

CLIQUE MINORS IN CARTESIAN PRODUCTS OF GRAPHS

DAVID R. WOOD

ABSTRACT. A *clique minor* in a graph G can be thought of as a set of connected subgraphs in G that are pairwise disjoint and pairwise adjacent. The *Hadwiger number* $\eta(G)$ is the maximum cardinality of a clique minor in G . It is one of the principle measures of the structural complexity of a graph.

This paper studies clique minors in the Cartesian product $G \square H$. Our main result is a rough structural characterisation theorem for Cartesian products with bounded Hadwiger number. It implies that if the product of two sufficiently large graphs has bounded Hadwiger number then it is one of the following graphs:

- a planar grid with a vortex of bounded width in the outerface,
- a cylindrical grid with a vortex of bounded width in each of the two ‘big’ faces, or
- a toroidal grid.

Motivation for studying the Hadwiger number of a graph includes Hadwiger’s Conjecture, which asserts that the chromatic number $\chi(G) \leq \eta(G)$. It is open whether Hadwiger’s Conjecture holds for every Cartesian product. We prove that $G \square H$ (where $\chi(G) \geq \chi(H)$) satisfies Hadwiger’s Conjecture whenever:

- H has at least $\chi(G) + 1$ vertices, or
- the treewidth of G is sufficiently large compared to $\chi(G)$.

On the other hand, we prove that Hadwiger’s Conjecture holds for all Cartesian products if and only if it holds for all $G \square K_2$. We then show that $\eta(G \square K_2)$ is tied to the treewidth of G .

We also develop connections with pseudoachromatic colourings and connected dominating sets that imply near-tight bounds on the Hadwiger number of grid graphs (Cartesian products of paths) and Hamming graphs (Cartesian products of cliques).

Date: November 8, 2007; revised: November 15, 2018.

1991 *Mathematics Subject Classification.* graph minors 05C83, structural characterization of types of graphs 05C75.

Key words and phrases. graph minor, cartesian product, Hadwiger number.

Supported by QEII Research Fellowship from the Australian Research Council. Research initiated at the Universitat Politècnica de Catalunya (Barcelona, Spain) where supported by a Marie Curie Fellowship of the European Commission under contract MEIF-CT-2006-023865, and by the projects MEC MTM2006-01267 and DURSI 2005SGR00692.

CONTENTS

1. Introduction	3
1.1. Hadwiger's Conjecture	4
2. Preliminaries	4
2.1. Vortices	5
2.2. Graph Products	5
2.3. Graph Minors	5
2.4. Upper Bounds on the Hadwiger Number	6
2.5. Treewidth, Pathwidth and Bandwidth	7
3. Hadwiger Number of Grid Graphs	7
4. Odd-Dimensional Grids and Pseudoachromatic Colourings	11
5. Star Minors and Dominating Sets	14
6. Dominating Sets and Clique Minors in Even-Dimensional Grids	18
7. Hadwiger Number of Products of Complete Graphs	22
8. Hypercubes and Lexicographic Products	27
9. Rough Structural Characterisation Theorem for Trees	30
10. Product of a General Graph and a Complete Graph	39
11. Rough Structural Characterisation Theorem	43
12. On Hadwiger's Conjecture for Cartesian Products	48
Note Added in Proof	52
References	52

1. INTRODUCTION

A *clique minor* in a graph G can be thought of as a set of connected subgraphs in G that are pairwise disjoint and pairwise adjacent. The *Hadwiger number* $\eta(G)$ is the maximum cardinality of a clique minor in G . It is one of the principle measures of the structural complexity of a graph.

Robertson and Seymour [46] proved a rough structural characterisation of graphs with bounded Hadwiger number. It says that such a graph can be constructed by a combination of four ingredients: graphs embedded in a surface of bounded genus, vortices of bounded width inside a face, the addition of a bounded number of apex vertices, and the clique-sum operation. Moreover, each of these ingredients is essential. This result is at the heart of Robertson and Seymour’s proof of Wagner’s Conjecture [47]: Every infinite set of finite graphs contains two graphs, one of which is a minor of the other.

This paper studies clique minors in the (Cartesian) product $G \square H$. Our main result is a rough structural characterisation of products with bounded Hadwiger number, which is less rough than the far more general result by Robertson and Seymour. It says that for connected graphs G and H , each with at least one edge, $G \square H$ has bounded Hadwiger number if and only if at least one of the following conditions are satisfied:

- G has bounded treewidth and H has bounded order,
- H has bounded treewidth and G has bounded order, or
- G has bounded hangover and H has bounded hangover,

where hangover is a parameter defined in Section 11. Basically, a graph with bounded hangover is either a cycle or consists of a path of degree-2 vertices joining two connected subgraphs of bounded order with no edge between the subgraphs. This implies that if the product of two sufficiently large graphs has bounded Hadwiger number then it is one of the following graphs:

- a planar grid (the product of two paths) with a vortex of bounded width in the outerface,
- a cylindrical grid (the product of a path and a cycle) with a vortex of bounded width in each of the two ‘big’ faces, or
- a toroidal grid (the product of two cycles).

The key case for the proof of this structure theorem is when G and H are trees. This case is handled in Section 9. The proof for general graphs is given in Sections 10 and 11.

Before proving our main results we develop connections with pseudoachromatic colourings (Section 4) and connected dominating sets (Sections 5 and 6) that imply near-tight bounds on the Hadwiger number of grid graphs (products of paths; Sections 3, 4 and 6) and Hamming graphs (products of cliques; Section 7). As summarised in Table 1, in each case, we improve the best previously known lower bound by a factor of between $\Omega(n^{1/2})$ and $\Omega(n^{3/2})$ to conclude asymptotically tight bounds for fixed d .

TABLE 1. Improved lower bounds on the Hadwiger number of specific graphs.

graph	d	previous best	new result	reference
grid graph P_n^d	even	$\Omega(n^{(d-2)/2})$	$\Theta(n^{d/2})$	Theorem 3.2
grid graph P_n^d	odd	$\Omega(n^{(d-1)/2})$	$\Theta(n^{d/2})$	Theorem 4.4
Hamming graph K_n^d	even	$\Omega(n^{(d-2)/2})$	$\Theta(n^{(d+1)/2})$	Theorem 7.5
Hamming graph K_n^d	odd	$\Omega(n^{(d-1)/2})$	$\Theta(n^{(d+1)/2})$	Theorem 7.5

1.1. Hadwiger’s Conjecture. Motivation for studying clique minors includes Hadwiger’s Conjecture, a far reaching generalisation of the 4-colour theorem, which states that the chromatic number $\chi(G) \leq \eta(G)$ for every graph G . It is open whether Hadwiger’s Conjecture holds for every product. The following classes of products are known to satisfy Hadwiger’s Conjecture (where G and H are connected and $\chi(G) \geq \chi(H)$):

- The product of sufficiently many graphs relative to their maximum chromatic number satisfies Hadwiger’s Conjecture [9].
- If $\chi(H)$ is not too small relative to $\chi(G)$, then $G \square H$ satisfies Hadwiger’s Conjecture [7, 43].

See Section 12 for precise versions of this statements. We add to this list as follows:

- If H has at least $\chi(G) + 1$ vertices, then $G \square H$ satisfies Hadwiger’s Conjecture (Theorem 12.4).
- If the treewidth of G is sufficiently large compared to $\chi(G)$, then $G \square H$ satisfies Hadwiger’s Conjecture (Theorem 12.3).

On the other hand, we prove that Hadwiger’s Conjecture holds for all $G \square H$ with $\chi(G) \geq \chi(H)$ if and only if Hadwiger’s Conjecture holds for $G \square K_2$. We then show that $\eta(G \square K_2)$ is tied to the treewidth of G . All these results are presented in Section 12.

Clique minors in products have been previously considered by a number of authors [1, 7, 9, 32, 38, 40, 43, 61]. In related work, Xu and Yang [59] and Špacapan [53] studied the connectivity of products, Drier and Linial [16] studied minors in lifts of graphs, and Goldberg [20] studied the Colin de Verdière number of products. See [24, 30, 31] for more on graph products.

2. PRELIMINARIES

All graphs considered in this paper are undirected, simple, and finite; see [4, 13]. Let G be a graph with vertex $V(G)$ and edge set $E(G)$. Let $v(G) = |V(G)|$ and $e(G) = |E(G)|$ respectively denote the *order* and *size* of G . Let $\Delta(G)$ denote the maximum degree of G . The *chromatic number* of G , denoted by $\chi(G)$, is the minimum integer k such that each vertex of G can be assigned one of k colours such that adjacent vertices receive distinct colours. Let K_n be the complete graph with n vertices. A *clique* of a graph

G is a complete subgraph of G . The *clique number* of G , denoted by $\omega(G)$, is the maximum order of a clique of G . Let P_n be the path with n vertices. By default, $V(K_n) = [n]$ and $P_n = (1, 2, \dots, n)$. A *leaf* in a graph is a vertex of degree 1. Let S_n be the star graph with n leaves; that is, $S_n = K_{1,n}$.

2.1. Vortices. Consider a graph H embedded in a surface; see [41]. Let (v_1, v_2, \dots, v_k) be a facial cycle in H . Consider a graph G obtained from H by adding sets of vertices S_1, S_2, \dots, S_k (called *bags*), such that for each $i \in [k]$ we have $v_i \in S_i \cap V(H) \subseteq \{v_1, \dots, v_k\}$, and for each vertex $v \in \cup_i S_i$, if $R(v) := \{i \in [k], v \in S_i\}$ then for some i, j , either $R(v) = [i, j]$ or $R(v) = [i, k] \cup [1, j]$, and for each edge $vw \in E(G)$ with $v, w \in \cup_i S_i$ there is some $i \in [k]$ for which $v, w \in S_i$. Then G is obtained from H by *adding a vortex of width* $\max_i |S_i|$.

2.2. Graph Products. Let G and H be graphs. The *Cartesian* (or *square*) *product* of G and H , denoted by $G \square H$, is the graph with vertex set

$$V(G \square H) := V(G) \times V(H) := \{(v, x) : v \in V(G), x \in V(H)\} ,$$

where $(v, x)(w, y)$ is an edge of $G \square H$ if and only if $vw \in E(G)$ and $x = y$, or $v = w$ and $xy \in E(H)$.

Assuming isomorphic graphs are equal, the Cartesian product is commutative and associative, and $G_1 \square G_2 \square \dots \square G_d$ is well-defined. We can consider a Cartesian product $G := G_1 \square G_2 \square \dots \square G_d$ to have vertex set

$$V(G) = \{v = (v_1, v_2, \dots, v_d) : v_i \in V(G_i), i \in [d]\} ,$$

where $vw \in E(G)$ if and only if $v_i w_i \in E(G_i)$ for some i , and $v_j = w_j$ for all $j \neq i$; we say that the edge vw is in *dimension* i . For a graph G and integer $d \geq 1$, let G^d denote the d -fold Cartesian product

$$G^d := \underbrace{G \square G \square \dots \square G}_d .$$

Since the Cartesian product is the focus of this paper, it will henceforth be simply referred to as the *product*. Other graph products will be briefly discussed. The *direct product* $G \times H$ has vertex set $V(G) \times V(H)$, where (v, x) is adjacent to (w, y) if and only if $vw \in E(G)$ and $xy \in E(H)$. The *strong product* $G \boxtimes H$ is the union of $G \square H$ and $G \times H$. The *lexicographic product* (or *graph composition*) $G \cdot H$ has vertex set $V(G) \times V(H)$, where (v, x) is adjacent to (w, y) if and only if $vw \in E(G)$, or $v = w$ and $xy \in E(H)$. Think of $G \cdot H$ as being constructed from G by replacing each vertex of G by a copy of H , and replacing each edge of G by a complete bipartite graph. Note that the lexicographic product is not commutative.

2.3. Graph Minors. A graph H is a *minor* of a graph G if H can be obtained from a subgraph of G by contracting edges. For each vertex v of H , the connected subgraph of G that is contracted into v is called a *branch set* of H . Two subgraphs X and Y in G are *adjacent* if there is an edge with one endpoint in X and the other endpoint in Y . A K_n -minor of G is called

a *clique minor*. It can be thought of as n connected subgraphs X_1, \dots, X_n of G , such that distinct X_i and X_j are disjoint and adjacent. The *Hadwiger number* of G , denoted by $\eta(G)$, is the maximum n such that K_n is a minor of G .

The following observation is used repeatedly.

Lemma 2.1. *If H is a minor of a connected graph G , then G has an H -minor such that every vertex of G is in some branch set.*

Proof. Start with an H -minor of G . If some vertex of G is not in a branch set, then since G is connected, some vertex v of G is not in a branch set and is adjacent to a vertex that is in a branch set X . Adding v to X gives an H -minor using more vertices of G . Repeat until every vertex of G is in some branch set. \square

In order to describe the principal result of this paper (Theorem 11.8), we introduce the following formalism. Let $\alpha : \mathcal{X} \rightarrow \mathbb{R}$ and $\beta : \mathcal{X} \rightarrow \mathbb{R}$ be functions, for some set \mathcal{X} . Then α and β are *tied* if there is a function f such that $\alpha(x) \leq f(\beta(x))$ and $\beta(x) \leq f(\alpha(x))$ for all $x \in \mathcal{X}$. Theorem 11.8 presents a function that is tied to $\eta(G \square H)$.

2.4. Upper Bounds on the Hadwiger Number. To prove the tightness of our lower bound constructions, we use the following elementary upper bounds on the Hadwiger number.

Lemma 2.2. *For every connected graph G with average degree at most $\delta \geq 2$,*

$$\eta(G) \leq \sqrt{(\delta - 2)v(G)} + 3 .$$

Proof. Let $k := \eta(G)$. Say X_1, \dots, X_k are the branch sets of K_k -minor in G . By Lemma 2.1, we may assume that every vertex is in some branch set. Since at least $\binom{k}{2}$ edges have endpoints in distinct branch sets,

$$e(G) \geq \binom{k}{2} + \sum_{i=1}^k e(X_i) \geq \binom{k}{2} + \sum_{i=1}^k (v(X_i) - 1) = \binom{k}{2} + v(G) - k.$$

Since $2e(G) = \delta v(G)$, we have $k^2 - 3k - (\delta - 2)v(G) \leq 0$. The result follows from the quadratic formula. \square

The following result, first proved by Ivančo [32], is another elementary upper bound on $\eta(G)$. It is tight for a surprisingly large class of graphs; see Proposition 8.3. We include the proof for completeness.

Lemma 2.3 ([32, 54]). *For every graph G ,*

$$\eta(G) \leq \left\lfloor \frac{v(G) + \omega(G)}{2} \right\rfloor .$$

Proof. Consider a K_n -minor in G , where $n := \eta(G)$. For $j \geq 1$, let n_j be the number of branch sets that contain exactly j vertices. Thus

$$v(G) - n_1 \geq \sum_{j \geq 2} j \cdot n_j \geq 2 \sum_{j \geq 2} n_j = 2(n - n_1).$$

Hence $v(G) + n_1 \geq 2n$. The branch sets that contain exactly one vertex form a clique. Thus $n_1 \leq \omega(G)$ and $v(G) + \omega(G) \geq 2n$. The result follows. \square

2.5. Treewidth, Pathwidth and Bandwidth. Another upper bound on the Hadwiger number is obtained as follows. A *tree decomposition* of a graph G consists of a tree T and a set $\{T_x \subseteq V(G) : x \in V(T)\}$ of ‘bags’ of vertices of G indexed by T , such that

- for each edge $vw \in E(G)$, there is some bag T_x that contains both v and w , and
- for each vertex $v \in V(G)$, the set $\{x \in V(T) : v \in T_x\}$ induces a non-empty (connected) subtree of T .

The *width* of the tree decomposition is $\max\{|T_x| : x \in V(T)\} - 1$. The *treewidth* of G , denoted by $\text{tw}(G)$, is the minimum width of a tree decomposition of G . For example, G has treewidth 1 if and only if G is a forest. A tree decomposition whose underlying tree is a path is called a *path decomposition*, and the *pathwidth* of G , denoted by $\text{pw}(G)$, is the minimum width of a path decomposition of G . The *bandwidth* of G , denoted by $\text{bw}(G)$, is the minimum, taken over of all linear orderings (v_1, \dots, v_n) of $V(G)$, of $\max\{|i - j| : v_i v_j \in E(G)\}$. It is well known [3] that for every graph G ,

$$(1) \quad \eta(G) \leq \text{tw}(G) + 1 \leq \text{pw}(G) + 1 \leq \text{bw}(G) + 1 .$$

3. HADWIGER NUMBER OF GRID GRAPHS

In this section we consider the Hadwiger number of the products of paths, so called *grid* graphs. First consider the $n \times m$ grid $P_n \square P_m$. It has no K_5 -minor since it is planar. In fact, $\eta(P_n \square P_m) = 4$ for all $n \geq m \geq 3$. Similarly, $P_n \square P_2$ has no K_4 -minor since it is outerplanar, and $\eta(P_n \square P_2) = 3$ for all $n \geq 2$.

Now consider the *double-grid* $P_n \square P_m \square P_2$, where $n \geq m \geq 2$. For $i \in [n]$, let C_i be the i -th column in the base copy of $P_n \square P_m$; that is, $C_i := \{(i, y, 1) : y \in [m]\}$. For $j \in [m]$, let R_j be the j -th row in the top copy of $P_n \square P_m$; that is, $R_j := \{(x, j, 2) : x \in [n]\}$. Since each R_i and each C_j are adjacent, contracting each R_i and each C_j gives a $K_{n,m}$ -minor. Chandran and Sivadasan [9] studied the case $n = m$, and observed that a K_m -minor is obtained by contracting a matching of m edges in $K_{m,m}$. In fact, contracting a matching of $m - 1$ edges in $K_{n,m}$ gives a K_{m+1} -minor. (In fact, $\eta(K_{m,m}) = m + 1$; see [57] for example.) Now observe that R_1 is adjacent to R_2 and C_1 is adjacent to C_2 . Thus contracting each edge of the matching $R_3 C_3, R_4 C_4, \dots, R_m C_m$ gives a K_{m+2} -minor, as illustrated in Figure 1. Hence $\eta(P_n \square P_m \square P_2) \geq m + 2$.

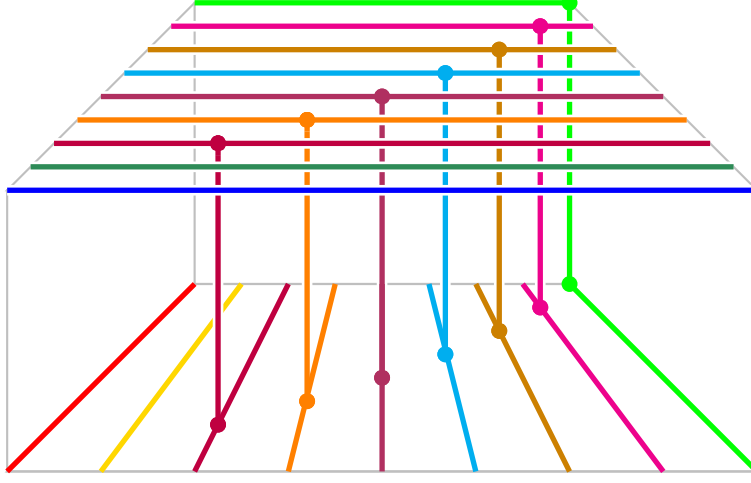
FIGURE 1. A K_{m+2} -minor in $P_m \square P_m \square P_2$.

Now we prove a simple upper bound on $\eta(P_n \square P_m \square P_2)$. Clearly,

$$\text{bw}(P_n \square P_m) \leq m .$$

Thus, by Lemma 10.3 and (1),

$$\eta(P_n \square P_m \square P_2) \leq \text{bw}(P_n \square P_m \square P_2) + 1 \leq 2m + 1 .$$

Summarising¹,

$$(2) \quad m + 2 \leq \eta(P_n \square P_m \square P_2) \leq 2m + 1 .$$

We conjecture that the lower bound in (2) is the answer; that is,

$$\eta(P_n \square P_m \square P_2) = m + 2 .$$

The above construction of a clique minor in the double-grid generalises as follows.

Proposition 3.1. *For all connected graphs G and H , each with at least one edge,*

$$\begin{aligned} \eta(G \square H \square P_2) &\geq \omega(G) + \omega(H) + \min\{\nu(G) - \omega(G), \nu(H) - \omega(H)\} \\ &\geq \min\{\nu(G), \nu(H)\} + \min\{\omega(G), \omega(H)\} \\ &\geq \min\{\nu(G), \nu(H)\} + 2 . \end{aligned}$$

Proof. Let P be a maximum clique of G . Let Q be a maximum clique of H . Without loss of generality, $n := \nu(G) - \omega(G) \leq \nu(H) - \omega(H)$. Say $V(G) - V(P) = \{v_1, v_2, \dots, v_n\}$ and $V(H) - V(Q) = \{w_1, w_2, \dots, w_m\}$, where $n \leq m$. Let $V(P_2) = \{1, 2\}$.

For $x \in V(G)$, let $A\langle x \rangle$ be the subgraph of $G \square H \square P_2$ induced by $\{(x, y, 1) : y \in V(H)\}$. For $y \in V(G)$, let $B\langle y \rangle$ be the subgraph of

¹In the case $n = m$, Chandran and Sivadasan [9] claimed an upper bound of $\eta(P_m \square P_m \square P_2) \leq 2m + 2$ without proof.

$G \square H \square P_2$ induced by $\{(x, y, 2) : x \in V(G)\}$. Note that each subgraph $A\langle x \rangle$ is isomorphic to H , and is thus connected. Similarly, each subgraph $B\langle y \rangle$ is isomorphic to G , and is thus connected.

Distinct subgraphs $A\langle x \rangle$ and $A\langle x' \rangle$ are disjoint since the first coordinate of every vertex in $A\langle x \rangle$ is x . Distinct subgraphs $B\langle y \rangle$ and $B\langle y' \rangle$ are disjoint since the second coordinate of every vertex in $B\langle x \rangle$ is y . Subgraphs $A\langle x \rangle$ and $B\langle y \rangle$ are disjoint since the third coordinate of every vertex in $A\langle x \rangle$ is 1, and the third coordinate of every vertex in $B\langle y \rangle$ is 2.

Since the vertex $(x, y, 1)$ in $A\langle x \rangle$ is adjacent to the vertex $(x, y, 1)$ in $B\langle y \rangle$, the $A\langle x \rangle$ and $B\langle y \rangle$ subgraphs are the branch sets of a complete bipartite $K_{\nu(G), \nu(H)}$ -minor in $G \square H \square H$. Moreover, for distinct vertices x and x' in the clique P , for any vertex $y \in V(H)$, the vertex $(x, y, 1)$ in $A\langle x \rangle$ is adjacent to the vertex $(x', y, 1)$ in $A\langle x' \rangle$. Similarly, for distinct vertices y and y' in the clique Q , for any vertex $x \in V(G)$, the vertex $(x, y, 2)$ in $B\langle y \rangle$ is adjacent to the vertex $(x, y', 2)$ in $B\langle y' \rangle$. For each $i \in [n]$, let X_i be the subgraph induced by $A\langle v_i \rangle \cup B\langle w_i \rangle$. Now $X\langle i \rangle$ is connected, since the vertex $(v_i, w_i, 1)$ in $A\langle i \rangle$ is adjacent to the vertex $(v_i, w_i, 2)$ in $B\langle i \rangle$.

We have shown that $\{A\langle x \rangle : x \in P\} \cup \{B\langle x \rangle : x \in Q\} \cup \{X_i : i \in [n]\}$ is a set of $\omega(G) + \omega(H) + n$ connected subgraphs, each pair of which are disjoint and adjacent. Hence these subgraphs are the branch sets of a clique minor in $G \square H \square P_2$. Therefore $\eta(G \square H \square P_2) \geq \omega(G) + \omega(H) + n$, as desired. The final claims are easily verified. \square

Now consider the Hadwiger number of the d -dimensional grid graph

$$P_n^d := \underbrace{P_n \square P_n \square \cdots \square P_n}_d .$$

The best previously known bounds are due to Chandran and Sivadasan [9] who proved that

$$n^{\lfloor (d-1)/2 \rfloor} \leq \eta(P_n^d) \leq \sqrt{2d} n^{d/2} + 1 .$$

In the case that d is even we now improve this lower bound by a $\Theta(n)$ factor, and thus determine $\eta(P_n^d)$ to within a factor of $4\sqrt{2d}$ (ignoring lower order terms).

Theorem 3.2. *For every integer $n \geq 2$ and even integer $d \geq 4$,*

$$\frac{1}{4}n^{d/2} - \mathcal{O}(n^{d/2-1}) \leq \eta(P_n^d) < \sqrt{2d-2} n^{d/2} + 3 .$$

Proof. The upper bound follows from Lemma 2.2 since $\nu(P_n^d) = n^d$ and $\Delta(P_n^d) = 2d$. Now we prove the lower bound. Let $V(P_n^d) = [n]^d$, where two vertices are adjacent if and only if they share $d-1$ coordinates in common and differ by 1 in the remaining coordinate. Let $p := \frac{d}{2}$.

For $j_1, j_2 \in \lfloor \frac{n}{2} \rfloor$ and $j_3, \dots, j_p \in [n]$, let $A\langle j_1, \dots, j_p \rangle$ be the subgraph of P_n^d induced by

$$\{(2j_1, 2j_2, j_3, j_4, \dots, j_p, x_1, x_2, \dots, x_p) : x_i \in [n], i \in [p]\};$$

let $B\langle j_1, \dots, j_p \rangle$ be the subgraph of P_n^d induced by

$$\begin{aligned} & \{(2x_1 - 1, x_2, x_3, \dots, x_p, j_1, j_2, \dots, j_p) : x_1 \in \lfloor \frac{n}{2} \rfloor, x_i \in [n], i \in [2, p]\} \\ & \cup \{(x_1, 2x_2 - 1, x_3, x_4, \dots, x_p, j_1, j_2, \dots, j_p) : x_1 \in [n], x_2 \in \lfloor \frac{n}{2} \rfloor, \\ & \quad x_i \in [n], i \in [3, p]\}; \end{aligned}$$

and let $X\langle j_1, \dots, j_p \rangle$ be the subgraph of P_n^d induced by $A\langle j_1, \dots, j_p \rangle \cup B\langle j_1, \dots, j_p \rangle$.

Each $A\langle j_1, \dots, j_p \rangle$ subgraph is disjoint from each $B\langle j'_1, \dots, j'_p \rangle$ subgraph since the first and second coordinates of each vertex in $A\langle j_1, \dots, j_p \rangle$ are both even, while the first or second coordinate of each vertex in $B\langle j'_1, \dots, j'_p \rangle$ is odd. Two distinct subgraphs $A\langle j_1, \dots, j_p \rangle$ and $A\langle j'_1, \dots, j'_p \rangle$ are disjoint since the p -tuples determined by the first p coordinates are distinct. Similarly, two distinct subgraphs $B\langle j_1, \dots, j_p \rangle$ and $B\langle j'_1, \dots, j'_p \rangle$ are disjoint since the p -tuples determined by the last p coordinates are distinct. Hence each pair of distinct subgraphs $X\langle j_1, \dots, j_p \rangle$ and $X\langle j'_1, \dots, j'_p \rangle$ are disjoint.

Observe that $A\langle j_1, \dots, j_p \rangle$ is isomorphic to P_n^p , and is thus connected. In particular, every pair of vertices $(2j_1, 2j_2, j_3, j_4, \dots, j_p, x_1, x_2, \dots, x_p)$ and $(2j_1, 2j_2, j_3, j_4, \dots, j_p, x'_1, x'_2, \dots, x'_p)$ in $A\langle j_1, \dots, j_p \rangle$ are connected by a path of length $\sum_i |x_i - x'_i|$ contained in $A\langle j_1, \dots, j_p \rangle$. To prove that $B\langle j_1, \dots, j_p \rangle$ is connected, consider a pair of vertices

$$v = (x_1, x_2, \dots, x_p, j_1, j_2, \dots, j_p) \text{ and } v' = (x'_1, x'_2, \dots, x'_p, j_1, j_2, \dots, j_p)$$

in $B\langle j_1, \dots, j_p \rangle$. If x_1 is even then walk along any one of the dimension-1 edges incident to v . This neighbour is in $B\langle j_1, \dots, j_p \rangle$, and its first coordinate is odd. Thus we can now assume that x_1 is odd. Similarly, we can assume that x_2, x'_1 , and x'_2 are all odd. Then

$$(x_1, x_2, \dots, x_p, j_1, j_2, \dots, j_p) \text{ and } (x'_1, x'_2, \dots, x'_p, j_1, j_2, \dots, j_p)$$

are connected by a path of length $\sum_i |x_i - x'_i|$ contained in $B\langle j_1, \dots, j_p \rangle$. Thus $B\langle j_1, \dots, j_p \rangle$ is connected. The vertex

$$(2j_1, 2j_2, j_3, j_4, \dots, j_p, j_1, j_2, \dots, j_p)$$

in $A\langle j_1, \dots, j_p \rangle$ is adjacent to the vertex

$$(2j_1 - 1, 2j_2, j_3, j_4, \dots, j_p, j_1, j_2, \dots, j_p)$$

in $B\langle j_1, \dots, j_p \rangle$. Thus $X\langle j_1, \dots, j_p \rangle$ is connected. Each pair of subgraphs $X\langle j_1, \dots, j_p \rangle$ and $X\langle j'_1, \dots, j'_p \rangle$ are adjacent since the vertex

$$(2j_1, 2j_2, j_3, j_4, \dots, j_p, j'_1, j'_2, \dots, j'_p)$$

in $A\langle j_1, \dots, j_p \rangle$ is adjacent to the vertex

$$(2j_1 - 1, 2j_2, j_3, j_4, \dots, j_p, j'_1, j'_2, \dots, j'_p)$$

in $B\langle j'_1, \dots, j'_p \rangle$.

Hence the $X\langle j_1, \dots, j_p \rangle$ form a complete graph minor in P_n^d of order $n^{d/2-2} \lfloor \frac{n}{2} \rfloor^2 = \frac{1}{4}n^{d/2} - \mathcal{O}(n^{d/2-1})$. \square

Note that for particular values of n , the lower bound in Theorem 3.2 is improved by a constant factor in Corollary 6.6 below.

4. ODD-DIMENSIONAL GRIDS AND PSEUDOACHROMATIC COLOURINGS

The ‘dimension pairing’ technique used in Section 3 to construct large clique minors in even-dimensional grids does not give tight bounds for odd-dimensional grids. To construct large clique minors in odd-dimensional grids we use the following idea.

A *pseudoachromatic k -colouring* of a graph G is a function $f : V(G) \rightarrow [k]$ such that for all distinct $i, j \in [k]$ there is an edge $vw \in E(G)$ with $f(v) = i$ and $f(w) = j$. The *pseudoachromatic number* of G , denoted by $\psi(G)$, is the maximum integer k such that there is a pseudoachromatic k -colouring of G . Pseudoachromatic colourings were introduced by Gupta [22] in 1969, and have since been widely studied. For example, many authors [19, 29, 39, 60] have proved² that

$$(3) \quad \psi(P_n) > \sqrt{2n-2} - 2.$$

Note that the only difference between a pseudoachromatic colouring and a clique minor is that each colour class is not necessarily connected. We now show that the colour classes in a pseudoachromatic colouring can be made connected in a three-dimensional product.

Theorem 4.1. *Let G , H and I be connected graphs. Let A , B and C be connected minors of G , H and I respectively, such that each branch set in each minor has at least two vertices. If $\mathfrak{v}(B) \geq \mathfrak{v}(C)$ then*

$$\eta(G \square H \square I) \geq \min\{\psi(A), \mathfrak{v}(B)\} \cdot \mathfrak{v}(C) .$$

Proof. (The reader should keep the example of $G = H = I = P_n$ and $A = B = C = P_{\lfloor n/2 \rfloor}$ in mind.)

Let $V(B) = \{y_1, \dots, y_{\mathfrak{v}(B)}\}$ and $V(C) = \{z_1, \dots, z_{\mathfrak{v}(C)}\}$. By contracting edges in H , we may assume that there are exactly two vertices of H in each branch set of B . Label the two vertices of H in the branch set corresponding to each y_j by y_j^+ and y_j^- . By contracting edges in I , we may assume that there are exactly two vertices of I in each branch set of C . Label the two vertices of I in the branch set corresponding to each z_j by z_j^+ and z_j^- .

Let $k := \min\{\psi(A), \mathfrak{v}(B)\}$. Let $f : V(A) \rightarrow [k]$ be a pseudoachromatic colouring of A . Our goal is to prove that $\eta(G \square H \square I) \geq k \cdot \mathfrak{v}(C)$.

²For completeness, we prove that $\psi(P_n) > \sqrt{2n-2} - 2$. Let $P_n = (x_1, \dots, x_n)$. Let t be the maximum odd integer such that $\binom{t}{2} \leq n-1$. Then $t > \sqrt{2n-2} - 2$. Denote $V(K_t)$ by $\{v_1, \dots, v_t\}$. Since t is odd, K_t is Eulerian. Orient the edges of K_t by following an Eulerian cycle $C = (e_1, e_2, \dots, e_{\binom{t}{2}})$. For $\ell \in [\binom{t}{2}]$, let $f(x_\ell) = i$, where $e_\ell = (v_i, v_j)$. For $\ell \in [\binom{t}{2} + 1, n]$, let $f(x_\ell) = 1$. Consider distinct colours $i, j \in [t]$. Thus for some edge e_ℓ of K_t , without loss of generality, $e_\ell = (v_i, v_j)$. Say $e_{\ell+1} = (v_j, v_k)$ is the next edge in C , where $e_{\ell+1}$ means e_1 if $\ell = \binom{t}{2}$. Since $\ell \leq \binom{t}{2} \leq n-1$, we have $\ell+1 \in [n]$. By construction, $f(x_\ell) = i$ and $f(x_{\ell+1}) = j$. Thus f is a pseudoachromatic colouring.

By contracting edges in G , we may assume that there are exactly two vertices of G in each branch set of A . Now label the two vertices of G in the branch set corresponding to each vertex v of A by v^+ and v^- as follows. Let T be a spanning tree of A . Orient the edges of T away from some root vertex r . Arbitrarily label the vertices r^+ and r^- of G . Let w be a non-root leaf of T . Label each vertex of $T - w$ by induction. Now w has one incoming arc (v, w) . Some vertex in the branch set of G corresponding to v is adjacent to some vertex of G in the branch set corresponding to w . Label w^+ and w^- so that there is an edge in G between v^+ and w^- , or between v^- and w^+ .

For $v \in V(A)$ and $j \in [v(C)]$ (and thus $j \in [v(B)]$), let $P\langle v, j \rangle$ be the subgraph of $G \square H \square I$ induced by

$$\{(v^+, y_j^+, z) : z \in V(I)\} ,$$

and let $Q\langle v, j \rangle$ be the subgraph of $G \square H \square I$ induced by

$$\{(v^-, y, z_j^+) : y \in V(H)\} .$$

For $i \in [k]$ (and thus $i \leq v(B)$) and $j \in [v(C)]$, let $R\langle i, j \rangle$ be the subgraph of $G \square H \square I$ induced by

$$\{(v, y_i^-, z_j^-) : v \in V(G)\} ,$$

and let $X\langle i, j \rangle$ be the subgraph of $G \square H \square I$ induced by

$$\cup\{P\langle v, j \rangle \cup Q\langle v, j \rangle \cup R\langle i, j \rangle : v \in f^{-1}(i)\} ,$$

as illustrated in Figure 2. We now prove that the $X\langle i, j \rangle$ are the branch sets of a clique minor in $G \square H \square I$.

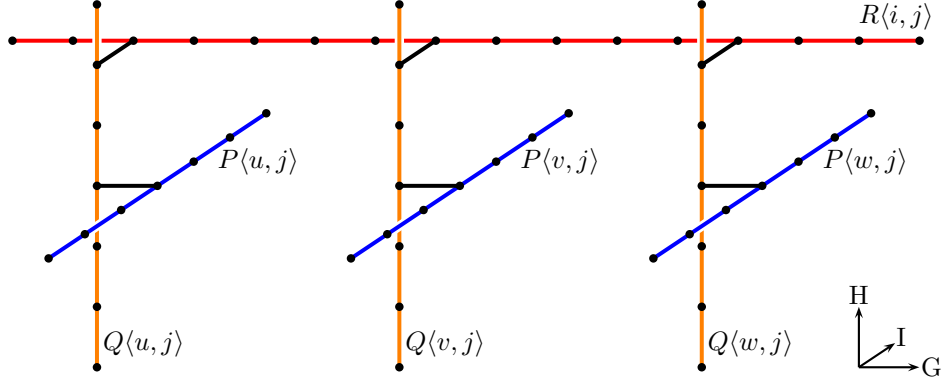

FIGURE 2. The branch set $X\langle i, j \rangle$ in Proposition 4.2, where $f^{-1}(i) = \{u, v, w\}$.

First we prove that each $X\langle i, j \rangle$ is connected. Observe that each $P\langle v, j \rangle$ is a copy of I and each $Q\langle i, j \rangle$ is a copy of H , and are thus connected. Moreover, the vertex (v^+, y_j^+, z_j^+) in $P\langle v, j \rangle$ is adjacent to the vertex (v^-, y_j^+, z_j^+) in

$Q\langle v, j \rangle$. Thus $P\langle v, j \rangle \cup Q\langle v, j \rangle$ is connected. Now each $R\langle i, j \rangle$ is a copy of G , and is thus connected. For each $v \in f^{-1}(i)$, the vertex (v^-, y_i^-, z_j^+) which is in $Q\langle v, j \rangle$, is adjacent to (v^-, y_i^-, z_j^-) which is in $R\langle i, j \rangle$. Thus $X\langle i, j \rangle$ is connected.

Now consider distinct subgraphs $X\langle i, j \rangle$ and $X\langle i', j' \rangle$. We first prove that $X\langle i, j \rangle$ and $X\langle i', j' \rangle$ are disjoint. Distinct subgraphs $P\langle v, j \rangle$ and $P\langle w, j' \rangle$ are disjoint since the first two coordinates of every vertex in $P\langle v, j \rangle$ are (v^+, y_j^+) , which are unique to (v, j) . Similarly, distinct subgraphs $Q\langle v, j \rangle$ and $Q\langle w, j' \rangle$ are disjoint since the first and third coordinates of every vertex in $Q\langle v, j \rangle$ are (v^-, z_j^+) , which are unique to (v, j) . Every $P\langle v, j \rangle$ is disjoint from every $Q\langle w, j' \rangle$ since the first coordinate of every vertex in $P\langle v, j \rangle$ is positive, while the first coordinate of every vertex in $Q\langle w, j' \rangle$ is negative. Observe that $R\langle i, j \rangle$ and $R\langle i', j' \rangle$ are disjoint since the second and third coordinates of every vertex in $R\langle i, j \rangle$ are (y_i^-, z_j^-) , which are unique to (i, j) . Also $R\langle i, j \rangle$ is disjoint from every $P\langle v, j' \rangle \cup Q\langle v, j' \rangle$ since the second and third coordinate of every vertex in $R\langle i, j \rangle$ are negative, while every vertex in $P\langle v, j' \rangle \cup Q\langle v, j' \rangle$ has a positive second or third coordinate. Therefore distinct $X\langle i, j \rangle$ and $X\langle i', j' \rangle$ are disjoint.

It remains to prove that distinct subgraphs $X\langle i, j \rangle$ and $X\langle i', j' \rangle$ are adjacent. If $i = i'$ then the vertex (v^+, y_j^+, z_j^+) , which is in $P\langle i, j \rangle$, is adjacent to the vertex (v^-, y_j^+, z_j^+) , which is in $Q\langle i', j' \rangle$. Now assume that $i \neq i'$. Then $f(v) = i$ and $f(w) = i'$ for some edge vw of A . By the labelling of vertices in G , without loss of generality, there is an edge in G between v^+ and w^- . Thus the vertex (v^+, y_j^+, z_j^+) , which is in $P\langle v, j \rangle \subset X\langle i, j \rangle$, is adjacent to the vertex (w^-, y_j^+, z_j^+) , which is in $Q\langle w, j \rangle \subset X\langle i', j' \rangle$. In both cases, $X\langle i, j \rangle$ and $X\langle i', j' \rangle$ are adjacent.

Hence the $X\langle i, j \rangle$ are the branch sets of a clique minor in $G \square H \square I$. Thus $\eta(G \square H \square I) \geq k \cdot \nu(C)$. \square

Now consider the Hadwiger number of the three-dimensional grid graph $P_n \square P_n \square P_n$. Prior to this work the best lower and upper bounds on $\eta(P_n \square P_n \square P_n)$ were $\Omega(n)$ and $\mathcal{O}(n^{3/2})$ respectively [7, 9, 43]. The next result improves this lower bound by a $\Theta(\sqrt{n})$ factor, thus determining $\eta(P_n \square P_n \square P_n)$ to within a factor of 4 (ignoring lower order terms).

Proposition 4.2. *For all integers $n \geq m \geq 1$,*

$$\frac{1}{2}n\sqrt{m} - \mathcal{O}(n + \sqrt{m}) < \eta(P_n \square P_n \square P_m) \leq 2n\sqrt{m} + 3 .$$

Proof. The upper bound follows from Lemma 2.2 since $P_n \square P_n \square P_m$ has n^2m vertices and maximum degree 6. Now we prove the lower bound. P_m has a $P_{\lfloor m/2 \rfloor}$ -minor with two vertices in each branch set. By (3), $\psi(P_{\lfloor m/2 \rfloor}) > \sqrt{m-3} - 2$. By Theorem 4.1 with $G = P_m$, $A = P_{\lfloor m/2 \rfloor}$, $H = I = P_n$, and $B = C = P_{\lfloor n/2 \rfloor}$ (and since $\psi(P_{\lfloor m/2 \rfloor}) \leq \lfloor \frac{m}{2} \rfloor \leq \lfloor \frac{n}{2} \rfloor = \nu(B)$),

$$\eta(P_n \square P_n \square P_m) \geq (\sqrt{m-3} - 2) \lfloor \frac{n}{2} \rfloor = \frac{1}{2}n\sqrt{m} - \mathcal{O}(n + \sqrt{m}) ,$$

as desired. \square

Here is another scenario when tight bounds for three-dimensional grids can be obtained.

Proposition 4.3. *For all integers $n \geq m \geq 1$ such that $n \leq \frac{1}{4}m^2$,*

$$\frac{1}{2}m\sqrt{n} - \mathcal{O}(m + \sqrt{n}) < \eta(P_n \square P_m \square P_m) \leq 2m\sqrt{n} + 3 .$$

Proof. The upper bound follows from Lemma 2.2 since $P_n \square P_m \square P_m$ has m^2n vertices and maximum degree 6. For the lower bound, apply Theorem 4.1 with $G = P_n$, $A = P_{\lfloor n/2 \rfloor}$, $H = I = P_m$, and $B = C = P_{\lfloor m/2 \rfloor}$. By (3), $\psi(P_{\lfloor n/2 \rfloor}) > \sqrt{n-3} - 2$. Thus

$$\eta(P_n \square P_n \square P_n) \geq \min\{(\sqrt{n-3} - 2), \lfloor \frac{m}{2} \rfloor\} \cdot \lfloor \frac{m}{2} \rfloor .$$

Since $n \leq \frac{1}{4}m^2$,

$$\eta(P_n \square P_n \square P_n) \geq (\sqrt{n-3} - 2) \cdot \lfloor \frac{m}{2} \rfloor = \frac{1}{2}m\sqrt{n} - \mathcal{O}(m + \sqrt{n}) ,$$

as desired. \square

Now consider the Hadwiger number of P_n^d for odd d . Prior to this work the best lower and upper bounds on $\eta(P_n^d)$ were $\Omega(n^{(d-1)/2})$ and $\mathcal{O}(\sqrt{d}n^{d/2})$ respectively [7, 9, 43]. The next result improves this lower bound by a $\Theta(\sqrt{n})$ factor, thus determining $\eta(P_n^d)$ to within a factor of $2\sqrt{2(d-1)}$ (ignoring lower order terms).

Theorem 4.4. *For every integer $n \geq 1$ and odd integer $d \geq 3$,*

$$\frac{1}{2}n^{d/2} - \mathcal{O}(n^{(d-1)/2}) < \eta(P_n^d) \leq \sqrt{2(d-1)}n^{d/2} + 3 .$$

Proof. The upper bound follows from Lemma 2.2 since $v(P_n^d) = n^d$ and $\Delta(P_n^d) = 2d$. Now we prove the lower bound. Let $G := P_n$ and $A := P_{\lfloor n/2 \rfloor}$. By (3), $\psi(A) > \sqrt{n-3} - 2$. Let $H := P_n^{(d-1)/2}$. Every grid graph with m vertices has a matching of $\lfloor \frac{m}{2} \rfloor$ edges. (*Proof:* induction on the number of dimensions.) Thus H has a minor B with $\lfloor \frac{1}{2}n^{(d-1)/2} \rfloor$ vertices, and two vertices in each branch set. By Theorem 4.1 with $I = H$ and $C = B$ (and since $\psi(P_{\lfloor n/2 \rfloor}) \leq \lfloor \frac{n}{2} \rfloor \leq \lfloor \frac{1}{2}n^{(d-1)/2} \rfloor$),

$$\eta(P_n^d) \geq (\sqrt{n-3} - 2) \lfloor \frac{1}{2}n^{(d-1)/2} \rfloor = \frac{1}{2}n^{d/2} - \mathcal{O}(n^{(d-1)/2}) ,$$

as desired. \square

5. STAR MINORS AND DOMINATING SETS

Recall that S_t is the star graph with t leaves. Consider the Hadwiger number of the product of S_t with a general graph.

Lemma 5.1. *For every connected graph G and for every integer $t \geq 1$,*

$$\eta(G \square S_t) \geq \min\{v(G), t + 1\} .$$

Proof. Let $k := \min\{v(G), t+1\}$. Let $V(G) := \{v_1, v_2, \dots, v_n\}$ and $V(S_t) := \{r\} \cup [t]$, where r is the root. For $i \in [k-1]$, let X_i be the subgraph of $G \square S_t$ induced by $\{(v_i, r)\} \cup \{(v_j, i) : j \in [n]\}$. Since G is connected, and (v_i, r) is adjacent to (v_i, i) , each X_i is connected. Let X_k be the subgraph consisting of the vertex (v_k, r) . For distinct $i, j \in [k]$ with $i < j$ (and thus $i \in [k-1] \subseteq [t]$), the subgraphs X_i and X_j are disjoint, and vertex (v_j, i) , which is in X_i , is adjacent to (v_j, r) , which is in X_j . Thus X_1, \dots, X_k are the branch sets of a K_k -minor in $G \square S_t$, as illustrated in Figure 3 when G is a path. \square

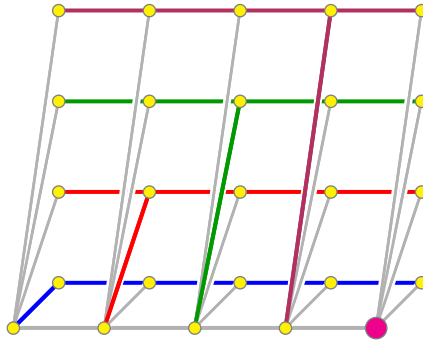

FIGURE 3. A K_5 -minor in $P_5 \square S_4$.

Note that the lower bound in Lemma 5.1 is within a constant factor of the upper bound in Lemma 2.2 whenever $e(G) = \Theta(v(G)) = \Theta(t)$. In particular, if G is a tree with at least $t+1$ vertices, then

$$t+1 \leq \eta(G \square S_t) \leq \eta(G \square K_{t+1}) \leq t+2 ,$$

where the upper bound is proved in Theorem 10.1 below. When G is another star, Ivančo [32] determined the Hadwiger number precisely. We include the proof for completeness.

Lemma 5.2 ([32]). *For all integers $n \geq m \geq 2$,*

$$\eta(S_n \square S_m) = m+2 .$$

Proof. Let $V(S_n) := \{r\} \cup [n]$, where r is the root vertex. Observe that for all $i \in [n]$ and $j \in [m]$, vertex (i, j) has degree 2; it is adjacent to (r, j) and (i, r) . In every graph except K_3 , contracting an edge incident to a degree-2 vertex does not change the Hadwiger number. Thus replacing the path $(r, j)(i, j)(i, r)$ by the edge $(r, j)(i, r)$ does not change the Hadwiger number. Doing so gives $K_{1,m,n}$. Ivančo [32] proved that $\eta(K_{1,m,n}) = m+2$. Thus $\eta(S_n \square S_m) = m+2$. In fact, Ivančo [32] determined the Hadwiger number of every complete multipartite graph (a result rediscovered by the author [57]). \square

For every graph G , let $\text{star}(G)$ be the maximum integer t for which S_t is minor of G . Since a vertex and its neighbours form a star, $\text{star}(G) \geq \Delta(G)$. Thus Lemmas 5.1 and 5.2 imply:

Corollary 5.3. *For all connected graphs G and H ,*

$$\begin{aligned} \eta(G \square H) &\geq \min\{\text{star}(G) + 1, \nu(H)\} \geq \min\{\Delta(G) + 1, \nu(H)\}, \text{ and} \\ \eta(G \square H) &\geq \min\{\text{star}(G), \text{star}(H)\} + 2 \geq \min\{\Delta(G), \Delta(H)\} + 2 . \end{aligned}$$

As an aside, we now show that star minors are related to radius and bandwidth. Let G be a connected graph. The *radius* of G , denoted by $\text{rad}(G)$, is the minimum, taken over all vertices v of G , of the maximum distance between v and some other vertex of G . Each vertex v that minimises this maximum distance is a *centre* of G .

Lemma 5.4. *For every connected graph G with at least one edge,*

- (a) $\nu(G) \leq \text{star}(G) \cdot \text{rad}(G) + 1$
- (b) $\text{bw}(G) \leq 2 \cdot \text{star}(G) - 1$.

Proof. First we prove (a). Let v be a centre of G . For $i \in [0, \text{rad}(G)]$, let V_i be the set of vertices at distance i from v . Thus the V_i are a partition of $V(G)$, and $|V_0| = 1$. For each $i \in [\text{rad}(G)]$, contracting V_0, \dots, V_{i-1} into a single vertex and deleting $V_{i+1}, \dots, V_{\text{rad}(G)}$ gives a $S_{|V_i|}$ -minor. Thus $\text{star}(G) \geq |V_i|$. Hence $\nu(G) = \sum_i |V_i| \leq 1 + \text{rad}(G) \cdot \text{star}(G)$.

Now we prove (b). Let (v_1, \dots, v_n) be a linear ordering of $V(G)$ such that if $v_a \in V_i$ and $v_b \in V_j$ with $i < j$, then $a < b$. Consider an edge $v_a v_b \in E(G)$. Say $v_a \in V_i$ and $v_b \in V_j$. Without loss of generality, $i \leq j$. By construction, $j \leq i + 1$. Thus $b - a \leq |V_i| + |V_{i+1}| - 1 \leq 2 \cdot \text{star}(G) - 1$. Hence $\text{bw}(G) \leq 2 \cdot \text{star}(G) - 1$. \square

Note that Lemma 5.4(a) is best possible for $G = P_{2n+1}$, which has $\text{star}(G) = 2$ and $\text{rad}(G) = n$, or for $G = K_n$, which has $\text{star}(G) = n - 1$ and $\text{rad}(G) = 1$. Corollary 5.7 and Lemma 5.4 imply that the product of graphs with small radii or large bandwidth has large Hadwiger number; we omit the details.

Star minors are related to connected dominating sets (first defined by Sampathkumar and Walikar [49]). Let G be a graph. A set of vertices $S \subseteq V(G)$ is *dominating* if each vertex in $V(G) - S$ is adjacent to a vertex in S . The *domination number* of G , denoted by $\gamma(G)$, is the minimum cardinality of a dominating set of G . If S is dominating and $G[S]$ is connected, then S and $G[S]$ are *connected dominating*. Only connected graphs have connected dominating sets. The *connected domination number* of a connected graph G , denoted by $\gamma_c(G)$, is the minimum cardinality of a connected dominating set of G . Finally, let $\ell(G)$ be the maximum number of leaves in a spanning tree of G (where K_1 is considered to have no leaves, and K_2 is considered to have one leaf). Hedetniemi and Laskar [28] proved that $\gamma_c(G) = \nu(G) - \ell(G)$. We extend this result as follows.

Lemma 5.5. *For every connected graph G ,*

$$\text{star}(G) = \mathbf{v}(G) - \gamma_c(G) = \ell(G) .$$

Proof. Let T be a spanning tree of G with $\ell(G)$ leaves. Let S be the set of non-leaf vertices of T . Thus S is a connected dominating set of G , implying $\gamma_c(G) \leq \mathbf{v}(G) - \ell(G)$ and $\ell(G) \leq \mathbf{v}(G) - \gamma_c(G)$.

Say S is a connected dominating set in G of order $\gamma_c(G)$. Contracting $G[S]$ gives a $S_{\mathbf{v}(G) - \gamma_c(G)}$ -minor in G . Thus $\text{star}(G) \geq \mathbf{v}(G) - \gamma_c(G)$.

Now suppose that $X_0, X_1, \dots, X_{\text{star}(G)}$ are the branch sets of a $S_{\text{star}(G)}$ -minor in G , where X_0 is the root. By Lemma 2.1, we may assume that every vertex of G is in some X_i . Let T_i be a spanning tree of each $G[X_i]$. Each T_i has at least two leaves, unless $\mathbf{v}(T_i) \leq 2$. Let T be the tree obtained from $\cup_i T_i$ by adding one edge between T_0 and T_i for each $i \in [\text{star}(G)]$. Each such T_i contributes at least one leaf to T . Thus T has at least $\text{star}(G)$ leaves, implying $\ell(G) \geq \text{star}(G)$. \square

Corollary 5.6. *For every tree $T \neq K_2$, $\text{star}(T)$ equals the number of leaves in T .*

Corollary 5.3 and Lemma 5.5 imply:

Corollary 5.7. *For all connected graphs G and H ,*

$$\eta(G \square H) \geq \min\{\mathbf{v}(G) - \gamma_c(G) + 1, \mathbf{v}(H)\} \text{ and}$$

$$\eta(G \square H) \geq \min\{\mathbf{v}(G) - \gamma_c(G), \mathbf{v}(H) - \gamma_c(H)\} + 2 .$$

We now show that a connected dominating set in a product can be constructed from a dominating set in one of its factors.

Lemma 5.8. *For all connected graphs G and H ,*

$$\gamma_c(G \square H) \leq (\mathbf{v}(G) - 1) \cdot \gamma_c(H) + \mathbf{v}(H) .$$

Proof. Let S be a minimum dominating set in H . Let v be an arbitrary vertex in G . Consider the set of vertices in $G \square H$,

$$T := \{(x, y) : x \in V(G) - \{v\}, y \in S\} \cup \{(v, y) : y \in V(H)\} .$$

Then $|T| = (\mathbf{v}(G) - 1) \cdot \gamma_c(H) + \mathbf{v}(H)$. First we prove that T is dominating. Consider a vertex (x, y) of $G \square H$. If $y \in S$ then $(x, y) \in T$. Otherwise, y is adjacent to some vertex $z \in S$, in which case (x, y) is adjacent to (x, z) , which is in T . Thus T is dominating. Now we prove that T is connected. Since G is connected, for each vertex x of G , there is a path $P(x, v)$ between x and v in G . Consider distinct vertices (x, y) and (x', y') in $G \square H$. Since H is connected there is a path $Q(y, y')$ between y and y' in H . Thus

$$\{(s, y) : s \in P(x, v)\} \cup \{(v, t) : t \in Q(y, y')\} \cup \{(s, y') : s \in P(x', v)\}$$

is a path between (x, y) and (x', y') in $G \square H$, all of whose vertices are in T . Thus T is a connected dominating set. \square

Corollary 5.7 (with $G = A \square B$ and $H = C$) and Lemma 5.8 (with $G = A$ and $H = B$) imply:

Corollary 5.9. *For all connected graphs A, B, C ,*

$$\eta(A \square B \square C) \geq \min\{v(A) \cdot v(B) - (v(A) - 1) \cdot \gamma(B) - v(B) + 1, v(C)\} .$$

There are hundreds of theorems about domination in graphs that may be used in conjunction with the above results to construct clique minors in products; see the monograph [27]. Instead, we now apply perhaps the most simple known bound on the order of dominating sets to conclude tight bounds on $\eta(G^d)$ whenever $d \geq 4$ is even and G has bounded average degree.

Theorem 5.10. *Let $G \neq K_1$ be a connected graph with n vertices and average degree δ . Then for every even integer $d \geq 4$,*

$$\frac{1}{2}n^{d/2} - n^{d/2-1} + 2 \leq \eta(G^d) \leq \sqrt{\delta d - 2}n^{d/2} + 3 .$$

Proof. The upper bound follows from Lemma 2.2 since G^d has average degree $\delta d \geq 4$. Now we prove the lower bound. Ore [42] observed that for every connected graph $H \neq K_1$, the smaller colour class in a 2-colouring of a spanning tree of H is dominating in H . Thus $\gamma(H) \leq \frac{1}{2}v(H)$. This observation with $H = G^{d/2-1}$ gives

$$\gamma(G^{d/2-1}) \leq \frac{1}{2}v(G^{d/2-1}) = \frac{1}{2}n^{d/2-1} .$$

By Lemma 5.8,

$$\begin{aligned} \gamma_c(G^{d/2}) &\leq (v(G) - 1) \cdot \gamma(G^{d/2-1}) + v(G^{d/2-1}) \leq (n - 1)\left(\frac{1}{2}n^{d/2-1}\right) + n^{d/2-1} \\ &= \frac{1}{2}n^{d/2} + \frac{1}{2}n^{d/2-1} . \end{aligned}$$

By Corollary 5.7,

$$\begin{aligned} \eta(G^d) &\geq v(G^{d/2}) - \gamma_c(G^{d/2}) + 2 \geq n^{d/2} - \left(\frac{1}{2}n^{d/2} + \frac{1}{2}n^{d/2-1}\right) \\ &= \frac{1}{2}n^{d/2} - \frac{1}{2}n^{d/2-1} + 2 , \end{aligned}$$

as desired. \square

6. DOMINATING SETS AND CLIQUE MINORS IN EVEN-DIMENSIONAL GRIDS

The results in Section 5 motivate studying dominating sets in grid graphs. First consider the one-dimensional case of P_n . It is well known and easily proved that $\gamma(P_n) = \lceil \frac{n}{3} \rceil$. Thus, by Lemma 5.8, for every connected graph G ,

$$\gamma_c(G \square P_n) \leq (v(G) - 1)\lceil \frac{n}{3} \rceil + n .$$

In particular,

$$\gamma_c(P_m \square P_n) \leq (m - 1)\lceil \frac{n}{3} \rceil + n \leq (m - 1)\left(\frac{n+2}{3}\right) + n = \frac{1}{3}(nm + 2m + 2n - 2) .$$

Hence Corollary 5.7 with $G = P_n \square P_m$ implies the following bound on the Hadwiger number of the 4-dimensional grid:

$$\eta(P_n \square P_m \square P_n \square P_m) \geq nm - \frac{1}{3}(nm + 2m + 2n - 2) + 2 = \frac{2}{3}(nm - m - n + 4) .$$

This result improves upon the bound in Theorem 3.2 by a constant factor.

Dominating sets in 2-dimensional grid graphs are well studied [10–12, 17, 18, 25, 26, 33, 34, 51, 56]. Using the above technique, these results imply bounds on the Hadwiger number of the 6-dimensional grid. We omit the details, and jump to the general case.

We first construct a dominating set in a general grid graph.

Lemma 6.1. *Fix integers $d \geq 1$ and $n_1, n_2, \dots, n_d \geq 1$. Let S be the set of vertices*

$$S := \{(x_1, x_2, \dots, x_d) : x_i \in [n_i], i \in [d], \sum_{i \in [d]} i \cdot x_i \equiv 0 \pmod{2d+1}\} .$$

For $j \in [d]$, let B_j be the set of vertices

$$B_j := \{(x_1, \dots, x_{j-1}, 1, x_{j+1}, \dots, x_d) : x_i \in [n_i], i \in [d] - \{j\}, \sum_{i \in [d] - \{j\}} i \cdot x_i \equiv 0 \pmod{2d+1}\} ,$$

and let C_j be the set of vertices

$$C_j := \{(x_1, \dots, x_{j-1}, n_j, x_{j+1}, \dots, x_d) : x_i \in [n_i], i \in [d] - \{j\}, \sum_{i \in [d] - \{j\}} i \cdot x_i \equiv -j(n_j + 1) \pmod{2d+1}\} ,$$

Let $T := \cup_j (S \cup B_j \cup C_j)$. Then T is dominating in $P_{n_1} \square P_{n_2} \square \dots \square P_{n_d}$.

Proof. Consider a vertex $x = (x_1, x_2, \dots, x_d)$ not in S . We now prove that x has neighbour in S , or x is in some $B_j \cup C_j$. Now $x_i \in [n_i]$ for each $i \in [d]$, and for some $r \in [2d]$,

$$\sum_{i=1}^d i \cdot x_i \equiv r \pmod{2d+1} .$$

First suppose that $r \in [d]$. Let $j := r$. Thus

$$j \cdot (x_j - 1) + \sum_{i \in [d] - \{j\}} i \cdot x_i \equiv 0 \pmod{2d+1} .$$

Hence, if $x_j \neq 1$ then $(x_1, \dots, x_{j-1}, x_j - 1, x_{j+1}, \dots, x_d)$ is a neighbour of x in S , and x is dominated. If $x_j = 1$ then x is in $B_j \subset T$.

Now assume that $r \in [d+1, 2d]$. Let $j := 2d+1-r \in [d]$. Thus $r \equiv -j \pmod{2d+1}$, and

$$j \cdot (x_j + 1) + \sum_{i \in [d] - \{j\}} i \cdot x_i \equiv 0 \pmod{2d+1} .$$

Hence, if $x_j \neq n_j$ then $(x_1, \dots, x_{j-1}, x_j + 1, x_{j+1}, \dots, x_d)$ is a neighbour of x in S , and x is dominated. If $x_j = n_j$ then x is in $C_j \subset T$.

Thus every vertex not in T has a neighbour in $S \subset T$, and T is dominating. \square

We now determine the size of the dominating set in Lemma 6.1.

Lemma 6.2. For integers $r \geq 2$, $d \geq 1$, c , and $n_1, \dots, n_d \geq 1$, define

$$Q(n_1, \dots, n_d; c; r) := \{(x_1, x_2, \dots, x_d) : x_i \in [n_i], i \in [d], \\ \sum_{i \in [d]} i \cdot x_i \equiv c \pmod{r}\} .$$

If each $n_i \equiv 0 \pmod{r}$ then for every integer c ,

$$|Q(n_1, \dots, n_d; c; r)| = \frac{1}{r} \prod_{i \in [d]} n_i .$$

Proof. We proceed by induction on d . First suppose that $d = 1$. Without loss of generality, $c \in [r]$. Then

$$Q(n_1; c; r) = \{x \in [n_1] : x \equiv c \pmod{r}\} = \{r \cdot y + c : y \in [0, \frac{n_1}{r} - 1]\} .$$

Thus $|Q(n_1; c; r)| = \frac{n_1}{r}$, as desired. Now assume that $d \geq 2$. Thus

$$\begin{aligned} & |Q(n_1, \dots, n_d; c; r)| \\ &= |\{(x_1, x_2, \dots, x_d) : x_i \in [n_i], i \in [d], \sum_{i \in [d]} i \cdot x_i \equiv c \pmod{r}\}| \\ &= \sum_{x_d \in [n_d]} |\{(x_1, x_2, \dots, x_d) : x_i \in [n_i], i \in [d-1], \\ & \quad \sum_{i \in [d-1]} i \cdot x_i \equiv (c - d \cdot x_d) \pmod{r}\}| \\ &= \sum_{x_d \in [n_d]} |Q(n_1, \dots, n_{d-1}; c - d \cdot x_d; r)| . \end{aligned}$$

By induction,

$$|Q(n_1, \dots, n_d; c; r)| = \sum_{x_d \in [n_d]} \frac{1}{r} \prod_{i \in [d-1]} n_i = \frac{1}{r} \prod_{i \in [d]} n_i ,$$

as desired. \square

Lemma 6.3. Let $G := P_{n_1} \square P_{n_2} \square \dots \square P_{n_d}$ for some integers $d \geq 1$ and $n_1, n_2, \dots, n_d \geq 1$, where each $n_i \equiv 0 \pmod{2d+1}$. Then

$$\gamma(G) \leq \frac{\mathfrak{v}(G)}{2d+1} \left(1 + \sum_{j \in [d]} \frac{2}{n_j} \right) .$$

Proof. Using the notation in Lemma 6.1, by Lemma 6.2 applied three times,

$$|S| = \frac{1}{2d+1} \prod_{i \in [d]} n_i = \frac{\mathfrak{v}(G)}{2d+1} ,$$

and for each $j \in [d]$,

$$|B_j|, |C_j| = \frac{1}{2d+1} \prod_{i \in [d] - \{j\}} n_i = \frac{\mathfrak{v}(G)}{(2d+1)n_j} .$$

Thus

$$|T| \leq |S| + \sum_{j \in [d]} |B_j| + |C_j| = \frac{\mathfrak{v}(G)}{2d+1} \left(1 + \sum_{j \in [d]} \frac{2}{n_j} \right),$$

as desired. \square

If n_1, \dots, n_d are large compared to d , then Lemma 6.3 says that $\gamma(G) \leq \frac{\mathfrak{v}(G)}{2d+1} + o(\mathfrak{v}(G))$. This bound is best possible since $\gamma(H) \geq \frac{\mathfrak{v}(H)}{\Delta(H)+1}$ for every graph H (and G has maximum degree $2d$).

From the dominating set given in Lemma 6.3 we construct a connected dominating set as follows.

Lemma 6.4. *Let $G := P_{n_1} \square P_{n_2} \square \dots \square P_{n_d}$ for some integers $d \geq 1$ and $n_1 \geq n_2 \geq \dots \geq n_d \geq 1$, where each $n_i \equiv 0 \pmod{2d+1}$. Then*

$$\gamma_c(G) < \frac{\mathfrak{v}(G)}{2d-1} \left(1 + \frac{2d-2}{n_d} + \sum_{j \in [d-1]} \frac{2}{n_j} \right).$$

Proof. Let $G' := P_{n_1} \square P_{n_2} \square \dots \square P_{n_{d-1}}$. By Lemma 6.3 applied to G' ,

$$\gamma(G') \leq \frac{\mathfrak{v}(G')}{2d-1} \left(1 + \sum_{j \in [d-1]} \frac{2}{n_j} \right).$$

By Lemma 5.8 with $H = G'$,

$$\gamma_c(G) \leq (n_d - 1) \cdot \gamma(G') + \mathfrak{v}(G').$$

Thus,

$$\begin{aligned} \gamma_c(G) &\leq (n_d - 1) \frac{\mathfrak{v}(G')}{2d-1} \left(1 + \sum_{j \in [d-1]} \frac{2}{n_j} \right) + \mathfrak{v}(G') \\ &= \frac{\mathfrak{v}(G)}{2d-1} \left(1 + \sum_{j \in [d-1]} \frac{2}{n_j} \right) - \frac{\mathfrak{v}(G')}{2d-1} \left(1 + \sum_{j \in [d-1]} \frac{2}{n_j} \right) + \mathfrak{v}(G') \\ &< \frac{\mathfrak{v}(G)}{2d-1} \left(1 + \sum_{j \in [d-1]} \frac{2}{n_j} \right) - \frac{\mathfrak{v}(G')}{2d-1} + \mathfrak{v}(G') \\ &= \frac{\mathfrak{v}(G)}{2d-1} \left(1 + \sum_{j \in [d-1]} \frac{2}{n_j} \right) + \frac{\mathfrak{v}(G')(2d-2)}{2d-1} \\ &= \frac{\mathfrak{v}(G)}{2d-1} \left(1 + \frac{2d-2}{n_d} + \sum_{j \in [d-1]} \frac{2}{n_j} \right), \end{aligned}$$

as desired. \square

Note that Gravier [21] proved an analogous result to Lemma 6.4 for the total domination number of multi-dimensional grids. Lemma 6.4 leads to the following bounds on the Hadwiger number of even-dimensional grids. These lower and upper bounds are within a multiplicative factor of approximately $2\sqrt{d}$, ignoring lower order terms.

Theorem 6.5. *Let $G := P_{n_1}^2 \square P_{n_2}^2 \square \cdots \square P_{n_d}^2$ for some integers $d \geq 1$ and $n_1 \geq n_2 \geq \cdots \geq n_d \geq 1$, where each $n_i \equiv 0 \pmod{2d+1}$. Then*

$$\sqrt{v(G)} \left(1 - \frac{1}{2d-1}\right) \left(1 - \frac{1}{n_d} - \frac{1}{d-1} \sum_{j \in [d-1]} \frac{1}{n_j}\right) + 2 \leq \eta(G) \leq \sqrt{(4d-2)v(G)} + 3 .$$

Proof. The upper bound follows from Lemma 2.2 since $\Delta(G) = 4d$. For the lower bound, let $G' := P_{n_1} \square P_{n_2} \square \cdots \square P_{n_d}$. By Lemma 6.4 applied to G' ,

$$\gamma_c(G') < \frac{v(G')}{2d-1} \left(1 + \frac{2d-2}{n_d} + \sum_{j \in [d-1]} \frac{2}{n_j}\right).$$

By Corollary 5.7 applied to G' ,

$$\eta(G) \geq v(G') - \gamma_c(G') + 2 .$$

Thus

$$\begin{aligned} \eta(G) &\geq v(G') - \frac{v(G')}{2d-1} \left(1 + \frac{2d-2}{n_d} + \sum_{j \in [d-1]} \frac{2}{n_j}\right) + 2 \\ &= v(G') \left(1 - \frac{1}{2d-1} - \frac{2d-2}{(2d-1)n_d} - \frac{1}{2d-1} \sum_{j \in [d-1]} \frac{2}{n_j}\right) + 2 \\ &= \sqrt{v(G)} \left(\frac{2d-2}{2d-1} - \frac{2d-2}{(2d-1)n_d} - \frac{2}{2d-1} \sum_{j \in [d-1]} \frac{1}{n_j}\right) + 2 \\ &= \sqrt{v(G)} \left(1 - \frac{1}{2d-1}\right) \left(1 - \frac{1}{n_d} - \frac{1}{d-1} \sum_{j \in [d-1]} \frac{1}{n_j}\right) + 2 , \end{aligned}$$

as desired. \square

Corollary 6.6. *For all even integers $d \geq 4$ and $n \geq 1$ such that $n \equiv 0 \pmod{2d+1}$,*

$$n^{d/2} \left(1 - \frac{1}{d-1}\right) \left(1 - \frac{2}{n}\right) + 2 \leq \eta(P_n^d) \leq \sqrt{2(d-1)n^{d/2}} + 3 .$$

7. HADWIGER NUMBER OF PRODUCTS OF COMPLETE GRAPHS

In this section we consider the Hadwiger number of the product of complete graphs. First consider the case of two complete graphs. Chandran and Raju [7, 43] proved that $\eta(K_n \square K_m) = \Theta(n\sqrt{m})$ for $n \geq m$. In particular,

$$\frac{1}{4}(n - \sqrt{m})(\sqrt{m} - 2) \leq \eta(K_n \square K_m) \leq 2n\sqrt{m} .$$

Since $P_{\lfloor \sqrt{m} \rfloor} \square P_{\lfloor \sqrt{m} \rfloor} \square K_n$ is a subgraph of $K_n \square K_m$, Lemma 10.7 below immediately improves this lower bound to

$$\eta(K_n \square K_m) \geq \lfloor \frac{n}{2} \rfloor \lfloor \sqrt{m} \rfloor .$$

It is interesting that (up to a constant factor) $K_n \square K_m$ and $P_{\lfloor \sqrt{m} \rfloor} \square P_{\lfloor \sqrt{m} \rfloor} \square K_n$ have the same Hadwiger number. Chandran et al. [6]

improved both the lower and upper bound on $\eta(K_n \square K_m)$ to conclude the following elegant result.

Theorem 7.1 ([6]). *For all integers $n \geq m \geq 1$,*

$$\eta(K_n \square K_m) = (1 - o(1)) n\sqrt{m} .$$

Theorem 7.1 is improved for small values of m in the following three propositions.

Proposition 7.2. *For every integer $n \geq 1$,*

$$\eta(K_n \square K_2) = n + 1 .$$

Proof. Say $V(K_n) = [n]$ and $V(K_2) = \{v, w\}$.

First we prove the lower bound $\eta(K_n \square K_2) \geq n + 1$. For $i \in [n]$, let X_i be the subgraph of $K_n \square K_2$ induced by the vertex (i, v) . Let X_{n+1} be the subgraph of $K_n \square K_2$ induced by the vertices $(1, w), \dots, (n, w)$. Then X_1, \dots, X_{n+1} are branch sets of a K_{n+1} -minor in $K_n \square K_2$. Thus $\eta(K_n \square K_2) \geq n + 1$.

It remains to prove the upper bound $\eta(K_n \square K_2) \leq n + 1$. Let X_1, \dots, X_k be the branch sets of a complete minor in $K_n \square K_2$, where $k = \eta(K_n \square K_2)$. If every X_i has at least two vertices then $k \leq n$ since $K_n \square K_2$ has $2n$ vertices. Otherwise some X_i has only one vertex, which has degree n in $K_n \square K_2$. Thus $k \leq n + 1$, as desired. \square

Proposition 7.3. *For every integer $n \geq 1$,*

$$\eta(K_n \square K_3) = n + 2 .$$

Proof. A K_{n+2} -minor in $K_n \square K_3$ is obtained by contracting the first row and contracting the second row. Thus $\eta(K_n \square K_3) \geq n + 2$.

It remains to prove the upper bound $\eta(K_n \square K_3) \leq n + 2$. We proceed by induction on n . The base case $n = 1$ is trivial. Let X_1, \dots, X_k be the branch sets of a K_k -minor, where $k = \eta(K_n \square K_3)$. Without loss of generality, each X_i is an induced subgraph.

Suppose that some column C intersects at most one branch set X_i . Deleting C and X_i gives a K_{k-1} -minor in $K_{n-1} \square K_3$. By induction, $k-1 \geq n+1$. Thus $k \geq n+2$, as desired. Now assume that every column intersects at least two branch sets.

If some branch set has only one vertex v , then $k \leq 1 + \deg(v) = n + 2$, as desired. Now assume that every branch set has at least two vertices.

Suppose that some branch set X_i has vertices in distinct rows. Since X_i is connected, X_i has at least two vertices in some column C . Now C intersects at least two branch sets, X_i and X_j . Thus X_j intersects C in exactly one vertex v . Consider the subgraph $X_j - v$. It has at least one vertex. Every neighbour of v that is in X_j is in the same row as v . Since X_j is an induced subgraph, the neighbourhood of v in X_j is a non-empty clique. Thus v is not a cut-vertex in X_j , and $X_j - v$ is a non-empty connected subgraph. Hence deleting C and X_i gives a K_{k-1} -minor in $K_{n-1} \square K_3$. By induction,

$k - 1 \geq n + 1$. Thus $k \geq n + 2$, as desired. Now assume that each branch set is contained in some row.

If every branch set has at least three vertices, then $k \leq \frac{1}{3}|V(K_n \square K_3)| = n$, as desired. Now assume that some branch set X_i has exactly two vertices v and w . Now v and w are in the same row. There are at most $\frac{n-2}{2}$ other branch sets in the same row, since every branch set has at least two vertices and is contained in some row. Moreover, $N(v) \cup N(w)$ contains only four vertices that are not in the same row as v and w . Thus $k - 1 \leq \frac{n-2}{2} + 4$. That is, $k \leq \frac{n+8}{2}$, which is at most $n + 2$ whenever $n \geq 4$. Now assume that $n \leq 3$. Since every branch set has at least two vertices, $k \leq \frac{1}{2}|V(K_n \square K_3)| = \frac{3n}{2}$, which is at most $n + 2$ for $n \leq 4$. \square

Proposition 7.4. *For every integer $n \geq 1$,*

$$\lfloor \frac{3}{2}n \rfloor \leq \eta(K_n \square K_4) \leq \frac{3}{2}n + 7 .$$

Proof. First we prove the lower bound. Let $p := \lfloor \frac{n}{2} \rfloor$. Each vertex is described by a pair (i, x) where $i \in [2p]$ and $x \in \{a, b, c, d\}$. Distinct vertices (i, x) and (j, y) are adjacent if and only if $i = j$ or $x = y$. As illustrated in Figure 4, for $i \in [p]$, let X_i be the path $(2i - 1, a)(2i - 1, b)(2i, b)(2i, c)$, let Y_i be the edge $(2i - 1, c)(2i - 1, d)$, and let Z_i be the edge $(2i, a)(2i, d)$. Thus each X_i , Y_i , and Z_i is connected, and each pair of distinct subgraphs are disjoint. Moreover, the vertex $(2i - 1, a)$ in X_i is adjacent to the vertex $(2j - 1, a)$ in X_j . The vertex $(2i, c)$ in X_i is adjacent to the vertex $(2j - 1, c)$ in Y_j . The vertex $(2i - 1, a)$ in X_i is adjacent to the vertex $(2j, a)$ in Z_j . The vertex $(2i - 1, c)$ in Y_i is adjacent to the vertex $(2j - 1, c)$ in Y_j . The vertex $(2i - 1, d)$ in Y_i is adjacent to the vertex $(2j, d)$ in Z_j . And the vertex $(2i, a)$ in Z_i is adjacent to the vertex $(2j, a)$ in Z_j . Hence $\{X_i, Y_i, Z_i : i \in [p]\}$ are the branch sets of a K_{3p} -minor. Therefore $\eta(K_{2p} \square K_4) \geq 3p$. In the case that n is odd, one column is unused, implying $\eta(K_{2p} \square K_4) \geq 3p + 1$. It follows that $\eta(K_n \square K_4) \geq \lfloor \frac{3}{2}n \rfloor$ for all n .

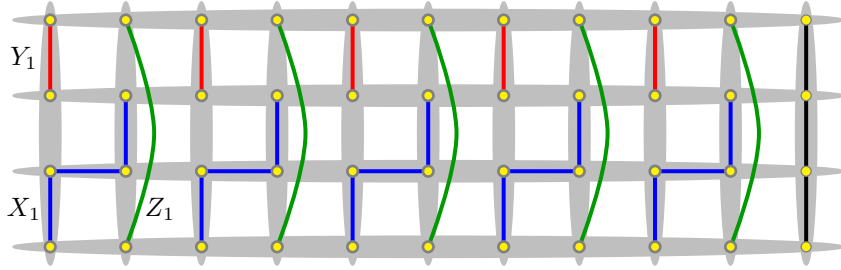

FIGURE 4. A K_{16} -minor in $K_{11} \square K_4$.

Now we prove the upper bound. (We make no effort to improve the constant 7.) Suppose on the contrary that $\eta(K_n \square K_4) > \frac{3}{2}n + 7$ for some minimum n . Thus $\eta(K_{n'} \square K_4) \leq \frac{3}{2}n' + 7$ for all $n' < n$. Consider the branch

sets of a K_p -minor in $K_n \square K_4$, where $p > \frac{3}{2}n + 7$. By Lemma 2.1, we may assume that every vertex is in some branch set.

Suppose that some branch set consists of at most three vertices all in a single row. These vertices have at most $n + 6$ neighbours in total, implying $p - 1 \leq n + 6$, which is a contradiction. Now assume that no branch set consists of at most three vertices all in a single row. In particular, no branch set is a singleton.

Suppose that some column C contains exactly three vertices in a single branch set X . Let y be the vertex in $C \setminus X$. Let Y be the branch set that contains y . The neighbourhood of y in Y is contained in a single row R , and is thus a clique. Hence $Y - y$ is connected and non-empty. Since y is the only vertex in $Y \cap C$, some neighbour y' of y in Y is in R . If, for some branch set Z that does not intersect C , some YZ -edge is incident to y , then Z intersects R , implying there is an edge from y' to Z . Therefore deleting C gives a K_{p-1} -minor (including the branch set $Y - y$). Hence

$$\frac{3}{2}(n - 1) + 7 \geq \eta(K_{n-1} \square K_4) \geq p - 1 > \frac{3}{2}n + 6 ,$$

which is a contradiction. Now assume that no column contains exactly three vertices in a single branch set.

Say there are q branch sets, each with exactly two or three vertices. Thus

$$4n \geq 2q + 4(p - q) > -2q + 4(\frac{3}{2}n + 7) ,$$

implying $q > n + 14$. Each branch set X with exactly two or three vertices contains exactly two vertices in some column C (since no branch set consists of at most three vertices all in a single row, and no column contains exactly three vertices in a single branch set). We say that C *belongs* to X . Since $q \geq n + 10$, there are distinct columns C_1, \dots, C_{10} that each belong to at least two branch sets.

Say C_i is type-1 if the vertices in the first and second rows (of C_i) are in the same branch set (which implies that the vertices in the third and fourth rows are in the same branch set). Say C_i is type-2 if the vertices in the first and third rows are in the same branch set (which implies that the vertices in the second and fourth rows are in the same branch set). Say C_i is type-3 if the vertices in the first and fourth rows are in the same branch set (which implies that the vertices in the second and third rows are in the same branch set).

At least four of C_1, \dots, C_{10} have the same type. Without loss of generality, C_1, C_2, C_3, C_4 are all type-1. Let X be the branch set that contains the vertices in the first and second rows of C_1 . In the case that $|X| = 3$, let D be the column that contains the vertex in $X \setminus C_1$. Note that $D \neq C_i$ for all $i \in \{2, 3, 4\}$ (since C_1 and C_i have the same type and $|X| \leq 3$). For $i \in \{2, 3, 4\}$, let Y_i be the branch set that contains the vertices in the third and fourth rows of C_i . Note that Y_2, Y_3 and Y_4 are distinct (since exactly one column belongs to each Y_i). Since $|X| \leq 3$, each vertex in X is in the first or second row. For each $i \in \{2, 3, 4\}$, since C_i belongs to two branch

sets and $|X| \leq 3$, we have $X \cap C_i = \emptyset$. Similarly, each vertex in Y_i is in the third or fourth row, and $Y_i \cap C_1 = \emptyset$. Since there is an edge between X and Y_i , it must be that $|X| = 3$, and each Y_i contains a vertex in the third or fourth row of D . That is, two vertices are contained in three branch sets. This contradiction completes the proof. \square

Now we consider the Hadwiger number of the product of d complete graphs. Here our lower and upper bounds are within a factor of $2\sqrt{d}$ (ignoring lower order terms).

Theorem 7.5. *For all integers $d \geq 2$ and $n_1 \geq n_2 \geq \dots \geq n_d \geq 2$,*

$$\left\lfloor \frac{n_1}{2} \right\rfloor \prod_{i \in [2, d]} \lfloor \sqrt{n_i} \rfloor \leq \eta(K_{n_1} \square K_{n_2} \square \dots \square K_{n_d}) < \left(\sqrt{d} n_1 \prod_{i \in [2, d]} \sqrt{n_i} \right) + 3 .$$

Proof. Let $G := K_{n_1} \square K_{n_2} \square \dots \square K_{n_d}$. Since $v(G) = \prod_i n_i$ and $\Delta(G) = \sum_i (n_i - 1)$, Lemma 2.2 implies the upper bound,

$$\begin{aligned} \eta(G) &< \sqrt{\left(\sum_{i \in [d]} (n_i - 1) \right) \left(\prod_{i \in [d]} n_i \right)} + 3 \\ &< \left(\sqrt{d} n_1 \prod_{i \in [d]} \sqrt{n_i} \right) + 3 \\ &= \left(\sqrt{d} n_1 \prod_{i \in [2, d]} \sqrt{n_i} \right) + 3 . \end{aligned}$$

For the lower bound, let $p := \lfloor \frac{n_1}{2} \rfloor$ and $k_i := \lfloor \sqrt{n_i} \rfloor$ for each $i \in [2, d]$. Let $m_1 := 2p$ and $m_i := k_i^2$ for each $i \in [2, d]$. Observe that each $n_i \geq m_i$. Thus it suffices to construct the desired minor in $K_{m_1} \square K_{m_2} \square \dots \square K_{m_d}$. Let $V(K_{m_1}) = [2p]$, and for each $i \in [2, d]$, let

$$V(K_{m_i}) = \{(a_i, b_i) : a_i, b_i \in [k_i]\} .$$

Each vertex is described by a vector $(r, a_2, b_2, \dots, a_d, b_d)$ where $r \in [m_1]$ and $a_i, b_i \in [k_i]$. Distinct vertices $(r, a_2, b_2, \dots, a_d, b_d)$ and $(s, x_2, y_2, \dots, x_d, y_d)$ are adjacent if and only if:

- (1) $a_i = x_i$ and $b_i = y_i$ for each $i \in [2, d]$, or
- (2) $r = s$, and for some $i \in [2, d]$, for every $j \neq i$, we have $a_j = x_j$ and $b_j = y_j$.

In case (1) the edge is in dimension 1, and in case (2) the edge is in dimension i .

For all $r \in [p]$, $i \in [2, d]$, and $j_i \in [k_i]$, let $A\langle r, j_2, \dots, j_d \rangle$ be the subgraph induced by

$$\{(2r, a_2, j_2, a_3, j_3, \dots, a_d, j_d) : a_i \in [k_i], i \in [2, d]\} ,$$

let $B\langle r, j_2, \dots, j_d \rangle$ be the subgraph induced by

$$\{(2r - 1, j_2, b_2, j_3, b_3, \dots, j_d, b_d) : b_i \in [k_i], i \in [2, d]\} ,$$

and let $X\langle r, j_2, \dots, j_d \rangle$ be the subgraph induced by the vertex set of $A\langle r, j_2, \dots, j_d \rangle \cup B\langle r, j_2, \dots, j_d \rangle$.

Observe that any two vertices in $A\langle r, j_2, \dots, j_d \rangle$ are connected by a path of at most $d - 1$ edges (in dimensions $2, \dots, d$). Thus $A\langle r, j_2, \dots, j_d \rangle$ is connected. Similarly, $B\langle r, j_2, \dots, j_d \rangle$ is connected. Moreover, the dimension-1 edge

$$(2r, j_2, j_2, j_3, j_3, \dots, j_d, j_d)(2r - 1, j_2, j_2, j_3, j_3, \dots, j_d, j_d)$$

connects $A\langle r, j_2, \dots, j_d \rangle$ and $B\langle r, j_2, \dots, j_d \rangle$. Hence $X\langle r, j_2, \dots, j_d \rangle$ is connected.

Consider a pair of distinct subgraphs $X\langle r, j_2, \dots, j_d \rangle$ and $X\langle s, \ell_2, \dots, \ell_d \rangle$. By construction they are disjoint. Moreover, the dimension-1 edge

$$(2r, \ell_2, j_2, \ell_3, j_3, \dots, \ell_d, j_d)(2s - 1, \ell_2, j_2, \ell_3, j_3, \dots, \ell_d, j_d)$$

connects $A\langle r, j_2, \dots, j_d \rangle$ and $B\langle s, \ell_2, \dots, \ell_d \rangle$. Hence the $X\langle r, j_2, \dots, j_d \rangle$ are branch sets of a clique minor of order $p \prod_{i=2}^d k_i$. Therefore

$$\eta(G) \geq p \prod_{i=2}^d k_i = \left\lfloor \frac{n_1}{2} \right\rfloor \prod_{i=2}^d \lfloor \sqrt{n_i} \rfloor ,$$

as desired. □

The d -dimensional *Hamming* graph is the product

$$H_n^d := \underbrace{K_n \square K_n \square \dots \square K_n}_d .$$

Chandran and Sivadasan [9] proved the following bounds on the Hadwiger number of H_n^d :

$$n^{\lfloor (d-1)/2 \rfloor} \leq \eta(H_n^d) \leq 1 + \sqrt{d} n^{(d+1)/2} .$$

Theorem 7.5 improves this lower bound by a $\Theta(n)$ factor; thus determining $\eta(H_n^d)$ to within a $2\sqrt{d}$ factor (ignoring lower order terms):

$$\frac{1}{2} n^{(d+1)/2} - \mathcal{O}(n^{d/2}) \leq \eta(H_n^d) < 1 + \sqrt{d} n^{(d+1)/2} .$$

8. HYPERCUBES AND LEXICOGRAPHIC PRODUCTS

The d -dimensional *hypercube* is the graph

$$Q_d := \underbrace{K_2 \square K_2 \square \dots \square K_2}_d .$$

Hypercubes are both grid graphs and Hamming graphs. The Hadwiger number of Q_d was first studied by Chandran and Sivadasan [8]. The best bounds on $\eta(Q_d)$ are due to Kotlov [38], who proved that

$$(4) \quad \eta(Q_d) \geq \begin{cases} 2^{(d+1)/2} & , d \text{ odd} \\ 3 \cdot 2^{(d-2)/2} & , d \text{ even} \end{cases}$$

and

$$\eta(Q_d) \leq \frac{5}{2} + \sqrt{2^d(d-3) + \frac{25}{4}} .$$

Kotlov [38] actually proved the following more general result which readily implies (4) by induction:

Proposition 8.1 ([38]). *For every bipartite graph G , the strong product $G \boxtimes K_2$ is a minor of $G \square K_2 \square K_2$.*

Proposition 8.1 is generalised by the following result with $H = K_2$ (since $G \cdot K_2 \cong G \boxtimes K_2$). See [58] for a different generalisation.

Proposition 8.2. *For every bipartite graph G and every connected graph H , the lexicographic product $G \cdot H$ is a minor of $G \square H \square H$.*

Proof. Properly colour the vertices of G *black* and *white*. For all vertices (v, p) of $G \cdot H$, let $X\langle v, p \rangle$ be the subgraph of $G \square H \square H$ induced by the set

$$\begin{cases} \{(v, p, q) : q \in V(H)\} & , \text{ if } v \text{ is black} \\ \{(v, q, p) : q \in V(H)\} & , \text{ if } v \text{ is white.} \end{cases}$$

We claim that the $X\langle v, p \rangle$ form the branch sets of a $G \cdot H$ -minor in $G \square H \square H$. First observe that each $X\langle v, p \rangle$ is isomorphic to H , and is thus connected.

Consider distinct vertices (v, p) and (v', p') of $G \cdot H$, where v is black.

Suppose on the contrary that some vertex (w, a, b) of $G \square H \square H$ is in both $X\langle v, p \rangle$ and $X\langle v', p' \rangle$. Since (w, a, b) is in $X\langle v, p \rangle$, we have $a = p$. By construction, $w = v = v'$. Thus v' is also black, and since (w, a, b) is in $X\langle v', p' \rangle$, we have $a = p'$. Hence $p = p'$, which contradicts that (v, p) and (v', p') are distinct. Hence $X\langle v, p \rangle$ and $X\langle v', p' \rangle$ are disjoint.

Suppose that (v, p) and (v', p') are adjacent in $G \cdot H$. It remains to prove that $X\langle v, p \rangle$ and $X\langle v', p' \rangle$ are adjacent in $G \square H \square H$. By definition, $vv' \in E(G)$, or $v = v'$ and $pp' \in E(H)$. If $vv' \in E(G)$, then without loss of generality, v is black and v' is white, implying that (v, p, p') , which is in $X\langle v, p \rangle$, is adjacent to (v', p, p') , which is in $X\langle v', p' \rangle$. If $v = v'$ and $pp' \in E(H)$, then for every $q \in V(H)$, the vertex (v, p, q) , which is in $X\langle v, p \rangle$, is adjacent to (v, p', q) , which is in $X\langle v', p' \rangle$. \square

Proposition 8.2 motivates studying $\eta(G \cdot H)$. We now show that when G is a complete graph, $\eta(G \cdot H)$ can be determined precisely.

Proposition 8.3. *For every graph H ,*

$$\eta(K_n \cdot H) = \left\lfloor \frac{n}{2} (\nu(H) + \omega(H)) \right\rfloor .$$

Proof. Let C be a maximum clique in H . Consider the set of vertices

$$X := \{(u, y) : u \in V(K_n), y \in C\}$$

in $K_n \cdot H$. Thus $|X| = n \cdot \omega(H)$ and X is a clique in $K_n \cdot H$. In fact, X is a maximum clique, since every set of $n \cdot \omega(H) + 1$ vertices in $K_n \cdot H$ contains

$\omega(H) + 1$ vertices in a single copy of H . Thus $\omega(K_n \cdot H) = n \cdot \omega(H)$. Hence the upper bound on $\eta(K_n \cdot H)$ follows from Lemma 2.3.

It remains to prove the lower bound on $\eta(K_n \cdot H)$. Delete the edges of H that are not in C . This operation is allowed since it does not increase $\eta(K_n \cdot H)$. So H now consists of C and some isolated vertices. Observe that $(K_n \cdot H) - X$ is isomorphic to the balanced complete n -partite graph with $v(H) - \omega(H)$ vertices in each colour class. Every balanced complete multipartite graph with r vertices has a matching of $\lfloor \frac{r}{2} \rfloor$ edges [52]. Thus $(K_n \cdot H) - X$ has a matching M of $\lfloor \frac{n}{2}(v(H) - \omega(H)) \rfloor$ edges. No edge in M is incident to a vertex in X . For every edge $(v, x)(v', x')$ in M and vertex (u, y) of $K_n \cdot H$, since $v \neq v'$, without loss of generality, $v \neq u$. Thus $vu \in E(K_n)$ and (v, x) is adjacent to (u, y) in $K_n \cdot H$. Hence contracting each edge in M gives a $K_{|X|+|M|}$ -minor in $K_n \cdot H$. Therefore

$$\eta(K_n \cdot H) \geq |X| + |M| = n \cdot \omega(H) + \left\lfloor \frac{n}{2}(v(H) - \omega(H)) \right\rfloor = \left\lfloor \frac{n}{2}(v(H) + \omega(H)) \right\rfloor.$$

□

We now show that Propositions 8.2 and 8.3 are closely related to some previous results in the paper.

Proposition 8.2 with $G = K_2$ implies that $K_2 \cdot H$ is a minor of $H \square H \square K_2$. Proposition 8.3 implies that $\eta(K_2 \cdot H) = v(H) + \omega(H)$. Thus $\eta(H \square H \square K_2) \geq v(H) + \omega(H)$, which is only slightly weaker than Proposition 3.1.

Proposition 8.2 with $G = K_{n,n}$ implies that $K_{n,n} \cdot H$ is a minor of $K_{n,n} \square H \square H$ for every connected graph H . Since K_{n+1} is a minor of $K_{n,n}$, we have $K_{n+1} \cdot H$ is a minor of $K_{n,n} \square H \square H$. Proposition 8.3 implies that

$$\eta(K_{n,n} \square H \square H) \geq \left\lfloor \frac{n+1}{2}(v(H) + \omega(H)) \right\rfloor.$$

Since $K_{n,n} \subset K_{2n}$,

$$\eta(K_{2n} \square H \square H) \geq \left\lfloor \frac{n+1}{2}(v(H) + \omega(H)) \right\rfloor.$$

With $H = K_m^d$ we have

$$\eta(K_{2n} \square K_m^{2d}) \geq \left\lfloor \frac{n+1}{2}(m^d + m) \right\rfloor,$$

which is equivalent to Theorem 7.5 with $n_1 = n$ and $n_2 = \dots = n_{2d+1} = m$ (ignoring lower order terms). In fact for small values of m , this bound is stronger than Theorem 7.5. For example, with $n = 1$ and $m = 3$ we have

$$\eta(K_2 \square K_3^{2d}) \geq 3^d + 3,$$

whereas Theorem 7.5 gives no non-trivial bound on $\eta(K_2 \square K_3^{2d})$.

9. ROUGH STRUCTURAL CHARACTERISATION THEOREM FOR TREES

In this section we characterise when the product of two trees has a large clique minor. Section 5 gives such an example: Corollaries 5.3 and 5.6 imply that if one tree has many leaves and the other has many vertices then their product has a large clique minor. Now we give a different example. As illustrated in Figure 5(a), let B_n be the tree obtained from the path P_{2n+1} by adding one leaf adjacent to the vertex in the middle of P_{2n+1} .

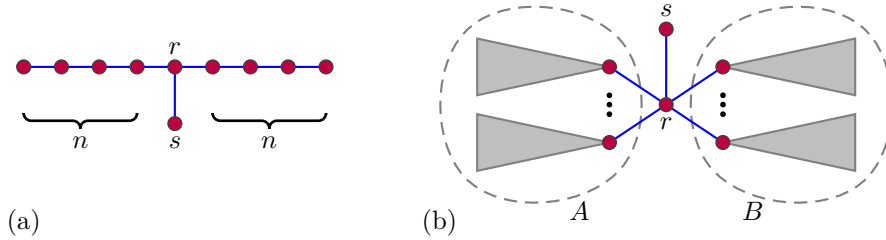

FIGURE 5. (a) The tree B_n . (b) A balance of order $\min\{|A|, |B|\}$.

Now B_n only has three leaves, but Seese and Wessel [50] implicitly proved that the product of B_n and a long path (which only has two leaves) has a large clique minor³. In Theorem 9.1 below we prove an explicit bound of $\eta(P_m \square B_n) \geq \min\{n, \sqrt{m}\}$, which is illustrated in Figure 6. In fact, this bound holds for a more general class of trees than B_n , which we now introduce.

As illustrated in Figure 5(b), a *balance of order n* is a tree T that has an edge rs , and disjoint sets $A, B \subseteq V(T) - \{r, s\}$, each with at least n vertices, such that $A \cup \{r\}$ and $B \cup \{r\}$ induce connected subtrees in T . We say A and B are the *branches*, r is the *root*, and s is the *support* of T . For example, the star S_t is a balance of order $\lfloor \frac{t-1}{2} \rfloor$, and B_n is a balance of order n . Theorem 9.1 below implies that $\eta(P_m \square T) \geq \min\{\sqrt{m}, n\}$ for every balance T of order n . The critical property of a long path is that it has many large disjoint subpaths.

Theorem 9.1. *Let G be a tree that has n disjoint subtrees each of order at least n . Then for every balance T of order n ,*

$$\eta(G \square T) \geq n .$$

³Seese and Wessel [50] observed that since the complete graph has a drawing in the plane with all the crossings collinear, $B_n \square P_m$ contains clique subdivisions of unbounded order, and thus $\eta(B_n \square P_m)$ is unbounded. On the other hand, Seese and Wessel [50] proved that if T is the tree obtained from the path (v_1, \dots, v_m) by adding one leaf adjacent to v_2 , then $\eta(P_n \square T) \leq 7$. This observation disproved an early conjecture by Robertson and Seymour about the structure of graphs with an excluded minor, and led to the development of vortices in Robertson and Seymour's theory; see [36, 46].

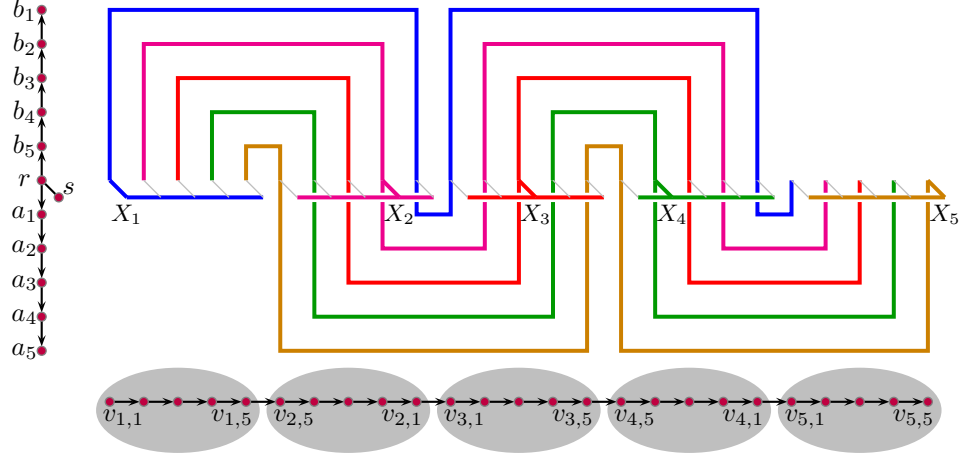
 FIGURE 6. K_n is a minor of $P_n^2 \square B_n$.

Proof. Let A and B be the branches, let r be the root, and let s be the support of T . Contract edges in T until A and B each have exactly n vertices. Orient the edges of T away from r . Label the vertices of A by $\{a_1, a_2, \dots, a_n\}$ such that if $\overrightarrow{a_i a_j} \in E(A)$ then $i < j$. Label the vertices of B by $\{b_1, b_2, \dots, b_n\}$ such that if $\overrightarrow{b_i b_j} \in E(B)$ then $j < i$. For each $i \in [n]$, let T_i be the path between a_i and b_i in T (which thus includes r).

Contract edges in G until it is the union of n disjoint subtrees G_1, \dots, G_n , each with exactly n vertices. For every pair of vertices $v, w \in V(G)$, let $G\langle v, w \rangle$ be the path between v and w in G . Orient the edges of G away from an arbitrary vertex in G_1 . Let G^* be the oriented tree obtained from G by contracting each G_i into a single vertex z_i . Note that for each $i \in [2, n]$, each vertex z_i has exactly one incoming arc in G^* . Fix a proper 2-colouring of G^* with colours *black* and *white*, where z_1 is coloured white. Label the vertices in each subtree G_i by $\{v_{i,1}, \dots, v_{i,n}\}$, such that for each arc $(v_{i,j}, v_{i,\ell})$ in G_i , we have $\ell < j$ if z_i is black, and $j < \ell$ if z_i is white.

For each $i \in [n]$, let H_i be the subgraph of $G \square T$ induced by

$$\{(v_{i,j}, s) : j \in [n]\} .$$

For all $i, j \in [n]$, let $T_{i,j}$ be the subgraph of $G \square T$ induced by

$$\{(v_{j,i}, y) : y \in V(T_i)\} .$$

For all $i, j \in [n]$, let $c_{i,j}$ be the vertex a_i if z_j is white, and b_i if z_j is black. For all $i \in [n]$ and $j \in [2, n]$, let $U_{i,j}$ be the subgraph of $G \square T$ induced by

$$\{(x, c_{i,j}) : x \in G\langle v_{k,i}, v_{j,i} \rangle\},$$

where (z_k, z_j) is the incoming arc at z_j in G^* .

For each $i \in [n]$, let X_i be the subgraph of $G \square T$ induced by

$$\bigcup_{j \in [n]} (T_{i,j} \cup U_{i,j} \cup H_i) .$$

We now prove that X_1, \dots, X_n are the branch sets of a K_n -minor.

First we prove that each X_i is connected. Observe that each H_i is isomorphic to G_i , and is thus connected. Each $T_{i,j}$ is isomorphic to the path T_i , and is thus connected. Moreover, the endpoints of $T_{i,j}$ are $(v_{j,i}, a_i)$ and $(v_{j,i}, b_i)$. Each $U_{i,j}$ is isomorphic to the path $G \langle v_{j',i}, v_{j,i} \rangle$, and is thus connected. Moreover, the endpoints of $U_{i,j}$ are $(v_{j',i}, c_{i,j})$ and $(v_{j,i}, c_{i,j})$. Thus if z_j is white (and thus $z_{j'}$ is black), then the endpoints of $U_{i,j}$ are $(v_{j',i}, a_i)$ and $(v_{j,i}, a_i)$. And if z_j is black (and thus $z_{j'}$ is white), then the endpoints of $U_{i,j}$ are $(v_{j',i}, b_i)$ and $(v_{j,i}, b_i)$. Hence the induced subgraph

$$T_{i,1} \cup U_{i,1} \cup T_{i,2} \cup U_{i,2} \cup T_{i,3} \cup U_{i,3} \cup \dots \cup T_{i,n} \cup U_{i,n}$$

is a path (illustrated in Figure 6 by alternating vertical and horizontal segments). Furthermore, the vertex $(v_{i,i}, s)$ in H_i is adjacent to the vertex $(v_{i,i}, r)$ in $T_{i,i}$. Thus X_i is connected.

Now we prove that the subgraphs X_i and $X_{i'}$ are disjoint for all distinct $i, i' \in [n]$. First observe that H_i and $H_{i'}$ are disjoint since the first coordinate of every vertex in H_i is some $v_{i,j}$. Similarly, for all $j, j' \in [n]$, the subgraphs $T_{i,j}$ and $T_{i',j'}$ are disjoint since the first coordinate of every vertex in $T_{i,j}$ is $v_{j,i}$. For all $j, j' \in [n]$, the subgraphs $U_{i,j}$ and $U_{i',j'}$ are disjoint since the second coordinate of every vertex in $U_{i,j}$ is a_i or b_i . For all $j \in [n]$, H_i is disjoint from $T_{i',j} \cup U_{i',j}$ since the second coordinate of H_i is s . It remains to prove that $T_{i,j}$ and $U_{i',j'}$ are disjoint. Suppose on the contrary that for some $j, j' \in [n]$, some vertex (x, y) is in $T_{i,j} \cap U_{i',j'}$. Without loss of generality, $z_{j'}$ is black. Say $(z_k, z_{j'})$ is the incoming arc at $z_{j'}$ in G^* . So z_k is white. Since $(x, y) \in T_{i,j}$, we have $x = v_{j,i}$ and $y \in V(T_i)$. Since $(x, y) \in U_{i',j'}$, x is in the path $G \langle v_{k,i'}, v_{j',i'} \rangle$. Since $z_{j'}$ is black, $y = b_{i'}$. Now $v_{j,i}$ (which equals x) is in the path $G \langle v_{k,i'}, v_{j',i'} \rangle$. Thus by the labelling of vertices in G_k and $G_{j'}$, we have $i' < i \leq n$. By comparing the second coordinates, observe that $b_{i'} \in V(T_i)$. Thus $i' > i$ by the labelling of the vertices in B . This contradiction proves that $T_{i,j}$ and $U_{i',j'}$ are disjoint for all $j, j' \in [n]$. Hence X_i and $X_{i'}$ are disjoint.

Finally, observe that for distinct $i, i' \in [n]$, the vertex $(v_{i,i'}, s)$ in $H_i \subset X_i$ is adjacent to the vertex $(v_{i,i'}, r)$ in $T_{i',i} \subset X_{i'}$. Therefore the X_i are branch sets of a K_n -minor. \square

We conjecture that the construction in Theorem 9.1 is within a constant factor of optimal; that is, $P_m \square B_n = \Theta(\min\{\sqrt{m}, n\})$.

Theorem 9.1 motivates studying large disjoint subtrees in a given tree. Observe that a star does not have two disjoint subtrees, both with at least two vertices. Thus a star cannot be used as the tree G in Theorem 9.1 with $n \geq 2$. On the other hand, a path on n^2 vertices has n disjoint subpaths, each with n vertices. Of the trees with the same number of vertices, the

star has the most leaves and the path has the least. We now prove that the every tree with few leaves has many large disjoint subtrees⁴.

Theorem 9.2. *Let T be a tree with at least one edge, and let n be a positive integer, such that*

$$\mathbf{v}(T) \geq n^2 + (\mathbf{star}(T) - 2)(n - 1) + 1 .$$

Then T has n disjoint subtrees, each with at least n vertices.

The proof of Theorem 9.2 is based on the following lemma.

Lemma 9.3. *Fix a positive integer n . Let T be a tree with at least one edge, where each vertex of T is assigned a weight $w(v) \in \mathbb{Z}^+$, such that every leaf has weight at most n and every other vertex has weight 1. Let $W(T) := \sum_{v \in V(T)} w(v)$ be the total weight. Then there is a vertex-partition of T into at least*

$$f(T) := \left\lfloor \frac{W(T) - (\mathbf{star}(T) - 2)(n - 1)}{n} \right\rfloor$$

disjoint subtrees, each with total weight at least n .

Proof. We proceed by induction on $f(T)$. If $f(T) \leq 0$ then there is nothing to prove. First suppose that $f(T) = 1$. Then $W(T) \geq (\mathbf{star}(T) - 2)(n - 1) + n \geq n$ since $\mathbf{star}(T) \geq 2$. Thus T itself has total weight at least n , and we are done. Now assume that $f(T) \geq 2$.

Suppose that $T = K_2$ with vertices x and y , both of which are leaves. Thus $\mathbf{star}(T) = 2$ and $f(T) = \lfloor \frac{w(x)+w(y)}{n} \rfloor$. Now $f(T) \geq 2$ and $w(x), w(y) \leq n$. Thus $f(T) = 2$ and $w(x) = w(y) = n$. Hence $T[\{x\}]$ and $T[\{y\}]$ is a vertex-partition of T into two disjoint subtrees, each with weight at least n , and we are done. Now assume that $\mathbf{v}(T) \geq 3$.

Suppose that $w(v) = n$ for some leaf v . Let $T' := T - v$. By induction, there is a vertex-partition of T' into $f(T')$ disjoint subtrees, each with total weight at least n . These subtrees plus $T[\{v\}]$ are a vertex-partition of T into $1 + f(T')$ disjoint subtrees, each with total weight at least n . Now

⁴As an aside we now describe a polynomial-time algorithm that for a given tree T , finds the maximum number of disjoint subtrees in T , each with at least n vertices. It is convenient to consider a generalisation of this problem, where each vertex v is assigned a positive weight $w(v)$, and each subtree is required to have total weight at least n . Let v be a leaf of T . Let $T' := T - v$. Define a new weight function $w'(z) := w(z)$ for every vertex z of $T - v$. First suppose that $w(v) \geq n$. Then T has k disjoint subtrees each of total w -weight at least n if and only if T' has $k - 1$ disjoint subtrees each of total w' -weight at least n . (In which case $T[\{v\}]$ becomes one of the k subtrees.) Now assume that $w(v) < n$. Let x be the neighbour of v in T . Redefine $w'(x) := w(x) + w(v)$. Then T has k disjoint subtrees each of total w -weight at least n if and only if T' has k disjoint subtrees each of total w' -weight at least n . (A subtree X of T' containing x is replaced by the subtree $T[V(X) \cup \{v\}]$.) Thus in each case, from an inductively computed optimal solution in T' (for the weight function w'), we can compute an optimal solution in T (for the weight function w).

$W(T') = W(T) - n$, and $s(T') \leq \text{star}(T)$ since v is not a leaf in T' , and the neighbour of v is the only potential leaf in T' that is not a leaf in T . Thus

$$\begin{aligned} 1 + f(T') &= \left\lfloor \frac{n + W(T') - (s(T') - 2)(n - 1)}{n} \right\rfloor \\ &\geq \left\lfloor \frac{W(T) - (\text{star}(T) - 2)(n - 1)}{n} \right\rfloor \\ &= f(T) , \end{aligned}$$

and we are done. Now assume that $w(v) \leq n - 1$ for every leaf v .

Let T' be the tree obtained from T by deleting each leaf. Since $T \neq K_2$, T' has at least one vertex. Suppose that T' has exactly one vertex. That is, T is a star. Thus $W(T) \leq 1 + \text{star}(T) \cdot (n - 1)$ since every leaf has weight at most $n - 1$. Thus

$$f(T) = \left\lfloor \frac{W(T) - (\text{star}(T) - 2)(n - 1)}{n} \right\rfloor \leq \left\lfloor \frac{2n - 1}{n} \right\rfloor = 1 ,$$

which is a contradiction.

Now assume that T' has at least two vertices. In particular, T' has a leaf v . Note that the neighbour of v in T' is not a leaf in T , as otherwise T' would only have one vertex. Now v is not a leaf in T (since it is in T'). Thus v is adjacent to at least one leaf in T . Let x_1, x_2, \dots, x_d be the leaves of T that are adjacent to v .

First suppose that $\sum_i w(x_i) \leq n - 1$. Let $T'' := T - \{x_1, \dots, x_d\}$. Then v is a leaf in T'' . Redefine $w(v) := 1 + \sum_i w(x_i)$. By induction, there is a vertex-partition of T'' into $f(T'')$ disjoint subtrees, each of total weight at least n . Observe that $W(T) = W(T'')$ and $s(T'') = \text{star}(T) - d + 1 \leq \text{star}(T)$. Thus

$$\begin{aligned} f(T'') &= \left\lfloor \frac{W(T'') - (s(T'') - 2)(n - 1)}{n} \right\rfloor \geq \left\lfloor \frac{W(T) - (\text{star}(T) - 2)(n - 1)}{n} \right\rfloor \\ &= f(T) . \end{aligned}$$

Adding x_1, \dots, x_d to the subtree of T'' containing v gives a vertex-partition of T into at least $f(T)$ disjoint subtrees, each with total weight at least n .

Now assume that $\sum_i w(x_i) \geq n$. Let $T''' := T - \{v, x_1, \dots, x_d\}$. Now $s(T''') \leq \text{star}(T) - d + 1$, since w_1, \dots, w_d are leaves in T that are not in T''' , and the neighbour of v in T'' is the only vertex in T''' that possibly is a leaf in T''' but not in T . Observe that $W(T''') \geq W(T) - 1 - d(n - 1)$ since v has weight 1 and each w_i has weight at most $n - 1$. By induction, there is partition of $V(T''')$ into at least $f(T''')$ disjoint subtrees, each with total weight at least n . These subtrees plus $T[\{v, x_1, \dots, x_d\}]$ are a vertex-partition of T into at least $1 + f(T''')$ disjoint subtrees, each with total weight

at least n . Now

$$\begin{aligned} 1 + f(T''') &= 1 + \left\lfloor \frac{W(T''') - (s(T''') - 2)(n - 1)}{n} \right\rfloor \\ &\geq \left\lfloor \frac{n + W(T) - 1 - d(n - 1) - (\text{star}(T) - d + 1 - 2)(n - 1)}{n} \right\rfloor \\ &= \left\lfloor \frac{W(T) - (\text{star}(T) - 2)(n - 1)}{n} \right\rfloor \\ &= f(T) . \end{aligned}$$

This completes the proof. □

Lemma 9.4. *For every positive integer n , every tree T with at least one edge has*

$$\left\lfloor \frac{\mathbf{v}(T) - (\text{star}(T) - 2)(n - 1)}{n} \right\rfloor$$

disjoint subtrees, each with at least n vertices. Moreover, for all integers $s, n \geq 2$ and $N \geq sn$, there is a tree T with $\mathbf{v}(T) = N$ and $\text{star}(T) = s$, such that T has at most

$$\left\lfloor \frac{\mathbf{v}(T) - (\text{star}(T) - 2)(n - 1)}{n} \right\rfloor$$

disjoint subtrees, each with at least n vertices.

Proof. Lemma 9.3 with each leaf assigned a weight of 1 implies the first claim. It remains to construct the tree T . Fix a path P with $N - s(n - 1)$ vertices. Let v and w be the endpoints of P . As illustrated in Figure 7, let T be the tree obtained from P by attaching $\lceil \frac{s}{2} \rceil$ pendant paths to v , each with $n - 1$ vertices, and by attaching $\lfloor \frac{s}{2} \rfloor$ pendant paths to w , each with $n - 1$ vertices. Thus T has N vertices and s leaves.

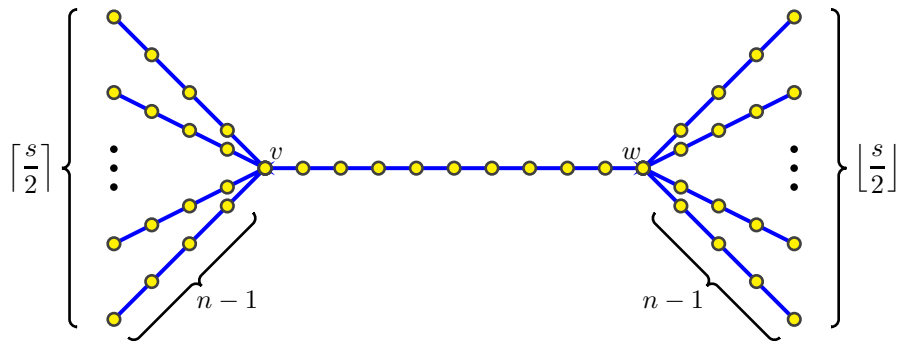

FIGURE 7. The tree T in Lemma 9.4.

Let A be the subtree of T induced by the union of v and the pendant paths attached at v . Let B be the subtree of T induced by the union of w

and the pendant paths attached at w . Let X_1, \dots, X_t be a set of disjoint subtrees in T , each with at least n vertices. If some X_i intersects A then v is in X_i . At most one subtree X_i contains v . Thus at most one subtree X_i intersects A . Similarly, at most one subtree X_j intersects B . The remaining $t - 2$ subtrees are contained in $P - \{v, w\}$. Thus

$$t - 2 \leq \frac{N - s(n - 1) - 2}{n} .$$

It follows that $tn \leq N - (s - 2)(n - 1)$, as desired. \square

Proof of Theorem 9.2. The assumption in Theorem 9.2 implies that

$$\frac{\mathbf{v}(T) - (\mathbf{star}(T) - 2)(n - 1)}{n} \geq n + \frac{1}{n} .$$

Hence

$$\left\lfloor \frac{\mathbf{v}(T) - (\mathbf{star}(T) - 2)(n - 1)}{n} \right\rfloor \geq n .$$

The result thus follows from Lemma 9.4. \square

For every tree T , let $\mathbf{bal}(T)$ be the maximum order of a balance subtree in T . The next lemma shows how to construct a balance of large order. For each vertex r of T , let T_r be the component of $T - r$ with the maximum number of vertices.

Lemma 9.5. *Let r be a vertex in a tree T with degree $d \geq 3$. Then every balance in T rooted at r has order at most $\mathbf{v}(T) - \mathbf{v}(T_r) - 2$. On the other hand, there is a balance in T rooted at r of order at least $\frac{1}{3}(\mathbf{v}(T) - \mathbf{v}(T_r) - 1)$.*

Proof. Consider a balance rooted at r . The largest component of $T - r$ is contained in at most one branch. Thus the other branch has at most $\mathbf{v}(T) - \mathbf{v}(T_r) - 2$ vertices. Hence the order of the balance is at most $\mathbf{v}(T) - \mathbf{v}(T_r) - 2$.

Now we prove the second claim. Let Y_1, \dots, Y_d be the components of $T - r$. Say $\mathbf{v}(Y_1) \geq \dots \geq \mathbf{v}(Y_d)$. Then $\mathbf{v}(T_r) = \mathbf{v}(Y_1)$. Let s be the neighbour of r in Y_d .

First suppose that $d = 3$. Then Y_1 and Y_2 are the branches of a balance rooted at r with support s , and order $\mathbf{v}(Y_2)$. Now $2\mathbf{v}(Y_2) \geq \mathbf{v}(Y_2) + \mathbf{v}(Y_3) = \mathbf{v}(T) - \mathbf{v}(Y_1) - 1$. Thus the order of the balance, $\mathbf{v}(Y_2)$, is at least $\frac{1}{2}(\mathbf{v}(T) - \mathbf{v}(Y_1) - 1) > \frac{1}{3}(\mathbf{v}(T) - \mathbf{v}(Y_1) - 1)$.

Now assume that $d \geq 4$. If A and B are a partition of $[d - 1]$, then $\cup\{Y_i : i \in A\}$ and $\cup\{Y_i : i \in B\}$ are the branches of a balance rooted at r with support s . The order of the balance is

$$\min \left\{ \sum_{i \in B} \mathbf{v}(Y_i), \sum_{i \in A} \mathbf{v}(Y_i) \right\} .$$

A greedy algorithm⁵ gives such a partition with

$$\begin{aligned} \min \left\{ \sum_{i \in B} v(Y_i), \sum_{i \in A} v(Y_i) \right\} &\geq \frac{1}{2} \left(-v(Y_1) + \sum_{i \in [d-1]} v(Y_i) \right) \\ &= \frac{1}{2} (v(T) - v(Y_1) - v(Y_d) - 1) . \end{aligned}$$

Since Y_d is the smallest of Y_2, \dots, Y_d , the order of the balance is at least

$$\begin{aligned} \frac{1}{2} (v(T) - v(Y_1) - \frac{v(T) - v(Y_1) - 1}{d-1} - 1) &= \frac{d-2}{2(d-1)} (v(T) - v(Y_1) - 1) \\ &\geq \frac{1}{3} (v(T) - v(Y_1) - 1) , \end{aligned}$$

as desired. \square

Which trees T have small $\text{bal}(T)$? First note that $\text{bal}(P) = 0$ for every path P . A path P in a tree T is *clean* if every internal vertex of P has degree 2 in T . Let $p(T)$ be the maximum number of vertices in a clean path in T . The *hangover* of T , denoted by $\text{hang}(T)$, is the minimum, taken over all clean paths P in T , of the maximum number of vertices in a component of $T - E(P)$. We now prove that $\text{bal}(T)$ and $\text{hang}(T)$ are tied.

Lemma 9.6. *For every tree T ,*

$$\text{bal}(T) + 1 \leq \text{hang}(T) \leq 3 \text{bal}(T) + 1 .$$

Proof. First we prove the lower bound. Let P be a longest clean path in T . Since every internal vertex in P has degree 2 in T , every balance in T is rooted at a vertex r in one of the components of the forest obtained by deleting the internal vertices and edges of P from T . For every such vertex r , $T - r$ has a component of at least $v(T) - \text{hang}(T) - 1$ vertices. That is, $v(T_r) \geq v(T) - \text{hang}(T) - 1$. By Lemma 9.5, every balance rooted at r has order at most $v(T) - v(T_r) - 2 \leq \text{hang}(T) - 1$. Thus $\text{bal}(T) \leq \text{hang}(T) - 1$.

Now we prove the upper bound. If T is a path then $\text{bal}(T) = \text{hang}(T) = 0$, and we are done. Now assume that T has a vertex of degree at least 3. Let r be a vertex of degree at least 3 in T such that $v(T_r)$ is minimised. Let x be the closest vertex in T_r to r such that $\deg(x) \neq 2$. Let P be the path between r and x in T . Thus P is clean. If x is a leaf, then $v(T_x) = v(T) - 1 \geq v(T_r)$. If $\deg(x) \geq 3$ then $v(T_x) \geq v(T_r)$ by the choice of r . In both cases $v(T_x) \geq v(T_r)$, which implies that r is in T_x . Thus deleting the internal vertices and edges of P gives a forest with two components, one with $v(T) - v(T_r)$ vertices, and the other with $v(T) - v(T_x)$ vertices. Hence $\text{hang}(T) \leq \max\{v(T) - v(T_r), v(T) - v(T_x)\} = v(T) - v(T_r)$. By Lemma 9.5,

⁵Given integers $m_1 \geq m_2 \geq \dots \geq m_t \geq 1$ that sum to m , construct a partition of $[t]$ into sets A and B as follows. For $i \in [t]$, let $A_i := \sum_{j \in [i] \cap A} m_j$ and $B_i := \sum_{j \in [i] \cap B} m_j$. Initialise $A := \{m_1\}$ and $B := \emptyset$. Then for $i = 2, 3, \dots, t$, if $A_{i-1} \leq B_{i-1}$ then add i to A ; otherwise add i to B . Thus $|A_1 - B_1| = m_1$ and by induction, $|A_i - B_i| \leq \max\{|A_{i-1} - B_{i-1}| - m_i, m_i\} \leq \max\{m_1 - m_i, m_i\} \leq m_1$. Thus $|A_t - B_t| \leq m_1$. Hence A_t and B_t are both at least $\frac{1}{2}(m - m_1)$.

there is a balance in T rooted at r of order at least $\frac{1}{3}(\mathfrak{v}(T) - \mathfrak{v}(T_r) - 1) \geq \frac{1}{3}(\text{hang}(T) - 1)$. Hence $\text{bal}(T) \geq \frac{1}{3}(\text{hang}(T) - 1)$. \square

We now prove that if the product of sufficiently large trees has bounded Hadwiger number then both trees have bounded hangover.

Lemma 9.7. *Fix an integer $c \geq 1$. Let T_1 and T_2 be trees, such that $\mathfrak{v}(T_1) \geq 2c^2 - c + 2$, $\mathfrak{v}(T_2) \geq c + 1$, and $\eta(T_1 \square T_2) \leq c$. Then*

$$\text{hang}(T_2) \leq 3c + 1 .$$

By symmetry, if in addition $\mathfrak{v}(T_2) \geq 2c^2 - c + 2$ then

$$\text{hang}(T_1) \leq 3c + 1 .$$

Proof. If $\text{star}(T_1) \geq c$, then by Corollary 5.3, $\eta(T_1 \square T_2) \geq \min\{\mathfrak{v}(T_2), \text{star}(T_1) + 1\} \geq c + 1$, which contradicts the assumption. Now assume that $\text{star}(T_1) \leq c - 1$.

Let $n := c + 1$. Then $\mathfrak{v}(T_1) \geq (c + 1)^2 + (c - 3)c + 1 \geq n^2 + (\text{star}(T_1) - 2)(n - 1) + 1$. Thus Theorem 9.2 is applicable to T_1 with $n = c + 1$. Hence T_1 has $c + 1$ disjoint subtrees, each with at least $c + 1$ vertices.

If $\text{bal}(T_2) \geq c + 1$, then by Theorem 9.1, $\eta(T_1 \square T_2) \geq \min\{c + 1, \text{bal}(T_2)\} = c + 1$, which contradicts the assumption. Thus $\text{bal}(T_2) \leq c$, and by Lemma 9.6, $\text{hang}(T_2) \leq 3c + 1$. \square

We now prove a converse result to Lemma 9.7. It says that the product of two trees has small Hadwiger number whenever one of the trees is small or both trees have small hangover.

Lemma 9.8. *Let T_1 and T_2 be trees, such that for some integer $c \geq 1$,*

- $\mathfrak{v}(T_1) \leq c$ or $\mathfrak{v}(T_2) \leq c$, or
- $\text{hang}(T_1) \leq c$ and $\text{hang}(T_2) \leq c$.

Then $\eta(T_1 \square T_2) \leq c'$ for some c' depending only on c .

Proof. First suppose that $\mathfrak{v}(T_1) \leq c$. Then $\eta(T_1 \square T_2) \leq \eta(K_c \square T_2) = c + 1$ by Theorem 10.1 below. Similarly, if $\mathfrak{v}(T_2) \leq c$ then $\eta(T_1 \square T_2) \leq c + 1$.

Otherwise, by assumption, $\text{hang}(T_1) \leq c$ and $\text{hang}(T_2) \leq c$. For $i \in [2]$, let P_i be a clean path with $p(T_i)$ vertices in T_i . Now $P_1 \square P_2$ is a planar $p(T_1) \times p(T_2)$ grid subgraph H in $T_1 \square T_2$. We now show that $T_1 \square T_2$ can be obtained from H by adding a vortex in the outerface of H .

Let F be the set of vertices on the outerface of H in clockwise order. Consider a vertex $v = (v_1, v_2) \in F$, where $v_1 \in V(P_1)$ and $v_2 \in V(P_2)$. For $i \in [2]$, let $A_i(v)$ be the component of $T_i - E(P_i)$ that contains v_i . As illustrated in Figure 8, define $S(v)$ to be the set $\{(a, b) : a \in A_1(v), b \in A_2(v)\}$ of vertices in $T_1 \square T_2$. Every vertex of $G - H$ is in $S(v)$ for some vertex $v \in F$. In addition, each vertex $v \in F$ is in $S(v)$. For every edge e of $T_1 \square T_2$ where both endpoints of e are in $\cup\{S(v) : v \in F\}$, the endpoints of e are in one bag or in bags corresponding to consecutive vertices in F . For each vertex $v \in F$, if w is clockwise from v in F , then define $S'(v) :=$

$S(v) \cup S(w)$. Hence for every edge xy of $T_1 \square T_2$ where both endpoints of e are in $\cup\{S(v) : v \in F\}$, the endpoints of e are both in $S'(v)$ for some vertex $v \in F$. Now $|S(v)| = |A_1(v)| \cdot |A_2(v)| \leq \text{hang}(T_1)^2 \leq c^2$. Thus $\{S'(v) : v \in F\}$ is a vortex of width at most $2c^2$.

It is well known that every graph obtained from a graph embedded in a surface of bounded genus by adding a vortex of bounded width has bounded Hadwiger number. Thus $\eta(T_1 \square T_2)$ is at most some constant depending only on c . Recently, Joret and Wood [35] proved a tight bound on the Hadwiger number of such a graph; it implies that $\eta(T_1 \square T_2) \leq \mathcal{O}(c^2)$. \square

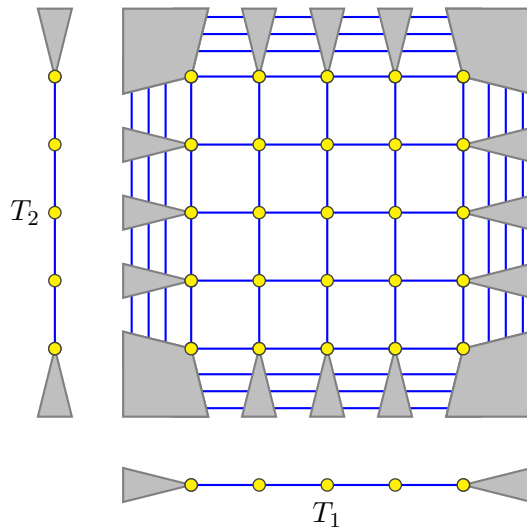

FIGURE 8. The sets $S(v)$ in the proof of Lemma 9.8.

Lemmas 9.7 and 9.8 imply the following rough structural characterisation theorem for the products of trees.

Theorem 9.9. *For trees T_1 and T_2 each with at least one edge, the function $\eta(T_1 \square T_2)$ is tied to $\min \{v(T_1), v(T_2), \max\{\text{hang}(T_1), \text{hang}(T_2)\}\}$.*

Theorem 9.9 can be informally stated as: $\eta(T_1 \square T_2)$ is bounded if and only if:

- $v(T_1)$ or $v(T_2)$ is bounded, or
- $\text{hang}(T_1)$ and $\text{hang}(T_2)$ are bounded.

Theorem 9.9 is generalised for products of arbitrary graphs in Theorem 11.8 below.

10. PRODUCT OF A GENERAL GRAPH AND A COMPLETE GRAPH

This section studies the Hadwiger number of the product of a general graph and a complete graph. Miller [40] stated without proof that

$\eta(T \square K_n) = n + 1$ for every tree T and integer $n \geq 2$. We now prove this claim.

Theorem 10.1. *For every tree T with at least one edge and integer $n \geq 1$,*

$$\eta(T \square K_n) = n + 1 .$$

Proof. Since $K_2 \square K_n$ is a subgraph of $T \square K_n$, the lower bound $\eta(T \square K_n) \geq n + 1$ follows from Proposition 7.2. It remains to prove the upper bound $\eta(T \square K_n) \leq n + 1$. Let X_1, \dots, X_k be the branch sets of a complete minor in $T \square K_n$, where $k = \eta(T \square K_n)$. For each $i \in [k]$, let T_i be the subtree of T consisting of the edges $vw \in E(T)$ such that (v, j) or (w, j) is in X_i for some $j \in [n]$. Since X_i is connected, T_i is connected. Since X_i and X_j are adjacent, T_i and T_j share an edge in common. By the Helly property of trees, there is an edge vw of T in every subtree T_i . Let Y be the set of vertices $\{(v, j), (w, j) : j \in [n]\}$. Thus, by construction, every X_i contains a vertex in Y . Since $|Y| = 2n$, if every X_i has at least two vertices in Y , then $k \leq n$, and we are done. Now assume that some X_i has only one vertex in Y . Say (v, j) is the vertex in $X_i \cap Y$. Let T_v and T_w be the subtrees of T obtained by deleting the edge vw , where $v \in V(T_v)$ and $w \in V(T_w)$. Thus X_i is contained in $T_v \square K_n$. Let Z be the set of neighbours of (v, j) in Y . That is, $Z = \{(v, \ell) : \ell \in [n] - \{j\}\} \cup \{(w, j)\}$. Suppose on the contrary that some branch set X_p ($p \neq i$) has no vertex in Z . Then X_p is contained in $T_w \square K_n$ minus the vertex (w, j) . Thus X_i and X_p are not adjacent. This contradiction proves that every branch set X_p ($p \neq i$) has a vertex in Z . Since $|Z| = n$, $k \leq n + 1$, as desired. \square

Theorem 10.1 is generalised through the notion of treewidth.

Theorem 10.2. *For every graph G and integer $n \geq 1$,*

$$\eta(G \square K_n) \leq \text{tw}(G \square K_n) + 1 \leq n(\text{tw}(G) + 1) .$$

Moreover, for all integers $k \geq 2$ and $n \geq 2$ there is a graph G with $\text{tw}(G) = k$ and

$$\eta(G \square K_n) = \text{tw}(G \square K_n) + 1 = n(k + 1) .$$

Proof. First we prove the upper bound⁶. Let $(T, \{T_x \subseteq V(G) : x \in V(T)\})$ be a tree decomposition of G with at most $\text{tw}(G) + 1$ vertices in each bag. Replace each bag T_x by $\{(v, i) : v \in T_x, i \in [n]\}$. We obtain a tree decomposition of $G \square K_n$ with at most $n(\text{tw}(G) + 1)$ vertices in each bag. Thus $\text{tw}(G \square K_n) \leq n(\text{tw}(G) + 1) - 1$. Every graph H satisfies $\eta(H) \leq \text{tw}(H) + 1$. The result follows.

Now we prove the lower bound. Let G be the graph with vertex set

$$V(G) := \{v_1, \dots, v_{k+1}\} \cup \{x_{i,j,p} : i, j \in [k+1], p \in [n]\} ,$$

where $\{v_1, \dots, v_{k+1}\}$ is a clique, and each $x_{i,j,p}$ is adjacent to v_i and v_j . A tree decomposition T of G is constructed as follows. Let $T_r :=$

⁶This upper bound even holds for strong products.

$\{v_1, \dots, v_{k+1}\}$, and for all $i, j \in [k+1]$ and $p \in [n]$, let $T_{i,j,p} := \{x_{i,j,p}, v_i, v_j\}$, where T_r is adjacent to every $T_{i,j,p}$ and there are no other edges in T . Thus T is a star with $n(k+1)^2$ leaves, and $(T, \{T_x : x \in V(T)\})$ is a tree decomposition of G with at most $k+1$ vertices in each bag. Thus $\text{tw}(G) \leq k$. Since G contains a clique of $k+1$ vertices, $\text{tw}(G) = k$.

Now consider $G \square K_n$. For $i, j \in [k+1]$ and $p \in [n]$, let $A\langle i, j, p \rangle$ be the subgraph of $G \square K_n$ induced by $\{(x_{i,j,p}, q) : q \in [n]\}$. Thus $A\langle i, j, p \rangle$ is a copy of K_n . For $i \in [k+1]$ and $p \in [n]$, let $X\langle i, p \rangle$ be the subgraph induced by $\cup\{A\langle i, j, p \rangle : j \in [k+1]\}$ plus the vertex (v_i, p) . We claim that the $X\langle i, p \rangle$ are the branch set of clique minor in $G \square K_n$. First we prove that each $X\langle i, p \rangle$ is connected. For all $j \in [k+1]$, v_i is adjacent to $x_{i,j,p}$ in G . Thus (v_i, p) is adjacent to $(x_{i,j,p}, p)$, which is in $A\langle i, j, p \rangle \subset X\langle i, p \rangle$. Thus $X\langle i, p \rangle$ consists of $k+1$ copies of K_n plus one vertex adjacent to each copy. In particular, $X\langle i, p \rangle$ is connected. Now consider distinct subgraphs $X\langle i, p \rangle$ and $X\langle j, q \rangle$. The first coordinate of every vertex in $X\langle i, p \rangle$ is either $v_{i,p}$ or $x_{i,i',p}$ for some $i' \in [k+1]$. Thus $X\langle i, p \rangle$ and $X\langle j, q \rangle$ are disjoint. Now the vertex $x_{i,j,p}$ is adjacent to the vertex $v_{j,q}$ in G . Thus the vertex $(x_{i,j,p}, q)$, which is in $A\langle i, j, p \rangle \subset X\langle i, p \rangle$, is adjacent to the vertex $(v_{j,q}, q)$, which is in $X\langle j, q \rangle$. Thus $X\langle i, p \rangle$ and $X\langle j, q \rangle$ are adjacent. Hence the $X\langle i, p \rangle$ are the branch set of clique minor in $G \square K_n$, and $\eta(G \square K_n) \geq n(k+1)$. We have equality because of the above upper bound. \square

We have the following similar upper bound for the bandwidth of a product.

Lemma 10.3. *For every graph G and integer $n \geq 1$,*

$$\text{bw}(G \square K_n) \leq n \cdot \text{bw}(G) .$$

Proof. Say $V(K_n) = \{w_1, \dots, w_n\}$. Let (v_1, \dots, v_p) be a vertex ordering of G , such that $\max\{|i-j| : v_i v_j \in E(G)\} = \text{bw}(G)$. Order the vertices of $G \square K_n$,

$$(v_1, w_1), \dots, (v_1, w_n); (v_2, w_1), \dots, (v_2, w_n); \dots; (v_p, w_1), \dots, (v_p, w_n) .$$

In this ordering, an edge $(v_i, w_j)(v_i, w_\ell)$ of $G \square K_n$ has length at most $n-1$, and an edge $(v_i, w_\ell)(v_j, w_\ell)$ of $G \square K_n$ has length $n \cdot |i-j| \leq n \cdot \text{bw}(G)$ (since $v_i v_j \in E(G)$). Thus $\text{bw}(G \square K_n) \leq n \cdot \text{bw}(G)$ (since $n \cdot \text{bw}(G) \geq n-1$). \square

We now set out to prove a lower bound on $\eta(G \square K_n)$ in terms of the treewidth of G . We start by considering the case $n=2$, which is of particular importance in Section 12 below. Robertson and Seymour [45] proved that every graph with large treewidth has a large grid minor. The following explicit bound was obtained by Diestel et al. [14]; also see [13, Theorem 12.4.4].

Lemma 10.4 ([14]). *For all integers $k, m \geq 1$ every graph with tree-width at least $k^{4m^2(k+2)}$ contains $P_k \square P_k$ or K_m as a minor. In particular, every graph with tree-width at least $k^{4k^4(k+2)}$ contains a $P_k \square P_k$ -minor.*

In what follows all logarithms are binary.

Lemma 10.5. *For every graph G with at least one edge,*

$$\eta(G \square K_2) > \left(\frac{1}{4} \log \text{tw}(G)\right)^{1/4} .$$

Proof. Let ℓ be the real-valued solution to $\text{tw}(G) = \ell^{4(\ell+1)^3}$. Thus $\ell \geq 1$, and

$$\log \text{tw}(G) = 4(\ell+1)^3(\log \ell) < 4(\ell+1)^4 .$$

That is, $(\frac{1}{4} \log \text{tw}(G))^{1/4} < \ell + 1$. Let $k := \lfloor \ell \rfloor$. Thus $k \geq 1$ and $\text{tw}(G) \geq k^{4(k+1)^3}$. Hence Lemma 10.4 is applicable with $m = k + 1$. Thus G contains $P_k \square P_k$ or K_{k+1} as a minor. If G contains a $P_k \square P_k$ -minor, then $G \square K_2$ contains a K_{k+2} -minor by (2). Otherwise G contains a K_{k+1} minor, and by Proposition 7.2, $G \square K_2$ contains a K_{k+2} -minor. In both cases

$$\eta(G \square K_2) \geq k + 2 > \ell + 1 > \left(\frac{1}{4} \log \text{tw}(G)\right)^{1/4} ,$$

as desired. \square

Lemma 10.5 and Theorem 10.2 imply that $\eta(G \square K_2)$ is tied to the treewidth of G . In particular,

$$(5) \quad \left(\frac{1}{4} \log \text{tw}(G)\right)^{1/4} < \eta(G \square K_2) \leq 2 \text{tw}(G) + 2 .$$

This result is similar to a theorem by Behzad and Mahmoodian [2], who proved that $G \square K_2$ is planar if and only if G is outerplanar. Equation (5) says that $G \square K_2$ has bounded η if and only if G has bounded treewidth.

We now extend Lemma 10.5 for general complete graphs.

Lemma 10.6. *For every graph G with at least one edge and every integer $n \geq 1$,*

$$\eta(G \square K_n) > \lfloor \frac{n}{2} \rfloor \left(\frac{1}{16} \log \text{tw}(G)\right)^{1/6} .$$

Proof. Let ℓ be the real-valued solution to $\text{tw}(G) = \ell^{4\ell^4(\ell+2)}$. Thus $\ell \geq 1$. Thus

$$\log \text{tw}(G) = 4\ell^4(\ell+2)(\log \ell) \leq 12\ell^6 .$$

That is, $(\frac{1}{16} \log \text{tw}(G))^{1/6} \leq \ell$. Let $k := \lfloor \ell \rfloor$. Thus $\ell \geq k \geq 1$ and $\text{tw}(G) \geq k^{4k^4(k+2)}$. By Lemma 10.4, G contains a $P_k \square P_k$ -minor. By Lemma 10.7 below,

$$\eta(G \square K_n) \geq \lfloor \frac{n}{2} \rfloor (k + 1) > \lfloor \frac{n}{2} \rfloor \ell \geq \lfloor \frac{n}{2} \rfloor \left(\frac{1}{16} \log \text{tw}(G)\right)^{1/6} ,$$

as desired. \square

Lemma 10.6 and Theorem 10.2 imply that $\eta(G \square K_n)/n$ is tied to the treewidth of G . In particular,

$$\left(\frac{1}{16} \log \text{tw}(G)\right)^{1/6} < \frac{\eta(G \square K_n)}{n} \leq \text{tw}(G) + 1 .$$

It remains to prove Lemma 10.7.

Lemma 10.7. *For all integers $n \geq 1$ and $k \geq 1$*

$$(k+1)\lfloor \frac{n}{2} \rfloor \leq \eta(P_k \square P_k \square K_n) < k(n + \frac{1}{2}) + 3 .$$

Proof. Since $P_k \square P_k \square K_n$ has k^2n vertices and maximum degree $n+3$, Lemma 2.2 implies the upper bound,

$$\eta(P_k \square P_k \square K_n) \leq \sqrt{(n+1)k^2n} + 3 < k(n + \frac{1}{2}) + 3 .$$

Now we prove the lower bound. Let $p := \lfloor \frac{n}{2} \rfloor$. Each vertex is described by a triple (x, y, r) where $x, y \in [k]$ and $r \in [n]$. Distinct vertices (x, y, r) and (x', y', r') are adjacent if and only if $x = x'$ and $y = y'$, or $x = x'$ and $|y - y'| = 1$ and $r = r'$, or $y = y'$ and $|x - x'| = 1$ and $r = r'$.

For $r \in [p]$, let $T_{0,r}$ be the subgraph induced by $\{(1, y, 2r-1) : y \in [k]\}$, and let $T_{1,r}$ be the subgraph induced by $\{(x, 1, 2r) : x \in [k]\}$. For $i \in [2, k]$ and $r \in [p]$, let $T_{i,r}$ be the subgraph of $P_k \square P_k \square K_n$ induced by

$$\{(i, y, 2r-1) : y \in [k]\} \cup \{(x, i, 2r) : x \in [k]\} .$$

For all $r \in [p]$, both $T_{0,r}$ and $T_{1,r}$ are paths, and for $i \in [2, k]$, $T_{i,r}$ consists of two adjacent paths. In particular, each $T_{i,r}$ is connected. Observe that each pair of distinct subgraphs $T_{i,r}$ and $T_{j,s}$ are disjoint.

There is an edge from $(1, 1, 2r-1)$ in $T_{0,r}$ to $(1, 1, 2s)$ in $T_{1,s}$. For all $i \in [2, k]$, there is an edge from $(1, i, 2r)$ in $T_{i,r}$ to $(1, i, 2s-1)$ in $T_{0,s}$, there is an edge from $(i, 1, 2r-1)$ in $T_{i,r}$ to $(i, 1, 2s)$ in $T_{1,s}$, and for all $i, j \in [2, k]$, there is an edge from $(j, i, 2r)$ in $T_{i,r}$ to $(j, i, 2s-1)$ in $T_{j,s}$.

Hence the $T_{i,j}$ are the branch sets of a $K_{(k+1)m}$ -minor. Therefore

$$\eta(P_k \square P_k \square K_n) \geq (k+1)p = (k+1) \lfloor \frac{n}{2} \rfloor . \quad \square$$

11. ROUGH STRUCTURAL CHARACTERISATION THEOREM

In this section we give a rough structural characterisation of pairs of graphs whose product has bounded Hadwiger number. The proof is based heavily on the corresponding result for trees in Section 9. Thus our first task is to extend a number of definitions for trees to general graphs.

For a connected graph G , let $\text{bal}(G)$ be the maximum order of a balance subgraph in G . A path P in G is *semi-clean* if every internal vertex of P has degree 2 in G . Let $p'(G)$ be the maximum number of vertices in a semi-clean path in G . A path P is *clean* if it is semi-clean, and every edge of P is a cut in G . Let $p(G)$ be the maximum number of vertices in a clean path in G . Note that $p(G) \geq 1$ since a single vertex is a clean path. In fact, if G is 2-connected, then the only clean paths are single vertices, and $p(G) = 1$. On the other hand, since every edge in a tree T is a cut, our two definitions of a clean path are equivalent for trees, and $p'(T) = p(T)$.

The *hangover* of a connected graph G , denoted by $\text{hang}(G)$, is defined as follows. If G is a path or a cycle then $\text{hang}(G) := 0$. Otherwise, $\text{hang}(G)$ is the minimum, taken over all clean paths P in G , of the maximum number

of vertices in a component of $G - E(P)$. First note the following trivial relationship between $\text{hang}(G)$ and $p(G)$:

$$(6) \quad \frac{1}{2}(\mathfrak{v}(G) - p(G) + 2) \leq \text{hang}(G) \leq \mathfrak{v}(G) - p(G) + 1.$$

To prove a relationship between $\text{bal}(G)$ and $\text{hang}(G)$ below, we reduce the proof to the case of trees using the following lemma.

Lemma 11.1. *Every connected graph G has a spanning tree T such that*

$$p(T) \leq p'(G) + 6 .$$

Proof. Define a *leaf-neighbour* in a tree to be a vertex of degree 2 that is adjacent to a leaf (a vertex of degree 1).

Choose a spanning tree T of G that firstly maximises the number of leaves in T , and secondly maximises the number of leaf-neighbours in T .

If $p(T) \leq 7$ then the claim is vacuous since $p'(G) \geq 1$. Now assume that $p(T) \geq 8$. Let (v_1, \dots, v_k) be a clean path in T with $k = p(T)$. Below we prove that $\deg_G(v_i) = 2$ for each $i \in [4, k - 3]$. This shows that the path (v_4, \dots, v_{k-3}) is semi-clean in G , implying $p'(G) \geq p(T) - 6$, as desired.

Suppose on the contrary that $\deg_G(v_i) \geq 3$ for some $i \in [4, k - 3]$. Let w be a neighbour of v_i in G besides v_{i-1} and v_{i+1} . Without loss of generality, the path between v_i and w in T includes v_{i+1} .

Case 1. $\deg_T(w) \geq 2$: Let T' be the spanning tree of G obtained from T by deleting the edge $v_i v_{i+1}$ and adding the edge $v_i w$. Now $\deg_T(v_{i+1}) = 2$ (since $i + 1 \leq k - 1$). Thus v_{i+1} becomes a leaf in T' . Since $\deg_T(v_i) = \deg_{T'}(v_i) = 2$, v_i is a leaf in neither T nor T' . Since $\deg_T(w) \geq 2$ and $\deg_{T'}(w) \geq 3$, w is a leaf in neither T nor T' . The degree of every other vertex is unchanged. Hence T' has one more leaf than T . This contradicts the choice of T .

Now assume that $\deg_T(w) = 1$. Let x be the neighbour of w in T .

Case 2. $\deg_T(w) = 1$ and $\deg_T(x) = 2$: Let T' be the spanning tree of G obtained from T by deleting the edge wx and adding the edge $v_i w$. Since $\deg_T(v_i) = 2$ and $\deg_{T'}(v_i) = 3$, v_i is a leaf in neither T nor T' . Since $\deg_T(w) = \deg_{T'}(w) = 1$, w is a leaf in both T and T' . Since $\deg_T(x) = 2$ and $\deg_{T'}(x) = 1$, x becomes a leaf in T' . The degree of every other vertex is unchanged. Hence T' has one more leaf than T . This contradicts the choice of T .

Case 3. $\deg_T(w) = 1$ and $\deg_T(x) \geq 3$: Let T' be the spanning tree of G obtained from T by deleting the edge $v_i v_{i+1}$ and adding the edge $v_i w$. Since $\deg_T(v_i) = \deg_{T'}(v_i) = 2$, v_i is a leaf in neither T nor T' . Now $\deg_T(v_{i+1}) = 2$ (since $i + 1 \leq k - 1$). Thus v_{i+1} is a leaf in T' but not in T . Since $\deg_T(w) = 1$ and $\deg_{T'}(w) = 2$, w is a leaf in T but not in T' . The degree of every other vertex is unchanged. Hence T' has the same number of leaves as T .

Suppose, for the sake of contradiction, that there is a leaf-neighbour p in T that is not a leaf-neighbour in T' . Since v_{i+1} and w are the only vertices with different degrees in T and T' , p is either v_{i+1} or w , or p is a neighbour

of v_{i+1} or w in T or T' . That is, $p \in \{v_{i+1}, w, x, v_i, v_{i+2}\}$. Now $\deg_T(p) = 2$ since p is a leaf-neighbour in T . Thus $p \neq w$ and $p \neq x$. Every neighbour of v_i and v_{i+1} in T has degree 2 in T (since $i - 1 \geq 2$ and $i + 2 \leq k - 1$). Thus $p \neq v_i$ and $p \neq v_{i+1}$. Finally, $p \neq v_{i+2}$ since the neighbours of v_{i+2} in T , namely v_{i+1} and v_{i+3} , are both not leaves (since there is a path in T from v_{i+3} to x that avoids v_{i+2}). This contradiction proves that every leaf-neighbour in T is also a leaf-neighbour in T' .

Now consider the vertex v_{i+2} . In both T and T' , the only neighbours of v_{i+2} are v_{i+1} and v_{i+3} (since $i + 2 \leq k - 1$). Both v_{i+1} and v_{i+3} have degree 2 in T , but v_{i+1} is a leaf in T' . Thus v_{i+2} is a leaf-neighbour in T' , but not in T .

Hence T' has more leaf-neighbours than T . This contradicts the choice of T , and completes the proof. \square

Lemma 9.6 proves that $\text{bal}(T)$ and $\text{hang}(T)$ are tied for trees. We now prove an analogous result for general graphs.

Lemma 11.2. *For every connected graph G ,*

$$\text{hang}(G) \leq 8 \text{bal}(G) + 9 .$$

Proof. If G is a path or cycle, then $\text{hang}(G) = 0$ and the result is vacuous. Now assume that G is neither a path nor a cycle. By Lemma 11.1, G has a spanning tree T such that $p(T) \leq p'(G) + 6$. By Lemma 9.6,

$$\text{bal}(G) \geq \text{bal}(T) \geq \frac{1}{3}(\text{hang}(T) - 1) .$$

By the lower bound in (6),

$$\begin{aligned} \text{bal}(G) &\geq \frac{1}{3}(\frac{1}{2}(\text{v}(T) - p(T) + 2) - 1) = \frac{1}{6}(\text{v}(G) - p(T)) \\ &\geq \frac{1}{6}(\text{v}(G) - p'(G) - 6) . \end{aligned}$$

Thus we are done if $\frac{1}{6}(\text{v}(G) - p'(G) - 6) \geq \frac{1}{8}(\text{hang}(G) - 9)$. Now assume that

$$\frac{1}{6}(\text{v}(G) - p'(G) - 6) \leq \frac{1}{8}(\text{hang}(G) - 9) .$$

By the upper bound in (6),

$$\frac{1}{6}(\text{v}(G) - p'(G) - 6) \leq \frac{1}{8}(\text{v}(G) - p(G) + 1 - 9) .$$

That is,

$$(7) \quad \text{v}(G) + 3p(G) \leq 4p'(G) .$$

If $p(G) \geq p'(G)$, then $\text{v}(G) \leq p'(G)$, which implies that G is a path. Now assume that $p(G) \leq p'(G) - 1$. Thus there is a non-clean semi-clean path P in G of length $p'(G)$. Since P is not clean and G is connected and not a cycle, there is a cycle C in G with at least $p'(G)$ vertices, such that one vertex r in C is adjacent to a vertex s not in C . It follows that G has a balance rooted at r with support s , and with order at least $\lfloor \frac{1}{2}(p'(G) - 1) \rfloor$. Thus $\text{bal}(G) \geq \frac{1}{2}p'(G) - 1$. That is, $8 \text{bal}(G) + 8 \geq 4p'(G)$. By (7),

$$8 \text{bal}(G) + 8 \geq \text{v}(G) + 3p(G) \geq \text{v}(G) \geq \text{hang}(G) ,$$

as desired. \square

We now prove an analogue of Lemma 9.7 for general graphs.

Lemma 11.3. *Fix an integer $c \geq 1$. Let G and H be graphs, such that $\nu(G) \geq 2c^2 - c + 2$, $\nu(H) \geq c + 1$, and $\eta(G \square H) \leq c$. Then*

$$\text{hang}(H) \leq 8c + 9 .$$

By symmetry, if in addition $\nu(H) \geq 2c^2 - c + 2$ then

$$\text{hang}(G) \leq 8c + 9 .$$

Proof. If $\text{star}(G) \geq c$, then by Corollary 5.3,

$$\eta(G \square H) \geq \min\{\nu(H), \text{star}(G) + 1\} \geq c + 1 ,$$

which contradicts the assumption. Now assume that $\text{star}(G) \leq c - 1$.

Let T be a spanning tree of G . Let $n := c + 1$. Then

$$\begin{aligned} \nu(T) = \nu(G) &\geq (c + 1)^2 + (c - 3)c + 1 \geq n^2 + (\text{star}(G) - 2)(n - 1) + 1 \\ &\geq n^2 + (\text{star}(T) - 2)(n - 1) + 1 . \end{aligned}$$

Thus Theorem 9.2 is applicable to T with $n = c + 1$. Hence T has $c + 1$ disjoint subtrees, each with at least $c + 1$ vertices.

If $\text{bal}(H) \geq c + 1$, then by Theorem 9.1,

$$\eta(G \square H) \geq \min\{c + 1, \text{bal}(H)\} = c + 1 ,$$

which contradicts the assumption. Thus $\text{bal}(H) \leq c$. Hence, by Lemma 11.2, $\text{hang}(H) \leq 8c + 9$. \square

We now prove that the product of graphs with bounded hangover have a specific structure.

Lemma 11.4. *Fix an integer $c \geq 1$. For all graphs G and H , if $\text{hang}(G) \leq c$ and $\text{hang}(H) \leq c$, then $G \square H$ is one of the following graphs:*

- a planar grid (the product of two paths) with a vortex of width at most $2c^2$ in the outerface,
- a cylindrical grid (the product of a path and a cycle) with a vortex of width at most $2c$ in each of the two ‘big’ faces, or
- a toroidal grid (the product of two cycles).

Proof. If G and H are cycles then $G \square H$ is a toroidal grid. If neither G nor H are cycles then by the same argument used in the proof of Lemma 9.8, $G \square H$ is obtained from a planar $p(G) \times p(H)$ grid by adding a vortex in the outerface with width at most $2c^2$. If G is a cycle and H is not a cycle, then by a similar argument used in the proof of Lemma 9.8, $G \square H$ is obtained from a cylindrical $\nu(C_n) \times p(H)$ grid by adding a vortex in each of the two ‘big’ faces with width at most $2c$. \square

Lemmas 11.3 and 11.4 imply the following characterisation of large graphs with bounded Hadwiger number that was described in Section 1.

Theorem 11.5. *Fix an integer $c \geq 1$. For all graphs G and H with $v(G) \geq 2c^2 - c + 2$ and $v(H) \geq 2c^2 - c + 2$, if $\eta(G \square H) \leq c$ then $G \square H$ is one of the following graphs:*

- a planar grid (the product of two paths) with a vortex of width at most $2(8c + 9)^2$ in the outerface,
- a cylindrical grid (the product of a path and a cycle) with a vortex of width at most $16c + 18$ in each of the two ‘big’ faces, or
- a toroidal grid (the product of two cycles).

Theorem 11.5 is similar to a result by Behzad and Mahmoodian [2], who proved that if G and H are connected graphs with at least 3 vertices, then $G \square H$ is planar if and only if both G and H are paths, or one is a path and the other is a cycle.

We now prove the first part of our rough structural characterisation of graph products with bounded Hadwiger number.

Lemma 11.6. *Let G and H be connected graphs, each with at least one edge, such that $\eta(G \square H) \leq c$ for some integer c . Then for some integers c_1, c_2, c_3 depending only on c :*

- $\text{tw}(G) \leq c_1$ and $v(H) \leq c_2$, or
- $\text{tw}(H) \leq c_1$ and $v(G) \leq c_2$, or
- $\text{hang}(G) \leq c_3$ and $\text{hang}(H) \leq c_3$.

Proof. Let $c_1 := 2^{4c^4}$, $c_2 := 2c^2 - c + 1$, and $c_3 := 8c + 9$.

First suppose that $\text{tw}(G) > c_1$ or $\text{tw}(H) > c_1$. Without loss of generality, $\text{tw}(G) > c_1$. Then by Lemma 10.5, $\eta(G \square H) \geq \eta(G \square K_2) > (\frac{1}{4} \log c_1)^{1/4} = c$, which is a contradiction. Now assume that $\text{tw}(G) \leq c_1$ and $\text{tw}(H) \leq c_1$.

Thus, if $v(H) \leq c_2$ or $v(G) \leq c_2$, then the first or second condition is satisfied, and we are done. Now assume that $v(H) > c_2$ and $v(G) > c_2$. By Lemma 11.3, $\text{hang}(G)$ and $\text{hang}(H)$ are both at most $8c + 9 = c_3$, as desired. \square

Now we prove the converse of Lemma 11.6.

Lemma 11.7. *Let G and H be connected graphs, each with at least one edge, such that for some integers c_1, c_2, c_3 ,*

- $\text{tw}(G) \leq c_1$ and $v(H) \leq c_2$, or
- $\text{tw}(H) \leq c_1$ and $v(G) \leq c_2$, or
- $\text{hang}(G) \leq c_3$ and $\text{hang}(H) \leq c_3$.

Then $\eta(G \square H) \leq c$ where c depends only on c_1, c_2, c_3 .

Proof. Suppose that $\text{tw}(G) \leq c_1$ and $v(H) \leq c_2$. Theorem 10.2 implies that

$$\eta(G \square H) \leq \eta(G \square K_{c_2}) \leq c_2(\text{tw}(G) + 1) \leq c_2(c_1 + 1),$$

and we are done. Similarly, if $\text{tw}(H) \leq c_1$ and $v(G) \leq c_2$, then $\eta(G \square H) \leq c_2(c_1 + 1)$, and we are done. Otherwise, $\text{hang}(G) \leq c_3$ and $\text{hang}(H) \leq c_3$. By Lemma 11.4, $G \square H$ is either a toroidal grid (which has no K_8 minor), or

$G \square H$ is a planar graph plus vortices of width at most $2c^2$ in one or two of the faces. As in the proof of Lemma 9.8, it follows that $\eta(G \square H) \leq \mathcal{O}(c^2)$. \square

Lemmas 11.6 and 11.7 imply the following rough structural characterisation of graph products with bounded Hadwiger number.

Theorem 11.8. *The function $\eta(G \square H)$ is tied to*

$$\min \left\{ \max\{\text{tw}(G), \text{v}(H)\}, \max\{\text{v}(G), \text{tw}(H)\}, \max\{\text{hang}(G), \text{hang}(H)\} \right\} .$$

Theorem 11.8 can be informally stated as: $\eta(G \square H)$ is bounded if and only if:

- $\text{tw}(G)$ and $\text{v}(H)$ is bounded, or
- $\text{v}(G)$ and $\text{tw}(H)$ is bounded, or
- $\text{hang}(G)$ and $\text{hang}(H)$ are bounded.

12. ON HADWIGER'S CONJECTURE FOR CARTESIAN PRODUCTS

In 1943, Hadwiger [23] made the following conjecture:

Hadwiger's Conjecture. For every graph G ,

$$\chi(G) \leq \eta(G) .$$

This conjecture is widely considered to be one of the most significant open problems in graph theory; see the survey by Toft [55]. Yet it is unknown whether Hadwiger's conjecture holds for all non-trivial products. (We say $G \square H$ is *non-trivial* if both G and H are both connected and have at least one edge.) The chromatic number of a product is well understood. In particular, Sabidussi [48] proved that $\chi(G \square H) = \max\{\chi(G), \chi(H)\}$. Thus Hadwiger's Conjecture for products asserts that

$$\max\{\chi(G), \chi(H)\} \leq \eta(G \square H) .$$

Hadwiger's Conjecture is known to hold for various classes of products. For example, Chandran and Sivadasan [9] proved that the product of sufficiently many graphs (relative to their maximum chromatic number) satisfies Hadwiger's Conjecture. The best bounds are by Chandran and Raju [7, 43], who proved that for some constant c , Hadwiger's Conjecture holds for the non-trivial product $G_1 \square G_2 \square \dots \square G_d$ whenever

$$\max_i \chi(G_i) \leq 2^{2^{(d-c)/2}} .$$

In a different direction, Chandran and Raju [7, 43] proved that if $\chi(G) \geq \chi(H)$ and $\chi(H)$ is not too small relative to $\chi(G)$, then $G \square H$ satisfies Hadwiger's Conjecture. In particular, there is a constant c , such that if $\chi(G) \geq \chi(H) \geq c \log^{3/2} \chi(G)$ then $G \square H$ satisfies Hadwiger's Conjecture. Similarly, they also implicitly proved that

$$\min\{\chi(G), \chi(H)\} \leq \eta(G \square H) ,$$

and concluded that if $\chi(G) = \chi(H)$ then Hadwiger's Conjecture holds for $G \square H$. We make the following small improvement to this result.

Lemma 12.1. *For all connected graphs G and H , both with at least one edge,*

$$\min\{\chi(G), \chi(H)\} \leq \eta(G \square H) - 1 .$$

Moreover, if $G \neq K_2$ and $H \neq K_2$ then

$$\min\{\chi(G), \chi(H)\} \leq \eta(G \square H) - 2 .$$

Proof. We have $\chi(G) \leq \Delta(G) + 1$ and $\chi(H) \leq \Delta(H) + 1$. Thus by Corollary 5.3,

$$\min\{\chi(G), \chi(H)\} \leq \min\{\Delta(G), \Delta(H)\} + 1 \leq \eta(G \square H) - 1 .$$

Now assume that $G \neq K_2$ and $H \neq K_2$.

Case 1. $G \in \{C_n, K_n\}$ and $\eta(H) = 2$ for some $n \geq 3$: Then H is a tree and $\min\{\chi(G), \chi(H)\} = 2$. On the other hand, $\eta(G \square H) \geq \eta(K_3 \square K_2) = 4$ by Proposition 7.2.

Case 2. $G = K_n$ and $\eta(H) \geq 3$ for some $n \geq 3$: Then $\min\{\chi(G), \chi(H)\} \leq n$ and $\eta(G \square H) \geq \eta(K_n \square K_3) = n + 2$ by Proposition 7.3.

Case 3. $G = C_n$ and $\eta(H) \geq 3$ for some $n \geq 3$: Then $\min\{\chi(G), \chi(H)\} \leq 3$, and $\eta(G \square H) \geq \eta(C_3 \square C_3) = 5$ by a result of Archdeacon et al. [1]. (In fact, Archdeacon et al. [1] determined $\eta(C_n \square C_m)$ for all values of n and m , as described in Table 2. Miller [40] had previously stated without proof that $\eta(C_n \square K_2) = 4$ for all $n \geq 3$.)

Case 4. Both G and H are neither complete graphs nor cycles. Then by Brooks' Theorem [5], $\chi(G) \leq \Delta(G)$ and $\chi(H) \leq \Delta(H)$. Thus $\min\{\chi(G), \chi(H)\} \leq \min\{\Delta(G), \Delta(H)\}$. By Corollary 5.3, $\eta(G \square H) \geq \min\{\Delta(G), \Delta(H)\} + 2$. Thus $\min\{\chi(G), \chi(H)\} \leq \eta(G \square H) - 2$. \square

TABLE 2. The Hadwiger number of $C_n \square C_m$, where $C_2 = K_2$; see [1].

	$n = 2$	$n = 3$	$n = 4$	$n = 5$	$n \geq 6$
$m = 2$	3	4	4	4	4
$m = 3$	4	5	5	5	6
$m = 4$	4	5	6	6	7
$m = 5$	4	5	6	7	7
$m \geq 6$	4	6	7	7	7

Theorem 12.2. *Hadwiger's Conjecture holds for a non-trivial product $G \square H$ whenever $|\chi(G) - \chi(H)| \leq 2$. Moreover, if $|\chi(G) - \chi(H)| \leq 1$ then $\chi(G \square H) \leq \eta(G \square H) - 1$.*

Proof. Without loss of generality, $\chi(G) - 2 \leq \chi(H) \leq \chi(G)$. Thus, by Sabidussi's Theorem [48], it suffices to prove that $\chi(G) \leq \eta(G \square H)$. If $H = K_2$ then $\chi(G) \leq 4$ by assumption. Hadwiger [23] and Dirac [15] independently proved Hadwiger's Conjecture whenever $\chi(G) \leq 4$. Thus

$\eta(G \square H) \geq \eta(G) + 1 \geq \chi(G) + 1$, as desired. This proves the ‘moreover’ claim in this case. Now assume that $H \neq K_2$. Thus by Lemma 12.1, $\chi(G) \leq \chi(H) + 2 \leq \eta(G \square H)$, as desired. And if $\chi(G) \leq \chi(H) + 1$ then $\chi(G) \leq \eta(G \square H) - 1$, as desired. \square

The following two theorems establish Hadwiger’s Conjecture for new classes of products. The first says that products satisfy Hadwiger’s Conjecture whenever one graph has large treewidth relative to its chromatic number.

Theorem 12.3. *Hadwiger’s Conjecture is satisfied for the non-trivial product $G \square H$ whenever $\chi(G) \geq \chi(H)$ and G has treewidth $\text{tw}(G) \geq 2^{4\chi(G)^4}$.*

Proof. Since H has at least one edge, $\eta(G \square H) \geq \eta(G \square K_2)$. By Lemma 10.5, $\eta(G \square H) > (\frac{1}{4} \log \text{tw}(G))^{1/4}$, which is at least $\chi(G)$ by assumption. Hence $\eta(G \square H) > \chi(G) = \chi(G \square H)$ by Sabidussi’s Theorem [48]. That is, $G \square H$ satisfies Hadwiger’s Conjecture. \square

We now show that products satisfy (a slightly better bound than) Hadwiger’s Conjecture whenever the graph with smaller chromatic number is relatively large.

Theorem 12.4. *Let G and H be connected graphs with $\nu(H) - 1 \geq \chi(G) \geq \chi(H)$. Then*

$$\chi(G \square H) \leq \eta(G \square H) - 1 .$$

Proof. By Sabidussi’s Theorem [48] it suffices to prove that $\eta(G \square H) \geq \chi(G) + 1$.

Case 1. $G = K_n$ for some $n \geq 3$: Then by Proposition 7.2,

$$\eta(G \square H) \geq \eta(K_n \square K_2) = n + 1 = \chi(G) + 1 = \chi(G \square H) + 1 .$$

Case 2. $G = C_n$ for some $n \geq 3$: Then by Proposition 7.2,

$$\eta(G \square H) \geq \eta(K_3 \square K_2) = 4 \geq \chi(G) + 1 = \chi(G \square H) + 1 .$$

Case 3. G is neither a complete graph nor a cycle: Then by Brooks’ Theorem [5] and Corollary 5.3,

$$\begin{aligned} \eta(G \square H) &\geq \min\{\nu(H), \Delta(G) + 1\} \geq \min\{\nu(H), \chi(G) + 1\} \\ &= \chi(G) + 1 \\ &= \chi(G \square H) + 1 , \end{aligned}$$

as desired. \square

Note that Theorem 12.4 is best possible, since Theorem 10.1 implies that for $G = K_n$ and H any tree (no matter how big), $\chi(G \square H) = n = \eta(G \square H) - 1$.

Theorems 12.2 and 12.4 both prove (under certain assumptions) that $\chi(G \square H) \leq \eta(G \square H) - 1$, which is stronger than Hadwiger’s Conjecture for general graphs. This should not be a great surprise, since if Hadwiger’s

Conjecture holds for all graphs, then the same improved result holds for all non-trivial products $G \square H$ with $\chi(G) \geq \chi(H)$:

$$\chi(G \square H) = \chi(G) \leq \eta(G) \leq \eta(G \square K_2) - 1 \leq \eta(G \square H) - 1 .$$

Whether Hadwiger's Conjecture holds for all non-trivial products reduces to the following particular case.

Theorem 12.5. *Let G be a graph. Then Hadwiger's Conjecture holds for every non-trivial product $G \square H$ with $\chi(G) \geq \chi(H)$ if and only if Hadwiger's Conjecture holds for $G \square K_2$.*

Proof. The forward direction is immediate. Suppose that Hadwiger's Conjecture holds for $G \square K_2$; that is, $\chi(G \square K_2) \leq \eta(G \square K_2)$. Let H be a graph with at least one edge and $\chi(G) \geq \chi(H)$. Then $\chi(G \square H) = \chi(G) = \chi(G \square K_2)$ by Sabidussi's Theorem [48]. Since K_2 is a subgraph of H , $\eta(G \square H) \geq \eta(G \square K_2)$. In summary,

$$\chi(G \square H) = \chi(G) = \chi(G \square K_2) \leq \eta(G \square K_2) \leq \eta(G \square H) .$$

Hence Hadwiger's Conjecture holds for $G \square H$. □

Theorem 12.5 motivates studying $\eta(G \square K_2)$ in more detail. By (5), $\eta(G \square K_2)$ is tied to $\text{tw}(G)$, the treewidth of G . By a minimum-degree-greedy algorithm, $\chi(G) \leq \text{tw}(G) + 1$. Thus it is tempting to conjecture that the lower bound on $\eta(G \square K_2)$ from Lemma 10.5 can be strengthened to

$$(8) \quad \eta(G \square K_2) \geq \text{tw}(G) + 1 .$$

This would imply that for all graphs G and H both with at least one edge and $\chi(G) \geq \chi(H)$,

$$\chi(G \square H) = \chi(G) \leq \text{tw}(G) + 1 \leq \eta(G \square K_2) \leq \eta(G \square H) ;$$

that is, Hadwiger's Conjecture holds for every non-trivial product. However, (8) is false. Kloks and Bodlaender [37] proved that a random cubic graph on n vertices has $\text{tw}(G) \geq \Omega(n)$ but $\eta(G \square K_2) \leq \mathcal{O}(\sqrt{n})$ by Lemma 2.2.

We finish with some comments about Hadwiger's Conjecture for d -dimensional products. In what follows G_1, \dots, G_d are graphs, each with at least one edge, such that $\chi(G_1) \geq \dots \geq \chi(G_d)$. Thus $\chi(G_1 \square G_2 \square \dots \square G_d) = \chi(G_1)$ by Sabidussi's Theorem [48]. Observe that Theorem 12.5 generalises as follows: Hadwiger's Conjecture holds for all $G_1 \square G_2 \square \dots \square G_d$ if and only if it holds for $G_1 \square Q_{d-1}$. (Recall that Q_d is the d -dimensional hypercube.) Finally we show that if Hadwiger's Conjecture holds for all graphs, then a significantly stronger result holds for

d -dimensional products. By (4) and Theorem 7.1,

$$\begin{aligned} \eta(G_1 \square G_2 \square \cdots \square G_d) &\geq \eta(K_{\eta(G_1)} \square Q_{d-1}) \\ &\geq \eta(K_{\eta(G_1)} \square K_{2^{d/2}}) \\ &\geq (2^{d/4} - o(1)) \eta(G_1) \\ &\geq (2^{d/4} - o(1)) \chi(G_1) \\ &= (2^{d/4} - o(1)) \chi(G_1 \square G_2 \square \cdots \square G_d) . \end{aligned}$$

This shows that if Hadwiger's Conjecture holds for all graphs, then the multiplicative factor of 1 in Hadwiger's Conjecture can be improved to an exponential in d for d -dimensional products.

NOTE ADDED IN PROOF

Lemma 10.5 can be restated as: if $\text{tw}(G) \geq 2^{4\ell^4}$ then $\eta(G \square K_2) \geq \ell$. This exponential bound was recently improved by Reed and Wood [44] to the following polynomial bound: for some constant c , if $\text{tw}(G) \geq c\ell^4 \sqrt{\log \ell}$ then $\eta(G \square K_2) \geq \ell$. Subsequently, the bounds in (5), in Theorem 12.3, and in the proof of Lemma 11.6 can be improved.

REFERENCES

- [1] ARCHDEACON, DAN; BONNINGTON, C. PAUL; PEARSON, JOHN; ŠIRÁŇ, JOZEF. The Hadwiger number for the product of two cycles. In *Combinatorics, Complexity, & Logic* (1997) 113–120, Springer. MR: [1644821](#) (99e:05071), Zbl: [0913.05067](#).
- [2] BEHZAD, M.; MAHMOODIAN, S. E. On topological invariants of the product of graphs. *Canad. Math. Bull.* **12** (1969) 157–166. MR: [0244076](#) (39 #5393), Zbl: [0177.52402](#), doi: [10.4153/CMB-1969-015-9](#).
- [3] BODLAENDER, HANS L. A partial k -arboretum of graphs with bounded treewidth. *Theoret. Comput. Sci.* **209** (1998) 1–45. MR: [1647486](#) (99k:05146), Zbl: [0912.68148](#), doi: [10.1016/S0304-3975\(97\)00228-4](#).
- [4] BOLLOBÁS, BÉLA. *Modern graph theory*, Springer-Verlag (1998). MR: [MR1633290](#) (99h:05001), Zbl: [0902.05016](#).
- [5] BROOKS, R. L. On colouring the nodes of a network. *Proc. Cambridge Philos. Soc.* **37** (1941) 194–197. MR: [0012236](#) (6,281b), Zbl: [0027.26403](#), doi: [10.1017/S030500410002168X](#).
- [6] CHANDRAN, L. SUNIL; KOSTOCHKA, ALEXANDR; RAJU, J. KRISHNAM. Hadwiger number and the Cartesian product of graphs. *Graphs Combin.* **24** (2008) 291–301. MR: [2438860](#) (2009d:05232), Zbl: [1215.05169](#), doi: [10.1007/s00373-008-0795-7](#).
- [7] CHANDRAN, L. SUNIL; RAJU, J. KRISHNAM. Hadwiger number and the cartesian product operation on graphs. Technical Report IISc-CSA-TR-2005-5, Department of Computer Science & Automation, Indian Institute of Science, Bangalore, India (2005).

- [8] CHANDRAN, L. SUNIL; SIVADASAN, NAVEEN. On the Hadwiger number of hypercubes and its generalizations. In *Proceedings of GRACO2005, Electron. Notes Discrete Math.* **19** (2005) 155–161. MR: [2173782](#) (1203.05146), doi: [10.1016/j.endm.2005.05.022](#).
- [9] CHANDRAN, L. SUNIL; SIVADASAN, NAVEEN. On the Hadwiger’s conjecture for graph products. *Discrete Math.* **307** (2007) 266–273. MR: [2285197](#) (2007h:05147), Zbl: [1119.05041](#), doi: [10.1016/j.disc.2006.06.019](#).
- [10] CHANG, TONY YU; CLARK, W. EDWIN. The domination numbers of the $5 \times n$ and $6 \times n$ grid graphs. *J. Graph Theory* **17** (1993) 81–107. MR: [1201248](#) (94b:05103), Zbl: [0780.05030](#), doi: [10.1002/jgt.3190170110](#).
- [11] CHANG, TONY YU; CLARK, W. EDWIN; HARE, ELEANOR O. Domination numbers of complete grid graphs. I. *Ars Combin.* **38** (1994) 97–111. MR: [1310409](#) (96b:05129), Zbl: [0818.05038](#)
- [12] CHÉRIFI, RACHID; GRAVIER, SYLVAIN; ZIGHEM, ISMAÏL. Bounds on domination number of complete grid graphs. *Ars Combin.* **60** (2001) 307–311. MR: [1849454](#) (2002e:05100), Zbl: [1073.05556](#)
- [13] DIESTEL, REINHARD. *Graph theory*, Springer (2000). <http://diestel-graph-theory.com/index.html>.
- [14] DIESTEL, REINHARD; JENSEN, TOMMY R.; GORBUNOV, KONSTANTIN YU.; THOMASSEN, CARSTEN. Highly connected sets and the excluded grid theorem. *J. Combin. Theory Ser. B* **75** (1999) 61–73. MR: [1666948](#) (2000a:05066), Zbl: [0949.05075](#), doi: [10.1006/jctb.1998.1862](#).
- [15] DIRAC, GABRIEL A. A property of 4-chromatic graphs and some remarks on critical graphs. *J. London Math. Soc.* **27** (1952) 85–92. MR: [0045371](#) (13,572f), Zbl: [0046.41001](#), doi: [10.1112/jlms/s1-27.1.85](#).
- [16] DRIER, YOTAM; LINIAL, NATHAN. Minors in lifts of graphs. *Random Structures Algorithms* **29** (2006) 208–225. MR: [2245501](#) (2007e:05074), Zbl: [pre05122830](#), doi: [10.1002/rsa.20100](#).
- [17] EL-ZAHAR, MOHAMED H.; SHAHEEN, RAMY S. The domination number of $C_8 \times C_n$ and $C_9 \times C_n$. *J. Egyptian Math. Soc.* **7** (1999) 151–166. MR: [1722066](#) (2000m:05170).
- [18] EL-ZAHAR, MOHAMED H.; SHAHEEN, RAMY S. Bounds for the domination number of toroidal grid graphs. *J. Egyptian Math. Soc.* **10** (2002) 103–113. MR: [1966607](#) (2004a:05114), Zbl: [1045.05071](#).
- [19] GELLER, DENNIS; KRONK, HUDSON. Further results on the achromatic number. *Fund. Math.* **85** (1974) 285–290. MR: [0357198](#) (50 #9666), Zbl: [0287.05119](#).
- [20] GOLDBERG, FELIX. On the Colin de Verdière numbers of Cartesian graph products. *Linear Algebra Appl.* **431** (2009) 2285–2290. MR: [2563021](#) (2010m:05176), Zbl: [1175.05083](#), doi: [10.1016/j.laa.2008.11.014](#).

- [21] GRAVIER, SYLVAIN. Total domination number of grid graphs. *Discrete Appl. Math.* **121** (2002) 119–128. MR:[1907550](#) (2003c:05162), Zbl:[0995.05109](#), doi:[10.1016/S0166-218X\(01\)00297-9](#).
- [22] GUPTA, RAM PRAKASH. Bounds on the chromatic and achromatic numbers of complementary graphs. In *Proc. 3rd Waterloo Conf. on Combinatorics*, Recent Progress in Combinatorics (1969) 229–235, Academic Press. MR:[0256930](#) (41 #1585), Zbl:[0209.55004](#)
- [23] HADWIGER, HUGO. Über eine Klassifikation der Streckenkomplexe. *Vierteljschr. Naturforsch. Ges. Zürich* **88** (1943) 133–142. MR:[0012237](#) (6,281c), Zbl:[0061.41308](#)
- [24] HAMMACK, RICHARD; IMRICH, WILFRIED; KLAVŽAR, SANDI. *Handbook of Product Graphs*, CRC Press (2011). Zbl:[pre05906416](#)
- [25] HARTNELL, BERT L.; RALL, DOUGLAS F. Improving some bounds for dominating Cartesian products. *Discuss. Math. Graph Theory* **23** (2003) 261–272. MR:[2070156](#) (2005c:05153), Zbl:[1055.05115](#).
- [26] HARTNELL, BERT L.; RALL, DOUGLAS F. On dominating the Cartesian product of a graph and K_2 . *Discuss. Math. Graph Theory* **24** (2004) 389–402. MR:[2120063](#) (2005k:05179), Zbl:[1063.05107](#).
- [27] HAYNES, TERESA W.; HEDETNIEMI, STEPHEN T.; SLATER, PETER J. *Fundamentals of domination in graphs*, Marcel Dekker (1998). MR:[MR1605684](#) (2001a:05112), Zbl:[0890.05002](#).
- [28] HEDETNIEMI, STEPHEN T.; LASKAR, RENU. Connected domination in graphs. In *Graph theory and combinatorics* (1984) 209–217, Academic Press. MR:[0777177](#) (86e:05055), Zbl:[0548.05055](#).
- [29] HELL, PAVOL; MILLER, DONALD J. Graph with given achromatic number. *Discrete Math.* **16** (1976) 195–207. MR:[0441778](#) (56 #173), Zbl:[0345.05113](#), doi:[10.1016/0012-365X\(76\)90099-6](#).
- [30] IMRICH, WILFRIED; KLAVŽAR, SANDI. *Product graphs: Structure and recognition*, Wiley (2000). MR:[MR1788124](#) (2001k:05001), Zbl:[0963.05002](#).
- [31] IMRICH, WILFRIED; KLAVŽAR, SANDI; RALL, DOUGLAS F. *Topics in graph theory: Graphs and their Cartesian product*. A K Peters (2008). MR:[MR2468851](#) (2010g:05002), Zbl:[1156.05001](#).
- [32] IVANČO, JAROSLAV. Some results on the Hadwiger numbers of graphs. *Math. Slovaca* **38** (1988) 221–226. MR:[0977899](#) (90g:05141) Zbl:[0658.05038](#).
- [33] JACOBSON, MICHAEL S.; KINCH, LAEL F. On the domination number of products of graphs. I. *Ars Combin.* **18** (1984) 33–44. MR:[0823829](#) (87a:05087), Zbl:[0566.05050](#).
- [34] JACOBSON, MICHAEL S.; KINCH, LAEL F. On the domination of the products of graphs. II. Trees. *J. Graph Theory* **10** (1986) 97–106. Zbl:[0584.05053](#), MR:[0830061](#) (87e:05056), doi:[10.1002/jgt.3190100112](#).
- [35] JORET, GWENAËL; WOOD, DAVID R. Complete graph minors and the graph minor structure theorem (2011), arXiv:[1105.3549](#).

- [36] KAWARABAYASHI, KEN-ICHI; MOHAR, BOJAN. Some recent progress and applications in graph minor theory. *Graphs Combin.* **23** (2007) 1–46. MR: [2292102](#) (2007k:05203), Zbl: [1114.05096](#), doi: [10.1007/s00373-006-0684-x](#).
- [37] KLOKS, TON; BODLAENDER, HANS. Only few graphs have bounded treewidth. Technical Report RRR-CS-92-35, Utrecht University, Netherlands (1992). <http://www.cs.uu.nl/research/techreps/repo/CS-1992/1992-35.pdf>.
- [38] KOTLOV, ANDREĬ. Minors and strong products. *European J. Combin.* **22** (2001) 511–512. MR: [1829745](#) (2002a:05222), Zbl: [1003.05094](#), doi: [10.1006/eujc.2000.0428](#).
- [39] MACGILLIVRAY, GARY; RODRIGUEZ, A. The achromatic number of the union of paths. *Discrete Math.* **231** (2001) 331–335. MR: [1821972](#) (2002a:05106), Zbl: [0979.05041](#), doi: [10.1016/S0012-365X\(00\)00330-7](#).
- [40] MILLER, ZEVI. Contractions of graphs: a theorem of Ore and an extremal problem. *Discrete Math.* **21** (1978) 261–272. MR: [0522900](#) (80a:05169), Zbl: [0378.05043](#), doi: [10.1016/0012-365X\(78\)90158-9](#).
- [41] MOHAR, BOJAN; THOMASSEN, CARSTEN. *Graphs on surfaces*. Johns Hopkins University Press, Baltimore, U.S.A. (2001).
- [42] ORE, OYSTEIN. *Theory of graphs*. American Mathematical Society Colloquium Publications, Vol. XXXVIII (1962). MR: [0150753](#) (27 #740), Zbl: [0105.35401](#).
- [43] RAJU, KRISHNAM. *Hadwiger Number and the Cartesian Product Operation on Graphs*. Master’s thesis, Department of Computer Science & Automation, Indian Institute of Science, Bangalore, India (2006).
- [44] REED, BRUCE; WOOD, DAVID R. Polynomial treewidth forces a large grid-like-minor. *European J. Combin.* (to appear), arXiv: [0809.0724](#).
- [45] ROBERTSON, NEIL; SEYMOUR, PAUL D. Graph minors. V. Excluding a planar graph. *J. Combin. Theory Ser. B* **41** (1986) 92–114. MR: [0854606](#) (89m:05070), Zbl: [0598.05055](#), doi: [10.1016/0095-8956\(86\)90030-4](#).
- [46] ROBERTSON, NEIL; SEYMOUR, PAUL D. Graph minors. XVI. Excluding a non-planar graph. *J. Combin. Theory Ser. B* **89** (2003) 43–76. MR: [1999736](#) (2004f:05168), Zbl: [1023.05040](#), doi: [10.1016/S0095-8956\(03\)00042-X](#).
- [47] ROBERTSON, NEIL; SEYMOUR, PAUL D. Graph minors. XX. Wagner’s conjecture. *J. Combin. Theory Ser. B* **92** (2004) 325–357. MR: [2099147](#) (2005m:05204), Zbl: [1061.05088](#), doi: [10.1016/j.jctb.2004.08.001](#).
- [48] SABIDUSSI, GERT. Graphs with given group and given graph-theoretical properties. *Canad. J. Math.* **9** (1957) 515–525. MR: [0094810](#) (20 #1322), Zbl: [0079.39202](#), doi: [10.4153/CJM-1957-060-7](#).
- [49] SAMPATHKUMAR, E.; WALIKAR, H. B. The connected domination number of a graph. *J. Math. Phys. Sci.* **13** (1979) 607–613. Zbl: [0449.05057](#), MR: [0575817](#) (81g:05077).

- [50] SEESE, DETLEF G.; WESSEL, WALTER. Grids and their minors. *J. Combin. Theory Ser. B* **47** (1989) 349–360. MR: [1026069](#) (90j:05127), Zbl: [0636.05023](#), doi: [10.1016/0095-8956\(89\)90033-6](#).
- [51] SHAHEEN, RAMY S. On the domination number of the $m \times n$ toroidal grid graph. *Congr. Numer.* **146** (2000) 187–200. MR: [1817979](#) (2001m:05198) Zbl: [0976.05045](#).
- [52] SITTON, DAVID. Maximum matchings in complete multipartite graphs. *Furman University Electronic J. Undergraduate Math.* **2** (1996) 6–16.
- [53] ŠPACAPAN, SIMON. Connectivity of Cartesian products of graphs. *Appl. Math. Lett.* **21** (2008) 682–685. MR: [2423045](#) (2009d:05138), Zbl: [1152.05340](#), doi: [10.1016/j.aml.2007.06.010](#).
- [54] STIEBITZ, MICHAEL. On Hadwiger’s number—a problem of the Nordhaus-Gaddum type. *Discrete Math.* **101** (1992) 307–317. MR: [1172386](#) (93j:05048), Zbl: [0774.05096](#), doi: [10.1016/0012-365X\(92\)90611-I](#).
- [55] TOFT, BJARNE. A survey of Hadwiger’s conjecture. *Congr. Numer.* **115** (1996) 249–283. MR: [1411244](#) (97i:05048), Zbl: [0895.05025](#).
- [56] VAN WIEREN, DOUGLAS M. Critical cyclic patterns related to the domination number of the torus. *Discrete Math.* **307** (2007) 615–632. MR: [2287500](#) (2007i:05144), Zbl: [1119.05084](#), doi: [10.1016/j.disc.2005.09.047](#).
- [57] WOOD, DAVID R. On the maximum number of cliques in a graph. *Graphs Combin.* **23** (2007) 337–352. MR: [2320588](#) (2008d:05084), Zbl: [1122.05048](#), doi: [10.1007/s00373-007-0738-8](#).
- [58] WU, ZEFANG; YANG, XU; YU, QINGLIN. A note on graph minors and strong products. *Appl. Math. Lett.* **23** (2010) 1179–1182. MR: [2665591](#) (2011h:05247), Zbl: [1193.05150](#), doi: [10.1016/j.aml.2010.05.007](#).
- [59] XU, JUN-MING; YANG, CHAO. Connectivity of Cartesian product graphs. *Discrete Math.* **306** (2006) 159–165. MR: [2202083](#) (2007a:05076), Zbl: [1085.05042](#), doi: [10.1016/j.disc.2005.11.010](#).
- [60] YEGNANARAYANAN, V. The pseudoachromatic number of a graph. *Southeast Asian Bull. Math.* **24** (2000) 129–136. MR: [1811221](#) (2001k:05085), Zbl: [0959.05043](#).
- [61] ZELINKA, BOHDAN. Hadwiger numbers of finite graphs. *Math. Slovaca* **26** (1976) 23–30. MR: [0427145](#) (55 #181), Zbl: [0324.05120](#).

DEPARTMENT OF MATHEMATICS AND STATISTICS
 THE UNIVERSITY OF MELBOURNE
 MELBOURNE, AUSTRALIA

E-mail address: woodd@unimelb.edu.au