

The hook fusion procedure and its generalisations.

James Grime

A Thesis Submitted for the Degree of PhD.

Department of Mathematics

University of York

Heslington

York YO10 5DD

July 2007

Abstract

The fusion procedure provides a way to construct new solutions to the Yang-Baxter equation. In the case of the symmetric group the fusion procedure has been used to construct diagonal matrix elements using a decomposition of the Young diagram into its rows or columns. We present a new construction which decomposes the diagram into hooks, the great advantage of this is that it minimises the number of auxiliary parameters needed in the procedure. We go on to use the hook fusion procedure to find diagonal matrix elements computationally and calculate supporting evidence to a previous conjecture.

We are motivated by the construction of certain elements that allow us to generate representations of the symmetric group and single out particular irreducible components. In this way we may construct higher representations of the symmetric group from elementary ones. We go some way to generalising the hook fusion procedure by considering other decompositions of Young diagrams, specifically into ribbons. Finally, we adapt our construction to the quantum deformation of the symmetric group algebra known as the Hecke algebra.

Contents

1	Introduction	7
2	Background	10
2.1	The Yang-Baxter equation	10
2.2	Young symmetrizers	14
2.3	The fusion procedure for the symmetric group	17
2.4	Constructing representations	26
3	The hook fusion procedure	30
3.1	Proof of the hook fusion procedure	33
4	Representations of degenerate affine Hecke algebras	51
4.1	The mixed hook length formula	51
4.2	Non mixed hook calculations	56
5	The ribbon fusion procedure	61
5.1	Ribbon Schur functions	61
5.2	Towards a ribbon fusion procedure	64
6	The hook fusion procedure for Hecke algebras	82
6.1	Hecke algebras and affine Hecke algebras	82
6.2	The hook fusion procedure for Hecke algebras	85
6.3	Generating irreducible representations of H_n	102

A Appendix A	110
B Appendix B	122
References	132

Acknowledgments

There are many people I wish to thank. First of all I would like to thank everyone in the department of mathematics at the University of York, especially Stephen Donkin, Niall MacKay and my supervisor Maxim Nazarov for all their help and guidance. Also I would like to give special thanks to the PhD students of the department for all their friendship and support. I thank EPSRC for funding my research, and all those of the GAP support mailing list, especially Alexander Konovalov and Alexander Hulpke, for their help and their amazing patience.

And finally, but most of all, I'd like to thank my parents, Rob and Liz Grime, without whose advice, love and support this would not have been possible.

Moriarty: How are you at Mathematics?

Seagoon: I speak it like a native.

Declaration

I, James Grime, confirm that the work presented in this thesis is my own. Where information has been derived from other sources, I confirm that this has been indicated in the thesis.

1 Introduction

There has been much interest in the Yang-Baxter equation since it first appeared in the works of McGuire in 1964 and Yang in 1967, [MG], [Ya]. They considered a quantum mechanical many body problem and found the scattering matrix factorised to that of the two body problem. Here the Yang-Baxter equation arises as the consistency condition for the factorisation. It has since continued to appear in many disparate branches of mathematics including solvable lattice models, soliton theory and quantum integrable models, and quantum groups. Therefore there has been much study into the Yang-Baxter equation and the construction of solutions.

In this thesis we present the construction of certain solutions in the symmetric group algebra and deformations of this algebra. We use a method of construction known as ‘the fusion procedure’ which requires introducing a number of spectral parameters before taking a certain product of operators. The result is an operator which can be used to generate a representation of the symmetric group algebra. This representation decomposes into irreducible representations, and for certain values of the spectral parameters, the fusion procedure gives us a way to single out one of these components.

We present a new fusion procedure which minimises the number of auxiliary parameters necessary in the procedure. We will call this new fusion procedure the ‘hook fusion procedure’ and go on to use it to construct elements of the symmetric group computationally, and thus provide supporting evidence to a previous conjecture. We will also generalise our results in two ways. We will construct a hook fusion procedure for Hecke algebras, which is a deformation of the symmetric group algebra, and we will go some way to generalising the fusion procedure beyond our hook version, which we will call the ‘ribbon fusion procedure’.

In chapter 2 we give some of the background to the problem, this includes a description and formulation of the Yang-Baxter equation itself, and its variant known as the classical Yang-Baxter equation. We state several well known

definitions relating to the representation theory of the symmetric group, including the definition of a Young diagram and its Young symmetrizer. The Young symmetrizers are primitive idempotents so may be used to form simple left ideals. We then go on to describe diagonal matrix elements, related to the Young symmetrizers by a certain multiplication of invertible elements, and so may use these elements to generate irreducible representations. We also give a description of the fusion procedure for constructing solutions to the Yang-Baxter equation, first in a general setting and then specifically for the symmetric group algebra due to Cherednik [C1] and Nazarov [N3]. We show how the fusion procedure may be used to construct the diagonal matrix elements in the symmetric group.

In Chapter 3 we present one of our main results, which appears in the author's first paper [Gr1]. Up to now the fusion procedure for the symmetric group required a Young diagram to be decomposed into either its rows or its columns. We consider a different decomposition of the Young diagram, namely we decompose the diagram into its 'principal hooks'. Not only does this reduce the number of auxiliary parameters needed in the fusion procedure, but it actually minimises the number. This will prove to be useful in later computational calculations. We introduce an element $F_\Lambda(z_1, \dots, z_n)$ whose coefficients are rational polynomials in the parameters z_1, \dots, z_n , which may contain a singularity on the line $z_1 = \dots = z_n$. After restriction to a certain subspace we will prove the function $F_\Lambda(z_1, \dots, z_n)$ is regular on the line, with any singularities being removable. By showing certain divisibilities we will prove that the value of this function on the line coincides with the diagonal matrix element. We call Theorem 3.4 of Chapter 3 the hook fusion procedure. We are motivated by the construction of certain induced representations and their decomposition into irreducible representations.

We use our main result of Chapter 3 in Chapter 4 to calculate diagonal matrix elements using the hook fusion procedure. Since the hook fusion procedure minimises the number of necessary spectral parameters we may use it to cal-

culate the diagonal matrix elements computationally. We are motivated by the irreducibility criterion of representations of degenerate affine Hecke algebras, which we define. It has been conjectured that this criterion can be defined solely in terms of certain eigenvalues. We provide supporting evidence that this is the case. We also go on to calculate more eigenvalues of a type not previously calculated. It is interesting to note that these eigenvalues all have integral roots.

In Chapter 5 we propose a possible ribbon fusion procedure which may be considered a generalisation of the hook fusion procedure and those procedures that relied on the decomposition of a Young diagram into its rows or columns. In this chapter we present many new ideas, including a new combinatorial construction of ribbons from 2×2 squares, and a new approach to proving such a ribbon fusion procedure based on chains of diagrams that resolve singularities of $F_\Lambda(z_1, \dots, z_n)$ using a common ordering. We also provide evidence supporting the opposite implication, that if the decomposition of the Young diagram is not as prescribed then the singularities of $F_\Lambda(z_1, \dots, z_n)$ are not removable and are in fact poles. We also mention Schur functions, $s_\lambda(\mathbf{x})$, and how the decomposition of Young diagrams into row, columns, hooks and ribbons can give determinantal expressions for $s_\lambda(\mathbf{x})$.

Finally, in Chapter 6 we adapt the hook fusion procedure of Chapter 3 to find representations of Hecke algebras, denoted H_n . The Hecke algebra may be viewed as a deformation of the symmetric group algebra, and like the symmetric group algebra, other fusion procedures for Hecke algebras have already been considered. However, the hook fusion procedure again minimises the now multiplicative spectral parameters. As an adaptation the proof both built upon the ideas developed in Chapter 3 while in detail contains several necessary changes. We finish by describing how the element defined in the limit of this procedure generates irreducible representations of H_n . We also touch on how this relates to the affine Hecke algebra and is the subject of the author's second paper [Gr2].

2 Background

2.1 The Yang-Baxter equation

We may view the Yang-Baxter equation as a relation involving operators of a certain vector space. This property turns out to be an important condition arising in several areas of mathematics, including solvable lattice models, quantum theory and conformal field theory.

The Yang-Baxter equation first appeared in 1964 in the study of the quantum mechanical many body problem, [MG], [Ya]. McGuire and Yang found the scattering matrix factorised to that of the two body problem, see [C4]. The consistency condition of that factorisation manifests itself as the Yang-Baxter equation.

The term ‘Yang-Baxter equation’ was given by Faddeev, Sklyanin and Takhtajan in their papers of 1978-79 which describe the quantum inverse method. This work was a unification of the classical integrable models, known as soliton theory, and the quantum integrable models. Here the commutation relation between operators is described by a solution of the Yang-Baxter equation, [FST1], [FST2]. These works led to the idea of quantum groups as certain deformations of groups, or Lie algebras, and consequently the study of Yang-Baxter equation as a type of braid relation, [FRT], [Sk], [D1], [D3], [Ji1].

Let V be a complex vector space, and $R(u)$ a function of $u \in \mathbb{C}$ taking values in $\text{End}_{\mathbb{C}}(V \otimes V)$. Furthermore, let R_{ij} denote the operator on $V^{\otimes 3}$, acting as $R(u)$ on the i -th and j -th components and as the identity on the other component, for example $R_{23}(u) = I \otimes R(u)$. Then we call the following equation for $R(u)$ the *Yang-Baxter equation*:

$$R_{12}(u)R_{13}(u+v)R_{23}(v) = R_{23}(v)R_{13}(u+v)R_{12}(u). \quad (1)$$

The variable u is called the spectral parameter. In most cases we assume that $N = \dim V < \infty$, hence a solution of (1) is often referred to as an R matrix. For example, a typical solution of (1) in the case $V = \mathbb{C}^2$ might be

$$R(u) = \begin{bmatrix} 1+u & 0 & 0 & 0 \\ 0 & u & 1 & 0 \\ 0 & 1 & u & 0 \\ 0 & 0 & 0 & 1+u \end{bmatrix} = P + uI,$$

where $P \in \text{End}_{\mathbb{C}}(V \otimes V)$ denotes the transposition $P(x \otimes y) = y \otimes x$.

We may extend the idea to matrices acting on $V^{\otimes n}$, $n \geq 2$, by defining $R_{ij}(u)$ as acting as $R(u)$ on the i -th and j -th components, such that

$$R_{ij}(u)R_{ik}(u+v)R_{jk}(v) = R_{jk}(v)R_{ik}(u+v)R_{ij}(u),$$

then for pairwise distinct indices

$$R_{ij}(u)R_{kl}(v) = R_{kl}(v)R_{ij}(u).$$

Further, one may consider the Yang-Baxter equation for a function of two variables $R(u, u')$:

$$R_{12}(u_1, u_2)R_{13}(u_1, u_3)R_{23}(u_2, u_3) = R_{23}(u_2, u_3)R_{13}(u_1, u_3)R_{12}(u_1, u_2). \quad (2)$$

Equation (1) is a special case of (2) where the (u, u') -dependence enters only through the difference

$$R(u, u') \equiv R(u - u').$$

We could rewrite the Yang-Baxter equation in terms of the matrix $\check{R}(u) = PR(u)$. Let $n \geq 2$, and define matrices on $V^{\otimes n}$ by $\check{R}_i(u) = I \otimes \cdots \otimes \check{R}(u) \otimes \cdots \otimes I$, where $\check{R}(u)$ is in the $(i, i+1)$ -th slot, $i = 1, \dots, n-1$. One then has

$$\check{R}_i(u)\check{R}_j(v) = \check{R}_j(v)\check{R}_i(u) \quad \text{if } |i-j| > 1,$$

$$\check{R}_{i+1}(u)\check{R}_i(u+v)\check{R}_{i+1}(v) = \check{R}_i(v)\check{R}_{i+1}(u+v)\check{R}_i(u).$$

Notice that, without the spectral parameters u, v , these relations are simply Artin's braid relations. For an introduction to the Yang-Baxter equation see [Ji2].

2.1.1 The classical Yang-Baxter equation

If solution of the Yang-Baxter equation contains an extra parameter \hbar such that as $\hbar \rightarrow 0$ it has the expansion

$$R(u, \hbar) = (\text{scalar}) \times (I + \hbar r(u) + O(\hbar^2)),$$

then we call $R(u, \hbar)$ quasi-classical, and $r(u) \in \text{End}_{\mathbb{C}}(V \otimes V)$ the classical limit of $R(u, \hbar)$. For quasi-classical R -matrices, the Yang-Baxter equation (1) implies the following *classical Yang-Baxter equation* for $r(u)$ ([BD], [KS]):

$$[r_{12}(u), r_{13}(u+v)] + [r_{12}(u), r_{23}(v)] + [r_{13}(u+v), r_{23}(v)] = 0. \quad (3)$$

Not all solutions of the Yang-Baxter equation are quasi-classical. However, quasi-classical solutions are a significant subset. In particular, one can see that the classical Yang-Baxter equation is formulated using only the Lie algebra structure of $\text{End}(V)$. We continue by giving some important results for the classical case.

Let \mathfrak{g} be a Lie algebra, and let $r(u)$ be a $\mathfrak{g} \otimes \mathfrak{g}$ -valued function. In terms of a basis $\{X_\mu\}$ of \mathfrak{g} , write

$$r(u) = \sum_{\mu, \nu} r^{\mu\nu}(u) X_\mu \otimes X_\nu$$

with \mathbb{C} -valued functions $r^{\mu\nu}(u)$. Further, let $r_{12}(u) = \sum r^{\mu\nu}(u) X_\mu \otimes X_\nu \otimes I \in (U\mathfrak{g})^{\otimes 3}$ and so on, where $U\mathfrak{g}$ denotes the universal enveloping algebra. One then has

$$[r_{12}(u), r_{23}(v)] = \sum r^{\mu\nu}(u) r^{\sigma\rho}(v) X_\mu \otimes [X_\nu, X_\rho] \otimes X_\sigma, \text{ etc}$$

so that each term in (3) actually lies inside $\mathfrak{g}^{\otimes 3}$. For each triplet of representations $(\pi_i, V_i), i = 1, 2, 3$ of \mathfrak{g} , $(\pi_i \otimes \pi_j)(r_{ij}(u))$ gives a matrix solution of the classical Yang-Baxter equation in $V_1 \otimes V_2 \otimes V_3$.

We say $r(u)$ is *regular* on a subset of the complex plane if it is a holomorphic function everywhere except on a set of isolated points, which are poles for the function, and call $r(u)$ *non-degenerate* if $\det(r^{\mu\nu}(u)) \neq 0$. Then we have the following result.

Theorem 2.1 (Belavin-Drinfeld) *If \mathfrak{g} is a finite dimensional complex simple Lie algebra, $\{X_\mu\}$ an orthonormal basis of \mathfrak{g} , and $r(u)$ is a regular, non-degenerate $\mathfrak{g} \otimes \mathfrak{g}$ -valued solution of (3) defined in a neighbourhood of $0 \in \mathbb{C}$, then*

(i) *$r(u)$ extends regularly to the whole complex plane \mathbb{C} , with all its poles being simple.*

(ii) *$\Gamma =$ the set of poles of $r(u)$ is a discrete subgroup relative to the addition of \mathbb{C} .*

(iii) *As a function of u there are the following possibilities for the $r^{\mu\nu}(u)$:*

rank $\Gamma = 2$: elliptic function;

rank $\Gamma = 1$: trigonometric function (i.e. a rational function in the variable $e^{\text{const. } u}$);

rank $\Gamma = 0$: rational function.

Belavin-Drinfeld further show that elliptic solutions exist only for $\mathfrak{g} = \mathfrak{sl}(n)$, in which case it is unique up to a certain equivalence of solutions. They also show that trigonometric solutions exist for each type, and can be classified using the Dynkin diagram for affine Lie algebras. Although we will not use the Yang-Baxter equation in this form ourselves, these remain an important class of solutions.

2.1.2 The fusion procedure

There are a few approaches to constructing R matrices. For instance, for finite dimensional matrix solutions one may solve a system of linear equations that uniquely determine $R(u)$, up to a scalar factor. Here we describe another method known as the *fusion procedure* developed by Kulish, Reshetikhin and Sklyanin, [KRS]. This method relates to that of a standard technique to get irreducible representations of Lie algebras, in which we form a tensor product of fundamental representations and decompose it.

We will describe the procedure in a more general setting than the ones we have so far considered. We begin by considering instead a family of vector spaces $\mathcal{F} = \{V_i\}$ and operators $\{R_{V_i V_j}(u) \in \text{End}_{\mathbb{C}}(V_i \otimes V_j) : V_i, V_j \in \mathcal{F}\}$. The Yang-Baxter equation (1) is then an equation in $\text{End}_{\mathbb{C}}(V_1 \otimes V_2 \otimes V_3)$, where $R_{ij}(u) = R_{V_i V_j}(u)$.

Fix u_1, u_2 and set

$$W = R_{V_1 V_2}(u_2 - u_1)(V_1 \otimes V_2) \subseteq V_1 \otimes V_2,$$

and define

$$R_{V_2 \otimes V_1, V_3}(u) = R_{V_2 V_3}(u + u_1)R_{V_1 V_3}(u + u_2).$$

Then using the Yang-Baxter equation (1) one finds

$$\begin{aligned} R_{V_2 \otimes V_1, V_3}(u)(W \otimes V_3) &= R_{V_2 V_3}(u + u_1)R_{V_1 V_3}(u + u_2)R_{V_1 V_2}(u_2 - u_1)(V_1 \otimes V_2 \otimes V_3) \\ &= R_{V_1 V_2}(u_2 - u_1)R_{V_1 V_3}(u + u_2)R_{V_2 V_3}(u + u_1)(V_1 \otimes V_2 \otimes V_3) \\ &\subseteq W \otimes V_3. \end{aligned}$$

And so, with appropriate choices of u_1 and u_2 , W becomes a proper, non-trivial, subspace giving new R matrices

$$R_{W V_3}(u) = R_{V_2 \otimes V_1, V_3}(u)|_{W \otimes V_3},$$

and similarly

$$R_{V_3 \otimes W}(u) = R_{V_3, V_2 \otimes V_1}(u)|_{V_3 \otimes W}.$$

2.2 Young symmetrizers

Soon we will apply the fusion procedure to representations of the symmetric group, but first we give some well known classical results.

Let K be a field, and e_1, e_2, \dots, e_k the set of orthogonal idempotents in a K -algebra \mathcal{A} , in other words we have $e_i^2 = e_i$ and $e_i e_j = 0 = e_j e_i$ for all

$1 \leq i \neq j \leq k$. Any idempotent e in \mathcal{A} is *primitive* (or minimal) if e cannot be written as a sum of two non-zero orthogonal idempotents. The importance of primitive idempotents derives from the following proposition.

Proposition 2.2 *Let $e \in \mathcal{A}$ be an idempotent element, then e is primitive if and only if the left ideal $\mathcal{A} \cdot e$ is indecomposable.*

From now on we will work exclusively in the field $K = \mathbb{C}$. No direct construction of the element e is known for a general \mathcal{A} , but if \mathcal{A} is the symmetric group algebra $\mathbb{C}S_n$ there exists the following construction due to Alfred Young, where the left ideals are not only indecomposable but also irreducible, [Yo1].

A partition $\lambda = (\lambda_1, \lambda_2, \dots, \lambda_k)$ of a positive integer n is a sequence of weakly decreasing integers whose sum is equal to n . This may be represented by its *Young diagram* which consists of k rows with λ_i boxes in the i^{th} row, and with each row being left justified. The coordinates of the boxes in such a diagram are labeled using matrix notation, that is to say we let the first coordinate i increase as one goes downwards, and the second coordinate j increase from left to right. For example the partition $\lambda = (3, 3, 2)$ is a partition of 8 and gives the diagram

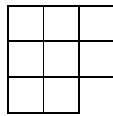

Let us identify a partition λ with its corresponding diagram. If $\lambda_1, \lambda_2, \dots, \lambda_k$ are the row lengths of λ then we denote its columns by $\lambda'_1, \lambda'_2, \dots, \lambda'_l$. The conjugate of a diagram λ is then a reflection in the main diagonal and is denoted $\lambda' = (\lambda'_1, \lambda'_2, \dots, \lambda'_l)$. Furthermore, if two diagrams correspond to partitions $\lambda = (\lambda_1, \dots, \lambda_k)$ and $\mu = (\mu_1, \dots, \mu_l)$, we write $\mu \subset \lambda$ if $\mu_i \leq \lambda_i$ for all i , and say ' λ contains μ '. A skew diagram is obtained by removing a Young diagram from one that contains it. The resulting skew shape is denoted λ/μ . For example, if $\lambda = (4, 3, 3, 1)$ and $\mu = (2, 1)$, we get the following skew diagram:

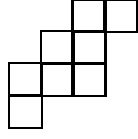

Any way of putting a positive integer in each box of the Young diagram is called a *filling*. A *semistandard tableau*, is a filling of a Young diagram λ that is both weakly increasing across each row and strictly increasing down each column. A *standard tableau* Λ of shape λ is a semistandard tableau of shape λ in which the entries are the numbers 1 to n , each occurring once. For example

1	4	7
2	5	8
3	6	

is a standard tableau of shape $(3, 3, 2)$. In this thesis we are only interested in standard tableaux and so may refer to one simply as a tableau. We will always denote tableau of a diagram using the corresponding capital Greek letter.

Since a permutation $\sigma \in S_n$ act on a tableau Λ by permutation of its entries, the row group of Λ , $R(\Lambda)$, is the set of all permutations in the symmetric group S_n that preserve the rows of Λ . For example, if Λ is as above then $(1\ 4\ 7)(2\ 8) \in R(\Lambda)$. The group $R(\Lambda)$ is a subgroup of S_n isomorphic to $S_{\lambda_1} \times S_{\lambda_2} \times \cdots \times S_{\lambda_k}$. Similarly we have the column group of Λ , $C(\Lambda)$, as the set of all permutations that preserve the columns of Λ .

We denote sign homomorphism by sgn and define it to be the homomorphism from the symmetric group S_n to the multiplicative group $\{1, -1\}$ such that $\text{sgn}t = -1$, for any transposition $t \in S_n$. We now define two elements of $\mathbb{C}S_n$

$$P_\Lambda = \sum_{p \in R(\Lambda)} p \quad \text{and} \quad Q_\Lambda = \sum_{q \in C(\Lambda)} (\text{sgn}q) \cdot q.$$

Then $Y_\Lambda = P_\Lambda Q_\Lambda$ is the *Young symmetrizer* of Λ . The element Y_Λ is a scalar multiple of a primitive idempotent, in particular

$$Y_\Lambda^2 = \alpha_\Lambda \cdot Y_\Lambda, \tag{4}$$

for some rational number $\alpha_\Lambda \in \mathbb{Q}$. Consequently we have the following theorem, [Yo1].

Theorem 2.3 (Young) *For any standard tableau Λ of shape λ , the ideal $\mathbb{C}S_n \cdot Y_\Lambda$ of $\mathbb{C}S_n$ is an irreducible left regular $\mathbb{C}S_n$ -module, denoted V_Λ . Two modules, V_Λ and $V_{\Lambda'}$ obtained from tableaux Λ and Λ' in this way are isomorphic if and only if Λ and Λ' are of the same shape. Furthermore, by choosing one standard tableau for each partition we obtain a full set of irreducible left $\mathbb{C}S_n$ -modules.*

Therefore irreducible representations of the group algebra $\mathbb{C}S_n$ are parameterized by partitions of n . We will use V_λ to denote V_Λ if Λ is an unspecified standard tableau of shape λ . The coefficient α_Λ in (4) is equal to $\frac{n!}{\dim V_\lambda}$.

In the following example, for any two distinct numbers $1 \leq p < q \leq n$, we denote the transposition of p and q by $(pq) \in S_n$.

Example 2.4. The partitions of $n = 3$ are

$$\lambda = \begin{array}{|c|c|c|} \hline \square & \square & \square \\ \hline \end{array}, \quad \mu = \begin{array}{|c|} \hline \square \\ \square \\ \square \\ \hline \end{array} \quad \text{and} \quad \nu = \begin{array}{|c|c|} \hline \square & \square \\ \square & \\ \hline \end{array}.$$

If $N = \begin{array}{|c|c|} \hline 1 & 3 \\ \hline 2 & \\ \hline \end{array}$ then

$$\begin{aligned} Y_N &= (1 + (1 \ 3))(1 - (1 \ 2)) \\ &= 1 + (1 \ 3) - (1 \ 2) - (1 \ 2 \ 3). \end{aligned}$$

And $\mathbb{C}S_3 \cdot Y_N$ has basis $Y_N, (1 \ 2)Y_N$, and is a 2-dimensional irreducible $\mathbb{C}S_3$ -module. ■

2.3 The fusion procedure for the symmetric group

The symmetric group S_n acts on $V^{\otimes n}$ by permuting its components.

Let

$$\{1\} = S_0 \subset S_1 \subset S_2 \subset \dots$$

be a chain of symmetric groups with the standard embedding. Let V_μ be an irreducible S_{n-1} -module, V_λ an irreducible S_n -module and k the multiplicity

of V_μ in the restriction of V_λ to the group S_{n-1} . For symmetric groups we always have $k \in \{0, 1\}$. By induction we obtain a decomposition of a module in V_λ into irreducible S_0 -modules. These are simply 1-dimensional subspaces indexed by all standard tableaux Λ of shape λ , thus we have the decomposition

$$V_\lambda \cong \bigoplus_{\Lambda} \mathbb{C}v_\Lambda.$$

Fix an S_n -invariant inner product $(\ , \)$ such that $(v_\Lambda, v_\Lambda) = 1$ for every Λ . The vectors v_Λ are pairwise orthogonal and are known as the *Young basis* of V_λ , [Yo2].

In the algebra of $n \times n$ matrices $\text{Mat}_n(\mathbb{C})$, let E_{ij} denote the elementary matrix whose $(i, j)^{\text{th}}$ entry is 1 with zeros elsewhere. The elementary matrices have the following properties

$$E_{ij}E_{kl} = \delta_{jk}E_{il}, \quad \text{and}$$

$$E_{11} + E_{22} + \cdots + E_{nn} = I_n,$$

where δ_{jk} is the Kronecker delta product and I_n is the identity matrix. Note that the E_{ii} form a complete set of pairwise orthogonal idempotents. Any set of matrices satisfying the two properties above is called a set of *matrix units*.

The group algebra $\mathbb{C}S_n$ is isomorphic to the direct sum of matrix algebras

$$\mathbb{C}S_n \cong \bigoplus_{\lambda} \text{Mat}_{f_\lambda}(\mathbb{C}),$$

where the sum is over all partitions of n and f_λ is equal to the number of standard tableaux of shape λ . The matrix units $E_{\Lambda\Lambda'} \in \text{Mat}_{f_\lambda}(\mathbb{C})$ are parameterised by pairs of standard tableaux, however when considering diagonal matrix units we shall write $E_\Lambda = E_{\Lambda\Lambda}$.

Let $F_{\Lambda\Lambda'}$ be the element

$$F_{\Lambda\Lambda'} = \sum_{\sigma \in S_n} (v_\Lambda, \sigma v_{\Lambda'}) \sigma \in \mathbb{C}S_n.$$

And denote the element $\frac{f_\lambda}{n!} F_{\Lambda\Lambda'}$ by $\overline{E}_{\Lambda\Lambda'}$. Then there exists an isomorphism from the matrix algebras to the symmetric group algebras sending $E_{\Lambda\Lambda'}$ to

$\overline{E}_{\Lambda\Lambda'}$ such that the elements \overline{E}_Λ act diagonally on the Young basis, that is to say $\overline{E}_\Lambda v_{\Lambda'} = \delta_{\Lambda\Lambda'} v_\Lambda$.

Murphy's construction of the diagonal matrix units, [Mu1], used certain elements $X_1, \dots, X_n \in \mathbb{C}S_n$ known as Jucys-Murphy elements where

$$\begin{aligned} X_1 &= 0 \\ X_k &= (1 \ k) + (2 \ k) + \dots + (k-1 \ k), \quad k = 2, \dots, n. \end{aligned} \quad (5)$$

If M is a standard tableaux with $n-1$ boxes then

$$\overline{E}_M = \sum_{M \rightarrow \Lambda} \overline{E}_\Lambda,$$

where $M \rightarrow \Lambda$ means that the standard tableaux Λ is obtained from M by adding one box containing the entry n . We then have the action

$$X_k \overline{E}_\Lambda = \overline{E}_\Lambda X_k = c_k(\Lambda) \overline{E}_\Lambda, \quad (6)$$

where $c_k(\Lambda) = j - i$ if the box $(i, j) \in \lambda$ is filled with the number k in Λ . The difference $j - i$ is the *content* of box (i, j) .

Let z be a complex variable, and M the standard tableau obtained from Λ after removing the box containing n . Murphy's recurrence relation for diagonal matrix units may then be written in terms of Jucys-Murphy elements as the following limit;

$$\overline{E}_\Lambda = \overline{E}_M \frac{z}{z + c_n(\Lambda) - X_n} \Big|_{z=0}.$$

We shall now move from diagonal matrix units and instead proceed using the *diagonal matrix element*, F_Λ , defined by,

$$F_\Lambda = \sum_{\sigma \in S_n} (v_\Lambda, \sigma v_\Lambda) \sigma \in \mathbb{C}S_n. \quad (7)$$

We naturally inherit the following equalities

$$F_\Lambda^2 = \frac{n!}{f_\lambda} \cdot F_\Lambda, \quad F_\Lambda v_{\Lambda'} = \frac{n!}{f_\lambda} \cdot \delta_{\Lambda\Lambda'} v_\Lambda \quad \text{and} \quad X_k F_\Lambda = F_\Lambda X_k = \frac{f_\lambda}{n!} \cdot c_k(\Lambda) F_\Lambda.$$

We define the *row tableau* of shape λ , Λ^r , to be the standard tableau obtain by filling the first row of λ consecutively with the numbers 1 to λ_1 , then filling

the second row with $\lambda_1 + 1$ to λ_2 , and so on. We may similarly define a *column tableau* of shape λ , denoted Λ^c , by consecutively filling the columns of λ . There is an explicit formula for the element F_Λ in the group ring $\mathbb{C}S_n$ which is particularly simple when Λ is the row, or column, tableau.

Proposition 2.5 (i) *Diagonal matrix elements may be expressed as follows;*

$$F_{\Lambda^r} = P_{\Lambda^r} Q_{\Lambda^r} P_{\Lambda^r} / \lambda_1! \lambda_2! \dots, \quad (8)$$

$$F_{\Lambda^c} = Q_{\Lambda^c} P_{\Lambda^c} Q_{\Lambda^c} / \lambda'_1! \lambda'_2! \dots, \quad (9)$$

where λ'_i is the length of the i^{th} column of λ .

(ii) *There exist invertible elements $P, Q \in \mathbb{C}S_n$ such that*

$$P_{\Lambda^r} Q_{\Lambda^r} P_{\Lambda^r} = P_{\Lambda^r} Q_{\Lambda^r} P \quad \text{and} \quad Q_{\Lambda^c} P_{\Lambda^c} Q_{\Lambda^c} = Q_{\Lambda^c} P_{\Lambda^c} Q.$$

For any $k = 1, \dots, n-1$ let $\sigma_k \in S_n$ be the transposition of k and $k+1$. The following expression for the matrix element F_Λ for an arbitrary Λ can be obtained from either of (8) or (9) by using the formulas for the action of the generators $\sigma_1, \dots, \sigma_{n-1}$ of the group S_n on the vectors of the Young basis.

Fix any standard tableau Λ . Consider the tableau $\sigma_k \Lambda$ obtained from Λ by exchanging the numbers k and $k+1$. Since the numbers k and $k+1$ cannot lie on the same diagonal in Λ we have $c_k(\Lambda) \neq c_{k+1}(\Lambda)$ always, and so we may set $d_k(\Lambda) = (c_{k+1}(\Lambda) - c_k(\Lambda))^{-1}$. If $\sigma_k \Lambda$ is non-standard then we must have k and $k+1$ standing next to each other in the same row or column of Λ , and hence $d_k(\Lambda) = 1$ or $d_k(\Lambda) = -1$.

Due to [Yo2] all the vectors of the Young basis may be normalised so that for any standard tableau Λ and $k = 1, \dots, n-1$

$$\begin{aligned} \sigma_k \cdot v_\Lambda &= d_k(\Lambda) v_\Lambda + \sqrt{1 - d_k(\Lambda)^2} v_{\sigma_k \Lambda} && \text{for } \sigma_k \Lambda \text{ standard} \\ &= d_k(\Lambda) v_\Lambda && \text{for } \sigma_k \Lambda \text{ non-standard.} \end{aligned} \quad (10)$$

This normalisation determines all the vectors of the Young basis up to a common multiplier $\omega \in \mathbb{C}$ with $|\omega| = 1$. If the tableau $\sigma_k \Lambda$ is standard, then by (10)

$$\sqrt{1 - d_k(\Lambda)^2} v_{\sigma_k \Lambda} = (\sigma_k - d_k(\Lambda)) v_\Lambda, \quad (11)$$

and by definition (7) we have the relation

$$(1 - d_k(\Lambda)^2)F_{\sigma_k\Lambda} = (\sigma_k - d_k(\Lambda))F_\Lambda(\sigma_k - d_k(\Lambda)). \quad (12)$$

For any standard tableau Λ there is a sequence of transpositions $\sigma_{k_1}, \dots, \sigma_{k_b}$ such that $\Lambda = \sigma_{k_b} \cdots \sigma_{k_1} \Lambda^r$. Set $\Lambda^a = \sigma_{k_a} \cdots \sigma_{k_1} \Lambda^r$. Then $\Lambda^0 = \Lambda^r$, $\Lambda^b = \Lambda$ and the tableaux Λ^a are standard for all $a = 0, \dots, b$. Using (12) repeatedly, one can derive from (8) the explicit formula for the element $F_\Lambda \in \mathbb{C}S_n$;

$$\begin{aligned} \prod_{a=1}^b (1 - d_{k_a}(\Lambda^{a-1})^2) F_\Lambda &= (\sigma_{k_b} - d_{k_b}(\Lambda^{b-1})) \cdots (\sigma_{k_1} - d_{k_1}(\Lambda^r)) \\ &\quad \times F_{\Lambda^r} \times (\sigma_{k_1} - d_{k_1}(\Lambda^r)) \cdots (\sigma_{k_b} - d_{k_b}(\Lambda^{b-1})). \end{aligned}$$

So multiplying F_Λ on the left and right by certain invertible elements returns the Young symmetrizer. So one can see that the diagonal matrix element F_Λ may also be used to generate the irreducible module V_Λ , [N5, section 2].

Example 2.6. Let N be the column tableau of shape $\nu = (2, 1)$ as in Example 2.4, and $N' = \sigma_2 N$ the row tableau.

$$N = \begin{array}{|c|c|} \hline 1 & 3 \\ \hline 2 & \\ \hline \end{array} \quad N' = \begin{array}{|c|c|} \hline 1 & 2 \\ \hline 3 & \\ \hline \end{array}$$

Then $v_N, v_{N'}$ is the complete orthonormal Young basis of V_ν . Using (10) we calculate the action of S_3 on v_N to be;

$$\begin{aligned} \sigma_1 v_N &= -v_N; \\ \sigma_2 v_N &= \frac{1}{2}v_N + \omega v_{N'}; \\ \sigma_2 \sigma_1 v_N &= -\frac{1}{2}v_N - \omega v_{N'}; \\ \sigma_1 \sigma_2 v_N &= -\frac{1}{2}v_N + \omega v_{N'}; \\ \sigma_1 \sigma_2 \sigma_1 v_N &= \frac{1}{2}v_N - \omega v_{N'}; \end{aligned}$$

where $\omega = \sqrt{3/4}$.

Hence the diagonal matrix element may be calculated as

$$\begin{aligned}
F_N &= \sum_{\sigma \in S_3} (v_N, \sigma v_N) \sigma \\
&= (v_N, v_N)1 + (v_N, \sigma_1 v_N)(1 \ 2) + (v_N, \sigma_1 \sigma_2 \sigma_1 v_N)(1 \ 3) + (v_N, \sigma_2 v_N)(2 \ 3) \\
&\quad + (v_N, \sigma_1 \sigma_2 v_N)(1 \ 2 \ 3) + (v_N, \sigma_2 \sigma_1 v_N)(1 \ 3 \ 2) \\
&= 1 - (1 \ 2) + \frac{(1 \ 3)}{2} + \frac{(2 \ 3)}{2} - \frac{(1 \ 2 \ 3)}{2} - \frac{(1 \ 3 \ 2)}{2}
\end{aligned}$$

Proposition 2.5 states the diagonal matrix element of the row tableau may be obtained from the Young symmetrizer after multiplication on the right by some invertible element, indeed in this case we have $F_{N'} = Y_{N'}(1 - \frac{(2 \ 3)}{2})$. Furthermore, by (12), $F_N = \frac{4}{3}((2 \ 3) + \frac{1}{2})F_{N'}((2 \ 3) + \frac{1}{2}) = (1 + \frac{(2 \ 3)}{2})Y_N$ and both elements generate modules isomorphic to V_ν . \blacksquare

In 1986 Ivan Cherednik proposed another description of the diagonal matrix element, [C1]. For any two distinct numbers $1 \leq p < q \leq n$, let (pq) be the transposition in the symmetric group S_n . Consider the rational function of two complex variables u, v , $u \neq v$, with values in the group ring $\mathbb{C}S_n$:

$$f_{pq}(u, v) = 1 - \frac{(pq)}{u - v}. \quad (13)$$

Now introduce n complex variables z_1, \dots, z_n . Consider the set of pairs (p, q) with $1 \leq p < q \leq n$. Ordering the pairs lexicographically we form the product

$$F_\Lambda(z_1, \dots, z_n) = \prod_{(p,q)}^{\rightarrow} f_{pq}(z_p + c_p(\Lambda), z_q + c_q(\Lambda)). \quad (14)$$

Notice, if p and q sit on the same diagonal in the tableau Λ , then $f_{pq}(z_p + c_p(\Lambda), z_q + c_q(\Lambda))$ has a pole at $z_p = z_q$. However, using appropriate limiting procedure, such singularities prove to be removable.

Theorem 2.7 (Cherednik) *The consecutive evaluations*

$$F_\Lambda(z_1, \dots, z_n) \Big|_{z_1=0} \Big|_{z_2=0} \cdots \Big|_{z_n=0}$$

of the rational function $F_\Lambda(z_1, \dots, z_n)$ are well defined. The corresponding value coincides with the matrix element F_Λ .

However, Cherednik's paper does not contain complete proofs. A complete proof was given by Nazarov, [N3], while a relatively simple proof was recently found by Molev [Mo]. Cherednik's limiting procedure, however, requires n auxiliary parameters. Nazarov describes a different limiting procedure that reduces the number of such parameters. The following version of Cherednik's description can be found in [N4]. Let \mathcal{R}_Λ be the vector subspace in \mathbb{C}^n consisting of all tuples (z_1, \dots, z_n) such that $z_p = z_q$ whenever the numbers p and q appear in the same row of the tableau Λ .

By direct calculation we can show the following identities are true;

$$f_{pq}(u, v) f_{pr}(u, w) f_{qr}(v, w) = f_{qr}(v, w) f_{pr}(u, w) f_{pq}(u, v) \quad (15)$$

for all pairwise distinct indices p, q, r , and

$$f_{pq}(u, v) f_{st}(z, w) = f_{st}(z, w) f_{pq}(u, v) \quad (16)$$

for all pairwise distinct p, q, s, t .

Let's refer to (15) and (16) as the Yang-Baxter relations. Using these relations we obtain reduced expressions for $F_\Lambda(z_1, \dots, z_n)$ different from the right hand side of (14). This situation is analogous to the case of the symmetric group where two reduced decompositions of the same permutation are always connected by a sequence of Coxeter moves. For more details on different expressions for $F_\Lambda(z_1, \dots, z_n)$ see [GP].

Using (15) and (16) we may reorder the product $F_\Lambda(z_1, \dots, z_n)$ such that each singularity is contained in an expression known to be regular at $z_1 = z_2 = \dots = z_n$, [N4]. It is by this method that it was shown that the restriction of the rational function $F_\Lambda(z_1, \dots, z_n)$ to the subspace \mathcal{R}_Λ is regular at $z_1 =$

$z_2 = \cdots = z_n$. Furthermore, by showing divisibility on the left and on the right by certain elements of $\mathbb{C}S_n$ it was shown that the value of $F_\Lambda(z_1, \dots, z_n)$ at $z_1 = z_2 = \cdots = z_n$ is the diagonal matrix element F_Λ . Thus we have the following theorem,

Theorem 2.8 (Nazarov) *Restriction to \mathcal{R}_Λ of the rational function $F_\Lambda(z_1, \dots, z_n)$ is regular at $z_1 = z_2 = \cdots = z_n$. The value of this restriction at $z_1 = z_2 = \cdots = z_n$ coincides with the element $F_\Lambda \in \mathbb{C}S_n$.*

We now give a typical example for a diagonal matrix element obtained by such a limiting procedure, and obtain the corresponding irreducible representation by using it in the of the Young symmetrizer.

Example 2.9. Again let $N = \begin{array}{|c|c|} \hline 1 & 3 \\ \hline 2 & \\ \hline \end{array}$ as in Example 2.6. Then on the subspace \mathcal{R}_N we have $z_1 = z_3$. By setting $z = z_1 - z_2$ and applying Theorem 2.8 we have,

$$\begin{aligned} F_N = F_N(z)|_{z=0} &= \left(1 - \frac{(1 \ 2)}{z+1}\right) (1 + (1 \ 3)) \left(1 + \frac{(2 \ 3)}{z+2}\right) \Big|_{z=0} \\ &= (1 - (1 \ 2)) (1 + (1 \ 3)) \left(1 + \frac{(2 \ 3)}{2}\right) \\ &= 1 - (1 \ 2) + \frac{(1 \ 3)}{2} + \frac{(2 \ 3)}{2} - \frac{(1 \ 2 \ 3)}{2} - \frac{(1 \ 3 \ 2)}{2} \end{aligned}$$

Notice we may reverse the second line of the above product using (15). In which case we have an invertible element of $\mathbb{C}S_3$ followed by the Young symmetrizer Y_N , and $\mathbb{C}S_3 \cdot F_N$ is the 2-dimensional irreducible $\mathbb{C}S_3$ -module.

The smallest examples containing a singularity are for standard tableau of shape $\gamma = (2, 2)$. Let Γ be the column tableau of shape γ ,

$$\Gamma = \begin{array}{|c|c|} \hline 1 & 3 \\ \hline 2 & 4 \\ \hline \end{array}$$

Then on the subspace \mathcal{R}_Γ we have $z_1 = z_3$ and $z_2 = z_4$, and by setting $z = z_1 - z_2$ we have,

$$F_\Gamma = \left(1 - \frac{(1\ 2)}{z+1}\right) (1 + (1\ 3)) \left(1 - \frac{(1\ 4)}{z}\right) \left(1 + \frac{(2\ 3)}{z+2}\right) (1 + (2\ 4)) \left(1 - \frac{(3\ 4)}{z+1}\right) \Big|_{z=0}$$

Using (15) we may reorder the product as follows. This ordering quickly shows the singularity in the limit is indeed a removable singularity.

$$\begin{aligned} &= \left(1 - \frac{(1\ 2)}{z+1}\right) \left[(1 + (1\ 3)) \left(1 - \frac{(1\ 4)}{z}\right) \left(1 - \frac{(3\ 4)}{z+1}\right) \right] (1 + (2\ 4)) \left(1 + \frac{(2\ 3)}{z+2}\right) \Big|_{z=0} \\ &= \left(1 - \frac{(1\ 2)}{z+1}\right) \left[1 + (1\ 3) - \frac{(1\ 4)}{z+1} - \frac{(3\ 4)}{z+1} - \frac{(1\ 3\ 4)}{z+1} - \frac{(1\ 4\ 3)}{z+1} \right] (1 + (2\ 4)) \left(1 + \frac{(2\ 3)}{z+2}\right) \Big|_{z=0} \\ &= (1 - (1\ 2)) [1 + (1\ 3) - (1\ 4) - (3\ 4) - (1\ 3\ 4) - (1\ 4\ 3)] (1 + (2\ 4)) \left(1 + \frac{(2\ 3)}{2}\right) \\ &= 1 - (1\ 2) - (3\ 4) + (1\ 2)(3\ 4) + (1\ 3)(2\ 4) + (1\ 4)(2\ 3) - (1\ 3\ 2\ 4) - (1\ 4\ 2\ 3) + \frac{(1\ 3)}{2} \\ &\quad + \frac{(1\ 4)}{2} + \frac{(2\ 3)}{2} + \frac{(2\ 4)}{2} - \frac{(1\ 2\ 3)}{2} - \frac{(1\ 2\ 4)}{2} - \frac{(1\ 3\ 2)}{2} - \frac{(1\ 3\ 4)}{2} - \frac{(1\ 4\ 2)}{2} - \frac{(1\ 4\ 3)}{2} \\ &\quad - \frac{(2\ 3\ 4)}{2} - \frac{(2\ 4\ 3)}{2} + \frac{(1\ 2\ 3\ 4)}{2} + \frac{(1\ 2\ 4\ 3)}{2} + \frac{(1\ 3\ 4\ 2)}{2} + \frac{(1\ 4\ 3\ 2)}{2} \end{aligned}$$

■

In particular, if λ is a partition with only one part, that is to say λ has a Young diagram consisting of a single row, then the fusion procedure uses only one parameter, z . However, this means all parameters in $F_\Lambda(z)$ cancel and the diagonal matrix element may be written without parameters as

$$F_\Lambda = \prod_{(p,q)}^{\rightarrow} f_{pq}(c_p(\Lambda), c_q(\Lambda)).$$

Similarly, we may form another expression for F_Λ by considering the subspace in \mathbb{C}^n consisting of all tuples (z_1, \dots, z_n) such that $z_p = z_q$ whenever the numbers p and q appear in the same column of the tableau Λ [NT].

2.4 Constructing representations

The fusion procedure described above required the decomposition of a Young diagram λ into its rows, with a similar limiting procedure corresponding to a decomposition of λ into its columns. We may use the same decompositions of λ to construct certain symmetric functions.

Let $\Lambda(i, j)$ be the entry in box (i, j) of a Young tableau Λ of shape λ . Then we can define a product x^Λ as follows,

$$x^\Lambda = \prod_{(i,j) \in \lambda} x_{\Lambda(i,j)}.$$

Given a partition λ , the associated *Schur function* is

$$s_\lambda(x_1, \dots, x_m) = \sum_{\Lambda} x^\Lambda,$$

where the sum is over all semistandard tableaux Λ of shape λ with entries $1, \dots, m$. The Schur functions are symmetric functions, [MD].

The n^{th} *complete homogeneous symmetric function*, $h_n(x_1, \dots, x_m)$, is the corresponding Schur function of a tableau consisting of a single row of n boxes. That is to say,

$$h_n(x_1, \dots, x_m) = s_{(n)}(x_1, \dots, x_m).$$

Similarly, the n^{th} *elementary symmetric function*, $e_n(x_1, \dots, x_m)$, is the corresponding Schur function of a tableau consisting of a single column of n boxes,

$$e_n(x_1, \dots, x_m) = s_{(1^n)}(x_1, \dots, x_m).$$

Define $\mathbf{x} = (x_1, \dots, x_m)$. We can obtain the Schur function of any shape from Young diagrams consisting of single rows, or alternatively single columns, by means of the *Jacobi-Trudi identities* [MD, Chapter I3]. Let $\lambda = (\lambda_1, \lambda_2, \dots, \lambda_k)$, then we have the determinantal expressions

$$s_\lambda(\mathbf{x}) = \det[h_{\lambda_i - i + j}(\mathbf{x})]_{i,j=1}^k \tag{17}$$

and

$$s_\lambda(\mathbf{x}) = \det[e_{\lambda'_i - i + j}(\mathbf{x})]_{i,j=1}^l, \tag{18}$$

where λ' is the conjugate of λ , l is the number of columns of λ , and any symmetric function with negative subscript is defined to be zero.

We can think of the following identities as related to the Jacobi-Trudi identities. Given $\lambda = (\lambda_1, \dots, \lambda_k)$ such that $n = \lambda_1 + \dots + \lambda_k$ then the following identity holds,

$$h_{\lambda_1}(\mathbf{x})h_{\lambda_2}(\mathbf{x}) \dots h_{\lambda_k}(\mathbf{x}) = \sum_{\mu} K_{\mu\lambda} s_{\mu}(\mathbf{x}), \quad (19)$$

where the sum is over all partitions of n . The coefficients $K_{\mu\lambda}$ are non-negative integers known as *Kostka numbers*, [MD]. Importantly, we have $K_{\lambda\lambda} = 1$.

There exists an isomorphism from the graded ring of symmetric functions to the ring of equivalence classes of representations of all $\mathbb{C}S_n$, which sends the schur function of shape λ to the equivalence class of shape λ . This translates the identity (19) into the following identity of S_n -modules;

$$\text{Ind}_{S_{\lambda_1} \times S_{\lambda_2} \times \dots \times S_{\lambda_k}}^{S_n} V_{(\lambda_1)} \otimes V_{(\lambda_2)} \otimes \dots \otimes V_{(\lambda_k)} \cong \bigoplus_{\mu} (V_{\mu})^{\oplus K_{\mu\lambda}}, \quad (20)$$

where the sum is over all partitions of n . Note that $V_{(\lambda_i)}$ is the trivial representation of S_{λ_i} .

Let μ be a partition of m and M is a standard tableaux of shape μ . Denote by ϵ_x the embedding $\mathbb{C}S_n \rightarrow \mathbb{C}S_{n+x}$ defined by

$$\epsilon_x : (pq) \mapsto (p+x, q+x) \quad (21)$$

for all distinct $p, q = 1, \dots, n$. Then the S_{n+m} -module induced from the $(S_n \times S_m)$ -module $V_{\lambda} \otimes V_{\mu}$ can be realised as the left ideal in $\mathbb{C}S_{n+m}$ generated by the product $F_{\Lambda} \cdot \epsilon_n(F_M)$.

Therefore on the subspace \mathcal{R}_{Λ} we may write (14) as the product of diagonal matrix elements corresponding to the rows of λ and an element depending on parameters z_1, z_2, \dots, z_n . Explicitly we have,

$$F_{\Lambda}(z_1, \dots, z_n) = F_{(\lambda_1)} \cdot \epsilon_{\lambda_1}(F_{(\lambda_2)}) \cdot \epsilon_{\lambda_1+\lambda_2}(F_{(\lambda_3)}) \cdot \dots \cdot \epsilon_{\lambda_1+\dots+\lambda_{k-1}}(F_{(\lambda_k)}) \cdot A(z_1, \dots, z_n).$$

If $z_i - z_j \notin \mathbb{Z}$ when i and j are in different rows of Λ then $A(z_1, \dots, z_n)$ is invertible in $\mathbb{C}S_n$. Hence, under this condition, (20) may be realised as the left ideal in $\mathbb{C}S_n$ generated by $F_\Lambda(z_1, \dots, z_n)$.

The irreducible representation V_λ appears in the decomposition of this induced module with coefficient 1, and is the ideal of $\mathbb{C}S_n$ generated by $F_\Lambda(z_1, \dots, z_n)$ when $z_1 = z_2 = \dots = z_n$. The fusion procedure of Theorem 2.8 provides a way of singling out this irreducible component.

Example 2.10. Let Λ be a standard tableau of shape $\lambda = (3, 3, 2)$. The first Jacobi-Trudi identity, (17), gives us a way to write the Schur function $s_\lambda(\mathbf{x})$ as a determinant of complete homogeneous symmetric functions.

$$s_{(3,3,2)}(\mathbf{x}) = \begin{vmatrix} h_3(\mathbf{x}) & h_4(\mathbf{x}) & h_5(\mathbf{x}) \\ h_2(\mathbf{x}) & h_3(\mathbf{x}) & h_4(\mathbf{x}) \\ h_0(\mathbf{x}) & h_1(\mathbf{x}) & h_2(\mathbf{x}) \end{vmatrix} = \begin{vmatrix} s_{\square\square\square} & s_{\square\square\square\square} & s_{\square\square\square\square\square} \\ s_{\square\square} & s_{\square\square\square} & s_{\square\square\square\square} \\ 1 & s_{\square} & s_{\square\square} \end{vmatrix},$$

or dually,

$$\begin{aligned} h_3(\mathbf{x})h_3(\mathbf{x})h_2(\mathbf{x}) = & s_{(3,3,2)}(\mathbf{x}) + s_{(4,4)}(\mathbf{x}) + 2s_{(4,3,1)}(\mathbf{x}) + s_{(4,2,2)}(\mathbf{x}) + 3s_{(5,3)}(\mathbf{x}) \\ & + 2s_{(5,2,1)}(\mathbf{x}) + 3s_{(6,2)}(\mathbf{x}) + 2s_{(7,1)}(\mathbf{x}) + s_{(8)}(\mathbf{x}). \end{aligned}$$

In terms of modules we therefore obtain the following identity;

$$\begin{aligned} \text{Ind}_{S_3 \times S_3 \times S_2}^{S_8} V_{(3)} \otimes V_{(3)} \otimes V_{(2)} = & V_{(3,3,2)} \oplus V_{(4,4)} \oplus 2V_{(4,3,1)} \oplus V_{(4,2,2)} \oplus 3V_{(5,3)} \\ & \oplus 2V_{(5,2,1)} \oplus 3V_{(6,2)} \oplus 2V_{(7,1)} \oplus V_{(8)}. \end{aligned}$$

Here, the induced module may be realised as the left ideal of $\mathbb{C}S_8$ generated by $F_\Lambda(z_1, \dots, z_8)$ which has three parameters on the subspace \mathcal{R}_Λ , where $z_i - z_j \notin \mathbb{Z}$ when i and j are in different rows of Λ . The irreducible representation corresponding to λ , $V_{(3,3,2)}$, appears in the decomposition above with coefficient 1, and is generated by $F_\Lambda(z_1, \dots, z_8)$ in the limit where the three parameters are equal. ■

Similarly we have the equivalent identity for columns,

$$\text{Ind}_{S_{\lambda'_1} \times S_{\lambda'_2} \times \cdots \times S_{\lambda'_l}}^{S_n} V_{(1^{\lambda'_1})} \otimes V_{(1^{\lambda'_2})} \otimes \cdots \otimes V_{(1^{\lambda'_l})} \cong \bigoplus_{\mu} (V_{\mu})^{\oplus K_{\mu'\lambda'}}.$$

In this case $V_{(1^{\lambda'_i})}$ is the alternating representation of $S_{\lambda'_i}$. This induced module is isomorphic to the left ideal of $\mathbb{C}S_n$ generated by $F_{\Lambda}(z_1, \dots, z_n)$ considered on the subspace $\mathcal{R}_{\Lambda'}$, with $z_i - z_j \notin \mathbb{Z}$ when i, j are in different columns of Λ . Here Λ' denotes the transpose of the standard tableau Λ of shape λ . Again the irreducible representation V_{λ} appears in the decomposition of this induced module with coefficient 1, and is the ideal of $\mathbb{C}S_n$ generated by $F_{\Lambda}(z_1, \dots, z_n)$ when $z_1 = z_2 = \cdots = z_n$.

3 The hook fusion procedure

In this chapter we present a new expression for the diagonal matrix elements which minimises the number of auxiliary parameters needed in the fusion procedure. We do this by considering diagonal hooks of standard tableaux rather than their rows or columns. This minimises the number of auxiliary parameters since using fewer parameters would require at least one pair (p, q) where $z_p = z_q$ and p and q lie on the same diagonal, leading to a pole in the function (14) in the limit $z_1 = \dots = z_n$. This is an expanded version of the author's first paper, [Gr1].

If (i, j) is a box in the diagram of λ , then its (i, j) -hook is the set of boxes in λ

$$\{(i, j') : j' \geq j\} \cup \{(i', j) : i' \geq i\}.$$

For example, if $\lambda = (3, 3, 2)$ then the $(2, 2)$ -hook is given by the dotted cells in the following diagram;

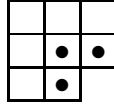

We call the (i, i) -hook in λ the i^{th} *principal hook*.

Let \mathcal{H}_Λ be the vector subspace in \mathbb{C}^n consisting of all tuples (z_1, \dots, z_n) such that $z_p = z_q$ whenever the numbers p and q appear in the same principal hook of the tableau Λ . We will prove the following theorem.

Theorem 3.1 *Restriction to \mathcal{H}_Λ of the rational function $F_\Lambda(z_1, \dots, z_n)$ is regular at $z_1 = z_2 = \dots = z_n$. The value of this restriction at $z_1 = z_2 = \dots = z_n$ coincides with the element $F_\Lambda \in \mathbb{C}S_n$.*

In particular, this hook fusion procedure can be used to form irreducible representations of $\mathbb{C}S_n$ corresponding to Young diagrams of hook shape using only one auxiliary parameter, z . If ν is a partition of hook shape, this means we

may calculate the diagonal matrix element without parameters as

$$F_N = \prod_{(p,q)}^{\rightarrow} f_{pq}(c_p(N), c_q(N)), \quad (22)$$

with the pairs (p, q) in the product ordered lexicographically. For example, if $\nu = (2, 1)$ as in Example 2.4, then the hook fusion procedure directly gives us the diagonal matrix element F_N .

There is another expression for Schur functions known as the *Giambelli identity* [Gi]. This identity expresses any Schur function $s_\lambda(\mathbf{x})$ as a determinant of Schur functions of hook shape. The following description along with a combinatorial proof of the Giambelli identity can be found in [ER].

Divide a Young diagram λ into boxes with positive and non-positive content. We may illustrate this on the Young diagram by drawing ‘steps’ above the main diagonal. Denote the boxes above the steps by $\alpha(\lambda)$ and the rest by $\beta(\lambda)$. For example, the following figure illustrates λ , $\alpha(\lambda)$ and $\beta(\lambda)$ for $\lambda = (3, 3, 2)$.

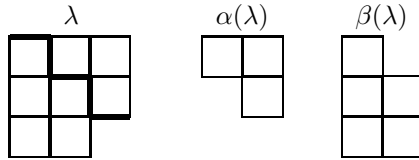

Figure 1: The Young diagram $(3, 3, 2)$ divided into boxes with positive content and non-positive content

If we denote the rows of $\alpha(\lambda)$ by $\alpha_1 > \alpha_2 > \dots > \alpha_d > 0$ and the columns of $\beta(\lambda)$ by $\beta_1 > \beta_2 > \dots > \beta_d > 0$, then we have the following alternative notation for λ ;

$$\lambda = (\alpha|\beta),$$

where $\alpha = (\alpha_1, \dots, \alpha_d)$ and $\beta = (\beta_1, \dots, \beta_d)$.¹

Here d denotes the length of the side of the *Durfee square* of the shape λ , which is the set of boxes corresponding to the largest square that fits inside λ ,

¹A related notation is known as the *Frobenius notation*, where $\beta' = (\beta_1 - 1, \dots, \beta_d - 1)$ and λ is written as $(\alpha|\beta')$.

and is equal to the number of principal hooks in λ . In our example $d = 2$ and $\lambda = (2, 1|3, 2)$.

Using this notation the Giambelli identity may be written as follows;

$$s_{(\alpha|\beta)}(\mathbf{x}) = \det[s_{(\alpha_i|\beta_j)}(\mathbf{x})]_{i,j=1}^d, \quad (23)$$

where the determinant is $d \times d$.

Dually, for a partition $\lambda = (\alpha_1, \alpha_2, \dots, \alpha_d | \beta_1, \beta_2, \dots, \beta_d)$ of n , we have the identity

$$s_{(\alpha_1|\beta_1)}(\mathbf{x}) s_{(\alpha_2|\beta_2)}(\mathbf{x}) \dots s_{(\alpha_d|\beta_d)}(\mathbf{x}) = \sum_{\mu} D_{\mu\lambda} s_{\mu}(\mathbf{x}), \quad (24)$$

where the sum is over all partitions of n . The coefficients, $D_{\mu\lambda}$, are non-negative integers, and in particular $D_{\lambda\lambda} = 1$, see Proposition 3.15. This translates to a decomposition of the induced representation of the tensor product of modules of hook shape. Further these hooks are the principal hooks of λ .

$$\text{Ind}_{S_{h_1} \times S_{h_2} \times \dots \times S_{h_d}}^{S_n} V_{(\alpha_1|\beta_1)} \otimes V_{(\alpha_2|\beta_2)} \otimes \dots \otimes V_{(\alpha_d|\beta_d)} \cong \bigoplus_{\mu} (V_{\mu})^{\oplus D_{\mu\lambda}},$$

where h_i is the length of the i^{th} principal hook.

Now, on the subspace \mathcal{H}_{Λ} , we may write (14) as the product of diagonal matrix elements corresponding to the principal hooks of λ and an element depending on parameters z_1, z_2, \dots, z_n . Explicitly we have,

$$\begin{aligned} F_{\Lambda}(z_1, \dots, z_n) &= F_{(\alpha_1|\beta_1)} \cdot \epsilon_{h_1}(F_{(\alpha_2|\beta_2)}) \cdot \epsilon_{h_1+h_2}(F_{(\alpha_3|\beta_3)}) \cdot \dots \\ &\quad \dots \epsilon_{h_1+\dots+h_{d-1}}(F_{(\alpha_d|\beta_d)}) \cdot B(z_1, \dots, z_n), \end{aligned}$$

where ϵ is the embedding described in (21).

If $z_i - z_j \notin \mathbb{Z}$ when i and j are in different principal hooks of Λ then $B(z_1, \dots, z_n)$ is invertible in $\mathbb{C}S_n$. Therefore, under this condition, the above induced module may be realised as the left ideal in $\mathbb{C}S_n$ generated by $F_{\Lambda}(z_1, \dots, z_n)$.

The irreducible representation V_{λ} appears in the decomposition of this induced module with coefficient 1, and is the ideal of $\mathbb{C}S_n$ generated by $F_{\Lambda}(z_1, \dots, z_n)$ when $z_1 = z_2 = \dots = z_n$.

Hence, in this way, our hook fusion procedure relates to the Giambelli identity in the same way that Cherednik's original fusion procedure relates to the Jacobi-Trudi identity. Namely, it provides a way of singling out the irreducible component V_λ from the above induced module.

3.1 Proof of the hook fusion procedure

We now begin our proof of Theorem 3.1, the hook fusion procedure. We fill a diagram λ by hooks to form a tableau Λ° in the following way: For the first principal hook we fill the column with entries $1, 2, \dots, r$ and then fill the row with entries $r + 1, r + 2, \dots, s$. We then fill the column of the second principal hook with $s + 1, s + 2, \dots, t$ and fill the row with $t + 1, t + 2, \dots, x$. Continuing in this way we form the *hook tableau*.

Example 3.2. On the left is the hook tableau, Λ° , of the diagram $\lambda = (3, 3, 2)$, and on the right the same diagram with the content of each box.

1	4	5
2	6	8
3	7	

0	1	2
-1	0	1
-2	-1	

Therefore the sequence $(c_1(\Lambda^\circ), c_2(\Lambda^\circ), \dots, c_8(\Lambda^\circ))$ is given by $(0, -1, -2, 1, 2, 0, -1, 1)$. ■

Consider (14) as a rational function of the variables z_1, \dots, z_n with values in $\mathbb{C}S_n$. The factor $f_{pq}(z_p + c_p(\Lambda), z_q + c_q(\Lambda))$ has a pole at $z_p = z_q$ if and only if the numbers p and q stand on the same diagonal of the tableau Λ . We then call the pair (p, q) a *singularity*. And we call the corresponding term $f_{pq}(z_p + c_p(\Lambda), z_q + c_q(\Lambda))$ a *singularity term*, or simply a singularity.

Let p and q be in the same hook of Λ . If p and q are next to one another in the column of the hook then, on \mathcal{H}_Λ , $f_{pq}(z_p + c_p(\Lambda), z_q + c_q(\Lambda)) = 1 - (pq)$. Similarly, if p and q are next to one another in the same row of the hook then

$f_{pq}(z_p + c_p(\Lambda), z_q + c_q(\Lambda)) = 1 + (pq)$. In both cases $\frac{1}{2}f_{pq}(z_p + c_p(\Lambda), z_q + c_q(\Lambda))$ is an idempotent.

Also, for distinct p, q , we have the identity

$$f_{pq}(u, v)f_{qp}(v, u) = 1 - \frac{1}{(u - v)^2}. \quad (25)$$

Therefore, if the contents c_p and c_q differ by a number greater than one, then the factor $f_{pq}(c_p, c_q)$ is invertible in $\mathbb{C}S_n$ with inverse $\frac{(c_p - c_q)^2}{(c_p - c_q)^2 - 1}f_{qp}(c_q, c_p)$.

The presence of singularity terms in the product $F_\Lambda(z_1, \dots, z_n)$ means this product may or may not be regular on the vector subspace of \mathcal{H}_Λ in the limit $z_1 = z_2 = \dots = z_n$. Using the following lemma, we will be able to show that $F_\Lambda(z_1, \dots, z_n)$ is in fact regular on this subspace, with all singularities being removable.

Lemma 3.3 *The restriction of $f_{pq}(u, v)f_{pr}(u, w)f_{qr}(v, w)$ to the set (u, v, w) such that $u = v \pm 1$ is regular at $u = w$.*

Proof. Under the condition $u = v \pm 1$, the product $f_{pq}(u, v)f_{pr}(u, w)f_{qr}(v, w)$ can be written as

$$(1 \mp (pq)) \cdot \left(1 - \frac{(pr) + (qr)}{v - w}\right).$$

And this rational function of v, w is clearly regular at $w = v \pm 1$. ■

Notice that the three term product, or *triple*, in the statement of the lemma can be written in reverse order due to (15). In particular, if the middle term is a singularity and the other two terms are an appropriate idempotent and *triple term*, then the triple is regular at $z_1 = z_2 = \dots = z_n$. We may now prove the first statement of Theorem 3.1.

Proposition 3.4 *The restriction of the rational function $F_\Lambda(z_1, \dots, z_n)$ to the subspace \mathcal{H}_Λ is regular at $z_1 = z_2 = \dots = z_n$.*

Proof. Consider any standard tableau Λ' obtained from the tableau Λ by an adjacent transposition of its entries, say by $\sigma_k \in S_n$. Using the relations (15), (16) and (25), we derive the equality of rational functions in the variables z_1, \dots, z_n

$$\begin{aligned} F_\Lambda(z_1, \dots, z_n) \cdot f_{k+1,k}(z_{k+1} + c_{k+1}(\Lambda), z_k + c_k(\Lambda)) \sigma_k = \\ \sigma_k f_{k,k+1}(z_k + c_k(\Lambda), z_{k+1} + c_{k+1}(\Lambda)) \cdot F_{\Lambda'}(z'_1, \dots, z'_n), \end{aligned} \quad (26)$$

where the sequence of variables (z'_1, \dots, z'_n) is obtained from the sequence (z_1, \dots, z_n) by exchanging the terms z_k and z_{k+1} . Observe that

$$(z'_1, \dots, z'_n) \in \mathcal{H}_{\Lambda'} \iff (z_1, \dots, z_n) \in \mathcal{H}_\Lambda.$$

Also observe that here $|c_k(\Lambda) - c_{k+1}(\Lambda)| \geq 2$ because the tableaux Λ and Λ' are standard. Therefore the functions

$$f_{k,k+n}(z_k + c_k(\Lambda), z_{k+1} + c_{k+1}(\Lambda)) \quad \text{and} \quad f_{k+1,k}(z_{k+1} + c_{k+1}(\Lambda), z_k + c_k(\Lambda))$$

appearing in the equality (26), are regular at $z_k = z_{k+1}$. Moreover, their values at $z_k = z_{k+1}$ are invertible in $\mathbb{C}S_n$. Due to these two observations, the equality (26) shows that Proposition 3.4 is equivalent to its counterpart for the tableau Λ' instead of Λ .

Let us take the hook tableau Λ° of shape λ . There is a chain $\Lambda, \Lambda', \dots, \Lambda^\circ$ of standard tableaux of the same shape λ , such that each subsequent tableau in the chain is obtained from the previous one by an adjacent transposition of the entries. Due to the above argument, it now suffices to prove Proposition 3.4 only in the case $\Lambda = \Lambda^\circ$.

We will prove the statement by reordering the factors of the product $F_{\Lambda^\circ}(z_1, \dots, z_n)$, using relations (15) and (16), in such a way that each singularity is part of a triple which is regular at $z_1 = z_2 = \dots = z_n$, and hence the whole of $F_{\Lambda^\circ}(z_1, \dots, z_n)$ will be manifestly regular.

Define g_{pq} to be the following;

$$g_{pq} = \begin{cases} f_{pq}(z_p + c_p(\Lambda^\circ), z_q + c_q(\Lambda^\circ)) & \text{if } p < q \\ 1 & \text{if } p \geq q \end{cases}$$

Now, let us divide the diagram λ into two parts, consisting of those boxes with positive contents and those with non-positive contents as in Figure 3. Consider the entries of the i^{th} column of the hook tableau Λ of shape λ that lie below the steps. If u_1, u_2, \dots, u_k are the entries of the i^{th} column below the steps, we define

$$C_i = \prod_{q=1}^n g_{u_1,q} g_{u_2,q} \cdots g_{u_k,q}. \quad (27)$$

Now consider the entries of the i^{th} row of Λ that lie above the steps. If v_1, v_2, \dots, v_l are the entries of the i^{th} row above the steps, we define

$$R_i = \prod_{q=1}^n g_{v_1,q} g_{v_2,q} \cdots g_{v_l,q}. \quad (28)$$

Our choice of the hook tableau was such that the following is true; if d is the number of principal hooks of λ then by relations (15) and (16) we may reorder the factors of $F_{\Lambda^\circ}(z_1, \dots, z_n)$ such that

$$F_{\Lambda^\circ}(z_1, \dots, z_n) = \prod_{i=1}^d C_i R_i.$$

Now each singularity (p, q) has its corresponding term $f_{pq}(z_p + c_p(\Lambda^\circ), z_q + c_q(\Lambda^\circ))$ contained in some product C_i or R_i . This singularity term will be on the immediate left of the term $f_{p+1,q}(z_{p+1} + c_{p+1}(\Lambda^\circ), z_q + c_q(\Lambda^\circ))$. Also, this ordering has been chosen such that the product of factors to the left of any such singularity in C_i or R_i is divisible on the right by $f_{p,p+1}(z_p + c_p(\Lambda^\circ), z_{p+1} + c_{p+1}(\Lambda^\circ))$.

Therefore we can replace the pair

$$f_{pq}(z_p + c_p(\Lambda^\circ), z_q + c_q(\Lambda^\circ)) f_{p+1,q}(z_{p+1} + c_{p+1}(\Lambda^\circ), z_q + c_q(\Lambda^\circ))$$

in the product by the triple

$$\frac{1}{2} f_{p,p+1}(z_p + c_p(\Lambda^\circ), z_{p+1} + c_{p+1}(\Lambda^\circ)) f_{pq}(z_p + c_p(\Lambda^\circ), z_q + c_q(\Lambda^\circ)) f_{p+1,q}(z_{p+1} + c_{p+1}(\Lambda^\circ), z_q + c_q(\Lambda^\circ)),$$

where $\frac{1}{2} f_{p,p+1}(z_p + c_p(\Lambda^\circ), z_{p+1} + c_{p+1}(\Lambda^\circ))$ is an idempotent. Divisibility on the right by $f_{p,p+1}(z_p + c_p(\Lambda^\circ), z_{p+1} + c_{p+1}(\Lambda^\circ))$ means the addition of the idempotent has no effect on the value of the product C_i or R_i .

By Lemma 3.3, the above triples are regular at $z_1 = z_2 = \dots = z_n$, and therefore, so too are the products C_i and R_i , for all $1 \leq i \leq d$. Moreover, this means $F_{\Lambda^\circ}(z_1, \dots, z_n)$ is regular at $z_1 = z_2 = \dots = z_n$. \blacksquare

Example 3.5. As an example consider the hook tableau of the Young diagram $\lambda = (3, 3, 2)$.

In the original lexicographic ordering the product $F_{\Lambda^\circ}(z_1, \dots, z_n)$ is written as follows, for simplicity we will write f_{pq} in place of the term $f_{pq}(z_p + c_p(\Lambda^\circ), z_q + c_q(\Lambda^\circ))$.

$$F_{\Lambda^\circ}(z_1, \dots, z_n) = f_{12}f_{13}f_{14}f_{15}f_{16}f_{17}f_{18}f_{23}f_{24}f_{25}f_{26}f_{27}f_{28}f_{34}f_{35}f_{36}f_{37}f_{38} \\ f_{45}f_{46}f_{47}f_{48}f_{56}f_{57}f_{58}f_{67}f_{68}f_{78}$$

We may now reorder this product into the form below using relations (15) and (16) as described in the above proposition. The terms bracketed are the singularity terms with their appropriate triple terms.

$$F_{\Lambda^\circ}(z_1, \dots, z_n) = f_{12}f_{13}f_{23}f_{14}f_{24}f_{34}f_{15}f_{25}f_{35}(f_{16}f_{26})f_{36}f_{17}(f_{27}f_{37})f_{18}f_{28}f_{38} \\ \cdot f_{45}f_{46}f_{56}f_{47}f_{57}(f_{48}f_{58}) \cdot f_{67}f_{68}f_{78}$$

And so, for each singularity f_{pq} , we can replace $f_{pq}f_{p+1,q}$ in the product by the triple $\frac{1}{2}f_{p,p+1}f_{pq}f_{p+1,q}$, where $\frac{1}{2}f_{p,p+1}$ is an idempotent, without changing the value of $F_{\Lambda^\circ}(z_1, \dots, z_n)$.

$$F_{\Lambda^\circ}(z_1, \dots, z_n) = f_{12}f_{13}f_{23}f_{14}f_{24}f_{34}f_{15}f_{25}f_{35}(\frac{1}{2}f_{12}f_{16}f_{26})f_{36}f_{17}(\frac{1}{2}f_{23}f_{27}f_{37})f_{18} \\ f_{28}f_{38} \cdot f_{45}f_{46}f_{56}f_{47}f_{57}(\frac{1}{2}f_{45}f_{48}f_{58}) \cdot f_{67}f_{68}f_{78}$$

And since each of these triples are regular at $z_1 = z_2 = \dots = z_n$ then so too is the whole of $F_{\Lambda^\circ}(z_1, \dots, z_n)$. \blacksquare

Therefore, due to the above proposition an element $F_\Lambda \in \mathbb{C}S_n$ can now be defined as the value of $F_{\Lambda^\circ}(z_1, \dots, z_n)$ at $z_1 = z_2 = \dots = z_n$. We proceed by showing this F_Λ is indeed the diagonal matrix element. To this end we will need the following propositions.

Note that for $n = 1$, we have $F_\Lambda = 1$. For any $n \geq 1$, we have the following fact.

Proposition 3.6 *The coefficient of $F_\Lambda \in \mathbb{C}S_n$ at the unit element of S_n is 1.*

Proof. For each $r = 1, \dots, n-1$ let $\sigma_r \in S_n$ be the adjacent transposition $(r, r+1)$. Let $\sigma_0 \in S_n$ be the element of maximal length. Multiply the ordered product (14) by the element σ_0 on the right. Using the reduced decomposition

$$\sigma_0 = \prod_{(p,q)}^{\rightarrow} \sigma_{q-p} \quad (29)$$

we get the product

$$\prod_{(p,q)}^{\rightarrow} \left(\sigma_{q-p} - \frac{1}{z_p - z_q + c_p(\Lambda) - c_q(\Lambda)} \right).$$

For the derivation of this formula see [GP, (2.4)]. This formula expands as a sum of the elements $\sigma \in S_n$ with coefficients from the field of rational functions of z_1, \dots, z_n valued in \mathbb{C} . Since the decomposition (29) is reduced, the coefficient at σ_0 is 1. By the definition of F_Λ , this implies that the coefficient of $F_\Lambda \sigma_0 \in \mathbb{C}S_n$ at σ_0 is also 1. ■

In particular this shows that $F_\Lambda \neq 0$ for any nonempty diagram λ . Let us now denote by φ the involutive antiautomorphism of the group ring $\mathbb{C}S_n$ defined by $\varphi(\sigma) = \sigma^{-1}$ for every $\sigma \in S_n$.

Proposition 3.7 *The element $F_\Lambda \in \mathbb{C}S_n$ is φ -invariant.*

Proof. Any element of the group ring $\mathbb{C}S_n$ of the form $f_{pq}(u, v)$ is φ -invariant. Applying the antiautomorphism φ to an element of the form (14) just reverses the ordering of the factors corresponding to the pairs (p, q) . However, the initial ordering can then be restored using relations (15) and (16), for more detail see [GP]. Therefore, any value of the function $F_\Lambda(z_1, \dots, z_n)$ is φ -invariant. Therefore, so too is the element F_Λ . ■

Proposition 3.8 *Let x be last entry in the k^{th} row of the hook tableau of shape λ . If $\lambda = (\alpha_1, \alpha_2, \dots, \alpha_d | \beta_1, \beta_2, \dots, \beta_d)$ and $\mu = (\alpha_{k+1}, \alpha_{k+2}, \dots, \alpha_d | \beta_{k+1}, \beta_{k+2}, \dots, \beta_d)$, then $F_{\Lambda^\circ} = P \cdot \epsilon_x(F_{M^\circ})$, for some element $P \in \mathbb{C}S_n$, where ϵ_x is the embedding in (21).*

Proof. Here the shape μ is obtained by removing the first k principal hooks of λ . By the ordering described in Proposition 3.4,

$$F_{\Lambda^\circ}(z_1, \dots, z_n) = \prod_{i=1}^k C_i R_i \cdot \epsilon_x(F_{M^\circ}(z_{x+1}, \dots, z_n)),$$

where C_i and R_i are defined by (27) and (28).

Since all products C_i and R_i are regular at $z_1 = z_2 = \dots = z_n$, Proposition 3.4 then gives us the required statement. \blacksquare

In any given ordering of $F_\Lambda(z_1, \dots, z_n)$, we want a singularity term to be placed next to an appropriate triple term such that we may then form a regular triple. In that case we will say these two terms are ‘tied’.

If u, v stand next to each other in the same row, or same column, of Λ° the following results show that F_{Λ° is divisible on the left (and on the right) by $1 - (uv)$, or $1 + (uv)$ respectively, or divisible by these terms preceded (followed) by some invertible elements of $\mathbb{C}S_n$.

However, proving the divisibilities described requires some pairs to be ‘untied’, in which case we must form a new ordering. This is the content of the following proofs. Some explicit examples will then given in Example 3.11 below.

Proposition 3.9 *Suppose the numbers $u < v$ stand next to each other in the same column of the hook tableau Λ° of shape λ . First, let s be the last entry in the row containing u . If $c_v(\Lambda^\circ) < 0$ then the element $F_{\Lambda^\circ} \in \mathbb{C}S_n$ is divisible on the left and on the right by $f_{u,v}(c_u(\Lambda^\circ), c_v(\Lambda^\circ)) = 1 - (uv)$. If $c_v(\Lambda^\circ) \geq 0$ then the element $F_{\Lambda^\circ} \in \mathbb{C}S_n$ is divisible on the left by the product*

$$\prod_{i=u, \dots, s}^{\leftarrow} \left(\prod_{j=s+1, \dots, v}^{\rightarrow} f_{ij}(c_i(\Lambda^\circ), c_j(\Lambda^\circ)) \right)$$

Proof. By Proposition 3.7, the divisibility of F_{Λ° by the element $1 - (uv)$ on the left is equivalent to the divisibility by the same element on the right. Let us prove divisibility on the left.

By Proposition 3.8, if $\epsilon_x(F_{M^\circ})$ is divisible on the right by $f_{uv}(c_u(\Lambda^\circ), c_v(\Lambda^\circ))$, or $f_{uv}(c_u(\Lambda^\circ), c_v(\Lambda^\circ))$ followed by some invertible terms, then so too will F_{Λ° .

If $\epsilon_x(F_{M^\circ})$ is divisible on the left by $f_{uv}(c_u(\Lambda^\circ), c_v(\Lambda^\circ))$, or $f_{uv}(c_u(\Lambda^\circ), c_v(\Lambda^\circ))$ preceded by some invertible terms, then by using Proposition 3.7 twice, first on $\epsilon_x(F_{M^\circ})$ and then on the product $F_{\Lambda^\circ} = P \cdot \epsilon_x(F_{M^\circ})$, so too will F_{Λ° . Hence we only need to prove the statement for (u, v) such that u is in the first row or first column of Λ° .

Let r be the last entry in the first column of Λ° , s the last entry in the first row of Λ° , and t the last entry in the second column of Λ° , as shown in Figure 3.1.

1	$r+1$	$r+2$...	u	s
2	$s+1$	$t+1$...	v	...		
⋮	⋮						
⋮	t						
⋮							
r							

Figure 2: The first two principal hooks of the hook tableau Λ°

We now continue this proof by considering three cases and showing the appropriate divisibility in each.

(i) If $c_v(\Lambda^\circ) < 0$ (i.e. u and v are in the first column of Λ°) then $v = u + 1$ and $F_{\Lambda^\circ}(z_1, \dots, z_n)$ can be written as $F_{\Lambda^\circ}(z_1, \dots, z_n) = f_{uv}(z_u + c_u(\Lambda^\circ), z_v + c_v(\Lambda^\circ)) \cdot F$.

Starting with $F_{\Lambda^\circ}(z_1, \dots, z_n)$ written in the ordering described in Proposition 3.4 and simply moving the term $f_{u,v}(z_u + c_u(\Lambda^\circ), z_v + c_v(\Lambda^\circ))$ to the left results in all the singularity terms in the product F remaining tied to the same triple terms as originally described. Therefore we may still form regular triples for each singularity in F , and hence F is regular at $z_1 = z_2 = \dots = z_n$.

So by considering this expression for $F_{\Lambda^\circ}(z_1, \dots, z_n)$ at $z_1 = z_2 = \dots = z_n$ we see that F_{Λ° will be divisible on the left or right by $f_{uv}(c_u(\Lambda^\circ), c_v(\Lambda^\circ)) = (1 - (uv))$.

(ii) If $c_v(\Lambda^\circ) = 0$ then $v = s + 1$, and $F_{\Lambda^\circ}(z_1, \dots, z_n)$ can be written as

$$F_{\Lambda^\circ}(z_1, \dots, z_n) = \prod_{i=u, \dots, s}^{\leftarrow} f_{i, s+1}(z_i + c_i(\Lambda^\circ), z_{s+1} + c_{s+1}(\Lambda^\circ)) \cdot F'.$$

Again, starting with the ordering described in Proposition 3.4, this results in all the singularity terms in the product F' remaining tied to the same triple terms as originally described in that ordering. Hence F' is regular at $z_1 = z_2 = \dots = z_n$. And so F_{Λ° is divisible on the left by

$$\prod_{i=u, \dots, s}^{\leftarrow} f_{i, s+1}(c_i(\Lambda^\circ), c_{s+1}(\Lambda^\circ)).$$

(iii) If $c_v(\Lambda^\circ) > 0$ (i.e. v is above the steps) then $f_{uv}(z_u + c_u(\Lambda^\circ), z_v + c_v(\Lambda^\circ))$ is tied to the singularity $f_{u-1, v}(z_{u-1} + c_{u-1}, z_v + c_v(\Lambda^\circ))$ as a triple term. To show divisibility by $f_{uv}(z_u + c_u(\Lambda^\circ), z_v + c_v(\Lambda^\circ))$ in this case we need an alternative expression for $F_{\Lambda^\circ}(z_1, \dots, z_n)$ that is regular when $z_1 = z_2 = \dots = z_n$. Define a permutation τ as follows,

$$\begin{aligned} \tau &= \prod_{i=u, \dots, s}^{\rightarrow} \left(\prod_{j=s+1, \dots, v}^{\leftarrow} (ij) \right) \\ &= \begin{pmatrix} 1 & 2 & \dots & u-1 & u & u+1 & \dots & \dots & \dots & \dots & v-1 & v & v+1 & \dots & n \\ 1 & 2 & \dots & u-1 & s+1 & s+2 & \dots & v-1 & v & u & u+1 & \dots & s-1 & s & v+1 & \dots & n \end{pmatrix} \end{aligned}$$

From the definition of C_1 in (27) we now define $C'_1 = \tau C_1$, where τ acts on the indices of the product C_1 such that

$$\tau C_1 = \prod_{j=1}^n \left(\prod_{i=1}^r g_{i, \tau \cdot j} \right).$$

For the rest of this proof we will simply write f_{ij} instead of $f_{ij}(z_i + c_i(\Lambda^\circ), z_j + c_j(\Lambda^\circ))$. Define R'_1 as,

$$\begin{aligned}
R'_1 &= \overleftarrow{\prod}_{i=r+2,\dots,u-1} \left(\overrightarrow{\prod}_{j=s+1,\dots,v} f_{ij} \right) \cdot \overrightarrow{\prod}_{i=s+1,\dots,t-1} \left(\overrightarrow{\prod}_{j=i+1,\dots,t} f_{ij} \right) \cdot \left(\overleftarrow{\prod}_{j=s+1,\dots,t} f_{r+1,j} \right) \\
&\times \left(\overrightarrow{\prod}_{j=t+1,\dots,v} f_{r+1,j} \right) \cdot \overrightarrow{\prod}_{i=r+1,\dots,s-1} \left(\overrightarrow{\prod}_{j=i+1,\dots,s} f_{ij} \right) \cdot \overrightarrow{\prod}_{j=v+1,\dots,n} \left(\overrightarrow{\prod}_{i=r+1,\dots,s} f_{ij} \right).
\end{aligned}$$

Finally, define C'_2 as,

$$C'_2 = \overrightarrow{\prod}_{j=t+1,\dots,n} \left(\overrightarrow{\prod}_{i=s+1,\dots,t} f_{ij} \right).$$

Then,

$$F_{\Lambda^\circ}(z_1, \dots, z_n) = \overleftarrow{\prod}_{i=u,\dots,s} \left(\overrightarrow{\prod}_{j=s+1,\dots,v} f_{ij} \right) \cdot C'_1 R'_1 C'_2 R_2 \cdot \prod_{i=3}^d C_i R_i,$$

where d is the number of principal hooks of λ .

The product $C'_1 R'_1 C'_2 R_2 \cdot \prod C_i R_i$ is regular at $z_1 = z_2 = \dots = z_n$ since, as before, for any singularity (p, q) the terms $f_{pq} f_{p+1,q}$ can be replaced by the triple $\frac{1}{2} f_{p,p+1} f_{pq} f_{p+1,q}$ – except in the expression R'_1 where the terms $f_{pl} f_{pq}$ are replaced by $\frac{1}{2} f_{pl} f_{pq} f_{lq}$, where l is the entry to the immediate left of q . Note that $l = q - 1$ when $c_q(\Lambda^\circ) > 1$ and $l = s + 1$ when $c_q(\Lambda^\circ) = 1$.

And so by letting $z_1 = z_2 = \dots = z_n$ we see that F_{Λ° is divisible on the left by

$$\overleftarrow{\prod}_{i=u,\dots,s} \left(\overrightarrow{\prod}_{j=s+1,\dots,v} f_{ij}(c_i(\Lambda^\circ), c_j(\Lambda^\circ)) \right).$$

■

Proposition 3.10 *Suppose the numbers $u < v$ stand next to each other in the same row of the hook tableau Λ° of shape λ . Let r be the last entry in the column containing u . If $c_u(\Lambda^\circ) > 0$ then the element $F_{\Lambda^\circ} \in \mathbb{C}S_n$ is divisible on the left and on the right by $f_{u,v}(c_u(\Lambda^\circ), c_v(\Lambda^\circ)) = 1 + (uv)$. If $c_u(\Lambda^\circ) \leq 0$ then the element $F_{\Lambda^\circ} \in \mathbb{C}S_n$ is divisible on the left by the product*

$$\overleftarrow{\prod}_{i=u,\dots,r} \left(\overrightarrow{\prod}_{j=r+1,\dots,v} f_{ij}(c_i(\Lambda^\circ), c_j(\Lambda^\circ)) \right)$$

Proof. Suppose u is to the immediate left of v in some row of Λ° . As in the proof of Proposition 3.9, we need only consider (u, v) such that u is in the first row or first column of Λ° . Let r be the last entry in the first column of Λ° and s the last entry in the first row of Λ° .

As in the proof of Proposition 3.9, we consider three cases.

(i) If $c_u(\Lambda^\circ) > 0$ (i.e. u and v are in the first row of Λ°) then $v = u + 1$ and $F_{\Lambda^\circ}(z_1, \dots, z_n)$ can be written as $F_{\Lambda^\circ}(z_1, \dots, z_n) = f_{uv}(z_u + c_u(\Lambda^\circ), z_v + c_v(\Lambda^\circ)) \cdot F$. Singularity terms in the product F remaining tied to the same triple terms as originally described in Proposition 3.4, hence F is regular at $z_1 = z_2 = \dots = z_n$. By considering this expression for $F_{\Lambda^\circ}(z_1, \dots, z_n)$ at $z_1 = z_2 = \dots = z_n$ we see that F_{Λ° will be divisible on the left/right by $f_{uv}(c_u(\Lambda^\circ), c_v(\Lambda^\circ)) = (1 + (uv))$.

(ii) If $c_u(\Lambda^\circ) = 0$ then $u = 1$, $v = r + 1$, and $F_{\Lambda^\circ}(z_1, \dots, z_n)$ can be written as

$$F_{\Lambda^\circ}(z_1, \dots, z_n) = \prod_{i=1, \dots, r}^{\leftarrow} f_{i, r+1}(z_i + c_i(\Lambda^\circ), z_{r+1} + c_{r+1}(\Lambda^\circ)) \cdot F'.$$

Again, singularities in F' remain tied to the same triple terms as originally described in Proposition 3.4. And so F_{Λ° is divisible on the left by

$$\prod_{i=1, \dots, r}^{\leftarrow} f_{i, r+1}(c_i(\Lambda^\circ), c_{r+1}(\Lambda^\circ)).$$

(iii) If $c_u(\Lambda^\circ) < 0$ (i.e. v is below the steps) then $f_{uv}(z_u + c_u(\Lambda^\circ), z_v + c_v(\Lambda^\circ))$ is tied to the singularity $f_{u-1, v}(z_{u-1} + c_{u-1}, z_v + c_v(\Lambda^\circ))$ as a triple term.

For the rest of this proof we will simply write f_{ij} instead of $f_{ij}(z_i + c_i(\Lambda^\circ), z_j + c_j(\Lambda^\circ))$. Define C_1'' as,

$$\begin{aligned} C_1'' &= \prod_{i=2, \dots, u-1}^{\leftarrow} \left(\prod_{j=r+1, \dots, v}^{\rightarrow} f_{ij} \right) \cdot \prod_{i=r+1, \dots, s-1}^{\rightarrow} \left(\prod_{j=i+1, \dots, s}^{\rightarrow} f_{ij} \right) \cdot \left(\prod_{j=r+1, \dots, s}^{\leftarrow} f_{1, j} \right) \\ &\times f_{1, s+1} \cdot \left(\prod_{i=r+1, \dots, s}^{\rightarrow} f_{i, s+1} \right) \cdot \prod_{j=s+2, \dots, v}^{\rightarrow} f_{1, j} \cdot \prod_{i=1, \dots, r-1}^{\rightarrow} \left(\prod_{j=i+1, \dots, r}^{\rightarrow} f_{ij} \right) \\ &\times \prod_{j=v+1, \dots, n}^{\rightarrow} \left(\prod_{i=1, \dots, r}^{\rightarrow} f_{ij} \right), \end{aligned}$$

and define R_1'' as,

$$R_1'' = \prod_{j=s+2, \dots, n}^{\rightarrow} \left(\prod_{i=r+1, \dots, s}^{\rightarrow} f_{ij} \right).$$

Then,

$$F_{\Lambda^\circ}(z_1, \dots, z_n) = \prod_{i=u, \dots, r}^{\leftarrow} \left(\prod_{j=r+1, \dots, v}^{\rightarrow} f_{ij} \right) \cdot C_1'' R_1'' \cdot \prod_{i=2}^d C_i R_i,$$

where d is the number of principal hooks of λ .

The product $C_1'' R_1'' \cdot \prod C_i R_i$ is regular at $z_1 = z_2 = \dots = z_n$ since, as before, for any singularity (p, q) the terms $f_{pq} f_{p+1, q}$ can be replaced by the triple $\frac{1}{2} f_{p, p+1} f_{pq} f_{p+1, q}$ – except in the expression C_1'' where $f_{1, s+1} f_{r+1, s+1}$ is replaced by $\frac{1}{2} f_{1, r+1} f_{1, s+1} f_{r+1, s+1}$, and $f_{p, q-1} f_{pq}$ is replaced by $\frac{1}{2} f_{p, q-1} f_{pq} f_{q-1, q}$ for all other singularities (p, q) in C_1'' .

And so by letting $z_1 = z_2 = \dots = z_n$ we see that F_{Λ° is divisible on the left by

$$\prod_{i=u, \dots, r}^{\leftarrow} \left(\prod_{j=r+1, \dots, v}^{\rightarrow} f_{ij}(c_i(\Lambda^\circ), c_j(\Lambda^\circ)) \right).$$

■

Let us now consider an example that allows us to see how the product

$F_{\Lambda^\circ}(z_1, \dots, z_n)$ is broken down in the proof of Proposition 3.9.

Example 3.11. We again consider the hook tableau of the Young diagram $\lambda = (3, 3, 2)$, as shown in Example 3.2.

We begin with the product $F_{\Lambda^\circ}(z_1, \dots, z_n)$ in the ordering described in Proposition 3.4. For simplicity we again write f_{pq} in place of the term $f_{pq}(z_p + c_p(\Lambda^\circ), z_q + c_q(\Lambda^\circ))$. We have also marked out the singularities in this expansion along with their triple terms, but no idempotents have yet been added which would form regular triples.

$$\begin{aligned} F_{\Lambda^\circ}(z_1, \dots, z_n) = & f_{12} f_{13} f_{23} f_{14} f_{24} f_{34} f_{15} f_{25} f_{35} (f_{16} f_{26}) f_{36} f_{17} (f_{27} f_{37}) f_{18} f_{28} f_{38} \\ & \cdot f_{45} f_{46} f_{56} f_{47} f_{57} (f_{48} f_{58}) \cdot f_{67} f_{68} f_{78} \end{aligned} \tag{30}$$

Let $u = 4$ and $v = 6$ in Proposition 3.9. Then by that proposition we may arrange the above product as follows. Notice since $c_v(\Lambda^\circ) = 0$ all singularity-triple term pairs remain the same.

$$F_{\Lambda^\circ}(z_1, \dots, z_n) = f_{56}f_{46} \cdot f_{12}f_{13}f_{23}(f_{16}f_{26})f_{36}f_{14}f_{24}f_{34}f_{15}f_{25}f_{35}f_{17}(f_{27}f_{37}) \\ f_{18}f_{28}f_{38} \cdot f_{45}f_{47}f_{57}(f_{48}f_{58}) \cdot f_{67}f_{68}f_{78}$$

We may now add the appropriate idempotents so that all singularities remain in regular triples. And so by considering the product at $z_1 = z_2 = \dots = z_n$ we have that F_{Λ° is divisible on the left by $(1 - (46))$, preceded only by invertible terms, as desired.

Now let $u = 3$ and $v = 7$ in Proposition 3.10. Then by that proposition we may arrange (30) as follows. Singularities in C_1 have been marked out with their alternative triple terms, while all other singularity-triple term pairs remain the same.

$$F_{\Lambda^\circ}(z_1, \dots, z_n) = f_{34}f_{35}f_{36}f_{37} \cdot f_{24}f_{25}(f_{26}f_{27}) \cdot f_{45} \cdot f_{13}(f_{14} \cdot f_{16}) \cdot f_{46}f_{56} \cdot f_{17} \\ \cdot f_{12}f_{13}f_{23} \cdot f_{18}f_{28}f_{38} \cdot f_{47}f_{57}(f_{48}f_{58}) \cdot f_{67}f_{68}f_{78}$$

In moving f_{37} to the left it is untied from the singularity f_{27} . So we must form new triples which are regular at $z_1 = z_2 = \dots = z_n$ by the method described in Proposition 3.10. Therefore, by considering the product at $z_1 = z_2 = \dots = z_n$, we have that F_{Λ° is divisible on the left by $(1 + (37))$, again preceded only by invertible terms, as desired. ■

Lemma 3.12 *Let σ_k be the adjacent transposition of k and $k + 1$. Let Λ and $\tilde{\Lambda}$ be tableaux of the same shape such that $k = \Lambda(a, b) = \Lambda(a + 1, b) - 1$ and $\tilde{k} = \tilde{\Lambda}(a, b) = \tilde{\Lambda}(a + 1, b) - 1$. Then $F_\Lambda \in \mathbb{C}S_n$ is divisible on the left by $1 - \sigma_k$ if and only if $F_{\tilde{\Lambda}} \in \mathbb{C}S_n$ is divisible on the left by $1 - \sigma_{\tilde{k}}$.*

Proof. Let σ be the permutation such that $\tilde{\Lambda} = \sigma \cdot \Lambda$. There is a decomposition $\sigma = \sigma_{i_N} \dots \sigma_{i_1}$ such that for each $M = 1, \dots, N - 1$ the tableau $\Lambda_M = \sigma_{i_M} \dots \sigma_{i_1} \cdot \Lambda$ is standard. Note that this decomposition is not necessarily reduced.

Denote F_Λ by $f_{k,k+1}(c_k(\Lambda), c_{k+1}(\Lambda)) \cdot F$. Then, by using the relations (15) and (16) and Proposition 3.4, we have the following chain of equalities:

$$\begin{aligned}
& f_{\tilde{k},\tilde{k}+1}(c_{\tilde{k}}(\tilde{\Lambda}), c_{\tilde{k}+1}(\tilde{\Lambda}))\sigma_{\tilde{k}} \cdot \prod_{M=1,\dots,N}^{\leftarrow} f_{i_{M+1},i_M}(c_{i_{M+1}}(\Lambda_M), c_{i_M}(\Lambda_M))\sigma_{i_M} \cdot F \\
&= \prod_{M=1,\dots,N}^{\leftarrow} \sigma_{i_M} f_{i_M,i_{M+1}}(c_{i_M}(\Lambda_M), c_{i_{M+1}}(\Lambda_M)) \cdot \sigma_k f_{k,k+1}(c_k(\Lambda), c_{k+1}(\Lambda)) \cdot F \\
&= \prod_{M=1,\dots,N}^{\leftarrow} \sigma_{i_M} f_{i_M,i_{M+1}}(c_{i_M}(\Lambda_M), c_{i_{M+1}}(\Lambda_M)) \cdot F_\Lambda \\
&= F_{\tilde{\Lambda}} \cdot \prod_{M=1,\dots,N}^{\leftarrow} f_{i_{M+1},i_M}(c_{i_{M+1}}(\Lambda_M), c_{i_M}(\Lambda_M))\sigma_{i_M}
\end{aligned}$$

Hence divisibility by $1 - \sigma_k$ for F_Λ implies its counterpart for the tableau $\tilde{\Lambda}$ and the index \tilde{k} , and vice versa. Here we also use the equalities

$$\begin{aligned}
f_{k,k+1}(c_k(\Lambda), c_{k+1}(\Lambda)) &= 1 - \sigma_k, \\
f_{\tilde{k},\tilde{k}+1}(c_{\tilde{k}}(\tilde{\Lambda}), c_{\tilde{k}+1}(\tilde{\Lambda})) &= 1 - \sigma_{\tilde{k}}.
\end{aligned}$$

■

Corollary 3.13 *If $k = \Lambda(a, b)$ and $k + 1 = \Lambda(a + 1, b)$ then the element $F_\Lambda \in \mathbb{C}S_n$ is divisible on the left and right by $1 - \sigma_k$. If $k = \Lambda(a, b)$ and $k + 1 = \Lambda(a, b + 1)$ then the element $F_\Lambda \in \mathbb{C}S_n$ is divisible on the left and right by $1 + \sigma_k$.*

Proof. By Proposition 3.7 divisibility on the left is equivalent to divisibility on the right. Let us show divisibility on the left.

Due to Lemma 3.12 it suffices to prove the first part of Corollary 3.13 for only one standard tableau Λ of shape λ . Therefore, using Proposition 3.9 and taking $\tilde{\Lambda}$ to be the hook tableau Λ° of shape λ we have shown the first part of Corollary 3.13 in the case $c_v(\Lambda) < 0$.

Next let $\Lambda^\circ(a, b) = u$, $\Lambda^\circ(a + 1, b) = v$ and s be the last entry in the row containing u . Then for $c_v(\Lambda^\circ) \geq 0$ Proposition 3.9 showed that $F_{\Lambda^\circ} \in \mathbb{C}S_n$ is

divisible on the left by

$$\prod_{i=u,\dots,s}^{\leftarrow} \left(\prod_{j=s+1,\dots,v}^{\rightarrow} f_{i,j}(c_i(\Lambda^\circ), c_j(\Lambda^\circ)) \right) \quad (31)$$

Put $k = u + v - s - 1$ and let Λ be the tableau such that Λ° is obtained from the tableau $\sigma_k \cdot \Lambda$ by the permutation

$$\sigma = \prod_{i=u,\dots,s}^{\leftarrow} \left(\prod_{j=s+1,\dots,v}^{\rightarrow} \sigma_{i+j-s-1} \right).$$

The tableau Λ is standard. Moreover, then $\Lambda(a, b) = k$ and $\Lambda(a+1, b) = k+1$. Note that the rightmost factor in the product (31), corresponding to $i = u$ and $j = v$, is

$$f_{u,v}(c_u(\Lambda^\circ), c_v(\Lambda^\circ)) = 1 - (uv).$$

Denote by F the product of all factors in (31) but the rightmost one. Further, denote by F' the product obtained by replacing each factor in F

$$f_{i,j}(c_i(\Lambda^\circ), c_j(\Lambda^\circ))$$

respectively by

$$\sigma_{i+j-s-1} f_{i+j-s-1, i+j-s}(c_i(\Lambda^\circ), c_j(\Lambda^\circ)),$$

and denote by G' the product obtained by replacing each factor in F by

$$f_{i+j-s, i+j-s-1}(c_j(\Lambda^\circ), c_i(\Lambda^\circ)) \sigma_{i+j-s-1}.$$

The element $F \in \mathbb{C}S_n$ is invertible, and we have

$$F \sigma \sigma_k \cdot F_\Lambda = F' \cdot F_\Lambda = F_{\Lambda^\circ} \cdot G' = F \cdot (1 - (uv)) \cdot (C'_1 R'_1 C'_2 R_2 \prod C_i R_i) \cdot G',$$

where the final equality is as described in Proposition 3.9. Finally we use the identity $(uv)\sigma = \sigma\sigma_k$. Therefore the divisibility of the element F_{Λ° on the left by the product (31) will imply the divisibility of the element F_Λ on the left by $1 - \sigma_k$.

This shows the required divisibility for the tableau $\Lambda = \sigma\sigma_k \cdot \Lambda^\circ$. Using Lemma 3.12 again concludes the proof of the first part of Corollary 3.13.

The second part of Corollary 3.13 may be shown similarly. ■

We may now complete the proof of Theorem 3.1.

Proposition 3.14 *The element F_Λ is the diagonal matrix element for Λ .*

Proof. Let $F_\Lambda = \sum_{\sigma \in S_n} \alpha_\sigma(\Lambda) \cdot \sigma$, where the coefficients $\alpha_\sigma(\Lambda)$ are in \mathbb{C} .

Let σ_k be the adjacent transposition of k and $k + 1$. For $\sigma_k \Lambda$ nonstandard we have, by Proposition, 3.13

$$\sigma_k F_\Lambda = F_\Lambda = F_\Lambda \sigma_k, \text{ for all } \sigma_k \in R(\Lambda), \text{ and,}$$

$$\sigma_k F_\Lambda = -F_\Lambda = F_\Lambda \sigma_k, \text{ for all } \sigma_k \in C(\Lambda).$$

Comparing coefficients gives us;

$$\alpha_{\sigma_k \sigma}(\Lambda) = \alpha_\sigma(\Lambda), \text{ for all } \sigma_k \in R(\Lambda), \text{ and}$$

$$\alpha_{\sigma_k \sigma}(\Lambda) = -\alpha_\sigma(\Lambda), \text{ for all } \sigma_k \in C(\Lambda).$$

For $\Lambda' = \sigma_k \Lambda$ standard we have, by Proposition 3.4, the identity

$$(1 - d_k(\Lambda')^2) F_\Lambda = (\sigma_k - d_k(\Lambda')) F_{\Lambda'} (\sigma_k - d_k(\Lambda')), \quad (32)$$

where $d_k(\Lambda) = (c_{k+1}(\Lambda) - c_k(\Lambda))^{-1}$.

Comparing coefficients here gives us;

$$\begin{aligned} & (1 - d_k(\Lambda')^2) \alpha_{\sigma_k \sigma}(\Lambda) \\ &= \alpha_{\sigma_k \sigma}(\Lambda') - d_k(\Lambda') \alpha_{\sigma_k \sigma \sigma_k}(\Lambda') - d_k(\Lambda') \alpha_\sigma(\Lambda') + d_k(\Lambda')^2 \alpha_{\sigma_k \sigma}(\Lambda'). \end{aligned}$$

By Proposition 3.6 $\alpha_1(\Lambda) = 1$, therefore these identities completely determine the coefficients of F_Λ . In particular we see $\alpha_{\sigma_k} = d_k(\Lambda)$ for all adjacent transpositions σ_k .

On the other hand, consider the inner product of (7). By definition $(v_\Lambda, v_\Lambda) = 1$ and $(v_\Lambda, v_{\Lambda'}) = 0$ for $\Lambda \neq \Lambda'$.

Then by (10) we have for $\sigma_k\Lambda$ nonstandard;

$$(v_\Lambda, \sigma_k v_\Lambda) = 1 \text{ for all } \sigma_k \in R(\Lambda), \text{ and,}$$

$$(v_\Lambda, \sigma_k v_\Lambda) = -1 \text{ for all } \sigma_k \in C(\Lambda).$$

And if $\sigma_k\Lambda$ standard;

$$\begin{aligned} (v_\Lambda, \sigma_k v_\Lambda) &= (v_\Lambda, d_k(\Lambda)v_\Lambda + \sqrt{1 - d_k(\Lambda)^2}v_{\sigma_k\Lambda}) \\ &= d_k(\Lambda). \end{aligned}$$

We also have the equivalent identity for (32) for diagonal matrix elements, (see (12)). Hence the coefficient of σ in the expression for the diagonal matrix element is the same as the coefficient $\alpha_\sigma(\Lambda)$ above for all $\sigma \in S_n$. \blacksquare

Finally, let us consider the Giambelli identity, (23), and its dual, (24), for a diagram λ . We obtain a decomposition of the induced representation of the tensor product of representations of hook shapes, where these hook shapes are the principal hooks of λ .

Proposition 3.15 *The coefficient $D_{\lambda\lambda}$ in (24) is equal to 1.*

Proof. Consider the Littlewood-Richardson coefficient $c_{\mu\nu}^\lambda$. This is the coefficient of $s_\lambda(\mathbf{x})$ in the decomposition of $s_\mu(\mathbf{x})s_\nu(\mathbf{x})$ and is equal to the number of ways to fill the skew tableau λ/μ with content ν such that the filling is a reverse lattice permutation.

Let $\lambda = (\alpha_1, \dots, \alpha_d | \beta_1, \dots, \beta_d)$ and let μ be a partition of $\sum_{i=1}^k h_i$, where h_i is the length of the i^{th} principal hook. If μ is not contained in

$$(\alpha_1, \dots, \alpha_{k+1} | \beta_1, \dots, \beta_{k+1}) \text{ then } c_{\mu(\alpha_{k+1} | \beta_{k+1})}^{(\alpha_1, \dots, \alpha_{k+1} | \beta_1, \dots, \beta_{k+1})} = 0.$$

If μ is contained in $(\alpha_1, \dots, \alpha_{k+1})$ then either $\mu = (\alpha_1, \dots, \alpha_k | \beta_1, \dots, \beta_k)$ and $c_{\mu(\alpha_{k+1} | \beta_{k+1})}^{(\alpha_1, \dots, \alpha_{k+1} | \beta_1, \dots, \beta_{k+1})} = 1$, or $s_\mu(\mathbf{x})$ has coefficient zero in the decomposition of

$$s_{(\alpha_1 | \beta_1)}(\mathbf{x})s_{(\alpha_2 | \beta_2)}(\mathbf{x}) \cdots s_{(\alpha_k | \beta_k)}(\mathbf{x}).$$

The same argument holds for the base case so, by induction, $s_\lambda(\mathbf{x})$ appears with coefficient 1 in the decomposition of $s_{(\alpha_1 | \beta_1)}(\mathbf{x})s_{(\alpha_2 | \beta_2)}(\mathbf{x}) \cdots s_{(\alpha_d | \beta_d)}(\mathbf{x})$. \blacksquare

Example 3.16. Once more let Λ be a standard tableau of shape $\lambda = (3, 3, 2)$, or in the alternative notation used in the Giambelli identity, $\lambda = (2, 1|3, 2)$. As described before, the Giambelli identity gives us a way to write the Schur function $s_\lambda(\mathbf{x})$ as a determinant of Schur functions of hook shape,

$$s_{(2,1|3,2)}(\mathbf{x}) = \begin{vmatrix} s_{(2|3)}(\mathbf{x}) & s_{(2|2)}(\mathbf{x}) \\ s_{(1|4)}(\mathbf{x}) & s_{(1|2)}(\mathbf{x}) \end{vmatrix} = \begin{vmatrix} s_{\begin{array}{|c|} \hline \square\square\square \\ \square \\ \hline \end{array}} & s_{\begin{array}{|c|} \hline \square\square\square \\ \hline \end{array}} \\ s_{\begin{array}{|c|} \hline \square\square \\ \square \\ \hline \end{array}} & s_{\begin{array}{|c|} \hline \square\square \\ \hline \end{array}} \end{vmatrix},$$

or dually,

$$\begin{aligned} s_{(2|3)}(\mathbf{x})s_{(1|2)}(\mathbf{x}) &= s_{(2,1|3,2)}(\mathbf{x}) + s_{(2,1|4,1)}(\mathbf{x}) + s_{(2|5,1)}(\mathbf{x}) + s_{(2|4,2)}(\mathbf{x}) + s_{(3,1|3,1)}(\mathbf{x}) \\ &\quad + s_{(3|3,2)}(\mathbf{x}) + 2s_{(3|4,1)}(\mathbf{x}) + s_{(3|5)}(\mathbf{x}) + s_{(4|3,1)}(\mathbf{x}) + s_{(4|4)}(\mathbf{x}). \end{aligned}$$

And therefore, in terms of modules, we obtain the following identity;

$$\begin{aligned} \text{Ind}_{S_5 \times S_3}^{S_8} V_{(2|3)} \otimes V_{(1|2)} &= V_{(2,1|3,2)} \oplus V_{(2,1|4,1)} \oplus V_{(2|5,1)} \oplus V_{(2|4,2)} \oplus V_{(3,1|3,1)} \\ &\quad \oplus V_{(3|3,2)} \oplus 2V_{(3|4,1)} \oplus V_{(3|5)} \oplus V_{(4|3,1)} \oplus V_{(4|4)}. \end{aligned}$$

Here, the induced module on the left hand side may be realised as the left ideal of $\mathbb{C}S_n$ generated by $F_\Lambda(z_1, \dots, z_8)$ on \mathcal{H}_Λ such that $z_i - z_j \notin \mathbb{Z}$ when i and j are in different principal hooks of λ . Since λ only has two principal hooks we only need two auxiliary parameters in the hook fusion procedure. Letting these parameters be equal gives us the diagonal matrix element F_Λ which generates the irreducible representation corresponding to λ , $V_{(2,1|3,2)}$, which appears in the decomposition above with coefficient 1. \blacksquare

4 Representations of degenerate affine Hecke algebras

We may now use our hook fusion procedure of Chapter 3 to calculate diagonal matrix elements computationally. This is only possible thanks to the minimisation of the parameters, making such calculations easier. We then use these elements in the construction of the eigenvalues of a certain operator which have been conjectured to provide the irreducibility criterion of certain representations. We provide supporting evidence for this conjecture, which includes calculating eigenvalues from a more general construction which have never been calculated before.

4.1 The mixed hook length formula

In this chapter we work with the degenerate affine Hecke algebra H'_n of type A , for a description of degenerate affine Hecke algebras of other types see [C3], and was introduced by V. Drinfeld in [D]. As before, let σ_k be the transposition of k and $k + 1$. Then the complex associative algebra H'_n is generated by the symmetric group algebra $\mathbb{C}S_n$ and the pairwise commuting elements y_1, \dots, y_n with the cross relations

$$\begin{aligned}\sigma_i y_j &= y_j \sigma_i, \quad j \neq i, i + 1, \\ \sigma_i y_i &= y_{i+1} \sigma_i - 1.\end{aligned}$$

Let V_λ be the irreducible $\mathbb{C}S_n$ -module corresponding to the partition λ . We may also regard V_λ as a H'_n -module by sending the element y_k to the Jucys-Murphy element $X_k = (1 \ k) + (2 \ k) + \dots + (k - 1 \ k) \in \mathbb{C}S_n$ for each $k = 1, \dots, n - 1$. For any number $z \in \mathbb{C}$ there is also an automorphism of H'_n which acts as the identity on the subalgebra $\mathbb{C}S_n$, but such that $y_k \mapsto y_k + z$ for each $k = 1, \dots, n$. We will denote by $V_\lambda(z)$ the H'_n -module obtained by pulling V_λ back through this automorphism. The module $V_\lambda(z)$ is irreducible by construction and can be realised as the left ideal in $\mathbb{C}S_n$ generated by the diagonal matrix element F_Λ , for some standard tableau Λ of shape λ . The

subalgebra $\mathbb{C}S_n \subset H'_n$ acts here via left multiplication, and the action of the generators y_1, \dots, y_n is $y_k \cdot F_\Lambda = (c_k(\Lambda) + z)F_\Lambda$ by (6).

Consider the algebra $H'_n \otimes H'_m$. It is isomorphic to the subalgebra in H'_{n+m} generated the transpositions (pq) , where $1 \leq p < q \leq n$ or $n+1 \leq p < q \leq n+m$, along with the elements y_1, \dots, y_{n+m} . For any partition μ of m and any number $w \in \mathbb{C}$ take the corresponding H'_m -module $V_\mu(w)$. Now consider the H'_{n+m} -module W induced from the $H'_n \otimes H'_m$ -module $V_\Lambda(z) \otimes V_\mu(w)$. Let M be a standard tableaux of shape μ and set $\overline{F}_M = \epsilon_n(F_M)$, where ϵ is as defined in (21). Then the module W may be realised as the left ideal in $\mathbb{C}S_{n+m}$ generated by the product $F_\Lambda \overline{F}_M$. The action of the generators y_1, \dots, y_{n+m} in this ideal can be determined using

$$\begin{aligned} y_k \cdot F_\Lambda \overline{F}_M &= (c_k(\Lambda) + z)F_\Lambda \overline{F}_M \quad \text{for each } k = 1, \dots, n; \\ y_{n+k} \cdot F_\Lambda \overline{F}_M &= (c_k(M) + w)F_\Lambda \overline{F}_M \quad \text{for each } k = 1, \dots, m. \end{aligned}$$

If $z - w \notin \mathbb{Z}$, then the module W is irreducible, see [C1].

Now introduce the ordered products in the symmetric group algebra $\mathbb{C}S_{n+m}$

$$\begin{aligned} R_{\Lambda M}(z, w) &= \prod_{i=1, \dots, n}^{\rightarrow} \left(\prod_{j=1, \dots, m}^{\leftarrow} f_{i, n+j}(z + c_i(\Lambda), w + c_j(M)) \right), \\ R'_{\Lambda M}(z, w) &= \prod_{i=1, \dots, n}^{\leftarrow} \left(\prod_{j=1, \dots, m}^{\rightarrow} f_{i, n+j}(z + c_i(\Lambda), w + c_j(M)) \right). \end{aligned}$$

We keep to the assumption $z - w \notin \mathbb{Z}$. Applying Theorem 3.1 and using relations (15) and (16) repeatedly, we get

$$F_\Lambda \overline{F}_M R_{\Lambda M}(z, w) = R'_{\Lambda M}(z, w) F_\Lambda \overline{F}_M. \quad (33)$$

Hence the right multiplication in $\mathbb{C}S_{n+m}$ by $R_{\Lambda M}(z, w)$ preserves the left ideal W .

Consider the operator of the right multiplication in $\mathbb{C}S_{n+m}$ by $R_{\Lambda M}(z, w)$. This operator preserves the subspace W due to (33). The restriction of this operator to W will be denoted J . Furthermore, J commutes with the action of H'_{n+m} , in other words J is a H'_{n+m} -module homomorphism, see [N2]. Now

regard W as a $\mathbb{C}S_{n+m}$ -module only. Then the subalgebra $\mathbb{C}S_{n+m} \subset H'_{n+m}$ acts on $W \subset \mathbb{C}S_{n+m}$ via left multiplication and, under this action, W splits into irreducible components according to the Littlewood-Richardson rule [MD]. Let ν be any partition of $n + m$ such that the irreducible $\mathbb{C}S_{n+m}$ -module V_ν appears in W with multiplicity one. The homomorphism $J : W \rightarrow W$ preserves the subspace $V_\nu \subset W$ and therefore, by Schur's Lemma, acts there as multiplication by a certain number from \mathbb{C} . Denote this number $r'_{\lambda\mu}(z, w)$, it depends on z and w as a rational function of $z - w$, but does not depend on the choice of tableaux Λ and M . We will now compute the eigenvalues $r'_{\lambda\mu}(z, w)$ of J for certain ν .

First let us observe the following general property of the eigenvalues $r'_{\lambda\mu}(z, w)$. Consider the H'_{n+m} -module W' induced from the $H'_m \otimes H'_n$ -module $V_\mu(w) \otimes V_\lambda(z)$. Similar to the definition of J , one can define a H'_{n+m} -module homomorphism $J' : W' \rightarrow W'$ as the restriction to W' of the operator of right multiplication in $\mathbb{C}S_{n+m}$ by $R_{M\Lambda}(w, z)$. There is a unique irreducible $\mathbb{C}S_{n+m}$ -submodule $V'_\nu \subset W'$ equivalent to $V_\nu \subset W$. By considering the corresponding eigenvalue $r'_{\mu\lambda}(w, z)$ of the operator J' we have the following identity derived in [N2].

Proposition 4.1

$$r'_{\lambda\mu}(z, w)r'_{\mu\lambda}(w, z) = \prod_{i=1}^{\lambda'_1} \prod_{k=1}^{\mu'_1} \frac{(z - w + \lambda_i - i + k)(z - w - \mu_k - i + k)}{(z - w + \lambda_i - \mu_k - i + k)(z - w - i + k)}.$$

Furthermore, by the definition of J , we have the second identity $r'_{\lambda\mu}(z, w) = r'_{\lambda'\mu'}(w, z)$, where λ' , μ' and ν' denote the conjugates of λ , μ and ν . We now continue by constructing certain partitions ν such that their corresponding irreducible $\mathbb{C}S_{n+m}$ -modules V_ν appear in W with multiplicity one.

Choose any sequence $a_1, \dots, a_{\lambda'_1} \in \mathbb{N}$ of pairwise distinct natural numbers. Note that the sequence does not need to be increasing. Consider the partition μ as an infinite sequence with finitely many non-zero terms. Define an infinite

sequence $\gamma = (\gamma_1, \gamma_2, \dots)$ by

$$\gamma_{a_i} = \mu_{a_i} + \lambda_i, \quad i = 1, \dots, \lambda'_1;$$

$$\gamma_a = \mu_a, \quad a \neq a_1, \dots, a_{\lambda'_1}.$$

If $\gamma_1 \geq \gamma_2 \geq \dots$ then γ is a partition of $n + m$. One may think of this partition as being constructed from the Young diagram of μ after adding the rows of λ to the rows of μ in some order.

Similarly, if $b_1, \dots, b_{\lambda_1} \in \mathbb{N}$ is a sequence of pairwise distinct natural numbers, we may construct an infinite sequence $\delta' = (\delta'_1, \delta'_2, \dots)$ by

$$\delta'_{b_j} = \mu'_{b_j} + \lambda'_j, \quad j = 1, \dots, \lambda_1;$$

$$\delta'_b = \mu'_b, \quad b \neq b_1, \dots, b_{\lambda_1}.$$

If $\delta'_1 \geq \delta'_2 \geq \dots$ then δ' is a partition of $n + m$, as is its conjugate δ . One may think of the partition δ as being constructed from the Young diagram of μ after adding the columns of λ to the columns of μ in some order.

For such partitions, the irreducible $\mathbb{C}S_{n+m}$ -modules V_γ and V_δ appear in W with multiplicity one. And the corresponding eigenvalues $r_{\lambda\mu}^\gamma(z, w)$ and $r_{\lambda\mu}^\delta(z, w)$ of the operator $J : W \rightarrow W$ have the following combinatorial description due to [N2].

Theorem 4.2 (Nazarov)

$$r_{\lambda\mu}^\gamma(z, w) = \prod_{(i,j)} \frac{z - w - \lambda'_j - \mu_{a_i} + a_i + j - 1}{z - w - i + j};$$

$$r_{\lambda\mu}^\delta(z, w) = \prod_{(i,j)} \frac{z - w + \lambda_i + \mu'_{b_j} - i - b_j + 1}{z - w - i + j}$$

where the products are taken over all boxes (i, j) of the Young diagram λ .

So far we have assumed $z - w \notin \mathbb{Z}$, in which case the H'_{n+m} -module W is irreducible. Now let us consider $z - w \in \mathbb{Z}$. If we multiply the terms of $R_{\Lambda M}(z, w)$ by their common denominator we will get a non-zero operator such that, for certain values of $z - w$, acts on the subspace V_ν with an eigenvalue

of zero. Therefore the kernel of this operator is a proper non-trivial H'_{n+m} -submodule of W , and hence W is reducible.

For example, there are two distinguished irreducible components of the $\mathbb{C}S_{n+m}$ -module W which always have multiplicity one. They correspond to partitions

$$\lambda + \mu = (\lambda_1 + \mu_1, \lambda_2 + \mu_2, \dots) \quad \text{and} \quad (\lambda' + \mu')' = (\lambda'_1 + \mu'_1, \lambda'_2 + \mu'_2, \dots)'.$$

Denote by $h_{\lambda\mu}(z, w)$ the ratio of the corresponding eigenvalues of J , $r_{\lambda\mu}^{\lambda+\mu}(z, w)/r_{\lambda\mu}^{(\lambda'+\mu)'}(z, w)$. This ratio does not depend on the normalisation of the operator J . We then have the following corollary to Theorem 4.2.

Corollary 4.3

$$h_{\lambda\mu}(z, w) = \prod_{(i,j)} \frac{z - w - \lambda'_j - \mu_i + i + j - 1}{z - w + \lambda_i + \mu_j - i - j + 1}$$

where the product is taken over all boxes (i, j) belonging to the intersection of the diagrams λ and μ .

If $\lambda = \mu$ the numbers $\lambda_i + \lambda'_j - i - j + 1$ are called the *hook lengths* of the diagram λ , [MD]. If $\lambda \neq \mu$ the numbers

$$\lambda_i + \mu'_j - i - j + 1 \quad \text{and} \quad \lambda'_j + \mu_i - i - j + 1$$

in the above fraction may be called the *mixed hook lengths* of the first and second kind respectively. Both these numbers are positive for any box (i, j) in the intersection of λ and μ .

Then, by Corollary 4.3, W is reducible if $z - w$ is either a mixed hook length of the first or second kind relative to λ and μ . When $\lambda = \mu$, the corollary implies that the module W is reducible if $|z - w|$ is a hook length of λ . Furthermore, the module W is irreducible for all remaining values $|z - w|$, [LNT].

The irreducibility criterion of the module W for arbitrary λ and μ has also been given in [LNT]. This work shows that the module W is reducible if and only if the difference $z - w$ belongs to a certain finite subset $\mathcal{S}_{\lambda\mu} \subset \mathbb{Z}$ determined in [LZ]. Denote by $\mathcal{D}_{\lambda\mu}$ the set of all zeros and poles of the rational

functions $r_{\lambda\mu}^{\lambda+\mu}(z, w)/r_{\lambda\mu}^{\nu}(z, w)$ in $z - w$, where ν ranges over all partitions γ and δ described above. Then $\mathcal{D}_{\lambda\mu} \subseteq \mathcal{S}_{\lambda\mu}$.

At the end of [N2] it was conjectured that the set $\mathcal{S}_{\lambda\mu}$ is equal to the set of all zeros and poles of the rational functions $r_{\lambda\mu}^{\lambda+\mu}(z, w)/r_{\lambda\mu}^{\nu}(z, w)$ in $z - w$, where ν ranges over all partitions of $n + m$ such that the $\mathbb{C}S_{n+m}$ -module V_{ν} appears in W with multiplicity one. The next section provides supporting evidence for this conjecture using a combination of the results in this section and computational methods.

4.2 Non mixed hook calculations

Given a partition λ of n and a partition μ of m , we call a partition ν of $n + m$ of *mixed hook type* if it can be obtained either

- (i) by adding rows of λ to μ ;
- (ii) by adding columns of λ to μ ;
- (iii) by adding rows of μ to λ ;
- (iv) by adding columns of μ to λ .

We may calculate the eigenvalue $r_{\lambda\mu}^{\nu}(z, w)$ for partitions ν of mixed hook type (i) and (ii) by using Theorem 4.2, and those of type (iii) and (iv) by using a combination of Theorem 4.2 and Proposition 4.1.

Let $u = z - w$. The smallest examples of a partition ν that is *not* of mixed hook type, while having Littlewood-Richardson coefficient $c_{\lambda\mu}^{\nu} = 1$, occurs when λ and μ are certain partitions of 4. There are only six such partitions, for which we have calculated the corresponding eigenvalues $r_{\lambda\mu}^{\nu}(u)$.

Result 4.4

$$\begin{array}{llll}
 1. & \lambda = \begin{array}{|c|c|c|} \hline \square & \square & \square \\ \hline \square & & \end{array} & \mu = \begin{array}{|c|c|c|} \hline \square & \square & \square \\ \hline \square & & \end{array} & \nu = \begin{array}{|c|c|c|c|} \hline \square & \square & \square & \square \\ \hline \square & \square & & \end{array} & r_{\lambda\mu}^\nu(u) = \frac{(u-4)(u-1)}{(u)(u+1)} \\
 2. & \lambda = \begin{array}{|c|c|c|} \hline \square & \square & \square \\ \hline \square & & \end{array} & \mu = \begin{array}{|c|c|} \hline \square & \square \\ \hline \square & \square \\ \hline \end{array} & \nu = \begin{array}{|c|c|c|} \hline \square & \square & \square \\ \hline \square & \square & \square \\ \hline \square & & \end{array} & r_{\lambda\mu}^\nu(u) = \frac{(u-3)(u+4)}{(u-1)(u+2)} \\
 3. & \lambda = \begin{array}{|c|c|} \hline \square & \square \\ \hline \square & \square \\ \hline \end{array} & \mu = \begin{array}{|c|c|} \hline \square & \square \\ \hline \square & \square \\ \hline \end{array} & \nu = \begin{array}{|c|c|c|} \hline \square & \square & \square \\ \hline \square & \square & \square \\ \hline \square & & \end{array} & r_{\lambda\mu}^\nu(u) = \frac{(u-3)(u-2)(u+2)}{(u)(u+1)} \\
 4. & \lambda = \begin{array}{|c|c|} \hline \square & \square \\ \hline \square & \square \\ \hline \end{array} & \mu = \begin{array}{|c|c|} \hline \square & \square \\ \hline \square & \square \\ \hline \end{array} & \nu = \begin{array}{|c|c|c|} \hline \square & \square & \square \\ \hline \square & \square & \square \\ \hline \square & & \end{array} & r_{\lambda\mu}^\nu(u) = \frac{(u-2)(u+2)(u+3)}{(u-1)(u)(u)} \\
 5. & \lambda = \begin{array}{|c|c|} \hline \square & \square \\ \hline \square & \square \\ \hline \end{array} & \mu = \begin{array}{|c|c|} \hline \square & \square \\ \hline \square & \square \\ \hline \square & \end{array} & \nu = \begin{array}{|c|c|c|} \hline \square & \square & \square \\ \hline \square & \square & \square \\ \hline \square & & \end{array} & r_{\lambda\mu}^\nu(u) = \frac{(u-2)(u+3)}{u(u+1)} \\
 6. & \lambda = \begin{array}{|c|c|} \hline \square & \square \\ \hline \square & \square \\ \hline \end{array} & \mu = \begin{array}{|c|c|} \hline \square & \square \\ \hline \square & \square \\ \hline \square & \end{array} & \nu = \begin{array}{|c|c|} \hline \square & \square \\ \hline \square & \square \\ \hline \square & \square \\ \hline \square & \end{array} & r_{\lambda\mu}^\nu(u) = \frac{(u+1)(u+4)}{(u-1)(u)}
 \end{array}$$

Before we describe how we computed these eigenvalues, let us examine how these calculations support the conjecture at the end of section 4.1.

Example 4.5. Let $\lambda = (3, 1)$ and $\mu = (2, 2)$, then the following is a complete list of partitions ν , such that the Littlewood-Richardson coefficient, $c_{\lambda\mu}^\nu$, equals 1. We then give the corresponding eigenvalues $r_{\lambda\mu}^\nu(z, w)$ and $r_{\mu\lambda}^\nu(w, z)$.

$$\lambda = \begin{array}{|c|c|c|} \hline \square & \square & \square \\ \hline \square & & \\ \hline \end{array} \quad \mu = \begin{array}{|c|c|} \hline \square & \square \\ \hline \square & \square \\ \hline \end{array}$$

$$\begin{array}{l}
1. \quad \nu = \begin{array}{|c|c|c|c|c|} \hline \square & \square & \square & \square & \square \\ \hline \square & \square & & & \\ \hline \end{array} \quad r_{\lambda\mu}^\nu(z, w) = \frac{(z-w-3)(z-w-2)}{(z-w+1)(z-w+2)} \quad r_{\mu\lambda}^\nu(w, z) = \frac{(z-w+3)(z-w+4)}{(z-w-1)(z-w)} \\
2. \quad \nu = \begin{array}{|c|c|c|c|c|} \hline \square & \square & \square & \square & \square \\ \hline \square & \square & & & \\ \hline \square & & & & \\ \hline \end{array} \quad r_{\lambda\mu}^\nu(z, w) = \frac{(z-w-3)}{(z-w+2)} \quad r_{\mu\lambda}^\nu(w, z) = \frac{(z-w-2)(z-w+3)(z-w+4)}{(z-w-1)(z-w)(z-w+1)} \\
3. \quad \nu = \begin{array}{|c|c|c|c|} \hline \square & \square & \square & \square \\ \hline \square & \square & \square & \\ \hline \square & & & \\ \hline \end{array} \quad r_{\lambda\mu}^\nu(z, w) = \frac{(z-w-3)(z-w+4)}{(z-w+1)(z-w+2)} \quad r_{\mu\lambda}^\nu(w, z) = \frac{(z-w-2)(z-w+3)}{(z-w-1)(z-w)} \\
\ddagger 4. \quad \nu = \begin{array}{|c|c|c|c|} \hline \square & \square & \square & \square \\ \hline \square & \square & & \\ \hline \square & & & \\ \hline \end{array} \quad r_{\lambda\mu}^\nu(z, w) = \frac{(z-w-3)(z-w+4)}{(z-w-1)(z-w+2)} \quad r_{\mu\lambda}^\nu(w, z) = \frac{(z-w-2)(z-w+3)}{(z-w)(z-w+1)} \\
5. \quad \nu = \begin{array}{|c|c|c|c|} \hline \square & \square & \square & \square \\ \hline \square & \square & & \\ \hline \square & & & \\ \hline \square & & & \\ \hline \end{array} \quad r_{\lambda\mu}^\nu(z, w) = \frac{(z-w+4)}{(z-w+2)} \quad r_{\mu\lambda}^\nu(w, z) = \frac{(z-w-3)(z-w-2)(z-w+3)}{(z-w-1)(z-w)(z-w+1)} \\
6. \quad \nu = \begin{array}{|c|c|c|} \hline \square & \square & \square \\ \hline \square & \square & \square \\ \hline \square & & \\ \hline \end{array} \quad r_{\lambda\mu}^\nu(z, w) = \frac{(z-w-3)(z-w+3)(z-w+4)}{(z-w-1)(z-w+1)(z-w+2)} \quad r_{\mu\lambda}^\nu(w, z) = \frac{(z-w-2)}{(z-w)} \\
7. \quad \nu = \begin{array}{|c|c|c|} \hline \square & \square & \square \\ \hline \square & \square & \square \\ \hline \square & & \\ \hline \square & & \\ \hline \end{array} \quad r_{\lambda\mu}^\nu(z, w) = \frac{(z-w+3)(z-w+4)}{(z-w-1)(z-w+2)} \quad r_{\mu\lambda}^\nu(w, z) = \frac{(z-w-3)(z-w-2)}{(z-w)(z-w+1)}
\end{array}$$

The first result is the partition $\nu = \lambda + \mu$. The fourth result is not of mixed hook type and its eigenvalues were calculated using GAP. All other eigenvalues were calculated using Theorem 4.2 and Proposition 4.1. Let $\mathcal{Z}_{\lambda\mu}$ denote the set of zeros and poles of $r_{\lambda\mu}^{\lambda+\mu}(z, w)/r_{\lambda\mu}^\nu(z, w)$, then for the ν listed above we have $\mathcal{Z}_{\lambda\mu} = \{\pm 1, +2, \pm 3, -4\}$.

Using [LZ] one can demonstrate that if $\lambda'_1, \mu'_1 \leq 3$ then $\mathcal{S}_{\lambda\mu} = \mathcal{D}_{\lambda\mu} \cup (-\mathcal{D}_{\mu\lambda})$. Then we can see, using the above calculations, that $\mathcal{S}_{\lambda\mu}$ does indeed equal $\mathcal{Z}_{\lambda\mu}$ as expected. ■

Similar calculations, where λ and μ are partitions of 4, also support the conjecture. Although these are the smallest examples of partitions ν that are not of

mixed hook type they are also the largest examples calculated so far. Results 4.4 were calculated using GAP, see Appendix A. The results were calculated by constructing a test vector in V_ν . This test vector is constructed by multiplying the primitive central idempotent, Z_ν , corresponding to the representation ν , on the right by the product $F_\Lambda \bar{F}_M$. The diagonal matrix elements F_Λ and F_M were computed using the hook fusion procedure of Section 3, which is a more efficient way to calculate the diagonal matrix elements since it minimises the number of auxiliary parameters needed. Finally, the eigenvalue $r'_{\lambda\mu}(u)$ may be determined by multiplying the test vector on the right by the operator $R_{\Lambda M}(u)$.

We illustrate the method with a simple example below. This example is much smaller than the ones above. Here $\nu = \lambda + \mu$ and is the trivial representation of $\mathbb{C}S_4$.

Example 4.6. Let $\lambda = \begin{array}{|c|c|} \hline \square & \square \\ \hline \end{array}$ and $\mu = \begin{array}{|c|c|} \hline \square & \square \\ \hline \end{array}$. There is only one standard tableau, Λ , of shape λ . Similarly for μ .

Take $\nu = \lambda + \mu = \begin{array}{|c|c|c|c|} \hline \square & \square & \square & \square \\ \hline \end{array}$, which has Littlewood-Richardson coefficient $c'_{\lambda\mu} = 1$. Then the corresponding diagonal matrix elements are simply;

$$F_\Lambda = 1 + (1 \ 2) \quad \text{and} \quad \bar{F}_M = 1 + (3 \ 4).$$

The primitive central idempotent corresponding to ν is given by the formula

$$Z_\nu = \frac{\dim V_\nu}{(n+m)!} \sum_{\sigma \in S_{n+m}} \chi^\nu(\sigma) \cdot \sigma = \frac{1}{4!} \sum_{\sigma \in S_4} \sigma,$$

where χ^ν is the character of the representation ν . The test vector is then

$$v_\nu = Z_\nu F_\Lambda \bar{F}_M = 4Z_\nu \in V_\nu.$$

The operator J is then

$$\begin{aligned}
R_{\Lambda M}(u) &= f_{14}(z + c_1(\Lambda), w + c_2(M))f_{13}(z + c_1(\Lambda), w + c_1(M)) \\
&\quad \times f_{24}(z + c_2(\Lambda), w + c_2(M))f_{23}(z + c_2(\Lambda), w + c_1(M)) \\
&= \left(1 - \frac{(14)}{u-1}\right) \left(1 - \frac{(13)}{u}\right) \left(1 - \frac{(24)}{u}\right) \left(1 - \frac{(23)}{u+1}\right) \\
&= 1 - \frac{(14)}{u-1} - \frac{(13)}{u} + \frac{(134)}{u(u-1)} - \frac{(24)}{u} + \frac{(142)}{u(u-1)} + \frac{(13)(24)}{(u+1)(u-1)} \\
&\quad - \frac{2 \cdot (1342)}{u(u+1)(u-1)} - \frac{(23)}{u+1} + \frac{(14)(23)}{(u+1)(u-1)} + \frac{(132)}{u(u+1)} \\
&\quad - \frac{(1324)}{u(u+1)(u-1)} + \frac{(234)}{u(u+1)} - \frac{(1423)}{u(u+1)(u-1)}
\end{aligned}$$

And,

$$v_\nu \cdot R_{\Lambda M}(u) = \frac{u(u-1)(u-1)(u-2)}{u^2(u+1)(u-1)} \cdot v_\nu = r_{\lambda\mu}^\nu(u)v_\nu.$$

■

In particular, the numerators of the eigenvalues of 4.4 have integral roots as a polynomial of u . This suggests there may be a combinatorial description for all such eigenvalues.

5 The ribbon fusion procedure

We now consider a further generalisation of the fusion procedure. So far the fusion procedure has required us to decompose Young diagrams either into their rows, columns or hooks before applying a certain limiting process to obtain the diagonal matrix element. Therefore it is natural to consider how many other ways we may decompose the Young diagram in this procedure. So let us now consider ribbons of a Young diagram, of which rows, columns and hooks are special cases. It is worth noting ribbons too have a Jacobi-Trudi or Giambelli style determinant to calculate Schur functions. We go on to introduce new notation which we may use to build certain types of ribbons, with the aim of making a ribbon fusion procedure.

5.1 Ribbon Schur functions

We have already seen some determinantal expressions for the Schur function $s_\lambda(\mathbf{x})$ obtained either by decomposing the Young diagram λ into rows or columns (Jacobi-Trudi identities (17), (18)) or hooks (Giambelli (23)). Since these decompositions also gave us a limiting procedure to find the diagonal matrix element F_Λ , let us consider some of the other ways to decompose a diagram λ . First we define a skew Schur function in the variables $\mathbf{x} = (x_1, \dots, x_m)$ to be

$$s_{\lambda/\mu}(\mathbf{x}) = \sum_T \prod_{(i,j) \in \lambda/\mu} x_{T(i,j)},$$

where the sum is over all semistandard tableaux of shape λ/μ with entries $1, \dots, m$. We now state an important definition:

Definition 5.1 *A ribbon is a skew diagram with an edgewise connected set of boxes that contain no 2×2 block of boxes.*

For example, the skew diagram below is a ribbon.

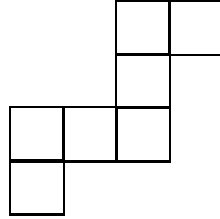

These objects are also known as ‘strips’ or ‘skew hooks’ amongst other names. Note that rows, columns and hooks are all special cases of ribbon which are of non-skew shape. The term *rim ribbon* denotes the maximal outer ribbon of a diagram. Below we give the successive rim ribbons of the partition $(4, 3, 3, 1)$.

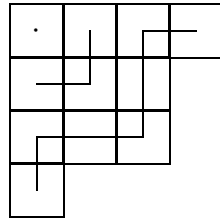

In 1988, Lascoux and Pragacz obtained a new determinantal expression for the Schur function $s_\lambda(\mathbf{x})$ obtained from a decomposition of λ into rim ribbons, [LP].

Proposition 5.2 (Lascoux-Pragacz) *Let λ be a partition with d boxes on the main diagonal, and let $(\theta_1, \theta_2, \dots, \theta_d)$ be its decomposition into rim ribbons, then*

$$s_\lambda(\mathbf{x}) = \det \left[s_{\theta_i^- \& \theta_j^+}(\mathbf{x}) \right]_{i,j=1}^d,$$

where $\theta_i^- \& \theta_j^+$ denotes the skew diagram obtained by replacing the boxes below the diagonal of θ_j by that of θ_i .

Then, in 1995, Hamel and Goulden considered a much larger class of decompositions which gave determinantal expressions of skew Schur functions, and which also contain the Jacobi-Trudi, Giambelli and Lascoux-Pragacz identities as special cases, [HG]. Suppose that $\theta_1, \dots, \theta_m$ are ribbons in the skew

diagram λ/μ such that each ribbon has a starting box on the left or bottom perimeter of the diagram and an ending box on the right or top perimeter of the diagram, then we say this set is a *planar outside decomposition* of λ/μ if the disjoint union of these ribbons is the skew diagram λ/μ . Below is the planar decomposition of $(4, 3, 3, 1)$ into four ribbons.

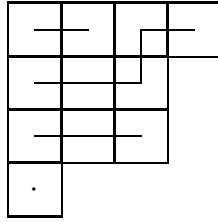

Then we have the following remarkable identity;

Theorem 5.3 (Hamel-Goulden) *Let λ/μ be a skew shape partition. Then, for any planar outside decomposition $(\theta_1, \theta_2, \dots, \theta_m)$ of λ/μ we have*

$$s_{\lambda/\mu}(\mathbf{x}) = |s_{\theta_i \# \theta_j}(\mathbf{x})|_{m \times m}$$

where $\theta_i \# \theta_j$ is the non-commutative superimposing of θ_i and θ_j described in [HG].

However, in the same paper, Hamel and Goulden show that this determinantal expression does not necessarily hold for other decompositions that are not planar outside decompositions, in particular they give the following decomposition of $(4, 4, 4)$ as an example.

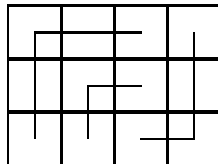

However, it turns out then that such a decomposition could be used in a ribbon fusion procedure, while other examples of planar outside decompositions fail. So instead we must construct our own class of decompositions which will form a basis for our ribbon fusion procedure.

5.2 Towards a ribbon fusion procedure

Consider a Young diagram of shape $(2,2)$. That is a 2×2 square of four boxes. Each box has an associated parameter z_i . If $z_i = z_j$ connect the boxes containing i and j with a line. Below is a complete list of 2×2 squares connected using vertical and horizontal lines, we label them as types $\textcircled{0}$ to $\textcircled{15}$.

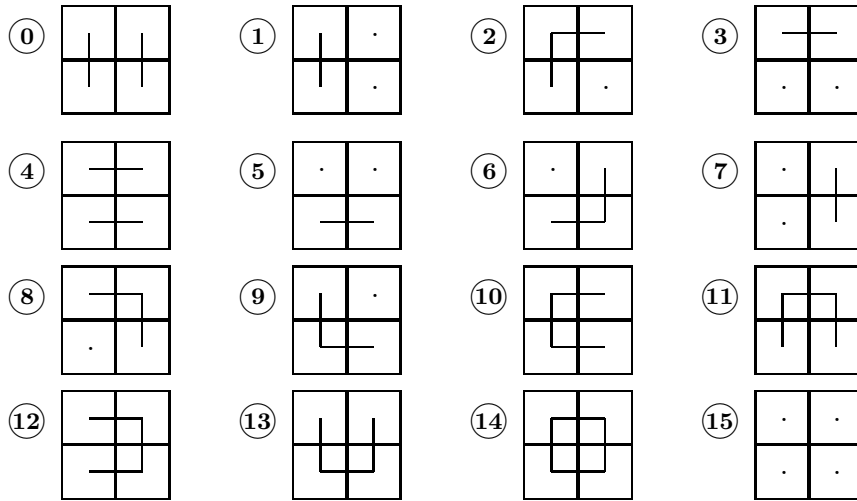

If p and q sit on the same diagonal of a tableau Λ , we say the singularity (p, q) is of degree r if q is r steps away from p on the diagonal. For example the 2×2 squares above contain a singularity of degree 1 only.

We say a singularity (p, q) is of type \textcircled{i} , $0 \leq i \leq 15$, if we can form a 2×2 square of type \textcircled{i} as follows: Take the boxes containing p and q and identify (or superimpose) the box below p with the box to the left of q , and identify the box to the right of p with the box above q to form a 2×2 square, see the below figure.

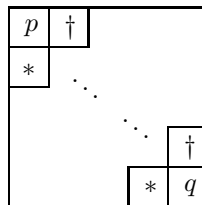
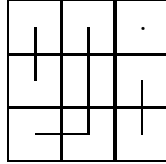

Figure 3: We identify the boxes labeled \dagger and the boxes labeled $*$ to form a 2×2 square.

For example, the 3×3 square



contains a singularity of degree 2 of type $\textcircled{0}$.

If the singularity of degree r in a $(r + 1) \times (r + 1)$ square is of type \textcircled{i} , we denote the square by \textcircled{i}^r . We omit r when $r = 1$.

We say i union j , and write

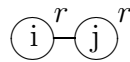

to mean the second column of \textcircled{i}^r superimposed onto the first column of \textcircled{j}^r , and write

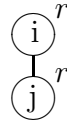

to mean the second row of \textcircled{i}^r superimposed onto the first row of \textcircled{j}^r .

So the 3×3 square above may be denoted $\textcircled{0}^2$ for singularities of degree 2, and

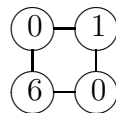

for singularities of degree 1.

Definition 5.4 : Valid Diagrams.

A diagram is a tableau Λ in which we connect the boxes as described above. If i is connected to j in the diagram Λ then we let $z_i = z_j$, and set $z_i - z_j \notin \mathbb{Z}$ otherwise.

It is our intention to re-order the product (14) to form regular triples at $z_1 = \dots = z_n$. Since they do not allow the formation of regular triples we exclude 2×2 squares of type $\textcircled{8}$ to $\textcircled{15}$ in our diagrams. For the same reason we also exclude the unions

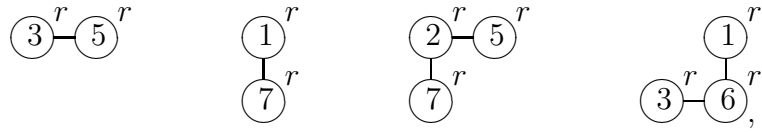

including these unions with any number of

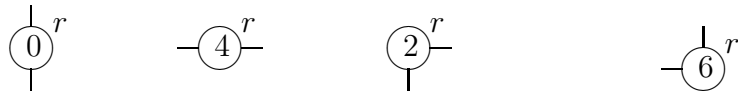

between the two ends of the chain, for all $r \geq 1$, where such unions are possible.

The direction of the connecting lines is important. For example,

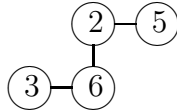

is an excluded union, whereas

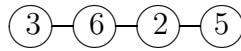

is not excluded.

If we list the possible unions to the right and below a singularity of type \textcircled{i} ,

then the unions of degree 1 are;

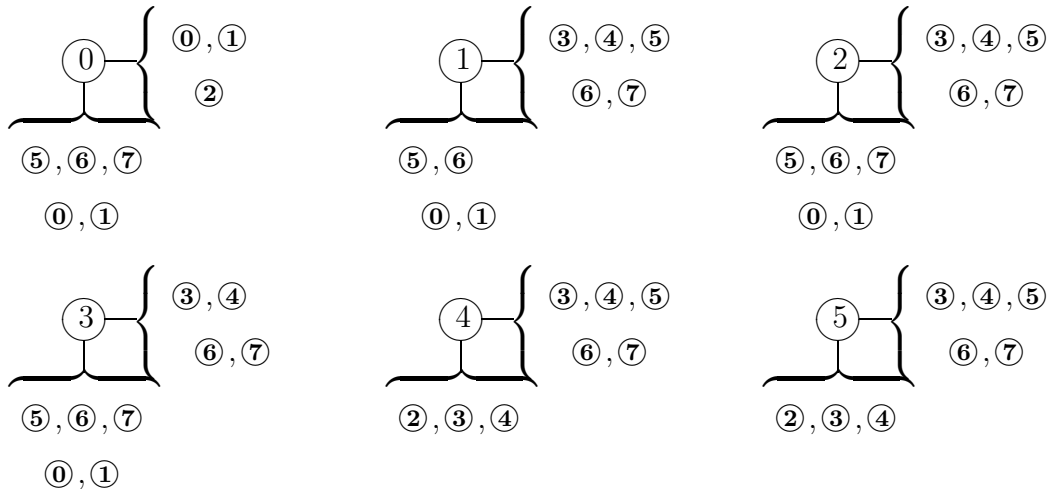

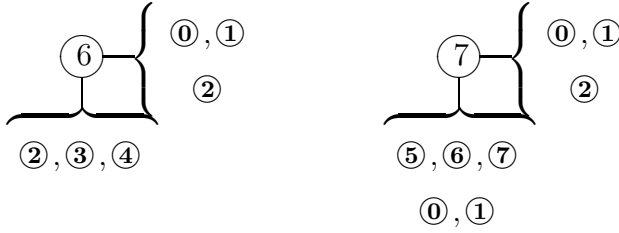

Similarly, a 2×2 square of type ① may not be diagonally below a 2×2 square of type ⑦, and a 2×2 square of type ③ may not be diagonally below a 2×2 square of type ⑤. The following shows which types may be immediately diagonally below a 2×2 square of type ①.

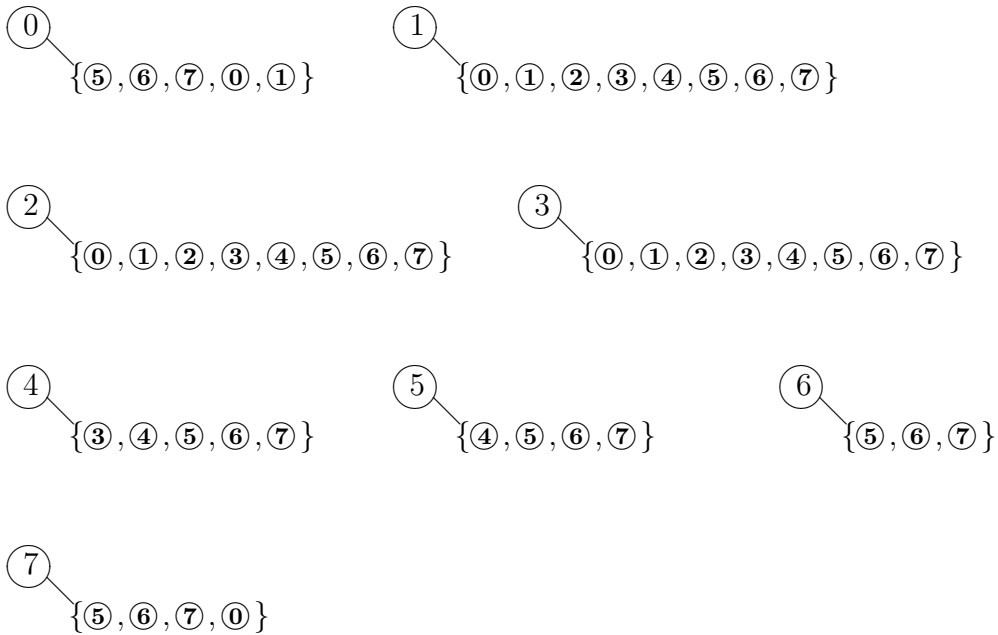

By considering diagonal chains we can see that, under the above conditions, we can never have a singularity of type ⑮, of any degree.

Note, for a tableau Λ of shape $\lambda = (\lambda_1, \dots, \lambda_k)$, we may connect the boxes $\Lambda(1, b)$ with $b > \lambda_2$ in the first row any way we like without consequence. Similarly we may connect the boxes $\Lambda(a, 1)$ with $a > \lambda'_2$ in the first column in any way we wish.

We call a diagram *invalid* if;

- (i) It contains any 2×2 square of type $\textcircled{8}$ to $\textcircled{15}$.
- (ii) It contains excluded unions such as $\textcircled{3}-\textcircled{5}$.
- (iii) It contains a singularity of type $\textcircled{15}$, of any degree.

We call all other diagrams *valid*.

We may now state our conjecture for a possible ribbon fusion procedure. Let \mathcal{P}_Λ be the vector subspace of \mathbb{C}^n consisting of all tuples (z_1, \dots, z_n) such that $z_i = z_j$ if i is connected to j in the diagram Λ , and $z_i - z_j \notin \mathbb{Z}$ otherwise.

Conjecture 5.5 *The value of $F_\Lambda(z_1, \dots, z_n)$ at $z_1 = \dots = z_n$, after restriction to \mathcal{P}_Λ , is the diagonal matrix element $F_\Lambda \in \mathbb{C}S_n$ if and only if Λ is a valid diagram.*

Let us look at how valid diagrams can imply the element $F_\Lambda(z_1, \dots, z_n)$ is the diagonal matrix element. The valid diagrams are designed to be those diagrams such that regular triples are possible at $z_1 = \dots = z_n$. Consider the column tableau of the partition $(2, 2)$ and then the following two diagrams;

$$A = \begin{array}{|c|c|} \hline 1 & 3 \\ \hline 2 & 4 \\ \hline \end{array} \quad B = \begin{array}{|c|c|} \hline 1 & 3 \\ \hline 2 & 4 \\ \hline \end{array}$$

The ordering $f_{12}(f_{13}f_{14})f_{23}f_{24}f_{34}$, with $\frac{1}{2}f_{34}$ as an idempotent, shows regularity at $z_1 = \dots = z_n$ for both $F_A(z_1, \dots, z_n)$ and $F_B(z_1, \dots, z_n)$. In full we have;

$$F_A(z_1, \dots, z_n) = (1 - (1 \ 2)) \left[\left(1 - \frac{(1 \ 3)}{z_1 - z_3 - 1}\right) \left(1 - \frac{(1 \ 4)}{z_1 - z_3}\right) \frac{1}{2} (1 - (3 \ 4)) \right] \\ \times \left(1 - \frac{(2 \ 3)}{z_1 - z_3 - 2}\right) \left(1 - \frac{(2 \ 4)}{z_1 - z_3 - 1}\right) (1 - (3 \ 4))$$

and

$$F_B(z_1, \dots, z_n) = \left(1 - \frac{(1 \ 2)}{z_1 - z_2 + 1}\right) \left[\left(1 - \frac{(1 \ 3)}{z_1 - z_3 - 1}\right) \left(1 - \frac{(1 \ 4)}{z_1 - z_3}\right) \frac{1}{2} (1 - (3 \ 4)) \right] \\ \times \left(1 - \frac{(2 \ 3)}{z_2 - z_3 - 2}\right) \left(1 - \frac{(2 \ 4)}{z_2 - z_3 - 1}\right) (1 - (3 \ 4))$$

Since we use the same tableau in both diagrams, they both have the same singularity. In both cases that singularity is resolved in exactly the same way, with a shared idempotent $\frac{1}{2}f_{34}$ and a shared triple term f_{13} . So the value of the triple is the same at $z_1 = \dots = z_n$ in both cases. All other terms in the two products also have the same value at $z_1 = \dots = z_n$. So by comparing the two products, first comparing triples and then term by term, we see that $F_A(z_1, \dots, z_n)$ has the same value as $F_B(z_1, \dots, z_n)$ at $z_1 = \dots = z_n$. We know, by the column fusion procedure, that $F_A(z_1, \dots, z_n)$ is the diagonal matrix element at $z_1 = \dots = z_n$, and hence so is $F_B(z_1, \dots, z_n)$.

We cannot compare the diagrams

$$A = \begin{array}{|c|c|} \hline 1 & 3 \\ \hline 2 & 4 \\ \hline \end{array} \quad \text{and} \quad D = \begin{array}{|c|c|} \hline 1 & 3 \\ \hline 2 & 4 \\ \hline \end{array}$$

directly in this way. Instead we need an intermediate step such as

$$C = \begin{array}{|c|c|} \hline 1 & 3 \\ \hline 2 & 4 \\ \hline \end{array}$$

We may then form a chain of diagrams comparing A and C using $\frac{1}{2}f_{12}$ as the shared idempotent and f_{24} as the shared triple term. Then rearranging the product of C using the Yang-Baxter relations (15) and (16), which reorder the terms without changing the value of the product, such that we may then compare C with D using $\frac{1}{2}f_{13}$ as the shared idempotent and f_{34} as the shared triple term.

This example illustrates our method of proof. We break the proof into two statements. The first states that the corresponding product $F_\Lambda(z_1, \dots, z_n)$ of every valid diagram Λ has at least one ordering such that each singularity may be resolved by regular triples. While the second statement shows there exists a chain of diagrams, ending with the diagram used in the column fusion procedure, such that we may compare each diagram in the chain to the one before in the way described above.

Given this plan of attack, we give the first statement formally as the following conjecture.

Conjecture 5.6 *For every valid diagram Λ there exists at least one ordering of $F_\Lambda(z_1, \dots, z_n)$ such that, after restriction to \mathcal{P}_Λ , we may resolve all singularities by regular triples at $z_1 = \dots = z_n$.*

We assert this to be a reasonable conjecture, which then has the immediate corollary;

Corollary 5.7 *For every valid diagram Λ , $F_\Lambda(z_1, \dots, z_n)$ is regular at $z_1 = \dots = z_n$, after restriction to \mathcal{P}_Λ .*

Given Conjecture 5.6 we now describe a chain of diagrams which allow us to compare any valid diagram to the diagram used in the column fusion procedure which is made entirely of 2×2 squares of type $\textcircled{0}$.

Proposition 5.8 *Let $\tilde{\Lambda}$ be the diagram made entirely of 2×2 squares of type $\textcircled{0}$. For any valid diagram Λ there exist a chain of valid diagrams, $\Lambda = \Lambda^\circ, \Lambda^1, \Lambda^2, \dots, \Lambda^N = \tilde{\Lambda}$ such that, any two adjacent diagrams, $F_{\Lambda^k}(z_1, \dots, z_n)$ and $F_{\Lambda^{k+1}}(z_1, \dots, z_n)$ share an ordering which resolves all singularities in both products by regular triples at $z_1 = \dots = z_n$.*

Proof. Let u stand next to v in the same row or column of Λ . We call a line connecting two such adjacent boxes an idempotent, since $\frac{1}{2}f_{uv}(c_u(\Lambda), c_v(\Lambda))$ is

an idempotent in $\mathbb{C}S_n$. One diagram may be turned into another by addition or subtraction of an idempotent. Then, given Conjecture 5.6, the diagram with the fewest idempotents has an associated product with at least one ordering which resolves all singularities by regular triples at $z_1 = \cdots = z_n$. Any such ordering will also resolve the singularities of the product associated to the diagram with the additional idempotent. Note, this would not be the case if the additional idempotent was in the place of a triple term, but this can not happen since such an idempotent would connect the boxes of a singularity making an invalid diagram.

Let $j = i \pm 1 \pmod 8$. Then we may turn a 2×2 square of type \textcircled{i} , $0 \leq i \leq 7$, into a square of type \textcircled{j} by adding or removing an idempotent. The following figure shows which types may be turned into which other types².

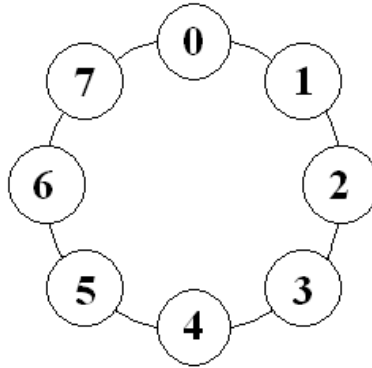

Figure 4: Changing types by adding and removing idempotents.

We now provide an algorithm to turn any valid diagram into the diagram made entirely of 2×2 squares of type $\textcircled{0}$. We do this by using Figure 4 and moving away from 2×2 squares of type $\textcircled{4}$ and towards 2×2 squares of type $\textcircled{0}$. This will give us a valid diagram except in the following cases. In these cases we must perform the prescribed actions first. If this causes a loop of logic we perform all actions simultaneously.

²This figure is suggestive of modular arithmetic, mod 8. Indeed $\textcircled{4}$ is the square $\textcircled{0}$ rotated 180° . Also, if $j - i = 4 \pmod 8$ then \textcircled{i} is opposite \textcircled{j} on the circle and is a reflection of \textcircled{j} in the line $y = x$.

Turning ① into ① is fine except when we have the following unions:

- ①—③ In which case first change ③ \mapsto ②
- ①—④ First change ④ \mapsto ③ or ④ \mapsto ⑤
- ①—⑤ First change ⑤ \mapsto ⑥
- ①—⑥ First change ⑥ \mapsto ⑦
- ①—⑦ First change ⑦ \mapsto ①

Turning ②^r into ①^r is fine except when we have the following unions:

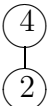
- 

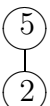
In which case first change ④ \mapsto ③ or ④ \mapsto ⑤
- 

First change ⑤ \mapsto ⑥
- 

First change ⑥ \mapsto ⑦
- *

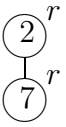

First change ⑦^r \mapsto ①^r, for $r \geq 1$
- *

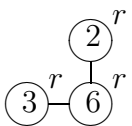

First change ⑤^r \mapsto ⑥^r, for $r \geq 1$

Turning ③ into ② is fine except when we have the following unions:

- ①—③ In which case first change ① \mapsto ①
- ②—③ First change ② \mapsto ①
- ③'—③ First change ③' \mapsto ②
- ④—③ First change ④ \mapsto ③ or ④ \mapsto ⑤



Turning ④^r into ③^r is fine except when we have the following unions:

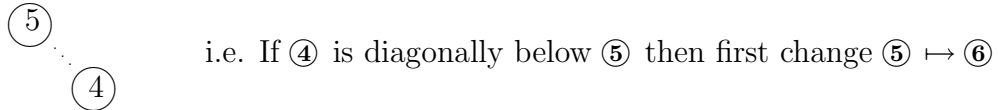
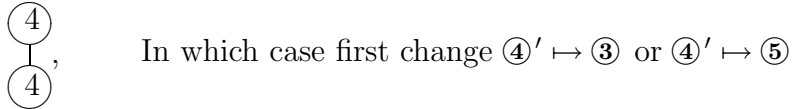
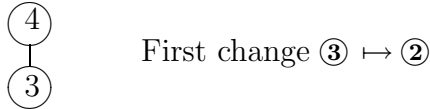
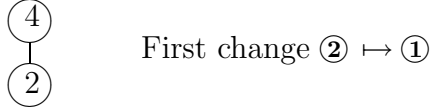

Turning ④^r into ⑤^r is fine except when we have the following unions:

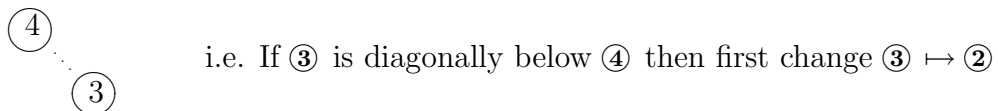
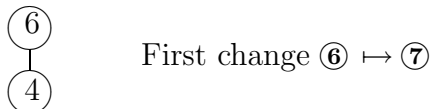
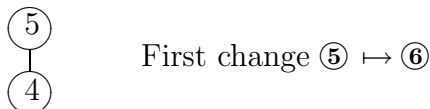
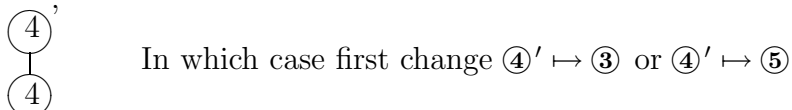

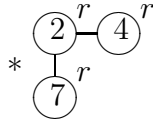

First change $\textcircled{7}^r \mapsto \textcircled{0}^r$, for all $r \geq 1$

Turning $\textcircled{5}$ into $\textcircled{6}$ is fine except when we have the following unions:

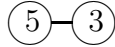

In which case first change $\textcircled{3} \mapsto \textcircled{2}$

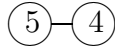

First change $\textcircled{4} \mapsto \textcircled{3}$ or $\textcircled{4} \mapsto \textcircled{5}$

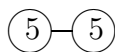

First change $\textcircled{5}' \mapsto \textcircled{6}$

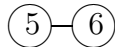

First change $\textcircled{6} \mapsto \textcircled{7}$

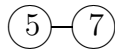

First change $\textcircled{7} \mapsto \textcircled{0}$

Turning $\textcircled{6}^r$ into $\textcircled{7}^r$ is fine except when we have the following unions:

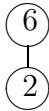

First change $\textcircled{2} \mapsto \textcircled{1}$

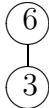

First change $\textcircled{3} \mapsto \textcircled{2}$

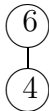

In which case first change $\textcircled{4} \mapsto \textcircled{3}$ or $\textcircled{4} \mapsto \textcircled{5}$

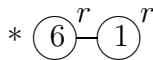

First change $\textcircled{1}^r \mapsto \textcircled{0}^r$, for all $r \geq 1$

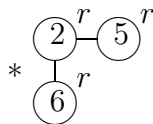

First change $\textcircled{8}^r \mapsto \textcircled{6}^r$, for all $r \geq 1$

Turning $\textcircled{7}$ into $\textcircled{0}$ is fine except when we have the following unions:

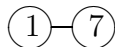

In which case first change $\textcircled{1} \mapsto \textcircled{0}$

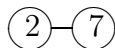

First change $\textcircled{2} \mapsto \textcircled{1}$

- ③—⑦ First change ③ \mapsto ②
- ④—⑦ First change ④ \mapsto ③ or ④ \mapsto ⑤
- ⑤—⑦ First change ⑤ \mapsto ⑥

* with any number of

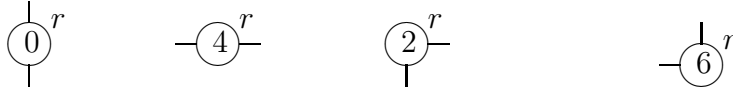

between the two ends of the chain, for all $r \geq 1$.

These actions prevent us from making an invalid diagram from a diagram that was previously valid. We often have a choice of changing a square of type ④ to either one of type ③ or type ⑤. For types of odd number it is enough to consider unions of degree 1, for types of even number we must also consider singularities of higher degree. ■

Thanks to the above proposition, given any valid starting point, we can now form a chain of diagrams in which we know, for any two adjacent diagrams, $F_{\Lambda^k}(z_1, \dots, z_n)$ and $F_{\Lambda^{k+1}}(z_1, \dots, z_n)$ have the same value in $\mathbb{C}S_n$ at $z_1 = \dots = z_n$. This chain ends with the diagram used in the column fusion procedure, for which the associated product is known to be the diagonal matrix element at $z_1 = \dots = z_n$. Hence;

Corollary 5.9 *For any valid diagram Λ , the value of $F_{\Lambda}(z_1, \dots, z_n)$ at $z_1 = \dots = z_n$, after restriction to \mathcal{P}_{Λ} , is the diagonal matrix element $F_{\Lambda} \in \mathbb{C}S_n$.*

Let us give an example of this algorithm in practice and how it implies the product associated to a particular diagram defines the diagonal matrix element.

Example 5.10. Let $\lambda = (4, 4, 4, 4)$. Note λ could be any partition, not necessarily square. Fix a standard tableau of shape λ , say the column tableau Λ^c . Consider the following valid diagram;

1	5	9	13
2	6	10	14
3	7	11	15
4	8	12	16

Starting with this diagram we then use the algorithm of Proposition 5.8 to form the following chain of diagrams. We also write the diagrams in terms of their unions of both degree 1 and degree 2.

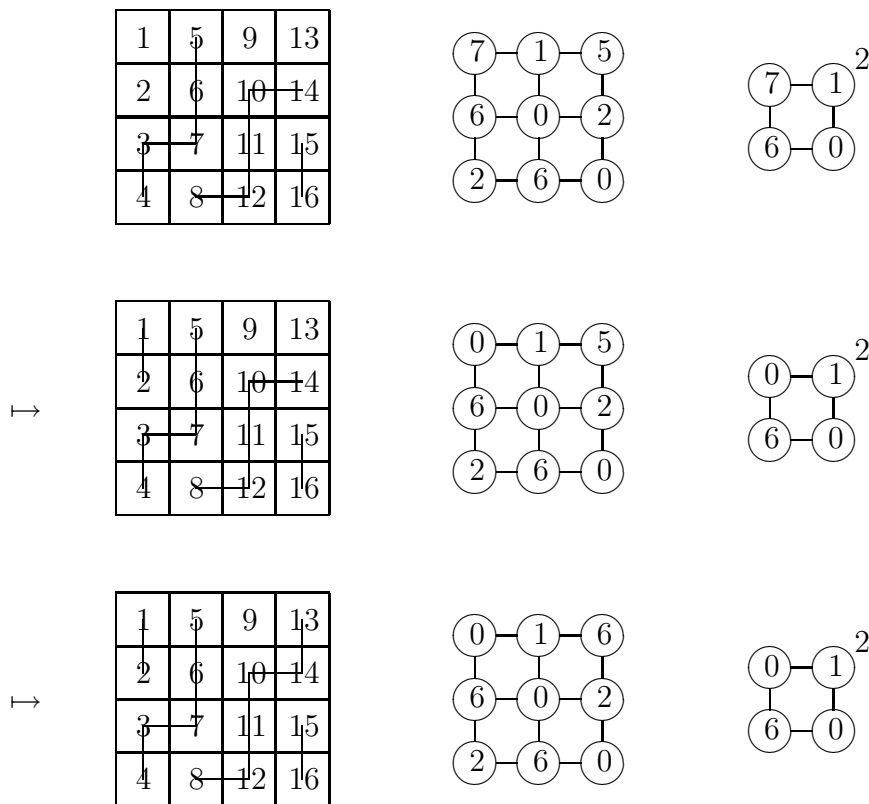

There is a product of the form (14) associated to each diagram above. The following ordering is shared by all three diagrams, and resolves all the singularities of Λ^c in the same way. For simplicity we write $f_{p,q}$ instead of $f_{p,q}(z_p+c_p(\Lambda^c), z_q+c_q(\Lambda^c))$. We indicate the singularities along with their triple terms, idempotents may then be added to form regular triples at $z_1 = \dots = z_n$.

$f_{1,2}f_{1,3}f_{2,3}f_{1,4}f_{2,4}f_{3,4} (f_{1,5}f_{1,6}) f_{1,7}f_{2,5} (f_{2,6}f_{2,7}) f_{3,5}f_{3,6}f_{3,7}f_{4,5}f_{4,6}f_{4,7}f_{5,6}f_{5,7}f_{6,7}f_{8,9}f_{1,9}f_{2,9}f_{3,9}$
 $f_{4,9}f_{5,9}f_{6,9}f_{7,9}f_{8,10}f_{8,11} (f_{1,10}f_{1,11}) f_{2,10}f_{2,11}f_{3,10}f_{3,11}f_{4,10}f_{4,11} (f_{5,10}f_{6,10}) f_{7,10}f_{5,11} (f_{6,11}f_{7,11})$
 $f_{10,11}f_{9,11}f_{1,8}f_{1,12} (f_{2,8}f_{2,12}) (f_{3,8}f_{4,8}) f_{3,12}f_{4,12}f_{5,8}f_{5,12}f_{6,8}f_{6,12} (f_{7,8}f_{7,12}) f_{8,12}f_{9,12}f_{10,12}f_{11,12}$
 $f_{1,13}f_{2,13}f_{3,13}f_{4,13}f_{5,13}f_{6,13}f_{7,13}f_{8,13}f_{10,13}f_{9,13}f_{11,13}f_{12,13}f_{1,14}f_{2,14}f_{3,14}f_{4,14}f_{5,14}f_{6,14}f_{7,14}f_{8,14}$
 $(f_{9,10}f_{9,14}) f_{10,14}f_{11,14}f_{12,14}f_{13,14} (f_{1,15}f_{1,16}) f_{2,15}f_{2,16}f_{3,15}f_{3,16}f_{4,15}f_{4,16} (f_{5,15}f_{6,15}) f_{7,15}f_{5,16}$
 $(f_{6,16}f_{7,16}) f_{8,15}f_{8,16}f_{9,15}f_{9,16} (f_{10,15}f_{11,15}) f_{12,15}f_{10,16} (f_{11,16}f_{12,16}) f_{13,15}f_{13,16}f_{14,15}f_{14,16}f_{15,16}$

And hence, by first comparing triples and then all other terms, these three products have the same value at $z_1 = \dots = z_n$. We now continue the chain of diagrams, starting with our last diagram.

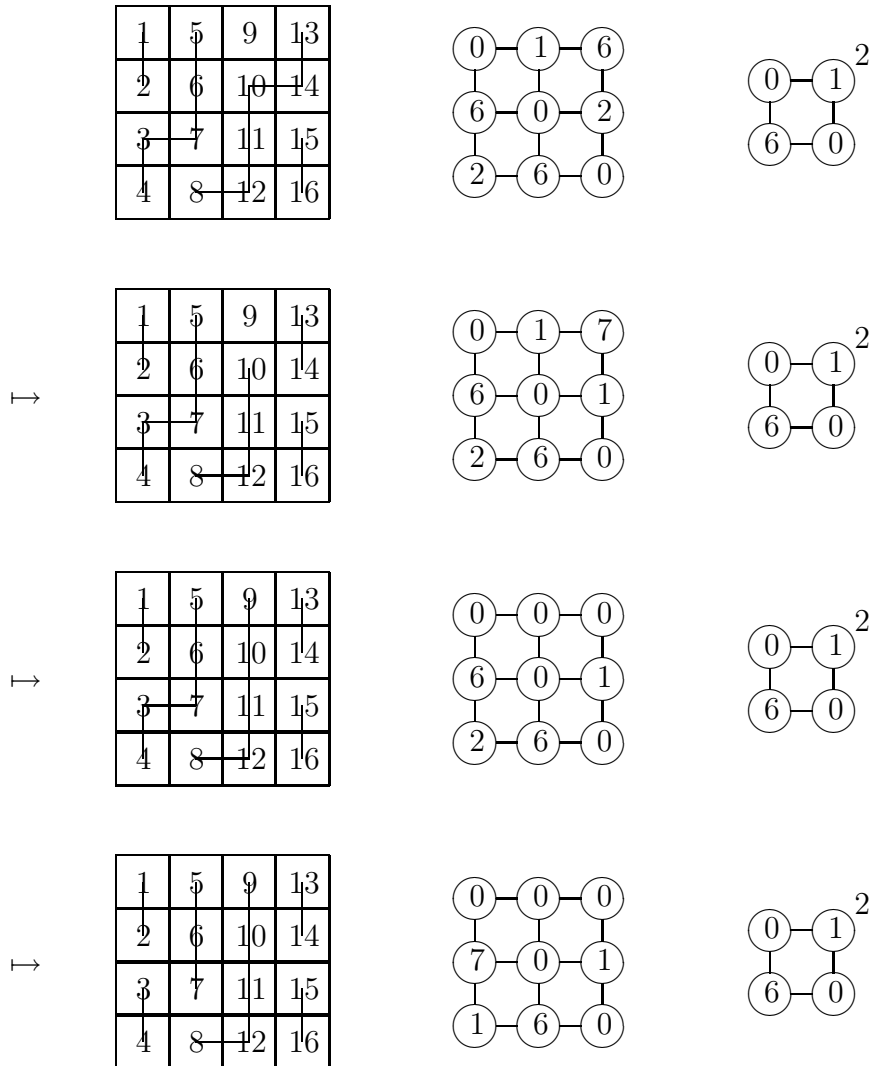

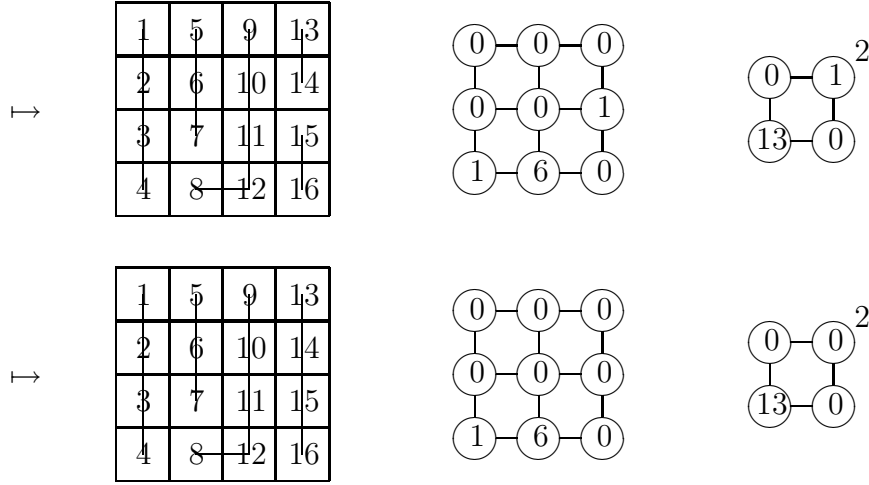

We may rearrange the above ordering using the Yang-Baxter relations (15) and (16), and doing so does not change the value of the product. We do this to obtain the following ordering.

$$\begin{aligned}
& f_{1,2} f_{1,3} f_{2,3} f_{1,4} f_{2,4} f_{3,4} (f_{1,5} f_{1,6}) f_{1,7} f_{2,5} (f_{2,6} f_{2,7}) f_{3,5} f_{3,6} f_{3,7} f_{4,5} f_{4,6} f_{4,7} f_{5,6} f_{5,7} f_{6,7} f_{8,9} f_{1,9} f_{2,9} f_{3,9} \\
& f_{4,9} f_{5,9} f_{6,9} f_{7,9} f_{8,10} f_{1,10} f_{2,10} f_{3,10} f_{4,10} (f_{5,10} f_{6,10}) f_{7,10} f_{9,10} f_{8,11} (f_{1,11} f_{2,11}) f_{3,11} f_{4,11} f_{5,11} (f_{6,11} f_{7,11}) \\
& f_{9,11} f_{10,11} f_{1,8} f_{1,12} (f_{2,8} f_{2,12}) (f_{3,8} f_{4,8}) f_{3,12} f_{4,12} f_{5,8} f_{5,12} f_{6,8} f_{6,12} (f_{7,8} f_{7,12}) f_{8,12} f_{9,12} f_{10,12} f_{11,12} f_{1,13} \\
& f_{1,14} f_{2,13} f_{2,14} f_{3,13} f_{3,14} f_{4,13} f_{4,14} f_{5,13} f_{5,14} f_{6,13} f_{6,14} f_{7,13} f_{7,14} f_{8,13} f_{8,14} (f_{9,13} f_{9,14}) f_{10,13} f_{10,14} f_{11,13} \\
& f_{11,14} f_{12,13} f_{12,14} f_{13,14} f_{1,15} f_{2,15} f_{3,15} f_{4,15} (f_{5,15} f_{6,15}) f_{7,15} f_{8,15} f_{9,15} (f_{10,15} f_{11,15}) f_{12,15} f_{13,15} f_{14,15} \\
& (f_{1,16} f_{2,16}) f_{3,16} f_{4,16} f_{5,16} (f_{6,16} f_{7,16}) f_{8,16} f_{9,16} f_{10,16} (f_{11,16} f_{12,16}) f_{13,16} f_{14,16} f_{15,16}
\end{aligned}$$

This ordering is shared by the previous six diagrams, hence their associated products all have the same value at $z_1 = \dots = z_n$. We now complete the chain, starting with our last diagram.

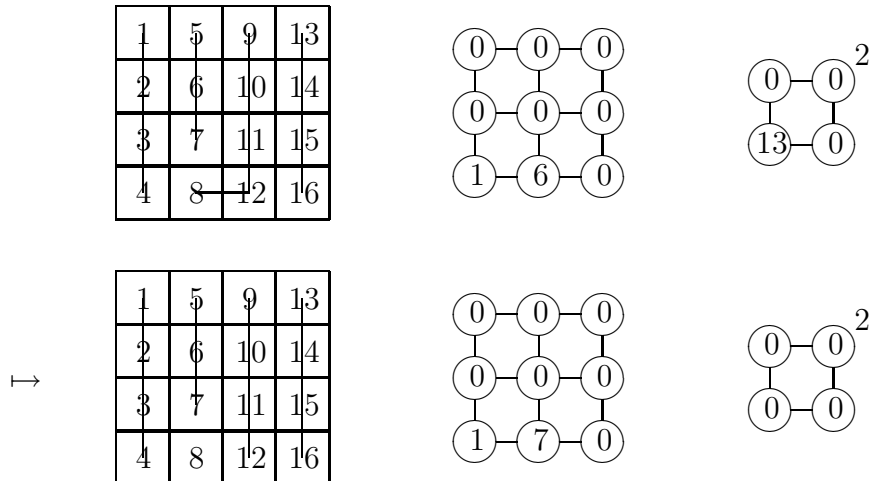

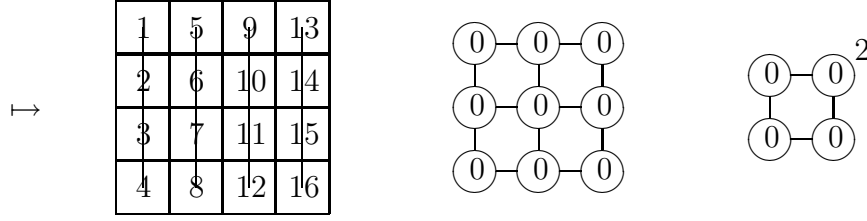

Finally, these last three diagrams share the following ordering and so have the same value at $z_1 = \dots = z_n$;

$$\begin{aligned}
& f_{1,2}f_{1,3}f_{2,3}f_{1,4}f_{2,4}f_{3,4}f_{1,5}f_{2,5}f_{3,5}f_{4,5} (f_{1,6}f_{2,6}) f_{3,6}f_{4,6}f_{5,6}f_{1,7} (f_{2,7}f_{3,7}) f_{4,7}f_{5,7}f_{6,7}f_{1,8}f_{2,8} (f_{3,8}f_{4,8}) \\
& f_{5,8}f_{6,8}f_{7,8}f_{1,9} (f_{1,10}f_{1,11}) f_{1,12}f_{2,9}f_{2,10} (f_{2,11}f_{2,12}) f_{3,9}f_{3,10}f_{3,11}f_{3,12}f_{4,9}f_{4,10}f_{4,11}f_{4,12} (f_{5,9}f_{5,10}) \\
& f_{5,11}f_{5,12}f_{6,9} (f_{6,10}f_{6,11}) f_{6,12}f_{7,9}f_{7,10} (f_{7,11}f_{7,12}) f_{8,9}f_{8,10}f_{8,11}f_{8,12}f_{9,10}f_{9,11}f_{9,12}f_{10,11}f_{10,12}f_{11,12} \\
& f_{1,13}f_{2,13}f_{3,13}f_{4,13}f_{5,13}f_{6,13}f_{7,13}f_{8,13}f_{10,13}f_{9,13}f_{11,13}f_{12,13}f_{1,14}f_{2,14}f_{3,14}f_{4,14}f_{5,14}f_{6,14}f_{7,14}f_{8,14} \\
& (f_{9,14}f_{10,14}) f_{11,14}f_{12,14}f_{13,14}f_{1,15}f_{2,15}f_{3,15}f_{4,15} (f_{5,15}f_{6,15}) f_{7,15}f_{8,15}f_{9,15} (f_{10,15}f_{11,15}) f_{12,15}f_{13,15} \\
& f_{14,15} (f_{1,10}f_{1,16}) f_{2,16}f_{3,16}f_{4,16}f_{5,16} (f_{6,16}f_{7,16}) f_{8,16}f_{9,16}f_{10,16} (f_{11,16}f_{12,16}) f_{13,16}f_{14,16}f_{15,16}
\end{aligned}$$

In particular the last diagram is the column diagram used in the column fusion procedure. We know the value of its associated product is the diagonal matrix element at $z_1 = \dots = z_n$, and hence this is the value in the limit for all the diagrams in the chain. ■

We now go some way to proving the opposite implication of Conjecture 5.5, that is to say, if the defining diagram is invalid then the associated product is not the diagonal matrix element in the limit $z_1 = \dots = z_n$.

Under the conditions imposed in the row, column and hook fusion procedures we found we had a removable singularity along the line $z_1 = \dots = z_n$. For rational polynomials, a singularity is removable exactly when there is an (improper) cancellation in the numerator and the denominator. We now have the following immediate consequence:

Proposition 5.11 *If the diagram Λ contains any 2×2 square of type $\textcircled{8}$ to $\textcircled{14}$ then the product $F_\Lambda(z_1, \dots, z_n)$ has a pole at $z_1 = \dots = z_n$.*

Proof. If (p, q) is a singularity of degree 1 and of type $\textcircled{8}$ to $\textcircled{14}$ then $z_p = z_q$ and there is no possible cancellation of $(z_p - z_q)$ on the subspace \mathcal{P}_Λ , hence the singularity is not removable, but is instead a pole. \blacksquare

Let us now consider the other kinds of invalid diagram, diagrams that contain a square of type $\textcircled{15}$ or contain a union excluded by Definition 5.4. Taking explicit examples, we identified a coefficient likely to have a pole at $z_1 = \dots = z_n$, and then used the software packages GAP and Maple to show if this was the case. These examples support the claim that the associated products $F_\Lambda(z_1, \dots, z_n)$ of invalid diagrams have a pole at $z_1 = \dots = z_n$. We give a couple of such examples below, for details see Appendix B.

Consider the column tableau, Λ^c , of the Young diagram $\lambda = (3, 3)$. We proceed to calculate the coefficient of one of the elements in the expansion of F_{Λ^c} , and show this coefficient has a pole in the limit $z_1 = \dots = z_n$. By observation we identify the permutation $(1\ 4\ 3\ 6)$ as one such possible permutation.

For comparison let us first consider the subspace defined in the row fusion procedure by the diagram

1	3	5
2	4	6

Maple calculates the coefficient of $(1\ 4\ 3\ 6)$ to be

$$\frac{2z_1^3 + 10z_1^2 + 12z_1 - 6z_1^2z_2 - 20z_1z_2 + 6z_1z_2^2 - 2z_2^3 + 10z_2^2 - 12z_2 - 1}{(z_1 - z_2 + 1)^3(z_1 - z_2 + 2)^2}.$$

So on the subspace where $z_1 = z_3 = z_5$, $z_2 = z_4 = z_6$ and $z_1 - z_2 \notin \mathbb{Z}$ there has been a cancellation of the term $(z_1 - z_2)$ in the numerator and denominator, hence the singularity is removable and the coefficient of $(1\ 4\ 3\ 6)$ tends to $-1/4$ in the limit $z_1 = z_2$.

Now consider an invalid diagram that contains a square of type $\textcircled{15}$

1	3	5
2	4	6

We also calculate the coefficient of $(1\ 4\ 3\ 6)$ on this subspace. The numerator of which is too large to reproduce here. However, importantly, the denominator contains the term $(z_1 - z_6)$ and so the singularity is not removable.

Finally we consider one more invalid diagram, a diagram that contains the union $\textcircled{3}$ – $\textcircled{5}$

1	3	5
2	4	6

We use Maple again to calculate the coefficient of $(1\ 4\ 3\ 6)$ on this subspace. Here the denominator contains the term $(z_1 - z_4)$, which again shows the singularity is not removable.

6 The hook fusion procedure for Hecke algebras

The Hecke algebra of type A is a quantum deformation of the symmetric group algebra. We adapt our hook fusion procedure of Chapter 3 to this new setting to construct an element that generates irreducible representations of this deformation. This is also the content of the author's second paper [Gr2].

6.1 Hecke algebras and affine Hecke algebras

We begin by defining the Hecke and the affine Hecke algebra of type A , for a description of these algebras of other types see [C3]. Let H_n be the finite dimensional Hecke algebra over the field $\mathbb{C}(q)$ of rational functions in q , with the generators T_1, \dots, T_{n-1} and the relations

$$(T_i - q)(T_i + q^{-1}) = 0; \quad (34)$$

$$T_i T_{i+1} T_i = T_{i+1} T_i T_{i+1}; \quad (35)$$

$$T_i T_j = T_j T_i, \quad j \neq i, i + 1 \quad (36)$$

for all possible indices i and j .

These generators are invertible in H_n since

$$T_i^{-1} = T_i - q + q^{-1} \quad (37)$$

due to (34).

As usual let $\sigma_i = (i, i + 1)$ be the adjacent transposition in the symmetric group S_n . Take any element $\sigma \in S_n$ and choose a reduced decomposition $\sigma = \sigma_{i_1} \dots \sigma_{i_l}$ and set $T_\sigma = T_{i_1} \dots T_{i_l}$. This element of the algebra H_n does not depend on the choice of reduced decomposition of σ due to (35) and (36). We denote the element of maximal length in S_n by σ_0 , but will write T_0 instead of T_{σ_0} for short. The elements T_σ form a basis of H_n as a vector space over the field $\mathbb{C}(q)$. We will also use the basis in H_n formed by the elements T_σ^{-1} .

If q is not a root of unity then the $\mathbb{C}(q)$ -algebra H_n is semisimple, for a short proof see [GU, Section 4]. Like irreducible representations of the symmetric

group S_n , the simple ideals of H_n are labeled by partitions λ of n . In this chapter we will construct a certain non-zero element $F_\Lambda \in H_n$ for any standard tableau Λ of shape λ . The element F_Λ is related to the q -analogue of the Young symmetrizer in the group ring $\mathbb{C}S_n$ constructed in [Gy]. Under left multiplication by the elements of H_n , the left ideal $H_n F_\Lambda \subset H_n$ is an irreducible H_n -module. The H_n -modules V_λ for different partitions λ are pairwise non-equivalent, see Corollary 6.21. Note, at $q = 1$, the algebra $H_n(q)$ specialises to the group ring $\mathbb{C}S_n$, where T_σ becomes the permutation $\sigma \in S_n$. The $H_n(q)$ -module V_λ then specialises to the irreducible representation of S_n , corresponding to the partition λ .

Let us also consider the *affine Hecke algebra* \widehat{H}_n is the $\mathbb{C}(q)$ -algebra generated by the elements T_1, \dots, T_{n-1} and the pairwise commuting invertible elements Y_1, \dots, Y_n subject to the relations (34)–(36) and

$$T_i Y_j = Y_j T_i, \quad j \neq i, i+1, \quad (38)$$

$$T_i Y_i T_i = Y_{i+1}. \quad (39)$$

By definition, the affine Hecke algebra \widehat{H}_n contains H_n as a subalgebra. And for any nonzero $z \in \mathbb{C}(q)$, one can define a homomorphism $\pi_z : \widehat{H}_n \rightarrow H_n$, identical on the subalgebra $H_n \subset \widehat{H}_n$, defined by $\pi_z(Y_1) = z$. It is completely defined due to (38). By pulling any irreducible H_n -module V back through the homomorphism π_z we obtain an irreducible module over the algebra \widehat{H}_n , called an *evaluation module* at z and denoted $V(z)$.

Specifically, setting $z = 1$ we have the homomorphism $\pi_1 : \widehat{H}_n \rightarrow H_n$, identical on the subalgebra $H_n \subset \widehat{H}_n$, defined by $\pi_1(Y_1) = 1$. Denote by X_i the expression

$$\pi_1(Y_i) = T_{i-1} \dots T_1 T_1 \dots T_{i-1}.$$

Using the relations (35), (36), and (37) one can check that and that the elements X_1, \dots, X_n are pairwise commuting and invertible in H_n . The elements X_1, \dots, X_n are called the *Murphy elements* [Mu2] of the Hecke algebra H_n .

To motivate the study of H_n -modules of hook shape let us consider certain

identities of representations of the Hecke algebra. Again we can think of the following identities as dual to the Jacobi-Trudi identities.

If $\lambda = (\lambda_1, \dots, \lambda_k)$ such that $n = \lambda_1 + \dots + \lambda_k$ then we have the following decomposition of the induced representation of the tensor product of modules corresponding to the rows of λ ;

$$\text{Ind}_{H_{\lambda_1} \times H_{\lambda_2} \times \dots \times H_{\lambda_k}}^{H_n} V_{(\lambda_1)} \otimes V_{(\lambda_2)} \otimes \dots \otimes V_{(\lambda_k)} \cong \bigoplus_{\mu} (V_{\mu})^{\oplus K_{\mu\lambda}}, \quad (40)$$

where the sum is over all partitions of n . Here $V_{(\lambda_i)}$ denotes the trivial representation of H_{λ_i} , that sends generators T_i to q . Again, the coefficients $K_{\mu\lambda}$ are Kostka numbers, with $K_{\lambda\lambda} = 1$.

Similarly we have the equivalent identity for columns,

$$\text{Ind}_{H_{\lambda'_1} \times H_{\lambda'_2} \times \dots \times H_{\lambda'_l}}^{H_n} V_{(1^{\lambda'_1})} \otimes V_{(1^{\lambda'_2})} \otimes \dots \otimes V_{(1^{\lambda'_l})} \cong \bigoplus_{\mu} (V_{\mu})^{\oplus K_{\mu'\lambda'}}, \quad (41)$$

where l is the number of columns of λ . In this case $V_{(1^{\lambda'_i})}$ is the alternating representation of $H_{\lambda'_i}$.

However, we are interested in the following identity related to the the Giambelli identity and the principal hooks of λ .

$$\text{Ind}_{H_{h_1} \times H_{h_2} \times \dots \times H_{h_d}}^{H_n} V_{(\alpha_1|\beta_1)} \otimes V_{(\alpha_2|\beta_2)} \otimes \dots \otimes V_{(\alpha_d|\beta_d)} \cong \bigoplus_{\mu} (V_{\mu})^{\oplus D_{\mu\lambda}}, \quad (42)$$

where h_i is the length of the i^{th} principal hook, and the sum is over all partitions of n . This is a decomposition of the induced representation of the tensor product of modules of hook shape. Further these hooks are the principal hooks of λ . The coefficients, $D_{\mu\lambda}$, are non-negative integers, and in particular $D_{\lambda\lambda} = 1$. The hook fusion procedure for Hecke algebras will provide a way of singling out the component V_{λ} in this decomposition.

6.2 The hook fusion procedure for Hecke algebras

For each $i = 1, \dots, n-1$ introduce the H_n -valued rational function in two variables $a \neq 0, a \neq b \in \mathbb{C}(q)$

$$F_i(a, b) = T_i + \frac{q - q^{-1}}{a^{-1}b - 1}. \quad (43)$$

Now introduce n variables $z_1, \dots, z_n \in \mathbb{C}(q)$. Equip the set of all pairs (i, j) where $1 \leq i < j \leq n$, with the following ordering. The pair (i, j) precedes another pair (i', j') if $j < j'$, or if $j = j'$ but $i < i'$. Call this the *reverse-lexicographic* ordering. Take the ordered product

$$F_\Lambda(z_1, \dots, z_n) = \prod_{(i,j)}^{\rightarrow} F_{j-i}(q^{2c_i(\Lambda)}z_i, q^{2c_j(\Lambda)}z_j) \quad (44)$$

over this set. Consider the product (44) as a rational function taking values in H_n , of the variables z_1, \dots, z_n . Note, if i and j sit on the same diagonal in the tableau Λ , then $F_{j-i}(q^{2c_i(\Lambda)}z_i, q^{2c_j(\Lambda)}z_j)$ has a pole at $z_i = z_j \neq 0$.

Let \mathcal{R}_Λ be the vector subspace in $\mathbb{C}(q)^n$ consisting of all tuples (z_1, \dots, z_n) such that $z_i = z_j$ whenever the numbers i and j appear in the same row of the tableau Λ .

As a direct calculation using (34) and (35) shows, these functions satisfy

$$F_i(a, b)F_{i+1}(a, c)F_i(b, c) = F_{i+1}(b, c)F_i(a, c)F_{i+1}(a, b). \quad (45)$$

Due to (36) these rational functions also satisfy the relations

$$F_i(a, b)F_j(c, d) = F_j(c, d)F_i(a, b); \quad j \neq i, i+1. \quad (46)$$

Using (45) and (46) we may reorder the product $F_\Lambda(z_1, \dots, z_n)$ such that each singularity is contained in an expression known to be regular at $z_1 = z_2 = \dots = z_n \neq 0$, [N2]. It is by this method that it was shown that the restriction of the rational function $F_\Lambda(z_1, \dots, z_n)$ to the subspace \mathcal{R}_Λ is regular at $z_1 = z_2 = \dots = z_n \neq 0$. Furthermore the following theorem was proved;

Theorem 6.1 (Nazarov) *Restriction to \mathcal{R}_Λ of the rational function $F_\Lambda(z_1, \dots, z_n)$ is regular at $z_1 = z_2 = \dots = z_n \neq 0$ and has value $F_\Lambda \in H_n$. The left ideal generated by this element is irreducible, and the H_n -modules for different partitions λ are pairwise non-equivalent.*

So, on the subspace \mathcal{R}_Λ , if $z_i/z_j \notin q^{\mathbb{Z}}$ when i and j are in different rows of Λ , the induced module (40) may be realised as the left ideal in H_n generated by $F_\Lambda(z_1, \dots, z_n)$. Hence Theorem 6.1 provides a way of singling out the irreducible component V_λ after taking the limit $z_1 = z_2 = \dots = z_n \neq 0$.

Similarly, we may form another expression for F_Λ by considering the subspace in $\mathbb{C}(q)^n$ consisting of all tuples (z_1, \dots, z_n) such that $z_i = z_j$ whenever the numbers i and j appear in the same column of the tableau Λ [N1]. Again, the irreducible representation V_λ that appears in the decomposition (41) may be formed from the ideal generated by $F_\Lambda(z_1, \dots, z_n)$ when $z_1 = z_2 = \dots = z_n \neq 0$.

Let \mathcal{H}_Λ be the vector subspace in $\mathbb{C}(q)^n$ consisting of all tuples (z_1, \dots, z_n) such that $z_i = z_j$ whenever the numbers i and j appear in the same principal hook of the tableau Λ . We will prove the following theorem.

Theorem 6.2 *Restriction to \mathcal{H}_Λ of the rational function $F_\Lambda(z_1, \dots, z_n)$ is regular at $z_1 = z_2 = \dots = z_n \neq 0$ and has value $F_\Lambda \in H_n$. The left ideal generated by this element is irreducible, and the H_n -modules for different partitions λ are pairwise non-equivalent. The element is the same as the element in Theorem 6.1.*

In particular, this hook fusion procedure can be used to form irreducible representations of H_n corresponding to Young diagrams of hook shape using only one auxiliary parameter, z . By taking this parameter to be 1 we find that no parameters are needed for diagrams of hook shape. Therefore if ν is a partition

of hook shape, and N a standard tableau of shape ν , we have

$$F_N = F_N(z) = \prod_{(p,q)}^{\rightarrow} F_{j-i}(q^{2c_i(\Lambda)}, q^{c_j(\Lambda)}), \quad (47)$$

with the pairs (i, j) in the product ordered reverse-lexicographically.

Example 6.3. Let $N = \begin{array}{|c|c|} \hline 1 & 3 \\ \hline 2 & \\ \hline \end{array}$ as before. Then on the subspace \mathcal{H}_N we have,

$$\begin{aligned} F_N &= \left(T_1 + \frac{q - q^{-1}}{q^{-2} - 1} \right) \left(T_2 + \frac{q - q^{-1}}{q^2 - 1} \right) \left(T_1 + \frac{q - q^{-1}}{q^4 - 1} \right) \\ &= T_1 T_2 T_1 + \frac{1}{q(q^2 + 1)} T_1 T_2 - q T_2 T_1 - \frac{1}{q^2 + 1} T_1 - \frac{1}{q^2 + 1} T_2 + \frac{q}{q^2 + 1}. \end{aligned}$$

When $q = 1$ this element becomes

$$(1 \ 3) + \frac{(1 \ 2 \ 3)}{2} - (1 \ 3 \ 2) - \frac{(1 \ 2)}{2} - \frac{(2 \ 3)}{2} + \frac{1}{2} 1.$$

Notice this element is not the diagonal matrix element described in Example 2.6, but rather it is the diagonal matrix element multiplied on the right by the longest element $\sigma_0 \in S_n$, which, in this case, is the element $\sigma_1 \sigma_2 \sigma_1 = (1 \ 3) \in S_3$. ■

On the subspace \mathcal{H}_Λ , if $z_i/z_j \notin q^{\mathbb{Z}}$ when i and j are in different principal hooks of Λ , the induced module (40) may be realised as the left ideal in H_n generated by $F_\Lambda(z_1, \dots, z_n)$. The irreducible representation V_λ appears in the decomposition of this induced module with coefficient 1, and is the ideal of H_n generated by $F_\Lambda(z_1, \dots, z_n)$ when $z_1 = z_2 = \dots = z_n \neq 0$. So, as promised, our hook fusion procedure will provide a way of singling out the irreducible component V_λ from the this induced module.

Consider (44) as a rational function of the variables z_1, \dots, z_n with values in H_n . Using the substitution

$$w_i = q^{c_i(\Lambda)} z_i, \quad (48)$$

the factor $F_i(w_a, w_b)$ has a pole at $z_a = z_b$ if and only if the numbers a and b stand on the same diagonal of a tableau Λ . So, as in Chapter 3, let us

again call the pair (a, b) a singularity, and the corresponding term $F_i(w_a, w_b)$ a singularity term, or simply a singularity.

Let a and b be in the same principal hook of Λ . If a and b are next to one another in the column of the hook then, on \mathcal{H}_λ , $F_i(w_a, w_b) = T_i - q$. Since

$$(T_i - q)^2 = -(q + q^{-1})(T_i - q) \quad (49)$$

then $\frac{-1}{q+q^{-1}}F_i(w_a, w_b)$ is an idempotent. Denote this idempotent P_i^- .

Similarly, if a and b are next to one another in the same row of the hook then $F_i(w_a, w_b) = T_i + q^{-1}$. And since

$$(T_i + q^{-1})^2 = (q + q^{-1})(T_i + q^{-1}) \quad (50)$$

then $\frac{1}{q+q^{-1}}F_i(w_a, w_b)$ is an idempotent. Denote this idempotent P_i^+ .

We also have

$$F_i(a, b)F_i(b, a) = 1 - \frac{(q - q^{-1})^2 ab}{(a - b)^2}. \quad (51)$$

Therefore, if the contents $c_a(\Lambda)$ and $c_b(\Lambda)$ differ by a number greater than one, then the factor $F_i(w_a, w_b)$ is invertible in H_n when $z_a = z_b \neq 0$ for all values of q .

The presence of singularity terms in the product $F_\Lambda(z_1, \dots, z_n)$ mean this product may or may not be regular on the vector subspace of \mathcal{H}_λ consisting of all tuples (z_1, \dots, z_n) such that $z_1 = z_2 = \dots = z_n \neq 0$. Using the following lemma, we will be able to show that $F_\Lambda(z_1, \dots, z_n)$ is indeed regular on this subspace.

Lemma 6.4 *Restriction of the rational function $F_i(a, b)F_{i+1}(a, c)F_i(b, c)$ to the set of (a, b, c) such that $a = q^{\pm 2}b$, is regular at $a = c \neq 0$.*

Proof. If we write $F_{i+1}(a, c)$ in full, one may expand the left hand side of (45) and obtain the sum

$$F_i(a, b)T_{i+1}F_i(b, c) + \frac{q - q^{-1}}{a^{-1}c - 1}F_i(a, b)F_i(b, c).$$

Here the restriction to $a = q^{\pm 2}b$ of the first summand is evidently regular at $a = c$. After the substitution $b = q^{\mp 2}a$, the second summand takes the form

$$\frac{q - q^{-1}}{a^{-1}c - 1}(T_i \mp q^{\pm 1})\left(T_i + \frac{q - q^{-1}}{q^{\pm 2}a^{-1}c - 1}\right) = \frac{q - q^{-1}}{a^{-1}c - q^{\mp 2}}(q^{\pm 1} \mp T_i).$$

The rational function of a, c at the right hand side of the last displayed equality is also evidently regular at $a = c$. ■

In particular, if the middle term on the left hand side of (45) is a singularity and the other two terms are an appropriate idempotent and triple term, then this three term product is regular at $z_1 = z_2 = \dots = z_n \neq 0$. we may now prove the first statement of Theorem 6.2.

Proposition 6.5 *The restriction of the rational function $F_{\Lambda}(z_1, \dots, z_n)$ to the subspace \mathcal{H}_{Λ} is regular at $z_1 = z_2 = \dots = z_n \neq 0$.*

Proof. Consider any standard tableau Λ' obtained from the tableau Λ by an adjacent transposition of its entries, say by $\sigma_k \in S_n$. Using the relations (45) and (46), we derive the equality of rational functions in the variables z_1, \dots, z_n

$$\begin{aligned} F_{\Lambda}(z_1, \dots, z_n)F_{n-k}(q^{2c_{k+1}(\Lambda)}z_{k+1}, q^{2c_k(\Lambda)}z_k) = \\ F_k(q^{2c_k(\Lambda)}z_k, q^{2c_{k+1}(\Lambda)}z_{k+1})F_{\Lambda'}(z'_1, \dots, z'_n), \end{aligned} \quad (52)$$

where the sequence of variables (z'_1, \dots, z'_n) is obtained from the sequence (z_1, \dots, z_n) by exchanging the terms z_k and z_{k+1} . Observe that

$$(z'_1, \dots, z'_n) \in \mathcal{H}_{\Lambda'} \iff (z_1, \dots, z_n) \in \mathcal{H}_{\Lambda}.$$

Also observe that here $|c_k(\Lambda) - c_{k+1}(\Lambda)| \geq 2$ because the tableaux Λ and Λ' are standard. Therefore the functions

$$F_k(q^{2c_k(\Lambda)}z_k, q^{2c_{k+1}(\Lambda)}z_{k+1}) \quad \text{and} \quad F_{n-k}(q^{2c_{k+1}(\Lambda)}z_{k+1}, q^{2c_k(\Lambda)}z_k)$$

appearing in the equality (52), are regular at $z_k = z_{k+1} \neq 0$. Moreover, their values at $z_k = z_{k+1} \neq 0$ are invertible in the algebra H_n , see the relation (51). Due to these two observations, the equality (52) shows that Proposition 6.5 is equivalent to its counterpart for the tableau Λ' instead of Λ .

Let us take the hook tableau Λ° of shape λ , as described in Section 3. There is a chain $\Lambda, \Lambda', \dots, \Lambda^\circ$ of standard tableaux of the same shape λ , such that each subsequent tableau in the chain is obtained from the previous one by an adjacent transposition of the entries. Due to the above argument, it now suffices to prove Proposition 6.5 only in the case $\Lambda = \Lambda^\circ$.

We will prove the statement by reordering the factors of the product $F_{\Lambda^\circ}(z_1, \dots, z_n)$, using relations (45) and (46), in such a way that each singularity is part of a triple which is regular at $z_1 = z_2 = \dots = z_n \neq 0$, and hence the whole of $F_{\Lambda^\circ}(z_1, \dots, z_n)$ will be manifestly regular.

Define $g(a, b)$ to be the following;

$$g(a, b) = \begin{cases} F_{b-a}(w_a, w_b) & \text{if } a < b \\ 1 & \text{if } a \geq b \end{cases}$$

where w_i is the substitution (48).

Now, let us divide the diagram λ into two parts, consisting of those boxes with positive contents and those with non-positive contents as in Figure 3. Consider the entries of the i^{th} column of the hook tableau Λ° of shape λ that lie below the steps. If u_1, u_2, \dots, u_k are the entries of the i^{th} column below the steps, we define

$$C_i = \prod_{j=1}^n g(u_1, j)g(u_2, j) \cdots g(u_k, j). \quad (53)$$

Now consider the entries of the i^{th} row of Λ° that lie above the steps. If v_1, v_2, \dots, v_l are the entries of the i^{th} row above the steps, we define

$$R_i = \prod_{j=1}^n g(v_1, j)g(v_2, j) \cdots g(v_l, j). \quad (54)$$

Our choice of the hook tableau was such that the following is true; if d is the number of principal hooks of λ then by relations (45) and (46) we may reorder the factors of $F_{\Lambda^\circ}(z_1, \dots, z_n)$ such that

$$F_{\Lambda^\circ}(z_1, \dots, z_n) = \prod_{i=1}^d C_i R_i.$$

Now, each singularity (a, b) has its corresponding term $F_{b-a}(w_a, w_b)$ contain in some product C_i or R_i . This singularity term will be on the immediate left of the term $F_{b-a-1}(w_{a+1}, w_b)$. Also, this ordering has been chosen such that the product of factors to the left of any such singularity in C_i or R_i is divisible on the right by $F_{b-a-1}(w_a, w_{b+1})$.

Therefore we can replace the pair $F_{b-a}(w_a, w_b)F_{b-a-1}(w_{a+1}, w_b)$ in C_i by the triple

$$P_{b-a-1}^- F_{b-a}(w_a, w_b) F_{b-a-1}(w_{a+1}, w_b),$$

where $P_{b-a-1}^- = \frac{-1}{q+q^{-1}} F_{b-a-1}(w_a, w_{a+1})$ is the idempotent (49). Divisibility on the right by $F_{b-a-1}(w_a, w_{a+1})$ means the addition of the idempotent has no effect on the value of the product C_i . Similarly, in the product R_i we can replace the pair by

$$P_{b-a-1}^+ F_{b-a}(w_a, w_b) F_{b-a-1}(w_{a+1}, w_b).$$

By Lemma 6.4, the above triples are regular at $z_1 = z_2 = \dots = z_n \neq 0$, and therefore, so too are the products C_i and R_i , for all $1 \leq i \leq d$. Moreover, this means $F_{\Lambda^\circ}(z_1, \dots, z_n)$ is regular at $z_1 = z_2 = \dots = z_n \neq 0$. \blacksquare

Example 6.6. As an example consider the hook tableau of the Young diagram $\lambda = (3, 3, 2)$, as shown in Example 3.2.

In the original reverse-lexicographic ordering the product $F_{\Lambda^\circ}(z_1, \dots, z_n)$ is written as;

$$\begin{aligned} F_{\Lambda^\circ}(z_1, \dots, z_n) = & F_1(w_1, w_2) F_2(w_1, w_3) F_1(w_2, w_3) F_3(w_1, w_4) F_2(w_2, w_4) F_1(w_3, w_4) \\ & F_4(w_1, w_5) F_3(w_2, w_5) F_2(w_3, w_5) F_1(w_4, w_5) F_5(w_1, w_6) F_4(w_2, w_6) \\ & F_3(w_3, w_6) F_2(w_4, w_6) F_1(w_5, w_6) F_6(w_1, w_7) F_5(w_2, w_7) F_4(w_3, w_7) \\ & F_3(w_4, w_7) F_3(w_4, w_7) F_2(w_5, w_7) F_1(w_6, w_7) F_7(w_1, w_8) F_6(w_2, w_8) \\ & F_5(w_3, w_8) F_4(w_4, w_8) F_3(w_5, w_8) F_2(w_6, w_8) F_1(w_7, w_8) \end{aligned}$$

we may now reorder this product into the form below using relations (45) and (46) as described in the above proposition. The terms bracketed are the

singularity terms with their appropriate triple terms.

$$\begin{aligned}
F_{\Lambda^\circ}(z_1, \dots, z_n) = & F_1(w_1, w_2)F_2(w_1, w_3)F_1(w_2, w_3)F_3(w_1, w_4)F_2(w_2, w_4)F_1(w_3, w_4) \\
& F_4(w_1, w_5)F_3(w_2, w_5)F_2(w_3, w_5) (F_5(w_1, w_6)F_4(w_2, w_6)) F_3(w_3, w_6) \\
& F_6(w_1, w_7) (F_5(w_2, w_7)F_4(w_3, w_7)) F_7(w_1, w_8)F_6(w_2, w_8)F_5(w_3, w_8) \\
& \cdot F_1(w_4, w_5)F_2(w_4, w_6)F_1(w_5, w_6)F_3(w_4, w_7)F_2(w_5, w_7) \\
& (F_4(w_4, w_8)F_3(w_5, w_8)) \cdot F_1(w_6, w_7)F_2(w_6, w_8)F_1(w_7, w_8)
\end{aligned}$$

We may now add the appropriate idempotents to these singularity-triple term pairs to form triples. Since each of these triples are regular at $z_1 = z_2 = \dots = z_n$ then so too is the whole of $F_{\Lambda^\circ}(z_1, \dots, z_n)$. \blacksquare

Therefore, due to the above proposition an element $F_\Lambda \in H_n$ can now be defined as the value of $F_{\Lambda^\circ}(z_1, \dots, z_n)$ at $z_1 = z_2 = \dots = z_n \neq 0$. Note that for $n = 1$ we have $F_\Lambda = 1$. For any $n \geq 1$, take the expansion of the element $F_\Lambda \in H_n$ in the basis of the elements T_σ where σ is ranging over S_n .

Proposition 6.7 *The coefficient in $F_\Lambda \in H_n$ of the element T_0 is 1.*

Proof. Expand the product (44) as a sum of the elements T_σ with coefficients from the field of rational functions of z_1, \dots, z_n ; these functions take values in $\mathbb{C}(q)$. The decomposition in S_n with ordering of the pairs (i, j) as in (44)

$$\sigma_0 = \prod_{(i,j)}^{\rightarrow} \sigma_{j-i}$$

is reduced, hence the coefficient at $T_0 = T_{\sigma_0}$ in the expansion of (44) is 1. By the definition of F_Λ , then the coefficient of T_0 in F_Λ must be also 1 \blacksquare

In particular this shows that $F_\Lambda \neq 0$ for any nonempty diagram λ . Let us now denote by φ the involutive antiautomorphism of the algebra H_n over the field $\mathbb{C}(q)$, defined by $\varphi(T_i) = T_i$ for every $i \in 1, \dots, n - 1$.

Proposition 6.8 *The element $F_\Lambda T_0^{-1}$ is φ -invariant.*

Proof. Any element of the algebra H_n of the form $F_i(a, b)$ is φ -invariant. Hence applying the antiautomorphism φ to an element of H_n the form (44) just reverses the ordering of the factors corresponding to the pairs (i, j) . Using the relations (45) and (46), we can rewrite the reversed product as

$$\overrightarrow{\prod}_{(i,j)} F_{n-j+i}(q^{2c_i(\Lambda)} z_i, q^{2c_j(\Lambda)} z_j)$$

where the pairs (i, j) are again ordered as in (44). But due to (35) and (36), we also have the identity in the algebra H_n

$$F_{n-i}(a, b)T_0 = T_0 F_i(a, b).$$

This identity along with the equality $\varphi(T_0) = T_0$ implies that any value of the function $F_\Lambda(z_1, \dots, z_n)T_0^{-1}$ is φ -invariant. So is the element $F_\Lambda T_0^{-1} \in H_n$ ■

Proposition 6.9 *If $\lambda = (\alpha_1, \alpha_2, \dots, \alpha_d | \beta_1, \beta_2, \dots, \beta_d)$ and*

$\mu = (\alpha_{k+1}, \alpha_{k+2}, \dots, \alpha_d | \beta_{k+1}, \beta_{k+2}, \dots, \beta_d)$, then $F_{\Lambda^\circ} = P \cdot F_{M^\circ}$, for some element $P \in H_n$.

Proof. Here the shape μ is obtained by removing the first k principal hooks of λ . Let x be last entry in the k^{th} row of the hook tableau of shape λ . By the ordering described in Proposition 6.5,

$$F_{\Lambda^\circ}(z_1, \dots, z_n) = \prod_{i=1}^k C_i R_i \cdot F_{M^\circ}(z_{x+1}, \dots, z_n),$$

where C_i and R_i are defined by (53) and (54).

Since all products C_i and R_i are regular at $z_1 = z_2 = \dots = z_n \neq 0$, Proposition 6.5 then gives us the required statement. ■

To prove the following divisibilities we require to form new singularity and triple term pairs, in which case we must form a new ordering. We will give explicit examples below.

Proposition 6.10 *Suppose the numbers $u < v$ stand next to each other in the same column of the hook tableau Λ° of shape λ . First, let s be the last entry in the row containing u . If $c_v < 0$ then the element $F_{\Lambda^\circ} \in H_n$ is divisible on the left by $F_u(q^{2c_u(\Lambda^\circ)}, q^{2c_v(\Lambda^\circ)}) = T_u - q$. If $c_v \geq 0$ then the element $F_{\Lambda^\circ} \in H_n$ is divisible on the left by the product*

$$\prod_{i=u, \dots, s}^{\leftarrow} \left(\prod_{j=s+1, \dots, v}^{\rightarrow} F_{i+j-s-1}(q^{2c_i(\Lambda^\circ)}, q^{2c_j(\Lambda^\circ)}) \right)$$

Proof. Let λ and μ be as in Proposition 6.9 with λ a partition of n and μ a partition of m . If $F_M(z_1, \dots, z_m)$ is divisible on the left by $F_i(w_a, w_b)$ then $F_M(z_{x+1}, \dots, z_n)$ is divisible on the left by $F_i(w_{a+x}, w_{b+x})$. Then, by Proposition 6.8, $F_M(z_{x+1}, \dots, z_n)$ is divisible on the right by $F_{m-i}(w_{a+x}, w_{b+x})$. Therefore, by Proposition 6.9, $F_{\Lambda^\circ}(z_1, \dots, z_n)$ is divisible on the right by $F_{m-i}(w_{a+x}, w_{b+x})$ and so $F_{\Lambda^\circ}(z_1, \dots, z_n)$ is divisible on the left by $F_{n-m+i}(w_{a+x}, w_{b+x}) = F_{i+x}(w_{a+x}, w_{b+x})$. Hence we only need to prove the statement for (u, v) such that u is in the first row or first column of Λ° .

Let r be the last entry in the first column of Λ° , s the last entry in the first row of Λ° , and t the last entry in the second column of Λ° , as shown in the proof of Proposition 3.9.

We now continue this proof by considering three cases and showing the appropriate divisibility in each.

(i) If $c_v < 0$ (i.e. u and v are in the first column of Λ°) then $v = u + 1$ and $F_{\Lambda^\circ}(z_1, \dots, z_n)$ can be written as $F_{\Lambda^\circ}(z_1, \dots, z_n) = F_u(w_u, w_v) \cdot F$.

Starting with $F_{\Lambda^\circ}(z_1, \dots, z_n)$ written in the ordering described in Proposition 6.5 and simply moving the term $F_{v-u}(w_u, w_v)$ to the left results in all the singularity terms in the product F remaining tied to the same triple terms as originally described in that ordering, and the index of $F_{v-u}(w_u, w_v)$ increases from $u - v$ to u . Therefore we may still form regular triples for each singularity in F , and hence F is regular at $z_1 = z_2 = \dots = z_n \neq 0$.

So by considering this expression for $F_{\Lambda^\circ}(z_1, \dots, z_n)$ at $z_1 = z_2 = \dots = z_n \neq 0$

we see that F_{Λ° will be divisible on the left by $F_u(q^{2c_u(\Lambda^\circ)}, q^{2c_v(\Lambda^\circ)}) = T_{v-u} - q$.

(ii) If $c_v = 0$ then $v = s + 1$, and $F_{\Lambda^\circ}(z_1, \dots, z_n)$ can be written as

$$F_{\Lambda^\circ}(z_1, \dots, z_n) = \prod_{i=u, \dots, s}^{\leftarrow} F_i(w_i, w_{s+1}) \cdot F'.$$

Again, starting with the ordering described in Proposition 6.5, this results in all the singularity terms in the product F' remaining tied to the same triple terms as originally described in that ordering. Hence F' is regular at $z_1 = z_2 = \dots = z_n \neq 0$. And so F_{Λ° is divisible on the left by

$$\prod_{i=u, \dots, s}^{\leftarrow} F_i(q^{2c_i(\Lambda^\circ)}, q^{2c_{s+1}(\Lambda^\circ)}).$$

(iii) If $c_v > 0$ (i.e. v is above the steps) then $F_{v-u}(w_u, w_v)$ is tied to the singularity $F_{v-u+1}(w_{u-1}, w_v)$ as a triple term. To show divisibility by $F_{v-u}(w_u, w_v)$ in this case we need an alternative expression for $F_{\Lambda^\circ}(z_1, \dots, z_n)$ that is regular when $z_1 = z_2 = \dots = z_n \neq 0$. Define a permutation τ as follows,

$$\begin{aligned} \tau &= \prod_{i=u, \dots, s}^{\rightarrow} \left(\prod_{j=s+1, \dots, v}^{\leftarrow} (ij) \right) \\ &= \left(\begin{array}{cccccccccccccccc} 1 & 2 & \dots & u-1 & u & u+1 & \dots & \dots & \dots & \dots & \dots & v-1 & v & v+1 & \dots & n \\ 1 & 2 & \dots & u-1 & s+1 & s+2 & \dots & v-1 & v & u & u+1 & \dots & s-1 & s & v+1 & \dots & n \end{array} \right) \end{aligned}$$

From the definition of C_1 in (53) we now define $C'_1 = \psi_\tau C_1$, where ψ_τ is a homomorphism such that

$$\psi_\tau F_{j-i}(w_i, w_j) = F_{j-i}(w_i, w_{\tau j}).$$

Define R'_1 as,

$$\begin{aligned}
R'_1 &= \prod_{i=r+2, \dots, u-1}^{\leftarrow} \left(\prod_{j=s+1, \dots, v}^{\rightarrow} F_{i+j-s-r-1}(w_i, w_j) \right) \\
&\times \prod_{i=s+1, \dots, t-1}^{\rightarrow} \left(\prod_{j=i+1, \dots, t}^{\rightarrow} F_{j-i+1}(w_i, w_j) \right) \cdot \left(\prod_{j=s+1, \dots, t}^{\leftarrow} F_{t+1-j}(w_{r+1}, w_j) \right) \\
&\times \left(\prod_{j=t+1, \dots, v}^{\rightarrow} F_{j-s}(w_{r+1}, w_j) \right) \cdot \prod_{i=r+1, \dots, s-1}^{\rightarrow} \left(\prod_{j=i+1, \dots, s}^{\rightarrow} F_{j-i+v-s}(w_i, w_j) \right) \\
&\times \prod_{j=v+1, \dots, n}^{\rightarrow} \left(\prod_{i=r+1, \dots, s}^{\rightarrow} F_{j-i}(w_i, w_j) \right).
\end{aligned}$$

Finally, define C'_2 as,

$$C'_2 = \prod_{j=t+1, \dots, n}^{\rightarrow} \left(\prod_{i=s+1, \dots, t}^{\rightarrow} F_{j-i}(w_i, w_j) \right).$$

Then,

$$F_\Lambda(z_1, \dots, z_n) = \prod_{i=u, \dots, s}^{\leftarrow} \left(\prod_{j=s+1, \dots, v}^{\rightarrow} F_{i+j-s-1}(w_i, w_j) \right) \cdot C'_1 R'_1 C'_2 R_2 \cdot \prod_{i=3}^d C_i R_i,$$

where d is the number of principal hooks of λ .

The product $C'_1 R'_1 C'_2 R_2 \cdot \prod C_i R_i$ is regular at $z_1 = z_2 = \dots = z_n \neq 0$ since, as before, for any singularity (a, b) the terms $F_i(w_a, w_b) F_{i-1}(w_{a+1}, w_b)$ can be replaced by the triple $P_{i-1}^\pm F_i(w_a, w_b) F_{i-1}(w_{a+1}, w_b)$ for some index i – except in the expression R'_1 where the terms $F_{i-1}(w_a, w_l) F_i(w_a, w_b)$ are replaced by $F_{i-1}(w_a, w_l) F_i(w_a, w_b) P_{i-1}^+$, where l is the entry to the immediate left of b . Note that $l = b - 1$ when $c_b(\Lambda^\circ) > 1$ and $l = s + 1$ when $c_b(\Lambda^\circ) = 1$.

And so by letting $z_1 = z_2 = \dots = z_n \neq 0$ we see that F_{Λ° is divisible on the left by

$$\prod_{i=u, \dots, s}^{\leftarrow} \left(\prod_{j=s+1, \dots, v}^{\rightarrow} F_{i+j-s-1}(q^{2c_i(\Lambda^\circ)}, q^{2c_j(\Lambda)}) \right).$$

■

Proposition 6.11 *Suppose the numbers $u < v$ stand next to each other in the same row of the hook tableau Λ° of shape λ . Let r be the last entry in the column containing u . If $c_u > 0$ then the element $F_{\Lambda^\circ} \in H_n$ is divisible on the left by $F_u(q^{2c_u(\Lambda^\circ)}, q^{c_v(\Lambda^\circ)}) = T_u + q^{-1}$. If $c_u \leq 0$ then the element $F_{\Lambda^\circ} \in H_n$ is divisible on the left by the product*

$$\prod_{i=u, \dots, r}^{\leftarrow} \left(\prod_{j=r+1, \dots, v}^{\rightarrow} F_{i+j-r-1}(q^{c_i(\Lambda^\circ)}, q^{c_j(\Lambda^\circ)}) \right)$$

Proof. Suppose u is to the immediate left of v in some row of Λ° . As in the proof of Proposition 6.10, we need only consider (u, v) such that u is in the first row or first column of Λ° . Let r be the last entry in the first column of Λ° and s the last entry in the first row of λ .

As in the proof of Proposition 6.10, we consider three cases.

(i) If $c_u > 0$ (i.e. u and v are in the first row of Λ°) then $v = u + 1$ and $F_{\Lambda^\circ}(z_1, \dots, z_n)$ can be written as $F_{\Lambda^\circ}(z_1, \dots, z_n) = F_u(w_u, w_v) \cdot F$. Singularity terms in the product F remaining tied to the same triple terms as originally described in Proposition 6.5, hence F is regular at $z_1 = z_2 = \dots = z_n \neq 0$. By considering this expression for $F_{\Lambda^\circ}(z_1, \dots, z_n)$ at $z_1 = z_2 = \dots = z_n \neq 0$ we see that F_{Λ° will be divisible on the left by $F_u(q^{2c_u(\Lambda^\circ)}, q^{2c_v(\Lambda^\circ)}) = T_u + q^{-1}$.

(ii) If $c_u = 0$ then $u = 1$, $v = r + 1$, and $F_{\Lambda^\circ}(z_1, \dots, z_n)$ can be written as

$$F_{\Lambda^\circ}(z_1, \dots, z_n) = \prod_{i=1, \dots, r}^{\leftarrow} F_i(w_i, w_{r+1}) \cdot F'.$$

Again, singularities in F' remain tied to the same triple terms as originally described in Proposition 6.5. And so F_{Λ° is divisible on the left by

$$\prod_{i=1, \dots, r}^{\leftarrow} F_i(q^{2c_i(\Lambda^\circ)}, q^{2c_{r+1}(\Lambda^\circ)}).$$

(iii) If $c_u < 0$ (i.e. v is below the steps) then $F_{v-u}(w_u, w_v)$ is tied to the singularity $F_{v-u+1}(w_{u-1}, w_v)$ as a triple term.

Define C_1'' as,

$$\begin{aligned}
C_1'' &= \prod_{i=2, \dots, u-1}^{\leftarrow} \left(\prod_{j=r+1, \dots, v}^{\rightarrow} F_{i+j-r-1}(w_i, w_j) \right) \\
&\times \prod_{i=r+1, \dots, s-1}^{\rightarrow} \left(\prod_{j=i+1, \dots, s}^{\rightarrow} F_{j-i+1}(w_i, w_j) \right) \cdot \left(\prod_{j=r+1, \dots, s}^{\leftarrow} F_{s+1-j}(w_i, w_j) \right) \\
&\times F_{s-r+1}(w_1, w_{s+1}) \cdot \left(\prod_{i=r+1, \dots, s}^{\rightarrow} F_{s+1-i}(w_i, w_{s+1}) \right) \\
&\times \left(\prod_{j=s+2, \dots, v}^{\rightarrow} F_{j-r}(w_1, w_j) \right) \cdot \prod_{i=1, \dots, r-1}^{\rightarrow} \left(\prod_{j=i+1, \dots, r}^{\rightarrow} F_{j-i+v-r}(w_i, w_j) \right) \\
&\times \prod_{j=v+1, \dots, n}^{\rightarrow} \left(\prod_{i=1, \dots, r}^{\rightarrow} F_{j-i}(w_i, w_j) \right),
\end{aligned}$$

and define R_1'' as,

$$R_1'' = \prod_{j=s+2, \dots, n}^{\rightarrow} \left(\prod_{i=r+1, \dots, s}^{\rightarrow} F_{j-i}(w_i, w_j) \right).$$

Then,

$$F_{\Lambda^\circ}(z_1, \dots, z_n) = \prod_{i=u, \dots, r}^{\leftarrow} \left(\prod_{j=r+1, \dots, v}^{\rightarrow} F_{i+j-r-1}(w_i, w_j) \right) \cdot C_1'' R_1'' \cdot \prod_{i=2}^d C_i R_i,$$

where d is the number of principal hooks of λ .

The product $C_1'' R_1'' \cdot \prod C_i R_i$ is regular at $z_1 = z_2 = \dots = z_n \neq 0$ since, as before, for any singularity (a, b) the terms $F_i(w_a, w_b) F_{i-1}(w_{a+1}, w_b)$ can be replaced by the triple $P_{i-1}^\pm F_i(w_a, w_b) F_{i-1}(w_{a+1}, w_b)$ for some index i – except in the expression C_1'' where $F_{s-r+1}(w_1, w_{s+1}) F_{s-r}(w_{r+1}, w_{s+1})$ is replaced by $P_{s-r}^+ F_{s-r+1}(w_1, w_{s+1}) F_{s-r}(w_{r+1}, w_{s+1})$, and $F_{i-1}(w_a, w_{b-1}) F_i(w_a, w_b)$ is replaced by $F_{i-1}(w_a, w_{b-1}) F_i(w_a, w_b) P_{i-1}^-$ for all other singularities (a, b) in C_1'' . And so by letting $z_1 = z_2 = \dots = z_n \neq 0$ we see that F_{Λ° is divisible on the left by

$$\prod_{i=u, \dots, r}^{\leftarrow} \left(\prod_{j=r+1, \dots, v}^{\rightarrow} F_{i+j-r-1}(q^{2c_i(\Lambda^\circ)}, q^{2c_j(\Lambda^\circ)}) \right).$$

■

Let us now consider an example that allows us to see how the product $F_{\Lambda^\circ}(z_1, \dots, z_n)$ is broken down in the proofs of Proposition 6.10 and Proposition 6.11.

Example 6.12. We again consider the hook tableau of the Young diagram $\lambda = (3, 3, 2)$.

We begin with the product $F_{\Lambda^\circ}(z_1, \dots, z_n)$ in the ordering described in Proposition 6.5. We have also marked out the singularities in this expansion along with their triple terms, but no idempotents have yet been added which would form regular triples.

$$\begin{aligned}
F_{\Lambda^\circ}(z_1, \dots, z_n) = & F_1(w_1, w_2)F_2(w_1, w_3)F_1(w_2, w_3)F_3(w_1, w_4)F_2(w_2, w_4)F_1(w_3, w_4) \\
& F_4(w_1, w_5)F_3(w_2, w_5)F_2(w_3, w_5)(F_5(w_1, w_6)F_4(w_2, w_6))F_3(w_3, w_6) \\
& F_6(w_1, w_7)(F_5(w_2, w_7)F_4(w_3, w_7))F_7(w_1, w_8)F_6(w_2, w_8)F_5(w_3, w_8) \\
& \cdot F_1(w_4, w_5)F_2(w_4, w_6)F_1(w_5, w_6)F_3(w_4, w_7)F_2(w_5, w_7) \\
& (F_4(w_4, w_8)F_3(w_5, w_8)) \cdot F_1(w_6, w_7)F_2(w_6, w_8)F_1(w_7, w_8)
\end{aligned} \tag{55}$$

Let $u = 4$ and $v = 6$ in Proposition 6.10. Then by that proposition we may arrange the above product as follows. Notice since $c_v = 0$ all singularity-triple term pairs remain the same.

$$\begin{aligned}
F_{\Lambda^\circ}(z_1, \dots, z_n) = & F_5(w_5, w_6)F_4(w_4, w_6) \cdot F_1(w_1, w_2)F_2(w_1, w_3)F_1(w_2, w_3)(F_3(w_1, w_6) \\
& F_2(w_2, w_6))F_1(w_3, w_6)F_4(w_1, w_4)F_3(w_2, w_4)F_2(w_3, w_4)F_5(w_1, w_5) \\
& F_4(w_2, w_5)F_3(w_3, w_5)F_6(w_1, w_7)(F_5(w_2, w_7)F_4(w_3, w_7))F_7(w_1, w_8) \\
& F_6(w_2, w_8)F_5(w_3, w_8) \cdot F_2(w_4, w_5)F_3(w_4, w_7)F_2(w_5, w_7) \\
& (F_4(w_4, w_8)F_3(w_5, w_8)) \cdot F_1(w_6, w_7)F_2(w_6, w_8)F_1(w_7, w_8)
\end{aligned}$$

We may now add the appropriate idempotents so that all singularities remain in regular triples. And so by considering the product at $z_1 = z_2 = \dots = z_n \neq 0$ we have that F_{Λ° is divisible on the left by $T_4 - q$, preceded only by invertible terms, as desired.

Now let $u = 3$ and $v = 7$ in Proposition 6.11. Then by that proposition we may arrange (55) as follows. Singularities in C_1 have been marked out with their alternative triple terms, while all other singularity-triple term pairs remain the same.

$$\begin{aligned}
F_{\Lambda^\circ}(z_1, \dots, z_n) = & F_3(w_3, w_4)F_4(w_3, w_5)F_5(w_3, w_6)F_6(w_3, w_7) \cdot F_2(w_2, w_4)F_3(w_2, w_5) \\
& (F_4(w_2, w_6)F_5(w_2, w_7)) \cdot F_2(w_4, w_5) \cdot F_1(w_1, w_5)(F_2(w_1, w_4) \cdot F_3(w_1, w_6)) \\
& \cdot F_2(w_4, w_6)F_1(w_5, w_6) \cdot F_4(w_1, w_7) \cdot F_5(w_1, w_2)F_6(w_1, w_3)F_5(w_2, w_3) \\
& \cdot F_7(w_1, w_8)F_6(w_2, w_8)F_5(w_3, w_8) \cdot F_3(w_4, w_7)F_2(w_5, w_7) \\
& (F_4(w_4, w_8)F_3(w_5, w_8)) \cdot F_1(w_6, w_7)F_2(w_6, w_8)F_1(w_7, w_8)
\end{aligned}$$

In moving $F_4(w_3, w_7)$ to the left it is untied from the singularity $F_5(w_2, w_7)$. So we must form new triples which are regular at $z_1 = z_2 = \dots = z_n \neq 0$ by the method described in Proposition 6.11. Therefore, by considering the product at $z_1 = z_2 = \dots = z_n \neq 0$, we have that F_{Λ° is divisible on the left by $T_6 + q^{-1}$, again preceded only by invertible terms, as desired. \blacksquare

Lemma 6.13 *Let Λ and $\tilde{\Lambda}$ be tableaux of the same shape such that $k = \Lambda(a, b) = \Lambda(a + 1, b) - 1$ and $\tilde{k} = \tilde{\Lambda}(a, b) = \tilde{\Lambda}(a + 1, b) - 1$. Then $F_\Lambda \in H_n$ is divisible on the left by $T_k - q$ if and only if $F_{\tilde{\Lambda}} \in H_n$ is divisible on the left by $T_{\tilde{k}} - q$.*

Proof. Let σ be the permutation such that $\tilde{\Lambda} = \sigma \cdot \Lambda$. There is a decomposition $\sigma = \sigma_{i_N} \dots \sigma_{i_1}$ such that for each $M = 1, \dots, N - 1$ the tableau $\Lambda_M = \sigma_{i_M} \dots \sigma_{i_1} \cdot \Lambda$ is standard. Note that this decomposition is not necessarily reduced.

Denote F_Λ by $F_k(q^{2c_k(\Lambda)}, q^{2c_{k+1}(\Lambda)}) \cdot F$. Then, by using the relations (45) and (46) and Proposition 6.5, we have the following chain of equalities:

$$\begin{aligned}
F_{\tilde{k}}(q^{2c_{\tilde{k}}(\tilde{\Lambda})}, q^{2c_{\tilde{k}+1}(\tilde{\Lambda})}) \cdot \prod_{M=1, \dots, N}^{\leftarrow} F_{n-i_M}(q^{2c_{i_M+1}(\Lambda_M)}, q^{2c_{i_M}(\Lambda_M)}) \cdot F = \\
\prod_{M=1, \dots, N}^{\leftarrow} F_{i_M}(q^{2c_{i_M}(\Lambda_M)}, q^{2c_{i_M+1}(\Lambda_M)}) \cdot F_k(q^{2c_k(\Lambda)}, q^{2c_{k+1}(\Lambda)}) \cdot F =
\end{aligned}$$

$$\begin{aligned} & \overleftarrow{\prod}_{M=1, \dots, N} F_{i_M}(q^{2c_{i_M}(\Lambda_M)}, q^{2c_{i_M+1}(\Lambda_M)}) \cdot F_\Lambda = \\ & F_{\tilde{\Lambda}} \cdot \overleftarrow{\prod}_{M=1, \dots, N} F_{n-i_M}(q^{2c_{i_M+1}(\Lambda_M)}, q^{2c_{i_M}(\Lambda_M)}) \end{aligned}$$

Hence divisibility by $T_k - q$ for F_Λ implies its counterpart for the tableau $\tilde{\Lambda}$ and the index \tilde{k} , and vice versa. Here we also use the equalities

$$F_k(q^{2c_k(\Lambda)}, q^{2c_{k+1}(\Lambda)}) = T_k - q,$$

$$F_{\tilde{k}}(q^{2c_{\tilde{k}}(\tilde{\Lambda})}, q^{2c_{\tilde{k}+1}(\tilde{\Lambda})}) = T_{\tilde{k}} - q.$$

■

Corollary 6.14 *If $k = \Lambda(a, b)$ and $k + 1 = \Lambda(a + 1, b)$ then the element $F_\Lambda \in H_n$ is divisible on the left by $T_k - q$. If $k = \Lambda(a, b)$ and $k + 1 = \Lambda(a, b + 1)$ then the element $F_\Lambda \in H_n$ is divisible on the left by $T_k + q^{-1}$.*

Proof. Due to Lemma 6.13 it suffices to prove the first part of Corollary 6.14 for only one standard tableau Λ of shape λ . Therefore, using Proposition 6.10 and taking $\tilde{\Lambda}$ to be the hook tableau Λ° of shape λ we have shown the first part of Corollary 6.14 in the case $c_v(\Lambda) < 0$.

Next let $\Lambda^\circ(a, b) = u$, $\Lambda^\circ(a + 1, b) = v$ and s be the last entry in the row containing u . Then for $c_v(\Lambda^\circ) \geq 0$ Proposition 6.10 showed that $F_{\Lambda^\circ} \in H_n$ is divisible on the left by

$$\overleftarrow{\prod}_{i=u, \dots, s} \left(\overrightarrow{\prod}_{j=s+1, \dots, v} F_{i+j-s-1}(q^{2c_i(\Lambda^\circ)}, q^{2c_j(\Lambda^\circ)}) \right) \quad (56)$$

Put $k = u + v - s - 1$, this is the value of the index $i + j - s - 1$ in (56) when $i = u$ and $j = v$. Let Λ be the tableau such that Λ° is obtained from the tableau $\sigma_k \cdot \Lambda$ by the permutation

$$\overleftarrow{\prod}_{i=u, \dots, s} \left(\overrightarrow{\prod}_{j=s+1, \dots, v} \sigma_{i+j-s-1} \right).$$

The tableau Λ is standard. Moreover, then $\Lambda(a, b) = k$ and $\Lambda(a + 1, b) = k + 1$. Note that the rightmost factor in the product (56), corresponding to $i = u$ and $j = v$, is

$$F_{u+v-s-1}(q^{2c_u(\Lambda^\circ)}, q^{2c_v(\Lambda^\circ)}) = T_k - q.$$

Denote by F the product of all factors in (56) but the rightmost one. Further, denote by G the product obtained by replacing each factor in F

$$F_{i+j-s-1}(q^{2c_i(\Lambda^\circ)}, q^{2c_j(\Lambda^\circ)})$$

respectively by

$$F_{n-i-j+s+1}(q^{2c_j(\Lambda^\circ)}, q^{2c_i(\Lambda^\circ)}).$$

The element $F \in H_n$ is invertible, and we have

$$F \cdot F_\Lambda = F_{\Lambda^\circ} \cdot G = F \cdot (T_k - q) \cdot (C'_1 R'_1 C'_2 R_2 \prod C_i R_i) \cdot G,$$

where the final equality is as described in Proposition 6.10. Therefore the divisibility of the element F_{Λ° on the left by the product (56) will imply the divisibility of the element F_Λ on the left by $T_k - q$.

This shows the required divisibility for the tableau $\Lambda = \sigma\sigma_k \cdot \Lambda^\circ$. Using Lemma 6.13 again concludes the proof of the first part of Corollary 6.14.

The second part of Corollary 6.14 may be shown similarly. ■

6.3 Generating irreducible representations of H_n

In his thesis of 1974 Hoefsmit wrote down the irreducible seminormal representations for the Hecke algebras of type A , B and D , [H]. In the sequel we will construct the seminormal basis of type A . For every standard tableau Λ of shape λ we have defined an element F_Λ of the algebra H_n . Let us now assign to Λ another element of H_n , which will be denoted by G_Λ .

Let $\rho \in S_n$ be the permutation such that $\Lambda = \rho \cdot \Lambda^\circ$. For any $j = 1, \dots, n$ take the subsequence of the sequence $\rho(1), \dots, \rho(n)$ consisting of all $i < j$ such that $\rho^{-1}(i) > \rho^{-1}(j)$. Denote by \mathcal{A}_j the result of reversing this subsequence. Let

$|\mathcal{A}_j|$ be the length of sequence \mathcal{A}_j . We have a reduced decomposition in the symmetric group S_n ,

$$\rho = \prod_{j=1, \dots, n}^{\rightarrow} \left(\prod_{k=1, \dots, |\mathcal{A}_j|}^{\rightarrow} \sigma_{j-k} \right). \quad (57)$$

Let $\sigma_{i_L} \dots \sigma_{i_1}$ be the product of adjacent transpositions at the right hand side of (57). For each tail $\sigma_{i_K} \dots \sigma_{i_1}$ of this product, the image $\sigma_{i_K} \dots \sigma_{i_1} \cdot \Lambda^\circ$ is a standard tableau. This can easily be proved by induction on the length $K = L, \dots, 1$ of the tail, see also the proof of Proposition 6.15 below. Note that for any $i \in \mathcal{A}_j$ and $k \in \{1, \dots, n-1\}$ the elements of the algebra H_n ,

$$F_k(q^{2c_i(\Lambda)}, q^{2c_j(\Lambda)}) \quad \text{and} \quad F_k(q^{2c_j(\Lambda)}, q^{2c_i(\Lambda)})$$

are well defined and invertible. Indeed, if $i = \Lambda(a, b)$ and $j = \Lambda(c, d)$ for some a, b and c, d then $a < c$ and $b > d$. So $c_i(\Lambda) - c_j(\Lambda) = b - a - d + c \geq 2$ here.

Proposition 6.15 *We have the equality in the algebra H_n*

$$F_\Lambda \cdot \prod_{j=1, \dots, n}^{\rightarrow} \left(\prod_{k=1, \dots, |\mathcal{A}_j|}^{\rightarrow} F_{n-j+k}(q^{2c_j(\Lambda)}, q^{2c_i(\Lambda)}) \right) = \prod_{j=1, \dots, n}^{\rightarrow} \left(\prod_{k=1, \dots, |\mathcal{A}_j|}^{\rightarrow} F_{j-k}(q^{2c_i(\Lambda)}, q^{2c_j(\Lambda)}) \right) \cdot F_{\Lambda^\circ} \quad \text{where} \quad i = \mathcal{A}_j(k).$$

Proof. We will proceed by induction on the length $N = |\mathcal{A}_1| + \dots + |\mathcal{A}_n|$ of the element $\rho \in S_n$. Let m be the minimal of the indices j such that the sequence \mathcal{A}_j is not empty. Then we have $\mathcal{A}_m(1) = m-1$. Indeed, if $\mathcal{A}_m(1) < m-1$ then $\rho^{-1}(\mathcal{A}_m(1)) > \rho^{-1}(m-1)$. Then $\mathcal{A}_m(1) \in \mathcal{A}_{m-1}$, which would contradict to the minimality of m . The tableau $\sigma_{m-1} \cdot \Lambda$ is standard, denote it by Λ' . In our proof of Proposition 6.5 we used the equality (52). Setting $k = m-1$ in that equality and then using Proposition 6.5 itself, we obtain the equality in H_n

$$F_\Lambda F_{n-m+1}(q^{2c_m(\Lambda)}, q^{2c_{m-1}(\Lambda)}) = F_{m-1}(q^{2c_{m-1}(\Lambda)}, q^{2c_m(\Lambda)}) F_{\Lambda'}. \quad (58)$$

For each index $j = 1, \dots, n$ denote by \mathcal{A}'_j the counterpart of the sequence \mathcal{A}_j for the standard tableau Λ' instead of Λ . Each of the sequences $\mathcal{A}'_1, \dots, \mathcal{A}'_{m-2}$

and \mathcal{A}'_m is empty. The sequence \mathcal{A}'_{m-1} is obtained from the sequence \mathcal{A}_m by removing its first term $\mathcal{A}_m(1) = m - 1$. By replacing the terms $m - 1$ and m , whenever any of them occurs, respectively by m and $m - 1$ in all the sequences $\mathcal{A}_{m+1}, \dots, \mathcal{A}_n$ we obtain the sequences $\mathcal{A}'_{m+1}, \dots, \mathcal{A}'_n$.

Assume that the Proposition 6.15 is true for Λ' instead of Λ . Write the product at the left hand side of the equality to be proved in Proposition 6.15 as

$$F_\Lambda F_{n-m+1}(q^{2c_m(\Lambda)}, q^{2c_{m-1}(\Lambda)}) \cdot \prod_{k=2, \dots, |\mathcal{A}_m|}^{\rightarrow} F_{n-m+k}(q^{2c_m(\Lambda)}, q^{2c_i(\Lambda)}) \times$$

$$\prod_{j=m+1, \dots, n}^{\rightarrow} \left(\prod_{k=1, \dots, |\mathcal{A}_j|}^{\rightarrow} F_{n-j+k}(q^{2c_j(\Lambda)}, q^{2c_i(\Lambda)}) \right)$$

where in the first line $i = \mathcal{A}_m(k)$, while in the second line $i = \mathcal{A}_j(k)$. Using the equality (58) and the description of the sequences $\mathcal{A}'_1, \dots, \mathcal{A}'_n$ as given above, the latter product can be rewritten as

$$F_{m-1}(q^{2c_{m-1}(\Lambda)}, q^{2c_m(\Lambda)}) F_{\Lambda'} \times$$

$$\prod_{j=1, \dots, n}^{\rightarrow} \left(\prod_{k=1, \dots, |\mathcal{A}'_j|}^{\rightarrow} F_{n-j+k}(q^{2c_j(\Lambda')}, q^{2c_i(\Lambda')}) \right) \quad \text{where } i = \mathcal{A}'_j(k).$$

By the inductive assumption, this product equals

$$F_{m-1}(q^{2c_{m-1}(\Lambda)}, q^{2c_m(\Lambda)}) \cdot \prod_{j=1, \dots, n}^{\rightarrow} \left(\prod_{k=1, \dots, |\mathcal{A}'_j|}^{\rightarrow} F_{j-k}(q^{2c_i(\Lambda')}, q^{2c_j(\Lambda')}) \right)$$

times F_{Λ° , where we keep to the notation $i = \mathcal{A}'_j(k)$. Using the description of the sequences $\mathcal{A}'_1, \dots, \mathcal{A}'_n$ once again, the last product can be rewritten as at the right hand side of the equality to be proved in Proposition 6.15 \blacksquare

For any $j = 1, \dots, n$ denote by \mathcal{B}_j the subsequence of the sequence $\rho(1), \dots, \rho(n)$ consisting of all $i < j$ such that $\rho^{-1}(i) < \rho^{-1}(j)$. Note that we have a reduced decomposition in the symmetric group S_n ,

$$\rho\sigma_0 = \prod_{j=1, \dots, n}^{\rightarrow} \left(\prod_{k=1, \dots, |\mathcal{B}_j|}^{\rightarrow} \sigma_{j-k} \right)$$

where $|\mathcal{B}_j|$ is the length of sequence \mathcal{B}_j . Consider the rational function taking values in H_n , of the variables z_1, \dots, z_n

$$\prod_{j=1, \dots, n}^{\rightarrow} \left(\prod_{k=1, \dots, |\mathcal{B}_j|}^{\rightarrow} F_{j-k}(q^{2c_i(\Lambda)} z_i, q^{2c_j(\Lambda)} z_j) \right) \quad \text{where } i = \mathcal{B}_j(k).$$

Denote this rational function by $G_\Lambda(z_1, \dots, z_n)$. Using induction on the length of the element $\rho \in S_n$ as in the proof of Proposition 6.15, one can prove that

$$F_\Lambda(z_1, \dots, z_n) = G_\Lambda(z_1, \dots, z_n) \times \prod_{j=1, \dots, n}^{\leftarrow} \left(\prod_{k=1, \dots, |\mathcal{A}_j|}^{\leftarrow} F_{n-j+k}(q^{2c_i(\Lambda)} z_i, q^{2c_j(\Lambda)} z_j) \right) \quad \text{where } i = \mathcal{A}_j(k).$$

Hence restriction of $G_\Lambda(z_1, \dots, z_n)$ to the subspace $\mathcal{H}_\Lambda \subset \mathbb{C}(q)^n$ is regular on the line $z_1 = \dots = z_n \neq 0$ due to Proposition 6.5. The value of that restriction is our element $G_\Lambda \in H_n$ by definition. Moreover, then F_Λ equals

$$G_\Lambda \cdot \prod_{j=1, \dots, n}^{\leftarrow} \left(\prod_{k=1, \dots, |\mathcal{A}_j|}^{\leftarrow} F_{n-j+k}(q^{2c_i(\Lambda)}, q^{2c_j(\Lambda)}) \right) \quad \text{where } i = \mathcal{A}_j(k).$$

Using the relation (51), this factorization of F_Λ implies that the left hand side of the equality in Proposition 6.15 also equals G_Λ times

$$\prod_{j=1, \dots, n} \left(\prod_{k=1, \dots, |\mathcal{A}_j|} \left(1 - \frac{(q - q^{-1})^2 q^{2c_i(\Lambda) + 2c_j(\Lambda)}}{(q^{2c_i(\Lambda)} - q^{2c_j(\Lambda)})^2} \right) \right) \quad \text{where } i = \mathcal{A}_j(k).$$

By rewriting the factors of this product, Proposition 6.15 yields

Corollary 6.16. *We have the equality in the algebra H_n*

$$\prod_{j=1, \dots, n} \left(\prod_{k=1, \dots, |\mathcal{A}_j|} \left(1 - \frac{(q - q^{-1})^2}{(q^{c_i(\Lambda) - c_j(\Lambda)} - q^{c_j(\Lambda) - c_i(\Lambda)})^2} \right) \right) \cdot G_\Lambda = \prod_{j=1, \dots, n}^{\rightarrow} \left(\prod_{k=1, \dots, |\mathcal{A}_j|}^{\rightarrow} F_{j-k}(q^{2c_i(\Lambda)}, q^{2c_j(\Lambda)}) \right) \cdot F_{\Lambda^\circ} \quad \text{where } i = \mathcal{A}_j(k).$$

Yet arguing like in the proof of Proposition 6.7, the definition of G_Λ implies

Proposition 6.17. *The element G_Λ equals $T_{\rho\sigma_0}$ plus a sum of the elements T_σ with certain non-zero coefficients from $\mathbb{C}(q)$, where the length of each $\sigma \in S_n$ is less than that of $\rho\sigma_0$.*

Note that $G_{\Lambda^\circ} = F_{\Lambda^\circ}$ by definition. Denote by V_λ the left ideal in the algebra H_n generated by the element F_{Λ° . Due to Corollary 6.16 we have $G_\Lambda \in V_\lambda$ for any standard tableau Λ of shape λ . Proposition 6.17 shows that the elements $G_\Lambda \in H_n$ for all pairwise distinct standard tableaux Λ of shape λ are linearly independent. The next proposition implies, in particular, that these elements also span the vector space V_λ .

For any $k = 1, \dots, n-1$ denote $d_k(\Lambda) = c_k(\Lambda) - c_{k+1}(\Lambda)$. If the tableau $\sigma_k \Lambda$ is not standard, then the numbers k and $k+1$ stand next to each other in the same row or in the same column of Λ , that is $k+1 = \Lambda(a, b+1)$ or $k+1 = \Lambda(a+1, b)$ for $k = \Lambda(a, b)$. Then we have $d_k(\Lambda) = -1$ or $d_k(\Lambda) = 1$ respectively. But if the tableau $\sigma_k \Lambda$ is standard, then we have $|d_k(\Lambda)| \geq 2$.

Proposition 6.18. *For any standard tableau Λ and any $k = 1, \dots, n-1$ we have:*

$$\begin{aligned}
 a) \quad T_k G_\Lambda &= \begin{cases} qG_\Lambda & \text{if } d_k(\Lambda) = -1, \\ -q^{-1}G_\Lambda & \text{if } d_k(\Lambda) = 1; \end{cases} \\
 b) \quad T_k G_\Lambda &= \frac{q - q^{-1}}{1 - q^{2d_k(\Lambda)}} G_\Lambda + G_{\sigma_k \Lambda} \times \\
 &\quad \begin{cases} 1 - \frac{(q - q^{-1})^2}{(q^{d_k(\Lambda)} - q^{-d_k(\Lambda)})^2} & \text{if } d_k(\Lambda) \leq -2, \\ 1 & \text{if } d_k(\Lambda) \geq 2. \end{cases}
 \end{aligned}$$

Proof. The element $G_\Lambda \in H_n$ is obtained by multiplying F_Λ on the right by a certain element of H_n . Hence Part (a) of Proposition 6.18 immediately follows from Corollary 3.13. Now suppose that the tableau $\sigma_k \Lambda$ is standard. Moreover, suppose that $d_k(\Lambda) \geq 2$. Using Corollary 6.16 along with the relations (45) and (46), one can get the equality

$$\left(1 - \frac{(q - q^{-1})^2}{(q^{d_k(\Lambda)} - q^{-d_k(\Lambda)})^2} \right) G_\Lambda = F_k(q^{2c_k(\Lambda)}, q^{2c_{k+1}(\Lambda)}) G_{\sigma_k \Lambda}. \quad (59)$$

Using the relation (51), we obtain from (59) the equality

$$F_k(q^{2c_{k+1}(\Lambda)}, q^{2c_k(\Lambda)}) G_\Lambda = G_{\sigma_k \Lambda}.$$

The last equality implies Part (b) of Theorem 3.3 in the case when $d_k(\Lambda) \geq 2$, see the definition (43). Exchanging the tableaux Λ and $\sigma_k\Lambda$ in (59), so that the resulting equality applies in the case when $d_k(\Lambda) \leq -2$, we prove Part (b) of Proposition 6.18 in this remaining case. \blacksquare

Thus the elements $G_\Lambda \in H_n$ for all pairwise distinct standard tableaux Λ of shape λ form a basis in the vector space V_λ . This basis is distinguished due to

Proposition 6.19. *We have $X_i G_\Lambda = q^{2c_i(\Lambda)} G_\Lambda$ for each $i = 1, \dots, n$.*

Proof. We will proceed by induction on $i = 1, \dots, n$. By definition, $X_1 = 1$. On the other hand, $c_1(\Lambda) = 0$ for any standard tableau Λ . Thus Proposition 6.19 is true for $i = 1$. Now suppose that Proposition 6.19 is true for $i = k$ where $k < n$. To show that it is also true for $i = k + 1$, we will use Proposition 6.18. Note that $X_{k+1} = T_k X_k T_k$. If $d_k(\Lambda) = \pm 1$, then $T_k X_k T_k G_\Lambda$ equals

$$\mp q^{\mp 1} T_k X_k G_\Lambda = \mp q^{2c_k(\Lambda) \mp 1} T_k G_\Lambda = q^{2c_k(\Lambda) \mp 2} G_\Lambda = q^{2c_{k+1}(\Lambda)} G_\Lambda$$

respectively. If $d_k(\Lambda) \geq 2$, then the product $T_k X_k T_k G_\Lambda$ equals

$$\begin{aligned} & T_k X_k \left(\frac{q - q^{-1}}{1 - q^{2d_k(\Lambda)}} G_\Lambda + G_{\sigma_k \Lambda} \right) = \\ & q^{2c_{k+1}(\Lambda)} T_k \left(\frac{q - q^{-1}}{q^{-2d_k(\Lambda)} - 1} G_\Lambda + G_{\sigma_k \Lambda} \right) = \\ & q^{2c_{k+1}(\Lambda)} \left(\frac{q - q^{-1}}{q^{-2d_k(\Lambda)} - 1} \left(\frac{q - q^{-1}}{1 - q^{2d_k(\Lambda)}} G_\Lambda + G_{\sigma_k \Lambda} \right) + \right. \\ & \left. \frac{q - q^{-1}}{1 - q^{-2d_k(\Lambda)}} G_{\sigma_k \Lambda} + \left(1 - \frac{(q - q^{-1})^2}{(q^{d_k(\Lambda)} - q^{-d_k(\Lambda)})^2} \right) G_\Lambda \right) = q^{2c_{k+1}(\Lambda)} G_\Lambda. \end{aligned}$$

In the case when $d_k(\Lambda) \leq -2$, the proof of the equality $X_{k+1} G_\Lambda = q^{2c_{k+1}(\Lambda)} G_\Lambda$ is similar. \blacksquare

Let us now consider the left ideal $V_\lambda \subset H_n$ as H_n -module. Here the algebra H_n acts via left multiplication.

Corollary 6.20. *The H_n -module V_λ is irreducible.*

Proof. Let A be the commutative subalgebra of H_n generated by the Murphy elements X_1, \dots, X_n . For any H_n module V and any n -tuple $\mathbf{y} = (y_1, \dots, y_n)$ we define a subspace

$$V(\mathbf{y}) = \{v \in V : X_i v = y_i v \text{ for all } 1 \leq i \leq n\}.$$

Let $V = V_\lambda$, then the vectors $G_\Lambda \in V_\lambda$, where Λ is ranging over the set of all standard tableaux of the given shape λ , form an eigenbasis for the action on V_λ of the Murphy elements in H_n . So each G_Λ belongs to some $V(\mathbf{y})$. Moreover, we have the direct sum

$$V_\lambda = \bigoplus_{\mathbf{y}} V(\mathbf{y}).$$

If $\Lambda \neq M$ then $G_\Lambda \in V(\mathbf{y})$ and $G_M \in V(\mathbf{z})$ with $\mathbf{y} \neq \mathbf{z}$ - otherwise $c_i(\Lambda) = c_i(M)$ for all i . So $\dim V(\mathbf{y}) \leq 1$. This means, as an A -module, V_λ is a direct sum of 1-dimensional non-isomorphic A -submodules, namely the non-zero $V(\mathbf{y})$.

Let U be a H_n -submodule of V_λ . Then U is also a submodule for A and so contains a non-zero $V(\mathbf{y}) = \mathbb{C}G_\Lambda$, for some standard tableau Λ . However, by Corollary 6.16 any basis vector $G_\Lambda \in V_\lambda$ can be obtained by acting on the element $G_{\Lambda^\circ} \in V_\lambda$ by a certain invertible element of H_n . So $G_{\Lambda^\circ} \in U$, but since G_{Λ° generates all of V_λ we have $U = V_\lambda$, hence V_λ is simple. ■

Corollary 6.21. *The H_n -modules V_λ for different partitions λ of n are pairwise non-equivalent.*

Proof. Take any symmetric polynomial f in n variables over the field $\mathbb{C}(q)$. For all standard tableaux Λ of the same shape λ , the values of this polynomial

$$f(q^{2c_1(\Lambda)}, \dots, q^{2c_n(\Lambda)}) \in \mathbb{C}(q) \tag{60}$$

are the same. Hence by Proposition 6.19, the element $f(X_1, \dots, X_n) \in H_n$ acts on V_λ via multiplication by the scalar (60). On the other hand, the partition λ can be uniquely restored from the values (60) where the polynomial f varies. Thus the H_n -modules V_λ with different partitions λ cannot be equivalent. ■

For any $k = 1, \dots, n - 1$ consider the restriction of the H_n -module V_λ to the subalgebra $H_k \subset H_n$.

Corollary 6.22 *The vector $G_\Lambda \in V_\lambda$ belongs to the H_k -invariant subspace in V_λ , equivalent to the H_k -module V_κ where the partition κ is the shape of the tableau obtained by removing from Λ the entries $k + 1, \dots, n$.*

Proof. It suffices to consider the case $k = n - 1$ only. For each index a such that $\lambda_a > \lambda_{a+1}$, denote by V_a the vector subspace in V_λ spanned by those vectors G_Λ where $\Lambda(a, \lambda_a) = n$. By Proposition 6.18, the subspace V_a is preserved by the action of the subalgebra $H_{n-1} \subset H_n$ on V_λ . Moreover, Proposition 6.18 shows that the H_{n-1} -module V_a is equivalent to V_κ where the partition κ of $n - 1$ is obtained by decreasing the a^{th} part of λ by 1. ■

The properties of the vector G_Λ given by Corollary 6.22 for $k = 1, \dots, n - 1$, determine this vector in V_λ uniquely up to a non-zero factor from $\mathbb{C}(q)$. Setting $q = 1$, the algebra H_n specializes to the symmetric group ring $\mathbb{C}S_n$. The element $T_\sigma \in H_n$ then specializes to the permutation $\sigma \in S_n$ itself. The proof of Proposition 6.5 demonstrates that the coefficients in the expansion of the element $F_\Lambda \in H_n$ relative to the basis of the elements T_σ , are regular at $q = 1$ as rational functions of the parameter q . Thus the specialization of the element $F_\Lambda \in H_n$ at $q = 1$ is well defined. The same is true for the element $G_\Lambda \in H_n$, see Corollary 6.16. The specializations at $q = 1$ of the basis vectors $G_\Lambda \in V_\lambda$ form the *Young seminormal basis* in the corresponding irreducible representation of the group S_n . The action of the generators $\sigma_1, \dots, \sigma_{n-1}$ of S_n on the vectors of the latter basis was first given by [Yo2, Theorem IV]. For the interpretation of the elements F_Λ and G_Λ using representation theory of the affine Hecke algebra \widehat{H}_n , see [C2, Section 3].

A Appendix A

This appendix gives the GAP code used to calculate the results of 4.4. My thanks to Alexander Konovalov and Alexander Hulpke and all those of the GAP support mailing list for their help, and patience!

```
###IOTest###
```

```
#-----Mixed Hooks Problem-----
```

```
#####
```

```
#-----CancellationFunction-----
```

```
#       Added by AK 04/01/05
```

```
CancellationOfRationalFunction:=function(r)
local fam, num, den, numpol, denpol, div, gcdnum, gcdden,
      coeffs, i, anum, aden;
if IsZero(r) then
  return r;
fi;
#
# Step 1. Divide numerator and denominator by their GCD
#
fam:=RationalFunctionsFamily(FamilyObj(1));;
num:=ExtRepNumeratorRatFun(r);
den:=ExtRepDenominatorRatFun(r);
numpol:=PolynomialByExtRep(fam,num);
denpol:=PolynomialByExtRep(fam,den);
div:=Gcd(numpol,denpol);
r:=(numpol/div)/(denpol/div);
#
# Step 2. Divide numerator and denominator by GCD of their
# coefficients and then multiply the result by their fraction
#
num:=ExtRepNumeratorRatFun(r);
den:=ExtRepDenominatorRatFun(r);
```

```

numpol:=PolynomialByExtRep(fam,num);
denpol:=PolynomialByExtRep(fam,den);
# making coefficients integer
coeffs:=CoefficientsOfUnivariatePolynomial(numpol);
anum:=Lcm(List( coeffs, i -> DenominatorRat(i)));
if anum<>1 then
  numpol:=numpol*anum;
fi;
coeffs:=CoefficientsOfUnivariatePolynomial(denpol);
aden:=Lcm(List( coeffs, i -> DenominatorRat(i)));
if aden<>1 then
  denpol:=denpol*aden;
fi;
gcdnum:=Gcd(CoefficientsOfUnivariatePolynomial(numpol));
gcdden:=Gcd(CoefficientsOfUnivariatePolynomial(denpol));
r:=(numpol/gcdnum)/(denpol/gcdden);
return (aden/anum)*(gcdnum/gcdden)*r;
end;

#####

#-----Trace Function-----

TraceOfProduct:=function(a,b)
local subtr, la, lb, i, j, inv, sum, s;
if IsZero(a) then
  return ZeroCoefficient(a);
elif IsZero(b) then
  return ZeroCoefficient(b);
else
  #
  # Step 1. For each element x from the supp(a) we find its inverse
  # in the supp(b). If such exists, we multiply their coefficients
  # and store them in the list 'subtr'.
  #
  subtr :=[ ZeroCoefficient(a) ];
  la:=CoefficientsAndMagmaElements(a);
  lb:=CoefficientsAndMagmaElements(b);
  Print("Computing ", Length(la)/2, " coefficients \n");

```

```

for i in [1,3..Length(la)-1] do
  Print( (i+1)/2, "\r");
  inv:=la[i]^-1;
  for j in [1,3..Length(lb)-1] do
    if lb[j]=inv then
      Add( subtr, la[i+1]*lb[j+1] );
      break;
    fi;
  od;
  # now we do cancellation on each step
  subtr[Length(subtr)]:=CancellationOfRationalFunction(subtr[Length(subtr)]);
od;
#
# Step 2. Computing the sum of elements from the list 'subtr',
# performing cancellation on each step.
#
sum:=ZeroCoefficient(a);
Print("Computing the sum of ", Length(subtr), " coefficients \n");
for s in [ 1 .. Length(subtr) ] do
  Print(s, "\r");
  sum:=sum+subtr[s];
  sum:=CancellationOfRationalFunction(sum);
od;
return sum;
fi;
end;

```

```
#####
```

```
#-----Central Idempotent Function-----
```

```

CentralIdempotentSymmetricGroup:= function( QG, pi )
local G, OrderG, Emb, n, t, charprm, classprm, pos, chi, idcoeffs,
      ccl, dom, cycletypes, sortedccl, elms, fusions, eC, j, val, k;

```

```
# Initialization
```

```

if not ( IsFreeMagmaRing( QG ) and
        IsGroup( UnderlyingMagma( QG ) ) and
        IsRationals( LeftActingDomain( QG ) ) ) then

```



```

    Error( "The input must be a rational group algebra" );
fi;
G := UnderlyingMagma( QG );
OrderG := Size( G );
Emb := Embedding( G, QG );
if not IsNaturalSymmetricGroup( G ) then
    Error( "<G> must be a symmetric group in its natural representation" );
fi;
n := NrMovedPoints( G );

# Compute the coefficients of the idempotent w.r.t. the character
# table.
t := CharacterTable( "Symmetric", n );
charprm := CharacterParameters( t );
classprm := ClassParameters( t );
pos := Position( charprm, [ 1, pi ] );
if pos = fail then
    Error( "<pi> must be a partition of ", n );
fi;
chi := ValuesOfClassFunction( Irr( t )[ pos ] );
idcoeffs := ( chi[1] / OrderG ) * chi;

# Identify the classes of the character table and the group.
# (This is not needed if 'G' was constructed with 'SymmetricGroup'
# but in general the classes may be sorted in a different way.)
ccl := ConjugacyClasses( G );
dom := [ 1 .. n ];
cycletypes := List( ccl, c -> CycleLengths( Representative( c ), dom )
);
sortedccl := List( classprm, p -> ccl[ Position( cycletypes, p[2] ) ]
);

# Form the group ring element.
# Compute the PCIs of QG.
elms:= Elements( G );
fusions:= List( sortedccl,
    c -> List( Elements( c ),
        x -> PositionSorted( elms, x ) ) );
eC:= 0 * [ 1 .. OrderG ];

```

```

for j in [ 1 .. Length( chi ) ] do
  val:= idcoeffs[j];
  for k in fusions[j] do
    eC[k]:= val;
  od;
od;

return ElementOfMagmaRing( ElementsFamily( FamilyObj( QG ) ),
                          0, eC, elms );

end;

#####

#-----Function To Compute Eigenvalue-----

IOTest:=function(clambmu,Ilambmu,nu)

local r,z,u,fam,s8,g,QS,y,
#clambmu,Ilambmu,nu,
Flambdawithz,
elementsFlambdawithz,
coeffsFlambdawithz,
coffevalFlambdawithz,
Flambda,
Fmuwithz,
elementsFmuwithz,
coeffsFmuwithz,
coffevalFmuwithz,
Fmu,
ZnuInQS,
Znu,
vnu,
Rlambdamu,
TraceRlambdamuvnu,
rlambdamunu,
num,
den,
numfactors,
denfactors,

```

```

elementsRlambdamu,
coeffsRlambdamu,
i,c;

#####

#-----The Initial Setup-----

r:=PolynomialRing(Rationals,["z","u"]);
z:=IndeterminatesOfPolynomialRing(r)[1];
u:=IndeterminatesOfPolynomialRing(r)[2];
fam:=RationalFunctionsFamily(FamilyObj(1));
s8:=SymmetricGroup(8);
g:=GroupRing(r,s8);
QS:= GroupRing(Rationals,s8);
y:=One(g);

#clambmu:=[0,1,2,-1,0,1,2,-1];;
#lambmu:=[1,1,1,1,1,1,1,1];;
#nu:=[6,2];;

Print("Initial setup completed \n");

#####

#-----Calculating Flambda (two hooks only)-----

Print("Computing Flambda... \c");
Flambdawithz:=
(y - y*(3,4)/(z*((lambmu[3] - lambmu[4])^2) + clambmu[3] - clambmu[4]))*
(y - y*(2,4)/(z*((lambmu[2] - lambmu[4])^2) + clambmu[2] - clambmu[4]))*
(y - y*(2,3)/(z*((lambmu[2] - lambmu[3])^2) + clambmu[2] - clambmu[3]))*
(y - y*(1,4)/(z*((lambmu[1] - lambmu[4])^2) + clambmu[1] - clambmu[4]))*
(y - y*(1,3)/(z*((lambmu[1] - lambmu[3])^2) + clambmu[1] - clambmu[3]))*
(y - y*(1,2)/(z*((lambmu[1] - lambmu[2])^2) + clambmu[1] - clambmu[2]));;

elementsFlambdawithz:=Support(Flambdawithz);;
coeffsFlambdawithz:=CoefficientsBySupport(Flambdawithz);;
coeffevalFlambdawithz:=List(coeffsFlambdawithz,i->Value(i,[z],[0]));;

```

```

Flambda:=ElementOfMagmaRing(FamilyObj(Zero(g)), Zero(r),
One(r)*coffevalFlambdawithz, elementsFlambdawithz);

Unbind(Flambdawithz);;
Unbind(elementsFlambdawithz);;
Unbind(coeffsFlambdawithz);;
Unbind(coffevalFlambdawithz);;
Print("OK \n");

#####

#-----Calculating Fmu (two hooks only)-----

Print("Computing Fmu... \c");
Fmuwithz:=
(y - y*(7,8)/(z*((Ilambmu[7] - Ilambmu[8])^2) + clambmu[7] - clambmu[8]))*
(y - y*(6,8)/(z*((Ilambmu[6] - Ilambmu[8])^2) + clambmu[6] - clambmu[8]))*
(y - y*(6,7)/(z*((Ilambmu[6] - Ilambmu[7])^2) + clambmu[6] - clambmu[7]))*
(y - y*(5,8)/(z*((Ilambmu[5] - Ilambmu[8])^2) + clambmu[5] - clambmu[8]))*
(y - y*(5,7)/(z*((Ilambmu[5] - Ilambmu[7])^2) + clambmu[5] - clambmu[7]))*
(y - y*(5,6)/(z*((Ilambmu[5] - Ilambmu[6])^2) + clambmu[5] - clambmu[6]));;

elementsFmuwithz:=Support(Fmuwithz);;
coeffsFmuwithz:=CoefficientsBySupport(Fmuwithz);;
coffevalFmuwithz:=List(coeffsFmuwithz,i->Value(i,[z],[0]));;
Fmu:=ElementOfMagmaRing(FamilyObj(Zero(g)), Zero(r), One(r)*coffevalFmuwithz,
elementsFmuwithz);;

Unbind(Fmuwithz);;
Unbind(elementsFmuwithz);;
Unbind(coeffsFmuwithz);;
Unbind(coffevalFmuwithz);;
Print("OK \n");

#####

#-----Calculating Znu-----

Print("Computing Znu... \c");

```

```

ZnuInQS:= CentralIdempotentSymmetricGroup(QS,nu);;
Znu:=ElementOfMagmaRing(
    FamilyObj(Zero(g)),
    Zero(r),
    One(r)*CoefficientsBySupport(ZnuInQS),
    Support(ZnuInQS));;
Print("OK \n");

#####

#-----Calculating Test Eigenvector vnu-----

Print("Computing vnu = Znu*Flambda*Fmu... \c");
vnu:= Znu*Flambda;
Unbind(Flambda);;
Unbind(Znu);;
vnu:= vnu*Fmu;
Unbind(Fmu);;
Print("OK \n");

#####

#-----Calculating Operator Rlambdamu-----

Print("Computing Rlambdamu... \n");
Rlambdamu:=
(y - y*(4,5)/(u + clambmu[4] - clambmu[5]))*
(y - y*(4,6)/(u + clambmu[4] - clambmu[6]))*
(y - y*(4,7)/(u + clambmu[4] - clambmu[7]))*
(y - y*(4,8)/(u + clambmu[4] - clambmu[8]))*
(y - y*(3,5)/(u + clambmu[3] - clambmu[5]))*
(y - y*(3,6)/(u + clambmu[3] - clambmu[6]))*
(y - y*(3,7)/(u + clambmu[3] - clambmu[7]))*
(y - y*(3,8)/(u + clambmu[3] - clambmu[8]))*
(y - y*(2,5)/(u + clambmu[2] - clambmu[5]))*
(y - y*(2,6)/(u + clambmu[2] - clambmu[6]))*
(y - y*(2,7)/(u + clambmu[2] - clambmu[7]))*
(y - y*(2,8)/(u + clambmu[2] - clambmu[8]))*
(y - y*(1,5)/(u + clambmu[1] - clambmu[5]))*

```

```

(y - y*(1,6)/(u + clambmu[1] - clambmu[6]))*
(y - y*(1,7)/(u + clambmu[1] - clambmu[7]))*
(y - y*(1,8)/(u + clambmu[1] - clambmu[8]));

# AK 04/01/05 #####
#
elementsRlambdamu:=Support(Rlambdamu);;
coeffsRlambdamu:=CoefficientsBySupport(Rlambdamu);;
Unbind(Rlambdamu);;
Print("Performing cancellations on ", Length(coeffsRlambdamu), " coefficients \n");
for i in [ 1 .. Length(coeffsRlambdamu) ] do
Print(i, "\r");
c:= coeffsRlambdamu[i];;
c:=CancellationOfRationalFunction(c);;
od;
Rlambdamu:=ElementOfMagmaRing( FamilyObj(Zero(g)),
                                Zero(r),
                                One(r)*coeffsRlambdamu,
                                elementsRlambdamu);;
#####

Print("...OK \n");

#####

#-----Calculating Eigenvalue rlamdamunu-----

Print("Computing trace of Rlambdamu*vnu... \n");
TraceRlambdamuvnu:= TraceOfProduct(Rlambdamu, vnu);;
Unbind(Rlambdamu);;
Print("...OK \n");
Print("Computing rlamdamunu ... \c");
rlamdamunu:= TraceRlambdamuvnu/CoefficientsAndMagmaElements(vnu)[2];;
rlamdamunu:= CancellationOfRationalFunction( rlamdamunu );;
Print("OK \n");

#Print("rlamdamunu = ", rlamdamunu, "\n");

```

```
#####

#-----Factorising numerator and denominator-----

Print("Computing factors ... \n");
num:=ExtRepNumeratorRatFun(rlambdamunu);
den:=ExtRepDenominatorRatFun(rlambdamunu);
numfactors:= Factors(PolynomialByExtRep(fam,num));
denfactors:= Factors(PolynomialByExtRep(fam,den));
# return [numfactors, denfactors];
Print("numfactors = ", numfactors, "\n");
Print("denfactors = ", denfactors, "\n");
AppendTo("output.txt", "numfactors = ", numfactors, "\n");
AppendTo("output.txt", "denfactors = ", denfactors, "\n");
end;

#####

#-----End-----
```

We then input the necessary parameters, these are the contents of λ and μ , a vector indicating whether a box is in the first or second hook of λ and μ , and the partition ν . We consider six cases below.

```
###input###

Read("IOTest.txt");

AppendTo("output.txt", "##### Test 1: \n");

clambmu:=[0,1,2,-1,0,1,2,-1];;
l1ambmu:=[1,1,1,1,1,1,1,1];;
nu:=[5,3];;
IOTest(clambmu,l1ambmu,nu);

AppendTo("output.txt", "##### Test 2: \n");

clambmu:=[0,1,2,-1,0,1,-1,0];;
```

```

I1ambmu=[1,1,1,1,1,1,1,2];;
nu=[4,2,2];;
IOTest(c1ambmu,I1ambmu,nu);

AppendTo("output.txt", "##### Test 3: \n");

c1ambmu=[0,1,-1,0,0,1,-1,0];;
I1ambmu=[1,1,1,2,1,1,1,2];;
nu=[4,3,1];;
IOTest(c1ambmu,I1ambmu,nu);

AppendTo("output.txt", "##### Test 4: \n");

c1ambmu=[0,1,-1,0,0,1,-1,0];;
I1ambmu=[1,1,1,2,1,1,1,2];;
nu=[3,2,2,1];;
IOTest(c1ambmu,I1ambmu,nu);

AppendTo("output.txt", "##### Test 5: \n");

c1ambmu=[0,1,-1,0,0,1,-1,-2];;
I1ambmu=[1,1,1,2,1,1,1,1];;
nu=[3,3,1,1];;
IOTest(c1ambmu,I1ambmu,nu);

AppendTo("output.txt", "##### Test 6: \n");

c1ambmu=[0,1,-1,-2,0,1,-1,-2];;
I1ambmu=[1,1,1,1,1,1,1,1];;
nu=[2,2,2,1,1];;
IOTest(c1ambmu,I1ambmu,nu);

```

Which outputs;

###output###

#####

Test 1:

numfactors = [u-4, u-1]

denfactors = [u, u+1]

#####

Test 2:

numfactors = [-u+3, u+4]

denfactors = [-u+1, u+2]

#####

Test 3:

numfactors = [-u+3, u-2, u+2]

denfactors = [-u, u, u+1]

#####

Test 4:

numfactors = [-u+2, u+2, u+3]

denfactors = [-u+1, u, u]

#####

Test 5:

numfactors = [-u+2, u+3]

denfactors = [-u, u+1]

#####

Test 6:

numfactors = [u+1, u+4]

denfactors = [u-2, u-1]

B Appendix B

This appendix describes how we used the software packages GAP and Maple to calculate certain examples. These examples support the claim that the associated products $F_\Lambda(z_1, \dots, z_n)$ of invalid diagrams, as described in Section 5, have a pole at $z_1 = \dots = z_n$.

Consider the column tableau, Λ^c , of the Young diagram $\lambda = (3, 3)$ below:

1	3	5
2	4	6

We will proceed to calculate the coefficient of one of the elements in the expansion of F_{Λ^c} , and show this coefficient has a pole in the limit $z_1 = \dots = z_n$. By observation we identify the permutation (1 4 3 6) as one such possible permutation.

If we order the product $F_\Lambda(z_1, \dots, z_n)$ lexicographically, the following code, written for GAP by James Woodward, tells us how (1 4 3 6) is generated in the expansion of the product.

```
myList := [(1,2) , (1,3), (1,4), (1,5), (1,6), (2,3), (2,4), (2,5), (2,6),
           (3,4), (3,5), (3,6), (4,5), (4,6), (5,6)];

chosenElement := (1,4,3,6);
Count := 0;

for i in [1..Length(myList)-1] do

  g := ();
  myString := "";

  for j in [1..Length(myList)] do
    if Int(i/(2^(j-1))) mod 2 = 1 then
      g := myList[j] * g;
      myString := Concatenation(myString , String(myList[j]));
    end if;
  end for;
end for;
```

```

    fi;
od;

if g = chosenElement then
    Count := Count + 1;
    Print(Count, " ", g, "=", myString, "\n");
fi;

od;

Print("There are ", Count, " ways to do it! \n");

```

This gives us the following list:

- 1 (1,4,3,6)=(1,3)(1,4)(3,6)
- 2 (1,4,3,6)=(1,2)(1,3)(1,4)(2,3)(3,6)
- 3 (1,4,3,6)=(1,2)(1,4)(2,3)(2,4)(3,6)
- 4 (1,4,3,6)=(1,4)(3,4)(3,6)
- 5 (1,4,3,6)=(1,2)(1,4)(2,4)(3,4)(3,6)
- 6 (1,4,3,6)=(1,4)(3,6)(4,6)
- 7 (1,4,3,6)=(1,2)(1,4)(2,4)(3,6)(4,6)
- 8 (1,4,3,6)=(1,3)(1,4)(3,4)(3,6)(4,6)
- 9 (1,4,3,6)=(1,2)(1,3)(1,4)(2,3)(3,4)(3,6)(4,6)
- 10 (1,4,3,6)=(1,2)(1,4)(2,3)(2,4)(3,4)(3,6)(4,6)
- 11 (1,4,3,6)=(1,3)(1,4)(3,5)(3,6)(5,6)
- 12 (1,4,3,6)=(1,2)(1,3)(1,4)(2,3)(3,5)(3,6)(5,6)
- 13 (1,4,3,6)=(1,2)(1,4)(2,3)(2,4)(3,5)(3,6)(5,6)
- 14 (1,4,3,6)=(1,4)(3,4)(3,5)(3,6)(5,6)
- 15 (1,4,3,6)=(1,2)(1,4)(2,4)(3,4)(3,5)(3,6)(5,6)
- 16 (1,4,3,6)=(1,4)(3,5)(3,6)(4,5)(5,6)
- 17 (1,4,3,6)=(1,2)(1,4)(2,4)(3,5)(3,6)(4,5)(5,6)
- 18 (1,4,3,6)=(1,3)(1,4)(3,4)(3,5)(3,6)(4,5)(5,6)
- 19 (1,4,3,6)=(1,2)(1,3)(1,4)(2,3)(3,4)(3,5)(3,6)(4,5)(5,6)
- 20 (1,4,3,6)=(1,2)(1,4)(2,3)(2,4)(3,4)(3,5)(3,6)(4,5)(5,6)
- 21 (1,4,3,6)=(1,4)(3,6)(4,5)(4,6)(5,6)
- 22 (1,4,3,6)=(1,2)(1,4)(2,4)(3,6)(4,5)(4,6)(5,6)
- 23 (1,4,3,6)=(1,3)(1,4)(3,4)(3,6)(4,5)(4,6)(5,6)
- 24 (1,4,3,6)=(1,2)(1,3)(1,4)(2,3)(3,4)(3,6)(4,5)(4,6)(5,6)
- 25 (1,4,3,6)=(1,2)(1,4)(2,3)(2,4)(3,4)(3,6)(4,5)(4,6)(5,6)

There are 25 ways to do it!

We now use Maple to calculate the coefficient of $(1\ 4\ 3\ 6)$ in the expansion of $F_\Lambda(z_1, \dots, z_n)$. We first do this without imposing any conditions on the auxiliary parameters z_i .

```
># The coefficients of each term in the product

> c12:=(-1)/(z1-z2+1):
> c13:=(-1)/(z1-z3-1):
> c14:=(-1)/(z1-z4):
> c15:=(-1)/(z1-z5-2):
> c16:=(-1)/(z1-z6-1):
> c23:=(-1)/(z2-z3-2):
> c24:=(-1)/(z2-z4-1):
> c25:=(-1)/(z2-z5-3):
> c26:=(-1)/(z2-z6-2):
> c34:=(-1)/(z3-z4+1):
> c35:=(-1)/(z3-z5-1):
> c36:=(-1)/(z3-z6):
> c45:=(-1)/(z4-z5-2):
> c46:=(-1)/(z4-z6-1):
> c56:=(-1)/(z5-z6+1):

># The coefficients of each word that makes (1,4,3,6)

> w1:=c13*c14*c36:
> w2:=c12*c13*c14*c23*c36:
> w3:=c12*c14*c23*c24*c36:
> w4:=c14*c34*c36:
> w5:=c12*c14*c24*c34*c36:
> w6:=c14*c36*c46:
> w7:=c12*c14*c24*c36*c46:
> w8:=c13*c14*c34*c36*c46:
> w9:=c12*c13*c14*c23*c34*c36*c46:
> w10:=c12*c14*c23*c24*c34*c36*c46:
> w11:=c13*c14*c35*c36*c56:
> w12:=c12*c13*c14*c23*c35*c36*c56:
```

```

> w13:=c12*c14*c23*c24*c35*c36*c56:
> w14:=c14*c34*c35*c36*c56:
> w15:=c12*c14*c24*c34*c35*c36*c56:
> w16:=c14*c35*c36*c45*c56:
> w17:=c12*c14*c24*c35*c36*c45*c56:
> w18:=c13*c14*c34*c35*c36*c45*c56:
> w19:=c12*c13*c14*c23*c34*c35*c36*c45*c56:
> w20:=c12*c14*c23*c24*c34*c35*c36*c45*c56:
> w21:=c14*c36*c45*c46*c56:
> w22:=c12*c14*c24*c36*c45*c46*c56:
> w23:=c13*c14*c34*c36*c45*c46*c56:
> w24:=c12*c13*c14*c23*c34*c36*c45*c46*c56:
> w25:=c12*c14*c23*c24*c34*c36*c45*c46*c56:

># The coefficient of (1436) in the product

> simplify(w1+w2+w3+w4+w5+w6+w7+w8+w9+w10+w11+w12
           +w13+w14+w15+w16+w17+w18+w19+w20+w21+w22+w23+w24+w25);

```

The result is a rational polynomial in z_1, z_2, \dots, z_6 . The numerator of which is too large to reproduce here. The denominator however is calculated to be

$$(z_1 - z_2 + 1)(z_1 - z_4)(z_2 - z_4 - 1)(z_3 - z_5 - 1)(z_3 - z_6)(z_4 - z_5 - 2) \\ \times (z_5 - z_6 + 1)(z_1 - z_3 - 1)(z_3 - z_4 + 1)(z_2 - z_3 - 2)(z_4 - z_6 - 1).$$

The terms $(z_1 - z_4)$ and $(z_3 - z_6)$ in the denominator show we have a non-removable singularity at $z_1 = \dots = z_6$ here.

For comparison let us first consider the subspace defined in the row fusion procedure by the diagram

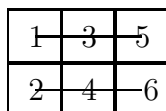

We use Maple to calculate the coefficient of (1 4 3 6) on this subspace.

```

> z3:=z1:

```

```

> z5:=z1:
> z4:=z2:
> z6:=z2:

> simplify(w1+w2+w3+w4+w5+w6+w7+w8+w9+w10+w11+w12
+w13+w14+w15+w16+w17+w18+w19+w20+w21+w22+w23+w24+w25);

```

$$\frac{1}{(z_1 - z_2 + 1)^3} \frac{\sqrt{2z_1^3 + 10z_1^2 - 6z_1z_2 + 12z_1 - 20z_1z_2}}{(-z_2 + z_1 + 2)^2}$$

$$+ \frac{6z_1^2z_2 - 1 - 12z_1z_2 - 2z_2^3 + 10z_2^2}{(-z_2 + z_1 + 2)^2}$$

i.e. the coefficient is

$$\frac{2z_1^3 + 10z_1^2 - 6z_1^2z_2 + 12z_1 - 20z_1z_2 + 6z_1z_2^2 - 12z_2 - 1 - 2z_2^3 + 10z_2^2}{(z_1 - z_2 + 1)^3(-z_2 + z_1 + 2)^2}$$

So on the subspace where $z_1 = z_3 = z_5$ and $z_2 = z_4 = z_6$ the coefficient tends to $-1/4$ in the limit $z_1 = z_2$.

Now consider an invalid diagram, for example a diagram that contains a square of type (15)

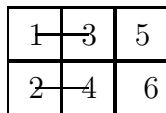

Then the coefficient of (1 4 3 6) is given by

```

> z3:=z1:
> z6:=z4:

> c:=simplify(w1+w2+w3+w4+w5+w6+w7+w8+w9+w10+w11+w12
+w13+w14+w15+w16+w17+w18+w19+w20+w21+w22+w23+w24+w25);

/ 2 2 2 2 2 3 3 3 3

```

$$\begin{aligned}
c := & \sqrt{3} z_1 z_5 + 4 z_1 z_6 + 5 z_2 z_5 - z_2 z_5 + 5 z_1 z_5 - z_1 \\
& + 2 z_1 z_2 z_5 z_6 + 5 z_1 z_2 z_5 z_6 - 8 z_1 z_2 z_5 z_6 + 10 z_1 z_2 z_5 z_6 \\
& - z_1 z_2 z_5 z_6 - z_1 z_5 z_6 - 6 z_1 z_2 z_6 + z_1 z_2 z_5 z_6 - z_1 z_6 z_2 \\
& - z_1 z_2 z_5 z_6 - 9 z_2 z_5 z_6 + z_2 z_6 + 20 z_1 z_5 z_6 + 7 z_2 z_6 + 6 z_2 z_5 z_6 \\
& + z_1 z_2 z_5 z_6 - 7 z_5 z_2 z_6 - z_5 z_6 + 3 z_1 z_5 z_6 + 3 z_5 z_2 z_6 - 3 z_1 z_5 z_6 \\
& - z_1 z_2 z_6 - 10 z_1 z_2 z_5 z_6 - z_1 z_5 z_6 - 2 z_1 z_2 z_5 z_6 - 6 z_1 z_5 z_6 \\
& - 8 z_1 z_2 z_6 + 4 z_1 z_2 z_5 z_6 - 4 z_1 z_2 z_6 + 8 z_1 z_2 z_6 - 11 z_1 z_2 z_5 z_6 \\
& - z_1 z_2 z_5 z_6 + z_1 z_6 z_5 + 2 z_1 z_2 z_5 z_6 - z_1 z_2 z_5 z_6 + 20 z_1 z_5 z_6 \\
& + 32 z_2 z_5 z_6 - 14 z_1 z_6 + 14 z_2 z_6 - 3 z_5 z_2 z_6 - 3 z_1 z_5 z_6 + z_2 z_5 z_6 \\
& - z_2 z_5 z_6 - 17 z_2 z_6 + 4 z_5 z_6 - 15 z_1 z_2 z_6 - 14 z_2 z_5 z_6 + 16 z_1 z_2 z_6 \\
& - 11 z_1 z_2 z_6 + z_1 z_5 z_6 - z_1 z_5 z_6 - z_1 z_2 z_5 z_6 + 18 z_1 z_2 z_5 z_6 \\
& - 7 z_1 z_5 z_6 - z_1 z_6 z_5 - 8 z_1 z_5 z_6 + 2 z_2 z_5 z_6 - 6 z_2 z_5 z_6 \\
& + 3 z_1 z_2 z_6 + z_2 z_5 z_6 + 2 z_1 z_2 z_5 z_6 + 10 z_1 z_2 z_5 z_6 + 4 z_5 z_6 \\
& + 3 z_1 z_2 z_6 + 3 z_1 z_2 z_6 + 2 z_1 z_2 z_6 + 2 z_1 z_2 z_6 + 2 z_1 z_2 z_6
\end{aligned}$$

$$\begin{aligned}
& - 6 z_5 z_2 - 7 z_1 z_2 z_5 + 6 z_1 z_5 z_6 - 3 z_5 z_6 - 2 z_6 + 10 z_5 z_2 z_6 \\
& + 5 z_1^3 z_2 z_5 + 2 z_1^2 z_5^3 + 7 z_1^3 z_2^2 - 27 z_1^2 z_2 z_5^3 - 24 z_5^2 z_2^2 \\
& - 3 z_1^3 z_2 z_6 + z_5^3 z_6^2 + 2 z_1^2 z_2 z_5^2 z_6 - 6 z_1 z_5 z_6^2 - 11 z_2^2 z_5 z_6^2 \\
& + 4 z_5^2 z_2 z_6 + 16 z_1 z_2 z_5 z_6^2 - z_1^3 z_2^2 z_5^2 - 24 z_5^2 z_2^2 + 6 z_1 z_2 z_5 z_6^2 + z_6^2 \\
& + 26 z_2^2 z_5^2 - 4 z_1^2 z_6^2 + 7 z_2^2 z_6^2 - 5 z_2^2 z_6^2 - 20 z_1 z_2 z_5^2 - 2 z_1^2 z_2 z_6^3 \\
& + z_1^3 z_2^2 z_6 + 4 z_1^3 z_2^2 - 6 z_1^3 z_5 + 2 z_1^3 z_6 - 2 z_1^3 z_5^2 + z_2^4 z_5^2 \\
& - z_2^4 z_6 + 2 z_2^4 z_5 + 2 z_1^2 z_2^3 z_6 - z_1^4 z_2^2 - z_1^3 z_2^2 + 2 z_1^3 z_6 - z_1^3 z_2^2 z_5^4 \\
& + 17 z_1^2 z_2^2 + 2 z_1^2 z_2^3 z_5 + z_1^4 z_2 z_6 - z_1^3 z_5 z_6 + 2 z_1^2 z_2^2 z_6^2 \\
& - z_1^2 z_2^2 z_5^2 - z_2^4 z_5 z_6 - z_1^3 z_2^2 z_5 + z_1^3 z_2 z_5^2 / \sqrt{(z_2 - z_5 - 2)(-z_5} \\
& + z_6 - 1)(z_1 - z_5 - 1)(-z_2 + z_1 + 2)(z_1 - z_2 + 1)(z_2 - z_6 - 1)(z_1 \\
& \backslash \\
& - z_6)/
\end{aligned}$$

Importantly, the denominator contains the term $(z_1 - z_6)$ and so the singularity is not removable.

Finally we consider one more invalid diagram, a diagram that contains the union $\textcircled{3}-\textcircled{5}$

1	3	5
2	4	6

Then the coefficient of (1 4 3 6) is given by

> z3:=z1:

> z6:=z4:

> c:=simplify(w1+w2+w3+w4+w5+w6+w7+w8+w9+w10+w11+w12

+w13+w14+w15+w16+w17+w18+w19+w20+w21+w22+w23+w24+w25);

$$\begin{aligned}
 c := & \frac{-6 z_1^3 z_2^3 z_4^3 + 6 z_1^3 z_2^3 z_5^2 + 2 z_1^3 z_2^2 z_5^3 - 2 z_1^3 z_4^2 z_5^3 + 4 z_1^3 z_4^2 z_5^2}{-2 z_1^3 z_4^3 + 3 z_4^3 z_5^2 - 8 z_4^2 z_5^2 z_2 + 16 z_4^2 z_5^2 z_2 + 12 z_4^2 z_5^2 z_2} \\
 & + 22 z_4^2 z_5^2 z_2 - 6 z_4^3 z_5^2 z_2 + 3 z_4^3 z_5^2 z_2 + 7 z_4^2 z_5^2 z_2 - 6 z_4^3 z_5^2 z_2 - 6 z_4^3 z_5^2 z_2 \\
 & + 3 z_4^3 z_5^2 - 8 z_5^2 z_2 - 8 z_1^2 + 12 z_2^2 z_1 + 15 z_1^2 z_2 - 12 z_2^2 z_1 \\
 & - 6 z_1^2 z_2^2 + z_1^2 z_4^2 - 19 z_1^2 z_2^2 z_4 + 11 z_2^2 z_1 z_4 + 10 z_2^2 z_1 z_4 \\
 & - 4 z_1^2 z_2^2 z_4 + 2 z_2^2 z_1 z_4 - 10 z_2^2 z_1 z_4 + 3 z_2^3 z_1 - 20 z_2^3 z_4 \\
 & + 5 z_2^3 z_4 + 10 z_1^2 z_4^2 + 3 z_2^2 z_4^2 - 8 z_2^2 z_5^2 - 7 z_1^2 z_5^2 + 32 z_2^2 z_5^2 \\
 & + 12 z_1^2 z_2^2 z_4 - 6 z_2^3 z_1 z_4 + 4 z_1^2 z_2^3 z_4 + 2 z_1^2 z_2^3 z_4 z_5 \\
 & + 36 z_2^2 z_1 z_4 z_5 - 2 z_2^2 z_1 z_4^2 + 2 z_2^3 z_1 z_4^2 - 4 z_1^2 z_2^2 z_4^2
 \end{aligned}$$

$$\begin{aligned}
& + 2 z^2 z^2 z^1 z^4 - 16 z^2 z^1 z^5 + 22 z^1 z^2 z^5 - 8 z^2 z^1 z^5 - 12 z^1 z^2 z^5 \\
& - 2 z^2 z^4 - 4 z^1 z^4 + 2 z^2 z^4 - 16 z^1 z^4 - 10 z^2 z^1 z^4 z^5 \\
& - 10 z^1 z^2 z^4 z^5 + 8 z^2 z^1 z^4 z^5 - 2 z^2 z^1 z^4 z^5 + 8 z^1 z^2 z^4 z^5 \\
& - 4 z^2 z^1 z^4 z^5 + 6 z^2 z^1 z^5 - 32 z^2 z^4 z^5 + 10 z^2 z^4 z^5 + 4 z^1 z^4 z^5 \\
& - 2 z^2 z^4 z^5 - 10 z^1 z^4 z^5 - 19 z^1 z^4 z^5 - z^1 z^4 + 20 z^1 z^5 + 3 z^1 z^4 \\
& + 20 z^1 z^5 + 32 z^2 z^5 - 32 z^2 z^1 z^5 + 8 z^2 z^1 z^5 + 11 z^1 z^5 z^4 \\
& - 8 z^2 z^5 + 10 z^2 z^1 z^5 z^4 + 8 z^2 z^1 z^5 z^4 - 4 z^2 z^1 z^5 z^4 \\
& - 8 z^2 z^5 z^4 - 10 z^2 z^1 z^5 + 4 z^2 z^1 z^5 - 12 z^1 z^5 z^4 + 6 z^1 z^5 z^4 \\
& - 4 z^2 z^5 z^4 + 2 z^2 z^5 z^4 + 5 z^1 z^5 + 8 z^2 z^5 - 2 z^2 z^5 \\
& + 4 z^2 z^5 z^4 - 10 z^2 z^1 z^5 z^4 + 6 z^1 z^4 z^5 + 2 z^1 z^2 z^5 + 3 z^1 z^5 \\
& + 8 z^1 z^2 z^5 z^4 + 2 z^2 z^1 z^5 - 4 z^1 z^2 z^5 - 10 z^1 z^5 z^4 \\
& - 2 z^1 z^5 z^4 - 4 z^1 z^5 z^4 - 4 z^2 z^1 z^4 z^5 - 2 z^2 z^4 z^5 \\
& + 2 z^1 z^4 z^5 + 2 z^2 z^4 z^5 + 2 z^1 z^5 - 2 z^1 z^2 z^5 - z^1 + z^4
\end{aligned}$$

$$\begin{aligned}
& - 2 z_1^3 z_4 z_5 - 3 z_1^3 z_1 + 3 z_1^3 z_4 - 6 z_1^3 z_5 + 4 z_1^3 z_4^2 - 2 z_1^3 z_5^2 \\
& + 12 z_4^2 z_5 + 12 z_4^2 z_5^2 - 6 z_4^2 z_5^2 - 15 z_4^2 z_5^2 + 20 z_4^2 z_2 - 8 z_4^2 \\
& - 32 z_5^2 z_2 - 32 z_5^2 z_2 + 2 z_1^3 z_2 z_4 - 4 z_1^3 z_2 z_4 z_5 + 2 z_1^2 z_5^2 z_4 \\
& + 3 z_1^3 z_2 / \\
& - z_4 - 1) (-z_2 + z_1 + 2) (z_1 - z_4) (z_1 - z_2 + 1)
\end{aligned}$$

Here the denominator contains the term $(z_1 - z_4)$, this shows the singularity is not removable.

References

- [BD] A. A. Belavin, V. G. Drinfeld, *Solutions of the classical Yang-Baxter equation for simple Lie algebras*, *Funct. Anal. and Appl.* **16**, 159-180 (1982).
- [C1] I. V. Cherednik, *On special bases of irreducible finite-dimensional representations of the degenerate affine Hecke algebra*, *Funct. Anal. Appl.* **20** (1986) 87-89.
- [C2] I. V. Cherednik, *A new interpretation of Gelfand-Zetlibases*, *Duke Math. J* **54** (1987) 563-577.
- [C3] I. V. Cherednik, *A unification of Knizhnik-Zamolodchikov and Dunkle operators via affine Hecke algebras*, *Invent. Math.*, **106** (1991), no.2, 411-431.
- [C4] I. V. Cherednik, *Degenerate affine Hecke algebras and two-dimensional particles*, *Int. J. Mod. Phys A* . **7**, Suppl. 1A, 109-140, (1992).
- [CR] C. Curtis and I. Reiner, *Representation theory of finite groups and associative algebras*, Interscience Publishers, 1962.
- [D1] V. G. Drinfeld, *Hopf algebras and the quantum Yang-Baxter equation*, *Soviet Math. Dokl*, **32**, 254-258 (1985).
- [D2] V. G. Drinfeld, *Degenerate affine Hecke algebras and Yangians*, *Funct. Anal. Appl.* **20** (1986), 56-58.
- [D3] V. G. Drinfeld, *Quantum Groups*, ICM Proceedings, Berkeley, 798-820, 1986.
- [ER] Ö. N. Eğecioğlu and J.B. Remmel, *A combinatorial proof of the Giambelli Identity for Schur functions*, *Adv. in Math.* **70** (1988), no. 1, 59-86.
- [FRT] L. D. Faddeev, N. Yu. Reshetikhin, L.A. Takhtajan, *Quantization of Lie Groups and Lie Algebras*, *Algebraic Analysis* **1**, (1988).

- [FST1] L. D. Faddeev, E. K. Sklyanin, L. A. Takhtajan, *The quantum inverse problem I*, Theoret. Math. Phys, **40**, 194-220 (1979)
- [FST2] L. D. Faddeev, E. K. Sklyanin, L. A. Takhtajan, *Integrable models in (1+1)-dimensional quantum field theory*, Les Houches Session **XXXIX**, 563-608, Elsevier, Amsterdam, 1982.
- [Gi] G. Z. Giambelli, *Alcuna proprietà delle funzioni simmetriche caratteristiche*, Atti Accad. Sci. Torino Cl. Sci. Fis. Mat. Natur. **38** (1903), 323-344.
- [GP] V. Guizi and P. Papi, *A combinatorial approach to the fusion process for the symmetric group*, European Journal of Combinatorics, **19** (1998), 835-845.
- [Gr1] J. Grime, *The hook fusion procedure*, Electronic Journal of Combinatorics, **12** (2005), R26.
- [Gr2] J. Grime, *The hook fusion procedure for Hecke algebras*, Journal of algebra, **309** (2007), 744-759.
- [Gy] A. Gyoja, *A q -analogue of Young symmetrizer*, Osaka J. Math. **23** (1986), 841-852.
- [GU] A. Gyoja and K. Uno, *On the semisimplicity of Hecke algebras*, J. Math. Soc. Japan **41** (1989), 75-79.
- [H] P. N. Hoefsmit, *Representations of Hecke algebras of finite groups with BN -pairs of classical type*, Thesis, University of British Columbia, 1974.
- [HG] A. M. Hamel and I. P. Goulden, *Planar decomposition of tableaux and Schur function determinants*, Europ. J. Combin., **16** (1995), 461-477.
- [JN] A. Jones and M. Nazarov, *Affine Sergeev algebra and q -analogues of the Young symmetrizers for projective representations of the symmetric group*, Proc. London Math. Soc. **78** (1999), 481-512.
- [Ji1] M. Jimbo, *A q -difference analogue of $U_q\mathfrak{g}$ and the Yang-Baxter equation*, Lett. Math. Phys. **10**, 63-69 (1985).

- [Ji2] M. Jimbo, *Introduction to the Yang-Baxter equation*, International Journal of Modern Physics A, Volume 4, Issue 15, pp. 3759-3777 (1989).
- [Ju] A. Jucys, *On the Young operators of the symmetric group*, Lietuvos Fizikos Rinkinys. **6** (1966), 163-180.
- [KRS] P. P. Kulish, N. Yu. Reshetikhin, E. K. Sklyanin, *Yang-Baxter equation and representation theory I*, Lett. Math. Phys. **5**, 393-403, (1981).
- [KS] P. P. Kulish, E. K. Sklyanin, *Solutions to the Yang-Baxter equation*, J. Soviet Math **19**, 1596-1620 (1982).
- [LLT] A. Lascoux, B. Leclerc and J.Y. Thibon, *Flag varieties and the Yang-Baxter equation*, Lett. Math. Phys. **40** (1997), 75–90.
- [LNT] B. Leclerc, M. Nazarov and J.Y. Thibon, *Induced representations of affine Hecke algebras and canonical bases of quantum groups*, Progress in Mathematics **210**, 115-153, (2003).
- [LP] A. Lascoux and P. Pragacz, *Ribbon Schur functions*, Europ. J. Combin., **9** (1988), 561-574.
- [LZ] B. Leclerc and A. Zelevinsky, *Quasicommuting families of quantum Plücker coordinates*, Amer. Math. Soc. Translat. **181** (1998), 85–108.
- [Mo] A. I. Molev, *On the matrix units for the symmetric group*, math.RT/0612207.
- [Mu1] G. Murphy, *A new construction of Young's seminormal representation of the symmetric group*, J. Algebra **69** (1981), 287-291.
- [Mu2] G. Murphy, *On the representation theory of the symmetric groups and associated Hecke algebras*, J. Algebra **152** (1992), 492–513.
- [MD] I. G. Macdonald, *Symmetric functions and Hall polynomials*, Oxford Univ. Press, London/New York, 1979.
- [MG] J. B. McGuire, *Study of exactly solvable one-dimensionable N-body problems*, J. Math. Phys. **5**, 622-636 (1964).

- [N1] M. Nazarov, *A mixed hook-length formula for affine Hecke algebras*, European J. Combinatorics **25** (2004), 1345-1376.
- [N2] M. Nazarov, *Mixed hook-length formula for degenerate affine Hecke algebras*, Lecture Notes in Math. **1815** (2003), 223-236.
- [N3] M. Nazarov, *Young's symmetrizers for projective representations of the symmetric group*, Adv. Math. **127** (1997), no. 2, 190–257.
- [N4] M. Nazarov, *Yangians and Capelli Identities*, Amer. Math. Soc Translations **181** (1998), 139-163.
- [N5] M. Nazarov, *Representations of twisted Yangians associated with skew Young diagrams*, Selecta Math. **10** (2004), 71-129.
- [NT] M. Nazarov and V. Tarasov, *On irreducibility of tensor products of Yangian modules associated with skew Young diagrams.*, Duke Math Jour. **112** (2002), 343-378.
- [OV] A. Okounkov and A. Vershik, *A new approach to representation theory of symmetric groups*, Selecta Math, **2** (1996), no. 4, 581–605.
- [Sa] B. E. Sagan, *The symmetric group. Representations, combinatorial algorithms, and symmetric functions. Second edition*, Springer. Graduate texts in Mathematics, (2001).
- [Sk] E. K. Sklyanin, *Some algebraic structure connected with the Yang-Baxter equation*, Funct. Anal. and Appl. **16**, 27-34 (1982); **17**, 273-284 (1983).
- [Ya] C. N. Yang, *Some exact results for the many-body problem in one dimension with repulsive delta-function interaction*, Phys. Rev. Lett, **19**, 1312-1314 (1967).
- [Yo1] A. Young, *On quantitative substitutional analysis I, II*, Proc. London Math. Soc. **33** (1901) 97-146, **34** (1902) 361-397.
- [Yo2] A. Young, *On quantitative substitutional analysis VI*, Proc. London Math. Soc. **31** (1931) 253-289.