

# The Kinetostatic Optimization of a Novel Prismatic Drive

D. Chablat\* S. Caro†

Institut de Recherche en Communications et Cybernétique de Nantes, UMR CNRS n° 6597  
1 rue de la Noë, 44321 Nantes, France

**Abstract**—*The design of a mechanical transmission taking into account the transmitted forces is reported in this paper. This transmission is based on Slide-o-Cam, a cam mechanism with multiple rollers mounted on a common translating follower. The design of Slide-o-Cam, a transmission intended to produce a sliding motion from a turning drive, or vice versa, was reported elsewhere. This transmission provides pure-rolling motion, thereby reducing the friction of rack-and-pinions and linear drives. The pressure angle is a suitable performance index for this transmission because it determines the amount of force transmitted to the load vs. that transmitted to the machine frame. To assess the transmission capability of the mechanism, the Hertz formula is introduced to calculate the stresses on the rollers and on the cams. The final transmission is intended to replace the current ball-screws in the Orthoglide, a three-DOF parallel robot for the production of translational motions, currently under development for machining applications at École Centrale de Nantes.*

**Keywords:** Optimal design, Slide-o-Cam, Pressure angles, Hertz's formula

## I. Introduction

In robotics and mechatronics applications, whereby motion is controlled using a piece of software, the conversion from rotational motion to translational one is usually realized by means of *ball-screws* or *linear actuators*. The both are gaining popularity. However they present some drawbacks. On the one hand, ball-screws comprise a high number of moving parts, their performance depending on the number of balls rolling in the shaft groove. Moreover, they have a low load-carrying capacity, due to the punctual contact between the balls and the groove. On the other hand, linear bearings are composed of roller-bearings to figure out the previous issue, but these devices rely on a form of direct-drive motor, which makes them expensive to produce and maintain.

A novel transmission, called *Slide-o-Cam* is depicted in Fig. 1 and was introduced in [1] to transform a rotational motion to a translational one. Slide-o-Cam is composed of four main elements: (i) the frame; (ii) the cam; (iii) the follower; and (iv) the rollers. The input axis on which the cams are mounted, named *camshaft*, is driven at a constant

angular velocity by means of an actuator under computer-control. Power is transmitted to the output, the translating follower, which is the roller-carrying slider, by means of pure-rolling contact between the cams and the rollers. The roller comprises two components, the pin and the bearing. The bearing is mounted to one end of the pin, while the other end is press-fit into the roller-carrying slider. Consequently, the contact between the cams and rollers occurs at the outer surface of the bearing. The mechanism uses two conjugate cam-follower pairs, which alternately take over the motion transmission to ensure a positive action; the rollers are thus driven by the cams throughout a complete cycle. Therefore, the main advantages of cam-follower mechanisms with respect to the other transmissions, which transform rotation into translation are: (i) the lower friction; (ii) the higher stiffness; and (iii) the reduction of wear.

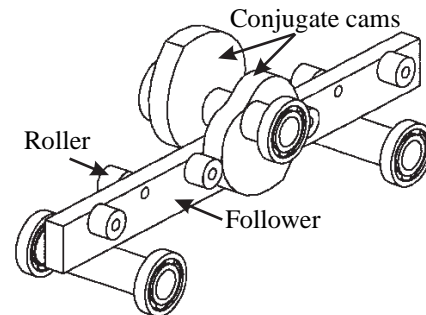

Fig. 1. Layout of Slide-o-Cam

Many researchers have devoted their efforts to study contact stress distribution and predict surface fatigue life in machine parts under different types of loading. Indeed, when two bodies with curved surfaces, for example, a cam and a roller, are pressed together, the contact is not linear but a surface. The stress occurred may generate failures such as cracks, pits, or flaking in the material. Heinrich Rudolf Hertz (1857-1894) came up with a formula to evaluate the amount of surface deformation when two surfaces (spherical, cylindrical, or planar) are pressed each other under a certain force and within their limit of elasticity.

## II. Synthesis of Planar Cam Mechanisms

Let the  $x$ - $y$  frame be fixed to the machine frame and the  $u$ - $v$  frame be attached to the cam, as depicted in Fig. 2.  $O_1$  is the origin of both frames,  $O_2$  is the center of the roller,

\*E-mail: Damien.Chablat@ircyn.ec-nantes.fr

†E-mail: Stephane.Caro@ircyn.ec-nantes.fr



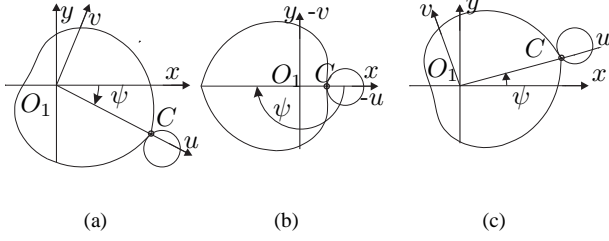

Fig. 4. Orientations of the cam found when  $v_c = 0$ : (a)  $\psi = \Delta$ ; (b)  $\psi = \pi$ ; and (c)  $\psi = 2\pi - \Delta$

### B. Geometric Constraints on the Mechanism

In order to lead to a feasible mechanism, the radius  $a_4$  of the roller must satisfy two conditions, as shown in Fig. 5a:

- Two consecutive rollers on the same side of the roller-carrying slider can not collide. Since  $p$  is the distance between the centers of two consecutive rollers, the constraint  $2a_4 < p$  has to be respected.
- Likewise, the radius  $b$  of the camshaft has to be considered. Therefore, the following condition has to be respected:  $a_4 + b \leq e$ , which can be written in terms of  $\eta$ :

$$a_4/p \leq \eta - b/p \quad (9)$$

According to the initial configuration of the roller, as de-

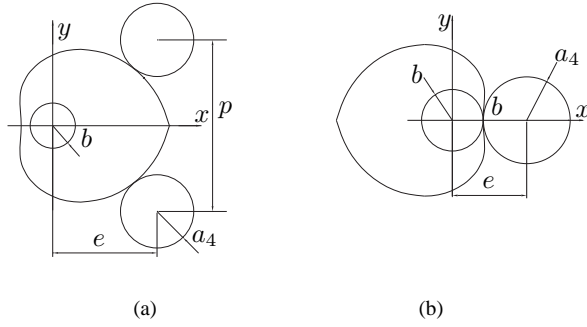

Fig. 5. Constraints on the radius of the roller: (a)  $a_4/p < 1/2$ ; and (b)  $a_4/p \leq \eta - b/p$ .

icted in Fig. 3, the  $v$ -component of the Cartesian coordinate of contact point  $C$  is negative in this configuration, *i.e.*,  $v_c(0) \leq 0$ . Moreover, from the expression of  $v_c(\psi)$  and for parameters  $b_3$  and  $\delta$  given in Eqs. (3b), (7b & c), respectively, the above relation leads to the condition:

$$\left( \frac{p}{2\pi a_4} \sqrt{(2\pi\eta - 1)^2 + (-\pi)^2} - 1 \right) \sin \left[ \arctan \left( \frac{-\pi}{2\pi\eta - 1} \right) \right] \leq 0$$

It turns out that the constraint  $v_c(0) \leq 0$  leads to a constraint on  $\eta$ , namely [5],

$$\eta > 1/(2\pi) \quad (10)$$

### C. Curvature of the Cam Profile

The curvature of any planar parametric curve, in terms of the Cartesian coordinates  $u$  and  $v$ , and parameterized with any parameter  $\psi$ , is given by [3]:

$$\kappa = \frac{v'(\psi)u''(\psi) - u'(\psi)v''(\psi)}{[u'(\psi)^2 + v'(\psi)^2]^{3/2}} \quad (11)$$

The curvature  $\kappa_p$  of the pitch curve is given in [5] as

$$\kappa_p = \frac{2\pi [(\psi - \pi)^2 + 2(2\pi\eta - 1)(\pi\eta - 1)]}{p [( \psi - \pi)^2 + (2\pi\eta - 1)^2]^{3/2}} \quad (12)$$

provided that the denominator never vanishes for any value of  $\psi$ , *i.e.*, provided that

$$\eta \neq 1/(2\pi) \quad (13)$$

Let  $\rho_c$  and  $\rho_p$  be the radii of curvature of both the cam profile and the pitch curve, respectively, and  $\kappa_c$  the curvature of the cam profile. Since the curvature is the reciprocal of the radius of curvature, we have  $\rho_c = 1/\kappa_c$  and  $\rho_p = 1/\kappa_p$ . Furthermore, due to the definition of the pitch curve, it is apparent that

$$\rho_p = \rho_c + a_4 \quad (14)$$

Writing Eq. (14) in terms of  $\kappa_c$  and  $\kappa_p$ , we obtain the curvature of the cam profile as

$$\kappa_c = \frac{\kappa_p}{1 - a_4\kappa_p} \quad (15)$$

### D. Physical constraints

Let us assume that the surfaces of contact are ideal, smooth and dry, with negligible friction. The relations between the forces of contact are described below:

- Two relations follow from the strength of materials. Besides, the bearing shafts are subject to shearing, whereas the camshafts are subject to shearing and bending. Consequently, we come up with the following relations:

$$\tau_{c_{max}} \geq 8M_t \left( \frac{2}{\pi \phi_{cam}^3} + \frac{1}{p \phi_{cam}^2} \right) \quad (16)$$

$$\tau_{b_{max}} \geq \frac{8M_t}{p \phi_{bear}^2} \quad (17)$$

where,

$\phi_{cam}$  is the diameter of the camshaft ( $\phi_{cam} = 2(e - a_4)$ );  
 $\phi_{bear}$  is the diameter of the bearing shaft ( $\phi_{bear} = 2a_4$ );  
 $M_t$  is the torque applied to the camshaft;

$\tau_{c_{max}}$  is the maximum allowable stress inside the cam axis which cannot be exceeded in the camshaft;

$\tau_{b_{max}}$  is the maximum stress inside the bearing's axis which cannot be exceeded in the bearing shaft;

Let us assume that the material of the cam and the one of the roller have the same Young modulus  $E$  and Poisson ratio. The Hertz's formula [8] yields the maximum pressure

of contact between the cams and rollers. Depending on the material, surface roughness and possible surface treatment, the Hertz pressure  $P_{Hertz}$  must remain smaller than a maximum value  $P_{max}$ .

$$P_{Hertz} \equiv 0.418 \sqrt{\frac{F E}{a r_{eq}}} \leq P_{max} \quad (18)$$

where,

$$F \text{ is the axial load, } F = \sqrt{\left(M_t \frac{2\pi}{p}\right)^2 + \left(M_t \frac{2\pi}{p \tan(\delta)}\right)^2},$$

$r_{eq}$  is the equivalent radius of the contact,  
 $a$  is the width of the cam and the roller,

$$r_{eq} = 1 / \left( \frac{2}{\phi_{cam}} + \frac{2}{\phi_{bear}} \right)$$

$P_{max}$  is the maximum pressure acceptable between two surfaces of contact.

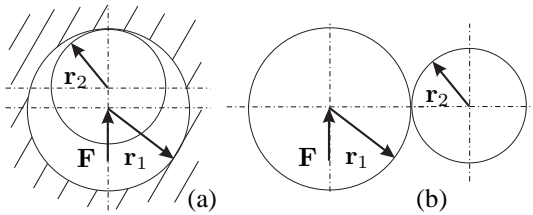

Fig. 6. Equivalent radius of contact with (a) a positive and a negative radius and (b) two positive radius

To minimize the Hertz pressure, we must maximize the equivalent radius of contact. Figure 6(a) shows an optimal configuration to minimize the Hertz pressure [4], i.e. the stresses bear opposite sign. The roller of radius  $r_1$  is included in the roller of radius  $r_2$  being smaller than  $r_1$  but close to it. However, this layout does not occur in Slide-o-Cam because the contact changes between the cam and rollers. Indeed, Fig. 6(b) depicts the actual configuration. In this case, the only way to minimize the Hertz pressure is to maximize the diameter of the roller and the curvature of the cam.

The Hertz pressure is evaluated only when the cam pushes the roller. The active interval is [5]:

$$\frac{\pi}{n} - \Delta \leq \psi \leq \frac{2\pi}{n} - \Delta$$

**E. Implementation**

A graphic user interface (GUI) based on the synthesis of planar cam mechanism is implemented in Excel, as shown in Fig. 7. This GUI allows the user to determine the dimensions of the cams. The value in blue cells have to be defined by the user. The results are shown in the yellow cells whereas the critical values are displayed in red cells. The GUI allows the user to test and visualize the cam profile generated. The algorithm underlying this GUI is shown

Data input:			
Engine torque =	1,2 N.m	Ceng =	1,2 N.m
Pitch =	20 mm	pitch =	0,02 m
Number of Lobs =	1	nbl =	1
Number of Cams =	2	nbc =	2
Data material:			
For the Cams:			
Maximum stress =	150 Mpa	am =	2E+08 Pa
Young modulus =	210000 Mpa	am =	2E+11 Pa
Axis of the Bearing:			
Maximum stress =	150 Mpa	xe =	2E+08 Pa
Young modulus =	210000 Mpa	ds =	2E+11 Pa
Calculations of dimensions:			
Axial Loading =	0,38 kN	Ial =	376,99 N
Proposals:			
Cams diameter =	3,22 mm		Proposal to support the force exchanged
Axis diameter =	1,79 mm		
Input Dimensions:		Constraints:	
Cams diameter =	1 mm	DiamC =	0,001 m
Bearing diameter =	8 mm	DiamA =	0,008 m
			-1,6 < Cam diameter (mm)
			5,4 < Bearing diameter (mm)
Stress Calculation:			
Stress cam =	6592 Mpa		7E+09 Pa
Stress axis =	8 Mpa		8E+06 Pa
Pressure-Angle:			
mu			
mu_min =	5,48 °		0,0956 rad
mu_max =	19,46 °		0,3396 rad
Δ mu =	13,98 °		0,244 rad
Width of the Contact:			
Width =	10 mm		Surface de Hertz
Curve of the cam =	13,59 mm		thickness of the contact
Curve of the cam =	3,29 mm		Maximum local curvature radius
E equivalent =	230769 Mpa		Minimum local curvature radius
P_Hertz min =	702 Mpa		red if P_Hertz > 1300 Mpa
P_Hertz max =	918 Mpa		
l =	62 μm		approximate width of the contact

Fig. 7. Worksheet of Slide-o-Cam

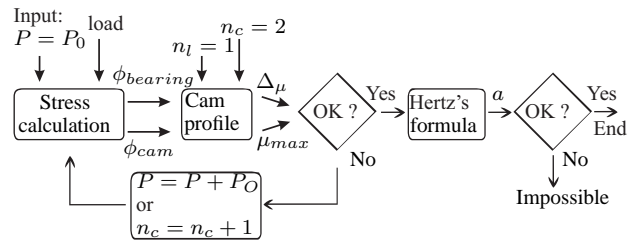

Fig. 8. Scheme of the design process

in Fig. 8.

1. The engine torque and the pitch  $p$  are assigned by the user;
2. for a given material of the camshaft and the roller, the minimum diameters are computed;
3. the shape of the cam and the pressure angle are defined;
4. in case the pressure angle is too high, the initial parameters and the number of cams are reassigned;
5. in the other case, the Hertz pressure is evaluated to define the width of the cam and roller.

### III. Influence of the design parameters on the pressure angle and the Hertz pressure

#### A. Analysis

The maximal value of the Hertz pressure depends on several parameters, namely, the number of conjugate cams, the material of the parts in contact, the geometry of the cams, and the load applied. The pressure angle can be optimized with regards to the number of cams and the shape of the cams [5]. There are many ways to minimize the Hertz pressure:

- increase the number of conjugate cams in order to decrease the maximum pressure angle. Nevertheless, the number of simultaneous contact lines does not increase.
- decrease the axial load. It can be done by increasing the pitch of the transmission.
- choose a material with a lower Young modulus. However, when the material is more compliant, the maximum pressure acceptable decreases because the plastic domain occurs for smaller stress.
- decrease the minimum radius of the cam. This feature will be used in the next section.
- increase the width of the cam and the roller.

#### B. Design strategies

In this section, we present four strategies to minimize the radius of the cam:

1. The lower  $e$ , the distance between the cam axis and the bearing axis, the lower the maximum pressure angle  $\mu_{max}$  and its range  $\Delta\mu$ . This involves the removal of the bearing between the shaft and the cam and its offset on the base.
2. With the first design strategy, the bearings can collide with the camshaft. In order to figure out this issue, the distance  $e$  is increased. However, the advantages of the first solution are not maintained. In this case, a good compromise is to use two lines of followers on both sides of the cams.
3. Another solution is to use cams assembled on the shaft. This design is more complex, but has some advantages. For instance, by means of a FEM, the optimal diameters of the camshaft and the roller are equal to 16 mm and 14 mm, respectively. For these values,  $\mu_{max} = 53.8^\circ$  and  $\Delta\mu = 35.6^\circ$  as illustrated in Fig. 9(a). With an inserted cam, we come up with a better design:  $\mu_{max} = 15.6^\circ$ ,  $\Delta\mu = 11.2^\circ$  and  $\phi_{cam} = 3$  mm as illustrated in Fig. 9(b).
4. In the first design of the Slide-o-Cam transmission, the motor is fixed, as shown in Fig. 10(a). We have the following drawbacks:
  - For the same length of displacement, the length of the module is double because of guidance;
  - The effector being positioned at the end of the follower, the latter is subjected to bending;
  - Many parts are assembled between the motor and the effector. Consequently, the stiffness of the unit is smaller.

To figure out with these issues, the motor can be linked to the end-effector so that they can move altogether, as shown in Fig. 10(b).

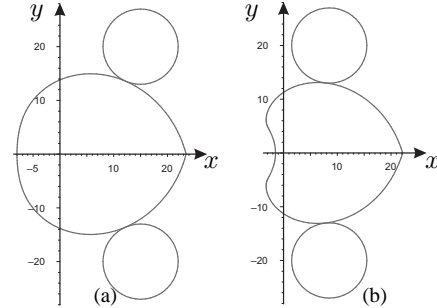

Fig. 9. Design strategies of Slide-o-Cam with (a)  $\phi_{cam} = 16\text{mm}$ ,  $a_4 = 7\text{mm}$ ,  $p = 40\text{mm}$ ,  $\mu_{max} = 53.8^\circ$  and  $\Delta\mu = 35.6^\circ$  and (b)  $\phi_{cam} = 3\text{mm}$ ,  $a_4 = 7\text{mm}$ ,  $p = 40\text{mm}$ ,  $\mu_{max} = 15.6^\circ$  and  $\Delta\mu = 11.1^\circ$

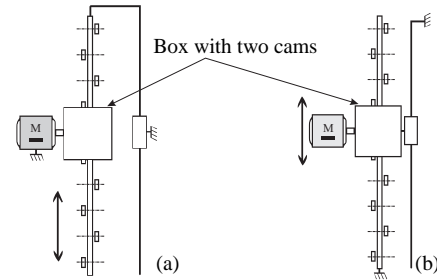

Fig. 10. Parametrization of Slide-o-Cam with (a) motor fixed and (b) motor fixed on the cam mechanism

If we apply the previous design strategies, we will replace the classical ball-screws, Fig. 11(a), by a new transmission where the motor moves with the camshaft and the effector is attached to it, Fig. 11(b).

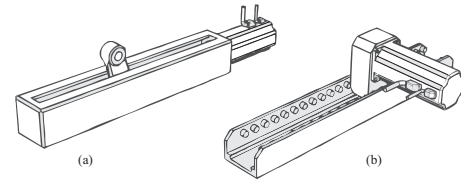

Fig. 11. Conversion of motion from rotational to translational made by (a) a ball-screws and (b) Slide-o-Cam with motor embedded

### IV. Implementation of the transmissions to the Orthoglide

A motivation of this research work is to design a *Slide-o-Cam* transmission for high-speed machines. As mentioned in the introduction, this mechanism should be suitable for the *Orthoglide*, which is a low power machine tool, as shown in Fig. 12 [9]. Here is a list of its features:



Case #	$P_{max}$	$P_{min}$	$\mu_{max}$	$r_{cam_{min}}$
(a)	786 MPa	579 MPa	8.0°	1.13mm
(b)	933 MPa	492 MPa	15.8°	0.08mm
(c)	732 MPa	492 MPa	26.6°	1.44mm
(d)	689 MPa	522 MPa	30.0°	1.6mm

TABLE I. The Hertz pressure obtained for four design strategies with  $a = 20mm$

- ball screw engine torque = 1.2 N.m;
- ball screw engine velocity = 0 to 3000 rpm;
- ball screw pitch = 20 mm/turn;
- axial static load = 376 N;
- stiffness = 130 N/ $\mu$ m.

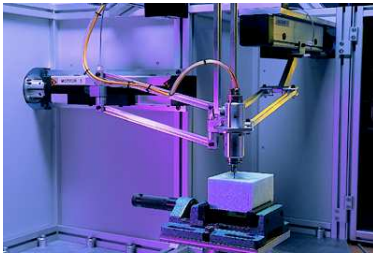

Fig. 12. The Orthoglide (©CNRS Photothèque / CARLSON Leif)

Let us assume that the maximum stress that the shafts can support is equal to 150 MPa. We can compute the minimum diameter of the bearing shaft  $\phi_{bear}$  and the cam shaft  $\phi_{cam}$  to transmit the load. The minimum diameter of the bearing shaft  $\phi_{bear}$  is equal to 1.8 mm. Likewise, the minimum diameter of the camshaft  $\phi_{cam}$  is equal to 3.75 mm.

Table I and Fig. 13 depict four design strategies applied to the Orthoglide. In case of high-speed operations, angular velocities of cams are higher than 50 rpm. Therefore, the pressure angle has to be smaller than 30°. For instance, with case study (d) the Hertz pressure is a minimum but the pressure angle is a maximum.

From cases (a) to (d), the local radius of the cam increases from 0.08 mm to 1.6 mm. This feature verifies the assumption of section II.D related to the minimization of the Hertz pressure. For the optimal design, the Orthoglide can transmit the load with  $\phi_{cam} = 3.8$  mm.

## V. Acknowledgments

This research work was made in the context of an exchange between McGill University and Centrale Nantes, which allows Lucas Chabert to work six months in Montreal. Moreover, the authors would like to thank Prof. Jorge Angeles for his great help and good advice.

## VI. Conclusions

New design strategies were presented in this paper to minimize the Hertz pressure in the rollers and the cam of the Slide-o-Cam mechanism. A graphic user interface was

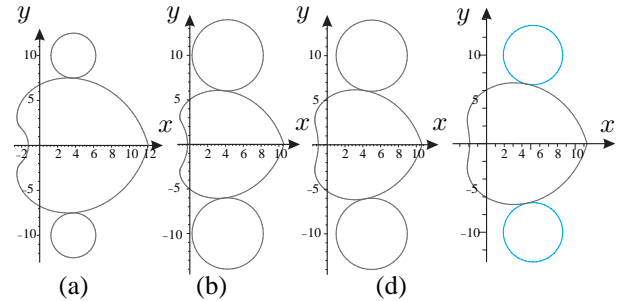

Fig. 13. Design strategies of Slide-o-Cam for the Orthoglide with (a)  $\phi_{cam} = 2.5mm$ ,  $\phi_{bear} = 5mm$ ,  $\mu_{max} = 8.0^\circ$  and  $\Delta\mu = 5.7^\circ$ , (b)  $\phi_{cam} = 0.5mm$ ,  $\phi_{bear} = 8mm$ ,  $\mu_{max} = 15.8^\circ$  and  $\Delta\mu = 11.3^\circ$ , (c)  $\phi_{cam} = 2mm$ ,  $\phi_{bear} = 8mm$ ,  $\mu_{max} = 26.6^\circ$  and  $\Delta\mu = 19.0^\circ$  and (d)  $\phi_{cam} = 3.8mm$ ,  $\phi_{bear} = 6.7mm$ ,  $\mu_{max} = 30.0^\circ$  and  $\Delta\mu = 21.5^\circ$

developed to synthesize planar cam mechanisms, considering their physical constraints. The cam profiles generated can be used to realize CAD models.

The main contribution of this research work lies in the study of the influence of the pressure angle on the Hertz pressure. As a matter of fact, the smaller the pressure angle of a cam, the higher its Hertz pressure. In order to reduce the maximum Hertz pressure of a cam, we defined its parameters in order to keep the pressure angle smaller than 30°.

## References

- [1] González-Palacios, M.A. and Angeles, J., 2003, "The design of a novel pure-rolling transmission to convert rotational into translational motion", *Journal of Mechanical Design*, Vol. 125, pp. 205–207
- [2] Waldron, K. J. and Kinzel, G. L., 1999, *Kinematics, Dynamics, and Design of Machinery*, John Wiley & Sons, Inc., New York.
- [3] Angeles, J. and López-Cajún, C., 1991, *Optimization of Cam Mechanisms*, Kluwer Academic Publishers B.V., Dordrecht.
- [4] Carra, S., Garziera, R. and Pellegrini, M., 2004, "Synthesis of cams with negative radius follower and evaluation of the pressure angles," *Mechanism and Machine Theory*, Vol. 34, pp. 1017–1032.
- [5] Renotte J., Chablat D. and Angeles J., 2004, "The Design of a Novel Prismatic Drive for a Three-DOF Parallel-Kinematics Machine," *ASME Design Engineering Technical Conferences*, September - October 28-2, Salt Lake City, Utah, USA.
- [6] González-Palacios, M. A. and Angeles, J., 1993, *Cam Synthesis*, Kluwer Academic Publishers B.V., Dordrecht.
- [7] Lee, M.K., 2001, *Design for Manufacturability of Speed-Reduction Cam Mechanisms*, M.Eng. Thesis, Dept. of Mechanical Engineering, McGill University, Montreal.
- [8] Golovin A., Borisov A., Drozdova I., and Shuman B., 2005, "The simulating model of a gearing wear", Moscow State Technical University named after M.E. Bauman, Moscow, Russia.
- [9] Chablat, D. and Wenger Ph., 2003, "Architecture Optimization of a 3-DOF Parallel Mechanism for Machining Applications, the Orthoglide," *IEEE Transactions on Robotics and Automation*, Vol. 19/3, pp. 403–410, June.

