

COMPUTING WORD LENGTH IN ALTERNATE PRESENTATIONS OF THOMPSON'S GROUP F

MATTHEW HORAK, MELANIE STEIN, AND JENNIFER TABACK

ABSTRACT. We introduce a new method for computing the word length of an element of Thompson's group F with respect to a "consecutive" generating set of the form $X_n = \{x_0, x_1, \dots, x_n\}$, which is a subset of the standard infinite generating set for F . We use this method to show that (F, X_n) is not almost convex, and has pockets of increasing, though bounded, depth dependent on n .

1. INTRODUCTION

Many questions in geometric group theory investigate whether a particular group has a given property. An ideal answer involves a determination of whether the group has the property with respect to all, none or some generating sets. There are few definitive answers of this form when the group in question is Thompson's group F because there is a single finite generating set with respect to which the word length of group elements can be computed. This allows results for F such as

Theorem 1.1. *With respect to the generating set $\{x_0, x_1\}$, Thompson's group F*

- (1) *is not almost convex.* [CT1]
- (2) *has only pockets of depth two.* [CT2]

Ideally we would like to determine whether the group has these, or other, properties with respect to any or no generating set, or list exactly those generating set which yield these properties.

In this paper, we present a method for computing the word length of elements of F with respect to *consecutive* generating sets of the form $X_n = \{x_0, x_1, \dots, x_n\}$. This greatly expands the set of generating sets in which we can compute the word length. We note that the three known methods of computing word length for the generating set $\{x_0, x_1\}$, due to Guba [G], Fordham [F] and Belk-Brown [BB], are all special cases of our procedure when $n = 1$.

We use this method to prove the following theorems which extend the results listed above in Theorem 1.1.

Theorem 6.1. Thompson's group F is not almost convex with respect to the generating set $X_n = \{x_0, x_1, \dots, x_n\}$.

Theorem 7.1. For any $k \geq 1$, Thompson's group F has pockets of depth at least k with respect to the generating set $X_n = \{x_0, x_1, \dots, x_n\}$, for $n \geq 2k + 2$.

In addition, we are able to provide an upper bound on the depth of these pockets which is also dependent on n .

Date: April 14, 2022.

The third author acknowledges partial support from National Science Foundation grant DMS-0437481.

This paper is organized as follows. The second section provides a short introduction to Thompson's group F . The third section outlines and proves our procedure for computing word length, although the proofs of the two main lemmas are deferred to sections four and five. Section six is devoted to the proof of Theorem 6.1, and in section seven we prove Theorem 7.1 as well as an upper bound on pocket depth.

2. BACKGROUND ON THOMPSON'S GROUP F

We present a brief introduction to Thompson's group F and refer the reader to [CFP] for a more detailed discussion. This group can be studied either as a finitely or infinitely presented group, using the two standard presentations:

$$\langle x_k, k \geq 0 \mid x_i^{-1} x_j x_i = x_{j+1} \text{ if } i < j \rangle$$

or, as it is clear that x_0 and x_1 are sufficient to generate the entire group, since powers of x_0 conjugate x_1 to x_i for $i \geq 2$,

$$\langle x_0, x_1 \mid [x_0 x_1^{-1}, x_0^{-1} x_1 x_0], [x_0 x_1^{-1}, x_0^{-2} x_1 x_0^2] \rangle.$$

The relators in the infinite presentation are all a consequence of the basic set of two relators given in the finite presentation.

With respect to the infinite presentation, each element $g \in F$ can be written in normal form as

$$g = x_{i_1}^{r_1} x_{i_2}^{r_2} \dots x_{i_k}^{r_k} x_{j_1}^{-s_1} \dots x_{j_2}^{-s_2} x_{j_1}^{-s_1}$$

with $r_i, s_i > 0$, $i_1 < i_2 \dots < i_k$ and $j_1 < j_2 \dots < j_l$. This normal form is unique if we further require that when both x_i and x_i^{-1} occur, so does x_{i+1} or x_{i+1}^{-1} , as discussed by Brown and Geoghegan [BG]. We will use the term *normal form* to mean this unique normal form.

Elements of F can be viewed combinatorially as pairs of finite binary rooted trees, each with the same number n of carets, called tree pair diagrams. We define a *caret* to be a vertex of the tree together with two downward oriented edges, which we refer to as the left and right edges of the caret. The *right (respectively left) child* of a caret c is defined to be a caret which is attached to the right (resp. left) edge of c . If a caret c does not have a right (resp. left) child, we call the right (resp. left) leaf of c *exposed*. Define the *level* of a caret inductively as follows. The root caret is defined to be at level 1, and the child of a level k caret has level $k + 1$, for $k \geq 1$.

We number the leaves of each tree from left to right from 0 through n , and number the carets in infix order from 1 through n . The infix ordering is carried out by numbering the left child of a caret c before numbering c , and the right child of c afterwards.

An element $g \in F$ is represented by an equivalence class of tree pair diagrams, among which there is a unique reduced tree pair diagram. We say that a pair of trees is *unreduced* if when the leaves are numbered from 0 through n , there is a caret in both trees with two exposed leaves bearing the same leaf numbers. We remove such pairs until no more exist, producing the unique *reduced* tree pair diagram representing g . See Figure 1 for an example of reduced and unreduced tree pair diagrams representing the same group element. The reduced tree pair diagrams for x_0 and x_n are given in Figure 2. When we write $g = (T, S)$, we are assuming that this is the unique reduced tree pair diagram representing $g \in G$.

The equivalence of these two interpretations of Thompson's group is given using the normal form for elements with respect to the standard infinite presentation, and the concept of leaf exponent. In a single tree T whose leaves are numbered from left to right beginning with 0, the *leaf exponent* $E(k)$ of leaf number k is defined to be the integral length of the longest path of left edges from leaf

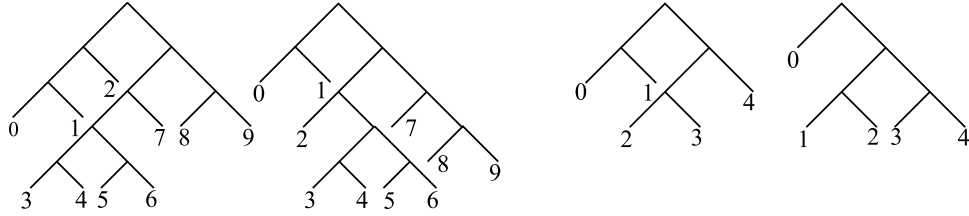

FIGURE 1. An example of an unreduced and then a reduced tree pair diagram representing the same group element.

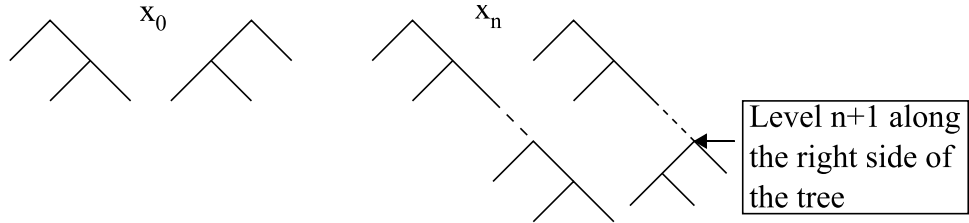

FIGURE 2. The reduced tree pair diagrams representing the generators x_0 and x_n of F .

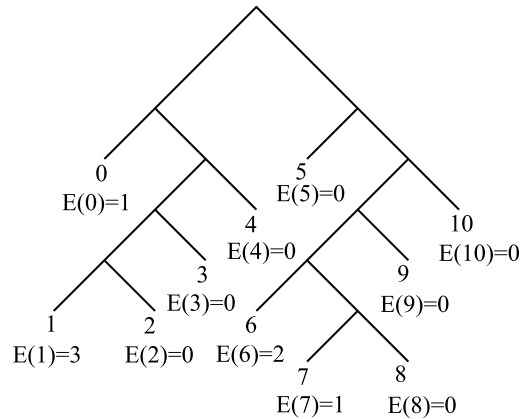

FIGURE 3. An example of a tree with leaf exponents computed.

k which does not reach the right side of the tree. Figure 3 gives an example of a tree whose leaf exponents are computed.

Given a reduced tree pair diagram (T, S) representing $g \in F$, compute the leaf exponents $E(k)$ for all leaves k in T , numbered 0 through n . The negative part of the normal form for g is then $x_n^{-E(n)} x_{n-1}^{-E(n-1)} \cdots x_1^{-E(1)} x_0^{-E(0)}$. We compute the exponents $E(k)$ for the leaves of the tree S and thus obtain the positive part of the normal form as $x_0^{E(0)} x_1^{E(1)} \cdots x_m^{E(m)}$. Many of these exponents will be 0, and after deleting these, we can index the remaining terms to correspond to the normal form given above, following [CFP]. As a result of this process, we often denote a tree pair diagram as (T_-, T_+) , since the first tree in the pair determines the terms in the normal form with negative exponents, and the second tree determines those terms with positive exponents. We refer to T_- as the negative tree in the pair, and T_+ as the positive tree.

Group multiplication is defined as follows when multiplying two elements represented by tree pair diagrams. Let $g = (T_-, T_+)$ and $h = (S_-, S_+)$. To form the product gh , we take unreduced

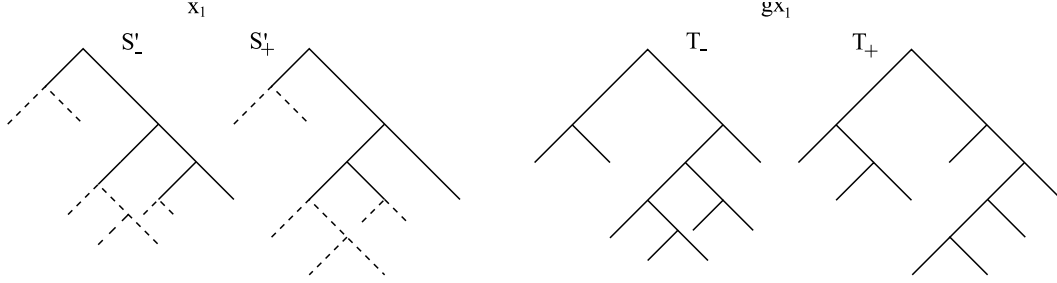

FIGURE 4. The group element $g = x_0x_1x_4^2x_5^{-1}x_3^{-1}x_2^{-2}x_0^{-1}$ is multiplied by the generator $x_1 = (S_-, S_+)$. An unreduced representative of x_1 is used to perform this multiplication. Dashed carets show the carets which are added to create this unreduced representative.

representatives of both elements, (T'_-, T'_+) and (S'_-, S'_+) , respectively, in which $S'_+ = T'_-$. The product is then represented by the (possibly unreduced) pair of trees (S'_-, T'_+) . An example of group multiplication, where $g = x_0x_1x_4^2x_5^{-1}x_3^{-1}x_2^{-2}x_0^{-1}$ is multiplied by the generator x_1 is given in Figure 4.

3. COMPUTING WORD LENGTH WITH RESPECT TO A CONSECUTIVE GENERATING SET

In this section, we describe a method for computing the word length of elements of F with respect to a *consecutive* generating set of the form $X_n = \{x_0, x_1, \dots, x_n\}$, which is a subset of the standard infinite presentation for F . In the case $n = 1$, there are three known formulae for computing word length, due to Fordham [F], Belk and Brown [BB] and Guba [G]. We end this section with a comparison of these methods, and show that they are all equivalent to our procedure when $n = 1$.

Below we present our method for computing word length, along with a detailed example. The proof that this method actually computes the word length of group elements follows the outline of Fordham's proof, and we apply a lemma from [F] as the main step in our proof. We then require two technical lemmas to show that the conditions in Fordham's lemma are fulfilled, and we defer the proofs of these lemmas to Sections 4 and 5 below.

Let T be a finite rooted binary tree with n carets, in which we number the carets from 1 through n in infix order. We use the infix numbers as names for the carets, and the statement $p < q$ for two carets p and q simply expresses the relationship between the infix numbers. A caret is said to be a right (resp. left) caret if one of its sides lies on the right (resp. left) side of T . The root caret can be considered either left or right. All other carets are called interior carets.

Our formula for the word length of elements $g \in F$ with respect to the generating set $X_n = \{x_0, x_1, \dots, x_n\}$ has two components. The first we call $l_\infty(g)$, as it is the word length of g with respect to the infinite generating set $\{x_i | i \geq 0\}$ for F . This quantity is simply the number of carets in the reduced tree pair diagram representing g which are not right carets. The difference between $l_\infty(g)$ and the word length $l_n(g)$ is measured by what we refer to as the *penalty* weight, denoted $p_n(g)$. Twice this penalty weight is the second component of our word length formula.

The intuition for this formula comes from the effect that multiplication by a generator has on a tree pair diagram (T_-, T_+) . One can view multiplication by each generator as performing a proscribed combinatorial rearrangement of the subtrees of T_- or T_+ . The rearrangement of these subtrees induced by multiplication by x_0 and x_2 is shown explicitly in Figure 5, and is analogous for multiplication by x_n with $n = 1$ or $n > 2$.

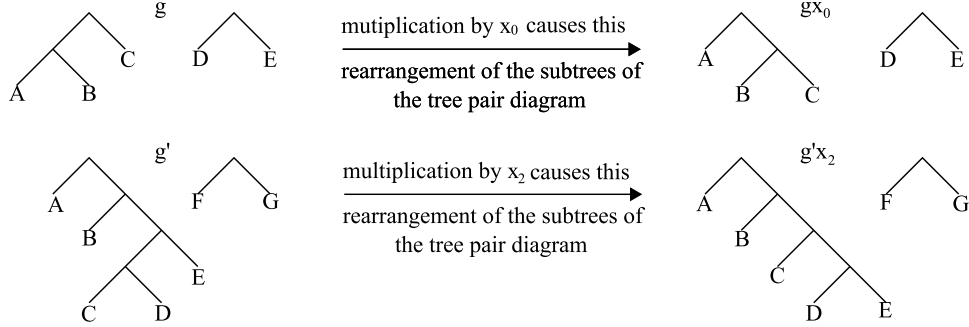

FIGURE 5. The combinatorial rearrangement of the subtrees of the tree pair diagrams representing elements g and g' of F induced by multiplication by x_0 and x_2 respectively. The letters A through G represent possibly empty subtrees of the tree pair diagram.

In creating a minimal length representative for $g \in F$, whose length is necessarily the word length of g , there are some arrangements of carets in T_- or T_+ which may be harder to produce using the combinatorial rearrangements available with the given generators. This incurs a “penalty” contribution to the length of the word. Determining this penalty contribution $p_n(g)$ to the word length lies at the heart of our method.

We begin by distinguishing a particular type of caret in a single tree. Caret types are central to the length formulae of Fordham [F] and Belk-Bux [BB]. While they require, respectively, seven and four caret types, we define a single one which is sufficient for our proofs below.

Definition 3.1. Caret p in a tree T has *type N* if caret $p + 1$ is an interior caret which lies in the right subtree of p .

We use this definition to describe certain carets in the tree pair diagram for $g \in F$ which we call *penalty carets* as they help determine the penalty contribution to the word length $l_n(g)$. Let $g \in F$ have a reduced tree pair diagram (T_-, T_+) in which the carets are numbered in infix order.

Definition 3.2. Caret p in a tree pair diagram (T_-, T_+) is a *penalty caret* if either

- (1) p has type N in either T_- or T_+ , or
- (2) p is a right caret in both T_- and T_+ and caret p is not the final caret in the tree pair diagram.

To compute the penalty contribution to the word length for a given $g = (T_-, T_+) \in F$ we use the following procedure, which will be made precise in Section 3.1. Using a notion of caret adjacency defined below, we take the two trees T_- and T_+ and construct a single tree \mathcal{P} , called a *penalty tree*, whose vertices correspond to a subset of the carets of T_- and T_+ , necessarily including the penalty carets. This tree is assigned a *weight* according to the arrangement of its vertices. Minimizing this weight over all possible penalty trees that can be constructed using the adjacencies between the carets of T_- and T_+ yields the penalty contribution $p_n(g)$ to the word length $l_n(g)$. We will prove the following theorem.

Theorem 3.3. For every $g \in F$, the word length of g with respect to the generating set $X_n = \{x_0, x_1, \dots, x_n\}$ is given by the formula

$$l_n(g) = l_\infty(g) + 2p_n(g)$$

where $l_\infty(g)$ is the number of carets in the reduced tree pair diagram for g which are not right carets, and $p_n(g)$ is the penalty weight.

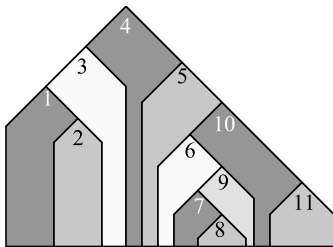

FIGURE 6. The spaces corresponding to the different carets are shaded. These spaces are used to define the notion of caret adjacency.

3.1. Constructing a penalty tree. Constructing penalty trees for $g \in F$ requires a concept of directed caret adjacency, which is an extension of the infix order. To define the concept of adjacency between carets in a tree T , we view each caret as a space rather than an inverted v. The point of intersection of the left and right edges of the caret naturally splits the boundary of this space into a left and right component. The space is bounded on the right (resp. left) by a *generalized right (resp. left) edge*. The generalized right (resp. left) edge may consist of actual left (resp. right) edges of other carets in the tree, in addition to the actual right (resp. left) edge of the caret itself. For example, in Figure 6, the spaces which we consider as carets are shaded, and the generalized left edge of caret 9 includes the right edges of carets 7 and 8.

Let p and q denote carets in a tree pair (T_-, T_+) , that is, p corresponds to a pair of carets, one in T_- and one in T_+ , each with infix number p , and the same is true for q . Additionally, assume $p < q$. We say that p is adjacent to q , written $p \prec q$, if there is a caret edge, in either T_- or T_+ , which is both part of the generalized right edge of caret p and the generalized left edge of caret q . We equivalently say that *traversing* the generalized left edge of caret q takes you to caret p in at least one tree. It is always true that carets p and $p + 1$ satisfy $p \prec p + 1$. Although the ordering of carets given by infix number is not symmetric but is transitive, the notion of caret adjacency is neither symmetric nor transitive.

We introduce a dummy caret denoted v_0 which is adjacent to all left carets in both T_- and T_+ . One can think of v_0 as being the space to the left of the left side of each tree. We now construct a penalty tree \mathcal{P} corresponding to the pair of trees (T_-, T_+) , which has this dummy caret v_0 as its root, according to the following rules.

- (1) The vertices of \mathcal{P} are a subset of the carets in the tree pair diagram, which we refer to by infix numbers: $0 = v_0, 1, 2, \dots, k$, always including v_0 .
- (2) A directed edge is drawn from vertex p to vertex q in \mathcal{P} if $p \prec q$.
- (3) There is a vertex for every penalty caret in (T_-, T_+) .
- (4) Each leaf of \mathcal{P} corresponds to a penalty caret of (T_-, T_+) . The only exception to this is when \mathcal{P} consists only of the root v_0 and no edges.

The penalty tree \mathcal{P} is oriented in the sense that there is a unique path from v_0 to every vertex $p \in \mathcal{P}$, and if this path passes through vertices $v_0, p_1, p_2, \dots, p_i = p$ then we must have $v_0 \prec p_1 \prec \dots \prec p_i = p$. Two vertices p, q in the tree are comparable if there is either a path $p = w_1, w_2, \dots, w_{i+1} = q$ or $q = w_1, w_2, \dots, w_{i+1} = p$ with $w_j \prec w_{j+1}, \forall j = 1, \dots, i = 1$, and in this case we say $d_{\mathcal{P}}(p, q) = i$.

When working with these penalty trees, we often abuse notation and refer to the edge between p and q as $p \prec q$, and conversely, will sometimes refer to an adjacency $p \prec q$ which exists in a tree pair diagram as an edge, meaning it can give rise to an edge in a penalty tree. Also, we call an edge $p \prec q$ both “an edge out of p ” and “an edge into q .”

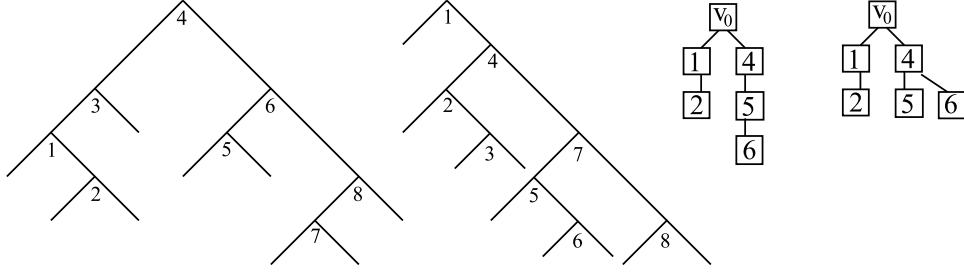

FIGURE 7. An example of two penalty trees associated to the same group element, whose carets are numbered in infix order from 1 through 8.

The penalty weight of a penalty tree is bounded above by the number of vertices on the tree, but not all vertices on the tree contribute to the weight. More precisely, we define:

Definition 3.4. The n -penalty weight $p_n(\mathcal{P})$ of a penalty tree \mathcal{P} associated to $g = (T_-, T_+) \in F$ is the number of vertices $v_i \in \mathcal{P}$ such that $d_{\mathcal{P}}(0, v_i) \geq 2$ and there exists a leaf l_i in \mathcal{P} with $d_{\mathcal{P}}(v_i, l_i) \geq n - 1$. These vertices are called the *weighted carets*.

To compute the penalty contribution $p_n(g)$ to the word length $l_n(g)$ for $g \in F$, we must minimize the penalty weight over all penalty trees associated to g .

Definition 3.5. For an element $g \in F$, define the penalty contribution $p_n(g)$ to the word length $l_n(g)$ by

$$p_n(g) = \min\{p_n(\mathcal{P}) \mid \mathcal{P} \text{ is a penalty tree for } g = (T_-, T_+)\}$$

This definition brings us to the statement of Theorem 3.3, which presents the formula $l_n(g) = l_{\infty}(g) + 2p_n(g)$. We call any penalty tree for g which realizes $p_n(g)$ a *minimal penalty tree*.

Computing the penalty contribution $p_n(g)$ for any $g = (T_-, T_+) \in F$ can be quite difficult, as there may be a large number of possible penalty trees based on the caret adjacencies present in T_- and T_+ . In Sections 6 and 7 we present families of group elements where the penalty trees with minimal penalty weight can be determined based on features of the original tree pair diagrams. One such feature which greatly simplifies the computation of p_n is recorded in the following observation.

Observation 3.6. Let $g \in F$ is represented by the reduced tree pair diagram (T_-, T_+) . If (T_-, T_+) contains two penalty carets $p \prec q$, where in both trees, p is a right caret which is not type N , then on any penalty tree \mathcal{P} for g , the unique path from v_0 to q must contain the caret p .

Observation 3.7. Observation 3.6 can be generalized as follows. If caret p does not have type N in either T_- or T_+ , then the only caret v with $p \prec v$ is $v = p + 1$.

The following lemma states that left carets in T_- and T_+ can never contribute to the penalty weight of a penalty tree.

Lemma 3.8. Let $w = (T_-, T_+)$ be an element of F , and p a caret which is a left caret in either T_- or T_+ . Then p is not a weighted caret in any minimal penalty tree for w .

Proof. Suppose that \mathcal{P} is a minimal penalty tree for w in which p is a vertex that carries weight. We construct a new minimal penalty tree \mathcal{P}' for w in which p is not a weighted caret. In \mathcal{P} , let c be the vertex which is the parent of p . Since p is weighted in \mathcal{P} , we know that c is not the root caret of \mathcal{P} .

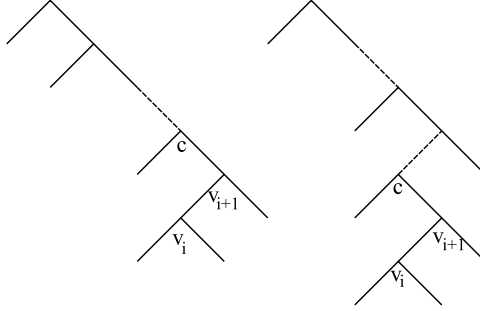

FIGURE 8. Two possible configurations of the carets c, v_i and v_{i+1} used to show that a penalty tree can always be constructed using only vertices corresponding to left and penalty carets in (T_-, T_+) when $n = 1$.

To construct \mathcal{P}' , begin with \mathcal{P} and remove the edge $c \prec p$. Attach vertex p , and its subtrees, to \mathcal{P}' via the adjacency $v_0 \prec p$ arising from the fact that p is a left caret in either T_- or T_+ . Thus we see that $p_n(\mathcal{P}') < p_n(\mathcal{P})$, since p is no longer a weighted caret in \mathcal{P}' . This contradicts the fact that \mathcal{P} was a minimal penalty tree for w , and the lemma follows. \square

We now address the question of whether a minimal penalty tree consists entirely of carets corresponding to left and penalty carets in the tree pair diagram for $g \in F$. We show directly that such a penalty tree can always be constructed when $n = 1$, and note that this fact follows from a result of Guba [G] discussed in Section 3.2 below. When $n > 1$, this need not be the case, as we illustrate with an example below.

Lemma 3.9. *In the case $n = 1$, a minimal penalty tree \mathcal{P} can always be constructed for $g = (T_-, T_+) \in F$ all of whose vertices correspond to left carets or penalty carets in the tree pair diagram.*

Proof. It follows from Lemma 3.8 that left carets in either tree can be assumed to be adjacent to v_0 in any minimal penalty tree. Let \mathcal{P} be a penalty tree for $w = (T_-, T_+) \in F$ in which all carets in \mathcal{P} which are left in either T_- or T_+ are adjacent to v_0 in \mathcal{P} , and suppose that \mathcal{P} contains a vertex v_i corresponding to a caret v_i in (T_-, T_+) which is neither a penalty caret nor a left caret. If v_i is a leaf in \mathcal{P} , simply delete it. If not, Observation 3.7 implies that the only caret v with $v_i \prec v$ is the caret immediately following caret v_i in the infix order. Call this caret $v_{i+1} = v_i + 1$. Note that v_{i+1} is not a left caret, since it is not connected by an edge in \mathcal{P} to v_0 . Since v_i is not a leaf of \mathcal{P} , it follows that the one and only edge out of v_i on \mathcal{P} is $v_i \prec v_{i+1}$. Delete both the edge $v_i \prec v_{i+1}$ and the vertex v_i from \mathcal{P} , and attach the vertex v_{i+1} and any subtree of \mathcal{P} having it as a root, as follows.

Since v_i in an interior caret with an exposed right leaf in at least one of T_- or T_+ , without loss of generality we assume this in T_- . It follows that the adjacencies determined by the actual (not generalized) left edges of v_i and v_{i+1} must connect them to a single caret c of type N . See Figure 8 for two possible configurations of these carets. We use the adjacency $c \prec v_{i+1}$ to reattach the subtree of \mathcal{P} whose root is v_{i+1} to the penalty tree. Thus we have created a new penalty tree which does not contain the vertex v_i . We can repeat this process until all non-penalty carets of (T_-, T_+) are removed from \mathcal{P} . Hence, $p_1(g)$ is simply the number of penalty carets in which neither caret in the pair is a left caret. \square

We conclude this section with two examples. The first contrasts the situations $n = 1$ and $n > 1$, and the second illustrates the computation of the word length $l_2(g)$ for a particular group element $g \in F$.

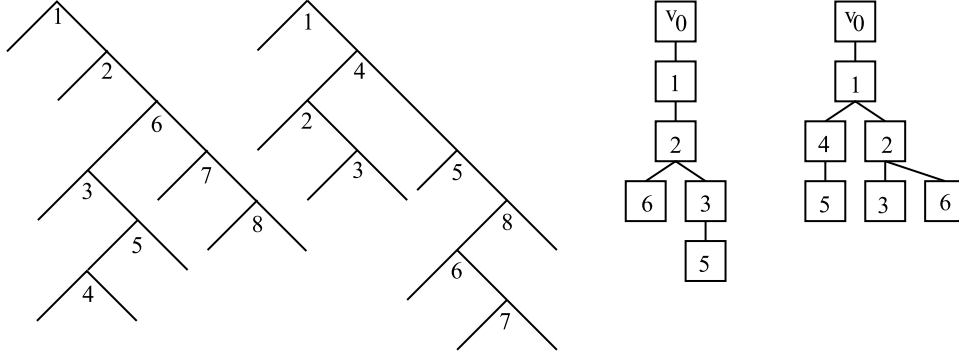

FIGURE 9. The element $g = x_1x_2x_5x_6x_3^{-2}x_2^{-1}$, along with two penalty trees: a non-minimal one which uses only penalty carets as vertices, and a minimal one which requires the addition of a vertex not corresponding to a penalty caret, both with respect to the generating set X_3 .

Example 3.10. We first present an example contrasting the cases $n = 1$ and $n > 1$. We proved above that when $n = 1$, a minimal penalty tree for $g \in F$ can always be constructed using only penalty carets and left carets. Although one can always construct a penalty tree for g consisting only of penalty and left carets, for $n \geq 2$ this tree may not be minimal. It may be the case that a penalty tree must include some non-penalty carets in order to realize $p_n(g)$. The following example illustrates this.

Consider $g = x_1x_2x_5x_6x_3^{-2}x_2^{-1}$ and the generating set $X_3 = \{x_0, x_1, x_2, x_3\}$. This element is depicted in Figure 9, and we see that $l_\infty(g) = 7$. Since g can be written as a word $x_3x_1x_2x_3^{-2}x_2^{-1}x_3$ of length seven, we must have $p_3(g) = 0$. We see that the carets with infix numbers 1, 2, 3, 5 and 6 are penalty carets in the tree pair diagram for g . It is possible to make a penalty tree for g using only these carets, but that tree will have penalty weight equal to one. In order to make a penalty tree with total weight zero, we must add caret 4 as a vertex. These two penalty trees are drawn in Figure 9.

Example 3.11. We now present an example in which we compute the word length of

$$g = x_0x_1^2x_4x_5^2x_8x_9^2x_{12}x_{13}^2x_{14}^{-1}x_{12}^{-2}x_{10}^{-1}x_8^{-2}x_6^{-1}x_4^{-2}x_2^{-1}x_0^{-2}$$

with respect to X_2 . The tree pair diagram for this element is given in Figure 10. We see that $l_\infty(g) = 24$, and begin the construction of a minimal penalty tree \mathcal{P} by identifying the penalty carets to be those numbered 1, 2, 4, 5, 6, 8, 9, 10, 12, 13, 14. We first note that any path of adjacencies connecting penalty carets with infix numbers greater than 8 with v_0 must include the vertex 8, as mentioned in Observation 3.6. This ensures that carets 8 and 12 will correspond to weighted penalty carets in any minimal penalty tree for g , and leads to the construction of the minimal penalty tree \mathcal{P} given in Figure 10. We see that $p_2(\mathcal{P}) = p_2(g) = 2$, and compute $l_2(g) = 28$.

3.2. Equivalence with known methods when $n = 1$. In the case $n = 1$, Fordham [F], Guba [G], and Belk and Brown [BB] have all provided formulas for $l_1(g)$. Our formula, restricted to the case $n = 1$, is seen below to be a streamlined version of these methods.

Guba [G] considers F as a diagram group, and elements of F are then infinite diagrams. The cells of a diagram correspond precisely to the carets in a tree pair diagram which are not right carets. Furthermore, his *special vertices* are precisely our penalty pairs in which neither caret is a left caret. Guba computes word length of an element to be the number of cells in the diagram plus twice the number of special vertices, corresponding exactly to our formula above.

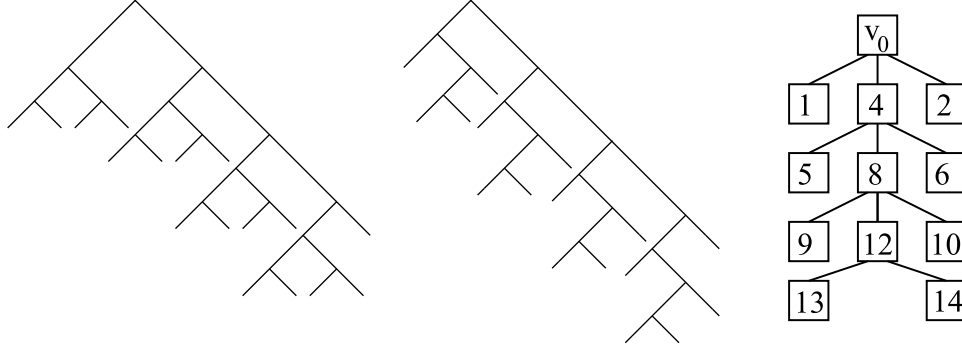

FIGURE 10. The element $g = x_0x_1^2x_4x_5^2x_8x_9^2x_{12}x_{13}^2x_{14}^{-1}x_{12}^{-2}x_{10}^{-1}x_8^{-2}x_6^{-1}x_4^{-2}x_2^{-1}x_0^{-2}$, along with a minimal penalty tree for g . With respect to X_2 , we compute $p_2(g) = 2$, as only carets 8 and 12 are weighted, and thus $l_n(g) = 28$.

It follows from Guba's length formula that we may always form a minimal penalty tree consisting only of penalty and left carets when $n = 1$, providing an alternate proof of Lemma 3.9. The example given above shows that this penalty tree may not be minimal when $n > 1$.

Now we compare our formula with the other two in the literature, due to Belk and Brown [BB] and Fordham [F], which are based on tables of weights corresponding to the different caret types. Encoded in each table is some of the information that we use when we tabulate $l_\infty(g)$ for $g \in F$.

Belk and Brown [BB] use forest diagrams for elements of F which, roughly, enumerate the right (resp. left) subtrees of the left (resp. right) carets in each tree, with a pointer to the root. They define four caret types, and their formula for the word length of $g \in F$ is $l_0(g) + l_1(g)$, where, translating from forest diagrams into binary trees, we see that $l_1(g)$ is simply the number of interior carets in the tree pair diagram. Then $l_0(g)$ is a sum of weights determined by the caret types with values 0, 1 or 2, which are presented in a table. The weights in the first row and column of their table count the number of left carets in the tree pair diagram distinct from the root caret, a count which we include as part of $l_\infty(g)$. The remainder of the table has a weight of two corresponding to each of our penalty carets in which neither caret is a left caret. Thus the two formulae are equivalent.

Blake Fordham [F] defines seven types of carets in a tree and forms the pairs of caret types analogous to Belk and Brown. He presents a six by six table of weights corresponding to the pairs of caret types. Altering Fordham's table in the following way:

- (1) subtract one from the weight of each pair of caret types containing a single caret which is not a right caret, and
- (2) subtract two from the weight of each pair or caret types containing no right carets,

one obtains a table that has a weight of two for each pair of caret types which we call a penalty pair, excluding those in which one caret type is left. Thus his entire table counts $l_\infty(g)$ and the penalty contribution $p_n(g)$ simultaneously.

3.3. Proof of Theorem 3.3. We rely on the following lemma of Fordham to prove Theorem 3.3. This lemma gives conditions under which a function defined from a group G to the nonnegative integers computes the word length of elements of the group.

Lemma 3.12 ([F], Lemma 3.1.1). *Given a group G , a generating set X , and a function $\phi : G \rightarrow \{0, 1, 2, \dots\}$, if ϕ has the properties*

- (1) $\phi(\text{Id}_G) = 0$;
- (2) if $\phi(g) = 0$ then $g = \text{Id}_G$;
- (3) if $g \in G$ and α or α^{-1} is any element of X , then $\phi(g) - 1 \leq \phi(g\alpha)$; and
- (4) for any non-identity element $g \in G$, there is at least one $\alpha \in G$ with either α or α^{-1} in X such that $\phi(g\alpha) = \phi(g) - 1$,

then $\phi(g) = l(g)$ for all $g \in G$, where $l(g)$ denotes the word length of g with respect to the generating set X .

We now prove Theorem 3.3 by showing that the function $\phi_n(g) = l_\infty(g) + 2p_n(g)$ for $g \in F$ satisfies the conditions of this lemma.

Proof. Define the function $\phi_n(g) = l_\infty(g) + 2p_n(g)$ for $g \in F$. We must show that this function satisfies all four conditions of Lemma 3.12. Since the identity is represented by a tree pair diagram consisting of a single caret in each tree, it is easy to see that both $l_\infty(\text{Id})$ and $p_n(\text{Id})$ equal zero, and thus the first condition is easily satisfied.

If $\phi_n(g) = 0$, in particular $l_\infty(g) = 0$, so g the tree pair diagram for g has no carets which are not right carets. Thus g is the identity in F .

We now state two lemmas which are slight variations on the last two conditions, and defer their proofs to the next two sections, as they are somewhat tedious.

Lemma 3.13. *For every $g \in F$ and $\alpha \in X_n$, $\phi_n(g\alpha) = \phi_n(g) \pm 1$.*

Lemma 3.14. *For every $g \in F$, there exists $\alpha \in X_n$ such that $\phi_n(g\alpha) = \phi_n(g) - 1$.*

Together with the fact that $\phi_n(g) = 0$ if and only if $g = \text{id}$, Lemma 3.13 implies that $\phi_n(g) \leq l_n(g)$ and Lemma 3.14 implies that $l_n(g) \leq \phi_n(g)$, and hence Theorem 3.3 follows. \square

The proofs of Lemmas 3.13 and 3.14 depend heavily on the combinatorial rearrangement of subtrees of a tree pair diagram caused by multiplication by a particular generator. This is illustrated in Figure 5. This figure shows how the subtrees of the original diagram are rearranged under multiplication by x_0 and x_2 . It may be necessary to add carets to the tree pair diagram to perform this multiplication. In general, multiplication by x_n performs the analogous rearrangement at level n along the right side of the first tree in the diagram.

Before proving Lemmas 3.13 and 3.14, we show that the change in l_∞ is easily computed when $g \in F$ is multiplied by a generator $\alpha = x_i^{\pm 1}$.

We first fix some notation. Let (T_-, T_+) be the reduced tree pair diagram for $g \in F$, and (S_-, S_+) the reduced tree pair diagram for a generator $\alpha = x_i^{\pm 1}$. The tree pair diagram for $g\alpha$ is formed by taking (possibly) unreduced representatives (T'_-, T'_+) of g and (S'_-, S'_+) of α in which in which $S'_+ = T'_-$. The (possibly unreduced) tree pair diagram for $g\alpha$ is then given by (S'_-, T'_+) . Careful examination reveals that this process results in three mutually exclusive situations, and in each case we can keep track of the difference between $l_\infty(g)$ and $l_\infty(g\alpha)$.

Observation 3.15. The multiplication described above results in exactly one of the following situations:

- (1) S_+ is not a subtree of T_- , so $T'_+ \neq T_+$. This implies that (S'_-, T'_+) must be a reduced tree pair diagram for $g\alpha$, and that $l_\infty(g\alpha) = l_\infty(g) + 1$.
- (2) S_+ is a subtree of T_- , so $T'_+ = T_+$, and (S'_-, T_+) is a reduced tree pair diagram for $g\alpha$. In this case, the change in l_∞ depends on α :

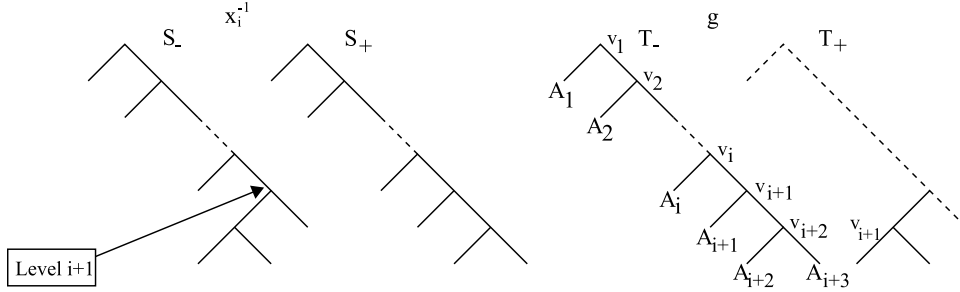

FIGURE 11. Multiplication of $g = (T_-, T_+)$ by $\alpha = x_i^{-1} = (S_-, S_+)$. We use dashed carets in T_+ to indicate that we do not know *a priori* the exact shape of this tree, except for the fact that v_{i+1} is an interior caret of the given form.

- (a) If $\alpha = x_i^{-1}$, then $l_\infty(g\alpha) = l_\infty(g) + 1$.
- (b) If $\alpha = x_i$, then $l_\infty(g\alpha) = l_\infty(g) - 1$.
- (3) S_+ is a subtree of T_- , so $T'_+ = T_+$, and (S'_-, T_+) is not a reduced tree pair diagram for $g\alpha$, then $l_\infty(g\alpha) = l_\infty(g) - 1$.

Since $l_\infty(g)$ is an important part of $\phi_n(g)$, the above observation will play a major role in the proof of Theorem 3.3.

4. PROOF OF LEMMA 3.13

We now prove Lemma 3.13, which states that multiplication by any generator in X_n or its inverse changes the value of $\phi_n(g)$ by either 1 or -1 . Recall that $g = (T_-, T_+)$.

Proof. First note that since $l_\infty(g\alpha)$ and $l_\infty(g)$ always differ by 1, we may assume without loss of generality that $l_\infty(g\alpha) = l_\infty(g) - 1$. To see why, assume that Lemma 3.13 holds whenever we have $l_\infty(g\alpha) = l_\infty(g) - 1$, and consider a pair g and α with $l_\infty(g\alpha) = l_\infty(g) + 1$. Set $h = g\alpha$ and $\beta = \alpha^{-1}$. Then $l_\infty(h\beta) = l_\infty(h) - 1$, so Lemma 3.13 holds for $h \in F$ and the generator β . Therefore, $\phi_n(g) = \phi_n(h\beta) = \phi_n(h) \pm 1 = \phi_n(g\alpha) \pm 1$, and thus $\phi_n(g\alpha) = \phi_n(g) \pm 1$.

Let $g \in F$ and $\alpha \in X_n$. Without loss of generality, we now assume that $l_\infty(g\alpha) = l_\infty(g) - 1$. It will suffice to prove that $p_n(g\alpha) = p_n(g)$ or $p_n(g) + 1$. We split the proof into two cases depending on the exponent of α .

Case 1: $\alpha = x_i^{-1}$. In the tree pair diagram (S_-, S_+) for α , the tree S_+ consists entirely of a string of $i + 2$ right carets. Notice that we must be in Case 3 of Observation 3.15, in which S_+ is a subtree of T_- . Thus T_- also has at least $i + 2$ right carets. In T_- , let $v_1 < v_2 < \dots < v_i < v_{i+1} < v_{i+2}$ be the infix numbers of the first $i + 2$ right carets, beginning with the root caret. As a separate subtree, this set of right carets has $i + 3$ leaves, each of which may have a subtree of T_- attached to it. Let A_j be the (possibly empty) subtree attached to the left leaf of caret v_j , for $1 \leq j \leq i + 2$. Let A_{i+3} be the (possibly empty) subtree attached to the right leaf of caret v_{i+2} . Note that multiplication by x_i^{-1} affects caret v_{i+1} , rotating it from the right side of the tree to the interior (or left in the case $i = 0$). See Figure 11 for a diagram of (S_-, S_+) and (T_-, T_+) .

Since we are in Case 3 of Observation 3.15, multiplication of (T_-, T_+) by $x_i^{-1} = (S_-, S_+)$ must create an interior caret which is removed when the pair (S'_-, T_+) is reduced. Thus we must have $A_{i+1} = A_{i+2} = \emptyset$, and that caret v_{i+1} is an exposed interior caret in T_+ . In addition, if A_{i+3} is also

empty in T_- , then v_{i+2} will also be removed when the product (S'_-, T_+) is reduced. Furthermore, if for some $1 \leq k \leq i$, the subtrees A_k, A_{k+1}, \dots, A_i of T_- are all empty, then carets v_k, v_{k+1}, \dots, v_i will also all be removed when the product (S'_-, T_+) is reduced.

This removal of carets may cause certain other carets to alter their penalty status, that is, penalty carets for g may not be penalty carets for $g\alpha$. If v_{i+1} is the only caret which is removed by the reduction, then caret v_i may change from being a penalty caret for g to not being a penalty caret for $g\alpha$. If more carets are removed during the reduction, say $v_k, v_{k+1}, \dots, v_{i+2}$ for $1 \leq k \leq i+1$, then caret v_{k-1} will switch from being a penalty caret in g to a non-penalty caret in $g\alpha$.

Suppose \mathcal{P} is any penalty tree for g . We claim that we can always create a new tree \mathcal{P}' which is a penalty tree for $g\alpha$ with $p_n(\mathcal{P}') \leq p_n(\mathcal{P})$, which would imply that $p_n(g\alpha) \leq p_n(g)$. There are two reasons that might prevent \mathcal{P} itself from being a penalty tree for $g\alpha$:

- \mathcal{P} may contain vertices corresponding to carets in the reduced tree pair diagram (T_-, T_+) for g which no longer appear in the reduced tree pair diagram for $g\alpha$, or
- there may be a leaf in \mathcal{P} corresponding to a penalty caret in (T_-, T_+) which is no longer a penalty caret in reduced tree pair diagram for $g\alpha$.

Let us first consider the case that only the caret v_{i+1} is removed when (S'_-, T_+) is reduced, and we describe how to alter \mathcal{P} to create \mathcal{P}' .

- (1) If v_{i+1} does not appear as a vertex in \mathcal{P} , and either v_i does not change penalty status as we go from g to $g\alpha$, or v_i does change penalty status, but is not a leaf in \mathcal{P} , let $\mathcal{P}' = \mathcal{P}$.
- (2) Suppose that v_{i+1} does not appear as a vertex of \mathcal{P} , v_i does change penalty status, and v_i is a leaf on \mathcal{P} . In this case we form \mathcal{P}' by simply removing the leaf v_i and the edge connecting it to the tree, as well as any newly exposed leaves which do not correspond to penalty carets.
- (3) Suppose that v_{i+1} does appear as a vertex of \mathcal{P} . We know that in $g = (T_-, T_+)$, caret v_{i+1} is not a penalty caret, since it is a right caret in T_- and an interior caret with no right subtree in T_+ . Thus it cannot be a leaf of \mathcal{P} , which forces \mathcal{P} to have vertices p and q with $p \prec v_{i+1} \prec q$ for some carets p and q . But since v_{i+1} is a right caret in T_- with both A_{i+1} and A_{i+2} empty, and v_{i+1} is an exposed caret T_+ , its generalized left and right edges are just the actual left and right edges, so there is only one such caret p and one caret q , and hence $p = v_i$ and $q = v_{i+2}$. Construct \mathcal{P}' by removing the vertex v_{i+1} from \mathcal{P} , and adding the edge $v_i \prec v_{i+2}$, since this adjacency exists in the reduced tree pair diagram corresponding to (S'_-, T_+) after caret v_{i+1} is removed. In this way, v_i is not a leaf of \mathcal{P}' so its penalty status, or any change therein, is irrelevant.

In each case above, it is clear that $p_n(\mathcal{P}') \leq p_n(\mathcal{P})$.

If more than one caret is removed when the tree pair diagram (S'_-, T_+) is reduced, say the string of carets $v_k, v_{k+1}, \dots, v_{i+2}$ for some $1 \leq k \leq i+1$, the situation is actually simpler. In this case carets v_{k-1}, v_k, \dots, v_i are all penalty carets for g , because they are right carets in both trees, and are not the final caret in the diagram. Thus they must appear as vertices of \mathcal{P} , and using Observation 3.6 one concludes that they must appear in \mathcal{P} as a path $v_{k-1} \prec v_k \prec \dots \prec v_i$, with the vertex v_i as the leaf.

In this case, we take \mathcal{P}' to be the tree \mathcal{P} with the string of vertices from v_{k-1} through v_i removed. It is possible that some leaf of this tree which is created by the removal of these vertices corresponds to a caret which is no longer a penalty caret for $g\alpha$. In this case, this leaf may be removed, and the resulting tree is a penalty tree for $g\alpha$. It is clear again that $p_n(\mathcal{P}') \leq p_n(\mathcal{P})$, which implies that $p_n(g\alpha) \leq p_n(g)$.

We now reverse the procedure outlined above to show that $p_n(g) \leq p_n(g\alpha)$; namely we begin with a penalty tree \mathcal{P}' for $g\alpha$ and describe how to alter it to obtain a penalty tree \mathcal{P} for g with $p_n(\mathcal{P}) \leq p_n(\mathcal{P}')$. One of three things may occur:

- (1) \mathcal{P}' may already be a penalty tree for g ,
- (2) if caret v_i changed penalty status between $g\alpha$ and g , it may need to be added as a vertex of the penalty tree, if it was not on \mathcal{P}' , or
- (3) if caret v_{k-1} changed penalty status between $g\alpha$ and g , for some k with $1 \leq k \leq i+1$, in which case the carets v_k, \dots, v_i were not present in the reduced tree pair diagram for $g\alpha$, the entire string of carets $v_{k-1} \prec v_k \prec \dots \prec v_i$ may need to be added to form a penalty tree for g .

Assume we are not in case (1), so we do need to add some of these carets to \mathcal{P}' . If we simply add the desired string of carets to \mathcal{P}' to form \mathcal{P} , we may increase the penalty quite a bit, but the vertices of the tree which contribute to this increase must lie on a path in \mathcal{P}' between v_0 and p , where p is the caret at the top of the newly added string. If any of these vertices do become weighted, we alter the tree again in such a way that the only vertices which are weighted in the new penalty tree but not weighted in \mathcal{P}' must now lie between v_0 and some other vertex q , where q is closer to v_0 than p was, and continue if necessary until there are no more vertices which might switch from being unweighted in \mathcal{P}' to being weighted in the altered tree \mathcal{P} .

More precisely, to construct \mathcal{P} , we will inductively construct a series of trees $\mathcal{P}' = \mathcal{P}_0, \mathcal{P}_1, \dots, \mathcal{P}_r$ associated with carets v_{j_1}, \dots, v_{j_r} , a certain subset of the carets $\{v_1, \dots, v_{k-2}$, where $j_r < j_{r-1} \dots < j_1$. For each $r \geq 1$, \mathcal{P}_r is a penalty tree for g , \mathcal{P}_r contains vertices corresponding to all carets v_k where $j_r \leq k \leq i$, and j_r is the largest index k with $k < j_{r-1}$ and v_k on \mathcal{P}_{r-1} . In addition, either:

- (1) $p_n(\mathcal{P}_r) \leq p_n(\mathcal{P}')$, or
- (2) $p_n(\mathcal{P}_r) > p_n(\mathcal{P}')$, $d_{\mathcal{P}_r}(v_0, v_{j_r}) = d_{\mathcal{P}'}(v_0, v_{j_r}) > j_r$, the reason that $p_n(\mathcal{P}_r)$ exceeds $p_n(\mathcal{P}')$ is that there are vertices along the path from v_0 to v_{j_r} in \mathcal{P}' which count towards $p_n(\mathcal{P}_r)$ but not towards $p_n(\mathcal{P}')$, and v_i is always the leaf at maximal distance from vertex v_{j_r} in \mathcal{P}_r .

In the first case we take $\mathcal{P} = \mathcal{P}_r$, and in the second case, we must construct \mathcal{P}_{r+1} . But since $0 < j_r \leq i$ and $j_{r+1} < j_r$, eventually case 1 above will occur, since $v_0 \in \mathcal{P}'$ and $d_{\mathcal{P}'}(v_0, v_0) = 0$. Hence, we can construct a penalty tree \mathcal{P} for g with $p_n(\mathcal{P}) \leq p_n(\mathcal{P}')$, which implies that $p_n(g) \leq p_n(g\alpha)$.

To complete the argument, we must show that the construction of penalty trees \mathcal{P}_r satisfying the properties above is possible. We first describe the construction of \mathcal{P}_1 . Let j_1 be the largest index j for which v_j appears on the penalty tree \mathcal{P}' . Then we can attach a string of $i - j_1$ vertices and edges corresponding to $v_{j_1} \prec \dots \prec v_i$ to \mathcal{P}' to form \mathcal{P}_1 , which is then a penalty tree for g . The added vertices themselves will never be weighted, since $i < n$, but it is possible that their addition might cause other unweighted vertices to become weighted. Either this does not occur, so $p_n(\mathcal{P}_1) \leq p_n(\mathcal{P}')$, or it does occur, so $p_n(\mathcal{P}_1) > p_n(\mathcal{P}')$, but this only happens if the distance in \mathcal{P}' between vertices v_0 and v_{j_1} satisfies $d_{\mathcal{P}'}(v_0, v_{j_1}) > j_1$. Moreover, it is only vertices along the path from v_0 to v_{j_1} which may be weighted in \mathcal{P}_1 but not in \mathcal{P}' . Furthermore, if there was a leaf of \mathcal{P}' further from v_{j_1} than v_i is, then appending the new path to v_i would not increase the total penalty.

For the inductive step, suppose the penalty tree \mathcal{P}_{r-1} has been constructed, and $p_n(\mathcal{P}_{r-1}) > p_n(\mathcal{P}')$. Furthermore, v_i is the leaf at maximal distance from $v_{j_{r-1}}$ in \mathcal{P}_{r-1} , and the reason that $p_n(\mathcal{P}_{r-1})$ exceeds $p_n(\mathcal{P}')$ is that there are vertices along the path from v_0 to $v_{j_{r-1}}$ in \mathcal{P}_{r-1} which are weighted in \mathcal{P}_{r-1} but not in \mathcal{P}' . Then we construct \mathcal{P}_r as follows. Choose j_r to be the largest index j with $0 \leq j < j_{r-1}$ so that v_j corresponds to a vertex of \mathcal{P}_{r-1} (or equivalently, of \mathcal{P}'). Delete the first edge along the path connecting $v_{j_{r-1}}$ to v_0 in \mathcal{P}_{r-1} , and attach to v_{j_r} the vertices and edges

corresponding to $v_{j_r} \prec \dots \prec v_{(j_{r-1})-1}$, and then add an edge connecting $v_{j_{r-1}-1}$ to $v_{j_{r-1}}$. The result, \mathcal{P}_{j_r} , is clearly an allowable tree for g . Since v_i was the most distant leaf from $v_{j_{r-1}}$ in \mathcal{P}_{r-1} , v_i is also the most distant leaf from $v_{j_{r-1}}, \dots, v_{j_r}$ in \mathcal{P}_r . Now in \mathcal{P}_{r-1} , only vertices between v_0 and $v_{j_{r-1}}$ may be weighted in \mathcal{P}_{r-1} but not in \mathcal{P}' , so deleting the edge connected to $v_{j_{r-1}}$ eliminates that difference in penalty. None of the vertices between v_{j_r} and $v_{j_{r-1}}$ are close enough to a leaf to count towards p_n , since they are too close to v_i , and v_i is the most distant leaf. Therefore, $p_n(\mathcal{P}_r) \leq p_n(\mathcal{P}')$ unless $d_{\mathcal{P}_{j_r}}(v_0, v_{j_r}) > j_r$, and then only vertices between v_0 and v_{j_r} can account for this increase in penalty. This completes the desired construction, and thus the proof that $p_n(g) \leq p_n(g\alpha)$.

Summing up, in this case where $\alpha = x_i^{-1}$, we have shown that $p_n(g\alpha) \leq p_n(g)$ and $p_n(g) \leq p_n(g\alpha)$, and hence $p_n(g) = p_n(g\alpha)$.

Case 2: $\alpha = x_i$. When $\alpha = x_i$ and we are assuming that $l_\infty(g\alpha) = l_\infty(g) - 1$, we must be in either Case 3 or Case 2b of Observation 3.15.

To obtain the tree pair diagram for $\alpha = x_i$, we switch the order of the trees given for $\alpha = x_i^{-1}$ in Figure 11. Thus S_- is a tree consisting of a string of $i + 2$ right carets, and S_+ has a single caret which is not a right caret: this caret is an interior caret if $i > 0$ and a left caret if $i = 0$.

Since we are not in case 1 of Observation 3.15, S_+ is a subtree of T_- . This guarantees an interior caret in T_- which is the left child of the right caret at level i from the root. As in Case 1, let $v_1 \prec v_2 \prec \dots \prec v_i \prec v_{i+2}$ be the first $i + 1$ right carets in T_- , and let v_{i+1} be the interior caret hanging from the left leaf of caret v_{i+2} . Number the leaves of the subtree consisting of the $\{v_i\}$ from 1 through $i + 3$, and let A_j be the (possibly empty) subtree attached to leaf j .

If we are in Case 2(b) of Observation 3.15 in which the pair (S'_-, T_+) is a reduced tree pair diagram, then there are two carets which may change penalty status, as opposed to one in Case 3 of Observation 3.15. In either case, the adjacency $v_i \prec v_{i+2}$ which is present in $g = (T_-, T_+)$ may not exist in the reduced tree pair diagram for $g\alpha$.

We claim first that $p_n(g\alpha) \leq p_n(g) + 1$, and begin our argument by choosing a penalty tree \mathcal{P} for g . Below we summarize the possible situations, which are not mutually exclusive, which might force us to alter \mathcal{P} to obtain a penalty tree \mathcal{P}' for $g\alpha$.

- (1) \mathcal{P} contains the edge corresponding to $v_i \prec v_{i+2}$, an adjacency present in g but not in $g\alpha$, and the tree pair diagram (S'_-, T_+) is reduced. (Case 2(b) of Observation 3.15.)
- (2) Caret v_{i+1} is not a penalty caret for g , but is for $g\alpha$, and the tree pair diagram (S'_-, T_+) is reduced. (Case 2(b) of Observation 3.15 and these conditions also require that $A_{i+2} = \emptyset, A_{i+3} \neq \emptyset$, and caret v_{i+1} is a right caret which is not type N in T_+ .)
- (3) There is a single caret which is a penalty caret for g , but no longer is one for $g\alpha$. This occurs as follows:
 - (a) In either Case 2b of Observation 3.15, or Case 3 of Observation 3.15 if exactly one caret is removed when (S'_-, T_+) is reduced, it may be the case that v_i is a penalty caret for g but not for $g\alpha$. This occurs if $A_{i+1} = \emptyset$ and v_i is a left or interior caret which is not type N in T_+ .
 - (b) In Case 3 of Observation 3.15, if carets $v_k, \dots, v_{i+1}, v_{i+2}$ are removed when (S'_-, T_+) is reduced, for some $0 \leq k \leq i + 1$, then v_{k-1} , if it exists, always changes from being a penalty caret for g to a non-penalty caret for $g\alpha$.

We describe a method for altering a penalty tree \mathcal{P} for g into a penalty tree for $g\alpha$ depending on which combination of the above situations occurs.

Suppose first that the first situation does occur. Then either v_{i+1} is a vertex on \mathcal{P} , or it is not. If v_{i+1} is already a vertex on \mathcal{P} , then we delete both the edge corresponding to $v_i \prec v_{i+2}$ as well as the edge along the path from v_0 to v_{i+1} which goes into v_{i+1} . We reconnect the tree by adding two edges corresponding to the adjacency $v_i \prec v_{i+1} \prec v_{i+2}$. The resulting tree \mathcal{P}' has vertices for all penalty carets for $g\alpha$.

We now claim that p_n can increase by at most 1, and show this by considering the distance from each vertex of the penalty tree to a leaf of the penalty tree. Recall that weighted carets, that is, those which count towards $p_n(\mathcal{P})$, are connected to the root of the tree by a path of length at least two, and a leaf of the tree by a path of length at least $n - 1$.

In altering \mathcal{P} in this way to obtain \mathcal{P}' , there are two carets which might become weighted penalty carets. First, it may be that v_{i+1} was not a weighted caret for \mathcal{P} but is weighted in \mathcal{P}' , since now all of the leaves which are connected by paths to v_{i+2} become leaves connected to v_{i+1} also. This can happen only if $d_{\mathcal{P}}(v_{i+2}, l) \geq n - 2$ where l is a leaf of \mathcal{P} at maximal distance from v_{i+2} . Second, it is possible that there is a vertex v along the path from v_0 to v_i in \mathcal{P} which is not far enough from a leaf of \mathcal{P} to be weighted, yet altering the tree by the addition of the edges $v_i \prec v_{i+1} \prec v_{i+2}$ may now make this caret weighted. But this can happen only if both $d_{\mathcal{P}}(v_0, v) \geq 2$ and a leaf l of \mathcal{P} which has maximal distance from v_{i+2} has $d_{\mathcal{P}}(v, l) = n - 2$. But this implies that $d_{\mathcal{P}}(v_{i+2}, l) \leq n - 3$. Since these conditions are mutually exclusive, we see that at most one of them can occur, so $p_n(\mathcal{P}') \leq p_n(\mathcal{P}) + 1$.

If, on the other hand, caret v_{i+1} does not correspond to a vertex of \mathcal{P} , the situation is simpler. Simply delete the edge $v_i \prec v_{i+2}$, and add a new vertex labeled v_{i+1} along with the edges $v_i \prec v_{i+1} \prec v_{i+2}$. Again, remove leaves as necessary until all remaining leaves correspond to penalty carets of the tree pair diagram for $g\alpha$. The resulting penalty tree \mathcal{P}' for $g\alpha$ again satisfies $p_n(\mathcal{P}') \leq p_n(\mathcal{P}) + 1$.

Now if situation (2) also occurs, no additional alteration of the penalty tree \mathcal{P}' is required, since v_{i+1} is already on it. Although situation (3a) may also occur, since v_i is not a leaf of \mathcal{P}' , it does not concern us that it may no longer be a penalty caret. However it is possible that some leaves of \mathcal{P}' may no longer correspond to penalty carets in the reduced tree pair diagram for $g\alpha$, since we may have created a new leaf when we removed edges of \mathcal{P} . Then we simply remove non-penalty leaves from \mathcal{P}' until all leaves do correspond to penalty carets. This can never increase $p_n(\mathcal{P}')$. Thus, \mathcal{P}' is a penalty tree for $g\alpha$ with $p_n(\mathcal{P}') \leq p_n(\mathcal{P}) + 1$.

Now suppose that situation (1) above does not occur, but situation (2) does. This implies that we are once again in Case 2(b) of Observation 3.15, and hence the adjacency $v_i \prec v_{i+2}$ is not present in T_+ , which implies that $v_i \prec v_{i+2}$ no longer holds for $g\alpha$. Therefore, since we assumed that situation (1) does not occur, the edge $v_i \prec v_{i+2}$ does not occur in \mathcal{P} . However, since $A_{i+3} \neq \emptyset$, it follows that v_{i+2} is a penalty caret for g , and hence must appear on \mathcal{P} . However, the facts that $A_{i+2} = \emptyset$ and v_{i+1} is a right caret in T_+ which is not type N imply that the only two carets v with $v \prec v_{i+2}$ in g are v_i and v_{i+1} . Since situation (1) does not occur, the edge $v_{i+1} \prec v_{i+2}$ is forced to exist in \mathcal{P} , so caret v_{i+1} , though not a penalty caret for g , was nonetheless already on \mathcal{P} . Now if situation (3a) occurs, and v_i is a leaf of \mathcal{P} , simply delete it. Continue to delete any non-penalty leaves from \mathcal{P} to form a penalty tree \mathcal{P}' for $g\alpha$ with $p_n(\mathcal{P}') \leq p_n(\mathcal{P})$.

Finally, suppose that neither situations 1 nor 2 occur, but situation 3 does. We must then be either in Case 2(b) or Case 3 of Observation 3.15. First we consider what happens if we are in case 2(b) of Observation 3.15. Then the only reason \mathcal{P} might not be a penalty tree for $g\alpha$ is that caret v_i corresponds to a leaf of \mathcal{P} , but v_i is not a penalty caret for $g\alpha$. In this case, to form \mathcal{P}' , we delete the vertex corresponding to v_i as well as any additional leaves which no longer correspond to penalty carets in $g\alpha$. The resulting tree satisfies $p_n(\mathcal{P}') \leq p_n(\mathcal{P})$.

If we are in Case 3 of Observation 3.15, then some carets are removed when the tree pair diagram (S'_-, T_+) for $g\alpha$ is reduced. If these carets appear in \mathcal{P} , we must delete them when forming \mathcal{P}' . Once again, Observation 3.6 reveals that these carets, if they appear in \mathcal{P} , appear as a string $v_k \prec \dots \prec v_i$ of vertices, with v_i as a leaf of the tree, and no other edges on the tree out of any of these vertices. Thus they can be easily deleted, along with the vertex corresponding to caret v_{k-2} if necessary, to produce a penalty tree \mathcal{P}' for $g\alpha$ with $p_n(\mathcal{P}') \leq p_n(\mathcal{P})$.

Thus in all of these situations, we can always construct a penalty tree \mathcal{P}' for $g\alpha$ with $p_n(\mathcal{P}') \leq p_n(\mathcal{P})$, and it follows that $p_n(g\alpha) \leq p_n(g) + 1$.

We now prove that if we begin with a penalty tree \mathcal{P}' for $g\alpha$, we can always alter it to construct a penalty tree \mathcal{P} for g with $p_n(\mathcal{P}) \leq p_n(\mathcal{P}')$. If we are in Case 3 of Observation 3.15, we must add vertices corresponding to the carets v_k, v_{k+1}, \dots, v_i to \mathcal{P}' to form \mathcal{P} . We do this using the same inductive procedure used in Case 1 of the proof of this lemma.

If we are in case 2(b) of Observation 3.15, there are two possible situations to consider.

- (1) Caret v_{i+1} is a penalty caret for $g\alpha$, but not for g . This happens if $A_{i+2} = \emptyset$, caret v_{i+1} is a right caret in T_+ which is not type N , and $A_{i+3} \neq \emptyset$.
- (2) Caret v_i is not a penalty caret for $g\alpha$, but is a penalty caret for g . This occurs if $A_{i+1} = \emptyset$ and v_i is a left or interior caret in T_+ which is not type N .

If the second situation above does not occur, or it does but v_i corresponds to a vertex already on \mathcal{P}' , then constructing \mathcal{P} from \mathcal{P}' requires only deleting any leaves which no longer correspond to penalty carets in g . This process cannot increase the penalty weight of the tree. If the second situation does occur, and v_i does not correspond to a vertex of \mathcal{P}' , we again use the inductive procedure from the first case of the proof of this lemma to construct the desired penalty tree \mathcal{P} for g containing a vertex corresponding to v_i . Hence, $p_n(g) \leq p_n(g\alpha)$, which in turn implies that in this case, either $p_n(g\alpha) = p_n(g)$ or $p_n(g\alpha) = p_n(g) + 1$, as desired. \square

5. PROOF OF LEMMA 3.14

Before embarking on the proof itself, we gather together a few cases in which $\phi_n(g\alpha) = \phi_n(g) - 1$. We will show that any $g \in F$ falls into at least one of these situations for some choice of α . As usual, we let (T_-, T_+) be the reduced tree pair diagram for g , and let $v_1 \prec v_2 \prec v_3 \prec \dots \prec v_j$ be all of the right carets in T_- , and we let A_k be the (possibly empty) subtree attached to the left leaf of v_k for $1 \leq k \leq j$. All of these observations essentially follow from the proof of Lemma 3.13, and we supply details following the statements below.

Observation 5.1. For $0 \leq i \leq n$, if $l_\infty(gx_i^{-1}) = l_\infty(g) - 1$, then $\phi_n(gx_i^{-1}) = \phi_n(g) - 1$. This occurs precisely when T_- contains at least $i + 2$ right carets, $A_{i+1} = A_{i+2} = \emptyset$ in T_- , and caret v_{i+1} is exposed in T_+ .

Observation 5.2. For $0 \leq i \leq n$, if T_- contains at least $i + 2$ right carets and $A_{i+1} \neq \emptyset$, and there is a minimal penalty tree \mathcal{P} for g not containing $v_i \prec v_{i+1}$, then $\phi_n(gx_i) = \phi_n(g) - 1$.

Observation 5.3. If there is a minimal penalty tree \mathcal{P} for g in which the caret v_2 is a weighted caret, then $\phi_n(gx_0^{-1}) = \phi_n(g) - 1$.

The first two observations follow directly from the proof of Lemma 3.13. Observation 5.1 falls into case 1 of the proof of Lemma 3.13, and notice that in this case we actually proved that $p_n(g) = p_n(gx_i^{-1})$, which implies $\phi_n(gx_i^{-1}) = \phi_n(g) - 1$. Now for Observation 5.2, since the generator $\alpha = x_i$, we look to case 2 of the proof. But the fact that there is a penalty tree \mathcal{P} for

g not containing the edge $v_i \prec v_{i+1}$ corresponds to Situation 1 of the proof not occurring (Note that the caret labeling is not the same as in the proof). As long as situation 1 does not occur, $p_n(g) = p_n(gx_i)$.

Observation 5.3 can be established by a similar type of argument. Note that the situation in Observation 5.3 is distinct from the case $i = 0$ in Observation 5.1, for if v_1 were exposed in T_+ and $A_1 = A_2 = \emptyset$ in T_- , then v_2 must be a left caret in T_+ , and thus is not a weighted penalty caret. Hence, in the situation of Observation 5.3, $l_\infty(gx_0^{-1}) = l_\infty(g) + 1$. Given a minimal penalty tree \mathcal{P} for g in which v_2 is weighted, we can construct a caret tree \mathcal{P}' for gx_0^{-1} by replacing the edge into v_2 by the edge $v_0 \prec v_2$. In \mathcal{P}' , v_2 is not weighted, and so $p_n(\mathcal{P}') \leq p_n(\mathcal{P}) - 1$, and hence $p_n(gx_0^{-1}) \leq p_n(g) - 1$. This implies that $\phi_n(gx_0^{-1}) = \phi_n(g) - 1$.

Proof of Lemma 3.14. Let $g \in F$ be represented by the reduced tree pair diagram (T_-, T_+) . As usual, we let $v_1 \prec v_2 \prec \dots \prec v_j$ be the right carets in T_- , and let A_k be the (possibly empty) subtree attached to the left leaf of v_k for $1 \leq k \leq j$. We proceed by analyzing two cases based on the number of right carets in T_- and the infix numbers of the penalty carets.

Case 1: Either T_- has at most $n + 1$ right carets, or T_- has more than $n + 1$ right carets, caret v_{n+1} is not a penalty caret and there are no penalty carets above v_{n+1} in the infix ordering.

First, if T_- consists entirely of right carets, then T_+ must have an exposed caret v_k where $k \neq j$, or else the tree pair diagram would not be reduced. But we claim $1 \leq k \leq n + 1$, for if v_k is exposed in T_+ for $k > n + 1$, then v_{k-1} would be a penalty caret with $k - 1 \geq n + 1$, contradicting the conditions of this case. But then $\phi_n(gx_{k-1}^{-1}) = \phi_n(g) - 1$ by Observation 5.1.

If T_- has some carets which are not right, let i be the greatest index such that $A_i \neq \emptyset$. So $i \leq n + 1$, since neither v_{n+1} nor caret beyond it are penalty carets. Now v_{i-1} is type N in T_- , but v_i, v_{i+1}, \dots, v_j are all right carets which are not type N . Hence, in T_+ , one of v_i, \dots, v_j must not be a right caret, else the tree pair diagram is not reduced. If there is some penalty caret at or beyond v_i , then it must either be of type N or a right caret in T_+ , and hence one of v_i, \dots, v_j must have type N in T_+ . Let v_k be the highest (in infix order) type N caret in T_+ ; since there are no penalty carets at or beyond v_{n+1} , $i \leq k \leq n$. Then this implies that caret v_{k+1} is an exposed caret in T_+ , and $i + 1 \leq k + 1 \leq n + 1$, which implies by Observation 5.1 that x_{k+1}^{-1} reduces ϕ_n . If, on the other hand, there are no penalty carets at or beyond v_i , then $v_{i-1} \prec v_i$ is not on any caret tree for g , so by Observation 5.2, x_{i-1} reduces ϕ_n .

Case 2: T_- has at least $n + 2$ right carets and there are penalty carets at or above v_{n+1} in the infix ordering.

In this case, if for some $0 \leq i \leq n$, $A_{i+1} \neq \emptyset$ and there is a minimal penalty tree \mathcal{P} for g not containing the edge $v_i \prec v_{i+1}$, then by Observation 5.2, $\phi(gx_i) = \phi(g) - 1$. Furthermore, if v_2 is weighted in some minimal penalty tree \mathcal{P} for g , then by Observation 5.3, $\phi_n(gx_0^{-1}) = \phi_n(g) - 1$.

So, we may assume that for every minimal penalty tree \mathcal{P} for g , v_2 is not a weighted caret and for each $0 \leq k \leq n$ such that $A_{k+1} \neq \emptyset$, \mathcal{P} contains the edge $v_k \prec v_{k+1}$. We split into subcases; in each subcase we will show that Observation 5.1 applies for some i .

Subcase 2.1: v_2 is a left caret in T_+ .

In this subcase, Observation 5.1 applies with $i = 0$. To see this, first note that $A_2 = \emptyset$, for if not, then every minimal penalty tree for g must contain the edge $v_1 \prec v_2$. The proof of Lemma 3.8 implies that we can always construct a minimal penalty tree for g which contains the edge $v_0 \prec v_2$ and does not contain the edge $v_1 \prec v_2$. Therefore $A_2 = \emptyset$, and hence v_1 and v_2 are consecutive

caret with v_2 a left caret in T_+ . So in T_+ , v_1 is not a caret of type N or a right caret, and recall that in T_- , caret v_1 is not of type N , so v_1 is not a penalty caret. Furthermore, $v_1 \prec v_2$ is the only edge out of v_1 . But this implies that $A_1 = \emptyset$, for if not, then by assumption all minimal trees \mathcal{P} realizing $p_n(g)$ contain the edge $v_0 \prec v_1$. Given such a \mathcal{P} , v_1 cannot be a leaf since it is not a penalty caret, so \mathcal{P} also must contain $v_1 \prec v_2$. Then alter \mathcal{P} by removing v_1 along with both edges $v_0 \prec v_1$ and $v_1 \prec v_2$, and adding the edge $v_0 \prec v_2$, obtaining a penalty tree \mathcal{P}' not containing $v_0 \prec v_1$ with $p_n(\mathcal{P}') \leq p_n(\mathcal{P})$. So $A_1 = A_2 = \emptyset$, v_1 must be a left caret in T_+ , and Observation 5.1 applies with $i = 0$ to show that $\phi_n(gx_0^{-1}) = \phi_n(g) - 1$.

Subcase 2.2: v_2 is not left in T_+ , and $v_2 \notin \mathcal{P}$ for some minimal penalty tree \mathcal{P} for g .

In this subcase, Observation 5.1 applies with $i = 1$. To see this, first note that $v_2 \notin \mathcal{P}$ which implies that $v_1 \prec v_2 \notin \mathcal{P}$ and hence that $A_2 = \emptyset$. Also, $v_2 \notin \mathcal{P}$ implies that v_2 is not a penalty caret, which implies that v_2 cannot have type N in T_- , and hence $A_3 = \emptyset$.

Moreover, since v_2 is not a penalty caret, it follows that v_2 is an interior caret in T_+ which is not of type N . This implies that v_1 is either of type N in T_+ or is an interior caret which is not of type N . We claim that v_1 must be of type N . Suppose v_1 is interior, but not of type N . It follows that $A_1 \neq \emptyset$, which implies by our assumption that \mathcal{P} contains the edge $v_0 \prec v_1$. We know that v_1 is not a penalty caret because it is not type N in either tree, and is an interior caret in T_+ . Thus v_1 is not a leaf of \mathcal{P} , so there must be some edge out of v_1 in \mathcal{P} . The only possible edge out of v_1 is $v_1 \prec v_2$, which means $v_2 \in \mathcal{P}$, a contradiction. Therefore v_1 has type N in T_+ , which in turn implies that v_2 is exposed in T_+ , and so by observation 5.1, $\phi_n(gx_1^{-1}) = \phi_n(g) - 1$.

Subcase 2.3: v_2 is not a left caret in T_+ , and for every minimal penalty tree \mathcal{P} for g , $v_2 \in \mathcal{P}$ but v_2 is not weighted.

Choose a minimal penalty tree \mathcal{P} for g . Since v_2 is neither a left caret nor weighted, it follows that $d_{\mathcal{P}}(v_2, l) < n - 1$ for all leaves l of \mathcal{P} . Now note that if all edges $v_k \prec v_{k+1}$ for $2 \leq k \leq n$ are on \mathcal{P} , then $d_{\mathcal{P}}(v_2, v_{n+1}) = n - 1$, so v_2 would be at least distance $n - 1$ from some leaf of \mathcal{P} . So let i be the smallest index such that $v_i \prec v_{i+1}$ is not on \mathcal{P} . Hence, $A_{i+1} = \emptyset$, for otherwise $v_i \prec v_{i+1}$ would be on \mathcal{P} by the conditions of Case (2). Note that $A_{i+1} = \emptyset$ means that the carets v_i and v_{i+1} are consecutive in infix order.

Since $v_{i-1} \prec v_i$ is on \mathcal{P} , $v_i \in \mathcal{P}$. We claim that v_i must have type N in T_+ , otherwise $v_i \prec v_{i+1}$ is the only possible edge out of v_i , so v_i is a leaf of \mathcal{P} . But then v_i must be a penalty caret, so must be a right caret in T_+ . Since there must be some penalty caret v beyond v_i , and v_i is a right caret in both trees, by Observation 3.6, the path in \mathcal{P} connecting v to v_0 must pass through v_i , contradicting the fact that v_i is a leaf of \mathcal{P} . So v_i has type N in T_+ , which implies that $v_i \prec v_{i+1}$ is the only possible edge into v_{i+1} , so $v_{i+1} \notin \mathcal{P}$, so v_{i+1} is not a penalty caret, and thus must be an interior caret in T_+ which is not of type N , hence exposed in T_+ . Also, since v_{i+1} is not a penalty caret, it cannot have type N in T_- , and hence $A_{i+2} = \emptyset$. So, by observation 5.1, $\phi_n(gx_i^{-1}) = \phi_n(g) - 1$. \square

6. (F, X_n) IS NOT ALMOST CONVEX

A finitely generated group G is *almost convex*(k), or $AC(k)$ with respect to a finite generating set X if there is a constant $L(k)$ satisfying the following property. For every positive integer n , any two elements x and y in the ball of radius n with $d_X(x, y) \leq k$ can be connected by a path of length $L(k)$ which lies completely within this ball. Cannon, who introduced this property in [C], proved that if a group G is $AC(2)$ with respect to a generating set X then it is also $AC(k)$ for all $k \geq 2$ with respect to that generating set. Thus if a group is $AC(2)$, it is called *almost convex* with

respect to that generating set. If a group is almost convex with respect to *any* generating set, then we simply call it almost convex, omitting the mention of a generating set.

There are interesting examples of families of groups with and without this property. Groups which are almost convex with respect to any generating set include hyperbolic groups [C] and fundamental groups of closed 3-manifolds whose geometry is not modeled on *Sol* [SS]. Moreover, amalgamated products of almost convex groups retain this property [C]. Groups which are not almost convex include fundamental groups of closed 3-manifolds whose geometry is modeled on *Sol* [CFGT] and the solvable Baumslag-Solitar groups $BS(1, n)$ [MS].

Almost convexity is a property which depends on generating set; this was proven by Thiel using the generalized Heisenberg groups [T]. Cleary and Taback prove in [CT1] that Thompson's group F is not almost convex with respect to the standard generating set $X_1 = \{x_0, x_1\}$, but this has no implications for the convexity of the group with respect to other generating sets. Below we prove that F is not almost convex with respect to any consecutive generating set $X_n = \{x_0, x_1, \dots, x_n\}$. The proof below follows the outline of [CT1].

Theorem 6.1. *Thompson's group F is not almost convex with respect to the generating set $X_n = \{x_0, x_1, \dots, x_n\}$.*

We begin with an overview of the proof of the theorem. Assume that (F, X_n) is almost convex, and construct particular group elements gx_n and gx_n^{-1} so that $l_n(g) = l_n(gx_n) + 1 = l_n(gx_n^{-1}) + 1 = k + 1$. Almost convexity guarantees a short path γ from gx_n to gx_n^{-1} which lies completely within the ball of radius k . Label the right caret at level $n + 1$ in the reduced tree pair diagram for g by r_{n+1} . Let γ_i for $0 \leq i \leq k$ denote the prefix of γ of length i . In the tree pair diagram for $gx_n\gamma_i$, caret r_{n+1} will change type and level as i increases. The salient point is that in gx_n the caret r_{n+1} is the right caret at level $n + 2$, and in gx_n^{-1} it is an interior caret of level $n + 2$, which is the left child of the right caret at level $n + 1$. Thus there is a point along γ where the caret with label r_{n+1} is again the right caret at level $n + 1$. Suppose this happens when the prefix γ_m is applied to gx_n . To prove the theorem, we show that $gx_n\gamma_m \notin B(k)$, contradicting the assumption of almost convexity.

Proof. Suppose that (F, X_n) is almost convex. Then there is a constant L so that elements $x, y \in B(k)$ with $d_{X_n}(x, y) = 2$ can be connected by a path of length at most L which is contained in $B(k)$.

We now construct a group element g by giving a reduced tree pair diagram (T_-, T_+) , so that the elements $gx_n^{\pm 1}$ yield a counterexample to this assumption.

Constructing T_- . Let $r_1 \prec \dots \prec r_{2n+1} \prec r_{2n+2}$ be the right carets of T_- , where r_1 is the root caret. These carets form a subtree with $2n + 2$ leaves; let A_i be the subtree of T_- whose root is attached to the left leaf of caret r_i . For $i \leq n + 1$, we take A_i to be the complete tree with $L + 1$ levels. When $n + 2 \leq i \leq 2n + 2$, A_i will be empty.

Constructing T_+ . The root caret of T_+ will be the caret immediately preceding r_{n+1} in infix order. The right carets of the right subtree of this caret will be $r_{n+1} \prec r_{n+2} \prec \dots \prec r_{2n-1} \prec r_{2n} \prec r_{2n+2}$, with the left subtree of r_j empty for $n + 1 \leq j \leq 2n$, and the left subtree of r_{2n+2} consisting of the single caret r_{2n+1} . The caret r_{2n+1} is added as an interior caret to ensure that the pair of trees is reduced. All carets before r_{n+1} in infix order will be left carets in this tree, except for the caret with infix number two, which will be an interior caret, again simply to ensure that the tree pair diagram is reduced.

Figure 12 gives an example of a group element which is of this form.

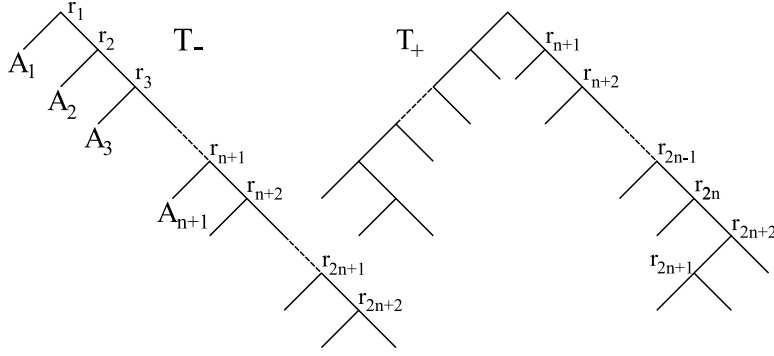

FIGURE 12. An example of a group element g constructed so that $gx_n^{\pm 1}$ will contradict the assumption of almost convexity.

We first prove a lemma which shows that both x_n and x_n^{-1} decrease the word length of g . We then use gx_n and gx_n^{-1} as the two elements which will contradict the assumption of almost convexity.

Lemma 6.2. *Let $g = (T_-, T_+)$ be defined as above. Then $l_n(gx_n) = l_n(gx_n^{-1}) = l_n(g) - 1$.*

Proof. We show that multiplication by both x_n and x_n^{-1} decrease the word length of the element g constructed above.

Case 1. Multiplication by x_n^{-1} . Multiplication by x_n^{-1} creates a pair of trees $(\tilde{T}_-, \tilde{T}_+)$ in which the caret r_{n+1} is now an interior caret in \tilde{T}_- , and $\tilde{T}_+ = T_+$. Thus $l_\infty(gx_n^{-1}) = l_\infty(g) + 1$.

We will show that any penalty tree for g can be altered to yield a penalty tree for gx_n^{-1} with one fewer weighted caret. First we observe that all penalty carets in the reduced tree pair diagram for gx_n^{-1} were also penalty carets for g . The only two possible differences in the reduced tree pair diagrams for g and gx_n^{-1} which might influence the construction of penalty trees are:

- (1) the caret r_{n+1} is a right caret in both T_- and T_+ , but in \tilde{T}_- it becomes an interior caret which is not of type N , hence is no longer a penalty caret in gx_n^{-1} , and
- (2) the adjacency $r_n \prec r_{n+2}$, not present for g , is present in gx_n^{-1} .

Since r_{2n} is a penalty caret for g , by Observation 3.6, the string of edges $r_{n+1} \prec \cdots \prec r_{2n}$ must appear in every penalty tree for g , and r_{n+1} is not a left caret in either T_- or T_+ . Hence r_{n+1} is a weighted caret in every penalty tree for g . Furthermore, since r_{n+1} and r_{n+2} are consecutive carets in the infix order, no other carets other than the r_i carets in the string above are connected to the root of the penalty tree by a path passing through r_{n+1} . Let \mathcal{P} be any penalty tree for g . Since caret r_n is a left caret in T_+ , we may assume, by the proof of Lemma 3.8, that if r_n is a vertex of \mathcal{P} , then the edge $v_0 \prec r_n$ also appears on \mathcal{P} . We construct a penalty tree \mathcal{P}' for gx_n^{-1} as follows: delete the edge $r_{n+1} \prec r_{n+2}$ from \mathcal{P} . This leaves the caret r_{n+1} as a leaf of \mathcal{P}' , so we simply remove it, as it is not a penalty caret in gx_n^{-1} . Now if r_n did appear on \mathcal{P} , connect r_{n+2} via the edge $r_n \prec r_{n+2}$. If not, add the two edges $v_0 \prec r_n \prec r_{n+2}$. In either case, the number of weighted carets in the subtree whose root is r_{n+1} does not increase, and even if we added the caret r_n to \mathcal{P} , it is not weighted. Thus caret r_{n+1} , which was a weighted penalty caret in \mathcal{P} , is not even present in \mathcal{P}' . Hence, $p_n(\mathcal{P}') \leq p_n(\mathcal{P}) - 1$, so applying this argument to a minimal penalty tree for g yields $p_n(gx_n^{-1}) = p_n(g) - 1$, and we conclude that $l_n(gx_n^{-1}) = l_n(g) - 1$.

Case 2. Multiplication by x_n . Let c be the caret which is the left child of caret r_{n+1} in T_- , that is, the root of the subtree A_{n+1} . Then multiplication by x_n produces a pair (T'_-, T'_+) in which

c is now the right caret at level $n + 1$ in T'_- , and r_{n+1} is the right caret at level $n + 2$ in T'_- . Since an interior caret has been changed to a right caret, $l_\infty(gx_n) = l_\infty(g) - 1$. Caret r_{n+1} , however, has not changed type: it is of type N in both T_- and \tilde{T}_- , and a left caret which is not of type N in both T_+ and \tilde{T}_+ . The only other change is that the adjacency $r_n \prec r_{n+1}$ in T_- no longer exists in T'_- , and hence is not available for constructing a minimal penalty tree. We will show that any penalty tree for g may be altered to construct a penalty tree for gx_n with no additional weighted penalty carets.

Let \mathcal{P} be any penalty tree for g . Let c_{root} be the root caret of T_+ . As before, since c_{root} is a left caret in T_+ , we may assume that either c_{root} does not appear on \mathcal{P} , or if it does, so does the edge $v_0 \prec c_{root}$. If the edge $r_n \prec r_{n+1}$ is not present in \mathcal{P} , then $\mathcal{P}' = \mathcal{P}$ is a penalty tree for gx_n . If the edge $r_{n-1} \prec r_n$ is present in \mathcal{P} , we construct \mathcal{P}' as follows. Delete the edge $r_n \prec r_{n+1}$ in \mathcal{P} . If c_{root} was on \mathcal{P} , it appears on the edge $v_0 \prec c_{root}$, and we add the edge $c_{root} \prec r_{n+1}$. If c_{root} was not on \mathcal{P} , add it together with the two edges $v_0 \prec c_{root} \prec r_{n+1}$ to form \mathcal{P}' . Thus the vertices r_n and r_{n+1} are present in both \mathcal{P} and \mathcal{P}' . It follows from the construction of \mathcal{P}' that $p_n(\mathcal{P}') \leq p_n(\mathcal{P})$, and hence $p_n(gx_n) = p_n(g)$. Thus $l_n(gx_n) = l_n(g) - 1$ and the lemma follows. \square

It follows from the assumption that (G, X_n) is almost convex that there is a path γ of length at most L from gx_n to gx_n^{-1} which is completely contained in the ball of radius k , where $k = l_n(g) - 1$. We view γ as a product $\alpha_1\alpha_2 \cdots \alpha_L$ where each $\alpha \in \{x_0^{\pm 1}, x_1^{\pm 1}, \dots, x_n^{\pm 1}, Id\}$, and consider the prefixes $gx_n\gamma_i = gx_n\alpha_1\alpha_2 \cdots \alpha_i$.

We first consider the effect of multiplication by x_n and x_n^{-1} on the caret r_{n+1} in the initial word $g = (T_-, T_+)$. This caret, in T_- , is a right caret at level $n + 1$. After multiplication by x_n , we obtain $gx_n = (T'_-, T'_+)$, and now caret r_{n+1} is a right caret in T'_- at level $n + 2$. After multiplication by x_n^{-1} , we obtain $gx_n^{-1} = (\tilde{T}_-, \tilde{T}_+)$, and this caret is an interior caret in \tilde{T}_- which is the left child of the right caret at level $n + 1$.

In each prefix $gx_n\gamma_i = gx_n\alpha_1\alpha_2 \cdots \alpha_i$ we note the position of the caret with label r_{n+1} . The generators in the set X_n and their inverses perform combinatorial rearrangements of the subtrees of the tree pair diagram representing $gx_n\gamma_i$ at levels one through $n + 1$ along the right side of the negative tree in the pair. Thus, there is a first point along the path γ at which caret r_{n+1} is again the right caret at level $n + 1$. Denote this prefix of γ by β , which has length j where $1 \leq j \leq L$. Denote the prefixes of β by β_i , where $1 \leq i \leq j$.

We note that because of the choice of g , multiplication of $gx_n\beta_i$ by α_{i+1} never requires the addition of carets to the tree pair diagram for $gx_n\beta_i$, and as a result, the positive tree is always unchanged by this multiplication. Additionally, after this multiplication is performed, no cancelation is necessary to obtain the reduced tree pair diagram. The only exposed carets in T_+ are in the second and the penultimate carets, and these carets are not exposed in T_- , nor can they ever become exposed along β . This means that the number of carets in the tree pair diagrams for $gx_n\beta_i$ remains constant for $i = 1, 2 \cdots, j$.

For each prefix β_i of β , we consider the tree pair diagram for $g_i = gx_n\beta_i$. As the values of i increase, the position of caret r_{n+1} moves up and down the right side of the negative tree at levels at least $n + 1$, and is unchanged in the positive tree. If the next generator in the path β is of the form x_j , then the level of r_n in the negative tree increases by one. If the next generator in the path β is x_j^{-1} , then the level of r_n in the negative tree decreases by one. In either case, the position of this caret in the positive tree is unchanged. Since the level of caret r_{n+1} must have a net decrease of 1, the path β necessarily consists of $m + 1$ generators with negative exponents and m generators with positive exponents.

To prove this theorem, we show that generators of the form x_j^{-1} as part of the path β always increase the word length. Thus the word length $l_n(gx_n\beta)$ satisfies the following inequality:

$$l_n(gx_n\beta) \geq l_n(gx_n) + (m+1) - m = k+1 > k.$$

It follows from this inequality that the element $gx_n\beta$ does not lie in the ball of radius k , contradicting the assumption of almost convexity.

Since multiplication by x_j^{-1} will always move a right caret to an interior or left caret, and carets are never added in order to complete multiplication along the path β , multiplication of $gx_n\beta_i$ by x_j^{-1} will always yield $l_\infty(gx_n\beta_{i+1}) = l_\infty(gx_n\beta_i) + 1$.

We now show that the penalty contribution to the word length is unchanged when $gx_n\beta_i$ is multiplied by x_j^{-1} . Each such multiplication changes a right caret into an interior caret, and also disrupts some adjacency, which might affect the penalty tree. However, we note two salient points:

- (1) The caret which is shifted from right to interior by this multiplication always precedes caret r_{n+1} in infix order, and any such caret can be connected to the right side of the negative tree for $gx_n\beta_i$ by a path of at most length L . Thus such a caret is a left caret in T_+ as well as in the positive tree in the reduced pair representing $gx_n\beta_i$.
- (2) It follows from Lemma 3.8 that this caret is never a weighted penalty caret in any minimal penalty tree for $gx_n\beta_i$, for any i .

Thus when $gx_n\beta_i$ is multiplied by x_j^{-1} to obtain $gx_n\beta_{i+1}$, we must have $p_n(gx_n\beta_i) = p_n(gx_n\beta_{i+1})$. Combining this with the fact that $l_\infty(gx_n\beta_{i+1}) = l_\infty(gx_n\beta_i) + 1$ implies that $l_n(gx_n\beta_{i+1}) = l_n(gx_n\beta_i) + 1$, which proves the theorem. \square

7. DEPTH OF POCKETS IN (F, X_n)

Let G be a finitely generated group with a finite generating set S . We say that $w \in G$, with $|w|_S = n$, is a k -pocket if $B_w(k) \subset B_{Id}(n)$, taking the maximal k for which this is true. Thus any path from w in the Cayley graph $\Gamma(G, S)$ of length at most k remains in the ball of radius n centered at the identity, and there is some path of length $k+1$ emanating from w which leaves this ball. The integer k is called the *depth* of the pocket.

We say that a group G has *deep pockets* with respect to a finite generating set S if there is no bound on the depth of group elements. Bogopol'ski proved in [B] that hyperbolic groups have finite depth, that is, there is a uniform upper bound on the depth of all pockets, with respect to every generating set. There are many examples of finitely-generated infinite groups with deep pockets: the lamplighter groups $\mathbb{Z}_n \wr \mathbb{Z} = \langle a, t | t^n, [a, a^{t^i}], i \in \mathbb{Z} \rangle$ with respect to the generating set $\{a, t\}$ were the first examples of such groups [CT3], and a finitely presented example of such a group is given in [CR]. Warshall, in [W], proves that the discrete Heisenberg group $\langle x, y | [x, [x, y]], [y, [x, y]] \rangle$ has deep pockets with respect to any finite generating set. Riley and Warshall in [RW] prove that the property of having deep pockets does depend on the choice of generating set.

We show below that for any $k \in \mathbb{Z}^+$, Thompson's group F has a generating set $X_n = \{x_0, x_1, \dots, x_n\}$ which yields pockets of depth at least k , as long as $n \geq 2k+2$. Since $2k+2$ is always greater than one, this does not contradict the result in [CT1] stating that (F, X_1) has only pockets of depth two. The theorem below is really of interest for large values of k . It is proved by example; for a given k we construct a family of pockets whose depth is at least k with respect to X_n . In [CT1], an exhaustive description is given of all pockets with respect to X_1 , which are necessarily of depth two. We do not give such a description below with respect to X_n .

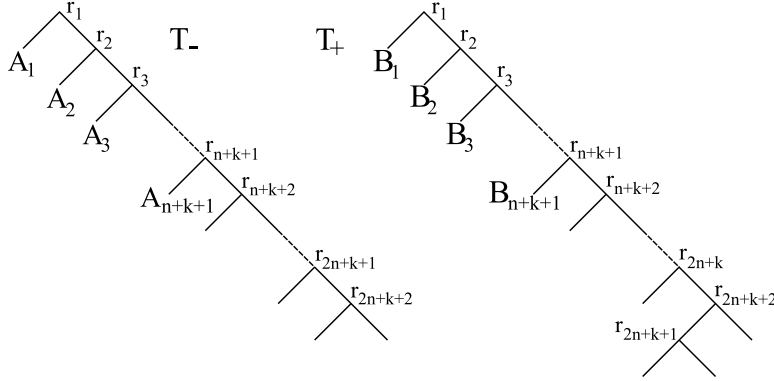

FIGURE 13. An example of a group element which will be a pocket of depth at least k .

In addition, we give upper bounds on pocket depth in each of these generating sets. We show that for fixed a n , there are no pockets of depth greater than or equal to the maximum of $4n - 3$ and $2n + 1$. Note that for $n \geq 2$ we have $4n - 3 \geq 2n + 1$, so it is only for the case $n = 1$ that the upper bound on pocket depth is $2n + 1 = 3$, and in this $n = 1$ case, there are in fact pockets of depth 2.

Theorem 7.1. *For any $k \geq 1$, Thompson's group F has pockets of depth at least k with respect to the generating set $X_n = \{x_0, x_1, \dots, x_n\}$, for $n \geq 2k + 2$.*

Proof. We construct a group element $g = g_k = (T_-, T_+)$ for each $k \in \mathbb{Z}^+$ which is a pocket of depth at least k with respect to the generating set X_n , for $n \geq 2k + 2$ by describing the trees T_- and T_+ . We assume that the carets of these trees are numbered in infix order.

- (1) Let $r_1 \prec \dots \prec r_{2n+k+2}$ be the right carets of T_- . Let A_i be the left subtree of r_i ; we choose A_i to be the complete tree with $k + 1$ levels for $1 \leq i \leq n + k + 1$. For $i > n + k + 1$, A_i is empty.
- (2) The right carets of T_+ are $r_1 \prec \dots \prec r_{2n+k} \prec r_{2n+k+2}$, but caret r_{2n+k+1} is the left child of caret r_{2n+k+2} , an interior caret. Denote the left subtree of caret r_i by B_i , and as in T_- , B_i is empty for $n + k + 1 < i \leq 2n + k$. For $1 \leq i \leq n + k + 1$, as an independent tree, B_i consists of a string of right carets, one fewer in number than the number of carets in A_i , with a penultimate interior caret. This additional caret ensures that the tree pair diagram will be reduced.

Figure 13 gives an example of a group element of the above form.

Let $\beta = \alpha_1 \alpha_2 \dots \alpha_k$ be any word with $\alpha_i \in X_n$ or $\alpha_i^{-1} \in X_n$ for all i , and denote the prefixes of β by $\beta_i = \alpha_1 \alpha_2 \dots \alpha_i$. The original word g was constructed so that the following are always true:

- (1) The original tree pair diagram (T_-, T_+) is reduced.
- (2) For each i , multiplication of $g\beta_i$ by α_{i+1} can be accomplished without adding additional carets to the tree pair diagram, and the resulting tree pair diagram for each $g\beta_i$ is always reduced. Thus the number of carets in the reduced tree pair diagram for $g\beta_i$ remains constant for $i = 1, 2, \dots, k$.
- (3) In the tree pair diagram for $g\beta_i$, the positive tree in the pair is always T_+ , the same positive tree as in the initial word g . Let $g\beta_i$ be represented by the reduced tree pair diagram (T_i, T_+) .

- (4) The only carets that can be affected when $g\beta_i$ is multiplied by α_{i+1} are penalty carets. Moreover, these carets remain penalty carets when the multiplication is completed, since they have type N in T_+ , and the tree T_+ is unchanged by the multiplication.
- (5) The subtree of T_i with root caret r_{n+k+2} remains unchanged for each $g\beta_i$, and always hangs from the right leaf of caret r_{n+k+1} . All carets in this subtree but the final two are penalty carets, and necessarily form a string of length $n-1$ which hangs from vertex r_{n+k+1} in any penalty tree for $g\beta_i$, as described in Observation 3.6.

To prove Theorem 7.1, we will show that $l_n(g\beta_i) \leq l_n(g)$ for all $1 \leq i \leq k$. We will describe the change in l_∞ between g and $g\beta_i$, and bound the change in penalty contribution between these two elements as well.

First note that a minimal penalty tree for g is easily constructed by joining each penalty caret to v_0 by choosing the shortest adjacency path in the single tree T_- . Namely, connect each caret to the caret adjacent to it via its honest, not generalized, left edge. We call this path the *greedy path* from a caret to v_0 . It follows that the only penalty carets which are weighted in this minimal penalty tree are r_2, \dots, r_{n+k+1} , yielding $p_n(g) = n + k$.

We begin with a lemma bounding the length of the greedy paths from any caret to v_0 . This lemma is easily proved by induction.

Lemma 7.2. *Let T be any nonempty subtree of the complete tree on m levels. Then the maximum length of the greedy path from any caret to v_0 is m .*

When considering possible penalty trees for $g\beta_i = (T_i, T_+)$, we again must consider those carets on the right side the tree T_i . Let M_i denote the number of carets r_j , for $1 \leq j \leq 2n + k + 2$, which were right carets in (T_-, T_+) but are no longer right carets in T_i , and N_i the number of right carets in T_i which are not amongst the carets numbered r_j for $1 \leq j \leq 2n + k + 2$. Observe that $l_\infty(g\beta_i) = l_\infty(g) + M_i - N_i$.

We give an upper bound for $p_n(g\beta_i)$ in order to control $l_n(g\beta_i)$ by constructing a penalty tree for $g\beta_i$ which is not necessarily minimal but will give the estimate necessary to prove Theorem 7.1. We do this in two cases, depending on the sign of $M_i - N_i$.

Case 1: $M_i - N_i > 0$. Construct a penalty tree \mathcal{P}_i for $g\beta_i$ once again by choosing the greedy paths in the tree T_i . The right carets of T_i are $c_1 \prec c_1 \prec c_2 \prec \dots \prec c_l \prec r_{n+k+1} \prec r_{n+k+2} \prec \dots \prec r_{2n+k+2}$ where some subset of the first l right carets are equal to r_j for values of j between 1 and $n+k$. These adjacencies alone yield a subtree where each vertex, other than the initial and final vertices, has valence two. For each j , the left subtree of c_j in the tree T_i is a subtree of the complete tree with $k+i+1$ levels, where $i \leq k$. It follows from Lemma 7.2 that the greedy path from a caret in the left subtree of c_j to c_{j-1} has length at most $k+i+1$, where $k+i+1 \leq 2k+1 \leq n-1$. Therefore we see that none of the carets in the left subtrees of the c_i correspond to weighted penalty carets in \mathcal{P}_i . Thus $p_n(\mathcal{P}_i) = n + k - M_i + N_i = p_n(g) - M_i + N_i$, and the difference in penalty contribution to the word length between g and $g\beta_i$ is bounded as follows:

$$p_n(g\beta_i) - p_n(g) \leq N_i - M_i.$$

Recall from above that $l_\infty(g\beta_i) = l_\infty(g) + M_i - N_i$, and combine these estimates to bound the difference in word length:

$$\begin{aligned}
l_n(g\beta_i) - l_n(g) &= (l_\infty(g\beta_i) - l_\infty(g)) + 2(p_n(g\beta_i) - p_n(g)) \\
&= (M_i - N_i) + 2(p_n(g\beta_i) - p_n(g)) \\
&\leq (M_i - N_i) + 2(N_i - M_i) \\
&= N_i - M_i \\
&< 0
\end{aligned}$$

It follows that when $M_i - N_i > 0$, we have $l_n(g\beta_i) < l_n(g)$.

Case 2: $M_i - N_i \leq 0$. Unlike Case 1, we now build a penalty tree \mathcal{P}_i using first the adjacencies $r_j \prec r_{j+1}$ present in T_+ for $1 \leq j \leq 2n + k$, attaching r_1 to the dummy caret v_0 . This again yields a tree where each vertex other than the final and initial ones has valence two.

We now attach vertices to \mathcal{P}_i representing the other penalty carets of T_i , those not amongst the carets r_j for $1 \leq j \leq 2n + k$. For each such caret p , we use the adjacencies along the greedy path in T_i from p to v_0 . We take the longest subpath of the greedy path containing p but none of the r_j carets, and attach vertices and edges corresponding to these adjacencies to \mathcal{P}_i , joining this path to the existing tree at the next caret along the path, which is necessarily either v_0 or r_j for some $1 \leq j \leq 2n + k$. We claim that the distance between p and that r_j caret is at most $2k + 1 \leq n - 1$. This will imply that none of these other carets p will be weighted carets in \mathcal{P}_i . To see why the claim is true, note that if caret p is a right caret in T_i , then the distance along the greedy path to the next r_j caret is at most $i \leq k$. If p is not a right caret, then it is in the left subtree of a right caret p' of T_i . The caret p' is the right child of a caret q , where q is either a right caret of T_i or the dummy caret v_0 , and the greedy path from p to v_0 passes through q . If the distance from q to the next r_j caret along that greedy path is $m \leq i \leq k$, then the left subtree of p' is a subtree of a complete tree with $k + (i - m) + 1$ levels. It follows from Lemma 7.2 that the greedy path from p to q has length at most $k + (i - m) + 1$. Hence, the greedy path from p to an r_j caret has length at most $k + (i - m) + m + 1 = k + i + 1 \leq 2k + 1$, establishing the claim. Therefore, $p_n(\mathcal{P}_i) = p_n(\mathcal{P})$, and hence $p_n(g\beta_i) \leq p_n(g)$.

We bound the difference in word length between g and $g\beta_i$ as above, again using the fact that $l_\infty(g\beta_i) = l_\infty(g) + M_i - N_i$.

$$\begin{aligned}
l_n(g\beta_i) - l_n(g) &= (l_\infty(g\beta_i) - l_\infty(g)) + 2(p_n(g\beta_i) - p_n(g)) \\
&= (M_i - N_i) + 2(p_n(g\beta_i) - p_n(g)) \\
&\leq (M_i - N_i) + 0 \\
&= M_i - N_i \\
&\leq 0
\end{aligned}$$

This shows that g is a pocket of depth at least k and completes the proof of the theorem. \square

Finally, we establish an upper bound on pocket depth.

Theorem 7.3. *For $n \geq 1$, F has no pockets of depth k with respect to X_n , if $k \geq \text{Max}\{4n - 3, 2n + 1\}$.*

Proof. We will show that for every $g \in F$, at least one of $l_n(gx_i)$, for $0 \leq i \leq 2n$, or $l_n(g\alpha)$, where $\alpha = x_{2n-1}^{-1}x_{2n-2}^{-1} \cdots x_2^{-1}x_1^{-1}$ is greater than $l_n(g)$. Since $l_n(x_i) \leq l_n(x_{2n}) = 2n + 1$ for $0 \leq i \leq 2n$, and $l_n(\alpha) = 4n - 3$, this proves the theorem.

Let $g \in F$ be represented by the reduced pair diagram (T_-, T_+) , and let $r_1 \prec r_2 \prec \dots \prec r_l$ be the right carets of T_- , and let A_i be the left subtree of r_i for $1 \leq i \leq l$. First observe that, for $1 \leq i \leq 2n$, if $l < i + 1$ or if both $l \geq i + 1$ and $A_{i+1} = \emptyset$, then $l_n(gx_i) > l_n(g)$. Thus we need only consider the case that $l \geq 2n + 1$ and $A_1, A_2, \dots, A_{2n+1}$ are all not empty.

Assume that we are in this case; we will show below that it follows that $l_n(g\alpha) > l_n(g)$. Note that in this case, the reduced tree pair diagram for $g\alpha$ is (T_α, T_+) . In T_α , carets r_i for $2 \leq i \leq 2n$ are all interior, whereas they were right carets in T_- , so $l_\infty(g\alpha) = l_\infty(g) + 2n - 1$. To compare penalty weight between g and $g\alpha$, notice that all of the r_i carets which are interior in T_α are type N , so they remain penalty carets for $g\alpha$. The only change is in the caret adjacencies; the adjacencies $r_i \prec r_{2n+1}$, for $2 \leq i \leq 2n - 1$ are present in T_α , but not in T_- . We claim that $p_n(g) \leq p_n(g\alpha) + n - 1$.

To prove this claim, suppose \mathcal{P} is a minimal penalty tree for $g\alpha$. We will construct a penalty tree \mathcal{P}' for g as follows. If \mathcal{P} contains no edges of the form $r_i \prec r_{2n+1}$, for $2 \leq i \leq 2n - 1$, then $\mathcal{P}' = \mathcal{P}$ is a penalty tree for g , so $p_n(g) \leq p_n(g\alpha)$. If \mathcal{P} does contain one such edge, it contains only one, say $r_i \prec r_{2n+1}$. Then alter \mathcal{P} to form \mathcal{P}' by deleting the edge, and inserting the edge $r_{2n} \prec r_{2n+1}$, noting that r_{2n} was already a vertex on \mathcal{P} , since it has type N in T_α . Then \mathcal{P}' is a penalty tree for g . It is possible that $p_n(\mathcal{P}') > p_n(\mathcal{P})$, but this possible increase can only be caused by carets along the path from v_0 to r_{2n} which were not weighted in \mathcal{P} but become weighted in \mathcal{P}' . However, there can be at most $n - 1$ of these, so $p_n(\mathcal{P}') \leq p_n(\mathcal{P}) + n - 1$, and therefore $p_n(g) \leq p_n(g\alpha) + n - 1$. Thus we obtain the necessary inequality:

$$\begin{aligned} l_n(g\alpha) &= (l_\infty(g\alpha) + 2p_n(g\alpha)) \\ &\geq l_\infty(g) + (2n - 1) + 2(p_n(g) - n + 1) \\ &= l_n(g) + (2n - 1) + 2(1 - n) \\ &= l_n(g) + 1 \end{aligned}$$

which proves the theorem. □

REFERENCES

- [BB] J.M. Belk and K.S. Brown, *Forest diagrams for Thompson's group F*, Internat. J. Algebra Comput. **15**(2005), no. 5-6, 815-850.
- [B] O.V. Bogopol'skiĭ, *Infinite commensurable hyperbolic groups are bi-Lipshitz equivalent*. Algebra and Logic **36** (1997), no. 3., 155-163.
- [BG] K.S. Brown and R. Geoghegan, *An infinite-dimensional torsion-free FP_∞ group*, Invent. Math. **77** (1984), 367-381.
- [C] J. Cannon, *Almost convex groups*, Geom. Dedicata **22**(1987), 197-210.
- [CFG] J. Cannon, W. Floyd, M. Grayson, and W. Thurston, *Solvgroups are not almost convex*, Geom. Dedicata **31**(1989), 291-300.
- [CFP] J.W. Cannon, W.J. Floyd, and W.R. Parry, *Introductory notes on Richard Thompson's groups*, Enseign. Math. **42**(1996), 215-256.
- [CR] S. Cleary and T.R. Riley, *A finitely presented group with unbounded dead end depth*, Proc. Amer. Math. Soc. **134**(2006), no.2., 343-349.
- [CT1] S. Cleary and J. Taback, *Thompson's group F is not almost convex*, J. Algebra **270**(2003), no.1., 133-149.
- [CT2] S. Cleary and J. Taback, *Combinatorial Properties of Thompson's group F*, Trans. Amer. Math. Soc. **356** (2004), no. 7., 2825-2849 (electronic).
- [CT3] S. Cleary and J. Taback, *Dead end words in Lamplighter groups and other wreath products*, Q. J. Math. **56** (2005), no. 2., 165-178.
- [F] S.B. Fordham, *Minimal length elements of Thompson's group F*, Geom. Dedicata, **99**(2003), 179-220.
- [G] V.S. Guba, *On the Properties of the Cayley Graph of Richard Thompson's Group F*, in International Conference on Semigroups and Groups in honor of the 65th birthday of Prof. John Rhodes. Internat. J. Algebra Comput. **14**(2004), no. 5-6, 677-702.

- [MS] C.F. Miller, III and M. Shapiro, *Solvable Baumslag-Solitar groups are not almost convex*, Geom. Dedicata **72**(1998), no. 2, 123-127.
- [RW] T.R. Riley and A.D. Warshall, *The unbounded dead-end depth property is not a group invariant*, Int. J. of Algebra and Computation **16**(2006), no.5., 969-983. 343-349.
- [SS] M. Shapiro and M. Stein, *Almost Convex Groups and the Eight Geometries*, Geom. Dedicata **55** (1995), 125-140.
- [T] C. Thiel *Zur Fast-Konvexität einiger nilpotenter Gruppen*, Bonner Math. Schriften (1992).
- [W] A.D. Warshall, *A group with deep pockets for all finite generating sets*, preprint(2007).

DEPARTMENT OF MATHEMATICS, STATISTICS AND COMPUTER SCIENCE, UNIVERSITY OF WISCONSIN-STOUT, MENOMONIE, WI 54751

E-mail address: horakm@uwstout.edu

DEPARTMENT OF MATHEMATICS, TRINITY COLLEGE, HARTFORD, CT 06106

E-mail address: melanie.stein@trincoll.edu

DEPARTMENT OF MATHEMATICS, BOWDOIN COLLEGE, BRUNSWICK, ME 04011

E-mail address: jtaback@bowdoin.edu