

An efficient centralized binary multicast network coding algorithm for any cyclic network

Ángela I. Barbero¹ and Øyvind Ytrehus²

¹Dept. of Applied Mathematics, University of Valladolid, 47011 Valladolid, Spain.

E-mail: angbar@wmatem.eis.uva.es

²Dept. of Informatics, University of Bergen, N-5020 Bergen, Norway

E-mail:oyvind@ii.uib.no

November 11, 2021

Abstract

We give an algorithm for finding network encoding and decoding equations for error-free multicasting networks with multiple sources and sinks. The algorithm given is efficient (polynomial complexity) and works on any kind of network (acyclic, link cyclic, flow cyclic, or even in the presence of knots). The key idea will be the appropriate use of the delay (both natural and additional) during the encoding. The resulting code will always work with finite delay with binary encoding coefficients.

Keywords: Network codes, multicasting, cyclic networks, pipelining, delay.

1 Introduction

We consider centralized algorithms for designing the network coding equations for multicast [1] in a network with directed edges. Early work in this area focused on acyclic networks (see [3], [4] and the references therein). Cyclic networks were considered in [5] and in [6], and [11]. In [5] we developed, based on the Linear Information Flow (LIF) algorithm in [3], the LIFE and LIFE-CYCLE algorithms. These will find a linear encoding (if one exists) in networks that are, respectively, link cyclic and simple flow cyclic (see [5] and Section 2 for definitions of different types of cyclicity).

Thus the state of the art prior to this paper is that centralized encoding can calculate, in polynomial time, a valid encoding for acyclic and simple cyclic networks. However, many networks occurring in practice may, in fact, contain complex cyclic structures.

There are two contributions of this paper:

1. We extend the algorithms in [5] by applying Mason's formula [14],[15] for signal propagation in a cyclic graph. The resulting new algorithm (LIFE*) will calculate a valid encoding for arbitrary cyclic and acyclic networks. The complexity is similar to that of the LIFE algorithm.
2. We propose a simple *binary* encoding scheme that exploits the natural delay inherent in the network. This scheme is related to those proposed in [8], [11], [12], and [13], and also to the randomized version of the LIF algorithm [4].

In Section 2 we give an overview of the necessary notation and previous results. Further, we will recall the two different notions of cyclicity and the two different types of flow cycles. Next, in Section 3 we present the LIFE* algorithm. Although the algorithm works over any field, we propose that the delay based binary encoding scheme demonstrated in Section 3 is particularly well suited for the LIFE* algorithm. Finally in Section 4 we discuss complexity issues and practical aspects. We have included an appendix, which makes up the bulk of the paper, with detailed examples that show how the algorithms work on the different kinds of networks.

2 Notation and previous results

The notations used in this paper follow and expand those used in [5].

Consider the network G , where $G = (V, E)$ is a directed multigraph. V represents the set of nodes and E the set of edges or links, each of unit capacity. A pair of nodes may be connected by one or multiple edges. Let $S = \{s_1, s_2, \dots, s_h\} \subset V$ be the set of unit rate information sources and let $T = \{t_1, t_2, \dots, t_r\} \subset V$ be the set of sinks. We will assume that each source (synchronously) generates one symbol at each (discrete) time instant. Let $x \in \mathbb{Z}$ denote the time. We will denote by $\sigma_i(x) \in \mathbb{F}_2$ the symbol produced by source s_i at time x . In case the given network has one unique source s that sends information at rate h we will simply create virtual sources s_i, \dots, s_h and link them to the actual source s . Note that most real life networks can be precisely or approximately described by a network G as outlined here.

For each edge $e \in E$ we will denote $start(e)$ and $end(e)$ the nodes at which e starts and ends, respectively. As usual, a *path* from node u to node v of length l is a sequence $\{e_i \in E : i = 1, \dots, l\}$ such that $u = start(e_1)$, $v = end(e_l)$, and $start(e_{i+1}) = end(e_i)$, for $i = 1, \dots, l - 1$.

The complete set of symbols $\sigma_i(x)$, $i = 1 \dots h$ will be called generation x . The object of the algorithm is to find an assignment of equations in such a way that each sink $t \in T$ at each time $x + d_t$ can complete the decoding of the whole generation x , where d_t is a (finite) constant for t denoting the total delay associated to that sink. It is assumed that $\sigma_i(x) = 0$, $i = 1 \dots h$ for any $x < 0$.

We assume that the transmission of a symbol on each link e has a unit delay associated with it, that is to say, if a symbol s is being carried by edge e at time x , that symbol, once processed at node $end(e)$, can be carried by an edge e' at time $x + 1$, for any edge e' with $start(e') = end(e)$. Apart from this intrinsic delay, as we will see, the encoding process might assign extra delays in order to satisfy certain required conditions.

Let D denote the linear delay operator. The way in which the operator works is as follows:

$$D(\sigma(x)) = D\sigma(x) = \sigma(x - 1)$$

and it is extended by linearity.

$$D(\sigma(x) + \xi(x)) = D\sigma(x) + D\xi(x) = \sigma(x - 1) + \xi(x - 1)$$

$$D^i\sigma(x) = D(D^{i-1}\sigma(x)) = \sigma(x - i) \quad \forall i \in \mathbb{Z}_0^+$$

$$(D^i + D^j)\sigma(x) = D^i\sigma(x) + D^j\sigma(x) = \sigma(x - i) + \sigma(x - j)$$

Also, abusing notation, we extend the operator in order to work with negative exponents in the following way.

$$D^{-1}\sigma(x) = \sigma(x + 1)$$

A *flow path* $f^{s,t}$ is simply a path from a source s to a sink t . We will assume that for each sink $t \in T$ there exists an edge disjoint set of flow paths $f^t = \{f^{s_i,t}, i = 1, \dots, h\}$. Following the notation of [3] we will call f^t the *flow* for sink t . The minimal subgraph of G that contains all flows (and their associated nodes) will be called the *flow path graph*, and can be determined from G by a suitable polynomial algorithm. From the perspective of encoding as discussed in this paper, we ignore the issue of determining the flow path graph and the flows, and assume that the network is a flow path graph, that the flows are known, and that every edge is on some flow path.

The results in [1] guarantee that in such a network, all the sinks can receive all the h input symbols produced by the h sources, and the results in [2] state that it can be done using linear coding on the network. In this paper we deal with linear coding, so each edge will be encoded using a linear encoding equation.

Definition 1 A *link cyclic network* is a network where there exists a cyclic subset of edges, i. e., a set $\{e_1, e_2, \dots, e_k, e_{k+1} = e_1\} \subset E$ for some positive integer k such that $\text{end}(e_i) = \text{start}(e_{i+1})$ for $1 \leq i < k$. The set of edges $\{e_1, e_2, \dots, e_k, e_{k+1} = e_1\}$ is a link cycle. If no such cycle exists, the network is *link acyclic* or *simply acyclic*.

Suppose e is an edge that lies on the flow path f^{s_i,t_j} . We will denote by $f_{\leftarrow}^{t_j}(e)$ the predecessor of edge e in that path. There is no ambiguity in the notation: e can lie on several flow paths f^{s_i,t_j} for different t_j , but not for different s_i and the same t_j , since all the flow paths arriving in t_j are edge disjoint. Thus, once t_j is fixed, e can only have one predecessor in the flow to t_j , that is, $f_{\leftarrow}^{t_j}(e)$ is the predecessor of e in the only flow path arriving in t_j that contains e . In the same way we denote by $f_{\rightarrow}^{t_j}(e)$ the successor of e in that flow path.

Let $T(e) \subseteq T$ denote the set of sinks t that use e in some flow path f^t , and let $P(e) = \{f_{\leftarrow}^t(e) \mid t \in T(e)\}$ denote the set of all predecessors of edge e . Note that all edges will have some predecessor ($P(e) \neq \emptyset$), except those with $\text{start}(e) = s_i$ for $i \in \{1, \dots, h\}$.

We will introduce some extra notation to denote the temporal order induced in the edges by the flow paths in f . When two edges e_1 and e_2 lie on the same flow path and e_1 is the predecessor of e_2 in that path, we will write $e_1 \prec e_2$. We will use transitivity to define relationships among other pairs of edges that lie on the same path but are not consecutive. We observe that in each path the relation \prec defines a total order in the edges that form that path, since a path that contains cycles, that is, edges that satisfy $e_1 \prec e_2 \prec \dots \prec e_n \prec e_1$ can be simplified by avoiding taking the trip around that cycle.

Definition 2 A *flow acyclic network* is a network where the relation \prec defines a partial ordering in E . If the relation does not define a partial ordering, the network is *flow cyclic*.

Note that a flow cyclic network is always link cyclic, but the converse is not true.

Definition 3 A *simple flow cycle* is a link cycle $\{e_1, e_2, \dots, e_k, e_{k+1} = e_1\}$ such that for each $i = 1, \dots, k$ there exists a flow path f^{s_i,t_i} that implies $e_i \prec e_{i+1}$. We observe here that there must be at least two distinct flow paths traversing the cycle.

Definition 4 A *flow knot* or *simply a knot* is formed by two or more simple flow cycles that share one or more edges.

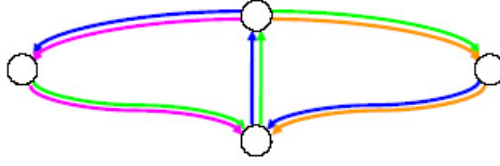

Figure 1: A flow knot.

Figure 1 shows an example of a knot. This particular knot forms part of the network in Example 4 in Figure 2.

We illustrate these concepts with some examples, shown in Figure 2, in which we show the flow path graphs for some networks. To make it easier to see, each sink is represented with a different color and all the flow paths arriving in that sink are drawn in the same color. One can easily check that the first example is an acyclic network (it is one of the so-called combination networks), the second is link cyclic but flow acyclic while Examples 3 and 4 are flow cyclic. Example 3 is the same cyclic network presented in [1], while Example 4 has been created by us to illustrate a network with a flow knot.

3 The LIFE* algorithm

In the whole process of encoding we will observe two basic principles.

- **Pass on information (PI) principle:** [5] When encoding each edge $e \in E$, all the symbols carried by the incoming edges $f_{\leftarrow}^t(e), t \in T(e)$ will contribute. This is because assigning coefficient 0 to any of those predecessors means that the flow carried on that predecessor is stopped at that point, meaning in turn that the actual flow path graph used is different from the one established initially. *
- **Old symbol removal (OSR) principle:** [5] To avoid symbols circulating endlessly on each flow cycle, they should be removed at the entrance point by the node through which they entered the cycle. We will explain this in more detail in 3.2.

In what follows we will consider two ways of expressing the symbol $v_e(x) \in \mathbb{F}_2$ to be transmitted on edge e at time x .

The *local encoding equation* specifies the action of each node. The general local encoding equation is

$$v_e(x) = \sum_{p \in P(e)} \pi(p, e) \tau(p, e) v_p(x), \quad (1)$$

where $\pi(p, e)$ is a polynomial in the operator D which denotes the encoding, i. e. they express the additional delays introduced for each flow path at the node $start(e)$. The term $\tau(p, e)$ denotes a function of the operator D , which we will call the transfer function from p to e and which accounts for the natural delay that, as previously noted, is inherent to the transmission on each edge. The way to compute this function will be explained in

*Observe that this principle makes sense if and only if the flow path graph is “reasonably efficient”. It may require some effort to calculate a reasonably efficient flow path graph, but if that work has been done it is wise, in terms of complexity, to rely on the provided flow path graph. The connection between flow path graph calculation and network coding can offer interesting complexity trade-offs, but this discussion is beyond the scope of this paper.

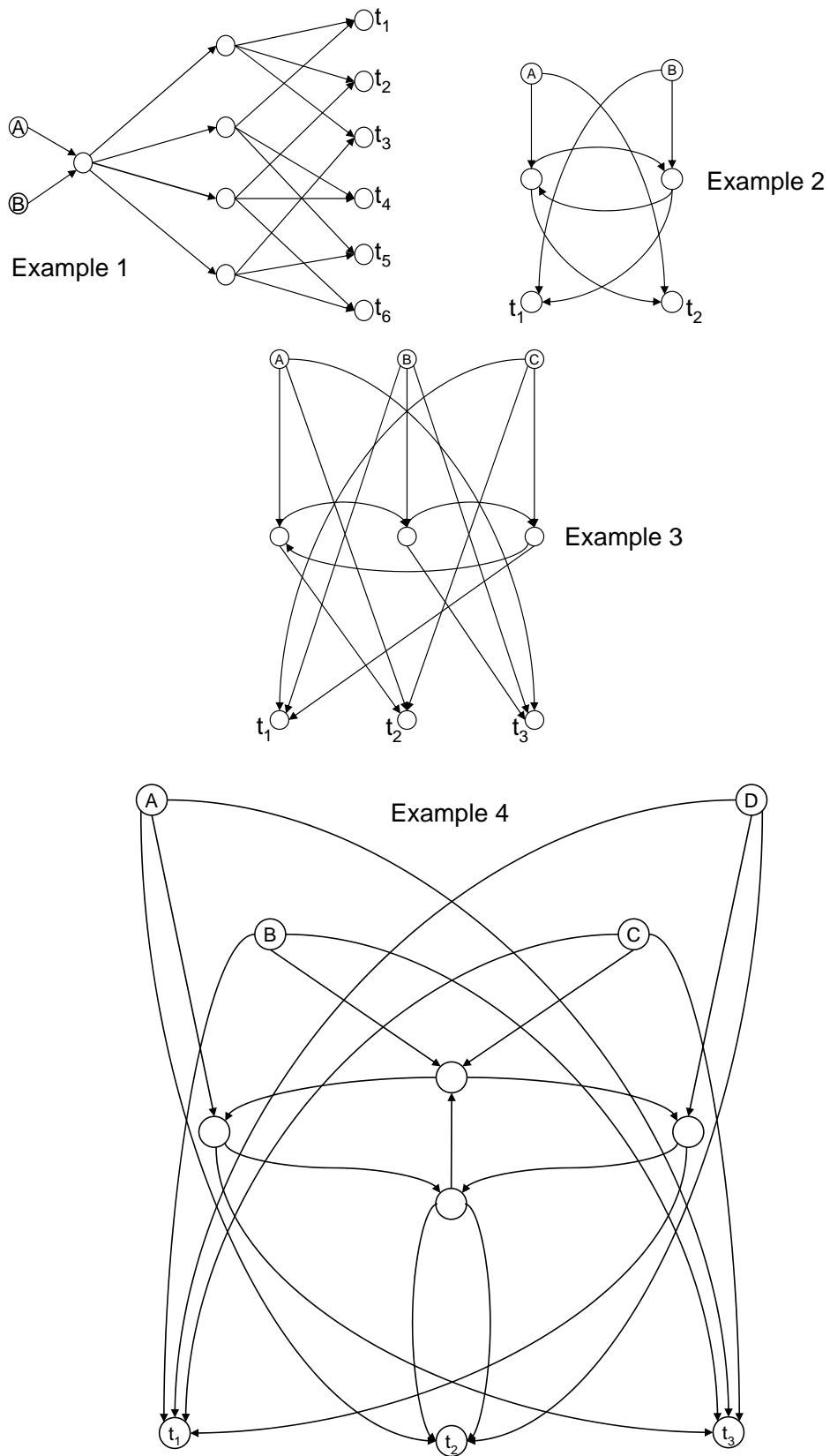

Figure 2: Examples of different types of networks.

detail for each case. The process of determining the network code consists of finding a set $\{\pi(p, e), e \in E, p \in P(e)\}$.

Remark: To simplify the encoding, we propose to use only monomial $\pi(p, e)$'s, that is, $\pi(p, e) = D^{i_e(p)}$ for some $i_e(p) \in \mathbb{Z}_0^+$. Thus the encoding consists of simply adding the encoding vectors of all predecessor edges, each one artificially delayed for zero or more time units as necessary. The algorithm can be straightforwardly modified to allow all polynomials in $\mathbb{F}_2(D)$ to be coefficients of the encoding combination. We have chosen the proposed scheme because it is simpler and because in this way we stick to the flow path graph that has been computed beforehand. Since there exists an encoding for any flow path graph, once a flow path graph has been computed we want to follow it and profit from that in order to reduce the computational complexity of finding the encoding equations for each edge. With this simplification, the encoding takes the form

$$v_e(x) = \sum_{p \in P(e)} D^{i_e(p)} \tau(p, e) v_p(x), \quad (2)$$

where $i_e(p) \in \mathbb{Z}_0^+$ are the exponents that express the additional delays introduced at the node $start(e)$.

The exponents $i_e(p)$ do not depend on the time variable x . We remark that employing a time invariant encoding, as in this case, ensures that streams of symbols from each source can be pipelined through the network.

The *global encoding equation* expresses the symbol $v_e(x)$ to be transmitted on edge e in terms of the source symbols:

$$v_e(x) = \sum_{i=1}^h \sum_{y \in \mathbb{Z}_0^+} \alpha(e, i, y) \sigma_i(x - y), \quad (3)$$

where $\alpha(e, i, y) \in \mathbb{F}_2$ is the coefficient that specifies the influence of each source symbol on $v_e(x)$.

Since $\sigma_i(z) = 0$ for all $z < 0$, the sum over y in (3) is finite, since the terms with $y > x$ will all be 0.

Another way of expressing the global encoding equation, more useful for our purposes, is by means of the field of rational functions $\mathbb{F}_2(D)$, where D is the delay operator.

$$v_e(x) = \sum_{i=1}^h F_{e,i}(D) \sigma_i(x), \quad (4)$$

where $F_{e,i}(D) \in \mathbb{F}_2(D)$. Again, all the monomials in D^y with $y > x$ will give null terms in the sum.

The goal of the LIFE* algorithm is to determine the local encoding equations of each edge e in each flow path, and the global encoding equation of the last edge in each flow path. In fact, during the course of the algorithm, all the global encoding equations will be determined.

In particular, the global encoding should be such that each sink t can, after a certain constant delay d_t , extract all the h information symbols belonging to a generation from the h sources. Each sink t receives h symbols, namely $\{v_{e_i}(x) \mid e_i \in f^{s_i, t}, t = end(e_i), i = 1, \dots, h\}$. If the corresponding h global encoding equations are linearly independent over the field $\mathbb{F}_2(D)$, the sink t can reconstruct the h input symbols of generation x at time $x + d_t$, by solving (in a simple way) the corresponding set of equations.

In the case of a flow acyclic network, all the edges in E can be visited according to the partial order \prec induced by the flow paths, starting by the edges with no predecessor ($e \in E \mid \text{start}(e) = s_i$ for some i), and proceeding in such a way that an edge e will not be visited until all its predecessors (all $p \in P(e)$) have already been visited and their global encoding equations computed. If the global encoding equations of all predecessors of e are substituted into (2), we get the global encoding equation for e .

When the network is flow cyclic the algorithm comes to a point at which no more edges can be visited in topological order, that is, the algorithm hits the flow cycle. Once the edges taking part in that cycle have been identified, the encoding of the whole cycle has to be treated as a whole. Here the old symbol removal principle is useful. An appropriate version of Mason's formula (see [14]) for the transfer function on a circuit will be the main tool to deal with it. We will explain this in detail in the second part of this section.

Similar to the LIF and the LIFE algorithms, the new LIFE* algorithm proceeds by maintaining, through the iterations of the main loop, the following sets for each $t \in T$:

- A set $E_t \subset E$, $|E_t| = h$, such that E_t contains *the most recently visited edge* on each flow path in f^t .
- An $h \times h$ matrix M_t , in which the element i, j will be the coefficient of $\sigma_i(x)$ in the global encoding equation of the j -th element of the subset E_t .

$$M_t = \begin{pmatrix} F_{e_{t,1},1}(D) & \cdots & F_{e_{t,h},1}(D) \\ \vdots & & \vdots \\ F_{e_{t,1},h}(D) & \cdots & F_{e_{t,h},h}(D) \end{pmatrix}$$

where $e_{t,1}, \dots, e_{t,h}$ are the edges in E_t .

Through each step of the algorithm we will impose the **full rank condition**: *The matrix M_t must have rank h , for all $t \in T$* . This condition is sufficient, but not necessary, for obtaining a valid network code. At the final step, for each $t \in T$ the set E_t will be that of the h edges which arrive in t . If these edges carry the symbols $r_{t,1}(x), \dots, r_{t,h}(x)$ at time x , we have

$$(\sigma_1(x), \dots, \sigma_h(x)) M_t = (r_{t,1}(x), \dots, r_{t,h}(x)).$$

By the full rank condition the matrix M_t is invertible, and the symbols $(\sigma_1(x), \dots, \sigma_h(x))$ can be recovered from the received ones as

$$(\sigma_1(x), \dots, \sigma_h(x)) = (r_{t,1}(x), \dots, r_{t,h}(x)) M_t^{-1}.$$

We will now explain how the algorithm will proceed.

3.1 The flow acyclic parts of the network

Whenever there is an edge e that can be visited in topological order (that is to say, one for which all the predecessors have been already visited), the algorithm will proceed to update the sets E_t and V_t in the following manner:

$$E_t := \{E_t \setminus \{f_{\leftarrow}^t(e)\}\} \cup \{e\}, \text{ for each } t \in T(e)$$

We consider the general local encoding equation for edge e

$$v_e(x) = \sum_{p \in P(e)} D^{i_e(p)} \tau(p, e) v_p(x)$$

where $i_e(p) \in \mathbb{Z}_0^+$ are the unknowns and represent the extra delay added at edge e to maintain the full rank invariant.

In the acyclic case with unit link delay, $\tau(p, e) = D, \forall p \in P(e)$. If the natural link delay is any other thing, even not necessarily the same for all links, it will be straightforward to adapt the corresponding equations. The local encoding formula (2) in the acyclic case with unit link delay takes the form

$$v_e(x) = \sum_{p \in P(e)} D^{i_e(p)} D v_p(x) = \sum_{p \in P(e)} D^{i_e(p)+1} v_p(x) \quad (5)$$

When the global encoding equations for all the $v_p(x)$, already determined in the previous steps of the algorithm, are substituted in the above expression, we will have the global encoding equation for e .

Further, for each $t \in T(e)$, replace in each matrix M_t the column corresponding to the encoding equation of $f_{\leftarrow}^t(e)$ with the new one $v_e(x)$.

The unknowns will be chosen to have values that satisfy the full rank invariant for all the matrices $M_t, t \in T(e)$, that have been updated following the update of the corresponding set E_t .

Conjecture 1 *There exists a finite value I , that depends on the graph and in particular on the set $T(e)$, so that some set $\{i_e(p) : p \in P(e) \text{ and } i_e(p) < I\}$, when applied to (2) and (5), will satisfy the full rank condition.*

This conjecture is in a way similar to Lemma 6 in [3]. There the field size required to guarantee the full rank invariant is proven to be $|T(e)|$, that is to say, each coefficient of the linear combination can be chosen among $|T(e)|$ possibilities. If we assume $I = |T(e)|$, the coefficients of the combinations in (2) can be chosen also among $|T(e)|$ different possibilities, namely $D^0 = 1, D, D^2, \dots, D^{|T(e)|-1}$. Nevertheless, the proof cannot use the Linear Algebra arguments used there because the set with which we are working is not a vector space.

The conjecture is further supported by Theorems 1 and 3 in [13], and by software simulations for random networks that we have carried out. We omit the details of these simulations.

For networks with random structure most encodings need no extra delay at all, and in the few remaining cases a delay of one unit in one of the incoming paths is enough to solve the problem for most of them. This observation also tells us that in order to find the encoding for each edge, which means finding the delay exponents $i_e(p)$, an efficient approach will be to use a greedy algorithm (see [4]) that starts by considering $i_e(p) = 0, \forall p \in P(e)$, checks if the full rank condition is satisfied, and in case it is not, proceeds to increment the delay exponents one by one until a solution is found. According to our simulations, the average number of tries needed to find the solution for each edge will be very low.

3.2 Dealing with flow cycles

When the algorithm encounters a flow cycle the set of edges forming part of the cycle has to be computed. Let us call C_E the set of edges and C_V the set of nodes that are ends of those edges in the cycle.

Let us call $P(C)$ the set of predecessor edges of the cycle,

$$P(C) = \{e \in E \setminus C_E \mid e \in P(e') \text{ for some } e' \in C_E\}.$$

We assume that the encoding equations for all the edges $e \in P(C)$ have been already determined in previous steps of the algorithm. The goal of this step of the algorithm will be finding at once the encoding equation of all the edges in C_E . In a sense it is as if the cycle as a whole is being treated as a kind of 'superedge'. All the individual edges in it will have basically the same structure of equation, which will be a combination of the equations of the edges in $P(C)$, that is

$$v_C(x) = \sum_{p \in P(C)} D^{i_C(p)} \tau(p, C) v_p(x) \quad (6)$$

Here $\tau(p, C)$ is a notation with which we simply mean a transfer function that will have to be computed separately for each particular edge in C_E . Thus, each edge in C_E will have a slightly different version of that basic structure due to the fact that they lay in different parts of the cycle and will consequently observe the incoming equations with different delay. We will distinguish two cases, namely, when the flow cycle is simple, or when it is a knot. The distinction will be made just for the clarity of explanation, since the simple case is just a particular case of the knot case.

Once the exact encoding equation has been determined for all the edges in C_E , the full rank invariant has to be checked only for the last edges in the cycle for each flow path, that is to say, for each t with $f^t \cap C_E \neq \emptyset$ the corresponding full rank condition must be satisfied by the edge $e \in f^t \cap C_E$ such that $f^t_{\rightarrow}(e) \notin C_E$.

3.2.1 The simple flow cycle case

Suppose $C_E = \{e_1, e_2, \dots, e_k\}$ with $end(e_i) = start(e_{i-1})$ for $i = 1, \dots, k-1$ and $end(e_k) = start(e_1)$.

Let us consider the local encoding equation of the cycle (6). We show now how to use the *Old symbol removal* principle.

We will focus on a certain edge in C_E , for instance e_1 . Suppose the local (and global) encoding equations of e_k , the predecessor of e_1 in the cycle, have been determined exactly.

$$v_{e_k}(x) = \sum_{p \in P(C)} D^{i_{e_k}(p)} \tau(p, e_k) v_p(x)$$

If e_1 had no predecessor outside the cycle, that is to say $P(e_1) = \{e_k\}$, then the encoding equation of e_1 would simply be $v_{e_1}(x) = Dv_{e_k}(x) = \sum_{p \in P(C)} D^{i_{e_k}(p)} \tau(p, e_k) Dv_p(x)$, which means $\tau(p, e_1) = D\tau(p, e_k) \forall p \in P(C)$. In the same way it is clear in general that if $p \in P(C) \setminus P(e_1)$, then $\tau(p, e_1) = D\tau(p, e_k)$.

Now suppose that there is one particular edge $p_1 \in P(C)$ which is the unique predecessor of e_1 not in C_E , this implies $\tau(p_1, e_1) = D$. Not removing at that point the old contribution of that predecessor would mean that the new contribution would mix with the old ones on each loop of the cycle and would keep circulating forever. In order to

avoid this we want to remove the old contribution that came on edge p_1 k time instants ago (where k is obviously the length of the cycle) and contribute to the circulation in the cycle with only the newest symbol coming on p_1 . This is done as follows

$$\begin{aligned} v_{e_1}(x) &= D \cdot v_{e_k}(x) + D^{i_C(p_1)} \tau(p_1, e_1) [-v_{p_1}(x - k) + v_{p_1}(x)] \\ &= D \cdot v_{e_k}(x) + D^{i_C(p_1)} D [-v_{p_1}(x - k) + v_{p_1}(x)] \end{aligned}$$

Here we have used the minus operator ($-$), despite all the operations are always on the binary field, in order to emphasize which symbols are being removed from the circulation.

In general, if $e \in C_E$ has several predecessors not lying in the cycle, the local encoding equation of e in terms of the predecessors of e takes the form

$$\begin{aligned} v_e(x) &= D \cdot v_{p_C(e)}(x) + \sum_{p \in P(e) \cap P(C)} D^{i_C(p)} \tau(p, e) [-v_p(x - k) + v_p(x)] \\ &= D \cdot v_{p_C(e)}(x) + \sum_{p \in P(e) \cap P(C)} D^{i_C(p)} D [-v_p(x - k) + v_p(x)] \end{aligned}$$

where $p_C(e) = P(e) \cap C_E$.

The result of doing this at the entrance in the cycle of each predecessor $p \in P(C)$ is that only one ‘instance’ of the symbols carried by each $p \in P(C)$ will be circulating on each edge $e \in C_E$. It is easy to see that the transfer function from each predecessor of the cycle to each edge in the cycle will be $\tau(p, e) = d(p, e) \forall p \in P(C), e \in C_E$, where $d(p, e)$ is the ‘distance’ measured in number of edges in the cycle that lay between $end(p)$ and $end(e)$.

To summarize, the local encoding equation of each edge $e \in C_E$ in terms of the predecessors of the cycle is

$$v_e(x) = \sum_{p \in P(C)} D^{i_C(p) + d(p, e)} v_p(x)$$

where again, the only unknowns are the values $i_C(p) \in \mathbb{Z}_0^+$.

An example of the use of this procedure can be found in the Appendix when encoding the network of Example 3.

3.2.2 The knot case

Suppose the set C_E is not just a simple flow cycle but forms a knot.

Again the local encoding equation for the whole knot will share a common structure

$$v_C(x) = \sum_{p \in P(C)} D^{i_C(p)} \tau(p, C) v_p(x)$$

Once more the idea is to treat the whole knot as a kind of ‘superedge’.

Here the main idea is the same as before: the old symbols must be removed from the circulation. In order to do it one needs to know how those arrive at each edge of the knot, and for this we need as a tool Mason’s formula (see [14],[15]) for the computation of the transfer function on a cyclic circuit.

We apply Mason’s formula to the directed line graph associated with C_E in the following way: Two edges e' and e in C_E are considered adjacent (and an arc starting in e' and ending in e will be drawn in the line graph) if and only if there exists a flow f^t for some $t \in T$ such that $f_{\leftarrow}^t(e) = e'$.

For each symbol entering the knot we have to compute the corresponding transfer function over all the edges in C_E . For this we will consider the entrance point of the

symbol (the edge at which that symbol enters) and the exit point (that is, the edge at which we want the transfer function of that symbol), and will apply Mason's formula between these points in the line graph above mentioned and using the delay operator D as the branch gain (see [14]) of each edge. Again, each branch gain can be taken to be whatever function of D models best the actual behavior of the transmission on that edge and the corresponding equations can be adapted consequently.

We show in detail how to compute the transfer functions by means of Example 4 in the Appendix.

The local encoding equation of edge $e \in C_E$ in terms of its predecessors is

$$v_e(x) = \sum_{p \in P(e) \cap C_E} Dv_p(x) + D \left[\sum_{p \in P(e) \cap P(C)} D^{i_C(p)} v_p(x) - \sum_{e' \in P(e) \cap C_E} \sum_{p' \in P'(e) \cap P(C)} D^{i_C(p')} \tau(p', e') v_{p'}(x) \right] \quad (7)$$

where $P'(e) = \{p \in E \mid \text{end}(p) = \text{start}(e)\}$. Note that $P(e) \subseteq P'(e)$ but the converse is not true in general. For instance, in Example 4 $P'(e_{13}) = \{e_5, e_8, e_{17}\}$ while $P(e_{13}) = \{e_5, e_{17}\}$ (see Figure 6).

The second sum in the formula brings the updated versions of the symbols that enter the knot at that point, while the double sum in the third term of the formula takes care of removing the old symbols.

This results in the following local encoding equation of each edge in the cycle in terms of the predecessors of the cycle:

$$v_e(x) = \sum_{p \in P(C)} D^{i_C(p)} \tau(p, e) v_p(x) \quad (8)$$

One can see that the previous case is just a particular case of this one, since the line graph that will be associated to a simple flow cycle will always contain a simple cycle itself, and the corresponding transfer function between each $p \in P(C)$ and each edge e in the cycle will be $\tau(p, e) = d(p, e)$ as was shown in 3.2.1.

A final observation at this point is that when the network is flow acyclic or contains only simple flow cycles, the global encoding equations will only contain polynomials on D , and not rational functions. Rational functions will be the result of using Mason's formula on knots.

Considerations about how to decode will be discussed in the Appendix.

We conclude the current Section by summarizing the complete LIFE* algorithm.

ALGORITHM LIFE*

Input: A directed multigraph G ; a set of flow paths f .

Initializing: $\forall t :$

- $E_t = \{e \mid e \in f^{s_i, t}, \text{start}(e) = s_i, i = 1, \dots, h\}$,
- $\{v_e(x) = D\sigma_i(x) = \sigma_i(x-1) \mid e \in E_t, \text{start}(e) = s_i\}$ or, equivalently, $M_t = DI_h$, $\forall t \in T$.

Main loop: Select an edge e for which the encoding equations have not yet been determined, but for which the global encoding equations of all the predecessor edges in $P(e)$ have been determined. Then proceed with the update of the set of current edges and current encoding equations as described in Subsection 3.1.

If selecting such an edge is not possible, then a flow cycle has been encountered. Follow the procedure explained in Subsection 3.2.

Output: For each edge, the local encoding as given by (2) is produced. At the end of the algorithm, $E_t = \{e \mid \text{end}(e) = t\}$ and V_t is still a set of h linearly independent equations from which t can recover the input.

Examples of application of the algorithm can be found in the Appendix.

4 Practical considerations

The algorithm will execute the main loop at most $|E|$ times. The exact complexity depends on details of the algorithm not discussed here. However the complexity of the LIF and LIFE algorithms are similar. For discussions on the complexity of the algorithm we also refer the reader to [3].

The encoding presented here follows a flow path graph given for a network. This flow path graph is not necessarily unique and the choice made when computing the flow path graph determines much of the possible encodings that can be achieved. Which flow path graph is the best choice remains an open problem. First one should consider in which way the solution wants to be optimal (minimal delay, minimal number of link used, minimal number of encoding nodes ...). Some notions of minimality in the flow path graph can be considered that we will not discuss here. Also we will not discuss the different strategies that can be used in order to compute a flow path graph.

Once the flow path graph for the network has been computed, the algorithm proceeds by following a topological order of the edges whenever that is possible (until a flow cycle or knot is found). However, this topological order is not unique. In many cases there is a certain choice to be made at each step about which edge will be encoded next of the several that follow in the order. This choice might in certain cases influence the total amount of delay necessary for the encoding. Examples can be given in which different choices of order lead to different final amounts of delay. Which ordering is most convenient for each flow path graph is also an open problem.

Another consideration to take into account is that the presence of added delay means that the nodes at which the delay has to be introduced must have memory elements to store the symbols that have to be 'artificially' delayed. In most cases the sinks will need to use memory in order to be able to solve the equations. In any case the maximum delay used is finite. In case no extra delay needs to be added to the maximum delay needed on each path will correspond to the total length of that path from source to sink.

The OSR and PI principles are also not necessary, but they help to keep the encoding simpler. Still, encodings can be found for flow cyclic networks in which the principles are not respected. Not respecting the PI principle is in fact equivalent to choosing a different flow graph path.

4.1 Network precoding

The inverse matrix of the encoding equation system may contain rational functions with denominators not on the form of D^i , for some constant i . If so, the encoding is 'catastrophic' in the sense that an error occurring in one of the transmissions can result in an infinite sequence of errors at the decoding sink. In order to avoid that, once the encoding has been computed using the LIFE* algorithm, one can compute the polynomial which is

maximum common divisor of all the rational functions resulting in the encoding process and introduce a pre-coding of the symbols generated by the sources, multiplying them by that maximum common divisor before they are introduced in the network. Alternatively, we can carry out this precoding locally in the nodes where a path enters a knot. We omit the details.

After this precoding is introduced, the network code as viewed from the perspective of the sink is polynomial, and any error that might occur will cause only a limited error propagation that can be handled by a suitable error correcting or erasure restoring code.

5 Conclusions

The LIFE* algorithm is able to encode any given network with polynomial complexity and over the binary field. The addition of delay at some nodes is not a major drawback. In fact, any network encoding will in practice have intrinsic delay associated with it, and the delay will differ over the various paths. Thus in most cases, LIFE* does not need to introduce extra delay. In the few cases in which we actually need to introduce extra delay, this extra delay is what allows us to get the encoding on the binary field, which would have been impossible otherwise. For networks where the LIF/LIFE algorithms work, LIFE* will perform with essentially the same complexity as the others, i. e., there is no known more efficient algorithm in these cases. If the network contains knots, which many practical networks do, no other known algorithm works, but for LIFE* the complexity may become dominated by the calculation of Mason's formula. The greedy approach to finding the coding coefficients for each edge performs essentially as in the acyclic cases, also for knots.

Appendix: Examples

We will show here how the LIFE* algorithm will find encodings for the different types of networks shown in Figure 2.

Example 1

The (2, 4) combination network is presented in Figure 2 a). It is known ([3],[8], [5]) to be a network which when extra delay is not used requires a finite field larger than \mathbb{F}_2 . We show here how the LIFE* algorithm will work on the flow graph given in Figure 3.

In order to better follow the progress of the algorithm, we have assigned labels e_1, \dots, e_{18} to the edges in the network following a topological order. Also, for simplicity in the notation we have called the two sources A and B , and $a(x)$ and $b(x)$ are the binary symbols released by the sources at time x .

The flow paths are represented with a code of colors and patterns in order to make it visually easy to follow. Each sink has a color assigned and each of the 2 sources has a pattern assigned (solid for A , dashed for B). The flow path from a source to a sink will be drawn in the color of the sink and with the pattern of the source.

The LIFE* algorithm starts by setting the following initial values:

$$\begin{aligned} E_{t_1} &= E_{t_2} = \dots = E_{t_6} = \{e_1, e_2\} \\ v_{e_1}(x) &= Da(x) = a(x-1) \\ v_{e_2}(x) &= Db(x) = b(x-1) \end{aligned}$$

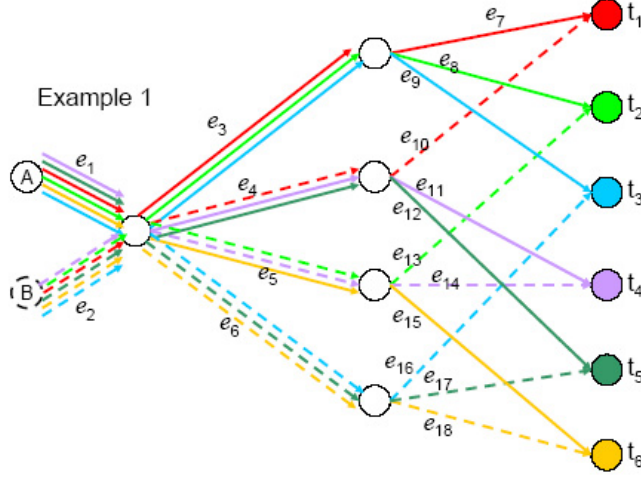

Figure 3: A flow path graph for the (2, 4) combination network.

Hence

$$M_{t_i} = \begin{pmatrix} D & 0 \\ 0 & D \end{pmatrix}, \quad i = 1, \dots, 6.$$

Now the algorithm enters the main loop:

- For encoding e_3 we can observe that the only predecessor is e_1 , and thus

$$v_{e_3}(x) = D^{i_{e_3}(e_1)+1}v_{e_1}(x) = D^{i_{e_3}(e_1)+2}a(x)$$

Edge e_3 is in the flows to sinks t_1, t_2 and t_3 , so we update the corresponding sets of edges and matrices

$$E_{t_1} = E_{t_2} = E_{t_3} = \{e_3, e_2\}$$

$$M_{t_1} = M_{t_2} = M_{t_3} = \begin{pmatrix} D^{i_{e_3}(e_1)+2} & 0 \\ 0 & D \end{pmatrix}$$

Clearly the choice $i_{e_3}(e_1) = 0$ makes all the matrices non singular. Thus the encoding of e_3 is

$$v_{e_3}(x) = Dv_{e_1}(x) = D^2a(x) = a(x - 2)$$

- e_4 has two predecessors, e_1 and e_2 .

$$v_{e_4}(x) = D^{i_{e_4}(e_1)+1}v_{e_1}(x) + D^{i_{e_4}(e_2)+1}v_{e_2}(x) = D^{i_{e_4}(e_1)+2}a(x) + D^{i_{e_4}(e_2)+2}b(x)$$

Edge e_4 is in the flows to sinks t_1, t_4 and t_5 , so we update the corresponding sets of edges and matrices

$$E_{t_1} = \{e_3, e_4\}, E_{t_4} = \{e_4, e_2\}, E_{t_5} = \{e_4, e_2\}$$

$$M_{t_1} = \begin{pmatrix} D^2 & D^{i_{e_4}(e_1)+2} \\ 0 & D^{i_{e_4}(e_2)+2} \end{pmatrix}, M_{t_4} = M_{t_5} = \begin{pmatrix} D^{i_{e_4}(e_1)+2} & 0 \\ D^{i_{e_4}(e_2)+2} & D \end{pmatrix},$$

Again one can see that the choice $i_{e_4}(e_1) = i_{e_4}(e_2) = 0$ makes all three matrices non singular. Hence

$$v_{e_4}(x) = Dv_{e_1}(x) + Dv_{e_2}(x) = D^2a(x) + D^2b(x) = a(x-2) + b(x-2)$$

- Edge e_5 has e_1 and e_2 as predecessors, and the form of the encoding is

$$v_{e_5}(x) = D^{i_{e_5}(e_1)+1}v_{e_1}(x) + D^{i_{e_5}(e_2)+1}v_{e_2}(x) = D^{i_{e_5}(e_1)+2}a(x) + D^{i_{e_5}(e_2)+2}b(x)$$

Edge e_5 takes part in the flows to sinks t_2, t_4 and t_6 , and the corresponding updating of edge sets and matrices is as follows:

$$E_{t_2} = \{e_3, e_5\}, E_{t_4} = \{e_4, e_5\}, E_{t_6} = \{e_5, e_2\}$$

$$M_{t_2} = \begin{pmatrix} D^2 & D^{i_{e_5}(e_1)+2} \\ 0 & D^{i_{e_5}(e_2)+2} \end{pmatrix}, M_{t_4} = \begin{pmatrix} D^2 & D^{i_{e_5}(e_1)+2} \\ D^2 & D^{i_{e_5}(e_2)+2} \end{pmatrix}, M_{t_6} = \begin{pmatrix} D^{i_{e_5}(e_1)+2} & 0 \\ D^{i_{e_5}(e_2)+2} & D \end{pmatrix},$$

Now clearly any value of $i_{e_5}(e_1)$ and $i_{e_5}(e_2)$ will make matrices M_{t_2} and M_{t_6} non singular, but in order to get M_{t_4} non singular we need those two values to be different, hence setting both equal to 0 does not work in this case. A possible choice would be $i_{e_5}(e_1) = 1, i_{e_5}(e_2) = 0$, which gives us the next encoding.

$$v_{e_5}(x) = D^2v_{e_1}(x) + Dv_{e_2}(x) = D^3a(x) + D^2b(x) = a(x-3) + b(x-2)$$

- In the same manner we work with edge e_6 , which has only one predecessor, namely e_2 and following the same procedure as before we can see that setting the only unknown exponent to 0 will give a correct encoding.

$$v_{e_6}(x) = Dv_{e_2}(x) = D^2b(x) = b(x-2)$$

Remark:

The particular case we have seen in the encodings of edges e_3 and e_6 , that is to say, an edge with only one predecessor is always solved in the same manner, copying the symbol carried by the predecessor and adding the natural delay unit. This corresponds to

$$v_e(x) = Dv_p(x)$$

when p is the only predecessor of e , that is to say, $P(e) = \{p\}$. (This means that the exponent $i_e(p)$ has been chosen to be 0.)

The updated matrices will keep full rank since, for each $t \in T(e)$ the corresponding updated matrix will be the result of multiplying by D the elements of one of the columns of the old matrix, which does not alter the rank of the matrix. \square

The rest of the encoding steps in this example are trivial in that sense, since all the rest of the edges have an only predecessor.

To complete the example we will illustrate how sinks can decode, this will also show what the delay means at the receiver end.

Let us focus on sink t_6 . According to the encoding just computed this sink will receive at time x the symbols $a(x - 4) + b(x - 3)$ and $b(x - 3)$.

Since we are assuming $a(x) = b(x) = 0$ for all negative x , sink t_6 will receive zeros on both channels until time $x = 3$ in which it receives $0 + b(0)$ and $b(0)$. This obviously gives him the knowledge only of symbol $b(0)$. But at time $x = 4$ it receives $a(0) + b(1)$ and $b(1)$. The knowledge of $b(1)$ allows it to recover $a(0)$, which completes the recovery of the symbols of generation 0. Proceeding in the same way it will complete the recovering of the symbols of generation x at time $x + 4$. The total delay observed by sink t_6 is 4, which in this case coincides with the maximum power of D used in the encoding equations arriving in t_6 .

This can also be interpreted in terms of matrices.

$$M_{t_6} \begin{pmatrix} D^4 & 0 \\ D^3 & D^3 \end{pmatrix},$$

If we create a vector with the symbols that arrive at t_6 at time x and denote it as $[r_{t_6,1}(x), r_{t_6,2}(x)]$, the encoding process can be described as

$$[a(x), b(x)]M_{t_6} = [r_{t_6,1}(x), r_{t_6,2}(x)]$$

(which is equivalent to saying that $r_{t_6,1}(x) = a(x - 4) + b(x - 3)$, $r_{t_6,2}(x) = b(x - 3)$). Now the decoding process can be described as

$$[a(x), b(x)] = [r_{t_6,1}(x), r_{t_6,2}(x)]M_{t_6}^{-1} = [r_{t_6,1}(x), r_{t_6,2}(x)]\frac{1}{D^4} \begin{pmatrix} 1 & 0 \\ 1 & D \end{pmatrix}$$

that is to say

$$\begin{aligned} a(x) &= r_{t_6,1}(x + 4) + r_{t_6,2}(x + 4) \\ b(x) &= r_{t_6,2}(x + 3) \end{aligned}$$

which again shows how, to recover the symbols in generation x , sink t_6 has to wait until receiving symbols at time $x + 4$.

Remark:

In general the delay experienced by each sink is lower bounded by the maximum length of the flow paths arriving at it from the h different sources and upper bounded by the maximum power of the delay operator D used in the global encoding equations of the edges arriving at that sink. \square

The upper bound is not always tight. To illustrate this let us consider the decoding that sink t_4 in the example has to do. Despite the maximum power of D for that sink is 4, it is easy to see that t_4 will complete the recovery of generation x at time $x + 3$. (But in addition it is absolutely necessary for t_4 to keep one memory element in order to be able to decode.)

Example 2

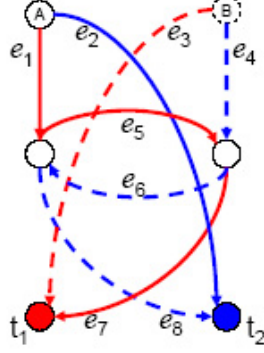

Figure 4: The unique flow path graph for Example 2.

Example 2

This example shows a network which is link cyclic but flow acyclic. The encoding process will work analogous to what was shown in the previous example.

The edges in Figure 4 have been numbered according to a topological order and one can observe that each edge has in fact only one predecessor, hence the encoding becomes trivial. We simply show here the result obtained.

$$\begin{aligned} v_{e_1}(x) &= v_{e_2}(x) = a(x - 1) \\ v_{e_3}(x) &= v_{e_4}(x) = b(x - 1) \\ v_{e_5}(x) &= a(x - 2) \\ v_{e_6}(x) &= b(x - 2) \\ v_{e_7}(x) &= a(x - 3) \\ v_{e_8}(x) &= b(x - 3) \end{aligned}$$

As we can see, link cyclic but flow acyclic networks do not present any additional problem for encoding, they behave exactly as the acyclic networks did.

Example 3

Here we deal with a flow cyclic network that contains a simple flow cycle. Figure 5 shows the unique flow path graph for this network.

The initialization will give us the encoding of the first 9 edges

$$\begin{aligned} v_{e_1}(x) &= v_{e_2}(x) = v_{e_3}(x) = a(x - 1) \\ v_{e_4}(x) &= v_{e_5}(x) = v_{e_6}(x) = b(x - 1) \\ v_{e_7}(x) &= v_{e_8}(x) = v_{e_9}(x) = c(x - 1) \end{aligned}$$

Now no more edges can be visited following a topological order. The cycle has set of edges $C_E = \{e_{10}, e_{11}, e_{12}\}$ and set of predecessors $P(C) = \{e_1, e_5, e_9\}$.

The structure of the local encoding equation in the cycle will be

$$v_C(x) = D^{i_C(e_1)}\tau(e_1, C)v_{e_1}(x) + D^{i_C(e_5)}\tau(e_5, C)v_{e_5}(x) + D^{i_C(e_9)}\tau(e_9, C)v_{e_9}(x)$$

Since we are in the case of a simple flow cycle, we can follow the formula given in 3.2.1 for the local encoding equation of each of the three edges in E_C .

Example 3

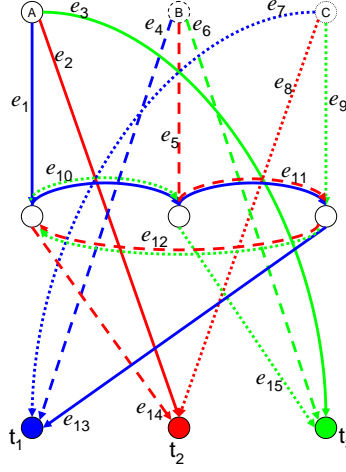

Figure 5: The unique flow path graph for Example 3.

$$v_{e_j}(x) = D^{i_C(e_1)+d(e_1,e_j)}v_{e_1}(x) + D^{i_C(e_5)+d(e_5,e_j)}v_{e_5}(x) + D^{i_C(e_9)+d(e_9,e_j)}v_{e_9}(x), \quad j = 10, 11, 12$$

Inspection of the graph shows that

$$\begin{aligned} d(e_1, e_{10}) &= 1, d(e_5, e_{10}) = 3, d(e_9, e_{10}) = 2 \\ d(e_1, e_{11}) &= 2, d(e_5, e_{11}) = 1, d(e_9, e_{11}) = 3 \\ d(e_1, e_{12}) &= 3, d(e_5, e_{12}) = 2, d(e_9, e_{12}) = 1 \end{aligned}$$

and the substitution in the above expression gives

$$\begin{aligned} v_{e_{10}}(x) &= D^{i_C(e_1)+1}a(x-1) + D^{i_C(e_5)+3}b(x-1) + D^{i_C(e_9)+2}c(x-1) \\ v_{e_{11}}(x) &= D^{i_C(e_1)+2}a(x-1) + D^{i_C(e_5)+1}b(x-1) + D^{i_C(e_9)+3}c(x-1) \\ v_{e_{12}}(x) &= D^{i_C(e_1)+3}a(x-1) + D^{i_C(e_5)+2}b(x-1) + D^{i_C(e_9)+1}c(x-1) \end{aligned}$$

The full rank invariant condition must be checked for edge e_{10} in the flow to sink t_3 , for edge e_{11} in the flow to sink t_1 and for edge e_{12} in the flow to sink t_2 . This gives us the following matrices:

$$M_{t_1} = \begin{pmatrix} D^{i_C(e_1)+3} & 0 & 0 \\ D^{i_C(e_5)+2} & D & 0 \\ D^{i_C(e_9)+4} & 0 & D \end{pmatrix}, M_{t_2} = \begin{pmatrix} D & D^{i_C(e_1)+4} & 0 \\ 0 & D^{i_C(e_5)+3} & 0 \\ 0 & D^{i_C(e_9)+2} & D \end{pmatrix}, M_{t_3} = \begin{pmatrix} D & 0 & D^{i_C(e_1)+2} \\ 0 & D & D^{i_C(e_5)+4} \\ 0 & 0 & D^{i_C(e_9)+3} \end{pmatrix}$$

Clearly any value of $i_C(e_1)$, $i_C(e_5)$ and $i_C(e_9)$ satisfies the full rank invariant and we choose the simplest one setting the three unknowns to be 0.

The global encoding equations of the edges in the cycle are as follows

$$\begin{aligned} v_{e_{10}}(x) &= a(x-2) + b(x-4) + c(x-3) \\ v_{e_{11}}(x) &= a(x-3) + b(x-2) + c(x-4) \\ v_{e_{12}}(x) &= a(x-4) + b(x-3) + c(x-2) \end{aligned}$$

The encoding now of edges e_{13} , e_{14} and e_{15} is trivial since each of them has only one predecessor.

$$\begin{aligned}v_{e_{13}}(x) &= a(x-4) + b(x-3) + c(x-5) \\v_{e_{14}}(x) &= a(x-5) + b(x-4) + c(x-3) \\v_{e_{15}}(x) &= a(x-3) + b(x-5) + c(x-4)\end{aligned}$$

The delay at the final receivers is 4, even when the maximum exponent of D in the equations received by the sinks is 5. Besides there is some extra memory needed in order to decode. For instance, recovering the element $a(1)$ and hence completing the generation 1, can be done by sink t_1 at time $x = 5$, provided it kept in memory the element $c(0)$.

A slight modification could be done for the encoding of the edges whose predecessors lie in the cycle, in such a way that they get the last updated values, for instance, edge e_{13} can benefit from the fact that edge e_9 enters in the same node from which e_{13} exits and hence get an updated version of the symbol carried by e_9 , then the encoding of e_{13} would be

$$v_{e_{13}}(x) = a(x-4) + b(x-3) + c(x-2)$$

which is actually the same encoding that has the edge e_{12} , and results in smaller memory needed at the receiver t_1 .

Remark:

In general, using this last observation, the local encoding equation of an edge $e \notin C_E$ with a predecessor $p_C \in P'(e) \cap P(C)$ would be

$$v_e(x) = D^{i_e(s_C)}v_{s_C}(x) + \sum_{p \in P(e) \setminus \{p_C\}} D^{i_e(p)}Dv_p(x)$$

where s_C is the successor of p_C that lies in the cycle, that is to say, the edge in C_E with $start(s_C) = start(e) = end(p_C)$.

We finally remark that in a simple flow cycle, the element s_C is are unique, even in there are several elements p_C in $P'(e) \cap P(C)$. \square

Example 4

In this example we show how to work with a knot. Figure 6 shows the essentially unique flow path graph for the network given.

The initialization values are

$$\begin{aligned}v_{e_1}(x) &= v_{e_2}(x) = v_{e_3}(x) = a(x-1) \\v_{e_4}(x) &= v_{e_5}(x) = v_{e_6}(x) = b(x-1) \\v_{e_7}(x) &= v_{e_8}(x) = v_{e_9}(x) = c(x-1) \\v_{e_{10}}(x) &= v_{e_{11}}(x) = v_{e_{12}}(x) = d(x-1)\end{aligned}$$

No more edges can be visited in topological order because $C_E = \{e_{13}, e_{14}, e_{15}, e_{16}, e_{17}\}$ form a flow cycle. In fact it is a non simple cycle, since it contains two flow cycles $e_{13} \prec e_{15} \prec e_{17} \prec e_{13}$ and $e_{14} \prec e_{16} \prec e_{17} \prec e_{14}$, both sharing the edge e_{17} . Hence we are in presence of a flow knot. (See Figure 7 a))

The predecessors of the knot are $P_C = \{e_2, e_5, e_8, e_{11}\}$.

The general structure of the local encoding equation for the knot is

$$v_C(x) = D^{i_C(e_2)}\tau(e_2, C)v_{e_2}(x) + D^{i_C(e_5)}\tau(e_5, C)v_{e_5}(x) + D^{i_C(e_8)}\tau(e_8, C)v_{e_8}(x) + D^{i_C(e_{11})}\tau(e_{11}, C)v_{e_{11}}(x)$$

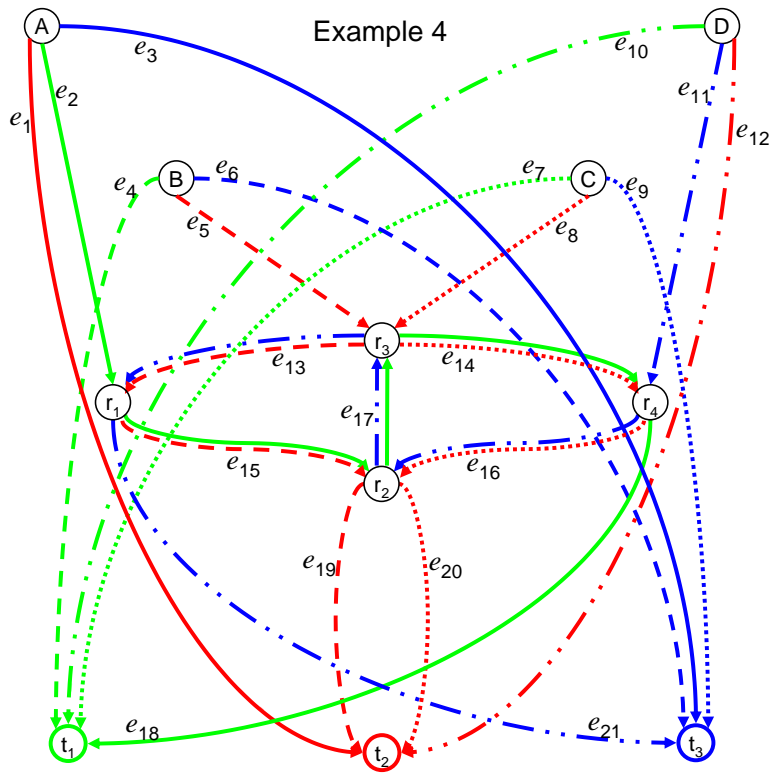

Figure 6: A flow path graph for the network in Example 4.

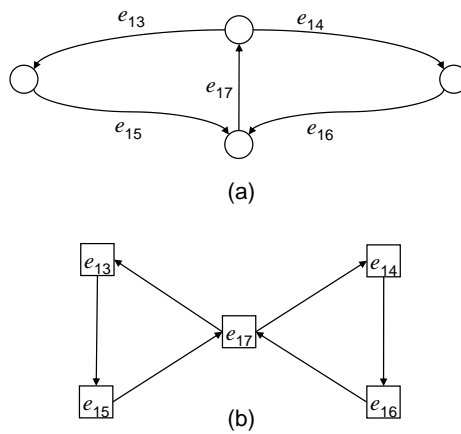

Figure 7: The knot in Example 4 and its line graph.

In order to find the local encoding of each edge in the knot we have to use Mason's formula on a line graph to compute the transfer function for each of the symbols carried by the predecessors of the knot.

The line graph is shown in Figure 7 b). The nodes correspond to the edges in C_E . The edge connecting e_{13} to e_{15} is drawn because of the flow path from source B to sink t_2 , the edge connecting e_{15} to e_{17} is determined by the flow from source A to sink t_1 . In the same way we draw the other connections in the line graph following the flow paths.

The branch gain of each connection is D . Mason's formula is as follows

$$\tau(e_j, e_k) = \frac{\sum F_i(e_j, e_k) \Delta_i(e_j, e_k)}{\Delta}$$

where $\Delta = 1 + \sum c_i - \sum c_i c_j + \dots$, $F_i(e_j, e_k)$ is the function corresponding to the i -th forward path from e_j to e_k and $\Delta_i(e_j, e_k)$ is defined as Δ but counting only the cycles in the circuit that are disjoint with the i -th forward path. Here we are using the notations in [14], and we refer the reader there for a more detailed explanation of Mason's formula.

- We will now focus on the symbol that enters through edge e_2 into e_{15} . Its itinerary through the knot is shown in Figure 8 (a).

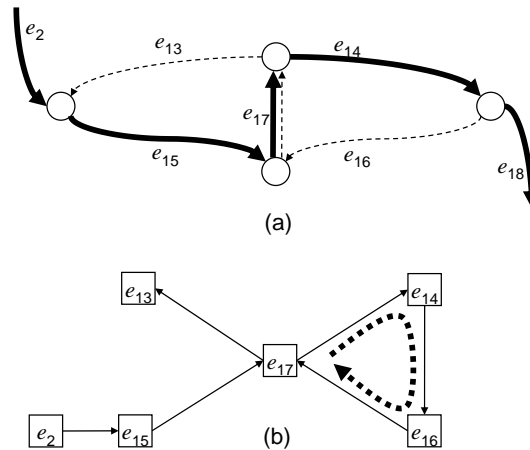

Figure 8: The itinerary of symbols carried by e_2 in the knot of Example 4.

The edges used by the flow path that carries that symbol are represented as bold lines, but we observe also that when the symbol arrives at node $end(e_{17})$ this node will distribute it not only to edge e_{14} , but since there is a flow path connecting edge e_{17} with edge e_{13} , the symbol in question will travel also on edge e_{13} and in the same way we can see that it will travel also on edge e_{16} . That is represented in dashed lines in Figure 7 (a). On the other hand, using memory, the node $end(e_2) = end(e_{13}) = start(e_{15})$ can remove the contribution of the old symbol that arrives back at it through e_{13} , so we can then remove the connection between edges e_{13} and e_{15} from the line graph. Hence the actual line graph followed by the symbols that enter the knot through edge e_2 is shown in Figure 8 (b).

In that graph there is only one cycle, which has length 3, namely $\{e_{17}, e_{14}, e_{16}, e_{17}\}$. All the transfer functions will have as denominator the function $\Delta = 1 + D^3$.

For the transfer function corresponding to edge e_{15} , Figure 9 (a) shows that the only forward path is node disjoint with the only cycle of the graph, hence $F_1(e_2, e_{15}) = D$ and $\Delta_1(e_{15}, e_{15}) = 1 + D^3$. Finally $\tau(e_2, e_{15}) = \frac{D \cdot (1 + D^3)}{1 + D^3} = D$ which is the expectable result.

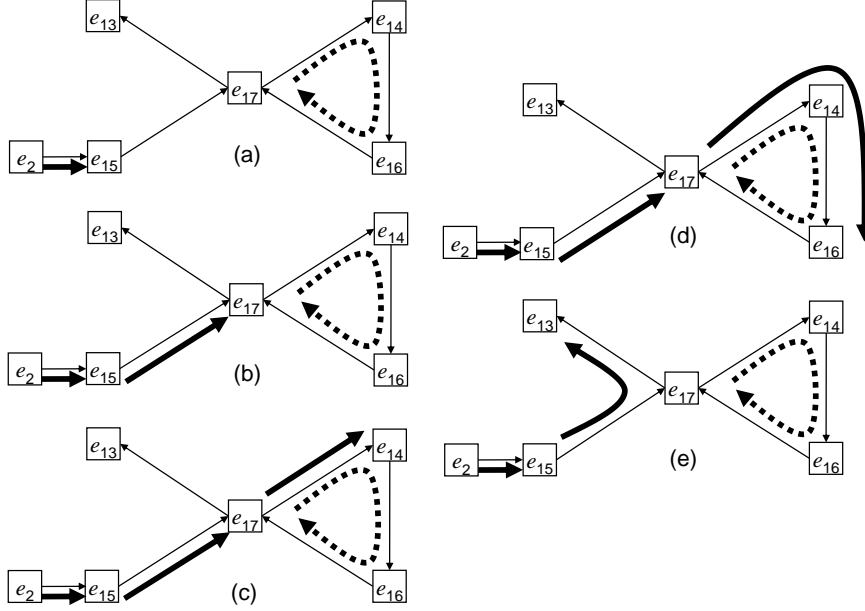

Figure 9: Computation of Mason's formula from edge e_2 .

Now we compute the transfer function corresponding to edge e_{17} . Figure 9 (b) shows the only forward path, which is not node disjoint with the only cycle of the graph, hence $F_1(e_2, e_{17}) = D^2$ and $\Delta_1(e_2, e_{17}) = 1$. Finally $\tau(e_2, e_{17}) = \frac{D^2 \cdot 1}{1 + D^3}$.

In the same way all the other transfer functions can be computed (drawings of the corresponding forward paths can be seen in Figures 9 c) to e)).

$$\tau(e_2, e_{14}) = \frac{D^3 \cdot 1}{1 + D^3}, \tau(e_2, e_{16}) = \frac{D^4 \cdot 1}{1 + D^3}, \tau(e_2, e_{13}) = \frac{D^3 \cdot 1}{1 + D^3}$$

Specially interesting is the transfer function corresponding to edge e_{13} since it gives the function of the old symbol that has to be removed when passing again through node $end(e_2) = end(e_{13}) = start(e_{15})$.

- If we now focus on the circulation in the knot of the symbol carried by edge e_5 we observe (Figure 10) that the flow path will transport it through edges e_{13} and e_{15} (bold line in the figure) and node $end(e_{15})$ will send it back to node $end(e_5)$ through edge e_{17} (dashed in the figure), but node $end(e_5)$ will not send that symbol on edge e_{14} and hence the symbol does not travel along the two cycles in the knot, but only on the cycle $\{e_{13}, e_{15}, e_{17}, e_{13}\}$. The computation of the transfer functions is then straightforward.

$$\tau(e_5, e_{13}) = D, \tau(e_5, e_{15}) = D^2, \tau(e_5, e_{17}) = D^3, \tau(e_5, e_{14}) = 0, \tau(e_5, e_{16}) = 0$$

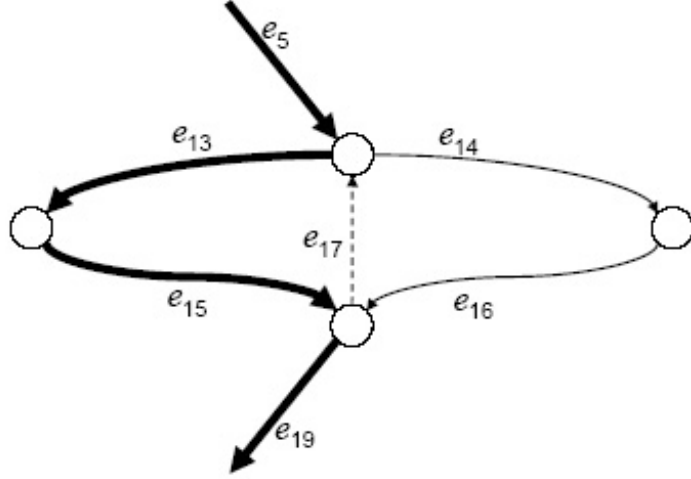

Figure 10: Itinerary of symbols carried by e_5 in the knot of Example 4.

- The symbol entering the knot via edge e_8 follows a similar trajectory to that of the one entering via edge e_5 .

$$\tau(e_8, e_{14}) = D, \tau(e_8, e_{16}) = D^2, \tau(e_8, e_{17}) = D^3, \tau(e_8, e_{13}) = 0, \tau(e_8, e_{15}) = 0$$

- Finally, the symbol entering via edge e_{11} follows an itinerary identical (considering symmetry) to that entering via e_2 already studied.

$$\tau(e_{11}, e_{16}) = \frac{D \cdot (1+D^3)}{1+D^3} = D, \tau(e_{11}, e_{17}) = \frac{D^2 \cdot 1}{1+D^3},$$

$$\tau(e_{11}, e_{13}) = \frac{D^3 \cdot 1}{1+D^3}, \tau(e_{11}, e_{15}) = \frac{D^4 \cdot 1}{1+D^3}, \tau(e_{11}, e_{14}) = \frac{D^3 \cdot 1}{1+D^3}$$

Now that all the transfer functions have been computed one can use formula in Equation (5) to compute the encoding of each edge in the knot.

We will go in detail with the computation of the encoding of edge e_{13} .

$$\begin{aligned} v_{e_{13}}(x) &= D^{ic(e_2)}\tau(e_2, e_{13})v_2(x) + D^{ic(e_5)}\tau(e_5, e_{13})v_5(x) + \\ &+ D^{ic(e_8)}\tau(e_8, e_{13})v_8(x) + D^{ic(e_{11})}\tau(e_{11}, e_{13})v_{11}(x) \\ &= D^{ic(e_2)}\frac{D^3}{1+D^3}a(x-1) + D^{ic(e_5)}Db(x-1) + D^{ic(e_8)}0c(x-1) + D^{ic(e_{11})}\frac{D^3}{1+D^3}d(x-1) \end{aligned}$$

In the same way the encoding of the other edge in the knot can be computed using Equation (6).

$$v_{e_{14}}(x) = D^{ic(e_2)}\frac{D^3}{1+D^3}a(x-1) + D^{ic(e_5)}0b(x-1) + D^{ic(e_8)}Dc(x-1) + D^{ic(e_{11})}\frac{D^3}{1+D^3}d(x-1)$$

$$v_{e_{15}}(x) = D^{ic(e_2)}Da(x-1) + D^{ic(e_5)}D^2b(x-1) + D^{ic(e_8)}0c(x-1) + D^{ic(e_{11})}\frac{D^4}{1+D^3}d(x-1)$$

$$v_{e_{16}}(x) = D^{ic(e_2)}\frac{D^4}{1+D^3}a(x-1) + D^{ic(e_5)}0b(x-1) + D^{ic(e_8)}D^2c(x-1) + D^{ic(e_{11})}Dd(x-1)$$

$$v_{e_{17}}(x) = D^{ic(e_2)}\frac{D^2}{1+D^3}a(x-1) + D^{ic(e_5)}D^3b(x-1) + D^{ic(e_8)}D^3c(x-1) + D^{ic(e_{11})}\frac{D^2}{1+D^3}d(x-1)$$

Now we will show how each edge can compute its encoding based on its predecessors and using formula in Equation (5). Again we will go in detail with edge e_{13} .

$$\begin{aligned} P(e_{13}) &= \{e_5, e_{17}\}, P(e_{13}) \cap P(C) = \{e_5\}, P(e_{13}) \cap C_E = \{e_{17}\} \\ P'(e_{13}) &= \{e_5, e_8, e_{17}\}, P'(e_{13}) \cap P(C) = \{e_5, e_8\} \end{aligned}$$

The direct application of formula in Equation (5) to this case gives the following

$$\begin{aligned} v_{e_{13}}(x) &= Dv_{e_{17}}(x) + DD^{i_C(e_5)}v_{e_5}(x) - D(D^{i_C(e_5)}\tau(e_5, e_{17})v_{e_5}(x) + D^{i_C(e_8)}\tau(e_8, e_{17})v_{e_8}(x)) \\ &= D\left(D^{i_C(e_2)}\frac{D^2}{1+D^3}a(x-1) + D^{i_C(e_5)}D^3b(x-1)\right. \\ &\quad \left.+ D^{i_C(e_8)}D^3c(x-1) + D^{i_C(e_{11})}\frac{D^2}{1+D^3}d(x-1)\right) \\ &\quad + D^{i_C(e_5)}Db(x-1) \\ &\quad - D^{i_C(e_5)}DD^3b(x-1) - D^{i_C(e_8)}DD^3c(x-1) \\ &= D^{i_C(e_2)}\frac{D^3}{1+D^3}a(x-1) + D^{i_C(e_5)}Db(x-1) + D^{i_C(e_8)}0c(x-1) + D^{i_C(e_{11})}\frac{D^3}{1+D^3}d(x-1) \end{aligned}$$

In a similar way all the other edges can get their encoding using those of its predecessors and formula in Equation (5).

Next point is determining the unknowns $i_C(e)$ for each edge in C by checking the full rank conditions. To be precise, the full rank condition must be checked for edge e_{13} in the flow to sink t_1 , for edge e_{14} in the flow to sink t_3 and for edges e_{15} and e_{16} in the flow to sink t_2 . A careful exam of the corresponding matrices will show that $i_C(e_2) = i_C(e_5) = i_C(e_8) = i_C(e_{11}) = 0$ is a valid choice.

Finally, a similar remark to the one made in Example 3 gives us $v_{e_{18}}(x) = v_{e_{16}}(x)$ and $v_{e_{21}}(x) = v_{e_{15}}(x)$.

Also we have $v_{e_{19}}(x) = Dv_{e_{15}}(x), v_{e_{20}}(x) = Dv_{e_{16}}(x)$.

The final encoding matrices at the sinks are

$$M_{t_1} = \begin{pmatrix} \frac{D^5}{1+D^3} & 0 & 0 & 0 \\ 0 & D & 0 & 0 \\ D^3 & 0 & D & 0 \\ D^2 & 0 & 0 & D \end{pmatrix}, M_{t_2} = \begin{pmatrix} D & D^3 & \frac{D^6}{1+D^3} & 0 \\ 0 & D^4 & 0 & 0 \\ 0 & 0 & D^4 & 0 \\ 0 & \frac{D^6}{1+D^3} & D^3 & D \end{pmatrix}, M_{t_3} = \begin{pmatrix} D & 0 & 0 & D^2 \\ 0 & D & 0 & D^3 \\ 0 & 0 & D & 0 \\ 0 & 0 & 0 & \frac{D^5}{1+D^3} \end{pmatrix}$$

As can be seen the elements in the matrices are now rational functions (typical case after traversing a knot). This however represents no extra difficulty at the sink. For instance, if we focus on sink t_2 , the received symbols at that sink are $r_{t_2,1}(x) = v_1(x), r_{t_2,2}(x) = v_{19}(x), r_{t_2,3}(x) = v_{20}(x)$ and $r_{t_2,4}(x) = v_{12}(x)$. Their expressions in terms of the source symbols are given in each column of the matrix M_{t_2} . In order to retrieve the source symbols t_2 will multiply the received ones by the inverse of matrix M_{t_2} .

$$\begin{aligned} [a(x), b(x), c(x), d(x)] &= [r_{t_2,1}(x), r_{t_2,2}(x), r_{t_2,3}(x), r_{t_2,4}(x)]M_{t_2}^{-1} \\ &= \left[r_{t_2,1}(x+1), r_{t_2,1}(x+2) + r_{t_2,2}(x+4) + \frac{D}{1+D^3}r_{t_2,4}(x), \right. \\ &\quad \left. \frac{D}{1+D^3}r_{t_2,1}(x) + r_{t_2,3}(x+4) + r_{t_2,4}(x+2), r_{t_2,4}(x+1) \right] \end{aligned}$$

The way to deal with expressions like $\frac{D}{1+D^3}r_{t_2,1}(x)$ at t_1 is to keep in memory three local variables that we will call $r_{t_2,1,i}(x)$. They will all be initialized as 0, and at time x one of them will be updated and the other two keep the same as follows:

$$\begin{aligned} r_{t_2,1,i_x}(x) &= r_{t_2,1,i_x}(x-1) + r_{t_2,1}(x) \\ r_{t_2,1,i}(x) &= r_{t_2,1,i}(x-1) \text{ for } i \in \{0, 1, 2\} \setminus \{i_x\} \end{aligned}$$

where $x = 3q_x + i_x$ with $i_x \in \{0, 1, 2\}$, that is to say, i_x is the remainder of the integer division of x by 3.

In this way $\frac{D}{1+D^3}r_{t_2,1}(x) = r_{t_2,1,i_{(x-1)}}(x-1)$, and the receiver t_2 does not need to keep an infinite memory, despite the aspect of the equations received.

Example 5

We will briefly show here one more example in which a more complicated network is dealt with.

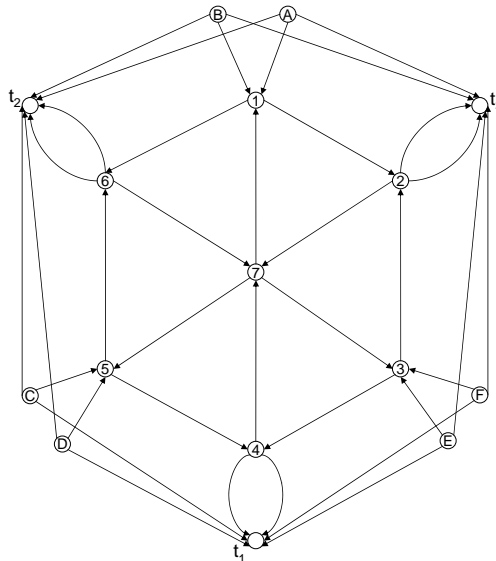

Figure 11: The network of Example 5.

The network is shown in Figure 11. It has six unit rate sources, labeled A, B, \dots, F , and three sinks, labeled t_1, t_2, t_3 .

The other nodes have been labeled $1, \dots, 7$.

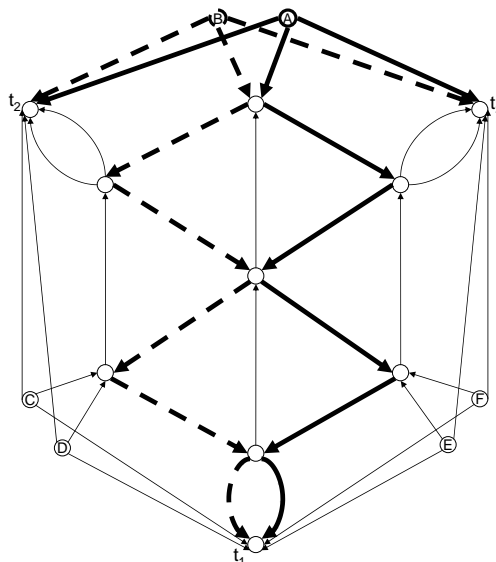

Figure 12: Flow paths in the network of Example 5.

The flow path graph for such a network is (essentially) unique. The flow paths starting in sources A and B are shown in Figure 12 in solid bold and dashed bold lines respectively. The flow paths from the other sources are the same but with a rotation of 120 degrees to the right or to the left.

This implies that the flow path graph of that network contains a knot formed by 6 simple cycles, each of length 3. Figure 13 a) shows the knot while Figure 13 b) shows the

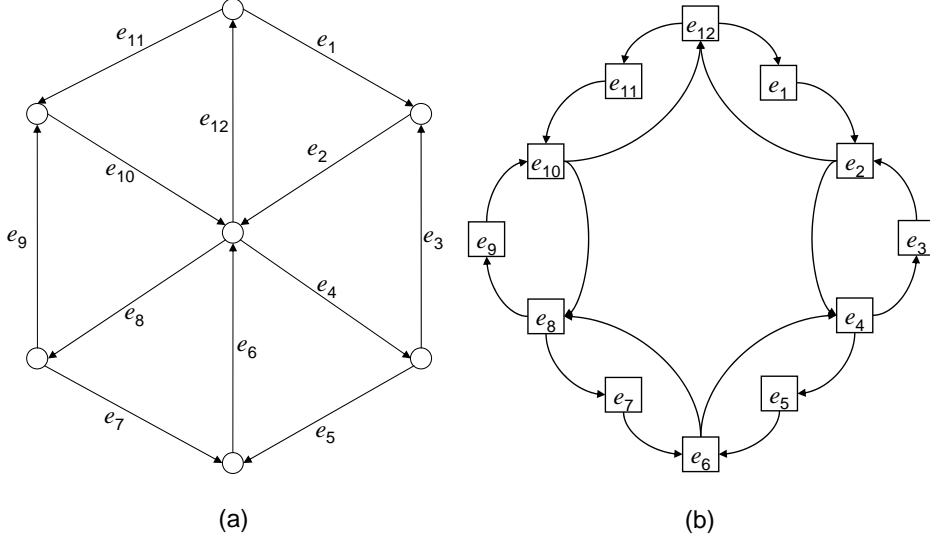

Figure 13: The knot and its line graph in the network of Example 5.

corresponding line graph constructed following the flow paths through the knot.

We will focus now on the way the symbols are carried by the edge that connects source A with node 1 travel through the node. Mason's formula will be used to compute the transfer functions from that edge (which is one of the predecessors of the knot) to any other edge in the knot. Let us call α that edge, that is, $\alpha = (A, 1) \in P(C)$. In Figure 14 a) we show the itinerary of the symbol from α . The bold solid lines are the actual flow path and the dashed lines are the edges not belonging to the flow path of the symbol but that will nevertheless carry instances of that symbol due to the connections in the knot. We can see that the only edge in which that symbol do not travel is e_{11} . Figure 14 b) shows the corresponding modified line graph that allow us to compute the transfer function $\tau(\alpha, 12)$. The bold dashed arrows show the position of the 4 simple cycles in that graph and the two bold lines (one black and the other grey) show the trajectories of the two different forward paths from α to e_{12} . Direct application of Mason's formula gives

$$\tau(\alpha, e_{12}) = \frac{D^3(1 + 3D^3 + D^6) + D^9 \mathbf{i}}{1 + 4D^3 + 3D^6} = \frac{D^3}{1 + D^3}$$

The rest of the transfer functions from α to edges in C are

$$\begin{aligned} \tau(\alpha, e_1) &= D, & \tau(\alpha, e_2) &= D^2 + \frac{D^5}{1+D^6}, & \tau(\alpha, e_3) &= \frac{D^4}{1+D^6}, & \tau(\alpha, e_4) &= \frac{D^3}{1+D^6}, \\ \tau(\alpha, e_5) &= \frac{D^4}{1+D^6}, & \tau(\alpha, e_6) &= \frac{D^5}{1+D^3}, & \tau(\alpha, e_7) &= \frac{D^7}{1+D^6}, & \tau(\alpha, e_8) &= \frac{D^6}{1+D^6}, \\ \tau(\alpha, e_9) &= \frac{D^7}{1+D^6}, & \tau(\alpha, e_{10}) &= \frac{D^8}{1+D^6}, & \tau(\alpha, e_{11}) &= 0, \end{aligned}$$

The transfer functions from the other predecessors of the knot to the edges in the knot are analogous. In fact, they can be derived from the ones already computed by simply taking into account the multiple symmetries that this network presents.

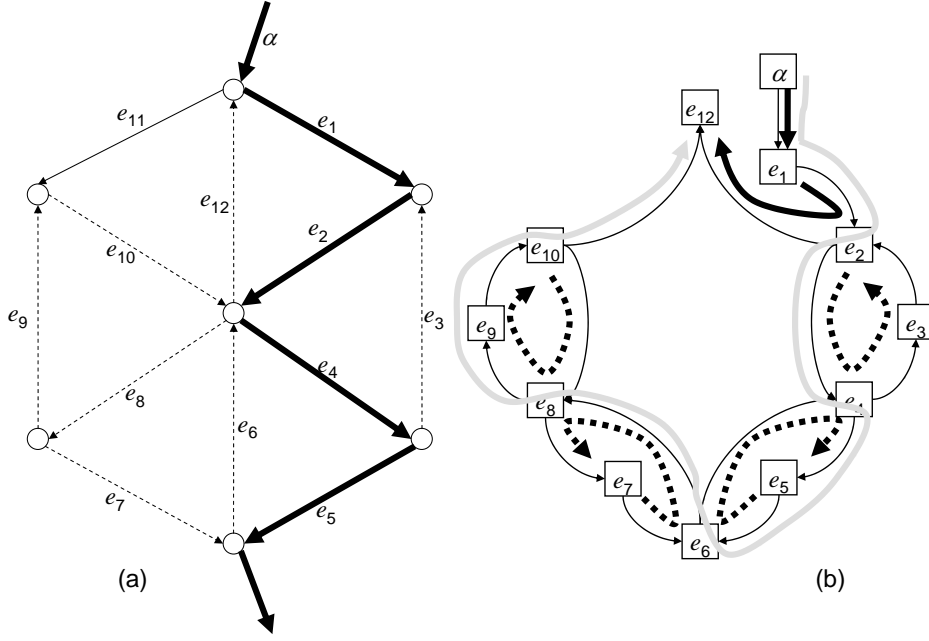

Figure 14: Itinerary of the symbol from edge α through the knot in the network of Example 5.

If we denote by β the edge that connects source B with node 1, γ the one that connects C with 5, δ the one that connects D with 5, and finally ϵ and ϕ the edges connecting sources E and F respectively to node 3, following the procedure of LIFE* we obtain the following global encoding equation for edge e_5

$$v_{e_5}(x) = D^{i_C(\alpha)} \frac{D^5}{1+D^6} a(x) + D^{i_C(\beta)} \frac{D^8}{1+D^6} b(x) + D^{i_C(\gamma)} \frac{D^8}{1+D^6} c(x) + D^{i_C(\delta)} \frac{D^5}{1+D^6} d(x) + D^{i_C(\epsilon)} D^2 e(x)$$

Encoding for other edges in the network will be analogous.

The full rank condition will be satisfied when choosing $e_C(\alpha) = e_C(\beta) = e_C(\gamma) = e_C(\delta) = e_C(\epsilon) = e_C(\phi) = 0$.

The local encoding equation of edge e_5 in terms of its predecessors is as follows.

$$v_{e_5}(x) = Dv_{e_4}(x) + DD^{i_C(\epsilon)}v_{\epsilon}(x) - D(D^{i_C(\epsilon)}\tau(\epsilon, e_4)v_{\epsilon}(x) + D^{i_C(\phi)}\tau(\phi, e_4)v_{\phi}(x))$$

The decoding matrix for sink t_1 has the form

$$M_{t_1}^{-1} = \frac{1}{D^6} \begin{pmatrix} 1 & D^3 & 0 & 0 & 0 & 0 \\ D^3 & 1 & 0 & 0 & 0 & 0 \\ \frac{D^8}{1+D^6} & \frac{D^{11}}{1+D^6} & D^5 & 0 & 0 & 0 \\ \frac{D^{11}}{1+D^6} & \frac{D^2}{1+D^6} & 0 & D^5 & 0 & 0 \\ D^2 + \frac{D^{11}}{1+D^6} & D^5 + \frac{D^8}{1+D^6} & 0 & 0 & D^5 & 0 \\ \frac{D^8}{1+D^6} & \frac{D^5}{1+D^6} & 0 & 0 & 0 & D^5 \end{pmatrix}$$

References

- [1] R. Ahlswede, N. Cai, S.-Y. R. Li, and R. W. Yeung, "Network Information Flow", *IEEE Transactions on Information Theory*, Vol. 46, April 2000, pp. 1204-1216.

- [2] S.-Y. R. Li, R. W. Yeung and N. Cai, “Linear Network Coding”, *IEEE Transactions on Information Theory*, Vol. 46, April 2000, pp. 1204-1216.
- [3] P. Sanders, S. Egner, and L. Tolhuizen, “Polynomial Time Algorithms for Network Information Flow”, *Proc. SPAA '03*, San Diego, June 7-9, 2003, pp. 286-294.
- [4] S. Jaggi, P. Sanders, P.A. Chou, M. Effros, S. Egner, K. Jain and L.M.G.M. Tolhuizen, “Polynomial Time Algorithms for Multicast Network Code Construction”, *IEEE Transactions on Information Theory*, Vol. 51, June 2005, pp. 1973-1982.
- [5] Á. Barbero and Ø. Ytrehus, “Cycle-logical Treatment of ‘Cyclopathic’ Networks”, *IEEE Transactions on Information Theory*, Vol. 52, June 2006, pp. 2795-2805.
- [6] Á. Barbero and Ø. Ytrehus, “Knotworking”, *Proceedings of ITA 2006*, San Diego, February 2006 (electronic publication).
- [7] Á. Barbero and Ø. Ytrehus, “Heuristic Algorithms for Small Field Multicast Encoding”, *Proceedings of ITW'06 Chengdu*, October 2006, pp. 428-432.
- [8] C. Fragouli and E. Soljanin, *IEEE Transactions on Information Theory*, Vol. 52, March 2006, pp. 829-848.
- [9] P. A. Chou, Y. Wu, and K. Jain, “Practical Network Coding”, *Proc. 41st Annual Allerton Conference on Communication, Control and Computing*, Oct. 2003.
- [10] D. S. Lun, M. Médard, and M. Effros, “On Coding for Reliable Communication over Packet Networks”,
- [11] E. Erez and M. Feder, “Convolutional network coding”, *Proceedings of ISIT'04 Chicago*, June 2004, p. 146.
- [12] Shuo-Yen Robert Li and R. W. Yeung, “On Convolutional Network Coding”, *Proceedings of ISIT'06 Seattle*, June 2006, pp. 1743-1747.
- [13] H. (Francis) Lu, “Binary Linear Network Codes”, *Submitted to IEEE ITW on Information Theory for Wireless networks* July 2007.
- [14] S. Lin and D. Costello, *Error Control Coding*, Prentice-Hall 2004.
- [15] Meng Chu Zhou, Chi-Hsu Wang, and Xiaoyong Zhao, “Automating Masons rule and its application to analysis of stochastic Petri nets”, *IEEE Transactions on Control Systems Technology*, Vol. 3, No. 2, June 1995, pp. 238-244.