

On a Conjecture of E. M. Stein on the Hilbert Transform on Vector Fields

Michael Lacey and Xiaochun Li

MICHAEL LACEY, SCHOOL OF MATHEMATICS, GEORGIA INSTITUTE OF TECHNOLOGY, ATLANTA GA 30332

XIAOCHUN LI, DEPARTMENT OF MATHEMATICS, UNIVERSITY OF ILLINOIS, URBANA IL 61801

E-mail address: xcli@math.uiuc.edu

The authors are supported in part by NSF grants. M.L. was supported in part by the Guggenheim Foundation.

ABSTRACT. Let v be a smooth vector field on the plane, that is a map from the plane to the unit circle. We study sufficient conditions for the boundedness of the Hilbert transform

$$H_{v,\epsilon} f(x) := \text{p.v.} \int_{-\epsilon}^{\epsilon} f(x - yv(x)) \frac{dy}{y}$$

where ϵ is a suitably chosen parameter, determined by the smoothness properties of the vector field. It is a conjecture, due to E. M. Stein, that if v is Lipschitz, there is a positive ϵ for which the transform above is bounded on L^2 . Our principal result gives a sufficient condition in terms of the boundedness of a maximal function associated to v , namely that this new maximal function be bounded on some L^p , for some $1 < p < 2$. We show that the maximal function is bounded from L^2 to weak L^2 for all Lipschitz vector fields. The relationship between our results and other known sufficient conditions is explored.

Contents

Preface	vii
Chapter 1. Overview of Principal Results	1
Chapter 2. Connections to Besicovitch Set and Carleson's Theorem	7
Besicovitch Set	7
The Kakeya Maximal Function	7
Carleson's Theorem	8
The Weak L^2 Estimate in Theorem 1.15 is Sharp	10
Chapter 3. The Lipschitz Kakeya Maximal Function	11
The Weak L^2 Estimate	11
An Obstacle to an L^p estimate, for $1 < p < 2$	22
Bourgain's Geometric Condition	23
Vector Fields that are a Function of One Variable	27
Chapter 4. The L^2 Estimate for Hilbert Transform on Lipschitz Vector Fields	31
Definitions and Principle Lemmas	31
Truncation and an Alternate Model Sum	36
Proofs of Lemmata	39
Chapter 5. Almost Orthogonality Between Annuli	63
Application of the Fourier Localization Lemma	63
The Fourier Localization Estimate	79
References	87

Preface

This memoir is devoted to a question in planar Harmonic Analysis, a subject which is a circle of problems all related to the Besicovitch set. This anomalous set has zero Lebesgue measure, yet contains a line segment of unit length in each direction of the plane. It is a known, since the 1970's, that such sets must necessarily have full Hausdorff dimension. The existence of these sets, and the full Hausdorff dimension, are intimately related to other, independently interesting issues [26]. An important tool to study these questions is the so-called Kakeya Maximal Function, in which one computes the maximal average of a function over rectangles of a fixed eccentricity and arbitrary orientation.

Most famously, Charles Fefferman showed [10] that the Besicovitch set is the obstacle to the boundedness of the disc multiplier in the plane. But as well, this set is intimately related to finer questions of Bochner-Riesz summability of Fourier series in higher dimensions and space-time regularity of solutions of the wave equation.

This memoir concerns one of the finer questions which center around the Besicovitch set in the plane. (There are not so many of these questions, but our purpose here is not to catalog them!) It concerns a certain degenerate Radon transform. Given a vector field v on \mathbb{R}^2 , one considers a Hilbert transform computed in the one dimensional line segment determined by v , namely the Hilbert transform of a function on the plane computed on the line segment $\{x + tv(x) \mid |t| \leq 1\}$.

The Besicovitch set itself says that choice of v cannot be just measurable, for you can choose the vector field to always point into the set. Finer constructions show that one cannot take it to be Hölder continuous of any index strictly less than one. Is the sharp condition of Hölder continuity of index one enough? This is the question of E. M. Stein, motivated by an earlier question of A. Zygmund, who asked the same for the question of differentiation of integrals.

The answer is not known under any condition of just smoothness of the vector field. Indeed, as is known, and we explain, a positive answer would necessarily imply Carleson's famous theorem on the convergence of Fourier series, [6]. This memoir is concerned with reversing

this implication: Given the striking recent successes related to Carleson's Theorem, what can one say about Stein's Conjecture? In this direction, we introduce a new object into the study, a *Lipschitz Kekeya Maximal Function*, which is a variant of the more familiar Kekeya Maximal Function, which links the vector field v to the 'Besicovitch sets' associated to the vector field. One averages a function over rectangles of arbitrary orientation and—in contrast to the classical setting—arbitrary eccentricity. But, the rectangle must suitably localize the directions in which the vector field points. This Maximal Function admits a favorable estimate on L^2 , and this is one of the main results of the Memoir.

On Stein's Conjecture, we prove a conditional result: If the Lipschitz Kekeya Maximal Function associated with v maps is an estimate a little better than our L^2 estimate, then the associated Hilbert transform is indeed bounded. Thus, the main question left open concerns the behavior of these novel Maximal Functions.

While the main result is conditional, it does contain many of the prior results on the subject, and greatly narrows the possible avenues of a resolution of this conjecture.

The principal results and conjectures are stated in the Chapter 1; following that we collect some of the background material for this subject, and prove some of the folklore results known about the subject. The remainder of the Memoir is taken up with the proofs of the Theorems stated in the Chapter 1.

Acknowledgment. The efforts of a strikingly generous referee has resulted in corrections of arguments, and improvements in presentation throughout this manuscript. We are indebted to that person.

Michael T. Lacey and Xiaochun Li

CHAPTER 1

Overview of Principal Results

We are interested in singular integral operators on functions of two variables, which act by performing a one dimensional transform along a particular line in the plane. The choice of lines is to be variable. Thus, for a measurable map, v from \mathbb{R}^2 to the unit circle in the plane, that is a vector field, and a Schwartz function f on \mathbb{R}^2 , define

$$H_{v,\epsilon} f(x) := \text{p.v.} \int_{-\epsilon}^{\epsilon} f(x - yv(x)) \frac{dy}{y}.$$

This is a truncated Hilbert transform performed on the line segment $\{x + tv(x) : |t| < 1\}$. We stress the limit of the truncation in the definition above as it is important to different scale invariant formulations of our questions of interest. This is an example of a Radon transform, one that is degenerate in the sense that we seek results independent of geometric assumptions on the vector field. We are primarily interested in assumptions of smoothness on the vector field.

Also relevant is the corresponding maximal function

$$(1.1) \quad M_{v,\epsilon} f := \sup_{0 < t \leq \epsilon} (2t)^{-1} \int_{-t}^t |f(x - sv(x))| ds$$

The principal conjectures here concern Lipschitz vector fields.

Zygmund Conjecture 1.2. *Suppose that v is Lipschitz. Then, for all $f \in L^2(\mathbb{R}^2)$ we have the pointwise convergence*

$$(1.3) \quad \lim_{t \rightarrow 0} (2t)^{-1} \int_{-t}^t f(x - sv(x)) ds = f(x) \quad \text{a. e.}$$

More particularly, there is an absolute constant $K > 0$ so that if $\epsilon^{-1} = K\|v\|_{\text{Lip}}$, we have the weak type estimate

$$(1.4) \quad \sup_{\lambda > 0} \lambda |\{M_{v,\epsilon} f > \lambda\}|^{1/2} \lesssim \|f\|_2.$$

The origins of this question go back to the discovery of the Besicovitch set in the 1920s, and in particular, constructions of this set show that the Conjecture is false under the assumption that v is Hölder continuous for any index strictly less than 1. These constructions, known

since the 1920's, were the inspiration for A. Zygmund to ask if integrals of, say, $L^2(\mathbb{R}^2)$ functions could be differentiated in a Lipschitz choice of directions. That is, for Lipschitz v , and $f \in L^2$, is it the case that

$$\lim_{\epsilon \rightarrow 0} (2\epsilon)^{-1} \int_{-\epsilon}^{\epsilon} f(x - yv(x)) dy = f(x) \quad \text{a.e.}(x)$$

These and other matters are reviewed in the next chapter.

Much later, E. M. Stein [25] raised the singular integral variant of this conjecture.

E. M. Stein Conjecture 1.5. *There is an absolute constant $K > 0$ so that if $\epsilon^{-1} = K\|v\|_{\text{Lip}}$, we have the weak type estimate*

$$(1.6) \quad \sup_{\lambda > 0} \lambda |\{ |H_{v,\epsilon} f| > \lambda \}|^{1/2} \lesssim \|f\|_2.$$

These are very difficult conjectures. Indeed, it is known that if the Stein Conjecture holds for, say, C^2 vector fields, then Carleson's Theorem on the pointwise convergence of Fourier series [6] would follow. This folklore result is recalled in the next Chapter.

We will study these questions using modifications of the phase plane analysis associated with Carleson's Theorem [15–20] and a new tool, which we term a *Lipschitz Kakeya Maximal Function*.

Associated with the Besicovitch set is the Kakeya Maximal Function, a maximal function over all rectangles of a given eccentricity. A key estimate is that the $L^2 \rightarrow L^{2,\infty}$ norm of this operator grows logarithmically in the eccentricity, [27, 28].

Associated with a Lipschitz vector field, we define a class of maximal functions taken over rectangles of *arbitrary* eccentricity, but these rectangles are approximate level sets of the vector field. Perhaps surprisingly, these maximal functions admit an L^2 bound that is *independent* of eccentricity. Let us explain.

A *rectangle* is determined as follows. Fix a choice of unit vectors in the plane (e, e^\perp), with e^\perp being the vector e rotated by $\pi/2$. Using these vectors as coordinate axes, a rectangle is a product of two intervals $R = I \times J$. We will insist that $|I| \geq |J|$, and use the notations

$$(1.7) \quad \mathbf{L}(R) = |I|, \quad \mathbf{W}(R) = |J|$$

for the length and width respectively of R .

The *interval of uncertainty* of R is the subarc $\text{EX}(R)$ of the unit circle in the plane, centered at e , and of length $\mathbf{W}(R)/\mathbf{L}(R)$. See Figure 1.1.

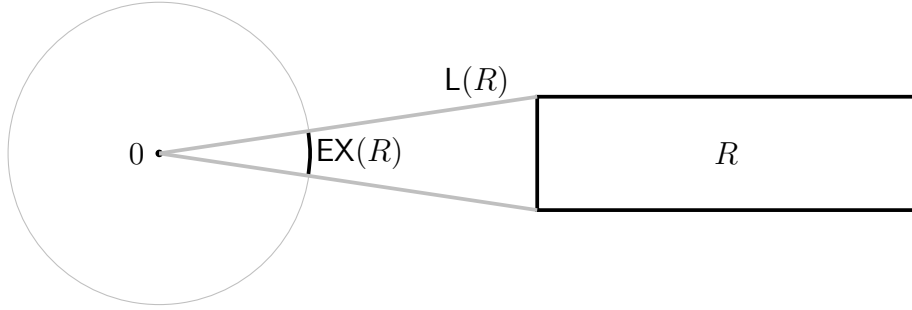

FIGURE 1.1. An example eccentricity interval $\text{EX}(R)$. The circle on the left has radius one.

We now fix a Lipschitz map v of the plane into the unit circle. We only consider rectangles R with

$$(1.8) \quad \text{L}(R) \leq (100\|v\|_{\text{Lip}})^{-1}.$$

For such a rectangle R , set $\mathbf{V}(R) = R \cap v^{-1}(\text{EX}(R))$. It is essential to impose a restriction of this type on the length of the rectangles, for without it, one can modify constructions of the Besicovitch set to provide examples which would contradict the main results and conjectures of this work.

For $0 < \delta < 1$, we consider the maximal functions

$$(1.9) \quad \mathbf{M}_{v,\delta} f(x) \stackrel{\text{def}}{=} \sup_{|\mathbf{V}(R)| \geq \delta|R|} \frac{\mathbf{1}_R(x)}{|R|} \int_R |f(y)| dy.$$

That is we only form the supremum over rectangles for which the vector field lies in the interval of uncertainty for a fixed positive proportion δ of the rectangle, see Figure 1.2.

Weak L^2 estimate for the Lipschitz Kakeya Maximal Function 1.10. *The maximal function $\mathbf{M}_{\delta,v}$ is bounded from $L^2(\mathbb{R}^2)$ to $L^{2,\infty}(\mathbb{R}^2)$ with norm at most $\lesssim \delta^{-1/2}$. That is, for any $\lambda > 0$, and $f \in L^2(\mathbb{R}^2)$, this inequality holds:*

$$(1.11) \quad \lambda^2 |\{x \in \mathbb{R}^2 : \mathbf{M}_{\delta,v} f(x) > \lambda\}| \lesssim \delta^{-1} \|f\|_2^2.$$

The norm estimate in particular is independent of the Lipschitz vector field v .

A principal Conjecture of this work is:

Conjecture 1.12. *For some $1 < p < 2$, and some finite N and all $0 < \delta < 1$ and all Lipschitz vector fields v , the maximal function $\mathbf{M}_{\delta,v}$ is bounded from $L^p(\mathbb{R}^2)$ to $L^{p,\infty}(\mathbb{R}^2)$ with norm at most $\lesssim \delta^{-N}$.*



FIGURE 1.2. A rectangle, with the vector field pointing in the long direction of the rectangle at three points.

We cannot verify this Conjecture, only establishing that the norm of the operator can be controlled by a slowly growing function of eccentricity.

In fact, this conjecture is stronger than what is needed below. Let us modify the definition of the Lipschitz Kakeya Maximal Function, by restricting the rectangles that enter into the definition to have an approximately fixed width. For $0 < \delta < 1$, and choice of $0 < \mathbf{w} < \frac{1}{100} \|v\|_{\text{Lip}}$, parameterizing the width of the rectangles we consider, define

$$(1.13) \quad M_{v,\delta,\mathbf{w}} f(x) \stackrel{\text{def}}{=} \sup_{\substack{|V(R)| \geq \delta |R| \\ \mathbf{w} \leq W(R) \leq 2\mathbf{w}}} \frac{\mathbf{1}_R(x)}{|R|} \int_R |f(y)| dy.$$

We can restrict attention to this case as the primary interest below is the Hilbert transform on vector fields applied to functions with frequency support in a fixed annulus. By Fourier uncertainty, the width of the fixed annulus is the inverse of the parameter \mathbf{w} above.

Conjecture 1.14. *For some $1 < p < 2$, and some finite N and all $0 < \delta < 1$, all Lipschitz vector fields v and $0 < \mathbf{w} < \frac{1}{100} \|v\|_{\text{Lip}}$ the maximal function $M_{\delta,v,\mathbf{w}}$ is bounded from $L^p(\mathbb{R}^2)$ to $L^{p,\infty}(\mathbb{R}^2)$ with norm at most $\lesssim \delta^{-N}$.*

These conjectures are stated as to be universal over Lipschitz vector fields. On the other hand, we will state conditional results below in which we assume that a given vector field satisfies the Conjecture above, and then derive consequences for the Hilbert transform on vector fields. We also show that e.g. real-analytic vector fields [3] satisfy these conjectures.

We turn to the Hilbert transform on vector fields. As it turns out, it is useful to restrict functions in frequency variables to an annulus. Such operators are given by

$$S_t f(x) = \int_{1/t \leq |\xi| \leq 2/t} \widehat{f}(\xi) e^{i\xi \cdot x} d\xi.$$

The relevance in part is explained in part by this result of the authors [15], valid for measurable vector fields.

Theorem 1.15. *For any measurable vector field v we have the L^2 into $L^{2,\infty}$*

$$\sup_{\lambda>0} \lambda |\{ |H_{v,\infty} \circ S_t f| > \lambda \}|^{1/2} \lesssim \|f\|_2.$$

The inequality holds uniformly in $t > 0$.

It is critical that the Fourier restriction S_t enters in, for otherwise the Besicovitch set would provide a counterexample, as we indicate in the first section of Chapter 2. This is one point at which the difference between the maximal function and the Hilbert transform is striking. The maximal function variant of the estimate above holds, and is relatively easy to prove, yet the Theorem above contains Carleson's Theorem on the pointwise convergence of Fourier series as a Corollary.

The weak L^2 estimate is sharp for measurable vector fields, and so we raise the conjecture

Conjecture 1.16. *There is a universal constant K for which we have the inequalities*

$$(1.17) \quad \sup_{0 < t < \|v\|_{\text{Lip}}} \|H_{v,\epsilon} \circ S_t\|_{2 \rightarrow 2} < \infty,$$

where $\epsilon = \|v\|_{\text{Lip}}/K$.

Modern proofs of the pointwise convergence of Fourier series use the so-called *restricted weak type approach*, invented by Muscalu, Tao and Thiele in [21]. This method uses refinements of the weak L^2 estimates, together with appropriate maximal function estimates, to derive L^p inequalities, for $1 < p < 2$. In the case of Theorem 1.15—for which this approach can not possibly work—the appropriate maximal function is the maximal function over all possible line segments. This is the unbounded Kakeya Maximal function for rectangles with zero eccentricity. One might suspect that in the Lipschitz case, there is a bounded maximal function. This is another motivation for our Lipschitz Kakeya Maximal Function, and our main Conjecture 1.12. We illustrate how these issues play out in our current setting, with this conditional result, one of the main results of this memoir.

Theorem 1.18. *Assume that Conjecture 1.14 holds for a choice of Lipschitz vector field v . Then we have the inequalities*

$$(1.19) \quad \|H_{v,\epsilon} \circ S_t\|_2 \lesssim 1, \quad 0 < t < \|v\|_{\text{Lip}}.$$

Here, ϵ is as in (1.17). Moreover, if the vector field has $1+\eta$ derivatives, we have the estimate

$$(1.20) \quad \|H_{v,\epsilon}\|_2 \lesssim (1 + \log\|v\|_{C^{1+\eta}})^2.$$

In this case, $\epsilon = K/\|v\|_{C^{1+\eta}}$ and $\eta > 0$.

While this is a conditional result, we shall see that it sheds new light on prior results, such as one of Bourgain [3] on real analytic vector fields. See Proposition 3.30, and the discussion of that Proposition.

The authors are not aware of any conceptual obstacles to the following extension of the Theorem above to be true, namely that one can establish L^p estimates, for all $p > 2$. As our argument currently stands, we could only prove this result for p sufficiently close to 2, because of our currently crude understanding of the underlying orthogonality arguments.

Conjecture 1.21. *Assume that Conjecture 1.14 holds for a choice of vector field v with $1 + \eta > 1$ derivatives, then we have the inequalities below*

$$(1.22) \quad \|H_{v,\epsilon}\|_p \lesssim (1 + \log\|v\|_{C^{1+\eta}})^2, \quad 2 < p < \infty.$$

In this case, $\epsilon = K/\|v\|_{C^{1+\eta}}$.

For a brief remark on what is required to prove this conjecture, see Remark 4.65.

The results of Christ, Nagel, Stein and Wainger [7] apply to certain vector fields v . This work is a beautiful culmination of the ‘geometric’ approach to questions concerning the boundedness of Radon transforms. Earlier, a positive result for analytic vector fields followed from Nagel, Stein and Wainger [22]. E.M. Stein [25] specifically raised the question of the boundedness of H_v for smooth vector fields v . And the results of D. Phong and Stein [23, 24] also give results about H_v . J. Bourgain [3] considered real-analytic vector field. N. H. Katz [13] has made an interesting contribution to maximal function question. Also see the partial results of Carbery, Seeger, Wainger and Wright [5].

CHAPTER 2

Connections to Besicovitch Set and Carleson's Theorem

Besicovitch Set

The Besicovitch set is a compact set that contains a line segment of unit length in each direction in the plane. Anomalous constructions of such sets show that they can have very small measure. Indeed, given $\epsilon > 0$ one can select rectangles R_1, \dots, R_n , with disjoint eccentricities, $|\text{EX}(R)| \simeq n^{-1}$, and of unit length, so that $|B| \leq \epsilon$ for $B := \bigcup_{j=1}^n R_j$. On the other hand, letting $e_j \in \text{EX}(R_j)$, one has that the rectangles $R_j + e_j$ are essentially disjoint. See Figure 2.1. Call the ‘reach’ of the Besicovitch set

$$\text{Reach} := \bigcup_{j=1}^n R_j + e_j.$$

This set has measure about one. On the Reach, one can define a vector field with points to a line segment contained in the Besicovitch set. Clearly, one has

$$|\mathbf{H}_v \mathbf{1}_B(x)| \simeq 1, \quad x \in \text{Reach}.$$

Further, constructions of this set permit one to take the vector field to be Lipschitz continuous of any index strictly less than one. And conversely, if one considers a Besicovitch set associated to a vector field of sufficiently small Lipschitz norm, of index one, the corresponding Besicovitch set must have large measure. Thus, Lipschitz estimates are critical.

The Kakeya Maximal Function

The Kakeya maximal function is typically defined as

$$(2.1) \quad \mathbf{M}_{K,\epsilon} f(x) := \sup_{|\text{EX}(R)| \geq \epsilon} \frac{\mathbf{1}_R(x)}{|R|} \int_R |f(y)| dy, \quad \epsilon > 0.$$

One is forced to take $\epsilon > 0$ due to the existence of the Besicovitch set. It is a critical fact that the norm of this operator admits a norm bound on L^2 that is logarithmic in ϵ . See Córdoba and Fefferman [8], and

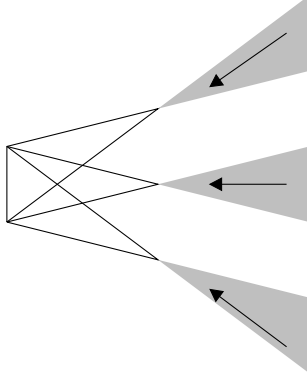

FIGURE 2.1. A Besicovitch Set on the left, and its Reach on the right.

Strömberg [27, 28]. Subsequently, there have been several refinements of this observation, we cite only Nets H. Katz [12], Alfonseca, Soria and Vargas [1], and Alfonseca [2]. These papers contain additional references. For the L^2 norm, the following is the sharp result.

Theorem 2.2. *We have the estimate below valid for all $0 < \epsilon < 1$.*

$$\|M_{K,\epsilon}\|_{2 \rightarrow 2} \lesssim 1 + \log 1/\epsilon.$$

The standard example of taking f to be the indicator of a small disk show that the estimate above is sharp, and that the norm grows as an inverse power of ϵ for $1 < p < 2$.

Carleson's Theorem

We explain the connection between the Hilbert transform on vector fields and Carleson's Theorem on the pointwise convergence of Fourier series. Since smooth functions have a convergent Fourier expansion, the main point of Carleson's Theorem is to provide for the control of an appropriate maximal function. We recall that maximal function in this Theorem.

Carleson's Theorem 2.3. *For all measurable functions $N : \mathbb{R} \rightarrow \mathbb{R}$, the operator below maps L^2 into itself.*

$$\mathcal{C}_N f(x) := \text{p.v.} \int e^{iN(x)y} f(x-y) \frac{dy}{y}.$$

The implied operator norm is independent of the choice of measurable $N(x)$.

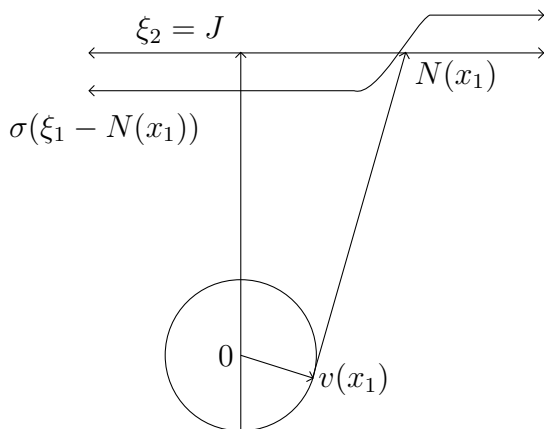

FIGURE 2.2. Deducing Carleson's Theorem from Stein's Conjecture.

For fixed function f , an appropriate choice of N will give us

$$\sup_N \left| \text{p.v.} \int e^{iNy} f(x-y) \frac{dy}{y} \right| \lesssim |\mathcal{C}_N f(x)|.$$

Thus, in the Theorem above we have simply linearized the supremum. Also, we have stated the Theorem with the un-truncated integral. The content of the Theorem is unchanged if we make a truncation of the integral, which we will do below.

Let us now show how to deduce this Theorem from an appropriate bound on certain bound on Hilbert transforms on vector fields. (This observation is apparently due to R. Coifman from the 1970's.)

Proposition 2.4. *Assume that we have, say, the bound*

$$\|\mathbf{H}_{v,1}\|_{2 \rightarrow 2} \lesssim 1,$$

assuming that $\|v\|_{C^2} \leq 1$. It follows that the Carleson maximal operator is bounded on $L^2(\mathbb{R})$.

PROOF. The Proposition and the proof are only given in their most obvious formulation. Set $\sigma(\xi) = \int_{-1}^1 e^{i\xi y} \frac{dy}{y}$. For a C^2 function $N : \mathbb{R} \rightarrow \mathbb{R}$ we deduce that the operator with symbol $\sigma(\xi - N(x))$ maps $L^2(\mathbb{R})$ into itself with norm that is independent of the C^2 norm of the function $N(x)$. A standard limiting argument then permits one to conclude the same bound for all measurable choices of $N(x)$, as is required for the deduction of Carleson's inequality.

This argument is indicated in Figure 2.2. Take the vector field to be $v(x_1, x_2) = (1, -N(x_1)/n)$ where n is chosen much larger than the

C^2 norm of the function $N(x_1)$. Then, $H_{v,1}$ is bounded on $L^2(\mathbb{R}^2)$ with norm bounded by an absolute constant. The symbol of $H_{v,1}$ is

$$\sigma(\xi_1, \xi_2) = \sigma(\xi_1 - \xi_2 N(x_1)/n).$$

The trace of this symbol along the line $\xi_2 = J$ defines a symbol of a bounded operator on $L^2(\mathbb{R})$. Taking J very large, we obtain a very good approximation to symbol $\sigma(\xi_1 - \xi_2 N(x_1)/n)$, deducing that it maps $L^2(\mathbb{R})$ into itself with a bounded constant. Our proof is complete. \square

The Weak L^2 Estimate in Theorem 1.15 is Sharp

An example shows that under the assumption that the vector field is measurable, the sharp conclusion is that $H_v \circ S_1$ maps L^2 into $L^{2,\infty}$. And a variant of the approach to Carleson's theorem by Lacey and Thiele [20] will prove this norm inequality. This method will also show, under only the measurability assumption, that $H_v S_1$ maps L^p into itself for $p > 2$, as is shown by the current authors [15]. The results and techniques of that paper are critical to this one.

CHAPTER 3

The Lipschitz Keakeya Maximal Function

The Weak L^2 Estimate

We prove Theorem 1.10, the weak L^2 estimate for the maximal function defined in (1.9), by suitably adapting classical covering lemma arguments.

The Covering Lemma Conditions. We adopt the covering lemma approach of Córdoba and R. Fefferman [8]. To this end, we regard the choice of vector field v and $0 < \delta < 1$ as fixed. Let \mathcal{R} be any finite collection of rectangles obeying the conditions (1.8) and $|\mathbf{V}(R)| \geq \delta|R|$. We show that \mathcal{R} has a decomposition into disjoint collections \mathcal{R}' and \mathcal{R}'' for which these estimates hold.

$$(3.1) \quad \left\| \sum_{R \in \mathcal{R}'} \mathbf{1}_R \right\|_2^2 \lesssim \delta^{-1} \left\| \sum_{R \in \mathcal{R}'} \mathbf{1}_R \right\|_1,$$

$$(3.2) \quad \left| \bigcup_{R \in \mathcal{R}''} R \right| \lesssim \left\| \sum_{R \in \mathcal{R}'} \mathbf{1}_R \right\|_1$$

The first of these conditions is the stronger one, as it bounds the L^2 norm squared by the L^1 norm; the verification of it will occupy most of the proof.

Let us see how to deduce Theorem 1.10. Take $\lambda > 0$ and $f \in L^2$ which is non negative and of norm one. Set \mathcal{R} to be all the rectangles R of prescribed maximum length as given in (1.8), density with respect to the vector field, namely $|\mathbf{V}(R)| \geq \delta|R|$, and

$$\int_R f(y) dy \geq \lambda|R|.$$

We should verify the weak type inequality

$$(3.3) \quad \lambda \left| \bigcup_{R \in \mathcal{R}} R \right|^{1/2} \lesssim \delta^{-1/2}.$$

Apply the decomposition to \mathcal{R} . Observe that

$$\begin{aligned} \lambda \left\| \sum_{R \in \mathcal{R}'} \mathbf{1}_R \right\|_1 &\leq \left\langle f, \sum_{R \in \mathcal{R}'} \mathbf{1}_R \right\rangle \\ &\leq \left\| \sum_{R \in \mathcal{R}'} \mathbf{1}_R \right\|_2 \\ &\lesssim \delta^{-1/2} \left\| \sum_{R \in \mathcal{R}'} \mathbf{1}_R \right\|_1^{1/2}. \end{aligned}$$

Here of course we have used (3.1). This implies that

$$\lambda \left\| \sum_{R \in \mathcal{R}'} \mathbf{1}_R \right\|_1^{1/2} \lesssim \delta^{-1/2}.$$

Therefore clearly (3.3) holds for the collection \mathcal{R}' .

Concerning the collection \mathcal{R}'' , apply (3.2) to see that

$$\lambda \left| \bigcup_{R \in \mathcal{R}''} R \right|^{1/2} \lesssim \lambda \left\| \sum_{R \in \mathcal{R}'} \mathbf{1}_R \right\|_1^{1/2} \lesssim \delta^{-1/2}.$$

This completes our proof of (3.3).

The remainder of the proof is devoted to the proof of (3.1) and (3.2).

The Covering Lemma Estimates.

Construction of \mathcal{R}' and \mathcal{R}'' . In the course of the proof, we will need several recursive procedures. The first of these occurs in the selection of \mathcal{R}' and \mathcal{R}'' .

We will have need of one large constant κ , of the order of say 100, but whose exact value does not concern us. Using this notation hides distracting terms.

Let M_κ be a maximal function given as

$$M_\kappa f(x) = \sup_{s>0} \max \left\{ s^{-2} \int_{x+sQ} |f(y)| dy, \sup_{\omega \in \Omega} s^{-1} \int_{-s}^s |f(x + \sigma\omega)| d\sigma \right\}.$$

Here, Q is the unit square in plane, and Ω is a set of uniformly distributed points on the unit circle of cardinality equal to κ . It follows from the usual weak type bounds that this operator maps $L^1(\mathbb{R}^2)$ into weak $L^1(\mathbb{R}^2)$.

To initialize the recursive procedure, set

$$\begin{aligned} \mathcal{R}' &\leftarrow \emptyset, \\ \text{STOCK} &\leftarrow \mathcal{R}. \end{aligned}$$

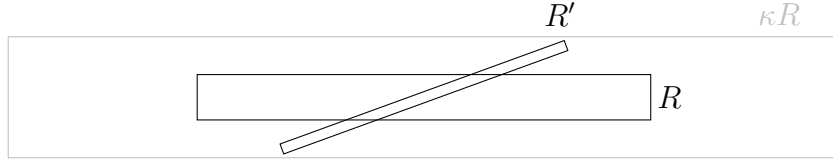

FIGURE 3.1. The rectangle R' would have been removed from **STOCK** upon the selection of R as a member of \mathcal{R}' .

The main step is this while loop. While **STOCK** is not empty, select $R \in \mathbf{STOCK}$ subject to the criteria that first it have a maximal length $L(R)$, and second that it have minimal value of $|\mathbf{EX}(R)|$. Update

$$\mathcal{R}' \leftarrow \mathcal{R}' \cup \{R\}.$$

Remove R from **STOCK**. As well, remove any rectangle $R' \in \mathbf{STOCK}$ which is also contained in

$$\left\{ M_\kappa \sum_{R \in \mathcal{R}'} \mathbf{1}_{\kappa R} \geq \kappa^{-1} \right\}.$$

As the collection \mathcal{R} is finite, the while loop will terminate, and at this point we set $\mathcal{R}'' \stackrel{\text{def}}{=} \mathcal{R} - \mathcal{R}'$. In the course of the argument below, we will refer the order in which rectangles were added to \mathcal{R}' .

With this construction, it is obvious that (3.3) holds, with a bound that is a function of κ . Yet, κ is an absolute constant, so this dependence does not concern us. And so the rest of the proof is devoted to the verification of (3.1).

An important aspect of the qualitative nature of the interval of eccentricity is encoded into this algorithm. We will choose κ so large that this is true: Consider two rectangles R and R' with $R \cap R' \neq \emptyset$, $L(R) \geq L(R')$, $W(R) \geq W(R')$, $|\mathbf{EX}(R)| \leq |\mathbf{EX}(R')|$ and $\mathbf{EX}(R) \subset 10 \mathbf{EX}(R')$ then we have

$$(3.4) \quad R' \subset \kappa R.$$

See Figure 3.1.

Uniform Estimates. We estimate the left hand side of (3.1). In so doing we expand the square, and seek certain uniform estimates.

Expanding the square on the left hand side of (3.1), we can estimate

$$\text{l.h.s. of (3.1)} \leq \sum_{R \in \mathcal{R}'} |R| + 2 \sum_{(\rho, R) \in \mathcal{P}} |\rho \cap R|$$

where \mathcal{P} consists of all pairs $(\rho, R) \in \mathcal{R}' \times \mathcal{R}'$ such that $\rho \cap R \neq \emptyset$, and ρ was selected to be a member of \mathcal{R}' before R was. It is then automatic that $L(R) \leq L(\rho)$. And since the density of all tiles is positive, it follows that $\text{dist}(\text{EX}(\rho), \text{EX}(R)) \leq 2\|v\|_{\text{Lip}}L(\rho) < \frac{1}{50}$.

We will split up the collection \mathcal{P} into sub-collections $\{\mathcal{S}_R : R \in \mathcal{R}'\}$ and $\{\mathcal{T}_\rho : \rho \in \mathcal{R}'\}$.

For a rectangle $R \in \mathcal{R}'$, we take \mathcal{S}_R to consist of all rectangles ρ such that (a) $(\rho, R) \in \mathcal{P}$; and (b) $\text{EX}(\rho) \subset 10\text{EX}(R)$. We assert that

$$(3.5) \quad \sum_{\rho \in \mathcal{S}_R} |R \cap \rho| \leq |R|, \quad R \in \mathcal{R}.$$

This estimate is in fact easily available to us. Since the rectangles $\rho \in \mathcal{S}_R$ were selected to be in \mathcal{R}' before R was, we cannot have the inclusion

$$(3.6) \quad R \subset \left\{ M_\kappa \sum_{\rho \in \mathcal{S}_R} \mathbf{1}_{\kappa\rho} > \kappa^{-1} \right\}.$$

Now the rectangle ρ are also longer. Thus, if (3.5) does not hold, we would compute the maximal function of

$$\sum_{\rho \in \mathcal{S}_R} \mathbf{1}_{\kappa\rho}$$

in a direction which is close, within an error of $2\pi/\kappa$, of being orthogonal to the long direction of R . In this way, we will contradict (3.6).

The second uniform estimate that we need is as follows. For fixed ρ , set \mathcal{T}_ρ to be the set of all rectangles R such that (a) $(\rho, R) \in \mathcal{P}$ and (b) $\text{EX}(\rho) \not\subset 10\text{EX}(R)$. We assert that

$$(3.7) \quad \sum_{R \in \mathcal{T}_\rho} |R \cap \rho| \lesssim \delta^{-1}|\rho|, \quad \rho \in \mathcal{R}'.$$

This proof of this inequality is more involved, and taken up in the next subsection.

Remark 3.8. In the proof of (3.7), it is not necessary that $\rho \in \mathcal{R}'$. Writing $\rho = I_\rho \times J_\rho$, in the coordinate basis e and e_\perp , we could take any rectangle of the form $I \times J_\rho$.

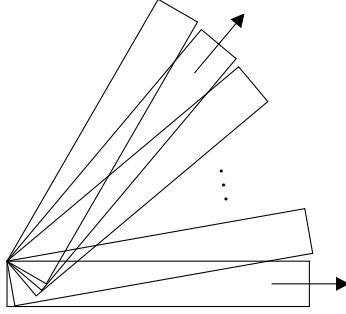

FIGURE 3.2. Proof of Lemma 3.9

These two estimates conclude the proof of (3.1). For any two distinct rectangles $\rho, R \in \mathcal{P}$, we will have either $\rho \in \mathcal{S}_R$ or $R \in \mathcal{T}_\rho$. Thus (3.1) follows by summing (3.5) on R and (3.7) on ρ .

The Proof of (3.7). We do not need this Lemma for the proof of (3.7), but this is the most convenient place to prove it.

Lemma 3.9. *Let \mathcal{S} be any finite collection of rectangles with $\mathbf{L}(R) \leq 2\mathbf{L}(R')$, and with $|\mathbf{V}(R)| \geq \delta|R|$ for all $R, R' \in \mathcal{S}$. Then it is the case that*

$$(3.10) \quad \left\| \sum_{R \in \mathcal{S}} \mathbf{1}_R \right\|_\infty \leq 2\delta^{-1}.$$

PROOF. Fix a point x at which we give an upper bound on the sum above. Let $C(x)$ be any circle centered at x . We shall show that there exists at most one R in \mathcal{S} such that $\mathbf{V}(R) \cap C(x) \neq \emptyset$. By the assumption $|\mathbf{V}(R)| \geq \delta|R|$ this proves the Lemma.

We prove this last claim by contradiction of the Lipschitz assumption on the vector field v . Assume that there exist at least two rectangles $R, R' \in \mathcal{S}$ for which the sets $\mathbf{V}(R)$ and $\mathbf{V}(R')$ intersect $C(x)$. Thus there exist y and y' in $C(x)$ such that $v(y) \in \mathbf{EX}(R)$ and $v(y') \in \mathbf{EX}(R')$. Since v is Lipschitz, we have

$$\begin{aligned} |v(y) - v(y')| &\leq \|v\|_{\text{Lip}}|y - y'| \\ &\leq 4\|v\|_{\text{Lip}}\mathbf{L}(R)|v(y) - v(y')|, \end{aligned}$$

but this is a contradiction to our assumption (1.8). See Figure 3.2. \square

We fix ρ , and begin by making a decomposition of the collection \mathcal{T}_ρ . Suppose that the coordinate axes for ρ are given by e_ρ , associated with the long side of R , and e_ρ^\perp , with the short side. Write the rectangle as a product of intervals $I_\rho \times J$, where $|I_\rho| = \mathbf{L}(\rho)$. Denote one of the endpoints of J as α . See Figure 3.3.

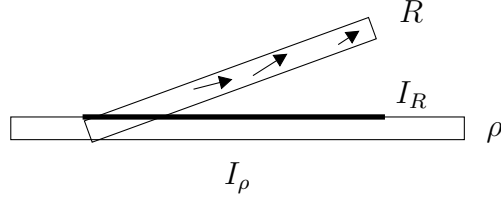

FIGURE 3.3. Notation for the proof of (3.7).

For rectangles $R \in \mathcal{T}_\rho$, let I_R denote the orthogonal projection R onto the line segment $2I_\rho \times \{\alpha\}$. Subsequently, we will consider different subsets of this line segment. The first of these is as follows. For $R \in \mathcal{T}_\rho$, let \mathbf{V}_R be the projection of the set $\mathbf{V}(R)$ onto $2I_\rho \times \{\alpha\}$. The angle θ between ρ and R is at most $|\theta| \leq 2\|v\|_{\text{Lip}} \mathbf{L}(\rho) \leq \frac{1}{50}$. It follows that

$$(3.11) \quad \frac{1}{2} \mathbf{L}(R) \leq |I_R| \leq 2 \mathbf{L}(R), \quad \text{and} \quad \delta \mathbf{L}(R) \lesssim |\mathbf{V}_R|.$$

A recursive mechanism is used to decompose \mathcal{T}_ρ . Initialize

$$\begin{aligned} \text{STOCK} &\leftarrow \mathcal{T}_\rho, \\ \mathcal{U} &\leftarrow \emptyset. \end{aligned}$$

While $\text{STOCK} \neq \emptyset$ select $R \in \text{STOCK}$ of maximal length. Update

$$(3.12) \quad \begin{aligned} \mathcal{U} &\leftarrow \mathcal{U} \cup \{R\}, \\ \mathcal{U}(R) &\leftarrow \{R' \in \text{STOCK} : \mathbf{V}_R \cap \mathbf{V}_{R'} \neq \emptyset\}. \\ \text{STOCK} &\leftarrow \text{STOCK} - \mathcal{U}(R). \end{aligned}$$

When this while loop stops, it is the case that $\mathcal{T}_\rho = \bigcup_{R \in \mathcal{U}} \mathcal{U}(R)$.

With this construction, the sets $\{\mathbf{V}_R : R \in \mathcal{U}\}$ are disjoint. By (3.11), we have

$$(3.13) \quad \sum_{R \in \mathcal{U}} \mathbf{L}(R) \lesssim \delta^{-1} \mathbf{L}(\rho).$$

The main point, is then to verify the uniform estimate

$$(3.14) \quad \sum_{R' \in \mathcal{U}(R)} |R' \cap \rho| \lesssim \mathbf{L}(R) \cdot \mathbf{W}(\rho), \quad R \in \mathcal{U}.$$

Note that both estimates immediately imply (3.7).

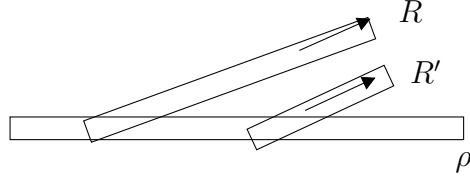

FIGURE 3.4. Proof of Lemma 3.15: The rectangles $R, R' \in \mathcal{U}(\rho)$, and so the angles R and R' form with ρ are nearly the same.

Proof of (3.14). There are three important, and more technical, facts to observe about the collections $\mathcal{U}(R)$.

For any rectangle $R' \in \mathcal{U}(R)$, denote its coordinate axes as $e_{R'}$ and $e_{R'}^\perp$, associated to the long and short sides of R' respectively.

Lemma 3.15. *For any rectangle $R' \in \mathcal{U}(R)$ we have*

$$|e_{R'} - e_R| \leq \frac{1}{2}|e_\rho - e_R|$$

PROOF. There are by construction, points $x \in \mathbf{V}(R)$ and $x' \in \mathbf{V}(R')$ which get projected to the same point on the line segment $I_\rho \times \{\alpha\}$. See Figure 3.4. Observe that

$$\begin{aligned} |e_{R'} - e_R| &\leq |\mathbf{EX}(R')| + |\mathbf{EX}(R)| + |v(x') - v(x)| \\ &\leq |\mathbf{EX}(R')| + |\mathbf{EX}(R)| + \|v\|_{\text{Lip}} \cdot \mathbf{L}(R) \cdot |e_\rho - e_R| \\ &\leq |\mathbf{EX}(R')| + |\mathbf{EX}(R)| + \frac{1}{100}|e_\rho - e_R| \end{aligned}$$

Now, $|\mathbf{EX}(R)| \leq \frac{1}{5}|e_\rho - e_R|$, else we would have $\rho \in \mathcal{S}_R$. Likewise, $|\mathbf{EX}(R')| \leq \frac{1}{5}|e_{R'} - e_R|$. And this proves the desired inequality. \square

Lemma 3.16. *Suppose that there is an interval $I \subset I_\rho$ such that*

$$(3.17) \quad \sum_{\substack{R' \in \mathcal{U}(R) \\ \mathbf{L}(R') \geq 8|I|}} |R' \cap I \times J| \geq |I \times J|.$$

Then there is no $R'' \in \mathcal{U}(R)$ such that $\mathbf{L}(R'') < |I|$ and $R'' \cap 4I \times J \neq \emptyset$.

PROOF. There is a natural angle θ between the rectangles ρ and R , which we can assume is positive, and is given by $|e_\rho - e_R|$. Notice that we have $\theta \geq 10|\mathbf{EX}(R)|$, else we would have $\rho \in \mathcal{S}_R$, which contradicts our construction.

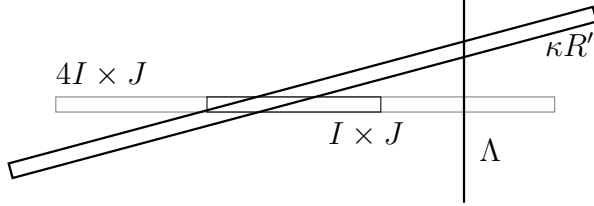

FIGURE 3.5.

Moreover, there is an important consequence of Lemma 3.15: For any $R' \in \mathcal{U}(R)$, there is a natural angle θ' between R' and ρ . These two angles are close. For our purposes below, these two angles can be regarded as the same.

For any $R' \in \mathcal{U}(R)$, we will have

$$\begin{aligned} \frac{|\kappa R' \cap \rho|}{|I \times J|} &\simeq \kappa \frac{\mathbf{W}(R') \cdot \mathbf{W}(\rho)}{\theta |I| \mathbf{W}(\rho)} \\ &= \kappa \frac{\mathbf{W}(R')}{\theta \cdot |I|}. \end{aligned}$$

Recall M_κ is larger than the maximal function over κ uniformly distributed directions. Choose a direction e' from this set of κ directions that is closest to e_ρ^\perp . Take a line segment Λ in direction e' of length $\kappa\theta|I|$, and the center of Λ is in $4I \times J$. See Figure 3.5. Then we have

$$\frac{|\kappa R' \cap \Lambda|}{|\Lambda|} \geq \frac{\mathbf{W}(R')}{\theta \cdot |I|}$$

Thus by our assumption (3.17),

$$\frac{1}{|\Lambda|} \sum_{R' \in \mathcal{U}(R)} |\kappa R' \cap \Lambda| \gtrsim 1.$$

That is, any of the lines Λ are contained in the set

$$\left\{ M_\kappa \sum_{R \in \mathcal{R}'} \mathbf{1}_{\kappa R'} > \kappa^{-1} \right\}.$$

Clearly our construction does not permit any rectangle $R'' \in \mathcal{U}(R)$ contained in this set. To conclude the proof of our Lemma, we seek a contradiction. Suppose that there is an $R'' \in \mathcal{U}(R)$ with $\mathbf{L}(R'') < |I|$ and R'' intersects $2I \times J$. The range of line segments Λ we can permit

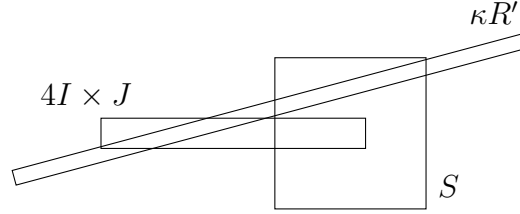

FIGURE 3.6. The proof of Lemma 3.18

is however quite broad. The only possibility permitted to us is that the rectangle R'' is quite wide. We must have

$$\mathbf{W}(R'') \geq \frac{1}{4}|\Lambda| = \frac{\kappa}{4} \cdot \theta \cdot |I|.$$

This however forces us to have $|\text{EX}(R'')| \geq \frac{\kappa}{4}\theta$. And this implies that $\rho \in \mathcal{S}_{R''}$, as in (3.5). This is the desired contradiction. \square

Our third and final fact about the collection $\mathcal{U}(R)$ is a consequence of Lemma 3.15 and a geometric observation of J.-O. Stromberg [27, Lemma 2, p. 400].

Lemma 3.18. *For any interval $I \subset I_R$ we have the inequality*

$$(3.19) \quad \sum_{\substack{R' \in \mathcal{U}(R) \\ \mathbf{L}(R') \leq |I| \leq \sqrt{\kappa} \mathbf{L}(R')}} |R' \cap I \times J| \leq 5|I| \cdot \mathbf{W}(\rho).$$

PROOF. For each point $x \in 4I \times J$, consider the square S centered at x of side length equal to $\sqrt{\kappa} \cdot |I| \cdot |e_R - e_\rho|$. See Figure 3.6. It is Stromberg's observation that for $R' \in \mathcal{U}(R)$ we have

$$\frac{|\kappa R' \cap I \times J|}{|I \times J|} \simeq \frac{|S \cap \kappa R'|}{|S|}$$

with the implied constant independent of κ . Indeed, by Lemma 3.15, we have that

$$\begin{aligned} \frac{|\kappa R' \cap I \times J|}{|I \times J|} &\simeq \frac{\kappa \mathbf{W}(R')}{|e_R - e_\rho| \cdot |I|} \\ &\simeq \frac{\kappa \mathbf{W}(R') \cdot |I| \cdot |e_R - e_\rho|}{(|e_R - e_\rho| \cdot |I|)^2} \\ &\simeq \frac{|S \cap \kappa R'|}{|S|}, \end{aligned}$$

as claimed.

Now, assume that (3.19) does not hold and seek a contradiction. Let $\mathcal{U}' \subset \mathcal{U}(R)$ denote the collection of rectangles R' over which the sum is made in (3.19). The rectangles in \mathcal{U}' were added in some order to the collection \mathcal{R}' , and in particular there is a rectangle $R_0 \in \mathcal{U}'$ that was the last to be added to \mathcal{U}' . Let \mathcal{U}'' be the collection $\mathcal{U}' - \{R_0\}$. We certainly have

$$\sum_{R' \in \mathcal{U}''} |R' \cap I \times J| \geq 4|I \times J|.$$

Since we cannot have $\rho \in \mathcal{S}_{R_0}$, Stromberg's observation implies that

$$R_0 \subset \left\{ M_\kappa \sum_{R' \in \mathcal{U}''} \mathbf{1}_{\kappa R'} > \kappa^{-1} \right\}.$$

Here, we rely upon the fact that the maximal function M_κ is larger than the usual maximal function over squares. But this is a contradiction to our construction, and so the proof is complete. \square

The principal line of reasoning to prove (3.14) can now begin with it's initial recursive procedure. Initialize

$$C(R') \leftarrow R' \cap \rho.$$

We are to bound the sum $\sum_{R' \in \mathcal{U}(R)} |C(R')|$. Initialize a collection of subintervals of I_R to be

$$\mathcal{I} \leftarrow \emptyset$$

WHILE there is an interval $I \subset I_R$ satisfying

$$(3.20) \quad \sum_{R' \in \mathcal{V}(I)} |C(R') \cap I \times J| \geq 40|I| \cdot \mathbf{W}(\rho),$$

$$(3.21) \quad \mathcal{V}(I) = \{R' \in \mathcal{U}(R) \mid |C(R') \cap I \times J| \neq \emptyset, \mathbf{L}(R') \geq 8|I|\},$$

we take I to be an interval of maximal length with this property, and update

$$\mathcal{I} \leftarrow \mathcal{I} \cup \{I\};$$

$$C(R', I) = C(R') \cap I \times J, \quad R' \in \mathcal{V}(I);$$

$$C(R') \leftarrow C(R') - I \times J, \quad R' \in \mathcal{V}(I).$$

[We remark that this last updating is not needed in the most important special case when all rectangles have the same width. But the case we are considering, rectangles can have variable widths, so that $|C(R)|$ can be much larger than any $|I| \cdot |J|$ that would arise from this algorithm.]

Once the WHILE loop stops, we have

$$R' \cap \rho = C(R') \cup \bigcup \{C(R', I) \mid I \in \mathcal{I}, R' \in \mathcal{V}(I)\}.$$

Here the union is over pairwise disjoint sets.

We first consider the collection of sets $\{C(R') \mid R' \in \mathcal{U}(R)\}$ that remain after the **WHILE** loop has finished. Since we must not have $R' \subset 1/4\kappa \cdot \rho$, it follows that the minimum value of $\mathsf{L}(R')$ is $\frac{1}{32} \mathsf{W}(\rho)$. Thus, if in (3.20), we consider an interval I of length $\frac{1}{256} \mathsf{W}(\rho)$, the condition $\mathsf{L}(R') \geq 8|I|$ in the definition of $\mathcal{V}(I)$ in (3.21) is vacuous. Thus, we necessarily have

$$\sum_{R' \in \mathcal{V}(I)} |C(R') \cap I \times J| \leq 40|I| \cdot \mathsf{W}(\rho).$$

For if this inequality failed, the **WHILE** loop would not have stopped. We can partition I_R by intervals of length close to $\frac{1}{256} \mathsf{W}(\rho)$, showing that we have

$$\sum_{R' \in \mathcal{U}(R)} |C(R')| \lesssim |I_R| \cdot \mathsf{W}(\rho).$$

Turning to the central components of the argument, namely the bound for the terms associated with the intervals in \mathcal{I} , consider $I \in \mathcal{I}$. The inequality (3.20) and Lemma 3.18 implies that each $I \in \mathcal{I}$ must have length $|I| \leq \kappa^{-1/2}|I_\rho|$. But we choose intervals in I to be of maximal length. Thus,

$$(3.22) \quad \sum_{R' \in \mathcal{V}(I)} |C(R', I)| \leq 100 \cdot |I| \cdot \mathsf{W}(\rho).$$

Indeed, suppose this last inequality fails. Let $I \subset \tilde{I} \subset I_\rho$ be an interval twice as long as I . By Lemma 3.18, we conclude that

$$\sum_{\substack{R' \in \mathcal{V}(I) \\ \mathsf{L}(R') \leq 8|\tilde{I}|}} |R' \cap \tilde{I} \times J| \leq 10|I| \cdot \mathsf{W}(\rho).$$

Notice that we are restricting the sum on the left by the length of $|\tilde{I}|$. Therefore, we have the inequalities

$$\sum_{\substack{R' \in \mathcal{V}(I) \\ \mathsf{L}(R') > 8|\tilde{I}|}} |C(R', I)| \geq 90 \cdot |I| \cdot \mathsf{W}(\rho) > 40 \cdot |\tilde{I}| \cdot \mathsf{W}(\rho).$$

That is, \tilde{I} would have been selected, contradicting our construction.

Lemmas 3.16 and 3.18 place significant restrictions on the collection of intervals \mathcal{I} . If we have $I \neq I' \in \mathcal{I}$ with $\frac{3}{2}I \cap \frac{3}{2}I' \neq \emptyset$, then we must have e.g. $\sqrt{\kappa}|I'| < |I|$, as follows from Lemma 3.18. Moreover, $\mathcal{V}(I')$ must contain a rectangle R' with $\mathsf{L}(R') < |I|$. But this contradicts Lemma 3.16.

Therefore, we must have

$$\sum_{I \in \mathcal{I}} |I| \lesssim |I_R| \lesssim \mathbf{L}(R).$$

With (3.22), this completes the proof of (3.14).

An Obstacle to an L^p estimate, for $1 < p < 2$

We address one of the main conjectures of this memoir, namely Conjecture 1.12. Let us first observe

Proposition 3.23. *We have the estimate below valid for all $0 < w < \|v\|_{\text{Lip}}$.*

$$\sup_{\lambda > 0} \lambda |\{M_{v,w} f > \lambda\}|^{2/3} \lesssim \delta^{-1/3} (1 + \log w^{-1} \|v\|_{\text{Lip}})^{1/3} \|f\|_{3/2}$$

PROOF. Let $\|v\|_{\text{Lip}} = 1$. This just relies upon the fact that with $0 < w < \frac{1}{2}$ fixed, there are only about $\log 1/w$ possible values of $\mathbf{L}(R)$. This leads very easily to the following two estimates. Following the earlier argument, consider an arbitrary collection of rectangles \mathcal{R} with each $R \in \mathcal{R}$ satisfying (1.8) and $|\mathbf{V}(R)| \geq \delta |R|$. We can then decompose \mathcal{R} into disjoint collections \mathcal{R}' and \mathcal{R}'' for which these estimates hold.

$$(3.24) \quad \left\| \sum_{R \in \mathcal{R}'} \mathbf{1}_R \right\|_3^3 \lesssim \delta^{-1} (\log 1/w) \left\| \sum_{R \in \mathcal{R}'} \mathbf{1}_R \right\|_1,$$

$$(3.25) \quad \left| \bigcup_{R \in \mathcal{R}''} R \right| \lesssim \left\| \sum_{R \in \mathcal{R}'} \mathbf{1}_R \right\|_1$$

Compare to (3.1) and (3.2). Following the same line of reasoning that was used to prove (3.3), we prove our Proposition. \square

We can devise proofs of smaller bounds on the norm of the maximal function than that given by this proposition. But no argument that we can find avoids the some logarithmic term in the width of the rectangle. Let us illustrate the difficulty in the estimate with an object pointed out to us by Ciprian Demeter. We term it a *pocketknife*, and it is pictured in Figure 3.7.

A pocketknife comes with a *handle*, namely a rectangle R_{handle} that is longer than any other rectangle in the pocketknife. We call a collection of rectangles \mathcal{B} a set of *blades* if these two conditions are met. In the first place,

$$(3.26) \quad R_{\text{handle}} \cap \bigcap_{R \in \mathcal{B}} R \neq \emptyset.$$

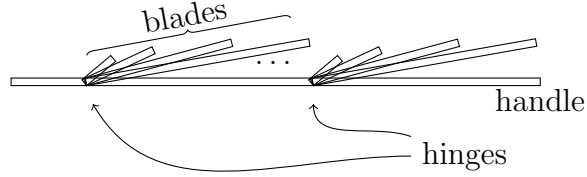
FIGURE 3.7. A *pocketknife*.

In the second place, we have

$$\text{angle}(R, R_{\text{handle}}) \simeq \text{angle}(R', R_{\text{handle}}), \quad R, R' \in \mathcal{B}.$$

Let $\theta(\mathcal{B})$ denote the angle between R_{handle} and the rectangles in the blade \mathcal{B} . We refer to as a *hinge* a rectangle of dimensions $w/\theta(\mathcal{B})$ by w , in the same coordinate system of R_{handle} that contains the intersection in (3.26).

Now, let \mathbb{B} be a collection of blades for the handle R_{handle} . Our proof of the weak L^2 estimate for the Lipschitz Keakeya Maximal function shows that we can assume

$$\sum_{\mathcal{B} \in \mathbb{B}} \#\mathcal{B} \cdot w^2 \cdot \theta(\mathcal{B})^{-1} \lesssim |R_{\text{handle}}|.$$

This is essentially the estimate (3.5).

But, to follow the covering lemma approach to the $L^{3/2}$ estimate for the maximal function, we need to control

$$\sum_{\mathcal{B} \in \mathbb{B}} (\#\mathcal{B})^2 \cdot w^2 \cdot \theta(\mathcal{B})^{-1}.$$

We can only find control of expressions of this type in terms of some slowly varying function of w^{-1} .

Bourgain's Geometric Condition

Jean Bourgain [3] gives a geometric condition on the Lipschitz vector field that is sufficient for the L^2 boundedness of the maximal function associated with v . We describe the condition, and show how it immediately proves that the corresponding Lipschitz Keakeya maximal function admits a weak type bound on L^1 . In particular our Conjecture 1.12 holds for these vector fields.

To motivate Bourgain's condition, let us recall the earlier condition considered by Nagel, Stein and Wainger in [22]. This condition imposes

a restriction on the maximum and minimum curvatures of the integral curves of the vector field through the assumption that

$$0 < \frac{\sup_{x \in \Omega} \det[\nabla v(x)v(x), v(x)]}{\inf_{x \in \Omega} \det[\nabla v(x)v(x), v(x)]} < \infty.$$

Here, Ω is a domain in \mathbb{R}^2 , and one can achieve an upper bound on the norm of the maximal function associated to v , appropriately restricted to Ω , in terms of this ratio.

Bourgain's condition permits the vector field to have integral curves which are flat. Suppose that v is defined on all of \mathbb{R}^2 . Define

$$(3.27) \quad \omega(x; t) := |\det[v(x + tv(x)), v(x)]|, \quad |t| \leq \frac{1}{2} \|v\|_{\text{Lip}}.$$

Assume a uniform estimate of the following type: For absolute constants $0 < c, C < \infty$ and $0 < \epsilon_0 < \frac{1}{2} \|v\|_{\text{Lip}}$,

$$(3.28) \quad |\{ |t| \leq \epsilon \mid \omega(x; t) < \tau \sup_{|s| \leq \epsilon} \omega(x, s) \}| \leq C\tau^c \epsilon,$$

this condition holding for all $x \in \mathbb{R}^2$, $0 < \tau < 1$ and $0 < \epsilon < \epsilon_0$.

The interest in this condition stems from the fact [3] that real-analytic vector fields satisfy it. Also see Remark 3.35. Bourgain proved:

Theorem 3.29. *Assume that (3.28) holds. Then, the maximal operator M_{v, ϵ_0} defined in (1.1) maps L^2 into itself.*

This paper claims that the same methods would prove the bounds

$$\|M_{v, \epsilon_0}\|_p \lesssim \|f\|_p, \quad 1 < p < \infty.$$

And suggests that similar methods would apply to the localized Hilbert transform with respect to these vector fields.

Here, we prove

Proposition 3.30. *Assume that (3.28) holds. Then, the Lipschitz Keakeya Maximal Functions*

$$M_{v, \delta, w}, \quad 0 < \delta < 1, \quad 0 < w < \epsilon_0$$

defined in (1.13) satisfy the weak L^1 estimate

$$\sup_{\lambda > 0} \lambda |\{M_{v, \delta, w} f > \lambda\}| \lesssim \delta^{-1} (1 + \log 1/\delta) \|f\|_1.$$

The implied constants depend upon the constants in (3.28).

That is, these vector fields easily fall within the scope of our analysis. As a corollary to Theorem 1.18, we see that H_v maps L^2 into itself.

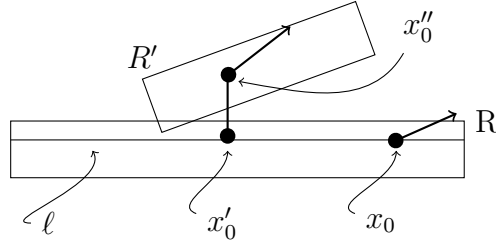

FIGURE 3.8. Proof of (3.31).

PROOF. Let us assume that $\|v\|_{\text{Lip}} = 1$. Fix $\delta > 0$ and $0 < w < \epsilon_0$. Let \mathcal{R} be the class of rectangles with $L(R) < \kappa$ and satisfying $|\mathbf{V}(R)| \geq \delta|R|$.

Say that $\mathcal{R}' \subset \mathcal{R}$ has *scales separated by $s > 3$* iff for $R, R' \in \mathcal{R}'$ the condition $4L(R) < L(R')$ implies that $2^s L(R) < L(R')$. One sees that \mathcal{R} can be decomposed into $\simeq s$ sub-collections with scales separated by s .

The fortunate observation is this: Assuming (3.28), and taking $s \simeq \log 1/\delta$, any subset $\mathcal{R}' \subset \mathcal{R}$ with scales separated by s further enjoys this property: If $R, R' \in \mathcal{R}'$ with $C \text{EX}(R) \cap C \text{EX}(R') = \emptyset$, with C a fixed constant, then

$$(3.31) \quad L(R) \simeq L(R') \quad \text{or} \quad R \cap R' = \emptyset.$$

Let us see why this is true, arguing by contradiction. Thus we assume that $L(R') \leq 2^{-s} L(R)$, $R \cap R' \neq \emptyset$ and $C \text{EX}(R) \cap C \text{EX}(R') = \emptyset$. Since the rectangles have an essentially fixed width, it follows that $2|\text{EX}(R')| \geq |\text{EX}(R)|$. Fix a line ℓ in the long direction of $2R$ with

$$|\{x \in \ell \mid v(x) \in \mathbf{V}(R)\}| \geq \frac{\delta}{2} |\ell| = \frac{\delta}{2} L(R).$$

Let x_0 be in the set above, $x'_0 \in \mathbf{V}(R')$ and x''_0 is the projection of x'_0 onto the line ℓ . See Figure 3.8. Observe that we can estimate

$$(3.32) \quad |v(x''_0) - v(x'_0)| \leq 2|v(x_0) - v(x''_0)| L(R')$$

Therefore, for C sufficiently large, we have

$$\begin{aligned} |v(x_0) - v(x'_0)| &\geq ||v(x'_0) - v(x''_0)| - |v(x''_0) - v(x_0)|| \\ &\geq |v(x''_0) - v(x_0)|(1 - 2L(R')) \\ &\geq |\text{EX}(R')| \end{aligned}$$

provided C is large enough.

Now, after a moments thought, one sees that

$$|\det[v(x_0), v(x'_0)]| \simeq \text{angle}(v(x_0), v(x'_0)).$$

Therefore, for any $x \in \ell$

$$\sup_{s \leq \mathbf{L}(R)} \omega(x; s) \gtrsim |\mathbf{EX}(R')|.$$

But the vector field satisfies (3.28), which we will apply with

$$\tau \simeq \frac{\mathbf{EX}(R)}{\mathbf{EX}(R')} \simeq \frac{\mathbf{L}(R')}{\mathbf{L}(R)}.$$

It follows that

$$\begin{aligned} \frac{\delta}{2} \mathbf{L}(R) &\leq |\{x \in \ell \mid \omega(x; s) \leq c\tau |\mathbf{EX}(R')|\}| \\ &\leq |\{x \in \ell \mid \omega(x; s) \leq \tau \sup_{|s| \leq \epsilon} \omega(x, s)\}| \\ &\lesssim \tau^c \mathbf{L}(R). \end{aligned}$$

Therefore, we see

$$(\delta/2)^{1/c} \lesssim \frac{\mathbf{L}(R')}{\mathbf{L}(R)},$$

which is a contradiction to \mathcal{R}' have scales separated by s , and $s \simeq 1 + \log 1/\delta$.

Let us see how to prove the Proposition now that we have proved (3.31). Take $s \simeq \log 1/\delta$, and a finite sub-collection $\mathcal{R}' \subset \mathcal{R}$ of rectangles with scales separated by s . We may take a further subset $\mathcal{R}'' \subset \mathcal{R}'$ such that

$$(3.33) \quad \left\| \sum_{R'' \in \mathcal{R}''} \mathbf{1}_{R''} \right\|_{\infty} \lesssim \delta^{-1},$$

$$(3.34) \quad \left| \bigcup_{R \in \mathcal{R}' - \mathcal{R}''} R'' \right| \lesssim \sum_{R \in \mathcal{R}''} |R''|.$$

These are precisely the covering estimates needed to prove the weak L^1 estimate claimed in the proposition.

But, in choosing \mathcal{R}'' to satisfy (3.33), it is clear that we need only be concerned about rectangles with a fixed length, and the separation in scales are (3.31) will control rectangles of distinct lengths.

The procedure that we apply to select \mathcal{R}'' is inductive. Set

$$\begin{aligned} \mathcal{R}'' &\leftarrow \emptyset, \\ \mathcal{S} &\leftarrow \emptyset, \\ \text{STOCK} &\leftarrow \mathcal{R}'. \end{aligned}$$

WHILE $\text{STOCK} \neq \emptyset$, select $R \in \text{STOCK}$ with maximal length, and update $\mathcal{R}'' \leftarrow \mathcal{R}'' \cup \{R\}$, as well as $\text{STOCK} \leftarrow \text{STOCK} - \{R\}$. In addition, for any $R' \in \text{STOCK}$ with $R' \subset 4CR$, where $C \geq 1$ is the

constant that insures that (3.31) holds, remove these rectangles from STOCK and add them to S.

Once the WHILE loop stops, we will have STOCK = \emptyset and we have our decomposition of \mathcal{R}' . By construction, it is clear that (3.34) holds. We need only check that (3.33) holds. Now, consider $R, R' \in \mathcal{R}'$, with two rectangles have their scales separated, thus $2^s L(R') < L(R)$. If it is the case that $R \cap R' \neq \emptyset$ and $C \text{EX}(R) \cap C \text{EX}(R') \neq \emptyset$, then R would be selected to be in \mathcal{R}' first, whence R' would have been placed in S.

Therefore, $C \text{EX}(R) \cap C \text{EX}(R') = \emptyset$, but then (3.31) implies that $R \cap R' = \emptyset$. Thus, the only contribution to the L^∞ norm in (3.33) can come from rectangles of about the same length. But Lemma 3.9 then implies that such rectangles can overlap only about δ^{-1} times. Our proof is complete. (As the interest in (3.28) is in small values of c , it will be more efficient to use Lemma 3.9 to handle the case of the rectangles having approximately the same length.) \square

Remark 3.35. To conclude that the Hilbert transform on vector fields is bounded, one could weaken Bourgain's condition (3.28) to

$$|\{ |t| \leq \epsilon \mid \omega(x; t) < \tau \sup_{|s| \leq \epsilon} \omega(x, s) \}| \leq C \exp(-(\log 1/\tau)^c) \epsilon.$$

This inequality is to hold universally in $x \in \mathbb{R}^2$, $0 < \tau < 1$, and $0 < \epsilon < \|v\|_{\text{Lip}}$. This is of interest for $0 < c < 1$. The proof above can be modified to show that the maximal functions $M_{v, \delta, w}$ satisfy the weak L^1 inequality, with constant at most $\lesssim \delta^{-1-1/c}$.

Vector Fields that are a Function of One Variable

We specialize to the vector fields that are a function of just one real variable. Assume that the vector field v is of the form

$$(3.36) \quad v(x_1, x_2) = (v_1(x_2), v_2(x_2)),$$

and for the moment we do not impose the condition that the vector field take values in the unit circle. The point is simply this: If we are interested in transforms where the kernel is not localized, the restriction on the vector field is immaterial. Namely, for *any* vector field v

$$\begin{aligned} H_{v, \infty} f(x) &= \text{p.v.} \int_{-\infty}^{\infty} f(x - yv(x)) \frac{dy}{y} \\ &= \text{p.v.} \int_{-\infty}^{\infty} f(x - y\tilde{v}(x)) \frac{dy}{y}, \quad \tilde{v}(x) = \frac{v(x)}{|v(x)|}. \end{aligned}$$

We return to a theme implicit in the proof of Proposition 2.4. This proof only relies upon vector fields that are only a function of one

variable. Thus, it is a significant subcase of the Stein Conjecture to verify it for Lipschitz vector fields of just one variable. Indeed, the situation is this.

Proposition 3.37. *Suppose that a choice of vector field $v(x_1, x_2) = (1, v_1(x_1))$ is just a function of, say, the first coordinate. Then, $H_{v, \infty}$ maps $L^2(\mathbb{R}^2)$ into itself.*

PROOF. The symbol of $H_{v, \infty}$ is

$$\operatorname{sgn}(\xi_1 + \xi_2 v_1(x_1)).$$

For each fixed ξ_2 , this is a bounded symbol. And in the special case of the L^2 estimate, this is enough to conclude the boundedness of the operator. \square

It is of interest to extend this Theorem in any L^p , for $p \neq 2$, for some reasonable choice of vector fields.

The corresponding questions for the maximal function are also of interest, and here the subject is much more developed. The paper [5] studies the maximal function $M_{v, \infty}$. They proved the boundedness of this maximal function on L^p , $p > 1$, assuming that the vector field was of the form $v(x) = (1, v_2(x))$, that Dv_2 was positive, and increasing, and satisfied a third more technical condition. More recently, [14] has showed that the third condition is not needed. Namely the following is true.

Theorem 3.38. *Assume that $v(x) = (1, v_2(x))$, and moreover that $Dv_2 \geq 0$ and is monotonically increasing. Then, $M_{v, \infty}$ is bounded on L^p , for $1 < p < \infty$.*

These vector fields present far fewer technical difficulties than a general Lipschitz vector field, and there are a richer set of proof techniques that one can bring to bear on them, as indicated in part in the proof of Proposition 3.37. The papers [5, 14] cleverly exploit the Plancherel identity (in the independent variable), and other orthogonality considerations to prove their results.

These considerations are not completely consistent with the dominant theme of this monograph, in which the transforms are localized. Nevertheless, it would be interesting to explore methods, possibly modifications of this memoir, that could provide an extension of Proposition 3.37.

In this direction, let us state a possible direction of study. The definition of the the sets $V(R)$ for vector fields of magnitude 1 is given as $V(R) = R \cap v^{-1}(\operatorname{EX}(R))$. For vector fields of arbitrary magnitude,

we define these sets to be

$$V(R) = \{x \in R \mid \frac{v(x)}{|v(x)|} \in \text{EX}(R)\}.$$

Define a maximal function—an extension of our Lipschitz Keakeya Maximal Function—by

$$(3.39) \quad \tilde{M}_{v,\delta} f(x) = \sup_{\substack{x \in R \\ |V(R)| \geq \delta |R|}} |R|^{-1} \int_R f(y) dy.$$

In this definition, we require the rectangles to have density δ , but do not restrict their eccentricities, or lengths.

Conjecture 3.40. *Assume that the vector field is of the form $v(x) = (1, v_2(x_2))$, and the derivative $Dv \geq 0$ and is monotone. Then for all $0 < \delta < 1$, we have the estimate*

$$\|\tilde{M}_{v,\delta}\|_p \lesssim \delta^{-1}, \quad 1 < p < \infty.$$

One can construct examples which show that the L^1 to weak L^1 norm of the maximal function is not bounded in terms of δ . Indeed, recalling the ‘pocketknife’ examples of Figure 3.7, we comment that one can construct examples of vector fields with these properties, which we describe with the terminology associated with the pocketknife examples.

- The width of all rectangles are fixed. And all rectangles have density δ .
- The ‘handle’ of the pocketknife has positive angle θ with the x_1 axis.
- There is ‘hinge’ whose blades have angles which are positive, and greater than θ . The number of blades can be unbounded, as the width of the rectangles decreases to zero.

The assumption that the vector field is only a function of x_2 then greatly restricts, but does not completely forbid, the existence of additional hinges. So the combinatorics of these vector fields, as expressed in the Lipschitz Keakeya Maximal Function, are not so simple.

CHAPTER 4

The L^2 Estimate for Hilbert Transform on Lipschitz Vector Fields

We prove one of our main conditional results about the Hilbert transform on Lipschitz vector fields, the inequality (1.19) which is the estimate at L^2 , for functions with frequency support in an annulus, assuming an appropriate estimate for the Lipschitz Keakeya Maximal Function.

We begin the proof by setting notation appropriate for phase plane analysis for functions f on the plane supported on an annulus. With this notation, we can define appropriate discrete analogs of the Hilbert transform on vector fields. The Lemmas 4.22 and 4.23 are the combinatorial analogs of our Theorem 1.15. We then take up the proofs. The main step in the proof is Lemma 4.50 which combines the (standard) orthogonality considerations with the conjectures about the Lipschitz Keakeya Maximal Functions.

Definitions and Principle Lemmas

Throughout this chapter, κ will denote a fixed small positive constant, whose exact value need not concern us. κ of the order of 10^{-3} would suffice. The following definitions are as in the authors' previous paper [15].

Definition 4.1. A *grid* is a collection of intervals \mathcal{G} so that for all $I, J \in \mathcal{G}$, we have $I \cap J \in \{\emptyset, I, J\}$. The dyadic intervals are a grid. A grid \mathcal{G} is *central* iff for all $I, J \in \mathcal{G}$, with $I \subsetneq J$ we have $500\kappa^{-20}I \subset J$.

The reader can find the details on how to construct such a central grid structure in [11].

Let ρ be rotation on \mathbb{T} by an angle of $\pi/2$. Coordinate axes for \mathbb{R}^2 are a pair of unit orthogonal vectors (e, e_\perp) with $\rho e = e_\perp$.

Definition 4.2. We say that $\omega \subset \mathbb{R}^2$ is a *rectangle* if it is a product of intervals with respect to a choice of axes (e, e_\perp) of \mathbb{R}^2 . We will say that ω is an *annular rectangle* if $\omega = (-2^{l-1}, 2^{l-1}) \times (a, 2a)$ for an integer l with $2^l < \kappa a$, with respect to the axes (e, e_\perp) . The dimensions of ω are said to be $2^l \times a$. Notice that the face $(-2^{l-1}, 2^{l-1}) \times a$ is

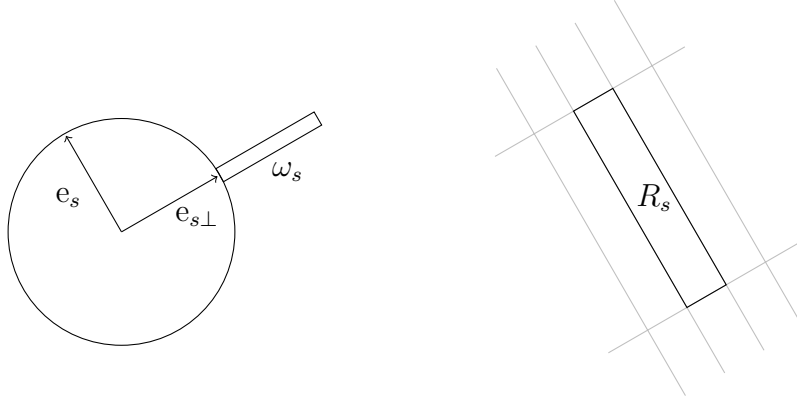

FIGURE 4.1. The two rectangles ω_s and R_s whose product is a tile. The gray rectangles are other possible locations for the rectangle R_s .

tangent to the circle $|\xi| = a$ at the midpoint to the face, $(0, a)$. We say that the *scale of ω* is $\text{scl}(\omega) := 2^l$ and that the *annular parameter of ω* is $\text{ann}(\omega) := a$. In referring to the coordinate axes of an annular rectangle, we shall always mean (e, e_\perp) as above.

Annular rectangles will decompose our functions in the frequency variables. But our methods must be sensitive to spatial considerations; it is this and the uncertainty principle that motivate the next definition.

Definition 4.3. Two rectangles R and \mathbf{R} are said to be *dual* if they are rectangles with respect to the same basis (e, e_\perp) , thus $R = r_1 \times r_2$ and $\mathbf{R} = \mathbf{r}_1 \times \mathbf{r}_2$ for intervals $r_i, \mathbf{r}_i, i = 1, 2$. Moreover, $1 \leq |r_i| \cdot |\mathbf{r}_i| \leq 4$ for $i = 1, 2$. The product of two dual rectangles we shall refer to as a *phase rectangle*. The first coordinate of a phase rectangle we think of as a frequency component and the second as a spatial component.

We consider collections of phase rectangles \mathcal{AT} which satisfy these conditions. For $s, s' \in \mathcal{AT}$ we write $s = \omega_s \times R_s$, and require that

$$(4.4) \quad \omega_s \text{ is an annular rectangle,}$$

$$(4.5) \quad R_s \text{ and } \omega_s \text{ are dual,}$$

$$(4.6) \quad \text{The rectangles } R_s \text{ are from the product of central grids.}$$

$$(4.7) \quad \{1000\kappa^{-100}R \mid \omega_s \times R \in \mathcal{AT}\} \text{ covers } \mathbb{R}^2, \text{ for all } \omega_s.$$

$$(4.8) \quad \text{ann}(\omega_s) = 2^j \text{ for some integer } j,$$

$$(4.9) \quad \#\{\omega_s \mid \text{scl}(s) = \text{scl}, \text{ann}(s) = \text{ann}\} \geq c \frac{\text{ann}}{\text{scl}},$$

$$(4.10) \quad \text{scl}(s) \leq \kappa \text{ann}(s).$$

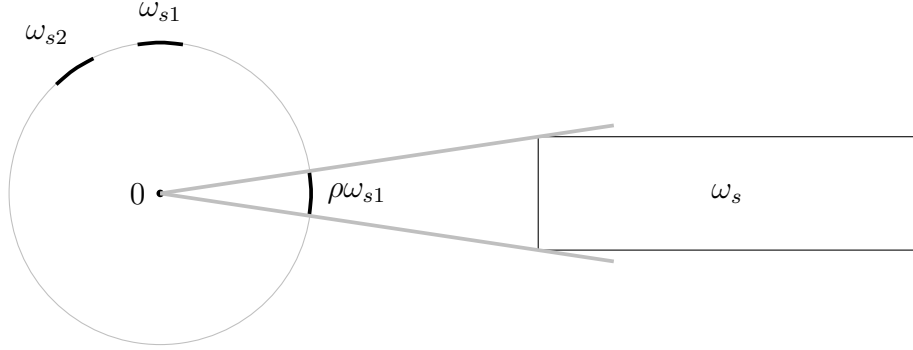

FIGURE 4.2. An annular rectangular ω_s , and three associated subintervals of $\rho\omega_{s1}$, ω_{s1} , and ω_{s2} .

We assume that there are auxiliary sets $\omega_s, \omega_{s1}, \omega_{s2} \subset \mathbb{T}$ associated to s —or more specifically ω_s —which satisfy these properties.

$$(4.11) \quad \Omega := \{\omega_s, \omega_{s1}, \omega_{s2} \mid s \in \mathcal{AT}\} \text{ is a grid in } \mathbb{T},$$

$$(4.12) \quad \omega_{s1} \cap \omega_{s2} = \emptyset, \quad |\omega_s| \geq 32(|\omega_{s1}| + |\omega_{s2}| + \text{dist}(\omega_{s1}, \omega_{s2}))$$

$$(4.13) \quad \omega_{s1} \text{ lies clockwise from } \omega_{s2} \text{ on } \mathbb{T},$$

$$(4.14) \quad |\omega_s| \leq K \frac{\text{scl}(\omega_s)}{\text{ann}(\omega_s)},$$

$$(4.15) \quad \left\{ \frac{\xi}{|\xi|} \mid \xi \in \omega_s \right\} \subset \rho\omega_{s1}.$$

In the top line, the intervals ω_{s1} and ω_{s2} are small subintervals of the unit circle, and we can define their dilate by a factor of 2 in an obvious way. Recall that ρ is the rotation that takes e into e_\perp . Thus, $e_{\omega_s} \in \omega_{s1}$. See the figures Figure 4.1 and Figure 4.2 for an illustration of these definitions.

Note that $|\omega_s| \geq |\omega_{s1}| \geq \text{scl}(\omega_s)/\text{ann}(\omega_s)$. Thus, e_{ω_s} is in ω_{s1} , and ω_s serves as ‘the angle of uncertainty associated to R_s .’ Let us be more precise about the geometric information encoded into the angle of uncertainty. Let $R_s = r_s \times r_{s\perp}$ be as above. Choose another set of coordinate axes (e', e'_\perp) with $e' \in \omega_s$ and let R' be the product of the intervals r_s and $r_{s\perp}$ in the new coordinate axes. Then $K_0^{-1}R' \subset R_s \subset K_0R'$ for an absolute constant $K_0 > 1$.

We say that *annular tiles* are collections \mathcal{AT} satisfying the conditions (4.4)—(4.15) above. We extend the definition of e_\perp , $e_{\omega\perp}$, $\text{ann}(\omega)$ and $\text{scl}(\omega)$ to annular tiles in the obvious way, using the notation e_s , $e_{s\perp}$, $\text{ann}(s)$ and $\text{scl}(s)$.

A phase rectangle will have two distinct functions associated to it. In order to define these functions, set

$$\begin{aligned} T_y f(x) &:= f(x - y), \quad y \in \mathbb{R}^2 \quad (\text{Translation operator}) \\ \text{Mod}_\xi f(x) &:= e^{i\xi \cdot x} f(x), \quad \xi \in \mathbb{R}^2 \quad (\text{Modulation operator}) \\ D_{R_1 \times R_2}^p f(x_1, x_2) &:= \frac{1}{(|R_1||R_2|)^{1/p}} f\left(\frac{x_1}{|R_1|}, \frac{x_2}{|R_2|}\right) \quad (\text{Dilation operator}). \end{aligned}$$

In the last display, $0 < p \leq \infty$, and $R_1 \times R_2$ is a rectangle, and the coordinates (x_1, x_2) are those of the rectangle. Note that the definition depends only on the side lengths of the rectangle, and not the location. And that it preserves L^p norm.

For a function φ and tile $s \in \mathcal{AT}$ set

$$(4.16) \quad \varphi_s := \text{Mod}_{c(\omega_s)} T_{c(R_s)} D_{R_s}^2 \varphi$$

We shall consider φ to be a Schwartz function for which $\widehat{\varphi} \geq 0$ is supported in a small ball, of radius κ , about the origin in \mathbb{R}^2 , and is identically 1 on another smaller ball around the origin. (Recall that κ is a fixed small constant.)

We introduce the tool to decompose the singular integral kernels. In so doing, we consider a class of functions ψ_t , $t > 0$, so that

$$(4.17) \quad \text{Each } \psi_t \text{ is supported in frequency in } [-\theta - \kappa, -\theta + \kappa].$$

$$(4.18) \quad |\psi_t(x)| \lesssim C_N (1 + |x|)^{-N}, \quad N > 1.$$

In the top line, θ is a fixed positive constant so that the second half of (4.19) is true.

Define

$$(4.19) \quad \begin{aligned} \phi_s(x) &:= \int_{\mathbb{R}} \varphi_s(x - yv(x)) \psi_s(y) dy \\ &= \mathbf{1}_{\omega_{s2}}(v(x)) \int_{\mathbb{R}} \varphi_s(x - yv(x)) \psi_s(sy) dy. \end{aligned}$$

$$(4.20) \quad \psi_s(y) := \text{scl}(s) \psi_{\text{scl}(s)}(\text{scl}(s)y).$$

An essential feature of this definition is that the support of the integral is contained in the set $\{v(x) \in \omega_{s2}\}$, a fact which can be routinely verified. That is, we can insert the indicator $\mathbf{1}_{\omega_{s2}}(v(x))$ without loss of generality. The set ω_{s2} serves to localize the vector field, while ω_{s1} serves to identify the location of φ_s in the frequency coordinate.

The model operator we consider acts on a Schwartz functions f , and it is defined by

$$(4.21) \quad \mathcal{C}_{\text{ann}} f := \sum_{\substack{s \in \mathcal{AT}(\text{ann}) \\ \text{scl}(s) \geq \|v\|_{\text{Lip}}} \langle f, \varphi_s \rangle \phi_s.$$

In this display, $\mathcal{AT}(\text{ann}) := \{s \in \mathcal{AT} \mid \text{ann}(s) = \text{ann}\}$, and we have deliberately formulated the operator in a dilation invariant manner.

Lemma 4.22. *Assume that the vector field is Lipschitz, and satisfies Conjecture 1.14. Then, for all $\text{ann} \geq \|v\|_{\text{Lip}}^{-1}$, the operator \mathcal{C}_{ann} extends to a bounded map from L^2 into itself, with norm bounded by an absolute constant.*

We remind the reader that for $2 < p < \infty$ the only condition needed for the boundedness of \mathcal{C}_{ann} is the measurability of the vector field, a principal result of Lacey and Li [15]. It is of course of great importance to add up the \mathcal{C}_{ann} over ann . The method we use for doing this are purely L^2 in nature, and lead to the estimate for $\mathcal{C} := \sum_{j=1}^{\infty} \mathcal{C}_{2^j}$.

Lemma 4.23. *Assume that the vector field is of norm at most one in C^α for some $\alpha > 1$, and satisfies Conjecture 1.14. Then \mathcal{C} maps L^2 into itself. In addition we have the estimate below, holding for all values of scl .*

$$(4.24) \quad \left\| \sum_{\text{ann}=-\infty}^{\infty} \sum_{\substack{s \in \mathcal{AT}(\text{ann}) \\ \text{scl}(s)=\text{scl}}} \langle f, \varphi_s \rangle \phi_s \right\|_2 \lesssim (1 + \log(1 + \text{scl}^{-1} \|v\|_{C^\alpha})).$$

Moreover, these operators are unconditionally convergent in $s \in \mathcal{AT}$.

These are the principal steps towards the proof of Theorem 1.15. In the course of the proof, we shall not invoke the additional notation needed to account for the unconditional convergence, as it is entirely notational. They can be added in by the reader.

Observe that (4.24) is only of interest when $\text{scl} < \|v\|_{C^\alpha}$. This inequality depends critically on the fact that the kernel $\text{scl}\psi(\text{scl}y)$ has mean zero. Without this assumption, this inequality is certainly false.

The proof of Theorem 1.15 from these two lemmas is an argument in which one averages over translations, dilations and rotations of grids. The specifics of the approach are very close to the corresponding argument in [15]. The details are omitted.

The operators \mathcal{C}_{ann} and \mathcal{C} are constructed from a kernel which is a smooth analog of the truncated kernel $\text{p.v.} \frac{1}{t} 1_{\{|t| \leq 1\}}$. Nevertheless, our

main theorem follows,¹ due to the observation that we can choose a sequence of Schwartz kernels $\psi_{(1+\kappa)^n}$, for $n \in \mathbb{Z}$, which satisfy (4.17) and (4.18), and so that for

$$K(t) := \sum_{n \in \mathbb{Z}} a_n (1 + \kappa)^n \psi_{(1+\kappa)^n}((1 + \kappa)^n t).$$

we have p.v. $\frac{1}{t} 1_{\{|t| \leq 1\}} = K(t) - \overline{K(t)}$. Here, for $n \geq 0$ we have $|a_n| \lesssim 1$. And for $n < 0$, we have $|a_n| \lesssim (1 + \kappa)^n$. The principal sum is thus over $n \geq \max(0, \|v\|_{C^\alpha})$, and this corresponds to the operator \mathcal{C} . For those $n < \max(0, \|v\|_{C^\alpha})$, we use the estimate (4.24), and the rapid decay of the coefficient a_n .

Truncation and an Alternate Model Sum

There are significant obstacles to proving the boundedness of the model sum \mathcal{C}_{ann} on an L^p space, for $1 < p < 2$. In this section, we rely upon some naive L^2 estimates to define a new model sum which is bounded on L^p , for some $1 < p < 2$.

Our next Lemma is indicative of the estimates we need. For choices of $\text{scl} < \kappa \text{ann}$, set

$$\mathcal{AT}(\text{ann}, \text{scl}) := \{s \in \mathcal{AT}(\text{ann}) \mid \text{scl}(s) = \text{scl}\}.$$

Lemma 4.25. *For measurable vector fields v and all choices of ann and scl .*

$$\left\| \sum_{s \in \mathcal{AT}(\text{ann}, \text{scl})} \langle f, \varphi_s \rangle \phi_s \right\|_2 \lesssim \|f\|_2$$

PROOF. The scale and annulus are fixed in this sum, making the Bessel inequality

$$\sum_{s \in \mathcal{AT}(\text{ann}, \text{scl})} |\langle f, \varphi_s \rangle|^2 \lesssim \|f\|_2^2$$

evident. For any two tiles s and s' that contribute to this sum, if $\omega_s \neq \omega_{s'}$, then ϕ_s and $\phi_{s'}$ are disjointly supported. And if $\omega_s = \omega_{s'}$, then R_s and $R_{s'}$ are disjoint, but share the same dimensions and orientation in the plane. The rapid decay of the functions ϕ_s then gives us the

¹In the typical circumstance, one uses a maximal function to pass back and forth between truncated and smooth kernels. This route is forbidden to us; there is no appropriate maximal function to appeal to.

estimate

$$\begin{aligned} \left\| \sum_{s \in \mathcal{AT}(\text{ann}, \text{scl})} \langle f, \varphi_s \rangle \phi_s \right\|_2 &\lesssim \left[\sum_{s \in \mathcal{AT}(\text{ann}, \text{scl})} |\langle f, \varphi_s \rangle|^2 \right]^{1/2} \\ &\lesssim \|f\|_2 \end{aligned}$$

□

Consider the variant of the operator (4.21) given by

$$(4.26) \quad \Phi f = \sum_{\substack{s \in \mathcal{AT}(\text{ann}) \\ \text{scl}(s) \geq \kappa^{-1} \|v\|_{\text{Lip}}}} \langle f, \varphi_s \rangle \phi_s.$$

As ann is fixed, we shall begin to suppress it in our notations for operators. The difference between Φ and \mathcal{C}_{ann} is the absence of the initial $\lesssim \log(1 + \|v\|_{\text{Lip}})$ scales in the former. The L^2 bound for these missing scales is clearly provided by Lemma 4.25, and so it remains for us to establish

$$(4.27) \quad \|\Phi\|_2 \lesssim 1,$$

the implied constant being independent of ann , and the Lipschitz norm of v .

It is an important fact, the main result of Lacey and Li [15], that

$$(4.28) \quad \|\Phi\|_p \lesssim 1, \quad 2 < p < \infty.$$

This holds without the Lipschitz assumption.

We are now at a point where we can be more directly engaged with the construction of our alternate model sum. We only consider tiles with $\kappa^{-1} \|v\|_{\text{Lip}} \leq \text{scl}(s) \leq \kappa \text{ann}$. A parameter is introduced which is used to make a spatial truncation of the functions φ_s ; it is

$$(4.29) \quad \gamma_s^2 := 100^{-2} \frac{\text{scl}(s)}{\|v\|_{\text{Lip}}}$$

Write $\varphi_s = \alpha_s + \beta_s$ where $\alpha_s = (T_{c(R_s)} D_{\gamma_s R_s}^\infty \zeta) \varphi_s$, and ζ is a smooth Schwartz function supported on $|x| < 1/2$, and equal to 1 on $|x| < 1/4$.

Write for choices of tiles s ,

$$(4.30) \quad \psi_s(y) = \psi_{s-}(y) + \psi_{s+}(y)$$

where $\psi_{s-}(y)$ is a Schwartz function on \mathbb{R} , with

$$\text{supp}(\psi_{s-}) \subset \frac{1}{2} \gamma_s (\text{scl}(s))^{-1} [-1, 1],$$

and equal to $\psi_{\text{scl}(s)}(y)$ for $|y| < \frac{1}{4}\gamma_s(\text{scl}(s))^{-1}$. Then define

$$(4.31) \quad a_{s\pm}(x) = \mathbf{1}_{\omega_{s2}}(v(x)) \int \phi_s(x - yv(x))\psi_{s\pm}(y) dy.$$

Thus, $\phi_s = a_{s-} + a_{s+}$. Recalling the notation S_{ann} in Theorem 1.15, define

$$(4.32) \quad A_{\pm} f := \sum_{\substack{s \in \mathcal{AT}(\text{ann}) \\ \text{scl}(s) \geq \kappa^{-1}\|v\|_{\text{Lip}}}} \langle S_{\text{ann}} f, \alpha_s \rangle a_{s\pm}$$

We will write $\Phi = \Phi S_{\text{ann}} = A_+ + A_- + B$, where B is an operator defined in (4.35) below. The main fact we need concerns A_- .

Lemma 4.33. *There is a choice of $1 < p_0 < 2$ so that*

$$\|A_-\|_p \lesssim 1, \quad p_0 < p < \infty.$$

The implied constant is independent of the value of ann , and the Lipschitz norm of v .

The proof of this Lemma is given in the next section, modulo three additional Lemmata stated therein. The following Lemma is important for our approach to the previous Lemma. It is proved below.

Lemma 4.34. *For each choice of $\kappa^{-1}\|v\|_{\text{Lip}} < \text{scl} < \kappa \text{ann}$, we have the estimate*

$$\sum_{s \in \mathcal{AT}(\text{ann}, \text{scl})} |\langle S_{\text{ann}} f, \alpha_s \rangle|^2 \lesssim \|f\|_2^2.$$

Define

$$(4.35) \quad B f := \sum_{\substack{s \in \mathcal{AT}(\text{ann}) \\ \text{scl}(s) \geq \kappa^{-1}\|v\|_{\text{Lip}}}} \langle S_{\text{ann}} f, \beta_s \rangle \phi_s$$

Lemma 4.36. *For a Lipschitz vector field v , we have*

$$\|B\|_p \lesssim 1, \quad 2 \leq p < \infty.$$

PROOF. For choices of integers $\kappa^{-1}\|v\|_{\text{Lip}} \leq \text{scl} < \kappa \text{ann}$, consider the vector valued operator

$$\mathbb{T}_{j,k} f := \left\{ \frac{\langle S_{\text{ann}} f, \beta_s \rangle}{\sqrt{|R_s|}} \mathbf{1}_{\{v(x) \in \omega_{s2}\}} \mathbb{T}_{c(R_s)} D_{R_s}^\infty \left(\frac{1}{(1 + |\cdot|^2)^N} \right) (x) \mid s \in \mathcal{AT}(\text{ann}, \text{scl}) \right\},$$

where N is a fixed large integer.

Recall that β_s is supported off of $\frac{1}{2}\gamma_s R_s$. This is bounded linear operator from $L^\infty(\mathbb{R}^2)$ to $\ell^\infty(\mathcal{AT}(\text{ann}, \text{scl}))$. It has norm $\lesssim (\text{scl}/\|v\|_{\text{Lip}})^{-10}$. Routine considerations will verify that

$$T_{j,k} : L^2(\mathbb{R}^2) \longrightarrow \ell^2(\mathcal{AT}(\text{ann}, \text{scl}))$$

with a similarly favorable estimate on its norm. By interpolation, we achieve the same estimate for $T_{j,k}$ from $L^p(\mathbb{R}^2)$ into $\ell^p(\mathcal{AT}(\text{ann}, \text{scl}))$, $2 \leq p < \infty$.

It is now very easy to conclude the Lemma by summing over scales in a brute force way, and using the methods of Lemma 4.25. \square

We turn to A_+ , as defined in (4.32).

Lemma 4.37. *We have the estimate*

$$\|A_+\|_p \lesssim 1 \quad 2 \leq p < \infty.$$

PROOF. We redefine the vector valued operator $T_{j,k}$ to be

$$T_{j,k} f := \left\{ \frac{\langle S_{\text{ann}} f, \alpha_s \rangle}{\sqrt{|R_s|}} \mathbf{1}_{\{v(x) \in \omega_{s2}\}} T_{c(R_s)} D_{R_s}^\infty \left(\frac{1}{(1 + |x|^2)^N} \right) \mid s \in \mathcal{AT}(\text{ann}, \text{scl}) \right\},$$

where N is a fixed large integer. This operator is bounded from

$$L^p(\mathbb{R}^2) \longrightarrow \ell^p(\mathcal{AT}(\text{ann}, \text{scl})), \quad 2 \leq p < \infty$$

Its norm is at most $\lesssim 1$.

But, for $s \in \mathcal{AT}(\text{ann}, \text{scl})$, we have

$$(4.38) \quad |a_{s+}| \lesssim (\text{scl}/\|v\|_{\text{Lip}})^{-10} |R_s|^{-1/2} (M \mathbf{1}_{R_s})^{100}.$$

Here M denotes the strong maximal function in the plane in the coordinates determined by R_s . This permits one to again adapt the estimate of Lemma 4.25 to conclude the Lemma. \square

Now we conclude that $\|\Phi\|_2 \lesssim 1$. And since $\Phi = A_- + A_+ + B$, it follows from the Lemmata of this section.

Proofs of Lemmata

Proof of Lemma 4.33. We have $\Phi = A_- + A_+ + B$, so from (4.28), Lemma 4.36 and Lemma 4.37, we deduce that $\|A_-\|_p \lesssim 1$ for all $2 < p < \infty$. It remains for us to verify that A_- is of restricted weak type p_0 for some choice of $1 < p_0 < 2$. That is, we should verify that for all sets $F, G \subset \mathbb{R}^2$ of finite measure

$$(4.39) \quad |\langle A_- \mathbf{1}_F, \mathbf{1}_G \rangle| \lesssim |F|^{1/p} |G|^{1-1/p}, \quad p_0 < p < 2.$$

Since A_- maps L^p into itself for $2 < p < \infty$, it suffices to consider the case of $|F| < |G|$. Since we assume only that the vector field is Lipschitz, we can use a dilation to assume that $1 < |G| < 2$, and so this set will not explicitly enter into our estimates.

We fix the data $F \subset \mathbb{R}^2$ of finite measure, ann , and vector field v with $\|v\|_{\text{Lip}} \leq \kappa \text{ann}$. Take $p_0 = 2 - \kappa^2$. We need a set of definitions that are inspired by the approach of Lacey and Thiele [20], and are also used in Lacey and Li [15]. For subsets $\mathcal{S} \subset \mathcal{A}_v := \{s \in \mathcal{AT}(\text{ann}) \mid \kappa^{-1}\|v\|_{\text{Lip}} \leq \text{scl}(s) < \kappa \text{ann}\}$, set

$$A^{\mathcal{S}} = \sum_{s \in \mathcal{S}} \langle S_{\text{ann}} \mathbf{1}_F, \alpha_s \rangle a_{s-}$$

Set $\chi(x) = (1 + |x|)^{-1000/\kappa}$. Define

$$(4.40) \quad \chi_{R_s}^{(p)} := \chi_s^{(p)} = T_{c(R_s)} D_{R_s}^p \chi, \quad 0 \leq p \leq \infty.$$

And set $\tilde{\chi}_s^{(p)} = \mathbf{1}_{\gamma_s R_s} \chi_s^{(p)}$.

Remark 4.41. It is typical to define a partial order on tiles, following an observation of C. Fefferman [9]. In this case, there doesn't seem to be an appropriate partial order. Begin with this assumption on the order relation ' $<$ ' on tiles:

$$(4.42)$$

If $\omega_s \times R_s \cap \omega_{s'} \times R_{s'} \neq \emptyset$, then s and s' are comparable under ' $<$ '.

It follows from transitivity of a partial order that that one can have tiles s_1, \dots, s_J , with $s_{j+1} < s_j$ for $1 \leq j < J$, $J \simeq \log(\|v\|_{\text{Lip}} \cdot \text{ann})$, and yet the rectangles R_{s_j} and R_{s_1} can be far apart, namely $R_{s_j} \cap (cJ)R_{s_1}$, for a positive constant c . See Figure 4.3. (We thank the referee for directing us towards this conclusion.) Therefore, one cannot make the order relation transitive, and maintain control of the approximate localization of spatial variables, as one would wish. The partial order is essential to the argument of [9], but while it is used in [20], it is not essential to that argument.

We recall a fact about the eccentricity. There is an absolute constant K' so that for any two tiles s, s'

$$(4.43) \quad \omega_s \supset \omega_{s'}, \quad R_s \cap R_{s'} \neq \emptyset \quad \text{implies} \quad R_s \subset K' R_{s'}.$$

Figure 3.1 illustrates this in the case where the two rectangles R_s and $R_{s'}$ have different widths, which is not the case here.

We define an order relation on tiles by $s \lesssim s'$ iff $\omega_s \supsetneq \omega_{s'}$ and $R_s \subset \kappa^{-10} R_{s'}$. Thus, (4.42) holds for this order relation, and it is certainly not transitive.

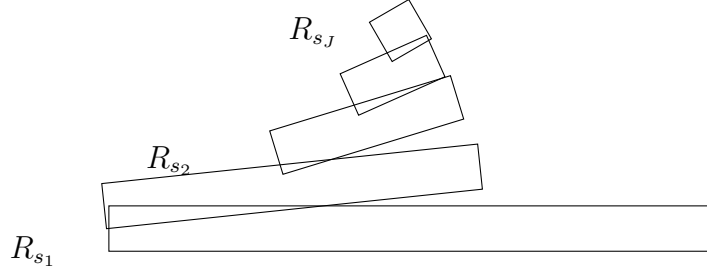

FIGURE 4.3. The rectangles R_{s_1}, \dots, R_{s_J} of Remark 4.41.

A *tree* is a collection of tiles $\mathbf{T} \subset \mathcal{A}_v$, for which there is a (non-unique) tile $\omega_{\mathbf{T}} \times R_{\mathbf{T}} \in \mathcal{AT}(\text{ann})$ with $R_s \subset 100\kappa^{-10}R_{\mathbf{T}}$, and $\omega_s \supset \omega_{\mathbf{T}}$ for all $s \in \mathbf{T}$. Here, we deliberately use a somewhat larger constant $100\kappa^{-10}$ than we used in the definition of the order relation ‘ \lesssim .’

For $j = 1, 2$, call \mathbf{T} a i -tree if the tiles for all $s, s' \in \mathbf{T}$, if $\text{scl}(s) \neq \text{scl}(s')$, then $\omega_{si} \cap \omega_{s'i} = \emptyset$. 1-trees are especially important. A few tiles in such a tree are depicted in Figure 4.4.

Remark 4.44. This remark about the partial order ‘ \lesssim ’ and trees is useful to us below. Suppose that we have two trees \mathbf{T} , with top $s(\mathbf{T})$ and \mathbf{T}' with top $s(\mathbf{T}')$. Suppose in addition that $s(\mathbf{T}') \lesssim s(\mathbf{T})$. Then, it is the case that $\mathbf{T} \cup \mathbf{T}'$ is a tree with top $s(\mathbf{T})$. Indeed, we must necessarily have $\omega_{\mathbf{T}} \subsetneq \omega_{\mathbf{T}'}$, since the R_s are from products of a central grid. Also, $100\kappa^{-1}R_{\mathbf{T}'} \subset 100\kappa^{-1}R_{\mathbf{T}}$. And so every tile in \mathbf{T}' could also be a tile in \mathbf{T} .

Our proof is organized around these parameters and functions associated to tiles and sets of tiles. Of particular note here are the first definitions of ‘density,’ which have to be formulated to accommodate the lack of transitivity in the partial order. Note that in the first definition, the supremum is taken over tiles $s' \in \mathcal{AT}$ of the same annular parameter as s . We choose the collection \mathcal{AT} as it is ‘universal,’ covering all scales in a uniform way, due to different assumptions including

(4.7).

$$(4.45) \quad \text{dense}(\mathbf{S}) := \sup_{s' \in \mathcal{AT}} \left\{ \int_{G \cap v^{-1}(\omega_{s'})} \tilde{\chi}_{s'}^{(1)} dx \mid \exists s, s'' \in \mathbf{S} : \right. \\ \left. \omega_s \supset \omega_{s'} \supset \omega_{s''}, R_s \subset 100\kappa^{-10} R_{s'}, \right. \\ \left. R_{s'} \subset 100\kappa^{-10} R_{s''} \right\}$$

$$(4.46) \quad \Delta(\mathbf{T})^2 := \sum_{s \in \mathbf{T}} \frac{|\langle S_{\text{ann}} 1_F, \alpha_s \rangle|^2}{|R_s|} \mathbf{1}_{R_s}, \quad \mathbf{T} \text{ is a 1-tree,}$$

$$(4.47) \quad \text{size}(\mathbf{S}) := \sup_{\substack{\mathbf{T} \subset \mathbf{S} \\ \mathbf{T} \text{ is a 1-tree}}} \int_{R_{\mathbf{T}}} \Delta(\mathbf{T}) dx.$$

Observe that $\text{dense}(\mathbf{S})$ only really applies to ‘tree-like’ sets of tiles, and that—and this is important—the tile s' that appear in (4.45) are *not* in \mathbf{S} , but only assumed to be in \mathcal{AT} . Finally, note that

$$\text{dense}(s) \simeq \int_{G \cap v^{-1}(\omega_s)} \tilde{\chi}_s^{(1)} dx$$

with the implied constants only depending upon κ , χ , and other fixed quantities.

Observe these points about size. First, it is computed relative to the truncated functions α_s , recall (4.29). Second, that for $p > 1$,

$$(4.48) \quad \|\Delta(\mathbf{T})\|_p \lesssim |F|^{1/p},$$

because of a standard L^p estimate for a Littlewood-Paley square function. Third, that $\text{size}(\mathcal{A}_v(\text{ann})) \lesssim 1$. And fourth, that one has an estimate of John-Nirenberg type.

Lemma 4.49. *For a 1-tree \mathbf{T} we have the estimate*

$$\|\Delta(\mathbf{T})\|_p \lesssim \text{size}(\mathbf{T}) |R_{\mathbf{T}}|^{1/p}, \quad 1 < p < \infty.$$

Proofs of results of this type are well represented in the literature. See [4, 11].

Given a set of tiles, say that $\text{count}(\mathbf{S}) < A$ iff \mathbf{S} is a union of trees $\mathbf{T} \in \mathcal{T}$ for which

$$\sum_{\mathbf{T} \in \mathcal{T}} |\text{sh}(\mathbf{T})| < A.$$

We will also use the notation $\text{count}(\mathbf{S}) \lesssim A$, implying the existence of an absolute constant K for which $\text{count}(\mathbf{S}) \leq KA$.

The principal organizational Lemma is

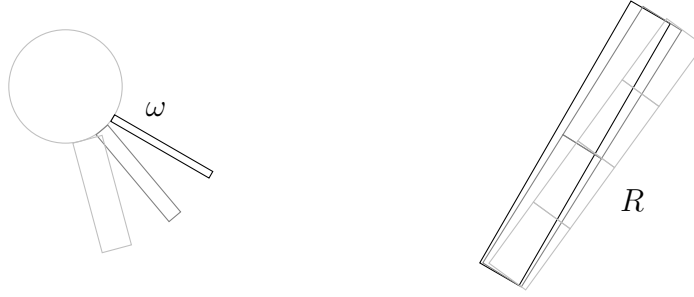

FIGURE 4.4. A few possible tiles in a 1-tree. Rectangles ω_s are on the left in different shades of gray. Possible locations of R_s are in the same shade of gray.

Lemma 4.50. *Any finite collection of tiles $\mathbf{S} \subset \mathcal{A}_v$ is a union of four subsets*

$$\mathbf{S}_{\text{light}}, \quad \mathbf{S}_{\text{small}}, \quad \mathbf{S}_{\text{large}}^\ell, \quad \ell = 1, 2.$$

They satisfy these properties.

$$(4.51) \quad \text{size}(\mathbf{S}_{\text{small}}) < \frac{1}{2} \text{size}(\mathbf{S}),$$

$$(4.52) \quad \text{dense}(\mathbf{S}_{\text{light}}) < \frac{1}{2} \text{dense}(\mathbf{S}),$$

and both $\mathbf{S}_{\text{large}}^\ell$ are unions of trees $\mathbf{T} \in \mathcal{T}^\ell$, for which we have the estimates

$$(4.53) \quad \text{count}(\mathbf{S}_{\text{large}}^1) \lesssim \begin{cases} \text{size}(\mathbf{S})^{-2-\kappa} |F| \\ \text{size}(\mathbf{S})^{-p} \text{dense}(\mathbf{S})^{-M} |F| \\ \quad + \text{size}(\mathbf{S})^{1/\kappa} \text{dense}(\mathbf{S})^{-1} \\ \text{dense}(\mathbf{S})^{-1} \end{cases}$$

$$(4.54) \quad \text{count}(\mathbf{S}_{\text{large}}^2) \lesssim \begin{cases} \text{size}(\mathbf{S})^{-2} (\log 1/\text{size}(\mathbf{S}))^3 |F| \\ \text{size}(\mathbf{S})^{\kappa/50} \text{dense}(\mathbf{S})^{-1} \end{cases}$$

What is most important here is the middle estimate in (4.53). Here, p is as in Conjecture 1.14, and $M > 0$ is only a function of N in that Conjecture.

The estimates that involve $\text{size}(\mathbf{S})^{-2}|F|$ are those that follow from orthogonality considerations. The estimates in $\text{dense}(\mathbf{S})^{-1}$ are those that follow from density considerations which are less complicated. However, in the second half of (4.54), the small positive power of size is essential for us. All of these estimates are all variants of those in [20].

The middle estimate of (4.53) is not of this type, and is the key ingredient that permits us to obtain an estimate below L^2 . Note that

it gives the best bound for collections with moderate density and size. For it we shall appeal to our assumed Conjecture 1.14.

Logarithms, such as those that arise in (4.54), arise from our truncation arguments, associated with the parameters γ_s in (4.29).

For individual trees, we need two estimates.

Lemma 4.55. *If \mathbf{T} is a 1-tree with $\int_{R_{\mathbf{T}}} \Delta(\mathbf{T}) \geq \sigma$, then we have*

$$(4.56) \quad |F \cap \sigma^{-\kappa} R_{\mathbf{T}}| \gtrsim \sigma^{1+\kappa} |R_{\mathbf{T}}|.$$

Lemma 4.57. *For trees \mathbf{T} we have the estimate*

$$(4.58) \quad \sum_{s \in \mathbf{T}} |\langle S_{\text{ann}} \mathbf{1}_F, \alpha_s \rangle \langle a_{s-}, \mathbf{1}_G \rangle| \lesssim \Psi(\text{dense}(\mathbf{T}) \text{size}(\mathbf{T})) |\text{sh}(\mathbf{T})|.$$

Here $\Psi(x) = x |\log cx|$, and inside the logarithm, c is a small fixed constant, to insure that $c \text{dense}(\mathbf{T}) \cdot \text{size}(\mathbf{T}) < \frac{1}{2}$, say.

Set

$$\text{Sum}(\mathbf{S}) := \sum_{s \in \mathbf{S}} |\langle S_{\text{ann}} \mathbf{1}_F, \alpha_s \rangle \langle a_{s-}, \mathbf{1}_G \rangle|$$

We want to provide the bound $\text{Sum}(\mathcal{A}_v) \lesssim |F|^{1/p}$ for $p_0 < p < 2$. We have the trivial bound

$$(4.59) \quad \text{Sum}(\mathbf{S}) \lesssim \Psi(\text{dense}(\mathbf{S}) \text{size}(\mathbf{S})) \text{count}(\mathbf{S}).$$

It is incumbent on us to provide a decomposition of \mathcal{A}_v into subcollections for which this last estimate is effective.

By inductive application of our principal organizational Lemma 4.50, \mathcal{A}_v is the union of $\mathbf{S}_{\delta, \sigma}^\ell$, $\ell = 1, 2$ for $\delta, \sigma \in \mathbf{2} := \{2^n \mid n \in \mathbb{Z}, n \leq 0\}$, satisfying

$$(4.60) \quad \text{dense}(\mathbf{S}_{\delta, \sigma}^\ell) \lesssim \delta,$$

$$(4.61) \quad \text{size}(\mathbf{S}_{\delta, \sigma}^\ell) \lesssim \sigma,$$

$$(4.62) \quad \text{count}(\mathbf{S}_{\delta, \sigma}^\ell) \lesssim \begin{cases} \min(\sigma^{-2-\kappa} |F|, \delta^{-M} \sigma^{-p} |F| + \sigma^{1/\kappa} \delta^{-1}, \delta^{-1}) & \ell = 1, \\ \min(\sigma^{-2} (\log 1/\sigma)^3 |F|, \delta^{-1} \sigma^{\kappa/50}) & \ell = 2 \end{cases}$$

Using (4.59), we see that

$$(4.63) \quad \begin{aligned} \text{Sum}(\mathbf{S}_{\delta, \sigma}^1) &\lesssim \min(\Psi(\delta) \sigma^{-1-\kappa} |F|, \delta^{-M+1} \sigma^{-p+1} |F| + \sigma^{1/\kappa+1}, \sigma) \\ \text{Sum}(\mathbf{S}_{\delta, \sigma}^2) &\lesssim \min(\Psi(\delta) \sigma^{-1} (\log 1/\sigma)^4 |F|, \sigma^{1+\kappa/50}) \end{aligned}$$

One can check that for $\ell = 1, 2$,

$$(4.64) \quad \sum_{\delta, \sigma \in \mathbf{2}} \text{Sum}(\mathbf{S}_{\delta, \sigma}^\ell) \lesssim |F|^{1/p}, \quad p_0 < p < 2.$$

This completes the proof of Lemma 4.33, aside from the proof of Lemma 4.50.

PROOF OF (4.64). We can assume that $|G| = 1$, and that $|F| \leq 1$, for otherwise the result follows from the known L^p estimates, for $p > 2$ and measurable vector fields, see Theorem 1.15.

The case of $\ell = 2$ in (4.64) is straightforward. Notice that in (4.63), for $\ell = 2$, the two terms in the minimum are roughly comparable, ignoring logarithmic terms, for

$$\delta|F| \simeq \sigma^{2+\kappa/50}.$$

Therefore, we set

$$\begin{aligned} T_1 &= \{(\delta, \sigma) \in \mathbf{2} \times \mathbf{2} \mid \delta|F| \leq \sigma^{2+\kappa/50} \leq |F|\}, \\ T_2 &= \{(\delta, \sigma) \in \mathbf{2} \times \mathbf{2} \mid \sigma^{2+\kappa/50} \leq \delta|F|\} \end{aligned}$$

and $T_3 = \mathbf{2} \times \mathbf{2} - T_1 - T_2$.

We can estimate

$$\begin{aligned} \sum_{(\delta, \sigma) \in T_1} \text{Sum}(\mathbf{S}_{\delta, \sigma}^2) &\lesssim \sum_{(\delta, \sigma) \in T_1} \Psi(\delta) \sigma^{-1} (\log 1/\sigma)^4 |F| \\ &\lesssim \sum_{\substack{\sigma \in \mathbf{2} \\ \sigma^{2+\kappa/50} \leq |F|}} \sigma^{1+\kappa/75} \\ &\lesssim |F|^{1/p_0}, \quad p_0 = \frac{2 + \kappa/50}{1 + \kappa/75} < 2. \end{aligned}$$

Notice that we have absorbed harmless logarithmic terms into a slightly smaller exponent in σ above.

The second term is

$$\begin{aligned} \sum_{(\delta, \sigma) \in T_2} \text{Sum}(\mathbf{S}_{\delta, \sigma}^2) &\lesssim \sum_{(\delta, \sigma) \in T_2} \sigma^{1+\kappa/50} \\ &\lesssim \sum_{\delta \in \mathbf{2}} (\delta F)^{1/p_1}, \quad p_1 = \frac{2 + \kappa/50}{1 + \kappa/50} < 2, \\ &\lesssim |F|^{1/p_1}. \end{aligned}$$

The third term is

$$\begin{aligned}
\sum_{(\delta, \sigma) \in T_3} \text{Sum}(\mathbf{S}_{\delta, \sigma}^2) &\lesssim \sum_{(\delta, \sigma) \in T_3} \Psi(\delta) \sigma^{-1} (\log 1/\sigma)^4 |F| \\
&\lesssim \sum_{\substack{\sigma \in \mathbf{2} \\ \sigma^{2+\kappa/50} \geq |F|}} \sigma^{-1} |F|^{1-\kappa/75} \\
&\lesssim |F|^{1/p_0}.
\end{aligned}$$

Here, we have again absorbed harmless logarithms into a slightly smaller power of $|F|$, and $p_0 < 2$ is as in the first term.

The novelty in this proof is the proof of (4.64) in the case of $\ell = 1$. We comment that if one uses the proof strategy just employed, that is only relying upon the first and last estimates from the minimum in (4.63), in the case of $\ell = 1$, one will only show that $|F|^{1/2}$.

In the definitions below, we will have a choice of $0 < \tau < 1$, where $\tau = \tau(M, p) \simeq M^{-1} \cdot (2-p)$ will only depend upon M and p in (4.63). (τ enters into the definition of T_4 and T_5 below.) The choice of $0 < \kappa < \tau$ will be specified below.

$$\begin{aligned}
T_1 &= \{(\delta, \sigma) \in \mathbf{2} \times \mathbf{2} \mid |F|^{\frac{1}{(2+\kappa)(1+\kappa)}} \leq \sigma\}, \\
T_2 &= \{(\delta, \sigma) \in \mathbf{2} \times \mathbf{2} \mid \sigma < |F|^{\frac{1}{2-\kappa}}, \delta \geq \sigma^{1/\kappa}\}, \\
T_3 &= \{(\delta, \sigma) \in \mathbf{2} \times \mathbf{2} \mid \sigma < |F|^{\frac{1}{2-\kappa}}, \delta > \sigma^{1/\kappa}\}, \\
T_4 &= \{(\delta, \sigma) \in \mathbf{2} \times \mathbf{2} \mid |F|^{\frac{1}{2-\kappa}} \leq \sigma < |F|^{\frac{1}{(2+\kappa)(1+\kappa)}}, \delta > \sigma^\tau\}, \\
T_5 &= \{(\delta, \sigma) \in \mathbf{2} \times \mathbf{2} \mid |F|^{\frac{1}{2-\kappa}} \leq \sigma < |F|^{\frac{1}{(2+\kappa)(1+\kappa)}}, \delta \leq \sigma^\tau\},
\end{aligned}$$

Let

$$\mathcal{T}(T) = \sum_{(\delta, \sigma) \in T} \text{Sum}(\mathbf{S}_{\delta, \sigma}^1).$$

Note that for T_1 we can use the first term in the minimum in (4.63).

$$\begin{aligned}
\mathcal{T}(T_1) &\lesssim \sum_{(\delta, \sigma) \in T_1} \delta \sigma^{-1-\kappa} |F| \\
&\lesssim \sum_{\substack{\sigma \in \mathbf{2} \\ \sigma \geq |F|^{\frac{1}{(2+\kappa)(1+\kappa)}}}} \sigma^{-1-\kappa} |F| \\
&\lesssim |F|^{1-\frac{1}{2+\kappa}}.
\end{aligned}$$

This last exponent on $|F|$ is strictly larger than $\frac{1}{2}$ as desired. The point of the definition of T_1 is that when it comes time to use the middle term

of the minimum for $\ell = 1$ in (4.63), we can restrict attention to the term

$$\delta^{-M+1}\sigma^{-p+1}|F|.$$

For the collection T_2 , use the last term in the minimum in (4.63).

$$\begin{aligned} \mathcal{T}(T_2) &\lesssim \sum_{(\delta,\sigma)\in T_2} \sigma \\ &\lesssim \sum_{\substack{\sigma\in\mathbf{2} \\ \sigma\leq|F|^{\frac{1}{2-\kappa}}}} \sigma \log 1/\sigma \\ &\lesssim |F|^{\frac{1}{2-\kappa/2}}. \end{aligned}$$

Again, for $0 < \kappa < 1$, the exponent on $|F|$ above is strictly greater than $1/2$.

The term T_3 can be controlled with the first term in the minimum in (4.63).

$$\begin{aligned} \mathcal{T}(T_3) &\lesssim \sum_{(\delta,\sigma)\in T_3} \delta\sigma^{-1-\kappa}|F| \\ &\lesssim \sum_{\sigma\in\mathbf{2}} \sigma|F| \lesssim |F|. \end{aligned}$$

The term T_4 is the heart of the matter. It is here that we use the middle term in the minimum of (4.63), and that the role of τ becomes clear. We estimate

$$\begin{aligned} \mathcal{T}(T_4) &\lesssim \sum_{(\delta,\sigma)\in T_4} \delta^{-M}\sigma^{-p+1}|F| \\ &\lesssim \sum_{\substack{\delta\in\mathbf{2} \\ \delta\geq|F|^\tau}} \delta^{-M}|F|^{1-\frac{p-1}{2-\kappa}} \\ &\lesssim |F|^{1-\frac{p-1}{2-\kappa}-M\tau}. \end{aligned}$$

Recall that $1 < p < 2$, so that $0 < p - 1 < 1$. Therefore, for $0 < \kappa$ sufficiently small, of the order of $2 - p$, we will have

$$1 - \frac{p-1}{2-\kappa} > \frac{1}{2} + \frac{2-p}{4}.$$

Therefore, choosing $\tau \simeq (2-p)/M$ will leave us with a power on $|F|$ that is strictly larger than $\frac{1}{2}$.

The previous term did not specify $\kappa > 0$. Instead it shows that for $0 < \kappa < 1$ sufficiently small, we can make a choice of τ , that is

independent of κ , for which $\mathcal{T}(T_4)$ admits the required control. The bound in the last term will specify a choice of κ on us. We estimate

$$\begin{aligned} \mathcal{T}(T_5) &\lesssim \sum_{(\delta, \sigma) \in T_5} \delta \sigma^{-1-\kappa} |F| \\ &\lesssim \sum_{\substack{\sigma \in 2 \\ \sigma \geq |F|^{\frac{1}{2-\kappa}}}} \sigma^{-1-\kappa} |F|^{1+\tau} \\ &\lesssim |F|^{1+\tau+\frac{1+\kappa}{2-\kappa}} \end{aligned}$$

Choosing $\kappa = \tau/6$ will result in the estimate

$$|F|^{\frac{1+\tau}{2}},$$

which is as required, so our proof is finished. \square

Remark 4.65. The resolution of Conjecture 1.21 would depend upon refinements of Lemma 4.50, as well as using the restricted weak type approach of [21].

Proof of Lemma 4.34. We only consider tiles $s \in \mathcal{AT}(\text{ann}, \text{scl})$, and sets $\omega \in \Omega$ which are associated to one of these tiles. For an element $a = \{a_s\} \in \ell^2(\mathcal{AT}(\text{ann}, \text{scl}))$,

$$T_\omega a = \sum_{s: \omega_s = \omega} a_s S_{\text{ann}} \alpha_s$$

For $|\omega_s| = |\omega_{s'}|$, note that $\text{dist}(\omega_s, \omega_{s'})$ is measured in units of scl/ann .

By a lemma of Cotlar and Stein, it suffices to provide the estimate

$$\|T_\omega T_{\omega'}^*\|_2 \lesssim \rho^{-3}, \quad \rho = 1 + \frac{\text{ann}}{\text{scl}} \text{dist}(\omega, \omega').$$

Now, the estimate $\|T_\omega\|_2 \lesssim 1$ is obvious. For the case $\omega \neq \omega'$, by Schur's test, it suffices to see that

$$(4.66) \quad \sup_{s': \omega_{s'} = \omega'} \sum_{s: \omega_s = \omega} |\langle S_{\text{ann}} \alpha_s, S_{\text{ann}} \alpha_{s'} \rangle| \lesssim \rho^{-3}.$$

For tiles s' and s as above, recall that $\langle \varphi_s, \varphi_{s'} \rangle = 0$, note that

$$\frac{|R_{s'} \cap R_s|}{|R_s|} \lesssim \frac{\text{scl}}{\text{ann} \text{dist}(\omega, \omega')} \simeq \rho^{-1},$$

and in particular, for a fixed s' , let $\mathbf{S}_{s'}$ be those s for which $\rho R_s \cap \rho R_{s'} \neq \emptyset$. Clearly,

$$\text{card}(\mathbf{S}_{s'}) \lesssim \frac{|\rho R_s|}{|2\rho R_{s'} \cap 2\rho R_s|} \rho \simeq \rho^2$$

If for $r > 1$, $rR_s \cap rR_{s'} = \emptyset$, then it is routine to show that

$$|\langle S_{\text{ann}}\alpha_s, S_{\text{ann}}\alpha_{s'} \rangle| \lesssim r^{-10}$$

And so we may directly sum over those $s \notin \mathbf{S}_{s'}$,

$$\sum_{s \notin \mathbf{S}_{s'}} |\langle S_{\text{ann}}\alpha_s, S_{\text{ann}}\alpha_{s'} \rangle| \lesssim \rho^{-3}.$$

For those $s \in \mathbf{S}_{s'}$, we estimate the inner product in frequency variables. Recalling the definition of $\alpha_s = (\mathbb{T}_{c(R_s)} D_{\gamma_s R_s}^\infty \zeta) \varphi_s$, we have

$$\widehat{\alpha}_s = (\text{Mod}_{-c(R_s)} D_{\gamma_s^{-1} \omega_s}^1 \widehat{\zeta}) * \widehat{\varphi}_s.$$

Recall that ζ is a smooth compactly supported Schwartz function. We estimate the inner product

$$|\langle \widehat{S_{\text{ann}}\alpha_s}, \widehat{S_{\text{ann}}\alpha_{s'}} \rangle|$$

without appealing to cancellation. Since we choose the function $\widehat{\lambda}$ to be supported in an annulus $\frac{1}{2} < |\xi| < \frac{3}{2}$ so that $\widehat{\lambda_{\text{ann}}} = \widehat{\lambda}(\cdot/\text{ann})$ is supported in the annulus $\frac{1}{2}\text{ann} < |\xi| < \frac{3}{2}\text{ann}$. We can restrict our attention to this same range of ξ . In the region $|\xi| > \text{ann}/4$, suppose, without loss of generality, that ξ is closer to ω_s than $\omega_{s'}$. Then since ω_s and $\omega_{s'}$ are separated by an amount $\gtrsim \text{ann} \text{dist}(\omega, \omega')$,

$$\begin{aligned} |\widehat{\alpha}_s(\xi) \widehat{\alpha}_{s'}(\xi)| &\lesssim \chi_{\omega_s}^{(2)}(\xi) \chi_{\omega_{s'}}^{(2)}(\xi) \left(\frac{\text{ann}}{\text{scl}} \text{dist}(\omega, \omega') \right)^{-20} \\ &\lesssim \chi_{\omega_s}^{(2)}(\xi) \chi_{\omega_{s'}}^{(2)}(\xi) \rho^{-20}. \end{aligned}$$

Here, χ is the non-negative bump function in (4.40). Hence, we have the estimate

$$\int |\widehat{\lambda_{\text{ann}}}(\xi)|^2 |\widehat{\alpha}_s(\xi) \widehat{\alpha}_{s'}(\xi)| d\xi \lesssim \rho^{-10}.$$

This is summed over the $\lesssim \rho^2$ possible choices of $s \in \mathbf{S}_{s'}$, giving the estimate

$$\sum_{s \in \mathbf{S}_{s'}} |\langle S_{\text{ann}}\alpha_s, S_{\text{ann}}\alpha_{s'} \rangle| \lesssim \rho^{-8} \lesssim \rho^{-3}.$$

This is the proof of (4.66). And this concludes the proof of Lemma 4.34.

Proof of the Principal Organizational Lemma 4.50. Recall that we are to decompose \mathbf{S} into four distinct subsets satisfying the favorable estimates of that Lemma. For the remainder of the proof set $\text{dense}(\mathbf{S}) := \delta$ and $\text{size}(\mathbf{S}) := \sigma$. Take $\mathbf{S}_{\text{light}}$ to be all those $s \in \mathbf{S}$ for which there is no tile $s' \in \mathcal{AT}$ of density at least $\delta/2$ for which $s \lesssim s'$. It is clear that this set so constructed has density at most $\delta/2$, that this is a set of tiles, and that $\mathbf{S}_1 := \mathbf{S} - \mathbf{S}_{\text{light}}$ is also .

The next Lemma and proof comment on the method we use to obtain the middle estimate in (4.53) which depends upon the Lipschitz Keakeya Maximal Function Conjecture 1.14. It will be used to obtain the important inequality (4.82) below.

Lemma 4.67. *Suppose we have a collection of trees $\mathbf{T} \in \mathcal{T}$, with these conditions.*

a: *For $\mathbf{T} \in \mathcal{T}$ there is a 1-tree $\mathbf{T}_1 \subset \mathbf{T}$ with*

$$(4.68) \quad \int_{R_{\mathbf{T}}} \Delta(\mathbf{T}_1) dx \geq \kappa \sigma,$$

b: *Each tree has top element $s(\mathbf{T}) := \omega_{\mathbf{T}} \times R_{\mathbf{T}}$ of density at least δ .*

c: *The collections of tops $\{s(\mathbf{T}) \mid \mathbf{T} \in \mathcal{T}\}$ are pairwise incomparable under the order relation \lesssim .*

d: *For all $\mathbf{T} \in \mathcal{T}$, $\gamma_{\mathbf{T}} = \gamma_{\omega_{\mathbf{T}} \times R_{\mathbf{T}}} \geq \kappa^{-1/2} \sigma^{-\kappa/5N}$. Here, N is the exponent on δ in Conjecture 1.14.*

Then we have

$$(4.69) \quad \sum_{\mathbf{T} \in \mathcal{T}} |R_{\mathbf{T}}| \lesssim \delta^{-Np-1} \sigma^{-p(1+\kappa/4)} |F| + \sigma^{1/\kappa} \delta^{-1}.$$

$$(4.70) \quad \sum_{\mathbf{T} \in \mathcal{T}} |R_{\mathbf{T}}| \lesssim \delta^{-1}.$$

Concerning the role of $\gamma_{\mathbf{T}}$, recall from the definition, (4.29), that γ_s is a quantity that grows as does the ratio $\text{scl}(s)/\|v\|_{\text{Lip}}$, hence there are only $\lesssim \log \sigma^{-1}$ scales of tiles that do not satisfy the assumption **d** above.

PROOF. Our primary interest is in (4.69), which is a consequence of our assumption about the Lipschitz Keakeya Maximal Functions, Conjecture 1.12.

Set

$$\mathbf{s}(\mathbf{T}) := \omega_{\mathbf{T}} \times \sigma^{-\kappa/10N} R_{\mathbf{T}}.$$

Let us begin by noting that

$$(4.71) \quad \kappa^{-1} \|v\|_{\text{Lip}} \leq \text{scl}(\mathbf{s}(\mathbf{T})) \leq \kappa \text{ann}(\mathbf{s}(\mathbf{T})), \quad \mathbf{T} \in \mathcal{T},$$

$$(4.72) \quad \text{dense}(\mathbf{s}(\mathbf{T})) \geq \delta \sigma^{\kappa/10N}, \quad \mathbf{T} \in \mathcal{T},$$

$$(4.73) \quad |F \cap R_{\mathbf{s}(\mathbf{T})}| \geq \sigma^{1+\kappa/4N} |R_{\mathbf{s}(\mathbf{T})}|.$$

The conclusion (4.71) is straightforward, as is (4.72). The inequality (4.73) follows from Lemma 4.55.

Note that the length of $\sigma^{-\kappa/10N} R_{\mathbf{T}}$ satisfies

$$(4.74) \quad \begin{aligned} \sigma^{-\kappa/10N} \mathbf{L}(R_{\mathbf{T}}) &\leq \gamma_{\mathbf{T}} \mathbf{L}(R_{\mathbf{T}}) \\ &\leq \sqrt{\frac{\text{scl}(s)}{\|v\|_{\text{Lip}}}} \leq (100\|v\|_{\text{Lip}})^{-1}. \end{aligned}$$

This is the condition (1.8) that we impose in the definition of the Lipschitz Keakeya Maximal Functions.

Observe that we can regard $\text{ann}(s(\mathbf{T})) \simeq \sigma^{\kappa/10} \mathbf{ann}$ as a constant independent of \mathbf{T} .

The point of these observations is that our assumption about the Lipschitz Keakeya Maximal Function applies to the maximal function formed over the set of tiles $\{s(\mathbf{T}) \mid \mathbf{T} \in \mathcal{T}\}$. And it will be applied below.

Let \mathcal{T}_k be the collection of trees so that $\mathbf{T} \in \mathcal{T}_k$ if $k \geq 0$ is the smallest integer such that

$$(4.75) \quad |(2^k R_{\mathbf{T}}) \cap v^{-1}(\omega_{\mathbf{T}}) \cap G| \geq 2^{20k/\kappa^2-1} \delta |R_{\mathbf{T}}|.$$

Then since the density of $s(\mathbf{T})$ for every tree $\mathbf{T} \in \mathcal{T}$ is at least δ , we have $\mathcal{T} = \bigcup_{k=0}^{\infty} \mathcal{T}_k$. We can apply Conjecture 1.12 to these collections, with the value of δ in that Conjecture being $2^{20k/\kappa^2-1} \delta$.

For each \mathcal{T}_k , we decompose it by the following algorithm. Initialize

$$\mathcal{T}_k^{\text{selected}} \leftarrow \emptyset, \quad \mathcal{T}_k^{\text{stock}} \leftarrow \mathcal{T}_k.$$

While $\mathcal{T}_k^{\text{stock}} \neq \emptyset$, select $\mathbf{T} \in \mathcal{T}_k^{\text{stock}}$ such that $\text{scl}(s(\mathbf{T}))$ is minimal. Define $\mathcal{T}_k(\mathbf{T})$ by

$$\mathcal{T}_k(\mathbf{T}) = \{\mathbf{T}' \in \mathcal{T}_k : (2^k R_{\mathbf{T}}) \cap (2^k R_{\mathbf{T}'}) \neq \emptyset \text{ and } \omega_{\mathbf{T}} \subset \omega_{\mathbf{T}'}\}.$$

Update

$$\mathcal{T}_k^{\text{selected}} \leftarrow \mathcal{T}_k^{\text{selected}} \cup \{\mathbf{T}\}, \quad \mathcal{T}_k^{\text{stock}} \leftarrow \mathcal{T}_k^{\text{stock}} \setminus \mathcal{T}_k(\mathbf{T}).$$

Thus we decompose \mathcal{T}_k into

$$\mathcal{T}_k = \bigcup_{\mathbf{T} \in \mathcal{T}_k^{\text{selected}}} \bigcup_{\mathbf{T}' \in \mathcal{T}_k(\mathbf{T})} \{\mathbf{T}'\}.$$

And

$$\sum_{\mathbf{T} \in \mathcal{T}_k} |R_{\mathbf{T}}| = \sum_{\mathbf{T} \in \mathcal{T}_k^{\text{selected}}} \sum_{\mathbf{T}' \in \mathcal{T}_k(\mathbf{T})} |R_{\mathbf{T}'}|.$$

Notice that $R_{\mathbf{T}'}$'s are disjoint for all $\mathbf{T}' \in \mathcal{T}_k(\mathbf{T})$ and they are contained in $5(2^k R_{\mathbf{T}})$. This is so, since the tops of the trees are assumed to be incomparable with respect to the order relation ' \lesssim ' on tiles.

Thus we have

$$\begin{aligned} \sum_{\mathbf{T} \in \mathcal{T}_k} |R_{\mathbf{T}}| &\lesssim \sum_{\mathbf{T} \in \mathcal{T}_k^{\text{selected}}} 2^{2k} |R_{\mathbf{T}}| \\ &\lesssim \delta^{-1} 2^{-10k/\kappa^2} \sum_{\mathbf{T} \in \mathcal{T}_k^{\text{selected}}} |(2^k R_{\mathbf{T}}) \cap v^{-1}(\omega_{\mathbf{T}}) \cap G|. \end{aligned}$$

Observe that $(2^k R_{\mathbf{T}}) \cap v^{-1}(\omega_{\mathbf{T}})$'s are disjoint for all $\mathbf{T} \in \mathcal{T}_k^{\text{selected}}$. This and the fact that $|G| \leq 1$ proves (4.70). To argue for (4.69), we see that

$$\begin{aligned} \sum_{\mathbf{T} \in \mathcal{T}_k} |R_{\mathbf{T}}| &\lesssim \delta^{-1} 2^{-10k/\kappa^2} \left| \bigcup_{\mathbf{T} \in \mathcal{T}_k^{\text{selected}}} (2^k R_{\mathbf{T}}) \cap v^{-1}(\omega_{\mathbf{T}}) \cap G \right| \\ &\lesssim \delta^{-1} 2^{-10k/\kappa^2} \left| \bigcup_{\mathbf{T} \in \mathcal{T}_k} (2^k R_{\mathbf{T}}) \cap G \right|. \end{aligned}$$

At this point, Conjecture 1.12 enters. Observe that we can estimate

$$\begin{aligned} (4.76) \quad \left| \bigcup_{\mathbf{T} \in \mathcal{T}_k} 2^k R_{\mathbf{T}} \right| &\lesssim |\{M_{\delta', v, (\sigma^{\kappa/10} \text{ann})^{-1}} \mathbf{1}_F > \sigma^{1+\kappa/4N}\}| \\ &\lesssim (\delta')^{-Np} \sigma^{-p(1+\kappa/4N)} |F|. \\ &\lesssim (\delta)^{-Np} 2^{-k} \sigma^{-p(1+\kappa/4N)} |F|. \end{aligned}$$

Here, $\delta' = 2^{20k/\kappa^2-1} \delta$, the choice of δ' permitted to us by (4.75), and we have used (4.73) in the first line, to pass to the Lipschitz Kakeya Maximal Function.

Hence,

$$\begin{aligned} \sum_{\mathbf{T} \in \mathcal{T}} |\text{sh}(\mathbf{T})| &\lesssim \sum_{k=0}^{\infty} \sum_{\mathbf{T} \in \mathcal{T}_k} |R_{\mathbf{T}}| \\ &\lesssim \delta^{-1} \sum_{k=0}^{\infty} 2^{-10k/\kappa^2} \left| \bigcup_{\mathbf{T} \in \mathcal{T}_k} (2^k R_{\mathbf{T}}) \cap G \right| \\ &\lesssim \delta^{-1} \sum_{k: 1 \leq 2^k \leq \sigma^{-\kappa/10}} 2^{-k} \left| \bigcup_{\mathbf{T} \in \mathcal{T}_k} (2^k R_{\mathbf{T}}) \right| \\ &\quad + \delta^{-1} \sum_{k: 2^k > \sigma^{-\kappa/10}} 2^{-10k/\kappa^2} |G|. \end{aligned}$$

On the first sum in the last line, we use (4.76), and on the second, we just sum the geometric series, and recall that $|G| = 1$. \square

We can now begin the principal line of reasoning for the proof of Lemma 4.50.

The Construction of $\mathbf{S}_{\text{large}}^1$. We use an orthogonality, or $\mathbf{T}\mathbf{T}^*$ argument that has been used many times before, especially in [20] and [15]. (There is a feature of the current application of the argument that is present due to the fact that we are working on the plane, and it is detailed by Lacey and Li [15].)

We may assume that all intervals ω_s are contained in the upper half of the unit circle in the plane. Fix $\mathbf{S} \subset \mathcal{A}_v$, and $\sigma = \text{size}(\mathbf{S})$.

We construct a collection of trees $\mathcal{T}_{\text{large}}^1$ for the collection \mathbf{S}_1 , and a corresponding collection of 1-trees $\mathcal{T}_{\text{large}}^{1,1}$, with particular properties. We begin the recursion by initializing

$$\begin{aligned} \mathcal{T}_{\text{large}}^1 &\leftarrow \emptyset, & \mathcal{T}_{\text{large}}^{1,1} &\leftarrow \emptyset, \\ \mathbf{S}_{\text{large}}^1 &\leftarrow \emptyset, & \mathbf{S}^{\text{stock}} &\leftarrow \mathbf{S}_1. \end{aligned}$$

In the recursive step, if $\text{size}(\mathbf{S}^{\text{stock}}) < \frac{1}{2}\sigma^{1+\kappa/100}$, then this recursion stops. Otherwise, we select a tree $\mathbf{T} \subset \mathbf{S}^{\text{stock}}$ such that three conditions are met.

- a:** The top of the tree $s(\mathbf{T})$ (which need not be in the tree) satisfies $\text{dense}(s(\mathbf{T})) \geq \delta/4$.
- b:** \mathbf{T} contains a 1-tree \mathbf{T}^1 with

$$(4.77) \quad \int_{R_{\mathbf{T}}} \Delta(\mathbf{T}^1) dx \geq \frac{1}{2}\sigma^{1+\kappa/100}.$$

- c:** And that $\omega_{\mathbf{T}}$ is in the first place minimal and in the second most clockwise among all possible choices of \mathbf{T} . (Since all ω_s are in the upper half of the unit circle, this condition can be fulfilled.)

We take \mathbf{T} to be the maximal tree in $\mathbf{S}^{\text{stock}}$ which satisfies these conditions.

We then update

$$\begin{aligned} \mathcal{T}_{\text{large}}^1 &\leftarrow \{\mathbf{T}\} \cup \mathcal{T}_{\text{large}}^1, & \mathcal{T}_{\text{large}}^{1,1} &\leftarrow \{\mathbf{T}^1\} \cup \mathcal{T}_{\text{large}}^{1,1}, \\ \mathbf{S}_{\text{large}}^1 &\leftarrow \mathbf{T} \cup \mathbf{S}_{\text{large}}^1 & \mathbf{S}^{\text{stock}} &\leftarrow \mathbf{S}^{\text{stock}} - \mathbf{T}. \end{aligned}$$

The recursion then repeats. Once the recursion stops, we update

$$\mathbf{S}_1 \leftarrow \mathbf{S}_{\text{stock}}$$

It is this collection that we analyze in the next subsection.

Note that it is a consequence of the recursion, and Remark 4.44, that the tops of the trees $\{s(\mathbf{T}) \mid \mathbf{T} \in \mathcal{T}_{\text{large}}^1\}$ are pairwise incomparable under \lesssim .

The bottom estimate of (4.53) is then immediate from the construction and (4.70).

First, we turn to the deduction of the first estimate of (4.53). Let $\mathcal{T}_{\text{large}}^{1,(1)}$ be the set

$$\mathcal{T}_{\text{large}}^{1,(1)} = \left\{ \mathbf{T} \in \mathcal{T}_{\text{large}}^1 : \sum_{s \in \mathbf{T}^1} |\langle S_{\text{ann}} \mathbf{1}_F, \beta_s \rangle|^2 < \frac{1}{16} \sigma^{2+\kappa/50} |R_{\mathbf{T}}| \right\}.$$

And let $\mathcal{T}_{\text{large}}^{1,(2)}$ be the set

$$\mathcal{T}_{\text{large}}^{1,(2)} = \left\{ \mathbf{T} \in \mathcal{T}_{\text{large}}^1 : \sum_{s \in \mathbf{T}^1} |\langle S_{\text{ann}} \mathbf{1}_F, \beta_s \rangle|^2 \geq \frac{1}{16} \sigma^{2+\kappa/50} |R_{\mathbf{T}}| \right\}.$$

In the inner products, we are taking β_s , which is supported off of $\gamma_s R_s$. Since $\mathbf{T} \in \mathcal{T}_{\text{large}}^1$ satisfies

$$(4.78) \quad \int_{R_{\mathbf{T}}} \Delta(\mathbf{T}) \, dx \geq \frac{1}{2} \sigma^{1+\kappa/100},$$

we have

$$\sum_{s \in \mathbf{T}^1} |\langle S_{\text{ann}} \mathbf{1}_F, \alpha_s \rangle|^2 \geq \frac{1}{4} \sigma^{2+\kappa/50} |R_{\mathbf{T}}|.$$

Thus, if $\mathbf{T} \in \mathcal{T}_{\text{large}}^{1,(1)}$, we have

$$\sum_{s \in \mathbf{T}^1} |\langle \mathbf{1}_F, \varphi_s \rangle|^2 \geq \frac{1}{8} \sigma^{2+\kappa/50} |R_{\mathbf{T}}|.$$

The replacement of α_s by φ_s in the inequality above is an important point for us. That we can then drop the S_{ann} is immediate.

With this construction and observation, we claim that

$$(4.79) \quad \sum_{\mathbf{T} \in \mathcal{T}_{\text{large}}^{1,(1)}} |R_{\mathbf{T}}| \lesssim (\log 1/\sigma)^2 \sigma^{-2-\kappa/50} |F|.$$

PROOF OF (4.79). This is a variant of the the argument for the ‘Size Lemma’ in [15], and so we will not present all details. Begin by making a further decomposition of the trees $\mathbf{T} \in \mathcal{T}_{\text{large}}^{1,(1)}$. To each such tree, we have a 1-tree $\mathbf{T}^1 \subset \mathbf{T}$ which satisfies (4.77). We decompose \mathbf{T}^1 . Set

$$\begin{aligned} \mathbf{T}^1(0) &= \left\{ s \in \mathbf{T}^1 \mid \frac{|\langle f, \varphi_s \rangle|}{\sqrt{|R_s|}} < \sigma^{1+\kappa/100} \right\}, \\ \mathbf{T}^1(j) &= \left\{ s \in \mathbf{T}^1 \mid 4^{j-1} \sigma^{1+\kappa/100} \leq \frac{|\langle f, \varphi_s \rangle|}{\sqrt{|R_s|}} < 4^j \sigma^{1+\kappa/100} \right\}, \\ 1 &\leq j \leq j_0 = C \log 1/\sigma. \end{aligned}$$

Now, set $\mathcal{T}(j)$ to be those $\mathbf{T} \in \mathcal{T}_{\text{large}}^{1,(1)}$ for which

$$(4.80) \quad \sum_{s \in \mathbf{T}^1(j)} |\langle f, \varphi_s \rangle|^2 \geq (2j_0)^{-1} \sigma^{2+\kappa/50} |R_{\mathbf{T}}|, \quad 0 \leq j \leq j_0.$$

It is the case that each $\mathbf{T} \in \mathcal{T}_{\text{large}}^{1,(1)}$ is in some $\mathcal{T}(j)$, for $0 \leq j \leq j_0$.

The central case is that of $j = 0$. We can apply the ‘Size Lemma’ of [15] to deduce that

$$\begin{aligned} \sum_{\mathbf{T} \in \mathcal{T}(0)} |R_{\mathbf{T}}| &\leq (2j_0) \sigma^{-2-\kappa/50} \sum_{\mathbf{T} \in \mathcal{T}(0)} \sum_{s \in \mathbf{T}^1(0)} |\langle f, \varphi_s \rangle|^2 \\ &\lesssim (\log 1/\sigma) \sigma^{-2-\kappa/50} |F|. \end{aligned}$$

The point here is that to apply the argument in the ‘Size Lemma’ one needs an average case estimate, namely (4.80), as well as a uniform control, namely the condition defining $\mathbf{T}^1(0)$. This proves (4.79) in this case.

For $1 \leq j \leq j_0$, we can apply the ‘Size Lemma’ argument to the individual tiles in the collection

$$\bigcup \{ \mathbf{T}^1(j) \mid T \in \mathcal{T}(j) \}.$$

The individual tiles satisfy the definition of a 1-tree. And the defining condition of $\mathbf{T}^1(j)$ is both the average case estimate, and the uniform control needed to run that argument. In this case we conclude that

$$\sum_{\mathbf{T} \in \mathcal{T}(j)} \sum_{s \in \mathbf{T}^1(j)} |\langle f, \varphi_s \rangle|^2 \lesssim |F|.$$

Thus, we can estimate

$$\sum_{\mathbf{T} \in \mathcal{T}(j)} |R_{\mathbf{T}}| \lesssim (\log 1/\sigma) \sigma^{-1-\kappa/50} |F|.$$

This summed over $1 \leq j \leq j_0 = C \log 1/\sigma$ proves (4.79). \square

For $\mathcal{T}_{\text{large}}^{1,(2)}$, we have

$$\begin{aligned} \sum_{T \in \mathcal{T}_{\text{large}}^{1,(2)}} |R_{\mathbf{T}}| &\lesssim \sigma^{-2-\kappa/50} \sum_{\text{scl} \geq \kappa^{-1} \|v\|_{\text{Lip}}} \sum_{s: \text{scl}(s) = \text{scl}} |\langle S_{\text{ann}} \mathbf{1}_F, \beta_s \rangle|^2 \\ &\lesssim \sigma^{-2-\kappa/50} |F| \sum_{\text{scl} \geq \kappa^{-1} \|v\|_{\text{Lip}}} \left(\frac{\|v\|_{\text{Lip}}}{\text{scl}} \right)^{100} \\ &\lesssim \sigma^{-2-\kappa/50} |F|, \end{aligned}$$

since β_s has fast decay. The Bessel inequality in the last display can be obtained by using the same argument in the proof of Lemma 4.34. Hence we get

$$(4.81) \quad \sum_{T \in \mathcal{T}_{\text{large}}^{1,(2)}} |R_{\mathbf{T}}| \lesssim \sigma^{-2-\kappa/50} |F|.$$

Combining (4.79) and (4.81), we obtain the first estimate of (4.53).

Second, we turn to the deduction of the middle estimate of (4.53), which relies upon the Lipschitz Keakeya Maximal Function. Let $\mathcal{T}_{\text{large}}^{1,\text{good}}$ be the set

$$\{\mathbf{T} \in \mathcal{T}_{\text{large}}^1 : \gamma_{\mathbf{T}} \geq \kappa^{-1/2} \sigma^{-\kappa/5N}\}.$$

And let $\mathcal{T}_{\text{large}}^{1,\text{bad}}$ be the set

$$\{\mathbf{T} \in \mathcal{T}_{\text{large}}^1 : \gamma_{\mathbf{T}} < \kappa^{-1/2} \sigma^{-\kappa/5N}\}.$$

The ‘good’ collection can be controlled by facts which we have already marshaled together. In particular, we have been careful to arrange the construction so that Lemma 4.67 applies. By the main conclusion of that Lemma, (4.69), we have

$$(4.82) \quad \sum_{\mathbf{T} \in \mathcal{T}_{\text{large}}^{1,\text{good}}} |R_{\mathbf{T}}| \lesssim \delta^{-M} \sigma^{-1-3\kappa/4} |F| + \sigma^{1/\kappa} \delta^{-1}.$$

Here, M is a large constant that only depends upon N in Conjecture 1.14.

For $\mathbf{T} \in \mathcal{T}_{\text{large}}^{1,\text{bad}}$, there are at most $K = O(\log(\sigma^{-\kappa}))$ many possible scales for $\text{scl}(\omega_{\mathbf{T}} \times R_{\mathbf{T}})$. Let $\text{scl}(\mathbf{T}) = \text{scl}(\omega_{\mathbf{T}} \times R_{\mathbf{T}})$. Thus we have

$$\sum_{\mathbf{T} \in \mathcal{T}_{\text{large}}^{1,\text{bad}}} |R_{\mathbf{T}}| \lesssim \sum_{m=0}^K \sum_{\mathbf{T}: \text{scl}(\mathbf{T})=2^m \kappa^{-1} \|v\|_{\text{Lip}}} |R_{\mathbf{T}}|.$$

Since \mathbf{T} satisfies (4.78), we have

$$|F \cap \gamma_{\mathbf{T}} R_{\mathbf{T}}| \gtrsim \sigma^{1+\kappa/2} |R_{\mathbf{T}}|.$$

Thus, we get

$$\sum_{\mathbf{T} \in \mathcal{T}_{\text{large}}^{1,\text{bad}}} |R_{\mathbf{T}}| \lesssim \sigma^{-1-\kappa/2} \sum_{m=0}^K \int_F \sum_{\mathbf{T}: \text{scl}(\mathbf{T})=2^m \kappa^{-1} \|v\|_{\text{Lip}}} \mathbf{1}_{\sigma^{-\kappa} R_{\mathbf{T}}}(x) dx.$$

For the tiles with a fixed scale, we have the following inequality, which is a consequence of Lemma 4.25.

$$\left\| \sum_{\mathbf{T}: \text{scl}(\mathbf{T})=2^m \kappa^{-1} \|v\|_{\text{Lip}}} \mathbf{1}_{\sigma^{-\kappa} R_{\mathbf{T}}} \right\|_{\infty} \lesssim \sigma^{-\kappa/5} \delta^{-1}.$$

Hence we obtain

$$(4.83) \quad \sum_{\mathbf{T} \in \mathcal{T}_{\text{large}}^{1, \text{bad}}} |R_{\mathbf{T}}| \lesssim \delta^{-1} \sigma^{-1-3\kappa/4} |F|.$$

Combining (4.82) and (4.83), we obtain the middle estimate of (4.53). Therefore, we complete the proof of (4.53).

The Construction of $\mathbf{S}_{\text{large}}^2$. It is important to keep in mind that we have only removed trees of nearly maximal size, with tops of a given density. In the collection of tiles that remain, there can be trees of large size, but they cannot have a top with nearly maximal density. We repeat the $\mathbf{T} \mathbf{T}^*$ construction of the previous step in the proof, with two significant changes.

We construct a collection of trees $\mathcal{T}_{\text{large}}^2$ from the collection \mathbf{S}_1 , and a corresponding collection of 1-trees $\mathcal{T}_{\text{large}}^{2,1}$, with particular properties. We begin the recursion by initializing

$$\begin{aligned} \mathcal{T}_{\text{large}}^2 &\leftarrow \emptyset, & \mathcal{T}_{\text{large}}^{2,1} &\leftarrow \emptyset, \\ \mathbf{S}_{\text{large}}^2 &\leftarrow \emptyset, & \mathbf{S}^{\text{stock}} &\leftarrow \mathbf{S}_1. \end{aligned}$$

In the recursive step, if $\text{size}(\mathbf{S}^{\text{stock}}) < \sigma/2$, then this recursion stops. Otherwise, we select a tree $\mathbf{T} \subset \mathbf{S}^{\text{stock}}$ such that two conditions are met:

- a:** \mathbf{T} satisfies $\|\Delta(\mathbf{T})\|_2 \geq \frac{\sigma}{2} |R_{\mathbf{T}}|^{1/2}$.
- b:** $\omega_{\mathbf{T}}$ is both minimal and most clockwise among all possible choices of \mathbf{T} .

We take \mathbf{T} to be the maximal tree in $\mathbf{S}^{\text{stock}}$ which satisfies these conditions. We take $\mathbf{T}^1 \subset \mathbf{T}$ to be a 1-tree so that

$$(4.84) \quad \int_{R_{\mathbf{T}}} \Delta(\mathbf{T}^1) dx \geq \kappa \sigma.$$

This last inequality must hold by Lemma 4.49.

We then update

$$\begin{aligned} \mathcal{T}_{\text{large}}^2 &\leftarrow \{\mathbf{T}\} \cup \mathcal{T}_{\text{large}}^2, & \mathcal{T}_{\text{large}}^{2,1} &\leftarrow \{\mathbf{T}^1\} \cup \mathcal{T}_{\text{large}}^{2,1}, \\ \mathbf{S}^{\text{stock}} &\leftarrow \mathbf{S}^{\text{stock}} - \mathbf{T}. \end{aligned}$$

The recursion then repeats.

Once the recursion stops, it is clear that the size of $\mathbf{S}^{\text{stock}}$ is at most $\sigma/2$, and so we take $\mathbf{S}_{\text{small}} := \mathbf{S}_{\text{stock}}$.

The estimate

$$\sum_{\mathbf{T} \in \mathcal{T}_{\text{large}}^2} |R_{\mathbf{T}}| \lesssim \sigma^{-2} |F|$$

then is a consequence of the TT^* method, as indicated in the previous step of the proof. That is the first estimate claimed in (4.54).

What is significant is the second estimate of (4.54), which involves the density. The point to observe is this. Consider any tile s of density at least $\delta/2$. Let \mathcal{T}_s be those trees $\mathbf{T} \in \mathcal{T}_{\text{large}}^2$ with top $\omega_{s(\mathbf{T})} \supset \omega_s$ and $R_{s(\mathbf{T})} \subset KR_s$. By the construction of $\mathbf{S}_{\text{large}}^1$, we must have

$$\int_{R_s} \Delta(\mathbf{T}^1) dx \leq \sigma^{1+\kappa/100},$$

for the maximal 1–tree T^1 contained in $\bigcup_{\mathbf{T} \in \mathcal{T}_s} \mathbf{T}$. But, in addition, the tops of the trees in $\mathcal{T}_{\text{large}}^2$ are pairwise incomparable with respect to the order relation ‘ \lesssim ,’ hence we conclude that

$$\frac{\sigma^2}{4} \sum_{\mathbf{T} \in \mathcal{T}_s} |R_{\mathbf{T}}| \lesssim \sigma^{2+\kappa/50} |R_s|.$$

Moreover, by the construction of $\mathbf{S}_{\text{light}}$, for each $\mathbf{T} \in \mathcal{T}_{\text{large}}^2$ we must be able to select some tile s with density at least $\delta/2$ and $\omega_{s(\mathbf{T})} \supset \omega_s$ and $R_{s(\mathbf{T})} \subset KR_s$.

Thus, we let \mathbf{S}^* be the maximal tiles of density at least $\delta/2$. Then, the inequality (4.70) applies to this collection. And, therefore,

$$\sum_{\mathbf{T} \in \mathcal{T}_{\text{large}}^2} |R_{\mathbf{T}}| \leq \sigma^{\kappa/50} \sum_{s \in \mathbf{S}^*} |R_s| \lesssim \sigma^{\kappa/50} \delta^{-1}.$$

This completes the proof of second estimate of (4.54). \square

The Estimates For a Single Tree.

The Proof of Lemma 4.55. It is a routine matter to check that for any 1–tree we have

$$\sum_{s \in \mathbf{T}} |\langle f, \varphi_s \rangle|^2 \lesssim \|f\|_2^2.$$

Indeed, there is a strengthening of this estimate relevant to our concerns here. Recalling the notation (4.40), we have

$$(4.85) \quad \left\| \left[\sum_{s \in \mathbf{T}} \frac{|\langle f, \varphi_s \rangle|^2}{|R_s|} \mathbf{1}_{R_s} \right]^{1/2} \right\|_p \lesssim \|\chi_{R_{\mathbf{T}}}^{(\infty)} f\|_p, \quad 1 < p < \infty.$$

This is variant of the Littlewood-Paley inequalities, with some additional spatial localization in the estimate.

Using this inequality for $p = 1 + \kappa/100$ and the assumption of the Lemma, we have

$$\begin{aligned}
 \sigma^{1+\kappa/100} &\leq \left[\int_{R_{\mathbf{T}}} \Delta_{\mathbf{T}} dx \right]^{1+\kappa/100} \\
 &\leq \int_{R_{\mathbf{T}}} \Delta_{\mathbf{T}}^{1+\kappa/100} dx \\
 &\leq |R_{\mathbf{T}}|^{-1} \left\| \left[\sum_{s \in \mathbf{T}} \frac{|\langle f, \varphi_s \rangle|^2}{|R_s|} \mathbf{1}_{R_s} \right]^{1/2} \right\|_{1+\kappa/100}^{1+\kappa/100} \\
 (4.86) \quad &\lesssim |R_{\mathbf{T}}|^{-1} \int_F \chi_{R_{\mathbf{T}}}^{(\infty)} dx.
 \end{aligned}$$

This inequality can only hold if $|F \cap \sigma^{-\kappa} R_{\mathbf{T}}| \geq \sigma^{1+\kappa} |R_{\mathbf{T}}|$. \square

The Proof of Lemma 4.57. This Lemma is closely related to the Tree Lemma of [15]. Let us recall that result in a form that we need it. We need analogs of the definitions of density and size that do not incorporate truncations of the various functions involved. Define

$$\text{dense}(s) := \int_{G \cap v^{-1}(\omega_s)} \chi_{R_s}^{(1)}(x) dx.$$

(Recall the notation from (4.40).)

$$\text{dense}(\mathbf{T}) := \sup_{s \in \mathbf{T}} \text{dense}(s).$$

Likewise define

$$\text{size}(\mathbf{T}) := \sup_{\substack{\mathbf{T}' \subset \mathbf{T} \\ \mathbf{T}' \text{ is a 1-tree}}} \left[|R_{\mathbf{T}'}|^{-1} \sum_{s \in \mathbf{T}'} |\langle \mathbf{1}_F, \varphi_s \rangle|^2 \right]^{1/2}$$

Then, the proof of the Tree Lemma of [15] will give us this inequality: For \mathbf{T} a tree,

$$(4.87) \quad \sum_{s \in \mathbf{T}} |\langle S_{\text{ann}} \mathbf{1}_F, \varphi_s \rangle \langle \phi_s, \mathbf{1}_G \rangle| \lesssim \text{dense}(\mathbf{T}) \text{size}(\mathbf{T}) |R_{\mathbf{T}}|.$$

Now, consider a tree \mathbf{T} with $\text{dense}(\mathbf{T}) = \delta$, and $\text{size}(\mathbf{T}) = \sigma$, where we insist upon using the original definitions of density and size. If in addition, $\gamma_s \geq K(\sigma\delta)^{-1}$ for all $s \in \mathbf{T}$, we would then have the inequalities

$$\begin{aligned}
 \text{dense}(\mathbf{T}) &\lesssim \delta, \\
 \text{size}(\mathbf{T}) &\lesssim \sigma,
 \end{aligned}$$

This places (4.87) at our disposal, but this is not quite the estimate we need, as the functions φ_s and ϕ_s that occur in (4.87) are not truncated in the appropriate way, and it is this matter that we turn to next. Recall that

$$\varphi_s = \alpha_s + \beta_s, \quad \int \alpha_s(x - yv(x))\psi_s(y) dy = \alpha_{s-}(x) + \alpha_{s+}(y).$$

One should recall the displays (4.30), (4.31), and (4.38).

As an immediate consequence of the definition of β_s , we have

$$\int_{\mathbb{R}^2} |\beta_s(x)| dx \lesssim \gamma_s^{-2} \sqrt{|R_s|}.$$

Hence, if we replace φ_s by β_s , we have

$$\begin{aligned} \sum_{s \in \mathbf{T}} |\langle S_{\text{ann}} \mathbf{1}_F, \beta_s \rangle \langle \phi_s, \mathbf{1}_G \rangle| &\lesssim \sum_{s \in \mathbf{T}} \gamma_s^{-2} \sqrt{|R_s|} |\langle \phi_s, \mathbf{1}_G \rangle| \\ &\lesssim \sigma \delta \sum_{s \in \mathbf{T}} \gamma_s^{-1} |R_s| \\ &\lesssim \sigma \delta |R_{\mathbf{T}}|. \end{aligned}$$

And by a very similar argument, one sees corresponding bounds, in which we replace the ϕ_s by different functions. Namely, recalling the definitions of $a_{s\pm}$ in (4.31) and estimate (4.38), we have

$$\begin{aligned} (4.88) \quad \sum_{s \in \mathbf{T}} \sqrt{|R_s|} |\langle a_{s+}, \mathbf{1}_G \rangle| &\lesssim \sigma \sum_{s \in \mathbf{T}} \sqrt{|R_s|} \int_G \left(\frac{\|v\|_{\text{Lip}}}{\text{scl}(s)} \right)^{10} \chi_{R_s}^{(2)}(x) dx \\ &\lesssim \sigma \delta \sum_{s \in \mathbf{T}} \left(\frac{\|v\|_{\text{Lip}}}{\text{scl}(s)} \right)^{10} |R_s| \\ &\lesssim \sigma \delta |R_{\mathbf{T}}|. \end{aligned}$$

Similarly, we have

$$\sum_{s \in \mathbf{T}} \sqrt{|R_s|} |\langle \phi_s - a_{s+} - a_{s-}, \mathbf{1}_G \rangle| \lesssim \sigma \delta |R_{\mathbf{T}}|,$$

Putting these estimates together proves our Lemma, in particular (4.58), under the assumption that $\gamma_s \geq K(\sigma\delta)^{-1}$ for all $s \in \mathbf{T}$.

Assume that \mathbf{T} is a tree with $\text{scl}(s) = \text{scl}(s')$ for all $s, s' \in \mathbf{T}$. That is, the scale of the tiles in the tree is fixed. Then, \mathbf{T} is in particular a 1-tree, so that by an application of the definitions and Cauchy–Schwartz,

$$\begin{aligned} \sum_{s \in \mathbf{T}} |\langle S_{\text{ann}} \mathbf{1}_F, \alpha_s \rangle \langle a_{s-}, \mathbf{1}_G \rangle| &\leq \delta \sum_{s \in \mathbf{T}} |\langle S_{\text{ann}} \mathbf{1}_F, \alpha_s \rangle| \sqrt{|R_s|} \\ &\leq \delta \sigma |R_{\mathbf{T}}|. \end{aligned}$$

But, $\gamma_s \geq 1$ increases as does $\sqrt{\text{scl}(s)}$. Thus, any tree \mathbf{T} with $\gamma_s \leq K(\sigma\delta)^{-1}$ for all $s \in \mathbf{T}$, is a union of $O(|\log \delta\sigma|)$ trees for which the last estimate holds. \square

Almost Orthogonality Between Annuli

Application of the Fourier Localization Lemma

We are to prove Lemma 4.23, and in doing so rely upon a technical lemma on Fourier localization, Lemma 5.56 below. We can take a choice of $1 < \alpha < \frac{9}{8}$, and assume, after a dilation, that $\|v\|_{C^\alpha} = 1$.

The first inequality we establish is this.

Lemma 5.1. *Using the notation of of Lemma 4.23, and assuming that $\|v\|_{C^\alpha} \lesssim 1$, we have the estimate $\|\mathcal{C}\|_2 \lesssim 1$, where*

$$\mathcal{C} = \sum_{\text{ann} \geq 1} \mathcal{C}_{\text{ann}}$$

where the \mathcal{C}_{ann} are defined in (4.21).

We have already established Lemma 4.22, and so in particular know that $\|\mathcal{C}_{\text{ann}}\|_2 \lesssim 1$. Due to the imposition of the Fourier restriction in the definition of these operators, it is immediate that $\mathcal{C}_{\text{ann}}\mathcal{C}_{\text{ann}'}^* \equiv 0$ for $\text{ann} \neq \text{ann}'$. We establish that

$$(5.2) \quad \begin{aligned} \|\mathcal{C}_{\text{ann}}^*\mathcal{C}_{\text{ann}'}\|_2 &\lesssim \max(\text{ann}, \text{ann}')^{-\delta}, \\ \delta &= \frac{1}{128}(\alpha - 1), \quad |\log \text{ann}(\text{ann}')^{-1}| > 3. \end{aligned}$$

Then, it is entirely elementary to see that \mathcal{C} is a bounded operator. Let P_{ann} be the Fourier projection of f onto the frequencies $\text{ann} < |\xi| < 2\text{ann}$. Observe,

$$\begin{aligned} \|\mathcal{C}f\|_2^2 &= \left\| \sum_{\text{ann} \geq 1} \mathcal{C}_{\text{ann}} P_{\text{ann}} f \right\|_2^2 \\ &\leq \sum_{\text{ann} \geq 1} \sum_{\text{ann}' > 1} \langle \mathcal{C}_{\text{ann}} P_{\text{ann}} f, \mathcal{C}_{\text{ann}'} P_{\text{ann}'} f \rangle \\ &\leq 2\|f\|_2 \sum_{\text{ann} \geq 1} \sum_{\text{ann}' > 1} \|\mathcal{C}_{\text{ann}}^* \mathcal{C}_{\text{ann}'} P_{\text{ann}'} f\|_2 \\ &\lesssim \|f\|_2^2 \left(1 + \sum_{\text{ann} \geq 1} \sum_{\text{ann}' > 1} \max(\text{ann}, \text{ann}')^{-\delta} \right) \\ &\lesssim \|f\|_2^2. \end{aligned}$$

There are only $O(\log \text{ann})$ possible values of scl that contribute to \mathcal{C}_{ann} , and likewise for $\mathcal{C}_{\text{ann}'}$. Thus, if we define

$$(5.3) \quad \mathcal{C}_{\text{ann}, \text{scl}} f = \sum_{\substack{s \in \mathcal{AT}(\text{ann}) \\ \text{scl}(s) = \text{scl}}} \langle f, \varphi_s \rangle \phi_s,$$

it suffices to prove

Lemma 5.4. *Using the notation of of Lemma 4.23, and assuming that $\|v\|_{C^\alpha} \lesssim 1$, we have*

$$\|\mathcal{C}_{\text{ann}, \text{scl}}^* \mathcal{C}_{\text{ann}', \text{scl}'}\|_2 \lesssim (\max(\text{ann}, \text{ann}'))^{-\delta}.$$

Here, we can take $\delta' = \frac{1}{100}(\alpha - 1)$, and the inequality holds for all $|\log \text{ann}(\text{ann}')^{-1}| > 3$, $1 < \text{scl} \leq \text{ann}$ and $1 < \text{scl}' \leq \text{ann}'$.

PROOF OF LEMMA 4.23. In this proof, we assume that Lemma 5.1 and Lemma 5.4 are established. The first Lemma clearly establishes the first (and more important) claim of the Lemma.

Let us prove the inequality (4.24). Using the notation of this section, this inequality is as follows.

$$(5.5) \quad \left\| \sum_{\text{ann}=-\infty}^{\infty} \mathcal{C}_{\text{ann}, \text{scl}} \right\|_2 \lesssim (1 + \log(1 + \text{scl}^{-1} \|v\|_{C^\alpha})).$$

This inequality holds for all choices of C^α vector fields v .

Note that Lemma 5.4 implies immediately

$$\left\| \sum_{\text{ann}=3}^{\infty} \mathcal{C}_{\text{ann}, \text{scl}} \right\|_2 \lesssim 1, \quad \|v\|_{C^\alpha} = 1.$$

We are however in a scale invariant situation, so that this inequality implies this equivalent form, independent of assumption on the norm of the vector field.

$$(5.6) \quad \left\| \sum_{\text{ann} \geq 8\|v\|_{C^\alpha}}^{\infty} \mathcal{C}_{\text{ann}, \text{scl}} \right\|_2 \lesssim 1.$$

On the other hand, Lemma 4.25, implies that independent of any assumption other than measurability, we have have the inequality

$$\|\mathcal{C}_{\text{ann}, \text{scl}}\|_2 \lesssim 1.$$

To prove (5.5), use the inequality (5.6), and this last inequality together with the simple fact that for a fixed value of scl , there are at most $\lesssim 1 + \log(1 + \text{scl}^{-1} \|v\|_{C^\alpha})$ values of ann with $\text{scl} \leq \text{ann} \leq 8\|v\|_{C^\alpha}$. \square

We use the notation

$$\mathcal{AT}(\text{ann}, \text{scl}) := \{s \in \mathcal{AT}(\text{ann}) : \text{scl}(s) = \text{scl}\},$$

Observe that as the scale is fixed, we have a Bessel inequality for the functions $\{\varphi_s \mid s \in \mathcal{AT}(\text{ann}, \text{scl})\}$. Thus,

$$\begin{aligned} \|\mathcal{C}_{\text{ann}, \text{scl}}^* \mathcal{C}_{\text{ann}', \text{scl}'} f\|_2^2 &= \left\| \sum_{s \in \mathcal{AT}(\text{ann}, \text{scl})} \sum_{s' \in \mathcal{AT}(\text{ann}', \text{scl}')} \langle \phi_s, \phi_{s'} \rangle \langle \varphi_{s'}, f \rangle \varphi_s \right\|_2^2 \\ &\lesssim \sum_{s \in \mathcal{AT}(\text{ann}, \text{scl})} \left| \sum_{s' \in \mathcal{AT}(\text{ann}', \text{scl}')} \langle \phi_s, \phi_{s'} \rangle \langle \varphi_{s'}, f \rangle \right|^2. \end{aligned}$$

At this point, the Schur test suggests itself, and indeed, we need a quantitative version of the test, which we state here.

Proposition 5.7. *Let $A = \{a_{i,j}\}$ be a matrix acting on $\ell^2(\mathbb{N})$ by*

$$A x = \left\{ \sum_j a_{i,j} x_j \right\}.$$

Then, we have the following bound on the operator norm of A .

$$\|A\|^2 \lesssim \sup_j \sum_i |a_{i,j}| \cdot \sup_i \sum_j |a_{i,j}|$$

We assume that $1 \leq \text{ann} < \frac{1}{8} \text{ann}'$. For a subset $\mathcal{S} \subset \mathcal{AT}(\text{ann}, \text{scl}) \times \mathcal{AT}(\text{ann}', \text{scl}')$ Consider the operator and definitions below.

$$\begin{aligned} A_{\mathcal{S}} f &= \sum_{(s,s') \in \mathcal{S}} \langle \phi_s, \phi_{s'} \rangle \langle \varphi_{s'}, f \rangle \varphi_s, \\ \text{FL}(s, \mathcal{S}) &= \sum_{s' \in \mathcal{AT}(\text{ann}', \text{scl}')} |\langle \phi_s, \phi_{s'} \rangle|, \\ \text{FL}(\mathcal{S}) &= \sup_s \text{FL}(s, \mathcal{S}). \end{aligned}$$

Here ‘FL’ is for ‘Fourier Localization’ as this term is to be controlled by Lemma 5.56. We will use the notations $\text{FL}(s', \mathcal{S})$, and $\text{FL}'(\mathcal{S})$, which are defined similarly, with the roles of s and s' reversed. By Proposition 5.7, we have the inequality

$$(5.8) \quad \|A_{\mathcal{S}}\|_2^2 \lesssim \text{FL}(\mathcal{S}) \cdot \text{FL}'(\mathcal{S}).$$

We shall see that typically $\text{FL}(\mathcal{S})$ will be somewhat large, but is balanced out by $\text{FL}'(\mathcal{S})$.

We partition $\mathcal{AT}(\text{ann}, \text{scl}) \times \mathcal{AT}(\text{ann}', \text{scl}')$ into three disjoint subcollections \mathcal{S}_u , $u = 1, 2, 3$, defined as follows. In this display, $(s, s') \in$

$\mathcal{AT}(\text{ann}, \text{scl}) \times \mathcal{AT}(\text{ann}', \text{scl}')$.

$$(5.9) \quad \mathcal{S}_1 = \left\{ (s, s') \mid \frac{\text{scl}'}{\text{ann}'} \geq \frac{\text{scl}}{\text{ann}} \right\},$$

$$(5.10) \quad \mathcal{S}_2 = \left\{ (s, s') \mid \frac{\text{scl}'}{\text{ann}'} < \frac{\text{scl}}{\text{ann}}, \text{scl} < \text{scl}' \right\},$$

$$(5.11) \quad \mathcal{S}_3 = \left\{ (s, s') \mid \frac{\text{scl}'}{\text{ann}'} < \frac{\text{scl}}{\text{ann}}, \text{scl}' < \text{scl} \right\}.$$

A further modification to these collections must be made, but it is not of an essential nature. For an integer $j \geq 1$, and $(s, s') \in \mathcal{S}_u$, for $u = 1, 2, 3$, write $(s, s') \in \mathcal{S}_{u,j}$ if j is the smallest integer such that $2^{j+2}R_s \cap 2^{j+2}R_{s'} \neq \emptyset$.

We apply the inequalities (5.8) to the collections $\mathcal{S}_{u,j}$, to prove the inequalities

$$(5.12) \quad \|\mathbf{A}_{\mathcal{S}_{u,j}}\|_2 \lesssim 2^{-j}(\text{ann}')^{-\delta'}$$

where $\delta' = \frac{1}{100}(\alpha - 1)$. This proves Lemma 5.4, and so completes the proof of Lemma 5.1.

In applying (5.8) it will be very easy to estimate $\text{FL}(s, \mathcal{S})$, with a term that decreases like say 2^{-10j} . The difficult part is to estimate either $\text{FL}(s, \mathcal{S})$ or $\text{FL}'(\mathcal{S})$ by a term with decreases faster than a small power of $(\text{ann}')^{-1}$. for which we use Lemma 5.56.

Considering a term $\langle \phi_s, \phi_{s'} \rangle$, the inner product is trivially zero if $\omega_s \cap \omega_{s'} = \emptyset$. We assume that this is not the case below. To apply Lemma 5.56, fix $e \in \omega'_s \cap \omega_s$. Let α be a Schwartz function on \mathbb{R} with $\widehat{\alpha}$ supported on $[\text{ann}', 2\text{ann}']$, and identically one on $\frac{3}{4}[\text{ann}', 2\text{ann}']$. Set $\widehat{\beta}(\theta) := \widehat{\alpha}(\theta - \frac{3}{2}\text{ann}')$. We will convolve ϕ_s with β in the direction e , and $\phi_{s'}$ with α also in the direction e , thereby obtaining orthogonal functions.

Define

$$(5.13) \quad \mathbf{I}_e g(x) = \int_{\mathbb{R}} g(x - ye)\beta(y) dy,$$

$$(5.14) \quad \begin{aligned} \Delta_s &= \phi_s - \mathbf{I}_e \phi_s \\ \Delta_{s'} &= \phi_{s'} - \mathbf{I}_e \phi_{s'} \end{aligned}$$

By construction, we have

$$\begin{aligned} \langle \phi_s, \phi_{s'} \rangle &= \langle \mathbf{I}_e \phi_s + \Delta_s, \mathbf{I}_e \phi_{s'} + \Delta_{s'} \rangle \\ &= \langle \mathbf{I}_e \phi_s, \Delta_{s'} \rangle + \langle \Delta_s, \mathbf{I}_e \phi_{s'} \rangle + \langle \Delta_s, \Delta_{s'} \rangle. \end{aligned}$$

It falls to us to estimate terms like

$$(5.15) \quad \sup_{s'} \sum_{s \in \mathbf{S}_{\ell,j}} |\langle \Delta_s, \mathbb{I}_e \phi_{s'} \rangle|,$$

$$(5.16) \quad \sup_{s'} \sum_{s \in \mathbf{S}_{\ell,j}} |\langle \mathbb{I}_e \phi_s, \Delta_{s'} \rangle|,$$

$$(5.17) \quad \sup_{s'} \sum_{s \in \mathbf{S}_{\ell,j}} |\langle \Delta_s, \Delta_{s'} \rangle|.$$

as well as the dual expressions, with the roles of s and s' reversed.

The differences Δ_s and $\Delta_{s'}$ are frequently controlled by Lemma 5.56. Concerning application of this Lemma to Δ_s , observe that

$$\text{Mod}_{-c(\omega_s)} \Delta_s = \text{Mod}_{-c(\omega_s)} \phi_s - \int [\text{Mod}_{-c(\omega_s)} \phi_s(x - ye)] \tilde{\beta}(y) dy$$

where $\tilde{\beta}(y) = e^{(c(\omega_s) \cdot e)y} \beta(y)$. Now the Fourier transform of β is identically one in a neighborhood of the origin of width comparable to ann' , where as $|c(\omega_s) \cdot e|$ is comparable to ann . Since we can assume that $\text{ann}' > \text{ann} + 3$, say, the function $\tilde{\beta}$ meets the hypotheses of Lemma 5.56, namely it is Schwarz function with Fourier transform identically one in a neighborhood of the origin, and the width of that neighborhood is comparable to ann' . And so Δ_s is bounded by the bounded by the three terms in (5.57)—(5.59) below. In these estimates, we take $2^k \simeq \text{ann}' > 1$. By a similar argument, one sees that Lemma 5.56 also applies to $\Delta_{s'}$.

We will let $\Delta_{s,m}$, for $m = 1, 2, 3$, denote the terms that come from (5.57), (5.58), and (5.59) respectively. We use the corresponding notation for $\Delta_{s',m}$, for $m = 1, 2, 3$. A nice feature of these estimates, is that while Δ_s and $\Delta_{s'}$ depend upon the choice of $e \in \omega_{s'} \cap \omega_s$, the upper bounds in the first two estimates do not depend upon the choice of e . While the third estimate does, the dependence of the set F_s on the choice of e is rather weak.

In application of (5.58), the functions $\Delta_{s,2}$ will be very small, due to the term $(\text{ann}')^{-10}$ which is on the right in (5.58). This term is so much smaller than all other terms involved in this argument that these terms are very easy to control. So we do not explicitly discuss the case of $\Delta_{s,2}$, or $\Delta_{s',2}$ below.

In the analysis of the terms (5.15) and (5.16), we frequently only need to use an inequality such as $|\mathbb{I}_e \phi_{s'}| \lesssim \chi_{R_{s'}}^{(2)}$. When it comes to the analysis of (5.17), the function $\Delta_{s'}$ obeys the same inequality, so that

these sums can be controlled by the same analysis that controls (5.15), or (5.16). So we will explicitly discuss these cases below.

In order for $\langle \phi_s, \phi_{s'} \rangle \neq \emptyset$, we must necessarily have $\omega_s \cap \omega_{s'} \neq \emptyset$. Thus, we update all $\mathcal{S}_{\ell,j}$ as follows.

$$\mathcal{S}_{\ell,j} \leftarrow \{(s, s') \in \mathcal{S}_{\ell,j} \mid \omega_s \cap \omega_{s'} \neq \emptyset\}.$$

The Proof of (5.12) for $\mathcal{S}_{1,j}$, $j \geq 1$. Recall the definition of $\mathcal{S}_{1,j}$ from (5.9). In particular, for $(s, s') \in \mathcal{S}_{1,j}$, we must have $\omega_s \subset \omega_{s'}$.

We will use the inequality (5.8), and show that for $0 < \epsilon < 1$,

$$(5.18) \quad \text{FL}(\mathcal{S}_{1,j}) \lesssim 2^{-10j} (\text{ann}')^{-\tilde{\alpha}} \sqrt{\frac{\text{scl}' \cdot \text{ann}'}{\text{scl} \cdot \text{ann}}}$$

$$(5.19) \quad \text{FL}'(\mathcal{S}_{1,j}) \lesssim 2^{2j} (\text{ann}')^\epsilon \cdot \sqrt{\frac{\text{scl} \cdot \text{ann}}{\text{scl}' \cdot \text{ann}'}}.$$

Notice that in the second estimate, we permit some slow increase in the estimates as a function of 2^j and ann' . But, due to the form of the estimate of the Schur test in (5.8), this slow growth is acceptable.

The terms inside the square root in these two estimates cancel out. These inequalities conclude the proof of the inequality (5.12) for the collection $\mathcal{S}_{1,j}$, $j \geq 1$.

We prove (5.18). For this, we use Lemma 5.56. That is, we should bound the several terms

$$(5.20) \quad \sum_{s' : (s, s') \in \mathcal{S}_{1,j}} |\langle \Delta_s, \mathbf{I}_e \phi_{s'} \rangle|,$$

$$(5.21) \quad \sum_{s' : (s, s') \in \mathcal{S}_{1,j}} |\langle \mathbf{I}_e \phi_s, \Delta_{s'} \rangle|,$$

$$(5.22) \quad \sum_{s' : (s, s') \in \mathcal{S}_{1,j}} |\langle \Delta_s, \Delta_{s'} \rangle|.$$

Here Δ_s and $\Delta_{s'}$ are as in (5.14). And, \mathbf{I}_e is defined as in (5.13). We can regard the tile s as fixed, and so fix a choice of $e \in \omega_s$. In the next two cases, we will need to estimate the same expressions as above. In all three cases, Lemma 5.56 is applied with $2^k \simeq \text{ann}'$, and we can take ϵ in this Lemma to be $\epsilon = \frac{1}{400}(\alpha - 1)$. For ease of notation, we set

$$(5.23) \quad \tilde{\alpha} = (\alpha - 1)(1 - \epsilon)^2 - \epsilon > 0$$

As we have already mentioned, we do not explicitly discuss the upper bound on the estimate for (5.22).

The Upper Bound on (5.20). We write $\Delta_s = \Delta_{s,1} + \Delta_{s,2} + \Delta_{s,3}$, where these three terms are those on the right in (5.57)–(5.59) respectively. Note that

$$(5.24) \quad |\mathbb{I}_e \phi_{s'}| \lesssim \chi_{R_{s'}}^{(2)},$$

since \mathbb{I}_e is convolution in the long direction of $R_{s'}$, at the scale of $(\text{ann}')^{-1}$, which is much smaller than the length of $R_{s'}$ in the direction e . Therefore, we can estimate the term in (5.20) by

$$(5.25) \quad \begin{aligned} \sum_{s' : (s, s') \in \mathbf{S}_{1,j}} |\langle \Delta_{s,1}, \mathbb{I}_e \phi_{s'} \rangle| &\lesssim (\text{ann}')^{-\tilde{\alpha}} 2^{-10j} \\ &\int \chi_{R_s}^{(2)} \left\{ \sum_{s' : (s, s') \in \mathbf{S}_{1,j}} \chi_{R_{s'}}^{(2)} \right\} dx \\ &\lesssim (\text{ann}')^{-\tilde{\alpha}} 2^{-10j} \sqrt{\frac{\text{scl}' \cdot \text{ann}'}{\text{scl} \cdot \text{ann}}}. \end{aligned}$$

This is as required to prove (5.18) for these sums.

For the terms associated with $\Delta_{s,3}$, we have

$$\begin{aligned} \sum_{s' : (s, s') \in \mathbf{S}_{1,j}} |\langle \Delta_{s,3}, \mathbb{I}_e \phi_{s'} \rangle| &\lesssim \sum_{s' : (s, s') \in \mathbf{S}_{1,j}} \int_{F_s} |R_s|^{-1/2} \cdot \chi_{R_{s'}}^{(2)} dx \\ &\lesssim 2^{-10j} |F_s| \sqrt{\text{ann}' \cdot \text{scl}' \cdot \text{ann} \cdot \text{scl}} \\ &\lesssim 2^{-10j} (\text{ann}')^{-\alpha+\epsilon} \sqrt{\frac{\text{scl}' \cdot \text{ann}'}{\text{scl} \cdot \text{ann}}}. \end{aligned}$$

That is, we only rely upon the estimate (5.60). This completes the analysis of (5.20). (As we have commented above, we do not explicitly discuss the case of $\Delta_{s,2}$.)

The Upper Bound for (5.21). Since $\omega_s \subset \omega_{s'}$, the only facts about $\Delta_{s'}$ we need are

$$(5.26) \quad \begin{aligned} \int_{(\text{ann}')^\epsilon R_s'} |\Delta_{s'}| dx &\lesssim (\text{ann}')^{-\tilde{\alpha}+\epsilon} \sqrt{\frac{1}{\text{scl}' \cdot \text{ann}'}} , \\ |\Delta_{s'}(x)| &\lesssim (\text{ann}')^{-\tilde{\alpha}} \chi_{R_{s'}}^{(2)}(x), \quad x \notin (\text{ann}')^\epsilon R_{s'}. \end{aligned}$$

Indeed, this estimate is a straightforward consequence of the various conclusions of Lemma 5.56. (We will return to this estimate in other cases below.)

These inequalities, with $|\mathbb{I}_e \phi_s| \lesssim \chi_{R_s}^{(2)}$, permit us to estimate

$$\begin{aligned}
(5.21) &\lesssim 2^{-20j} |R_s|^{-1/2} \sum_{s' : (s, s') \in \mathbf{S}_{1,j}} \int_{(\text{ann}')^\epsilon R'_s} |\Delta_{s'}| dx \\
&\lesssim 2^{-20j} (\text{ann}')^{-\tilde{\alpha}} \sqrt{\frac{\text{scl} \cdot \text{ann}}{\text{scl}' \cdot \text{ann}'}} \times \#\{s' : (s, s') \in \mathbf{S}_{1,j}\} \\
&\lesssim 2^{-20j} (\text{ann}')^{-\tilde{\alpha}} \sqrt{\frac{\text{scl}' \cdot \text{ann}'}{\text{scl} \cdot \text{ann}}}.
\end{aligned}$$

which is the required estimate. Here of course we use the estimate

$$\#\{s' : (s, s') \in \mathbf{S}_{1,j}\} \lesssim 2^{2j} \frac{\text{scl}' \cdot \text{ann}'}{\text{scl} \cdot \text{ann}}.$$

We now turn to the proof of (5.19), where it is important that we justify the small term

$$\sqrt{\frac{\text{scl} \cdot \text{ann}}{\text{scl}' \cdot \text{ann}'}}$$

on the right in (5.19). We estimate the terms dual to (5.20)—(5.22), namely

$$(5.27) \quad \sum_{s : (s, s') \in \mathbf{S}_{1,j}} |\langle \Delta_s, \mathbb{I}_{e_s} \phi_{s'} \rangle|,$$

$$(5.28) \quad \sum_{s : (s, s') \in \mathbf{S}_{1,j}} |\langle \mathbb{I}_{e_s} \phi_s, \Delta_{s'} \rangle|,$$

$$(5.29) \quad \sum_{s : (s, s') \in \mathbf{S}_{1,j}} |\langle \Delta_s, \Delta_{s'} \rangle|.$$

Here, for each choice of tile s , we make a choice of $e_s \in \omega_s \subset \omega_{s'}$.

The Upper Bound on (5.27). We have an inequality analogous to (5.24).

$$(5.30) \quad |\mathbb{I}_{e_s} \phi_{s'}| \lesssim \chi_{R_{s'}}^{(2)}.$$

Note that as we can view s' as fixed, all the tiles $\{s : (s, s') \in \mathbf{S}_{1,j}\}$ have the same approximate spatial location. Let us single out a tile s_0 in this collection. Then, for all s , we have $R_s \subset 2^{j+2} R_{s_0}$.

Recalling the specific information about the support of the functions of Δ_s from (5.57), (5.59) and (5.61), it follows that

$$\sum_{s : (s, s') \in \mathbf{S}_{1,j}} |\Delta_s| \lesssim 2^{2j} (\text{ann}')^\epsilon \chi_{2^{j+2} R_{s_0}}^{(2)}.$$

In particular, we do not claim any decay in ann' in this estimate. (The small growth of $(\text{ann}')^\epsilon$ above arises from the overlapping supports of the functions Δ_s , as detailed in Lemma 5.56.) Therefore, we can estimate

$$\begin{aligned} \sum_{s:(s,s') \in \mathbf{S}_{1,j}} |\langle \Delta_s, \mathbf{I}_{e_s} \phi_{s'} \rangle| &\lesssim 2^{2j} (\text{ann}')^\epsilon \int \chi_{2^j R_{s_0}}^{(2)} \chi_{R_{s'}}^{(2)} dx \\ &\lesssim 2^{-10j} (\text{ann}')^\epsilon \sqrt{\frac{\text{scl} \cdot \text{ann}}{\text{scl}' \cdot \text{ann}'}}. \end{aligned}$$

This is as required in (5.19).

Remark 5.31. It is the analysis of the term

$$\sum_{s:(s,s') \in \mathbf{S}_{1,j}} |\langle \Delta_{s,3}, \mathbf{I}_{e_s} \phi_{s'} \rangle|$$

which prevents us from obtaining a decay in ann' , at least in some choices of the parameters scl , ann , scl' , and ann' .

The Upper Bound on (5.28). The fact about $\Delta_{s'}$ we need is the simple inequality $|\Delta_{s'}| \lesssim \chi_{R_{s'}}^{(2)}$.

As in the previous case, we turn to the fact that all the tile $\{s : (s, s') \in \mathbf{S}_{1,j}\}$ have the same approximate spatial location. Single out a tile s_0 in this collection, so that $R_s \subset 2^{j+2} R_{s_0}$ for all such s .

Our claim is that

$$(5.32) \quad \sum_{s:(s,s') \in \mathbf{S}_{1,j}} |\mathbf{I}_{e_s} \phi_s| \lesssim 2^{2j} \chi_{2^{2j} R_s}^{(2)}.$$

(We will have need of related inequalities below.) Suppose that $s \in \{s : (s, s') \in \mathbf{S}_{1,j}\}$. These intervals all have the same length, namely scl/ann . And $x \notin \text{supp}(\phi_s)$ implies $v(x) \notin \omega_s$, so that by the Lipschitz assumption on the vector field

$$\text{dist}(x, \text{supp}(\phi_s)) \gtrsim \text{dist}(v(x), \omega_s).$$

This means that

$$(5.33) \quad |\mathbf{I}_{e_s} \phi_s(x)| \lesssim \chi_{R_s}^{(2)} \left(1 + \text{ann}' \cdot \text{dist}(v(x), \omega_s)\right)^{-10}.$$

Here, we recall that the operator \mathbf{I}_e is dominated by the operator which averages on spatial scale $(\text{ann}')^{-1}$ in the direction e . Moreover, we have

$$(5.34) \quad \text{ann}' \cdot \text{dist}(\omega_s, \bar{\omega}) \gtrsim \text{scl}.$$

Here, we partition the unit circle into disjoint intervals $\bar{\omega} \in \bar{\Omega}$ of length $|\bar{\omega}| \simeq \text{scl}/\text{ann}$, so that for all $s \in \{s : (s, s') \in \mathbf{S}_{1,j}\}$, we have $\omega_s \in \bar{\Omega}$.

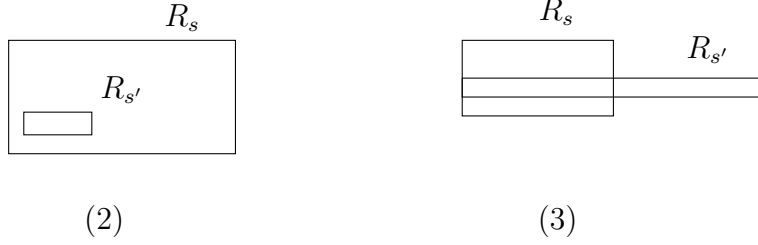

FIGURE 5.1. The relative positions of R_s and $R_{s'}$ in for pairs $(s, s') \in \mathcal{S}_\ell$, for $\ell = 2$ and $\ell = 3$ respectively.

In fact, the term on the left in (5.34) can be taken to be integer multiples of scl . Combining these observations proves (5.32). Indeed, we can estimate the term in (5.32) as follows. For x , fix $\bar{\omega} \in \bar{\Omega}$ with $v(x) \in \bar{\omega}$. Then,

$$\sum_{s:(s,s') \in \mathbf{S}_{1,j}} |\mathbf{I}_{e_s} \phi_s| \lesssim \sum_{s:(s,s') \in \mathbf{S}_{1,j}} \chi_{R_{\bar{\omega}}}^{(2)}(x) \left(1 + \text{ann}' \cdot \text{dist}(\bar{\omega}, \omega_s)\right)^{-10}.$$

The important point is that the term involving the distance allows us to sum over the possible values of $\omega_s \subset \omega_{s'}$ to conclude (5.32).

To finish this case, we can estimate

$$\sum_{s:(s,s') \in \mathbf{S}_{1,j}} |\langle \mathbf{I}_{e_s} \phi_s, \Delta_{s'} \rangle| \lesssim 2^{-10j} \sqrt{\frac{\text{scl} \cdot \text{ann}}{\text{scl}' \cdot \text{ann}'}}.$$

This completes the upper bound on (5.28).

The Proof (5.12) for $\mathcal{S}_{2,j}$, $j \geq 1$. In this case, note that the assumptions imply that we can assume that $\omega_{s'} \subset \omega_s$, and that dimensions of the rectangle $R_{s'}$ are smaller than those for R_s in both directions. See Figure 5.

We should show these two inequalities, in analogy to (5.18) and (5.19).

$$(5.35) \quad \text{FL}(\mathcal{S}_{2,j}) \lesssim 2^{-10j} (\text{ann}')^{-\tilde{\alpha}} \sqrt{\frac{\text{scl}' \cdot \text{ann}'}{\text{scl} \cdot \text{ann}}}$$

$$(5.36) \quad \text{FL}'(\mathcal{S}_{2,j}) \lesssim 2^{-10j} (\text{ann}')^{-\tilde{\alpha}} \cdot \sqrt{\frac{\text{scl} \cdot \text{ann}}{\text{scl}' \cdot \text{ann}'}}.$$

Here, $\tilde{\alpha}$ is as in (5.23).

For the proof of (5.35), we should analyze the sums

$$(5.37) \quad \sum_{s' : (s, s') \in \mathcal{S}_{2,j}} |\langle \Delta_s, \mathbf{I}_{e_{s'}} \phi_{s'} \rangle|,$$

$$(5.38) \quad \sum_{s' : (s, s') \in \mathcal{S}_{2,j}} |\langle \mathbf{I}_{e_{s'}} \phi_s, \Delta_{s'} \rangle|,$$

$$(5.39) \quad \sum_{s' : (s, s') \in \mathcal{S}_{2,j}} |\langle \Delta_s, \Delta_{s'} \rangle|.$$

These inequalities are in analogy to (5.20)—(5.22), and $e_{s'} \in \omega_{s'} \subset \omega_s$.

The Upper Bound on (5.37). Fix the tile s . Fix a translate \overline{R}_s of R_s with $2^j R_s \cap 2^j \overline{R}_s = \emptyset$, but $2^{j+1} R_s \cap 2^{j+2} \overline{R}_s \neq \emptyset$. Let us consider

$$(5.40) \quad \overline{\mathcal{S}}_{2,j} = \{(s, s') \in \mathcal{S}_{2,j} \mid R_{s'} \subset \overline{R}_s\}$$

and we restrict the the sum in (5.37) to this collection of tiles. Note that with $\lesssim 2^{2j}$ choices of \overline{R}_s , we can exhaust the collection $\mathcal{S}_{2,j}$. So we will prove a slightly stronger estimate in the parameter 2^j for the restricted collection $\overline{\mathcal{S}}_{2,j}$.

The point of this restriction is that we can appeal to an inequality similar to (5.32). Namely,

$$(5.41) \quad \sum_{s' : (s, s') \in \overline{\mathcal{S}}_{2,j}} |\mathbf{I}_{e_{s'}} \phi_{s'}| \lesssim \sqrt{\frac{\text{scl}' \cdot \text{ann}'}{\text{scl} \cdot \text{ann}}} \chi_{\overline{R}_s}^{(2)}.$$

Note that the term in the square root takes care of the differing L^2 normalizations of $\phi_{s'}$ and $\chi_{\overline{R}_s}^{(2)}$. Indeed, the proof of (5.32) is easily modified to give this inequality.

Next, we observe that the analog of (5.26) holds for Δ_s . Just replace s' in (5.26) with s . It is a consequence that we have

$$\sum_{s' : (s, s') \in \overline{\mathcal{S}}_{2,j}} |\langle \Delta_s, \mathbf{I}_{e_{s'}} \phi_{s'} \rangle| \lesssim 2^{-12j} (\text{ann}')^{-\tilde{\alpha}} \sqrt{\frac{\text{scl}' \cdot \text{ann}'}{\text{scl} \cdot \text{ann}}}.$$

This is enough to finish this case.

The Upper Bound on (5.38). Let us again appeal to the notations \overline{R}_s and $\overline{\mathcal{S}}_{2,j}$ as in (5.40).

We have the estimates

$$|\mathbf{I}_{e_{s'}} \phi_s| \lesssim \chi_{\overline{R}_s}^{(2)}.$$

As for the sum over $\Delta_{s'}$, we have an analog of the estimates (5.26). Namely,

$$\sum_{s' : (s, s') \in \overline{\mathbf{S}}_{2,j}} \int_{(\text{ann}')^\epsilon \overline{R}_s} |\Delta_{s',1}| dx \lesssim (\text{ann}')^{-\tilde{\alpha} + \epsilon} \sqrt{\frac{\text{scl}' \cdot \text{ann}'}{\text{scl} \cdot \text{ann}}}$$

$$\sum_{s' : (s, s') \in \overline{\mathbf{S}}_{2,j}} |\Delta_{s',1}| \lesssim \sqrt{\frac{\text{scl}' \cdot \text{ann}'}{\text{scl} \cdot \text{ann}}} \chi_{\overline{R}_s}^{(2)}, \quad x \notin (\text{ann}')^\epsilon \overline{R}_s.$$

Note that we again have to be careful to accommodate the different normalizations here. The proof of (5.26) can be modified to prove this estimate.

Putting these two estimates together clearly proves that

$$\sum_{s' : (s, s') \in \mathbf{S}_{2,j}} |\langle \mathbf{I}_{e_{s'}} \phi_s, \Delta_{s'} \rangle| \lesssim 2^{-10j} (\text{ann}')^{-\tilde{\alpha}} \sqrt{\frac{\text{scl}' \cdot \text{ann}'}{\text{scl} \cdot \text{ann}}},$$

as is required.

We now turn to the proof of the inequality (5.36), which will follow from appropriate upper bounds on the sums below.

$$(5.42) \quad \sum_{s : (s, s') \in \mathbf{S}_{2,j}} |\langle \Delta_s, \mathbf{I}_e \phi_{s'} \rangle|,$$

$$(5.43) \quad \sum_{s : (s, s') \in \mathbf{S}_{2,j}} |\langle \mathbf{I}_e \phi_s, \Delta_{s'} \rangle|,$$

$$(5.44) \quad \sum_{s : (s, s') \in \mathbf{S}_{2,j}} |\langle \Delta_s, \Delta_{s'} \rangle|.$$

Here, we can regard s' as a fixed tile, and $e \in \omega_{s'} \subset \omega_s$. In this case, observe that we have the inequality

$$(5.45) \quad \#\{s : (s, s') \in \mathbf{S}_{1,j}\} \lesssim 2^{2j}.$$

This is so since R_s has larger dimensions in both directions than does $R_{s'}$.

The Upper Bound on (5.42). We use the decomposition of $\Delta_s = \Delta_{s,1} + \Delta_{s,2} + \Delta_{s,3}$. In the first case, we can estimate

$$\sum_{s : (s, s') \in \mathbf{S}_{2,j}} |\langle \Delta_{s,1}, \mathbf{I}_e \phi_{s'} \rangle| \lesssim 2^{2j} \sup |\langle \Delta_{s,1}, \mathbf{I}_e \phi_{s'} \rangle|$$

$$\lesssim 2^{-10j} (\text{ann}')^{-\tilde{\alpha}} \sqrt{\frac{\text{scl} \cdot \text{ann}}{\text{scl}' \cdot \text{ann}'}}.$$

For the last case, of $\Delta_{s,3}$, we estimate

$$\begin{aligned} \sum_{s:(s,s') \in \mathbf{S}_{2,j}} |\langle \Delta_{s,3}, \mathbb{I}_e \phi_{s'} \rangle| &\lesssim 2^{2j} \sup |\langle \Delta_{s,3}, \mathbb{I}_e \phi_{s'} \rangle| \\ &\lesssim 2^{2j} \min \left\{ |F_s| \cdot \sqrt{\text{scl} \cdot \text{ann} \cdot \text{scl}' \cdot \text{ann}'}, \right. \\ &\quad \left. 2^{-30j} \sqrt{\frac{\text{scl} \cdot \text{ann}}{\text{scl}' \cdot \text{ann}'}} \right\}. \end{aligned}$$

Examining the two terms of the minimum, note that by (5.61),

$$\begin{aligned} |F_s| \cdot \sqrt{\text{scl} \cdot \text{ann} \cdot \text{scl}' \cdot \text{ann}'} &\lesssim (\text{ann}')^{-\alpha+\epsilon} \sqrt{\frac{\text{scl}' \cdot \text{ann}'}{\text{scl} \cdot \text{ann}}} \\ &\lesssim (\text{ann}')^{-\alpha+1+\epsilon} \sqrt{\frac{1}{\text{scl}' \cdot \text{ann}' \cdot \text{scl} \cdot \text{ann}}} \\ &\lesssim (\text{ann}')^{-\alpha+1+\epsilon} \sqrt{\frac{\text{scl} \cdot \text{ann}}{\text{scl}' \cdot \text{ann}'}}. \end{aligned}$$

Here it is essential that we have the estimate (5.60) as stated, with $|F_s| \lesssim (\text{ann}')^{-\alpha+\epsilon} |R_s|$. This is an estimate of the desired form, but without any decay in the parameter j . The second term in the minimum does have the decay in j , but does not have the decay in ann' . Taking the geometric mean of these two terms finishes the proof, provided $(\alpha - \epsilon)/2 > \tilde{\alpha}$, which we can assume by taking α sufficiently close to one.

The Upper Bound on (5.43). Using the inequality $|\mathbb{I}_e \phi_s| \lesssim \chi_{R_s}^{(2)}$, and the inequalities (5.26) and (5.45), it is easy to see that

$$\sum_{s:(s,s') \in \mathbf{S}_{2,j}} |\langle \mathbb{I}_e \phi_s, \Delta_{s'} \rangle| \lesssim 2^{-12j} (\text{ann}')^{-\tilde{\alpha}} \sqrt{\frac{\text{scl} \cdot \text{ann}}{\text{scl}' \cdot \text{ann}'}}.$$

This is the required estimate.

The Proof of (5.12) for $\mathcal{S}_{3,j}$, $j \geq 1$. In this case, we have that the length of the rectangles $R_{s'}$ are greater than those of the rectangles R_s , as depicted in Figure 5. We show that

$$(5.46) \quad \text{FL}(\mathcal{S}_{3,j}) \lesssim (\text{ann}')^\epsilon \sqrt{\frac{\text{scl}' \cdot \text{ann}'}{\text{scl} \cdot \text{ann}}}$$

$$(5.47) \quad \text{FL}'(\mathcal{S}_{3,j}) \lesssim 2^{-10j} (\text{ann}')^{-\tilde{\alpha}} \sqrt{\frac{\text{scl} \cdot \text{ann}}{\text{scl}' \cdot \text{ann}'}}.$$

In particular, we do not claim any decay in the term $\text{FL}(\mathcal{S}_{3,j})$, in fact permitting a small increase in the parameter ann' . Recall that $0 < \epsilon < 1$ is a small quantity. See (5.23). But due to the form of the estimate in

Proposition 5.7, with the decay in 2^j and ann' in the estimate (5.47), these two estimates still prove (5.12) for $\mathcal{S}_{3,j}$.

For the proof of (5.46), we analyze the sums

$$(5.48) \quad \sum_{s' : (s, s') \in \mathcal{S}_{3,j}} |\langle \Delta_s, \mathbf{I}_{e_{s'}} \phi_{s'} \rangle|,$$

$$(5.49) \quad \sum_{s' : (s, s') \in \mathcal{S}_{3,j}} |\langle \mathbf{I}_{e_{s'}} \phi_s, \Delta_{s'} \rangle|,$$

$$(5.50) \quad \sum_{s' : (s, s') \in \mathcal{S}_{3,j}} |\langle \Delta_s, \Delta_{s'} \rangle|.$$

Here, $e_{s'} \in \omega_{s'} \subset \omega_s$.

The Upper Bound on (5.48). Regard s as fixed. We employ a variant of the notation established in (5.40). Let \tilde{R}_s be a rectangle with in the same coordinates axes as R_s . In the direction e_s , let it have length $1/\text{scl}'$, that is the (longer) length of the rectangles $R_{s'}$, and let it have the same width of R_s . Further assume that $2^j R_s \cap \tilde{R}_s = \emptyset$ but $2^{j+4} R_s \cap \tilde{R}_s \neq \emptyset$. (There is an obvious change in these requirements for $j = 1$.) Then, define

$$\tilde{\mathcal{S}}_{3,j} = \{(s, s') \in \mathcal{S}_{3,j} \mid R_{s'} \subset \tilde{R}_s\}.$$

With $\lesssim 2^{2j}$ choices of \tilde{R}_s , we can exhaust the collection $\mathcal{S}_{3,j}$. Thus, we prove a slightly stronger estimate in the parameter 2^j for the collection $\tilde{\mathcal{S}}_{3,j}$.

The main point here is that we have an analog of the estimate (5.32):

$$\sum_{s' : (s, s') \in \tilde{\mathcal{S}}_{3,j}} |\mathbf{I}_e \phi_{s'}| \lesssim \sqrt{\frac{\text{ann}'}{\text{ann}}} \chi_{\tilde{R}_s}^{(2)}.$$

The term in the square root takes into account the differing L^2 normalizations between the $\phi_{s'}$ and $\chi_{\tilde{R}_s}^{(2)}$. The proof of (5.32) can be modified to prove the estimate above.

We also have the analogs of the estimate (5.26). Putting these two together proves that

$$\begin{aligned} \sum_{s' : (s, s') \in \mathcal{S}_{3,j}} |\langle \Delta_s, \mathbf{I}_{e_{s'}} \phi_{s'} \rangle| &\lesssim 2^{-10j} (\text{ann}')^{-\tilde{\alpha}} \sqrt{\frac{|R_s|}{\tilde{R}_s}} \sqrt{\frac{\text{ann}'}{\text{ann}}} \\ &\lesssim 2^{-10j} (\text{ann}')^{-\tilde{\alpha}} \sqrt{\frac{\text{scl}' \cdot \text{ann}'}{\text{scl} \cdot \text{ann}}}. \end{aligned}$$

That is, we get the estimate we want with decay in ann' , we do not claim in general.

The Upper Bound on (5.49). We use the inequality

$$|\mathbb{I}_{e_{s'}} \phi_s| \lesssim \chi_{R_s}^{(2)}.$$

And we use the decomposition $\Delta_{s'} = \Delta_{s',1} + \Delta_{s',2} + \Delta_{s',3}$.

For the case of $\Delta_{s',1}$, we have $\omega_{s'} \subset \omega_s$. And the supports of the functions $\Delta_{s'}$ are well localized with respect to the vector field. See (5.57). Thus, in particular we have

$$\sum_{s' : (s,s') \in \mathbf{S}_{3,j}} |\Delta_{s'}| \lesssim (\text{ann}')^\epsilon \sqrt{\text{scl}' \cdot \text{ann}'}$$

Hence, we have

$$\sum_{s' : (s,s') \in \mathbf{S}_{3,j}} |\langle \chi_{R_s}^{(2)}, \Delta_{s'} \rangle| \lesssim (\text{ann}')^{-\epsilon} \sqrt{\frac{\text{scl}' \cdot \text{ann}'}{\text{scl} \cdot \text{ann}}}$$

which is the desired estimate.

Remark 5.51. It is the analysis of the sum

$$\sum_{s' : (s,s') \in \mathbf{S}_{3,j}} |\langle \mathbb{I}_e \phi_s, \Delta_{s',3} \rangle|$$

that prevents us from obtaining decay in the parameter ann' for certain choices of parameters scl , ann , scl' and ann' . This is why we have formulated (5.46) the way we have.

For the proof of (5.47), we analyze the sums

$$(5.52) \quad \sum_{s : (s,s') \in \mathbf{S}_{3,j}} |\langle \Delta_s, \mathbb{I}_e \phi_{s'} \rangle|,$$

$$(5.53) \quad \sum_{s : (s,s') \in \mathbf{S}_{3,j}} |\langle \mathbb{I}_e \phi_s, \Delta_{s'} \rangle|,$$

$$(5.54) \quad \sum_{s : (s,s') \in \mathbf{S}_{3,j}} |\langle \Delta_s, \Delta_{s'} \rangle|.$$

Here $e_{s'} \in \omega_{s'} \subset \omega_s$, and one can regard the interval $\omega_{s'}$ as fixed. It is essential that we obtain the decay in 2^j and ann' in these cases.

Indeed, these cases are easier, as the sum is over s . For fixed s' , there is a unique choice of interval $\omega_s \supset \omega_{s'}$. And the rectangles R_s are shorter than $R_{s'}$, but wider. Hence,

$$(5.55) \quad \#\{s : (s,s') \in \mathbf{S}_{3,j}\} \lesssim 2^{2j} \frac{\text{scl}}{\text{scl}'}$$

The Upper Bound on (5.52). We use the decomposition $\Delta_s = \Delta_{s,1} + \Delta_{s,2} + \Delta_{s,3}$, and the inequality $|\mathbf{I}_{e_{s'}} \phi_{s'}| \lesssim \chi_{R_{s'}}^{(2)}$.

For the sum associated with $\Delta_{s,1}$, we have

$$\begin{aligned} \sum_{s:(s,s') \in \mathbf{S}_{3,j}} |\langle \Delta_{s,1}, \mathbf{I}_{e_{s'}} \phi_{s'} \rangle| &\lesssim (\text{ann}')^{-\tilde{\alpha}} \sum_{s:(s,s') \in \mathbf{S}_{3,j}} \langle \chi_{R_s}^{(2)}, \chi_{R_{s'}}^{(2)} \rangle \\ &\lesssim 2^{-12j} (\text{ann}')^{-\tilde{\alpha}} \sqrt{\frac{\text{scl}' \cdot \text{ann}}{\text{scl} \cdot \text{ann}'}} \\ &\quad \times \#\{s : (s, s') \in \mathbf{S}_{3,j}\} \\ &\lesssim 2^{-10j} (\text{ann}')^{-\tilde{\alpha}} \sqrt{\frac{\text{scl}' \cdot \text{ann}'}{\text{scl} \cdot \text{ann}}}. \end{aligned}$$

This is the required estimate.

For the sum associated with $\Delta_{s,3}$, the critical properties are those of the corresponding sets F_s , described in (5.60) and (5.61). Note that the sets

$$\sum_{s:(s,s') \in \mathbf{S}_{3,j}} \mathbf{1}_{F_s} \lesssim (\text{ann}')^{2\epsilon}.$$

On the other hand,

$$\begin{aligned} \sum_{s:(s,s') \in \mathbf{S}_{3,j}} |F_s| &\lesssim 2^{2j} \frac{\text{scl}}{\text{scl}'} \sup_{s:(s,s') \in \mathbf{S}_{3,j}} |F_s| \\ &\lesssim 2^{2j} (\text{ann}')^{-\alpha+\epsilon} \frac{1}{\text{scl}' \cdot \text{ann}}. \end{aligned}$$

Here, we have used the estimate (5.55).

This permits us to estimate

$$\sum_{s:(s,s') \in \mathbf{S}_{3,j}} |\langle \Delta_{s,3}, \mathbf{I}_{e_{s'}} \phi_{s'} \rangle| \lesssim 2^{-10j} (\text{ann}')^{-\alpha+3\epsilon} \sqrt{\frac{\text{scl} \cdot \text{ann}'}{\text{scl}' \cdot \text{ann}}}$$

Note that the parity between the ‘primes’ is broken in this estimate. By inspection, one sees that this last term is at most

$$\lesssim 2^{-10j} (\text{ann}')^{-\tilde{\alpha}} \sqrt{\frac{\text{scl}' \cdot \text{ann}'}{\text{scl} \cdot \text{ann}}}.$$

Indeed, the claimed inequality amounts to

$$(\text{ann}')^{-\alpha+3\epsilon} \text{scl} \lesssim (\text{ann}')^{-\tilde{\alpha}} \text{scl}'.$$

We have to permit scl' to be as small as 1, whereas scl can be as big as ann . But $\alpha > 1$, and $\text{ann} < \text{ann}'$, so the inequality above is trivially true. This completes the analysis of (5.52).

The Upper Bound on (5.53). We only need to use the inequality $|\mathbb{I}_{e_{s'}} \phi_s| \lesssim \chi_{R_s}^{(2)}$, and the inequalities (5.26). It follows that

$$\begin{aligned} \sum_{s: (s, s') \in \mathbf{S}_{3,j}} |\langle \mathbb{I}_{e_{s'}} \phi_s, \Delta_{s'} \rangle| &\lesssim \sum_{s: (s, s') \in \mathbf{S}_{3,j}} \langle \chi_{R_s}^{(2)}, |\Delta_{s'}| \rangle \\ &\lesssim 2^{-10j} (\text{ann}')^{-\tilde{\alpha}} \sqrt{\frac{\text{scl}' \cdot \text{ann}'}{\text{scl} \cdot \text{ann}}}. \end{aligned}$$

The Fourier Localization Estimate

The precise form of the inequalities quantifying the Fourier localization effect follows.

Fourier Localization Lemma 5.56. *Let $1 < \alpha < 2$, $\epsilon < (\alpha - 1)/20$, and v be a vector field with $\|v\|_{C^\alpha} \leq 1$. Let s be a tile with*

$$1 < \text{scl}(s) = \text{scl} \leq \text{ann}(s) = \text{ann} < \frac{1}{16} 2^k.$$

Let

$$f_s = \text{Mod}_{-c(\omega_s)} \phi_s$$

Let ζ be a smooth function on \mathbb{R} , with $\mathbf{1}_{(-2,2)} \leq \hat{\zeta} \leq \mathbf{1}_{(-3,3)}$ and set $\zeta_{2^k}(y) = 2^k \zeta(y 2^k)$. We have this inequality valid for all unit vectors e with $|e - e_s| \leq |\omega_s|$.

$$(5.57) \quad \left| f_s(x) - \int_{\mathbb{R}} f_s(x - ye) \zeta_{2^k}(y) dy \right| \lesssim (\text{scl} 2^{(\alpha-1)k})^{-1+\epsilon} \chi_{R_s}^{(2)}(x) \mathbf{1}_{\widetilde{\omega}_s}(v(x))$$

$$(5.58) \quad + (2^k \text{scl})^{-10} \chi_{R_s}^{(2)}(x)$$

$$(5.59) \quad + |R_s|^{-1/2} \mathbf{1}_{F_s}(x),$$

where $\widetilde{\omega}_s$ is a sub arc of the unit circle, with $\widetilde{\omega}_s = \lambda \omega_s$, and $1 < \lambda < 2^{ek}$. Moreover, the sets $F_s \subset \mathbb{R}^2$ satisfy

$$(5.60) \quad |F_s| \lesssim 2^{-(\alpha-\epsilon)k} (1 + \text{scl}^{-1})^{\alpha-1} |R_s|,$$

$$(5.61) \quad F_s \subset 2^{ek} R_s \cap v^{-1}(\widetilde{\omega}_s) \cap \left\{ \left| \frac{\partial(v \cdot e_{s\perp})}{\partial e} \right| > 2^{(1-\epsilon)k} \frac{\text{scl}}{\text{ann}} \right\}.$$

The appearance of the set F_s is explained in part because the only way for the function ϕ_s to oscillate quickly along the direction e_s is that the vector field moves back and forth across the interval ω_s very quickly. This sort of behavior, as it turns out, is the only obstacle to the frequency localization described in this Lemma.

Note that the degree of localization improves in k . In (5.57), it is important that we have the localization in terms of the directions

of the vector field. The terms in (5.58) will be very small in all the instances that we apply this lemma. The third estimate (5.59) is the most complicated, as it depends upon the exceptional set. The form of the exceptional set in (5.61) is not so important, but the size estimate, as a function of $\alpha > 1$, in (5.60) is.

PROOF. We collect some elementary estimates. Throughout this argument, $\vec{y} := y e \in \mathbb{R}^2$.

$$(5.62) \quad \int_{|y| > t2^{-k}} |y2^k| |\zeta_{2^k}(y)| dy \lesssim t^{-N}, \quad t > 1.$$

This estimate holds for all $N > 1$. Likewise,

$$(5.63) \quad \int_{|u| > t\text{scl}^{-1}} |us\text{cl}| |\text{scl} \psi(\text{scl} u)| du \lesssim t^{-N}, \quad t > 1.$$

More significantly, we have for all $x \in \mathbb{R}^2$,

$$(5.64) \quad \int_{\mathbb{R}^2} e^{i\xi_0 y} \varphi_{R_s}^{(2)}(x - \vec{y}) \zeta_{2^k}(y) dy = \varphi_{R_s}^{(2)}(x) \quad -2^k < \xi_0 < 2^k,$$

where $\varphi_{R_s}^{(2)} = T_{c(R_s)} D_{R_s}^2 \varphi$. This is seen by taking the Fourier transform. Likewise, by (4.17), for vectors v_0 of unit length,

$$\int_{\mathbb{R}} e^{-2\pi i u \lambda_0} \varphi_{R_s}^{(2)}(x - uv_0) \text{scl} \psi(\text{scl} u) du \neq 0$$

implies that

$$(5.65) \quad \text{scl} \leq \lambda_0 + \xi \cdot v_0 \leq \frac{9}{8} \text{scl}, \quad \text{for some } \xi \in \text{supp}(\widehat{\varphi_{R_s}^{(2)}}).$$

At this point, it is useful to recall that we have specified the frequency support of φ to be in a small ball of radius κ in (4.16). This has the implication that

$$(5.66) \quad |\xi \cdot e_s| \leq \kappa \text{scl}, \quad |\xi \cdot e_{s\perp}| \leq \kappa \text{ann} \quad \xi \in \text{supp}(\widehat{\varphi_{R_s}^{(2)}})$$

We begin the main line of the argument, which comes in two stages. In the first stage, we address the issue of the derivative below exceeding a ‘large’ threshold.

$$e \cdot \mathbf{D}v(x) \cdot e_{s\perp} = \frac{\partial v \cdot e_{s\perp}}{\partial e}$$

We shall find that this happens on a relatively small set, the set F_s of the Lemma. Notice that due to the eccentricity of the rectangle R_s , we can only hope to have some control over the derivative in the long direction of the rectangle, and e essentially points in the long direction. We are interested in derivative in the direction $e_{s\perp}$ as that is

the direction that v must move to cross the interval ω_{s2} . A substantial portion of the technicalities below are forced upon us due to the few choices of scales $1 \leq \text{scl} \leq 2^{\varepsilon k}$, for some small positive ε .¹

Let $0 < \varepsilon_1, \varepsilon_2 < \varepsilon$ to be specified in the argument below. In particular, we take

$$0 < \varepsilon_1 \leq \min\left(\frac{1}{1200}, \kappa \frac{\alpha-1}{20}\right), \quad 0 < \varepsilon_2 < \frac{1}{18}(\alpha - 1).$$

We have the estimate

$$|f_s(x)| + \left| \int_{\mathbb{R}} f_s(x - \vec{y}) \zeta_{2^k}(y) dy \right| \lesssim 2^{-10k} \chi_{R_s}^{(2)}(x), \quad x \notin 2^{\varepsilon_1 k} R_s.$$

This follows from (5.62) and the fact that the direction e differs from e_s by an no more than the measure of the angle of uncertainty for R_s . This is as claimed in (5.58). We need only consider $x \in 2^{\varepsilon_1 k} R_s$.

Let us define the sets F_s , as in (5.59). Define

$$\lambda_s := \begin{cases} 2^{\varepsilon_1 k} & \frac{\text{scl}}{\text{ann}} < 2^{-2\varepsilon_1 k} \\ 8 & \text{otherwise} \end{cases}$$

Let $\lambda\omega_s$ denote the interval on the unit circle with length $\lambda|\omega_s|$, and the same center as ω_s .² This is our $\tilde{\omega}$ of the Lemma; the set F_s of the Lemma is

$$(5.67) \quad F_s := 2^{\varepsilon_1 k} R_s \cap v^{-1}(\lambda_s \omega_s) \cap \left\{ \left| \frac{\partial(v \cdot e_{s\perp})}{\partial e} \right| > 2^{(1-\varepsilon_2)k} \frac{\text{scl}}{\text{ann}} \right\}.$$

And so to satisfy (5.61), we should take $\varepsilon_1 < 1/1200$.

Let us argue that the measure of F_s satisfies (5.60). Fix a line ℓ in the direction of e . We should see that the one dimensional measure

$$(5.68) \quad |\ell \cap F_s| \lesssim 2^{-k(\alpha-\varepsilon)} (1 + \text{scl}^{-1})^{\alpha-1} \text{scl}^{-1}.$$

For we can then integrate over the choices of ℓ to get the estimate in (5.60).

The set $\ell \cap F_s$ is viewed as a subset of \mathbb{R} . It consists of open intervals $A_n = (a_n, b_n)$, $1 \leq n \leq N$. List them so that $b_n < a_{n+1}$ for all n . Partition the integers $\{1, 2, \dots, N\}$ into sets of consecutive integers $I_\sigma = [m_\sigma, n_\sigma] \cap \mathbb{N}$ so that for all points x between the left-hand endpoint of A_{m_σ} and the right-hand endpoint of A_{n_σ} , the derivative $\partial(v \cdot e_{s\perp})/\partial e$ has the same sign. Take the intervals of integers I_σ to be maximal with respect to this property.

¹The scales of approximate length one are where the smooth character of the vector field helps the least. The argument becomes especially easy in the case that $\sqrt{\text{ann}} \leq \text{scl}$, as in the case, $|\omega_s| \gtrsim \text{scl}^{-1}$.

²We have defined λ_s this way so that $\lambda_s \omega_s$ makes sense.

For $x \in F_s$, the partial derivative of v , in the direction that is transverse to $\lambda_s \omega_s$, is large with respect to the length of $\lambda_s \omega_s$. Hence, v must pass across $\lambda_s \omega_s$ in a small amount of time:

$$\sum_{m \in I_\sigma} |A_m| \lesssim 2^{-(1-\varepsilon_1-\varepsilon_2)k} \quad \text{for all } \sigma.$$

Now consider intervals A_{n_σ} and $A_{1+n_\sigma} = A_{m_{\sigma+1}}$. By definition, there must be a change of sign of $\partial v(x) \cdot e_{s\perp} / \partial e$ between these two intervals. And so there is a change in this derivative that is at least as big as $2^{(1-\varepsilon_2)k} \frac{\text{scl}}{\text{ann}}$. The partial derivative is also Hölder continuous of index $\alpha - 1$, which implies that A_{n_σ} and $A_{m_{\sigma+1}}$ cannot be very close, specifically

$$\text{dist}(A_{n_\sigma}, A_{m_{\sigma+1}}) \geq \left(2^{(1-\varepsilon_2)k} \frac{\text{scl}}{\text{ann}}\right)^{\alpha-1}$$

As all of the intervals A_n lie in an interval of length $2^{\varepsilon_1 k} \text{scl}^{-1}$, it follows that there can be at most

$$1 \leq \sigma \lesssim 2^{\varepsilon_1 k} \text{scl}^{-1} \left(2^{(1-\varepsilon_2)k} \frac{\text{scl}}{\text{ann}}\right)^{-\alpha+1}$$

intervals I_σ . Consequently,

$$\begin{aligned} |\ell \cap F_s| &\lesssim 2^{-(1-2\varepsilon_1-\varepsilon_2+(1-\varepsilon_2)(\alpha-1))k} \text{scl}^{-1} \left(\frac{\text{ann}}{\text{scl}}\right)^{\alpha-1} \\ &\lesssim 2^{-(\alpha-2\varepsilon_1-2\varepsilon_2)k} \text{scl}^{-\alpha+1} \text{scl}^{-1} \end{aligned}$$

We have already required $0 < \varepsilon_1 < \frac{\epsilon}{600}$ and taking $0 < \varepsilon_2 < \frac{\epsilon}{600}$ will achieve the estimate (5.68). This completes the proof of (5.60).

The second stage of the proof begins, in which we make a detailed estimate of the difference in question, seeking to take full advantage of the Fourier properties (5.62)–(5.65), as well as the derivative information encoded into the set F_s .

We consider the difference in (5.57) in the case of $x \in 2^{\varepsilon_1 k} R_s - v^{-1}(\lambda_s \omega_s)$. In particular, x is not in the support of f_s , and due to the smoothness of the vector field, the distance of x to the support of f_s is at least

$$\gtrsim 2^{\varepsilon_1 k} \frac{\text{scl}}{\text{ann}}$$

so that by (5.62), we can estimate

$$\left| f_s(x) - \int_{\mathbb{R}} f_s(x - \vec{y}) \zeta_{2^k}(y) dy \right| \lesssim (2^{\varepsilon_1 k} \text{scl})^{-N} |R_s|^{-1/2}$$

which is the estimate (5.58).

We turn to the proof of (5.57). For $x \in 2^{\varepsilon_1 k} R_s \cap v^{-1}(\lambda_s \omega_s)$, we always have the bound

$$\left| f_s(x) - \int_{\mathbb{R}} f_s(x - \vec{y}) \zeta_{2^k}(y) dy \right| \lesssim 2^{10\varepsilon_1 k / \kappa} \chi_{R_s}^{(2)}(x)^{10} \mathbf{1}_{\lambda_s \omega_s}(x).$$

It is essential that we have $|e - e_s| \leq |\omega_s|$ for this to be true, and κ enters in on the right hand side through the definition (4.40).

We establish the bound

$$(5.69) \quad \left| f_s(x) - \int_{\mathbb{R}} f_s(x - \vec{y}) \zeta_{2^k}(y) dy \right| \lesssim (\text{scl} 2^{(\alpha-1)k})^{-1} |R_s|^{-1/2},$$

$$x \in 2^{\varepsilon_1 k} R_s \cap v^{-1}(\lambda_s \omega_s) \cap F_s^c.$$

We take the geometric mean of these two estimates, and specify that $0 < \varepsilon_1 < \kappa \frac{\alpha-1}{20}$ to conclude (5.57).

It remains to consider $x \in 2^{\varepsilon_1 k} R_s \cap v^{-1}(\lambda_s \omega_s) \cap F_s^c$, and now some detailed calculations are needed. To ease the burden of notation, we set

$$\exp(x) := e^{-2\pi i u c(\omega_s) \cdot v(x)}, \quad \Phi(x, x') = \varphi_{R_s}^{(2)}(x - uv(x')),$$

with the dependency on u being suppressed, and define

$$w(du, d\vec{y}) := \text{scl} \psi(\text{scl} u) \zeta_{2^k}(y) du d\vec{y}.$$

In this notation, note that

$$\begin{aligned} f_s &= \text{Mod}_{-c(\omega_s)} \phi_s \\ &= \int_{\mathbb{R}} e^{c(\omega_s)(x-uv(x))-c(\omega_s)x} \varphi_{R_s}^{(2)}(x - uv(x)) \text{scl} \psi(\text{scl} u) du \\ &= \int_{\mathbb{R}} \exp(x) \Phi(x, x) \text{scl} \psi(\text{scl} u) du \\ &= \int_{\mathbb{R}^2} \int_{\mathbb{R}} \exp(x) \Phi(x, x) w(du, d\vec{y}), \end{aligned}$$

since ζ has integral on \mathbb{R}^2 . In addition, we have

$$\begin{aligned} \int_{\mathbb{R}^2} f_s(x - \vec{y}e) \zeta_{2^k}(\vec{y}) d\vec{y} &= \int_{\mathbb{R}^2} \int_{\mathbb{R}} e^{c(\omega_s)(x-uv(x-\vec{y}))-c(\omega_s)x} \\ &\quad \times \varphi_{R_s}^{(2)}(x - uv(x - \vec{y})) \text{scl} \psi(\text{scl} u) du d\vec{y} \\ &= \int_{\mathbb{R}^2} \int_{\mathbb{R}} \exp(x - \vec{y}) \Phi(x - \vec{y}, x - \vec{y}) w(du, d\vec{y}). \end{aligned}$$

We are to estimate the difference between these two expressions, which is the difference of

$$\begin{aligned} \text{Diff}_1(x) &:= \int_{\mathbb{R}^2} \int_{\mathbb{R}} \exp(x) \Phi(x, x) - \exp(x - \vec{y}) \Phi(x - \vec{y}, x) w(du, d\vec{y}) \\ \text{Diff}_2(x) &:= \int_{\mathbb{R}^2} \int_{\mathbb{R}} \exp(x - \vec{y}) \{ \Phi(x - \vec{y}, x - \vec{y}) - \Phi(x - \vec{y}, x) \} w(du, d\vec{y}) \end{aligned}$$

The analysis of both terms is quite similar. We begin with the first term.

Note that by (5.64), we have

$$\text{Diff}_1(x) = \int_{\mathbb{R}} \int_{\mathbb{R}} \{ \exp(x) - \exp(x - \vec{y}) \} \Phi(x - \vec{y}, x) w(du, d\vec{y}).$$

We make a first order approximation to the difference above. Observe that

$$\begin{aligned} \exp(x) - \exp(x - \vec{y}) &= \exp(x) \{ 1 - \exp(x - \vec{y}) \overline{\exp(x)} \} \\ (5.70) \quad &= \exp(x) \{ 1 - e^{-2\pi i u [c(\omega_s) \cdot \mathbf{D}v(x) \cdot e] \vec{y}} \} \\ &\quad + O(|u| \text{ann} |\vec{y}|^\alpha). \end{aligned}$$

In the Big-Oh term, $|u|$ is typically of the order scl^{-1} , and $|\vec{y}|$ is of the order 2^{-k} . Hence, direct integration leads to the estimate of this term by

$$\begin{aligned} \int_{\mathbb{R}} \int_{\mathbb{R}} |u| \text{ann} |y|^\alpha |\Phi(x - \vec{y}, x)| \cdot |w(du, d\vec{y})| \\ \lesssim |R_s|^{-1/2} \frac{\text{ann}}{\text{scl}} 2^{-\alpha k} \\ \lesssim |R_s|^{-1/2} (\text{scl} 2^{(\alpha-1)k})^{-1}. \end{aligned}$$

This is (5.69).

The term left to estimate is

$$\begin{aligned} \text{Diff}'_1(x) &:= \int_{\mathbb{R}} \int_{\mathbb{R}} \exp(x) (1 - e^{-2\pi i u [c(\omega_s) \cdot \mathbf{D}v(x) \cdot e] \vec{y}}) \\ &\quad \Phi(x - \vec{y}, x) w(du, d\vec{y}). \end{aligned}$$

Observe that by (5.64), the integral in y is zero if

$$|u [c(\omega_s) \cdot \mathbf{D}v(x) \cdot e]| \leq 2^k.$$

Here we recall that $c(\omega_s) = \frac{3}{2} \text{ann} e_{s\perp}$. By the definition of F_s , the partial derivative is small, namely

$$|e_{s\perp} \cdot \mathbf{D}v(x) \cdot e| \lesssim 2^{(1-\varepsilon_1)k} \frac{\text{scl}}{\text{ann}}.$$

Hence, the integral in y in $\text{Diff}'_1(x)$ can be non-zero only for

$$\text{scl}|u| \gtrsim 2^{\varepsilon_1 k}.$$

By (5.63), it follows that in this case we have the estimate

$$|\text{Diff}'_1(x)| \lesssim 2^{-2k} |R_s|^{-1/2}$$

This estimate holds for $x \in 2^{\varepsilon_1 k} R_s \cap v^{-1}(\lambda_s \omega_s) \cap F_s^c$ and this completes the proof of the upper bound (5.69) for the first difference.

We consider the second difference Diff_2 . The term $v(x - \vec{y})$ occurs twice in this term, in $\exp(x - \vec{y})$, and in $\Phi(x - \vec{y}, x - \vec{y})$. We will use the approximation (5.70), and similarly,

$$\begin{aligned} & \Phi(x - \vec{y}, x - \vec{y}) - \Phi(x - \vec{y}, x) \\ &= \varphi_{R_s}^{(2)}(x - \vec{y} - uv(x - \vec{y})) - \varphi_{R_s}^{(2)}(x - \vec{y} - uv(x)) \\ &= \varphi_{R_s}^{(2)}(x - \vec{y} - uv(x) - u\mathbf{D}v(x)\vec{y}) \\ &\quad - \varphi_{R_s}^{(2)}(x - \vec{y} - uv(x)) + O(\text{ann } |u| |y|^\alpha) \\ &= \Delta\Phi(x, \vec{y}) + O(\text{ann } |u| |\vec{y}|^\alpha) \end{aligned}$$

The Big-Oh term gives us, upon integration in u and \vec{y} , a term that is no more than

$$\lesssim |R_s|^{-1/2} \frac{\text{ann}}{\text{scl}} 2^{-\alpha k} \lesssim |R_s|^{-1/2} (\text{scl} 2^{(\alpha-1)k})^{-1}.$$

This is as required by (5.69).

We are left with estimating

$$\text{Diff}'_2(x) := \int_{\mathbb{R}} \int_{\mathbb{R}} e^{-2\pi i uc(\omega_s) \cdot (v(x) - \mathbf{D}v(x) \cdot \vec{y})} \Delta\Phi(x, \vec{y}) w(du, d\vec{y}).$$

By (5.64), the integral in y is zero if both of these conditions hold.

$$|uc(\omega_s)\mathbf{D}v(x) \cdot e| < 2^k,$$

$$|[uc(\omega_s)\mathbf{D}v(x) - \xi - u\xi\mathbf{D}v(x)] \cdot e| < 2^k, \quad \xi \in \text{supp}(\widehat{\varphi_{R_s}^{(2)}})$$

Both of these conditions are phrased in terms of the derivative which is controlled as $x \notin F_s$. In fact, the first condition already occurred in the first case, and it is satisfied if

$$\text{scl}|u| \lesssim 2^{\varepsilon_1 k}.$$

Recalling the conditions (5.66), the second condition is also satisfied for the same set of values for u . The application of (5.63) then yields a very small bound after integrating $|u| \gtrsim 2^{\varepsilon_1 k} \text{scl}^{-1}$. This completes the proof our technical Lemma. \square

References

- [1] Angeles Alfonseca, Fernando Soria, and Ana Vargas, *A remark on maximal operators along directions in \mathbb{R}^2* , Math. Res. Lett. **10** (2003), no. 1, 41–49. MR1960122 (2004j:42010) ↑8
- [2] Angeles Alfonseca, *Strong type inequalities and an almost-orthogonality principle for families of maximal operators along directions in \mathbb{R}^2* , J. London Math. Soc. (2) **67** (2003), no. 1, 208–218. MR1942421 (2003j:42015) ↑8
- [3] J. Bourgain, *A remark on the maximal function associated to an analytic vector field*, Analysis at Urbana, Vol. I (Urbana, IL, 1986–1987), 1989, pp. 111–132. MR 90h:42028 ↑4, 6, 23, 24
- [4] Camil Muscalu, Terence Tao, and Christoph Thiele, *Uniform estimates on paraproducts*, J. Anal. Math. **87** (2002), 369–384. Dedicated to the memory of Thomas H. Wolff. MR 1945289 (2004a:42023) ↑42
- [5] Anthony Carbery, Andreas Seeger, Stephen Wainger, and James Wright, *Classes of singular integral operators along variable lines*, J. Geom. Anal. **9** (1999), no. 4, 583–605. MR 2001g:42026 ↑6, 28
- [6] Lennart Carleson, *On convergence and growth of partial sums of Fourier series*, Acta Math. **116** (1966), 135–157. MR 33 #7774 ↑vii, 2
- [7] Michael Christ, Alexander Nagel, Elias M. Stein, and Stephen Wainger, *Singular and maximal Radon transforms: analysis and geometry*, Ann. of Math. (2) **150** (1999), no. 2, 489–577. MR 2000j:42023 ↑6
- [8] A. Córdoba and R. Fefferman, *On differentiation of integrals*, Proc. Nat. Acad. Sci. U.S.A. **74** (1977), no. 6, 2211–2213. MR0476977 (57 #16522) ↑7, 11
- [9] Charles Fefferman, *Pointwise convergence of Fourier series*, Ann. of Math. (2) **98** (1973), 551–571. MR 49 #5676 ↑40
- [10] ———, *The multiplier problem for the ball*, Ann. of Math. (2) **94** (1971), 330–336. MR 45 #5661 ↑vii
- [11] Loukas Grafakos and Xiaochun Li, *Uniform bounds for the bilinear Hilbert transform, I*, Ann. of Math. **159** (2004), 889–933. ↑31, 42
- [12] Nets Hawk Katz, *Maximal operators over arbitrary sets of directions*, Duke Math. J. **97** (1999), no. 1, 67–79. MR 2000a:42036 ↑8
- [13] ———, *A partial result on Lipschitz differentiation*, Harmonic analysis at Mount Holyoke (South Hadley, MA, 2001), 2003, pp. 217–224. MR 979 942 ↑6
- [14] Joonil Kim, *Maximal Average Along Variable Lines* (2006). ↑28
- [15] Michael T. Lacey and Xiaochun Li, *Maximal theorems for the directional Hilbert transform on the plane*, Trans. Amer. Math. Soc. **358** (2006), no. 9, 4099–4117 (electronic). MR 2219012 ↑2, 4, 10, 31, 35, 37, 40, 53, 54, 55, 59
- [16] Michael T. Lacey and Christoph Thiele, *L^p estimates on the bilinear Hilbert transform for $2 < p < \infty$* , Ann. of Math. (2) **146** (1997), no. 3, 693–724. MR1491450 (99b:42014) ↑2
- [17] ———, *On Calderón’s conjecture for the bilinear Hilbert transform*, Proc. Natl. Acad. Sci. USA **95** (1998), no. 9, 4828–4830 (electronic). MR 1619285 (99e:42013) ↑2
- [18] Michael Lacey and Christoph Thiele, *On Calderón’s conjecture*, Ann. of Math. (2) **149** (1999), no. 2, 475–496. MR 1689336 (2000d:42003) ↑2
- [19] Michael T. Lacey and Christoph Thiele, *L^p estimates for the bilinear Hilbert transform*, Proc. Nat. Acad. Sci. U.S.A. **94** (1997), no. 1, 33–35. MR 1425870 (98e:44001) ↑2

- [20] Michael Lacey and Christoph Thiele, *A proof of boundedness of the Carleson operator*, Math. Res. Lett. **7** (2000), no. 4, 361–370. MR 2001m:42009 ↑[2](#), [10](#), [40](#), [43](#), [53](#)
- [21] Camil Muscalu, Terence Tao, and Christoph Thiele, *Multi-linear operators given by singular multipliers*, J. Amer. Math. Soc. **15** (2002), no. 2, 469–496 (electronic). MR 2003b:42017 ↑[5](#), [48](#)
- [22] Alexander Nagel, Elias M. Stein, and Stephen Wainger, *Hilbert transforms and maximal functions related to variable curves*, Harmonic analysis in Euclidean spaces (Proc. Sympos. Pure Math., Williams Coll., Williamstown, Mass., 1978), Part 1, 1979, pp. 95–98. MR 81a:42027 ↑[6](#), [23](#)
- [23] D. H. Phong and Elias M. Stein, *Hilbert integrals, singular integrals, and Radon transforms. II*, Invent. Math. **86** (1986), no. 1, 75–113. MR 88i:42028b ↑[6](#)
- [24] ———, *Hilbert integrals, singular integrals, and Radon transforms. I*, Acta Math. **157** (1986), no. 1-2, 99–157. MR 88i:42028a ↑[6](#)
- [25] Elias M. Stein, *Problems in harmonic analysis related to curvature and oscillatory integrals*, Proceedings of the International Congress of Mathematicians, Vol. 1, 2 (Berkeley, Calif., 1986), 1987, pp. 196–221. MR 89d:42028 ↑[2](#), [6](#)
- [26] E. M. Stein, *Harmonic analysis: real-variable methods, orthogonality, and oscillatory integrals*, Princeton Mathematical Series, vol. 43, Princeton University Press, Princeton, NJ, 1993. With the assistance of Timothy S. Murphy; Monographs in Harmonic Analysis, III. MR 95c:42002 ↑[vii](#)
- [27] Jan-Olov Strömberg, *Maximal functions associated to rectangles with uniformly distributed directions*, Ann. Math. (2) **107** (1978), no. 2, 399–402. MR0481883 (58 #1978) ↑[2](#), [8](#), [19](#)
- [28] ———, *Weak estimates on maximal functions with rectangles in certain directions*, Ark. Mat. **15** (1977), no. 2, 229–240. MR0487260 (58 #6911) ↑[2](#), [8](#)