

The β -neurexin–neuroligin link is essential for quantum brain dynamics

Danko Dimchev Georgiev ¹, Medical University Of Varna, Bulgaria

Abstract

There are many blank areas in understanding the brain dynamics and especially how it gives rise to conscious experience. Quantum mechanics is believed to be capable of explaining the enigma of consciousness, however till now there is not good enough model considering both the data from clinical neurology and having some explanatory power! In this paper is presented a novel model in defense of macroscopic quantum events within and between neural cells. The β -neurexin-neuroligin link is claimed to be not just the core of the central neural synapse, instead it is a device mediating entanglement between the cytoskeletons of the cortical neurons. The neurexin is also participating in the process of exocytosis through quantum tunneling. The gap junction tunneling supposed by Stuart Hameroff is shown to be incapable of sustaining quantum coherence between neurons for the needed 25 milliseconds. The possible role of DLBs, mitochondria and different types of glia in conscious experience is rationally criticized.

KEYWORDS: macroscopic quantum coherence, interneuronal entanglement, cortex, consciousness, glia, gap junctions, the Hameroff-Penrose Orch OR model of consciousness, quantum teleportation, quantum tunneling, exocytosis, neuromediator release, enzyme action, decoherence, shielding, glycosaminoglycans, actin meshwork, gel-sol transitions, synaptic plasticity

¹ e-mail: dankomed@yahoo.com

1. Intraneuronal macroscopic quantum coherence

There are a couple of models trying to resolve the enigmatic feature of consciousness. The most popular is the Hameroff-Penrose Orch OR model (1994) supposing that microtubule network within the neurons and glial cells is acting like a quantum computer. The tubulins are in superposition and the collapse of the wave function is driven by the quantum gravity [1,2,3]. A string theory model is developed by Dimitri Nanopoulos and Nick Mavromatos (1995) [4,5,6] and is further refined into QED-Cavity model (2002) supposing dissipationless energy transfer and biological quantum teleportation [7,8]. The last possibility is fundamental for the model presented in this paper.

The macroscopic quantum coherence is defined as a quantum state governed by a macroscopic wavefunction, which is shared by multiple particles. This typically involves the spatiotemporal organization of the multiparticle system and is closely related to what is called 'Bose-Einstein condensation'. Examples of quantum coherence in many particle macroscopic systems include superfluidity, superconductivity, and the laser. Of these three paradigm systems, the former two (superfluidity and superconductivity) are basically equilibrium systems, whereas the laser is our first example of an open system, which achieves coherence by energetic pumping - this latter idea is of the greatest importance for understanding the general implications of coherence. The laser functions in thermal environments (room temperature) and there are other, perhaps many other, nonequilibrium possibilities for coherence to exist and endure at macroscopic and thermally challenging scales, as for example, Frohlich has shown!

Observable quantum effects in biological matter are expected to be strongly suppressed mainly due to the macroscopic nature of most biological entities, as well as the fact that such systems live at near room temperature. These conditions normally result in a very fast collapse of the pertinent wave-functions to one of the allowed classical states. In attempt to refute the quantum mechanical model of consciousness Max Tegmark [9] has created a set of equations expressing in terms of time to decoherence (τ_{dec}) the influences of the surrounding environment on the microtubule network, which is supposed to be in quantum coherence (S. Hameroff, R. Penrose, 1994). Despite of Tegmark's failure to reject the quantum model of consciousness, his approach towards calculating time to decoherence for a studied process is a good preliminary step to do!

According to Stuart Hameroff (1999) the brain operates at 37.6 degrees centigrade, and deviations in brain temperature in either direction are not well tolerated for consciousness. This temperature is quite toasty compared to the extreme cold needed for quantum technological devices which operate near absolute zero.

In technology, the extreme cold serves to prevent thermal excitations, which could disrupt the quantum state. However proposals for biological quantum states suggest that biological heat is funneled (Conrad) or used to pump coherent excitations (Frohlich, or Fermi-Pasta-Ulam resonance, or Davydov solitons). In other words biomolecular systems may have evolved to utilize thermal energy to drive coherence. The assumption/prediction by quantum advocates is that biological systems (at least those with crystal lattice structures) have evolved techniques to funnel thermal energy to coherent vibrations conducive to quantum coherence, and/or to insulate quantum states through gelation or plasma phase screens!

The neural cytoplasm exists in different phases of liquid "sol" (solution), and solid "gel" (gelatinous phases of various sorts, "jello"). Transition between sol and gel phases depends on actin polymerization. Triggered by changes in calcium ion concentration, actin copolymerizes with different types of "actin cross-linking proteins" to form dense meshwork of microfilaments and various types of gels which encompass microtubules and organelles (soup to jello). The particular type of actin cross-linkers determines characteristics of the actin gels. Gels depolymerize back to liquid phase by calcium ions activating gelsolin protein, which severs actin (jello to soup). Actin repolymerizes into gel when calcium ion concentration is reduced (soup to jello). Actin gel, ordered water "jello" phases alternate with phases of liquid, disordered soup. Exchange of calcium ions between actin and microtubules (and microtubule-bound calmodulin) can mediate such cycles.

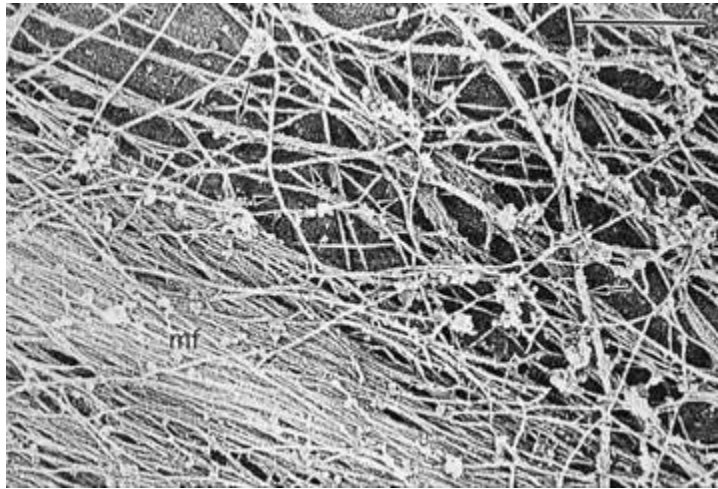

Fig. 1 | The actin monomers self-assemble suddenly into filaments forming a meshwork. The actin gel mesh encompasses the hidden microtubules insulating them from environmental decoherence.

Even in the "sol", or liquid phase, water within cells is not truly liquid and random. Pioneering work by Clegg (1984) and others have shown that water within cells is to a large extent "ordered," and plays the role of an active component rather than inert background solvent. Neutron diffraction studies indicate several layers of ordered water on such surfaces, with several additional layers of partially ordered water. Thus when the actin meshwork encompasses the microtubules it orders the water molecules in the vicinity, which like a laser shield the quantum entanglement between the tubulins!

The transition between the alternating phases of solution and gelation in cytoplasm depends on the polymerization of actin, and the particular character of the actin gel in turn depends on actin cross-linking. Of the various cross-linker related types of gels, some are viscoelastic, but others (e.g. those induced by the actin cross-linker avidin) can be deformed by an applied force without response. Cycles of actin gelation can be rapid, and in neurons, have been shown to correlate with the release of neurotransmitter vesicles from presynaptic axon terminals. In dendritic spines, whose synaptic efficacy mediates learning, rapid actin gelation and motility mediate synaptic function, and are sensitive to anesthetics (S. Kaech et al., 1999).

In the Orch OR model, actin gelation encases microtubules during their quantum computation phase. Afterwards, the gel liquefies to an aqueous form suitable for communication with the external environment. Such alternating phases can explain how input from and output to the environment can occur without disturbing quantum isolation.

2. The Hameroff's gap junction tunneling

According to Stuart Hameroff (1999) [2] each brain neuron is estimated to contain about 10^7 tubulins. If, say, 10 percent of each neuron's tubulins became coherent, then tubulins within roughly $2 \cdot 10^4$ gap junction connected neurons would be required for a 25 millisecond Orch OR event, or 10^3 neurons for a 500 millisecond Orch OR event, etc.

Sir John Eccles and Karl Pribram have advocated dendro-dendritic processing, including processing among dendrites on the same neuron. Eccles in particular pointed at dendritic arborizations of pyramidal cells in cerebral cortex as the locus of conscious processes! Francis Crick suggested that mechanical dynamics of the dendritic spines were essential to higher processes including consciousness.

Another "fly in the ointment" of the conventional approach is the prevalence of gap junction connections in the brain. In addition to chemical synaptic connections, neurons and glia are widely interconnected by electrotonic gap junctions. These are window-like portholes between adjacent neural processes (axon-dendrite, dendrite-dendrite, dendrite-glia cell). Cytoplasm flows through the gap, which is only 4 nm between the two processes, and the cells are synchronously coupled electrically via their common gap junction. Eric Kandel remarks that neurons connected by gap junctions behave like "one giant neuron". The role of gap junctions in thalamo-cortical 40 Hz is unclear, but currently under investigation.

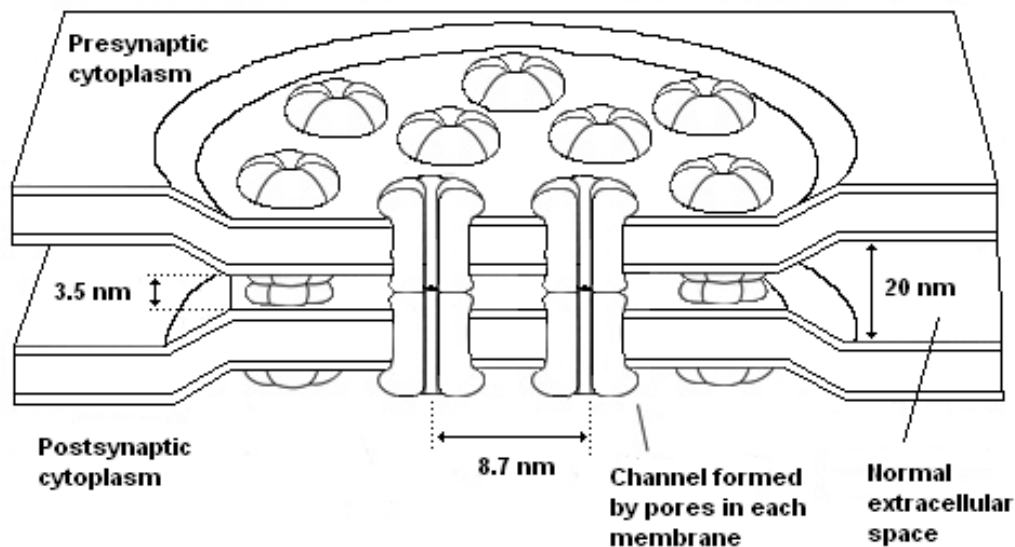

Fig.2 | A gap junction is a window between adjacent cells through which ions, current and cytoplasm can flow.

Gap junctions are generally considered to be more primitive connections than chemical synapses, essential for embryological development but fading into the background in mature brains. However brain gap junctions remain active throughout adult life, and are being appreciated as more and more prevalent (though still sparser than chemical synapses - a rough estimate is that gap junctions comprise 15% of all inter-neuron brain connections).

Stuart Hameroff (1999) supposes that gap junctions may be important for macroscopic spread of quantum states among neurons and glia [2]. Biological electron tunneling can occur up to a distance of 5 nm, so the 4 nm separation afforded by gap junctions may enable tunneling through the gaps, spreading the quantum state.

C.I. de Zeeuw et al. (1997) [10,11] have been discovered specific intracellular organelles in dendrites immediately adjacent to gap junctions. These are layers of membrane covering at least in some cases a mitochondrion, and are called "dendritic lamellar bodies - DLBs". The DLBs are tethered to small cytoskeletal proteins anchored to microtubules.

The basic idea of Stuart Hameroff is: "Perhaps mitochondria provide free electrons for tunneling, and DLBs form a sort of Josephson junction between cells, permitting spread of cytoplasmic quantum states throughout widespread brain regions?"

He also supposes that microtubule quantum coherent superposition in individual neuronal and glial cells are linked to those in other neurons and glia by gap junctions which also mediate synchronization e.g. 40 Hz, or quantum coherent photons traversing membranes - Jibu et al., 1995 [12,13]. This enables macroscopic quantum states in networks of gap junction connected cells (neurons and glia) throughout large brain volumes.

3. Gap junctions and electrical synapses

Gap junctions are regions of apposition of the surface membranes of cells. They occur in most embryonic tissues and in some adult tissues. Small molecules can pass freely from the cytoplasm of one cell to that of another across a gap junction. Thus gradients of concentration of developmentally significant compounds can exist across a mass of cells and may be important for growth and differentiation. Gap junctions between adjacent smooth muscle cells are important for synchronous contraction in many organs. Gap junctions also occur between certain neurons; they are called electrical synapses, and they permit coupled signaling activity of the cells.

The American scientist Charles Sherrington first used the term 'synapse' to indicate the junction between neurons at the beginning of the 20th century, but at that time there was no clear conception of their functional mechanism. Two schools of thought developed, with the majority of neurobiologists favoring an electrical transmission across synapses. The early evidence, however, favored a chemical transmission method, and new neurotransmitters were identified at a rapid rate in the latter half of that century.

Ultimately, it was found that both camps were correct...that there were two types of synapses...although most are chemical. Electrical synapses consist of clusters of gap junctions where the two plasma membranes approach very closely. Each of the membranes at this point is spanned by a multimolecular protein structure called a connexon, composed of six protein subunits, the connexins. These connexins cluster to create a passageway

between them. The electrical synapse is formed of connexons in line across the two plasma membranes with the two passageways aligned to yield an intercytoplasmic pore.

Such gap junctions are considerably larger than usual membrane pores, and this size permits the instantaneous transmission of electrical currents from one cell to the other. Thus, chemical synaptic delay is ~ 1 millisecond and may extend over several milliseconds; electrical synapses have essentially no delay. Most electrical synapses are bidirectional in their transmission, but there are mechanisms to regulate both the event of this transmission and the direction. The connexins of a connexon can slide or torque together to close the passageway. This will stop transmission as long as the pore is closed. In many instances, electrical connections occur between very large neurons and very small ones. Electrical resistance of a large cell is negligible, but if the postsynaptic neuron is small, it will have a very high resistance. Thus, transmission from large to small neurons is easy, but the high resistance of the small cell does not produce enough current by its impulse to reach gate threshold in the larger nerve cell, and effective conduction is unidirectional.

4. The gap junction structure

Gap junctions are tubes with ~2 nm holes that connect cells, spanning the intercellular space. Most metabolites (e.g., sugars, amino acids, ions, etc.) of less than 1000 grams/mole can move through the gap junctions. Gap junctions are important to for cellular communication in two ways: rapid flow of ions between cells allows synchronous response of tissues (e.g., heart muscle) to stimuli and nutrients may be provided to cells distant from the circulatory system (e.g., lens tissue). Gap junctions differ from channels in that... they cross two membranes, connect cytosol to cytosol, not cytosol to outside, remain open seconds to minutes, not milliseconds and close in response to calcium ion or pH changes. Calcium ion causes a rotation and sliding of the connexin molecules. The rotation/sliding brings the connexin into a nearly parallel position that closes the pore of the gate. The gap junction channel is composed of 12 molecules of connexin (a 32 kD transmembrane protein). Six connexin molecules stack around each other (like pencils held together by an invisible rubber band) to form a half-channel. The second six connexin form a second half-channel, and the two half-channels stack one on top of the other (like a layer cake) to complete the gap junction. Inside the channel, two putatively charged rings (close to extracellular side of each membrane) affect ion flux and selectivity. The distance between these charged rings of residues of the two connexons is estimated to be about 4 nm. Each subunit is predicted to have four transmembrane spanning helices (M1 through M4), with M3 being an amphipathic alpha helix.

Charged amino acid residues in the amino terminus of connexins form part, if not all, of the transjunctional voltage sensor of gap junction channels and play a fundamental role in ion permeation. Results from studies of the voltage dependence of N-terminal mutants predict that residues 1-10 of Group I connexins lie within the channel pore and that the N-terminus forms the channel vestibule by the creation of a turn initiated by the conserved G12 residue (Purnick et al., 2000) [14]. The C-terminal end of each connexin is located at the cytoplasmic side and together with a central cytoplasmic loop between M2 and M3 contributes 17 positive and 8 negative charges to the subunit surface.

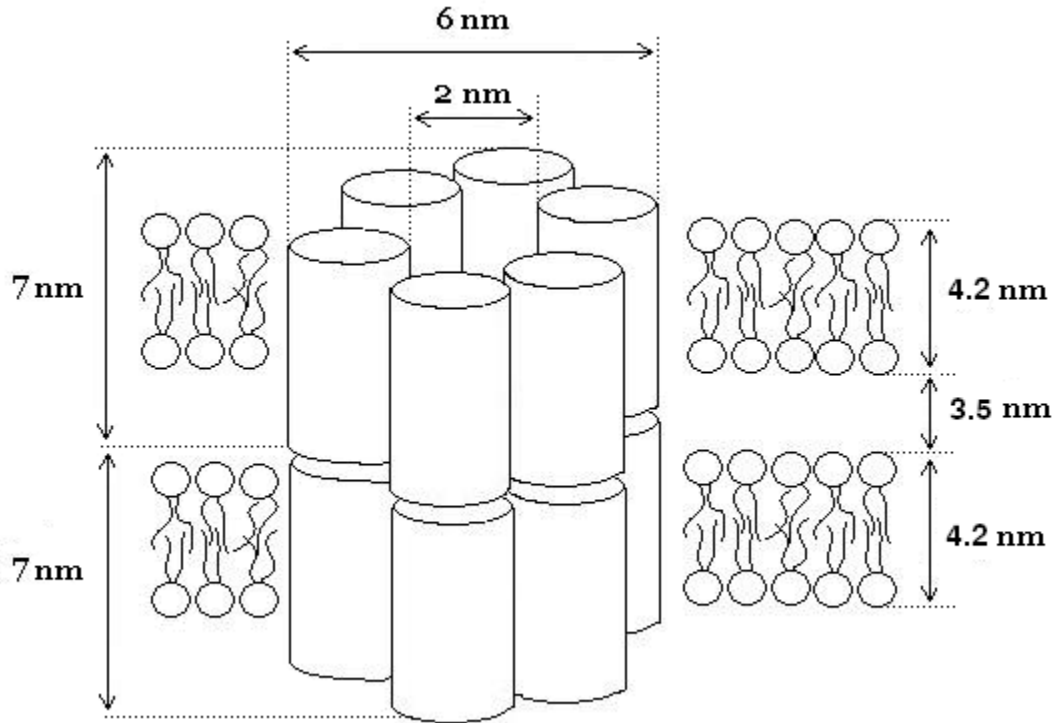

Fig.3 | Structure of a gap junction. Phospholipids indicate the membrane spanning domain (4,2 nm) for each connexon (7 nm) bridging an extracellular gap between the two coupled membranes of about 3,5 nm.

5. Gap junctions and 200 Hz neuronal activity

Brain waves, or the "EEG", are electrical signals that can be recorded from the brain, either directly or through the scalp. The kind of brain wave recorded depends on the behavior of the animal, and is the visible evidence of the kind of neuronal processing necessary for that behavior. Gyorgy Buzsaki showed that fast ripples at up to 200 Hz occur, superimposed on "sharp waves" in the hippocampus in rats in vivo. John Jefferys et al., 1998 [15] have found that 100-200 Hz oscillations also occur in the hippocampal slice in vitro.

According to John Jefferys (2002) the gap junctions in the brain have several roles. One is to exchange chemicals between cells, which is the basis of the calcium waves that can be seen spreading through populations of glia under some circumstances. The other main role is as an electrical synapse (widely used in invertebrates, and in some parts of the mammalian brain). There is also a good evidence for gap junctions between cortical interneurons where they seem to help synchronize firing (Tamas et al., 2000).

Jefferys et al., 1998 [15] studied the high frequency oscillations recorded from CA1 pyramidal layer in a hippocampal slice. Bathing the slice in zero calcium solution blocked the dentate evoked response, confirming that this treatment blocked synaptic transmission, but HF oscillations occurred more frequently than before, presumably due to the increased excitability causes by loss of charge screening of the membrane by calcium ions. The HF ripples also survived blockade of synaptic transmission by glutamate and GABA antagonists.

Several blockers of gap junctions, halothane, carbenoxolone, and octanol, amongst others all blocked the HF oscillations. Intracellular alkalinization, which opens gap junctions, enhanced HF oscillations. While all these agents have effects in addition to those on gap junctions, the only action they have in common is that on gap junctions, so their consistent effects on HF oscillations can be attributed to gap junctions. The data illustrated are from slices in the absence other drugs; similar results were found when synaptic transmission was blocked. Ammonium chloride causes a transient intracellular alkalinization, which opens gap junctions in other systems, and which here increases the incidence of HF ripples markedly.

The CA pyramidal cell fires in tight synchrony with the field potential ripple, but it does not fire on every cycle of the oscillations and occasionally fires independently of the oscillations, all of which suggests that the ripples are indeed produced by the interaction of groups of neurons. Given that no interneurons recorded were synchronized with the HF oscillations Jefferys et al., 2001 conclude that they are an emergent property of the pyramidal cells.

Coupling through the axons [16] is required to produce partial spikes as those seen in the experimental records. The physical idea is that the axons have a low threshold and high input resistance so that a relatively small number of gap junctions (hence high coupling resistance) can initiate a action potential in the postjunctional membranem and it is this action potential that is recorded at the soma rather than the "coupling potential" directly produced by the gap junction. Coupling at the dendrites or even the soma leads to unrealistic, slow potentials.

According to Jefferys (2002) gap junctions might help with the faster aspects of neuronal synchronization in epileptic seizures but for now there is no good estimate of how common are the gap junctions in the brain, and as a consequence it is hard to pin down an exact role for them.

6. Time to decoherence for gap junction interfering with a single ion

Max Tegmark (1999) [9] determines the time to decoherence (τ_{dec}) due to the long-range electromagnetic influence of an environmental ion to be:

$$(1) \quad \tau_{dec} \sim \frac{4\pi\epsilon_0 a^3 \sqrt{mkT}}{Nq_e^2 s},$$

where T is the temperature (310K), k is the Boltzmann constant ($1,3805 \cdot 10^{-23}$ J/K), m is the mass of the ionic species, a is the distance to the ion from the position of the quantum state, N is the number of elementary charges comprising that state, the elementary charge $q_e = 1,6 \cdot 10^{-19}$ C and s is the maximal 'separation' between the positions of the protein mass in the alternative geometries of the quantum superposition. Since any difference in the mass distributions of superposed matter states will impact upon the underlying spacetime geometry, such alternative geometries must presumably be permitted to occur within the superposition (Hameroff, Hagan, Tuszynski, 2000) [17].

In the case of a gap junction and a single sodium ion flowing through it, we have: mass of the sodium ion $m=3,88 \cdot 10^{-26}$ kg, $a=10^{-9}$ m, $\epsilon_0 \approx 80$, $s \sim 10^{-12}$ m.

The C-terminal end of each connexin is located at the cytoplasmic side and together with a central cytoplasmic loop between M2 and M3 contributes 17 positive and 8 negative charges to the subunit surface. If some of the positive and negative charges cancel out for N of one connexon we have 54 positive elementary charges.

The gap junctions between neural cells and glia are supposed to be in a form of clusters [18] and we'll consider that only the open gap junctions mediate interneuronal quantum coherence. The time for which the gap junction is open has already been shown to be seconds to minutes, so a massive ion through them is expected. If we suppose that some of the gap junctions are closed we can take the mean value of open gap junctions for a single neuron ~ 100 (approximately 10% of the chemical synapses formed by one neuron!). In the Orch OR model for a conscious event lasting 25 milliseconds are involved $\sim 2 \cdot 10^4$ neurons. Thus $\sim 2 \cdot 10^6$ gap junctions, each with 128 positive elementary charges, give us $N_1 \sim 2,56 \cdot 10^8$. Because the cytoskeleton is the primary residence of consciousness we must include the superposition states of the tubulin dimers. For $2 \cdot 10^{10}$ tubulins, each with 10 negative charges (Hameroff et al.) [17], we have $N_2 \sim 2 \cdot 10^{11}$. The microtubule network is intracellular and has negative charge under physiological pH while gap junctions are supposed to be positively charged and are devices located in the plasmalemma. Thus because the positive and negative charges are separated in the space we can sum N_1 and N_2 which gives us the rough number of elementary charges in superposition (N). Because $N_2 \gg N_1$ we'll take $N \sim 2 \cdot 10^{11}$.

Substituting all numerical values in equation (1) gives us $\tau_{dec} \sim 10^{-9} s$. The time to decoherence is 4 orders of magnitude longer than in the Tegmark's result, although the distance to the interfering ion is only 1 nm. This is because some of the values are corrected according to Hameroff et al., 2000 [17] – namely $\epsilon_0 \sim 80$, $s \sim 10^{-12} m$ and while calculating N is assumed that there are 10 negative charges per tubulin.

The alternative model in which gap junctions mediate interneuronal quantum coherence when are closed has no advantages. In order to be closed the intraneuronal level of calcium ions should be elevated. Calcium ions cause a rotation and sliding of the connexin molecules. The rotation/sliding brings the connexin into a nearly parallel position that closes the pore of the gate. However, calcium ions activate proteins, which liquefy the actin gel and destroy the microtubule shield, thus causing decoherence. The possibility that some gap junctions are closed while the most are open, supposing low calcium levels, requires additional hypothesis explaining why the open gap junctions do not destroy coherence – after all they are anchored to the cytoskeleton in the same way as the closed gap junctions.

Something about the temperature and the macroscopic quantum coherence should be said. Hameroff et al. [17] rejected Tegmark's equation because τ_{dec} is proportional to the square root of the temperature. Hameroff et al. complaint is that “it would appear that no quantum coherent states are likely to exist at any temperature - as the temperature approaches absolute zero, decoherence times should tend to zero as the square root of temperature. The apparent implication is that low temperatures, at which decohering environmental interactions should presumably have minimal impact, are deemed most inhospitable to the formation and preservation of quantum coherence, contrary to experience”.

However the above conclusion could be called 'unserious' because as Max Tegmark (2002) emphasizes the equation is only valid in the limited temperature range, where the water is liquid - and in that range, the scattering cross sections indeed drop as T rises and the molecules on average move faster. If you lower T sufficiently, the decoherence time of course gets much longer - when your brain freezes... Thus Hameroff et al. [17] don't take into account a very simple fact: the equation is valid only for liquid water and not for ice!

Obviously the problem of thermal decoherence is not an easy one! There are proposals for biological quantum states suggesting that biological heat can be used to pump coherent excitations (Fermi-Pasta-Ulam resonance, Davydov solitons). Thus the model complicates: the ordered water molecules outside the microtubules can funnel the thermal fluctuations from the environment but the thermal fluctuations of the tubulins can be used for quantum coherent excitations.

Stuart Hameroff (1999) [2] supposed that the channels and the ionotropic neuromediator receptors might take part in the macroscopic quantum coherent phenomena. Nevertheless this idea seems doubtful because no proper mechanism against decoherence from the ion flow can be adopted! The Tegmark's equation shows that the gap junctions and any of the ionotropic neuromediator receptors cannot be insulated from environmental decoherence for the needed 25 milliseconds, because of the massive ion flow through them and the short distance to the interfering ions ~ 1 nm.

7. Quantum computing and Josephson junctions

A quantum computer can perform certain tasks, which no classical computer is able to do in acceptable times [19,20,21]. It is composed of a large number of coupled two-state quantum systems forming qubits; the computation is the quantum-coherent time evolution of the state of the system described by unitary transformations, which are controlled by the program. According to Yuriy Makhlin et al., 1998 [22] the elementary steps are (i) the preparation of the initial state of the qubits, (ii) single-bit operations (gates), i.e. unitary transformation of individual qubit states, triggered by a modification of the corresponding one-qubit Hamiltonian for some period of time, (iii) two-bit gates, which require controlled inter-qubit couplings, and (iv) the measurement of the final quantum state of the system.

The phase coherence time has to be long enough to allow a large number of these coherent processes. Ideally, in the idle period between the operations the Hamiltonian of the system is zero to avoid further time evolution of the states.

Several physical realizations of quantum information systems have been suggested. Ions in a trap manipulated by laser irradiation are the best-studied system. However, alternatives need to be explored, in particular those which are more easily embedded in an electronic circuit as well as scaled up to large numbers of qubits. Most promising are systems built from Josephson junctions, where the coherence of the superconducting state can be exploited. Quantum extension of elements based on single-flux logic has been suggested, and attempts were made to observe coherent oscillations of flux quanta between degenerate states.

According to W. A. Al-Saidi et al., 2001 [23] circuits involving small Josephson junctions have the potential to behave as macroscopic two-level systems, which can be externally controlled. Indeed, several recent experiments have demonstrated that such a system can be placed in a coherent superposition of two macroscopic quantum states. The experiments

have involved small superconducting loops, and also so-called Cooper pair boxes. In the former case, it was shown experimentally that the loop could exist in a coherent superposition of two macroscopic states of different flux through the loop. In the case of the Cooper pair box, the system was placed into a superposition of two states having different numbers of Cooper pairs on one of the superconducting islands. One possible application of such two-state systems is as a quantum bit (qubit) for use in quantum computing. At sufficiently low temperatures, this Josephson qubit will have little dissipation, and hence may be coherent for a reasonable length of time, as is required of a qubit. But in order for it to be potentially useful in computation, it must be possible to prepare entangled states of two such qubits - that is, states of the two qubits, which cannot be expressed simply as product states of the two individual qubits.

At the present time the construction of quantum computers seems promising with the use of systems built from Josephson junctions, however the possible quantum coherence within and between neurons does not require such junctions at all.

A Josephson junction is a superconductor-insulator-superconductor (SIS) layer structure placed between two electrodes. Josephson predicted that if the metals on both sides of the junction are superconducting Cooper pairs also tunnel through such a junction. One of the characteristics of a Josephson junction is that as the temperature is lowered, superconducting current flows through it even in the absence of voltage between the electrodes, part of the Josephson effect.

According to Levy-Leblond and Balibar the superconductivity is nothing but a "superfluid" of pseudo-bosons in the form of Cooper pairs of electrons! This is the case of the conduction of electrons in certain metals, which, interacting via the vibrations of the crystalline lattice, form pairs of bound states - the 'Cooper pairs'. These electron pairs may be considered as being bosons and their 'superfluidity' - analogous to that of helium atoms - gives to the metal the property of 'superconductivity': below a certain critical temperature its resistance vanishes completely, just as does the viscosity of a superfluid! The superconductors have many unusual electromagnetic properties, which cannot be explained classically. Once a current is produced in a superconducting ring at sufficiently low temperature (T_c - critical temperature) the current persists with no measurable decay, because the resistance, which comes from electrons, scattered by lattice imperfections, totally disappears. The superconducting ring exhibits no electrical resistance to direct currents, no heating, no losses. It has been noted that certain superconductors expel applied magnetic fields so the field is always zero inside the superconductor.

According to Simon and Smith the Josephson effect in particular results from two superconductors acting to preserve their long-range order across an insulating barrier. With a thin enough barrier, the phase of the electron wavefunction in one superconductor maintains a fixed relationship with the phase of the wavefunction in another superconductor. This linking up of phase is called phase coherence. It occurs throughout a single superconductor, and it occurs between the superconductors in a Josephson junction. Phase coherence (long-range order) is the essence of the Josephson effect.

Stephen Godfrey (1997) lists some of the bizarre properties of the Josephson junctions: (i) a dc current can flow when no voltage is applied; (ii) if a small voltage of few millivolts is applied an alternating current of frequency in the microwave range results; (iii) due to phase coherence of the pairs under certain conditions (barrier $\sim 1\text{nm}$) the probability of pair tunneling is comparable to single particle tunneling.

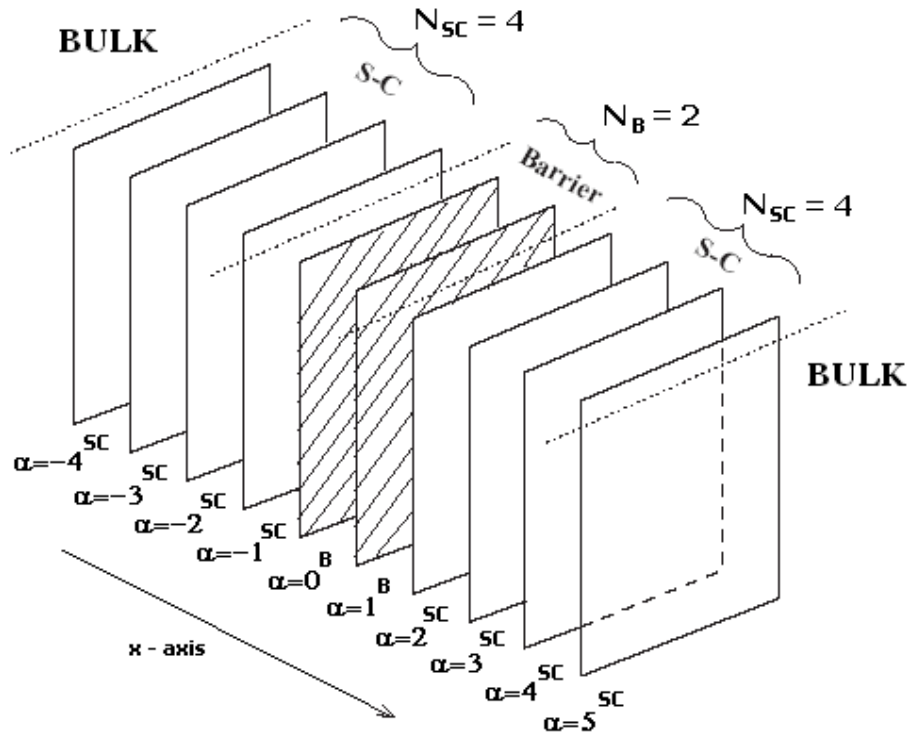

Fig.4 | Microscopic stacked planar geometry of a Josephson junction. The sandwich of $N=10$ planes: $N_{sc} = 4$ superconducting planes coupled to a bulk superconductor on the left and $N_B = 2$ barrier planes on the right, followed by a further $N_{sc} = 4$ superconducting planes coupled to another bulk superconductor on the right (J. K. Freericks et al., 2001) [24].

Although the Josephson junctions could be in principle useful in quantum computing they couldn't be present within or between neurons, because there is no superconductivity within the cells ($T \sim 310K$). The structural similarity between Josephson junctions and DLBs (lamellae from endoplasmatic reticulum) is not functional one, so we must be cautious when trying to explain the macroscopic quantum coherent states in the brain cortex!

8. The glial role in the conscious brain

Stuart Hameroff (1999) supposes that gap junctions may be important for macroscopic spread of quantum states among neurons and glia [1,2]. Brain development and function depends on glial cells, as they guide the migration of neuronal somata and axons, promote the survival and differentiation of neurons, and insulate and nourish neurons. It is not known, however, whether glial cells also promote the formation and function of synapses, although glial processes ensheath most synapses in the brain. The recent development of methods to purify and culture a specific type of neuron from the central nervous system (CNS) has allowed Pfrieder et al., 1997 [25] to investigate whether CNS neurons can form functional synapses in the absence of glial cells. The role of glial cells in synapse formation and function was studied in cultures of purified neurons from the rat central nervous system. In glia-free cultures, retinal ganglion cells formed synapses with normal ultrastructure but displayed little spontaneous synaptic activity and high failure rates in evoked synaptic transmission. Thus, developing neurons in culture form inefficient synapses that require glial signals to become fully functional.

Approximately 50% of the mammalian brain is composed of astrocytes. These cells, presented in every region of brain, are always closely associated with neuronal elements, and exhibit a wide variety of morphological phenotypes and neurotransmitter receptors. The astrocytes play a critical role in buffering extracellular potassium levels within the narrow range required for neuronal activity. Similarly, astrocytes are thought important in removing glutamate following its release at neuronal synapses. Modulation of either potassium buffering or glutamate uptake into astrocytes would markedly affect neuronal excitability.

According to Ken McCarthy (2001) [26] the astrocytes exhibit a very fine, branching network of velate processes that envelope neurons. The velate processes of astrocytes are frequently connected to other astrocytic processes via gap junctions to form an astrocytic syncytium through which intercellular signaling may propagate. It seems likely that discrete microdomains within the astrocytic syncytium may interact autonomously with neurons. The astroglia express a very wide variety of neuroligand receptors [27] (both ligand-gated ion channels and G-protein linked receptors), which are coupled to most of the known intracellular signaling cascades. Further, astroglia are heterogeneous with respect to their expression of different neuroligand receptors and individual astroglia often express multiple types of neuroligand receptors.

In vitro, these receptor systems appear to regulate a wide variety of cellular processes including 1) the uptake and release of neurotransmitters, 2) the synthesis and release of neurotrophic factors, 3) proliferation, 4) apoptosis, 5) intracellular volume, 6) the conductance of potassium channels, and 7) the opening and closing of the gap junctions [28] that normally connect astrocytes to form a syncytium.

Astrocytes exhibit a number of properties, which suggest that they modulate neuronal activity in vivo [29]. These properties include their ability to 1) buffer extracellular potassium, 2) rapidly take up neurotransmitters following release at neuronal synapses, 3) release neurotransmitters and neuromodulators (including glutamate, ATP and D-serine), 4) release neurotrophic factors, and 5) regulate the volume of the extracellular space. The complex morphology of astrocytes and their ability to form a syncytium connected by gap junctions suggests that their interactions with neurons may occur in discrete microdomains that function autonomously.

Ken McCarthy (2001) supposes that there are microdomains within astrocytic syncytium that interact with neuronal synapses to facilitate or to dampen neuronal excitability and/or neurotransmission. These microdomains may be derived from a single astrocyte or from multiple astrocytes and may function independently from one another or in unison depending on the level of neuronal activity. Further, the ability of signals to travel within the astrocytic syncytium is likely to be modulated by second messengers, which regulate the opening and closing of gap junctions. Ultimately, the complexity of signaling within the astrocytic syncytium is believed to be as complex as that occurring between neurons and will function to regulate neuronal excitability.

Thus the glia seems to be related mainly with regulating the neuronal excitability (classical computing) and has neurotrophic effects. Fox points out that the energy cost of a phone system is largely in setting up and maintaining lines of communication; communication itself (talking on the phone) is very cheap energetically. Following this analogy we can say that glia maintains the “phone lines” (neurons) working properly!

Hameroff assumes that glia is essential for conscious experience based mainly on his gap junction hypothesis and the wide distribution of glia in the brain. However, the calculations for the gap junction mediated interneuronal quantum coherence showed $\tau_{dec} \sim 10^{-9} s$, which is 6 orders of magnitude shorter than needed. So, if we suppose that the consciousness is quantum dissipationless process there is no obvious need for glial cytoskeletons to be involved in it.

There is enough clinical data that glia cannot compensate neuronal loss. In conditions of increased excitation like temporal epilepsy or ischemia the excess of glutamate release leads to massive calcium influx in the cortical neurons causing their death! The glia compensatory fills up the gap; nevertheless it does not restore the function. An implicit feature of all neurodegenerative diseases is the progressive developing dementia (state of severe impairment of consciousness).

9. Synaptogenesis in the mammalian CNS

Information in the brain is transmitted at synapses, which are highly sophisticated contact zones between a sending and a receiving nerve cell. They have a typical asymmetric structure where the sending, presynaptic part is specialized for the secretion of neurotransmitters and other signaling molecules while the receiving, postsynaptic part is composed of complex signal transduction machinery.

In the developing human embryo, cell recognition mechanisms with high resolution generate an ordered network of some 10^{15} synapses, linking about 10^{12} nerve cells. The extraordinary specificity of synaptic connections in the adult brain is generated in five consecutive steps. Initially, immature nerve cells migrate to their final location in the brain (1). There, they form processes, so called axons. Axons grow, often over quite long distances, into the target region that the corresponding nerve cell is supposed to hook up with (2). Once arrived in the target area, an axon selects its target cell from a large number of possible candidates (3). Next, a synapse is formed at the initial site of contact between axon and target cell. For this purpose, specialized proteins are recruited to the synaptic contact zone (4). Newly formed synapses are then stabilized and modulated, depending on their use (5). These processes result in finely tuned networks of nerve cells that mediate all brain functions, ranging from simple movements to complex cognitive or emotional behavior.

Nils Brose, Ji-Ying Song, Konstantin Ichtchenko and Thomas C. Südhof have studied the biochemical characteristics and cellular localization of neuroligin 1 - a member of a brain-specific family of cell adhesion proteins. They discovered that neuroligin 1 is specifically localized to synaptic junctions, making it the first known synaptic cell adhesion molecule. Using morphological methods with very high resolution Brose demonstrated that neuroligin 1 resides in postsynaptic membranes, its extracellular tail reaching into the cleft that separates postsynaptic nerve cells from the presynaptic axon terminal. Interestingly, the extracellular part of neuroligin 1 binds to another group of cell adhesion molecules, the β -neurexins. Both, neuroligins and β -neurexins are the cores of well-characterized intracellular protein-protein-interaction cascades. These link neuroligins to components of the postsynaptic signal transduction machinery and β -neurexins to the presynaptic transmitter secretion apparatus.

Based on their findings, Brose and colleagues suggest a novel molecular model of synapse formation in the brain. Central to this model is the transsynaptic connection between neuroligins and β -neurexins. This β -neurexin-neuroligin junction is formed at the initial site of contact between a presynaptic axon terminal and its target cell. Once this junction is formed, a complex cascade of intracellular protein-protein-interactions leads to the recruitment of the necessary pre- and postsynaptic protein components. A functional synapse is formed. But the model does not only provide a molecular mechanism for synaptogenesis, it provides an interesting and simple mechanism for retrograde signaling during learning-dependent changes in synaptic connectivity. Indeed, the β -neurexin-neuroligin junction allows for direct signaling between the postsynaptic nerve cell and the presynaptic transmitter secretion machinery. Neurophysiologists and cognitive neurobiologists have postulated such retrograde signaling as a functional prerequisite for learning processes in the brain.

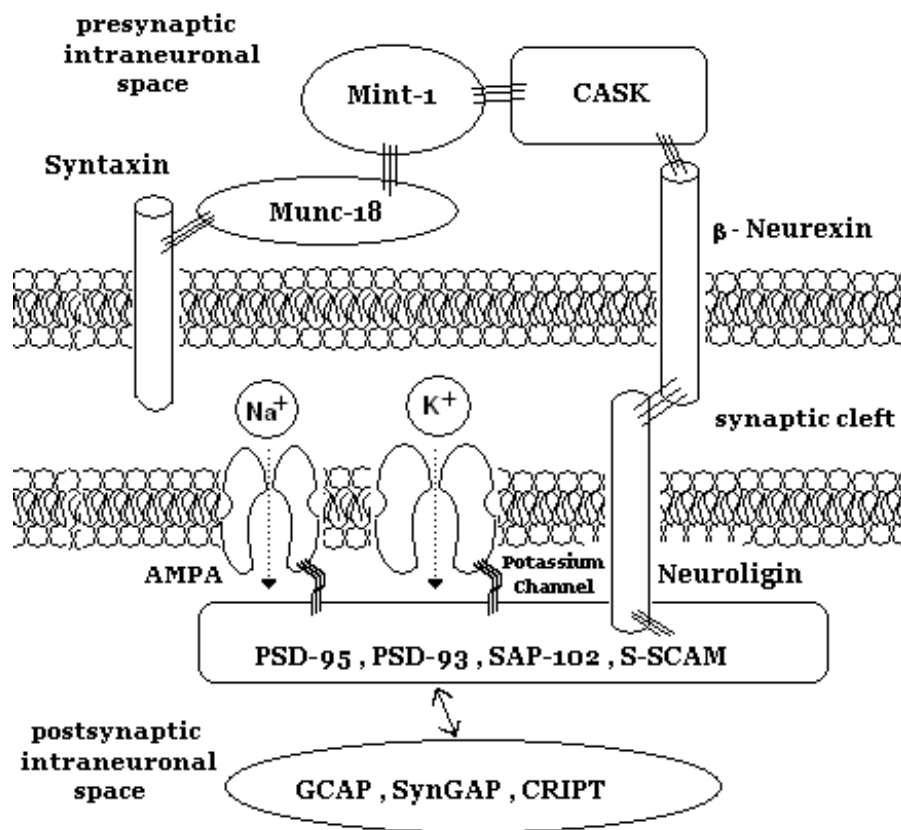

Fig.5 | The neuroligin/ β -neurexin-junction is the core of a newly forming synapse. CASK and Mint 1 are presynaptic PDZ-domain proteins with a scaffold function; Munc18 and syntaxin are essential components of the presynaptic transmitter release machinery; PSD95, PSD93, SAP102, and S-SCAM are postsynaptic PDZ-domain proteins with a scaffold and assembly function that recruit ion channels (e.g. K^+ -channels), neurotransmitter receptors (e.g. NMDA receptors) and other signal transduction proteins (GKAP, SynGAP, CRIPT).

Postsynaptic neuroligin interacts with presynaptic β -neurexin to form a transsynaptic cell-adhesion complex at a developing synapse. Once the junction is formed, neuroligins and β -neurexins initiate well-characterized intracellular protein-protein-interaction cascades. These lead to the recruitment of proteins of the transmitter release machinery on the

presynaptic side and of signal transduction proteins on the postsynaptic side. The resulting transsynaptic link could also function in retrograde and anterograde signaling of mature synapses.

10. The β -neurexin–neuroligin entanglement

Ultrastructural studies of excitatory synapses have revealed an electron-dense thickening in the postsynaptic membrane - the postsynaptic density (PSD). The PSD has been proposed to be a protein lattice that localizes and organizes the various receptors, ion channels, kinases, phosphatases and signaling molecules at the synapse (Fanning & Anderson, 1999 [30]). Studies from many laboratories over the past ten years have identified various novel proteins that make up the PSD. Many of these proteins contain PDZ domains, short sequences named after the proteins in which these sequence motifs were originally identified (PSD-95, Discs-large, Zona occludens-1). PDZ domains are protein–protein interaction motifs that bind to short amino-acid sequences at the carboxyl termini of membrane proteins. These PDZ domain-containing proteins have been shown to bind many types of synaptic proteins, including all three classes of ionotropic glutamate receptors, and seem to link these proteins together to organize and regulate the complex lattice of proteins at the excitatory synapse.

CASK (presynaptic) and PSD-95 (postsynaptic) stabilize synaptic structure by mediating interactions with cell adhesion molecules neurexin (presynaptic) and neuroligin (presynaptic) or by indirectly linking synaptic proteins to the cytoskeleton through the actin binding protein 4.1 or the microtubule-binding protein CRIP1. Another factor that might contribute to the organization of synapses is the ability of proteins like PSD-95 and CASK to bind transmembrane proteins that mediate cell-cell or cell-matrix adhesion. For example, the third PDZ domain in PSD-95 (and PSD-93 and PSD-102) has been demonstrated to bind to the carboxy-terminal tail of neuroligins [31] and CASK binds to the cell surface protein neurexin [32].

Direct binding of neurexins to neuroligins has been demonstrated to promote cell–cell interactions, leading to the suggestion that adhesive interactions mediated by PDZ proteins might promote assembly or stabilization of synaptic structure [33]. The CASK PDZ domain has also been shown to bind to syndecans, which are cell surface proteoglycans implicated in extracellular matrix attachment and growth factor signaling [34,35].

The organization of membrane domains might also be mediated by the ability of many of these multidomain proteins to promote direct or indirect linkage to cytoskeleton. CASK is tethered to the cortical cytoskeleton by the actin/spectrin-binding protein 4.1 [34,36]. Interestingly, this interaction is mediated by a conserved module in protein 4.1 known as a FERM domain, which is known to link other proteins to the plasma membrane [37].

The third PDZ domain of PSD-95 has been demonstrated to bind to the protein CRIP1, which can recruit PSD-95 to cellular microtubules in a heterologous cell assay [38]. Linkage of these scaffolding proteins to the cytoskeleton might help to stabilize their associated transmembrane proteins within discrete plasma membrane domains.

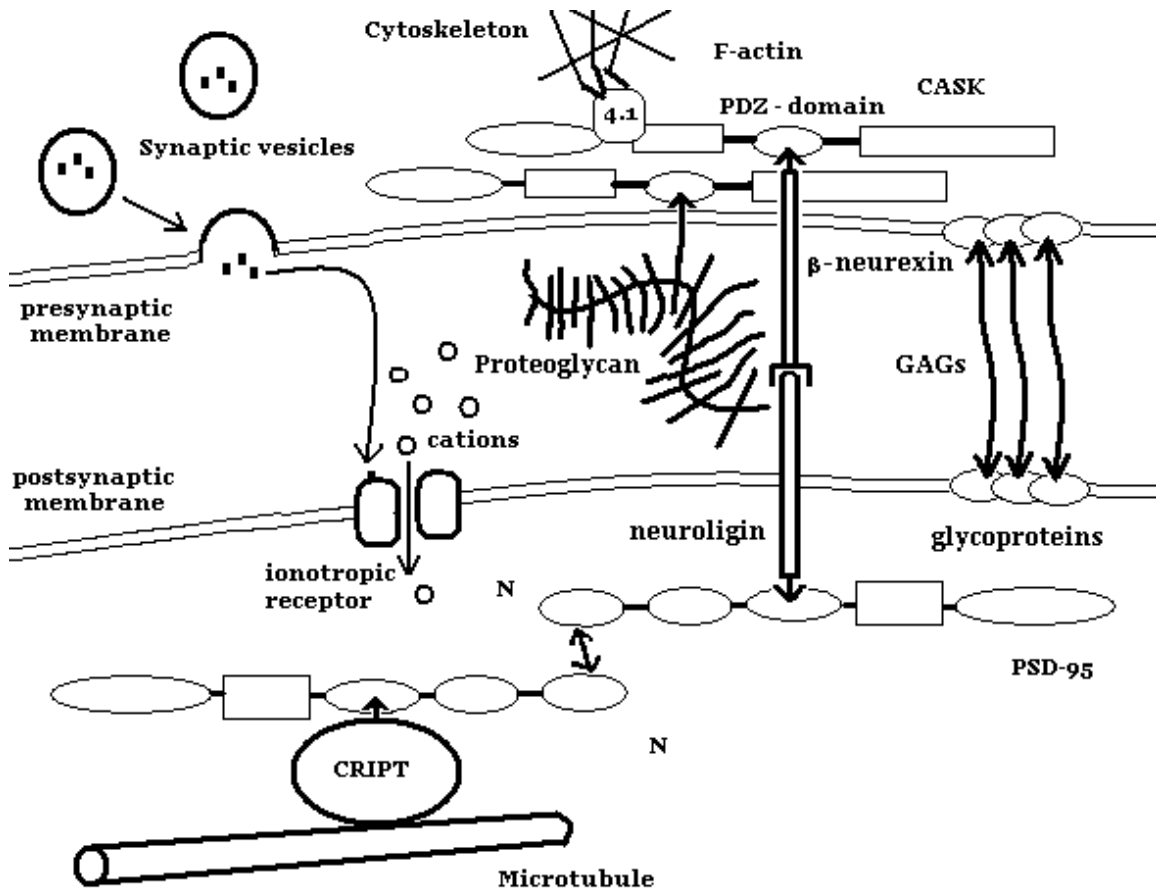

Fig.6 | The β -neurexin-neuroligin adhesion can influence the cytoskeletons of the two neurons. The quantum coherence between neurons is mediated by β -neurexin-neuroligin adhesion which can be shielded by glycosaminoglycans (GAGs) from decoherence.

We have considered the molecular organization of the synapse to reveal the molecular connection between the two neuronal cytoskeletons. The intraneuronal proteins (as well as the microtubules) can be periodically shielded by the actin meshwork according to the gel-sol transition mechanism proposed by Stuart Hameroff and Roger Penrose.

But what about the extracellular β -neurexin-neuroligin link? If we believe in the power of Nature and suppose that it can shield the macroscopic quantum coherent states of the microtubules by actin meshwork why it cannot shield an extracellular link? Such possible mechanism is shielding by glycosaminoglycans (GAGs), which interconnect the two neural membranes. Here should be noted that the extracellular matrix is not less strictly ordered in comparison with the intracellular space. Instead if you have an EM micrograph showing just the plasmalemma and some space in and out of the cell your chance to guess which side is intracellular is only 50%!

In contrast with Hameroff who seeks the shortest distance between two neural cells the β -neurexin-neuroligin model links the two cytoskeletons through protein lattice (CASK, PSD-95, CRIPT etc.) maybe in the longest possible way (~100 nm). However, Nature takes not the way, which seems easy but the way, which is possible!

11. Quantum teleportation between cortical neurons

In the QED-Cavity model of microtubules Mavromatos, Nanopoulos and Mershin (2002) [7] analytically show that intraneuronal dissipationless energy transfer and quantum teleportation of coherent quantum states are in principle possible. In the neuron this is achieved between microtubules entangled through MAPs.

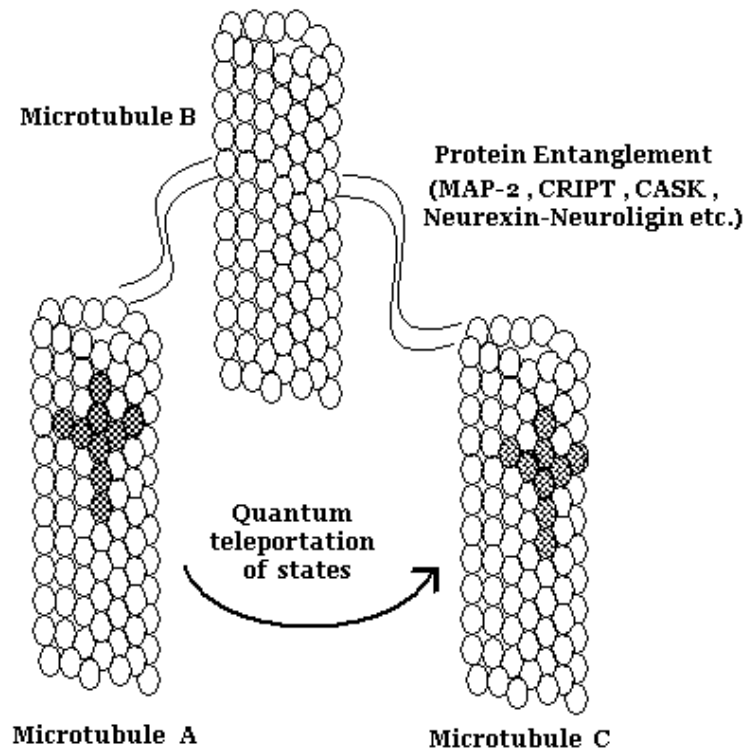

Fig.7 | Quantum teleportation of tubulin states between entangled microtubules. Microtubule A sends its state (represented by a cross) to Microtubule C without any transfer of mass or energy. Both Microtubule A and Microtubule C are entangled with Microtubule B (entanglement represented by presence of connecting proteins).

The β -neurexin-neurologin entanglement could allow such teleportation to occur between cortical neurons! The entanglement can be used for quantum transfer of tubulin states between neurons. The state of the recipient microtubule then could affect specific intraneuronal processes.

12. The glycosaminoglycan shield

Linda Hsieh-Wilson (2001) [39] has provided experimental data confirming the special role of fucose in the brain. Fucose is a simple sugar that is attached to proteins at the synapse and is frequently associated with other sugar molecules. There is some evidence that fucose is important for modulating the transmission of signals between two or more nerve cells. For example, fucose is highly concentrated at the synapse, and repeated nerve-cell firing increases the levels still further. Thus fucose may be involved in learning and memory because disrupting a critical fucose-containing linkage causes amnesia in lab rats.

Fucose is often linked to another sugar called galactose. The linkage is created when hydroxyl groups on the two sugars combine and expel a water molecule. Rats given 2-deoxygalactose (which is identical to galactose in all respects except that it lacks the critical hydroxyl group) cannot form this linkage, and develop amnesia because they cannot form the essential fucose-galactose linkage. In another study, rats treated with 2-deoxygalactose were unable to maintain long-term potentiation (LTP), which is a widely used model for learning and memory. Taken together, these experiments strongly suggest that fucose-containing molecules at the synapse may play an important role in learning and memory.

Linda Hsieh-Wilson et al. (2001) have developed a model that may explain fucose's role at the synapse. The fucose attached to a protein on the presynaptic membrane can bind to another protein located at the postsynaptic membrane. This stimulates the postsynaptic neuron to make more of the fucose-binding protein, enhancing the cell's sensitivity to fucose and strengthening the connection.

Glycosaminoglycans (GAGs) like fucose are found at the synapse, are important for proper brain development, and play a critical role in learning and memory [39]. It is believed that, like fucose, glycosaminoglycans are also involved in establishing connections between nerve cells. However, the molecular mechanisms of this process remain poorly understood.

Whereas fucose is a relatively simple sugar, glycosaminoglycans are complex polymers, having a repeating A-B-A-B-A structure composed of alternating sugar units. There are several different kinds of glycosaminoglycans found in nature, and each is characterized by different sugar units. For example, chondroitin sulfate is composed of alternating D-glucuronic acid and N-acetylgalactosamine units.

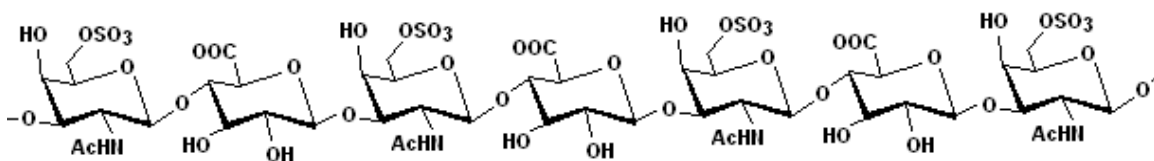

Fig.8 | A glycosaminoglycan is a polymer of simple sugars that alternate with each other. Shown here is chondroitin sulfate, which consists of alternating D-glucuronic acid and N-acetylgalactosamine. The polymer can be up to 200 sugars long.

Another glycosaminoglycan, heparan sulfate, is composed of alternating L-iduronic acid or D-glucuronic acid and N-acetyl-glucosamine units. Both chondroitin sulfate and heparan sulfate are found in the brain, but they play very different roles. So, at the first level, we see that nature can encode different biological functions by using different sugar sequences. However, nature has taken the chemical diversity of glycosaminoglycans one step further. Even a single sugar molecule can take many different forms. If, for example, we look at a typical simple sugar, we see that there are five different hydroxyl (OH) groups arrayed around a six-membered ring. If we attach a second chemical group to one of these five hydroxyl groups, the resulting molecule is different than if we attach that same chemical group to one of the other hydroxyl groups. These two molecules have the same number of atoms, the same electrical charge, and the same molecular weight. But, importantly, they are chemically distinct. They have different three-dimensional shapes, so they interact with the outside world in completely different ways.

In the brain D-glucuronic acid may be chemically modified with sulfate (OSO_3) groups at either or both of the 2- and 3- positions. Thus, sulfating D-glucuronic acid generates four different chemical structures: one molecule with no sulfate groups, two molecules, each with a single sulfate group at either the 2- or 3- position, and one molecule with sulfate groups at both the 2- and 3-positions. Similarly, sulfation of N-acetyl-galactosamine also generates four different structures. The result is that every sugar unit along the polymer chain can have any one of four different chemical structures. So if you consider a simple, four-unit molecule of chondroitin sulfate, you have four possibilities in the first position times four more in each of the second, third, and fourth positions, for a total of 256 different compounds.

Nature has done something remarkably clever here. It's taken a relatively simple polymer and built up diversity by adding sulfate groups along the chain. This strategy has tremendous implications in the body because naturally occurring glycosaminoglycans can be up to 200 sugar units long. Taking into account all the possible ways to sulfate 200 sugars, we end up with a number of possible compounds that is greater than Avogadro's number ($6,022 \times 10^{23}$). However, some scientists believe that using chemistry it is possible to unlock this sulfation code.

Considering the β -neurexin-neuroigin quantum model of consciousness here is proposed another speculative role for GAGs and the specific way of glycosaminoglycan sulfation. Because the extracellular link mediating the entanglement between two neurons must be protected against decoherence by interfering ions in the synaptic cleft there should be specific mechanism for shielding it. Every sugar monomer in the glycosaminoglycan molecule is supposed to be slight axially rotated in respect with the previous one. The sulfate groups itself could project in different directions thus contributing a bulk of negative charges in the vicinity ordering water molecules and positive ion. If the GAGs connecting the two neuronal membranes have proper space localization they can permanently insulate the β -neurexin-neuroigin adhesion. It is also possible that glycoproteins interconnected through fucose-galactose link and neural proteoglycans within the synaptic cleft could also contribute for insulating the β -neurexin-neuroigin link.

The consciousness is known to be product of the cerebral cortex activity. We can realize something only if it comes to certain areas of the brain cortex. In the β -neurexin-neuroigin quantum model of consciousness the interneuronal entanglement is supposed to occur only between cortical neurons. However arises the question why quantum coherence cannot be achieved between subcortical or spinal neurons considering that β -neurexin-neuroigin link is widely presented in the CNS? I suppose that the answer should come from studying the unique molecular synapse structure between the cortical neurons.

13. The hands of the Consciousness

Following our own experience we can say that our consciousness has the power to act or not act in specific manner depending on our will. If microtubules just do quantum computing how this could affect the immediate (~milliseconds) neuromediator release. Hameroff supposed that microtubules control the motor proteins – kinesin and dynein and thus control the synaptic plasticity. But this is very slow process (~hours). How could this explain for example my will to take a sheet of paper?

Somehow surprisingly the model including the β -neurexin-neuroigin entanglement not also answers how interneuronal quantum coherence can be achieved, but also gives answer how the synaptic vesicle release is acted upon. The neurexins are essential ligands for synaptotagmin – a protein docking the synaptic vesicle to the presynaptic membrane! The conformational states of neurexin can directly influence the exocytosis.

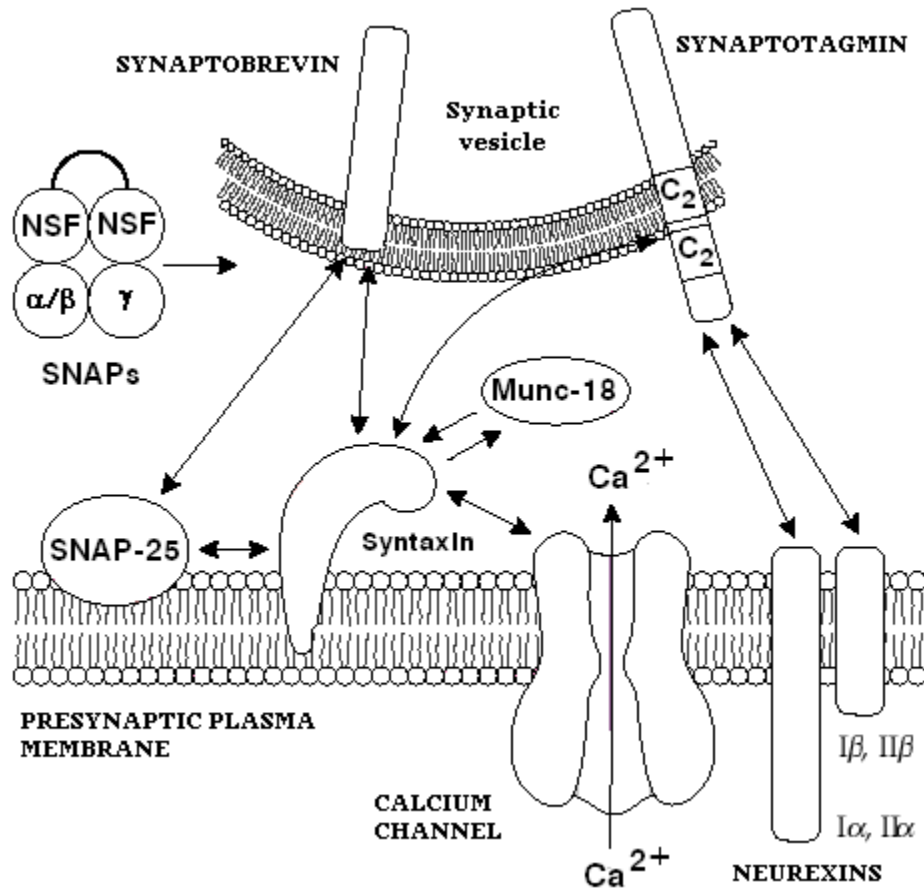

Fig.9 | Mechanism of exocytosis. The neurexins are major proteins involved in docking the synaptic vesicle to the plasmalemma and facilitating the mediator release. Some other proteins like Munc-18, SNAPs and Syntaxin are also taking part in the process.

If our conscious mind is in the “quantum coherent cytoskeleton” then it should have some power to influence the synaptic activity using its free will in a uniform way. This is so because everyone can immediately move his arm, leg etc. or say something. However because nobody can commit to memory at once a poem this means that the conscious thought acts much slower on synaptic plasticity.

Such kind of arguments can show us which brain activities are immediately connected with our conscious experience (motion) and which brain activities are only influenced by our “internal thoughts” (memory, motor proteins etc.). Of course, we are not “consciously aware” how exactly both types of activities are acted upon by the cytoskeleton (or other proteins in the macroscopic quantum coherent state). Thus ‘unconsciously’ our consciousness influences some of the intracellular processes and has diverse effects in the cortical neurons.

The basic of our understanding the consciousness is that it is “fundamental feature” of reality and is something dynamic, maybe complex quantum wave born into existence by a conglomerate of entangled proteins – tubulins, MAP-2, neurexin, neuroligin, CASK, CRIPT, PSD-95, protein 4.1 etc. All of these proteins has its specific function and constitutes a part from the protein body of the “consciousness”, which can be called “superposition of entangled spins (protein states)”. In this new model the tubulins are “computing”, the MAP-2 is “orchestrating and inputting information”, CASK, CRIPT, protein 4.1, neuroligin 1 are “linking together” and neurexin is “acting upon the exocytosis”. Thus a fully functional body is built up!

All the other intraneuronal processes (synaptic plasticity, memory) are also influenced by the “protein body of the consciousness” – the motor proteins are moving over the microtubules, the β -neurexin-neuroligin link is the core of a new formed synapse, the neuromediator receptors are anchored to the cytoskeleton, the synapsins are docking the synaptic vesicles to the cytoskeleton etc. All this molecules (kinesin, dynein, neuromediator receptors), different types of vesicles, actin filaments, enzymes etc. are not in coherence with our “conscious quantum state”, so our consciousness is influencing them not so easy, not so fast, and not by will.

14. Quantum tunneling and neuromediator release

The model proposed by Frederick Beck and Sir John Eccles introduces a quantum element into the functioning of the brain through the mechanism of "exocytosis", the process by which neurotransmitter molecules contained in synaptic vesicles are expelled into the synaptic cleft from the presynaptic terminal. The arrival of a nerve impulse at an axon terminus does not invariably induce the waiting vesicles to spill their neurotransmitter content into the synapse, as was once thought. Beck argues below that empirical work suggests a quantum explanation for the observed probabilistic release, and offers supporting evidence for a trigger model of synaptic action. The proposed model is realized in terms of electron transfer processes mediating conformational change in the presynaptic membrane via tunneling [40].

Beck (1999) cites the "non-causal logic of quantum mechanics, characterized by the famous von Neumann state reduction" as the reason a quantum mechanism might be relevant to the explanation of consciousness and suggests that probabilistic release at the synaptic cleft may be the point at which quantum logic enters into the determination of brain function in an explanatorily non-trivial manner. He postulates that global activation patterns resulting from non-linear feedback within the neural net might enhance weak signals through stochastic resonance, a process by which inherently weak signals can be discerned even when their amplitudes lie below the level of the ambient background noise. This might allow sufficient leverage to amplify the role of the quantum processes governing synaptic transmission to a level that could be causally efficacious in determining consciousness.

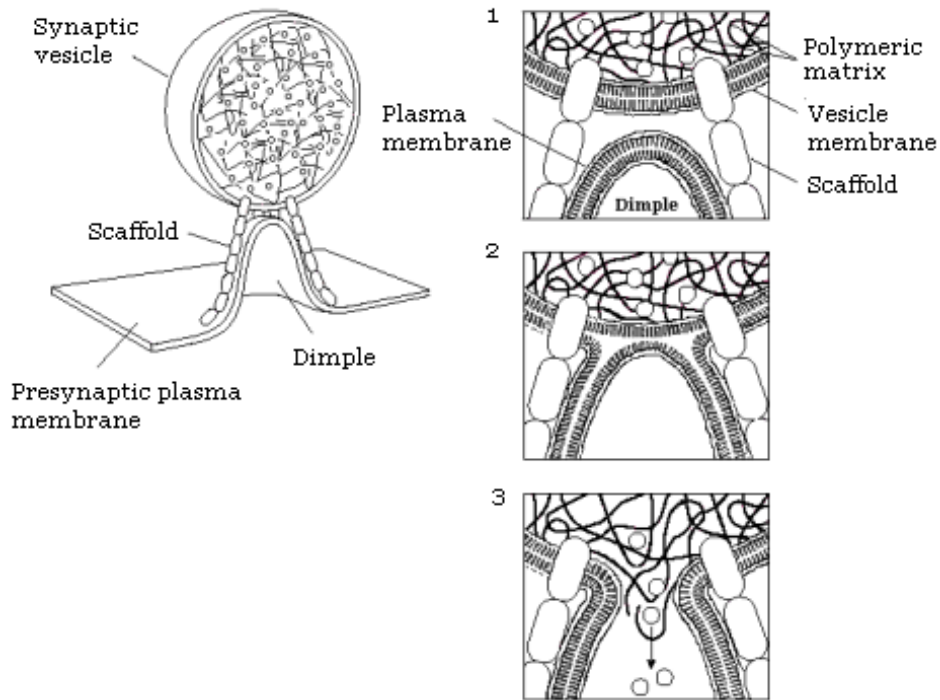

Fig.10 | Diagram of the process of exocytosis by which neurotransmitters in synaptic vesicles at the presynaptic terminal are probabilistically released into the synaptic cleft upon the arrival of an action potential.

According to Beck the synaptic exocytosis of neurotransmitters is the key regulator in the neuronal network of the neocortex. This is achieved by filtering incoming nerve impulses according to the excitatory or inhibitory status of the synapses. Findings by Jack et al. (1981) inevitably imply an activation barrier, which hinders vesicular docking, opening, and releasing of transmitter molecules at the presynaptic membrane upon excitation by an incoming nerve impulse. In 1990 Redman and co-workers have been demonstrated in single hippocampal pyramidal cells that the process of exocytosis occurs only with probability generally much smaller than one upon each incoming impulse.

There are principally two ways by which the barrier can be surpassed after excitation of the presynaptic neuron: the classical over-the-barrier thermal activation and quantum through-the-barrier tunneling. The characteristic difference between the two mechanisms is the strong temperature dependence of the former, while the latter is independent of temperature, and only depends on the energies and barrier characteristics involved!

Thermal activation. This leads, according to Arrhenius' law, to a transfer rate, k , of

$$(2) \quad k \sim V_c \cdot \exp\left(-\frac{E_A}{k_b T}\right),$$

where V_c stands for the coupling across the barrier, and E_A denotes the activation barrier.

Quantum tunneling. In this case the transfer rate, k , is determined in a semiclassical approximation (Gamow theory) by

$$(3) \quad k \approx \omega_0 \exp\left\{-2 \int_a^b \frac{\sqrt{2M[V(q) - E_0]}}{\eta} dq\right\}$$

with $V(q)$ - the potential barrier; E_0 - the energy of the quasi-bound tunneling state; and

$$(4) \quad \omega_0 = \frac{E_0}{\eta}$$

The quantum trigger model for exocytosis developed by Eccles and Beck (1992) is based on the second possibility. The reason for this choice lies in the fact that thermal activation is a broadly uncontrolled process, depending mainly on the temperature of the surroundings, while quantum tunneling can be fine-tuned in a rather stable manner by adjusting the energy E_0 of the quasi-bound state or, equivalently, by regulating the barrier height (the role of the action potential).

A careful study of the energies involved, however, showed that quantum tunneling remains safe from thermal interference only if the tunneling process is of the type of a molecular transition, and not a quantum motion in the macromolecular exocytosis mechanism as a whole.

In further work Beck (1996, 1998) attributed the molecular tunneling to the electron transfer mechanism in biomolecules. In biological reaction centers such processes lead to charge transfer across biological membranes quite analogous to $p - n$ transitions in semiconductors. The mechanism is based on the Franck-Condon principle and was worked out by Marcus (Marcus, 1956; Marcus and Sutin, 1985).

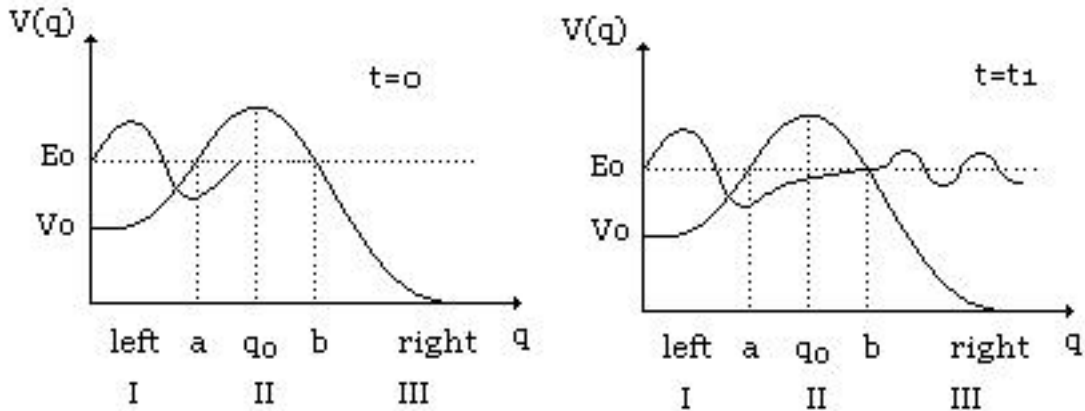

Fig.11 | The tunneling process in the quantum trigger model for exocytosis. (Left) The initial state at $t = 0$: the wave function is located to the left of the barrier. E_0 is the energy of the activated state that starts tunneling through the barrier [see equation (5)]. (Right) At time t_1 (duration time of presynaptic activation) the wave function has components on both sides of the barrier. a, b : classical turning points of the motion inside and outside the barrier.

Beck doubts that the distinction between the two activation mechanisms can be tested experimentally in isolated hippocampal neurons since one would have to vary temperatures at least in a range of $\pm 5-10^\circ\text{C}$. Nevertheless there is good indirect data suggesting that the exocytosis is a result of quantum tunnel effect through a barrier!

In the synaptic vesicle release there are involved a number of proteins (SNAPs, synaptotagmin, synaptobrevin, neurexin, syntaxin) and because there is an energy barrier their function can be compared with the enzyme catalytic action. According to Hameroff (1998) [41] the London quantum forces set the pattern for protein dynamics. A year later - 1999 Basran supposes vibration driven extreme tunneling for enzymatic H-transfer.

At the beginning of 21st century the Haldane's notion of 'imperfect key' about the biological catalysis in classical over-the-barrier manner is questioned. Sutcliffe and Scrutton (2000) [42] underline that matter is usually treated as a particle. However it can also be treated as a wave (wave-particle duality). These wavelike properties, which move our conceptual framework into the realm of quantum mechanics, enable matter to pass through regions that would be inaccessible if it were as a particle. In the quantum world, the pathway from reactants to products might not need to pass over the barrier but pass through the barrier by quantum tunneling. Quantum tunneling is more pronounced for light particles (e.g. electrons), because the wavelength of a particle is inversely proportional to the square root of the mass of the particle (Prince Louis-Victor De Broglie received Nobel Prize for 1929 for his discovery of the wave nature of electrons). Electrons can be tunneled for distance of about 2,5 - 3 nm. Protium can tunnel over a distance of 0,058 nm with the same probability as an electron tunneling over 2,5 nm. The isotopes of hydrogen - deuterium and tritium have increased mass and tunnel with the same probability over 0,041 nm and 0,034 nm. Klinmann and co-workers were the first to obtain experimental evidence consistent with H-tunneling in an enzyme-catalyzed reaction on the basis of deviation in kinetic isotope effect from that expected for classical behavior. Since their proposal of H-tunneling at physiological temperatures in yeast alcohol dehydrogenase [43], they have also demonstrated similar effects in bovine serum amine oxidase [44], monoamine oxidase [45] and glucose oxidase [46]. Tunneling in these systems was described in terms of static barrier depictions.

The pure quantum tunneling reactions are temperature independent, because thermal activation of the substrate is not required to ascend the potential energy surface. However the rate of C-H and C-D cleavage by methylamine dehydrogenase was found to be strongly dependent on temperature, indicating that thermal activation or 'breathing' of the protein molecule is required for catalysis. Moreover, the temperature dependence of the reaction is independent of isotope, reinforcing the idea that protein (and not substrate) dynamics drive the reaction and that tunneling is from the ground state. Good evidence is now available for vibrationally assisted tunneling [47,48] from studies of the effects of pressure on deuterium isotope effects in yeast alcohol dehydrogenase [49]. Combining the experimental evidence, the argument for vibrationally assisted tunneling is now compelling. The dynamic fluctuations in the protein molecule are likely to compress transiently the width of the potential energy barrier and equalize the vibrational energy levels on the reactant and product site of the barrier [50,51,52]. Compression of the barrier reduces the tunneling distance (thus increasing the probability of the transfer), and equalization of vibrational energy states is a prerequisite for tunneling to proceed. Following transfer to the product side of the barrier, relaxation from the geometry required for tunneling "traps" the H-nucleus by preventing quantum 'leakage' to the reactant side of the barrier.

The catalysis is driven by the protein conformations, but the opposite is also true. Every protein driven process (transport, muscle contraction, exocytosis) could be referred to as a catalyzed process and thus quantum in nature. The most important here is that the pure quantum tunneling is temperature independent. In contrast proteins have evolved mechanisms to utilize the thermal energy for quantum processes (compressing the width of the energy barrier).

15. Discussion

In the next table are presented comparatively some basic ideas of Stuart Hameroff [53] and their counterpart in the present paper.

Contemporary Orch OR Model	β-Neurexin-Neuroigin Entanglement
1. Supposes that DLBs are a kind of Josephson junctions	1. No Josephson junctions needed
2. Mitochondrion cannot supply electrons for tunneling – it has double bilayer and between the 2 membranes there are protons not electrons	2. No need of mitochondria
3. Gap junctions mediate interneuronal quantum coherence	3. No gap junctions needed
4. No interneuronal teleportation of microtubule states	4. Supposes entanglement between neurons and quantum teleportation of states
5. The maximal time to decoherence is too short ~ 1 nanosecond	5. The quantum coherent link between neurons is shielded by GAGs
6. Glia is involved in the conscious experience	6. Glia is not involved in consciousness
7. Cannot explain the integrative function of axons in conscious experience	7. Involves axons and chemical synapses in the conscious experience
8. Vague link with synaptic vesicle release	8. The consciousness directly acts upon exocytosis of neuromediator
9. Supposes that plasmalemmal receptors and some other proteins are maybe involved in conscious experience	9. Gives fully-functional protein body to consciousness
10. Does not explain why classical computing is needed.	10. The classical propagation of the membrane potential inputs and outputs information
11. Supposes that interneuronal quantum coherence can be sustained in the retina and cochlea	11. Supposes that interneuronal quantum coherence can be sustained only between cortical neurons

16. References

[1] Stuart Hameroff (1999) - Consciousness, the Brain, and Spacetime Geometry. Annals New York Academy Of Sciences, 74-104.

<http://www.consciousness.arizona.edu/hameroff/cajal.pdf>

[2] Stuart Hameroff (1999) - Quantum mechanisms in the brain?

<http://www.consciousness.arizona.edu/quantum/week6.htm>

[3] Stuart Hameroff, Roger Penrose (1998) - Quantum computation in brain microtubules? The Penrose-Hameroff "Orch OR" model of consciousness. Philosophical Transactions Royal Society London (A) 356:1869-1896.

[4] Dimitri Nanopoulos (1995) - Theory of Brain Function, Quantum Mechanics And Superstrings.

<http://arxiv.org/pdf/hep-ph/9505374>

[5] Dimitri Nanopoulos, Nick Mavromatos (1996) - A Non-Critical String (Liouville) Approach to Brain Microtubules: State Vector Reduction, Memory Coding and Capacity.

<http://arxiv.org/pdf/quant-ph/9512021>

[6] Andreas Merzhin, Dimitri V. Nanopoulos, Efthimios M.C. Skoulakis (2000) - Quantum Brain?

<http://arxiv.org/pdf/quant-ph/0007088>

[7] Nick E. Mavromatos, Andreas Merzhin, Dimitri V. Nanopoulos (2002) - QED-Cavity model of microtubules implies dissipationless energy transfer and biological quantum teleportation.

<http://arxiv.org/pdf/quant-ph/0204021>

[8] Nick Mavromatos (2000) - Cell Microtubules as Cavities: Quantum Coherence and Energy Transfer?

<http://arxiv.org/pdf/quant-ph/0009089>

[9] Max Tegmark (1999) - The Importance of Quantum Decoherence in Brain Processes.

<http://arxiv.org/pdf/quant-ph/9907009>

[10] C.I. De Zeeuw, S.K. Koekkoek, D.R. Wylie & J.I. Simpson (1997) - Association between dendritic lamellar bodies and complex spike synchrony in the olivocerebellar system. J. Neurophysiol. 77 (4): 1747-1758.

[11] C.I. De Zeeuw, C.C. Hoogenraad, E. Goedknegt, E. Hertzberg, A. Neubauer, F. Grosveld, N. Galjart (1997) - CLIP-115, a novel brain-specific cytoplasmic linker protein, mediates the localization of dendritic lamellar bodies. Neuron 19 (6): 1187-1199.

[12] M. Jibu & K. Yasue (1995) - Quantum brain dynamics: an introduction. John Benjamins, Amsterdam.

[13] M. Jibu, S. Hagan, S.R. Hameroff, K.M. Pribram, K. Yasue (1994) - Quantum optical coherence in cytoskeletal microtubules: implications for brain function. Bio-Systems 32: 195-209.

[14] Priscilla E.M. Purnick, David C. Benjamin, Vytas K. Verselis, Thaddeus A. Bargiello, Terry L. Dowd (2000) - Structure of the Amino Terminus of a Gap Junction Protein. Archives of Biochemistry and Biophysics Vol. 381, No. 2, pp. 181-190.

http://www.bioc.aecom.yu.edu/labs/girvlab/nmr/PDF/purnick_ABBI_2000.pdf

[15] A. Draguhn, R.D. Traub, D. Schmitz, J.G.R. Jefferys (1998) - Electrical coupling underlies high-frequency oscillations in the hippocampus in vitro, Nature, 394, 189-192.

- [16] R.D. Traub, D. Schmitz, J.G.R. Jefferys, A. Draguhn (1999) - High-frequency population oscillations are predicted to occur in hippocampal pyramidal neuronal networks interconnected by axo-axonal gap junctions. *Neuroscience* 92, 407-426.
- [17] S. Hagan, S.R. Hameroff, J.A. Tuszynski (2000) - Quantum Computation in Brain Microtubules? Decoherence and Biological Feasibility.
<http://arxiv.org/pdf/quant-ph/0005025>
- [18] E. Lucio Benedetti, Irene Dunia, Michel Recouvreur, Pierre Nicolas, Nalin M. Kumar, Hans Bloemendal (2000) - Structural organization of gap junctions as revealed by freeze-fracture and SDS fracture-labeling. *European Journal Of Cell Biology* 79, 575-582.
- [19] C.H. Bennett (1995) - Quantum information and computation. *Phys. Today* 48 (10), 24.
- [20] D.P. Di Vincenzo (1995) - Quantum computation. *Science* 269, 255.
- [21] A. Barenco (1996) - Quantum physics and computers. *Contemp. Phys.* 37, 375.
- [22] Yuriy Makhlin, Gerd Schon, Alexander Shnirman (1998) - Josephson Junction Qubits with Controlled Couplings
<http://fy.chalmers.se/~delsing/QubitBattle/Schon-Nature.pdf>
- [23] W. A. Al-Saidi, D. Stroud (2001) - Eigenstates of a small Josephson junction coupled to a resonant cavity.
<http://www.physics.ohio-state.edu/~stroud/alsaidi.pdf>
- [24] J.K. Freericks, B.K. Nikolic, P. Miller (2001) - Tuning a Josephson junction through a quantum critical point. *Physical Review B*, Volume 64, 054511
http://www.physics.sunysb.edu/~bnikolic/jj_qc.pdf
- [25] Frank W. Pfrieger, Barbara A. Barres (1997) - Synaptic Efficacy Enhanced by Glial Cells in Vitro. *Science*, Vol. 277, 1684-1687.
http://pfrieger.gmxhome.de/work/publications/pfrieger&barres_1997.pdf
- [26] Ken McCarthy (2001) - Investigating the role of astrocyte signaling in brain function.
<http://www.med.unc.edu/wrkunits/2depts/pharm/mccarthy.htm>
- [27] M.K. Shelton, K.D. McCarthy (1999) - Mature hippocampal astrocytes exhibit functional metabotropic and ionotropic glutamate receptors in situ. *Glia*, 26: 1-11.
- [28] C. Giaume, K.D. McCarthy (1996) - Control of gap-junctional communication in astrocytic networks. *Trends Neurosci.* 19:319-325.
- [29] J.T. Porter, K.D. McCarthy (1996) - Hippocampal astrocytes in situ respond to glutamate released from synaptic terminals. *J.Neurosci.* 16:5073-5081.
- [30] Alan S. Fanning, James Melvin Anderson (1999) - Protein modules as organizers of membrane structure. *Current Opinion in Cell Biology*, 11:432-439.
- [31] M. Irie, Y. Hata, M. Takeuchi, K. Ichtchenko, A. Toyoda, K. Hirao, Y. Takai, T.W. Rosahl, T. Sudhof (1997) - Binding of neuroligins to PSD-95. *Science*, 277:1511-1515.
- [32] Y. Hata, S. Butz, T.C. Sudhof (1996) - CASK: a novel dlg/PDZ95 homolog with an N-terminal calmodulin-dependent protein kinase domain identified by interaction with neurexins. *J Neurosci*, 16:2488-2494.
- [33] M. Missler, T. Sudhof (1998) Neurexins: three genes & 1001 products. *Trends Genet*, 14:20-26.

- [34] A.R. Cohen, D.F. Woods, S.M. Marfatia, Z. Walther, A.H. Chishti, J.M. Anderson (1998) - Human CASK LIN-2 binds syndecan-2 and protein 4.1 and localizes to the basolateral membrane of epithelial cells. *J Cell Biol*, 142:129-138.
- [35] Y. Hsueh, F. Yang, V. Kharazia, S. Naisbitt, A. Cohen, R. Weinberg, M. Sheng (1998) - Direct interaction of CASK/LIN-2 and syndecan heparan sulfate proteoglycan and their overlapping distribution in neuronal synapses. *J Cell Biol* 1998, 142:139-151.
- [36] R. Lue, S. Marfatia, D. Branton, A. Chishti (1995) - Cloning and characterization of hDlg; the human homolog of the *Drosophila* discs large tumor suppressor binds to protein 4.1. *Proc Natl Acad Sci USA*, 91:9818-9822.
- [37] A. Chishti, A.C. Kim, S. Marfatia, M. Lutchman, M. Hanspal, H. Jindal, S.C. Liu, P.S. Low, G.A. Rouleau, N. Mohandas et al. (1998) - The FERM domain: a unique module involved in the linkage of cytoplasmic proteins to the membrane. *Trends Biochem Sci*, 23:281-282.
- [38] M. Niethammer, J.G. Valtschanoff, T.M. Kapoor, D.W. Allison, T.M. Weinberg, A.M. Craig, M. Sheng (1998) - CRIPT, a novel postsynaptic protein that binds to the third PDZ domain of PSD-95/SAP90. *Neuron*, 20:693-707.
- [39] Linda Hsieh-Wilson (2001) - The Tangled Web: Unraveling the Molecular Basis for Communication. *Engeneering & Science No.2*, pp14-23.
[http://pr.caltech.edu/periodicals/EandS/articles/Hsieh-Wilson Feature.pdf](http://pr.caltech.edu/periodicals/EandS/articles/Hsieh-Wilson%20Feature.pdf)
- [40] Scott Hagan (1999) - Testable Predictions – Experimental Approaches.
<http://www.consciousness.arizona.edu/quantum/Lecture12.htm>
- [41] Stuart Hameroff (1998) - Anesthesia, consciousness and hydrophobic pockets-a unitary quantum hypothesis of anesthetic action. *Toxicology Letters*100/101:31-39.
- [42] Michael J. Sutcliffe & Nigel S. Scrutton (2000) – Enzyme catalysis: over the barrier or through-the-barrier? *TIBS*, September 405-408.
- [43] Y. Cha et al. (1989) – Hydrogen tunneling in enzyme reactions. *Science* 243, 1325-1330.
- [44] K.L. Gant, J.P. Klinman (1989) – Evidence that protium and deuterium undergo significant tunneling in the reaction catalyzed by bovine serum amine oxidase. *Biochemistry* 28, 6597-6605.
- [45] T. Johnsson et al. (1994) – Hydrogen tunneling in the flavoenzyme monoamine oxidase B. *Biochemistry* 33, 14871-14878.
- [46] A. Kohen et al. (1997) – Effects of protein glycosylation on catalysis: changes in hydrogen tunneling and enthalpy of activation in the glucose oxidase reaction. *Biochemistry* 36, 2603-2611.
- [47] W.J. Bruno, W. Bialek (1992) – Vibrationally enhanced tunneling as a mechanism for enzymatic hydrogen transfer. *Biophys. J.* 63, 689-699.
- [48] J. Basran et al. (1999) – Enzymatic H-transfer requires vibration driven extreme tunneling. *Biochemistry* 38, 3218-3222.
- [49] D.B. Northrop, Y.K. Cho (2000) – Effect of pressure of deuterium isotope effects of yeast alcohol dehydrogenase: evidence for mechanical models of catalysis. *Biochemistry* 39, 2406-2412.
- [50] M.J. Sutcliffe, N.S. Scrutton (2000) – Enzymology takes a quantum leap forward. *Philos. Trans. R. Soc. London Ser. A* 358, 367-386.

[51] N.S. Scrutton et al. (1999) – New insights into enzyme catalysis: ground state tunneling driven by protein dynamics. *Eur. J. Biochem.* 264, 666-671.

[52] A. Kohen, J.P. Klinman (1999) – Hydrogen tunneling in biology. *Chem. Biol.* 6, R191-R198.

[53] Stuart Hameroff (2002) - Quantum Consciousness
<http://www.consciousness.arizona.edu/hameroff/>