

Entropy as a function of Geometric Phase

Julian Hartley and Vlatko Vedral

November 9, 2018

Abstract

We give a closed-form solution of von Neumann entropy as a function of geometric phase modulated by visibility and average distinguishability in Hilbert spaces of two and three dimensions. We show that the same type of dependence also exists in higher dimensions. We also outline a method for measuring both the entropy and the phase experimentally using a simple Mach-Zehnder type interferometer which explains physically why the two concepts are related.

1 Introduction

The von Neumann entropy [1] is a measure of mixedness in a physical state described by a density matrix. The general rule is that the more orthogonal the states comprising the density matrix are, the higher the value of the corresponding entropy. Looking at it from a different perspective, the entropy signifies the lack of knowledge we have about the exact pure state the system is in. For pure states, the knowledge is maximal and the value of entropy is zero, while for a maximally mixed state (the normalized identity matrix), the value of entropy is highest as any of the pure states in the mixture is equally likely. Therefore, this intuition would suggest that distinguishability between states is the only parameter determining the value of entropy. We also note that entropy is a static property of the system (i.e. it is only a function of the density matrix describing the state, rendering it completely insensitive to the dynamical evolution).

Geometric phases, on the other hand, are obtained when a physical system evolves through a (discrete or continuous) set of states. We can say that this phase depends only on the geometric aspects of this evolution (i.e. it is, for instance, independent of the rate of evolution), but that it is still a dynamical property of the system. In other words, it is generated by dynamics, although

the dynamics can be either a continuous Schrödinger type evolution or a discrete quantum measurement (of the most general type). The geometric phase has a long and interesting history, and we refer the interested reader to the collection of papers compiled by Shapere and Wilczek [2]. No detailed knowledge of this will be necessary however, as all the relevant information will be given here.

Given that the entropy is a static property and geometric phase a dynamical property of a quantum system, we would not at first sight expect there to be any connections between the two. This conclusion is however incorrect and in this paper, we will show that entropy can in fact be written as a function of geometric phase (and some other parameters in general).

Our work has been stimulated by Jozsa and Schlienz [3] who pointed out that von Neumann entropy can increase even when the ensemble of quantum states become less distinguishable (i.e. more parallel). They noticed that this behaviour does not occur in a two dimensional Hilbert space but emerges in a three dimensional Hilbert space. Their conclusion is that distinguishability is a global property (considering the whole ensemble) which cannot be reduced to considering the pairwise overlaps of the states.

In this paper, we attribute this transition to the presence of a geometric phase by giving a closed-form solution of entropy as a function of geometric phase. We will begin by defining all the relevant variables. Then we will work through the two and three dimensional cases. We also comment on the arbitrary dimensional case. We will finally briefly discuss a method to experimentally measure entropy and show that the same set up is also used for measuring geometric phases. It is for this reason precisely that the two concepts are related. Interestingly, in two dimensions, the entropy is either a function of the phase or distinguishability, but we do not need both at the same time (this is because the phase and distinguishability can directly be related to each other). For higher dimensions this relationship becomes more complicated as we will show and throughout the paper we discuss mathematical and physical reasons for this difference between two and higher dimensional systems. We will conclude by discussing the implications of our results with possible generalizations.

2 Setting the Scene

As we have already said, entropy is a physical quantity that quantifies the lack of information in a given ensemble. Suppose the ensemble contains three quantum states $|\psi_1\rangle, |\psi_2\rangle, |\psi_3\rangle$ with prior probabilities p_1, p_2, p_3 respectively where $p_1 + p_2 + p_3 = 1$. We can construct the density operator

$\rho = p_1|\psi_1\rangle\langle\psi_1| + p_2|\psi_2\rangle\langle\psi_2| + p_3|\psi_3\rangle\langle\psi_3|$ and the von Neumann entropy as $S_{vN} = -Tr(\rho \ln \rho)$ where the Boltzmann constant $k_B = 1$. Rather than state vectors, we shall be predominantly working with coherence vectors which is a completely analogous description. This is because we can generalize to higher number of states than the dimension of the system. Any density operator for two dimensions can be written as $\rho = \frac{1}{2}(\mathbb{I} + \mathbf{n} \cdot \sigma)$, where σ are the Pauli matrices:

$$\sigma_1 = \begin{pmatrix} 0 & 1 \\ 1 & 0 \end{pmatrix}, \sigma_2 = \begin{pmatrix} 0 & -i \\ i & 0 \end{pmatrix}, \sigma_3 = \begin{pmatrix} 1 & 0 \\ 0 & -1 \end{pmatrix} \quad (1)$$

\mathbf{n} is a three component coherence vector and \cdot denotes the scalar product. In three dimensions any state can be written as $\rho = \frac{1}{3}(\mathbb{I} + \sqrt{3}\mathbf{n} \cdot \lambda)$ where λ are the Gell-Mann matrices:

$$\begin{aligned} \lambda_1 &= \begin{pmatrix} 0 & 1 & 0 \\ 1 & 0 & 0 \\ 0 & 0 & 0 \end{pmatrix}, & \lambda_2 &= \begin{pmatrix} 0 & -i & 0 \\ i & 0 & 0 \\ 0 & 0 & 0 \end{pmatrix}, & \lambda_3 &= \begin{pmatrix} 1 & 0 & 0 \\ 0 & -1 & 0 \\ 0 & 0 & 0 \end{pmatrix}, \\ \lambda_4 &= \begin{pmatrix} 0 & 0 & 1 \\ 0 & 0 & 0 \\ 1 & 0 & 0 \end{pmatrix}, & \lambda_5 &= \begin{pmatrix} 0 & 0 & -i \\ 0 & 0 & 0 \\ i & 0 & 0 \end{pmatrix}, & \lambda_6 &= \begin{pmatrix} 0 & 0 & 0 \\ 0 & 0 & 1 \\ 0 & 1 & 0 \end{pmatrix}, \\ \lambda_7 &= \begin{pmatrix} 0 & 0 & 0 \\ 0 & 0 & -i \\ 0 & i & 0 \end{pmatrix}, & \lambda_8 &= \frac{1}{\sqrt{3}} \begin{pmatrix} 1 & 0 & 0 \\ 0 & 1 & 0 \\ 0 & 0 & -2 \end{pmatrix} \end{aligned} \quad (2)$$

and \mathbf{n} is now an eight component coherence vector. Note that our representation of the state in terms of Pauli and Gell-Mann matrices is not unique. Any other appropriate basis will be related to this basis through an orthogonal matrix transformation that would be 3 and 8 dimensional respectively [4]. For arbitrary dimensions, the density matrix is given by:

$$\rho = \frac{1}{d}(\mathbb{I} + \sqrt{\frac{d(d-1)}{2}}\mathbf{n} \cdot \lambda) \quad (3)$$

where \mathbf{n} is the $d^2 - 1$ element coherence vector and λ are $d \times d$ matrices satisfying the Lie algebra of $SU(d)$ [5]. The mixedness is introduced in the coherence vectors by $\mathbf{n} = p_1\mathbf{n}_1 + p_2\mathbf{n}_2 + p_3\mathbf{n}_3$ where \mathbf{n}_i are the coherence vectors corresponding to the i th state.

We now introduce a quantity called the perimeter, P , defined as:

$$P = |\mathbf{n}_1 - \mathbf{n}_2|^2 + |\mathbf{n}_2 - \mathbf{n}_3|^2 + |\mathbf{n}_3 - \mathbf{n}_1|^2 \quad (4)$$

$$= 2\mathbf{n}_1^2 + 2\mathbf{n}_2^2 + 2\mathbf{n}_3^2 - 2\mathbf{n}_1 \cdot \mathbf{n}_2 - 2\mathbf{n}_2 \cdot \mathbf{n}_3 - 2\mathbf{n}_3 \cdot \mathbf{n}_1 \quad (5)$$

$$= 6 - 2(\mathbf{n}_1 \cdot \mathbf{n}_2 + \mathbf{n}_2 \cdot \mathbf{n}_3 + \mathbf{n}_3 \cdot \mathbf{n}_1) \quad (6)$$

This quantity tells us how different the three states are on average. The larger the perimeter, the more orthogonal the states become. Note that this quantity is related to the sum of the overlaps of the quantum states (for example in three dimensions):

$$Q = |\langle \psi_1 | \psi_2 \rangle|^2 + |\langle \psi_2 | \psi_3 \rangle|^2 + |\langle \psi_3 | \psi_1 \rangle|^2 \quad (7)$$

$$= \text{Tr}(\rho_1 \rho_2) + \text{Tr}(\rho_2 \rho_3) + \text{Tr}(\rho_3 \rho_1) \quad (8)$$

$$= \frac{1}{3}(1 + 2\mathbf{n}_1 \cdot \mathbf{n}_2) + \frac{1}{3}(1 + 2\mathbf{n}_2 \cdot \mathbf{n}_3) + \frac{1}{3}(1 + 2\mathbf{n}_3 \cdot \mathbf{n}_1) \quad (9)$$

$$= 1 + \frac{6 - P}{3} \quad (10)$$

The negative sign makes sense because the more/less parallel the states are, the smaller/larger the perimeter. If the states are identical, $P = 0$ (since $\mathbf{n}_i \cdot \mathbf{n}_i = 1$) and if they are orthogonal, $P = 9$ (since $\mathbf{n}_i \cdot \mathbf{n}_j = -1/(d - 1)$ for $i \neq j$ where d is the dimension of the system). Note that this is for the three dimensional case. With three states, we can visualize the perimeter as the square distances of each side of a triangle with each vertex representing a quantum state (see Figure 1). As soon as we consider more states, the usual

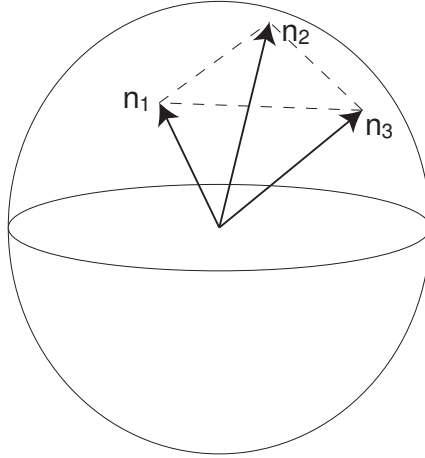

Figure 1: Coherence vector space with three general states. The dotted lines denote the perimeter. Note that in two dimensions, the ball itself is a Bloch sphere and every point corresponds to a physical state. But for higher dimensions, the coherence vector space is a proper subset of the ball. [4].

meaning of perimeter breaks down because we must include more than two distances for each state. For example with four states, we will have the square distances of each side of a four sided polygon as well as the two lines adjoining

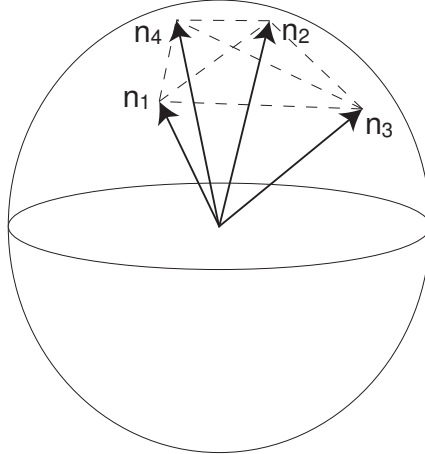

Figure 2: Coherence vector space with four states. The dotted lines again denote the perimeter.

opposite vertices (see Figure 2). Hence the term "average distinguishability" may be more appropriate than perimeter but we will continue to use the latter throughout the paper. We would now expect, as mentioned earlier in the introduction, that the larger the perimeter, the more distinguishable (orthogonal) the states comprising the mixture, and the higher the value of the entropy. This is, as will be shown in more detail soon, true for qubits, but fails in higher dimensions in general.

Before we go into the main topic of the paper, we point out another important issue. Namely, changing the definition of the perimeter and Q by removing the squares in equations (4) and (7) respectively, changes the behaviour of the perimeter with respect to the entropy. In particular, we can now observe an increase in entropy by decreasing the perimeter (or equivalently increasing the overlap) for the two dimensional ensemble contrary to [3]. Let us consider the following states:

$$|\psi_1\rangle = \cos(\theta_1/2)|0\rangle + \exp(-i\phi_1) \sin(\theta_1/2)|1\rangle \quad (11)$$

$$|\psi_2\rangle = \cos(\theta_2/2)|0\rangle + \exp(-i\phi_2) \sin(\theta_2/2)|1\rangle \quad (12)$$

$$|\psi_3\rangle = \cos(\theta_3/2)|0\rangle + \exp(-i\phi_3) \sin(\theta_3/2)|1\rangle \quad (13)$$

or equivalently the following coherence vectors:

$$\mathbf{n}_1 = [\sin(\theta_1) \cos(\phi_1), \sin(\theta_1) \sin(\phi_1), \cos(\theta_1)] \quad (14)$$

$$\mathbf{n}_2 = [\sin(\theta_2) \cos(\phi_2), \sin(\theta_2) \sin(\phi_2), \cos(\theta_2)] \quad (15)$$

$$\mathbf{n}_3 = [\sin(\theta_3) \cos(\phi_3), \sin(\theta_3) \sin(\phi_3), \cos(\theta_3)] \quad (16)$$

Let us fix $\theta_i = \pi/2$, $\phi_2 = 2\pi/3$, $\phi_3 = 4\pi/3$ and vary ϕ_1 from $0 \rightarrow 2\pi$. In the Bloch sphere picture, the states lie on the equator with each state initially equally spaced. ψ_1 or \mathbf{n}_1 rotates around once remaining on the equatorial plane while keeping the other two states fixed. Figure 3 shows the anomaly. Since this behaviour is counterintuitive, we will hereafter continue to use

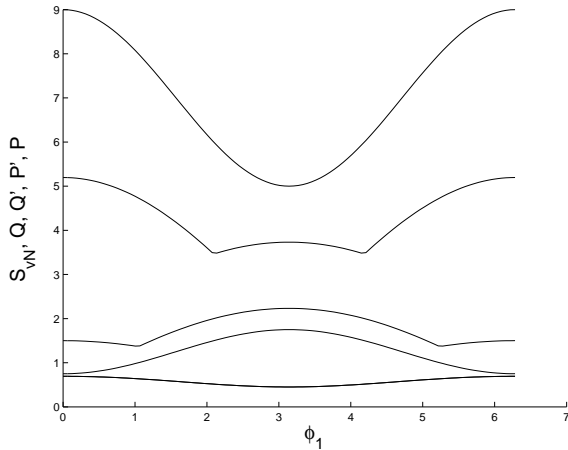

Figure 3: The bottom line shows the von Neumann entropy, the one above shows Q and so on until the top line shows P . P' and Q' are without the squares. Note that just less than $\phi_1 = \pi$, S_{vN} decreases as P' increases. Also around $\phi_1 = 0$ and $\phi_1 = 2\pi$, S_{vN} decreases as Q' decreases and S_{vN} increases as Q' increases respectively.

the original definitions of P and Q because they avoid the above anomaly and allow a simple relationship between the perimeter and the total overlap. So, in summary, we now have that the larger the perimeter (or equivalently the smaller the Q), the larger the von Neumann entropy keeping all other variables constant.

The geometric phase is a phase that is observed when a state evolves in parameter space (e.g. the parameter could be a magnetic field strength) [6]. A more amenable interpretation for our present purposes is the quantum version of the Pancharatnam relative phase [7]. See [8] for a concise modern introduction. We can calculate the geometric phase γ by:

$$\gamma_{ijk} = \arg\{Tr(|\psi_i\rangle\langle\psi_i|\psi_j\rangle\langle\psi_j|\psi_k\rangle\langle\psi_k|\psi_i\rangle)\} \quad (17)$$

For three states in two dimensions, we get:

$$\tan \gamma_{123} = \frac{\mathbf{n}_1 \times \mathbf{n}_2 \cdot \mathbf{n}_3}{1 + \mathbf{n}_1 \cdot \mathbf{n}_2 + \mathbf{n}_2 \cdot \mathbf{n}_3 + \mathbf{n}_3 \cdot \mathbf{n}_1} \quad (18)$$

where $\mathbf{n}_1 \times \mathbf{n}_2$ is the ordinary cross product. For three states in three dimensions, we get [9]:

$$\tan \gamma_{123} = \frac{2\sqrt{3}\mathbf{n}_1 \cdot \mathbf{n}_2 \wedge \mathbf{n}_3}{(\mathbf{n}_1 + \mathbf{n}_2 + \mathbf{n}_3)^2 + 2\mathbf{n}_1 \cdot \mathbf{n}_2 \star \mathbf{n}_3 - 2} \quad (19)$$

where $\mathbf{n}_1 \cdot \mathbf{n}_2 \wedge \mathbf{n}_3 = n_{1i}f_{ijk}n_{2j}n_{3k}$ and $\mathbf{n}_1 \cdot \mathbf{n}_2 \star \mathbf{n}_3 = \sqrt{3}n_{1i}d_{ijk}n_{2j}n_{3k}$. i, j, k refer to the components of the vectors, f_{ijk} are the antisymmetric $SU(3)$ structure constants and d_{ijk} are the symmetric tensors. Note that γ_{123} refers to the phase taking three states of any dimensionality. Exact definitions and other useful formulae are given in [9] but for convenience, we state them here:

$$[\lambda_i, \lambda_j] = 2if_{ijk}\lambda_k \quad (20)$$

$$\{\lambda_i, \lambda_j\} = \frac{4}{3}\delta_{ij} + 2d_{ijk}\lambda_k \quad (21)$$

$$f_{123} = 1, f_{458} = f_{678} = \frac{\sqrt{3}}{2}, f_{147} = f_{246} = f_{257} = f_{345} = f_{516} = f_{637} = \frac{1}{2} \quad (22)$$

$$d_{118} = d_{228} = d_{338} = -d_{888} = \frac{1}{\sqrt{3}}, d_{448} = d_{558} = d_{668} = d_{778} = -\frac{1}{2\sqrt{3}}$$

$$d_{146} = d_{157} = -d_{247} = d_{256} = d_{344} = d_{355} = -d_{366} = -d_{377} = \frac{1}{2} \quad (23)$$

Other useful formulae are:

$$\lambda_i \lambda_j = \frac{2}{3}\delta_{ij} + (d_{ijk} + if_{ijk})\lambda_k \quad (24)$$

$$Tr \lambda_i = 0, Tr(\lambda_i \lambda_j) = 2\delta_{ij} \quad (25)$$

The visibility is defined by:

$$V_{ijk} = |Tr(|\psi_i\rangle\langle\psi_i|\psi_j\rangle\langle\psi_j|\psi_k\rangle\langle\psi_k|)| \quad (26)$$

where the name originates from V corresponding to how visible or how large the amplitude is in an interferometer [10, 11]. Note that $V \cos \gamma$ is equal to the denominator of $\tan \gamma$ given in equations (18) and (19) for two and three dimensions respectively.

3 Results

In this section we obtain the following results. We first show that in two dimensions, the entropy depends on either the perimeter or the product of the visibility and the cosine of the geometric phase but not both together. We next show that for three states in three dimensions, we need both quantities and nothing else. The same is shown to be true for three states in any dimension as expected. Then we show that for many states in three dimensions, the entropy depends now on the perimeter and all the possible combinations of the product of the visibility and the cosine of the geometric phase for every triplet of states. In the last subsection, we generalize to any dimensions and any number of states by using a closed-form solution of the entropy obtained by Chumakov et. al. [12]. Note that our results will apply for general mixtures of pure states, i.e. unequal probabilities, however, we will frequently express them with equal probabilities for convenience.

3.1 Any Number of States in Two Dimensions

As is shown in [3], entropy cannot be increased by increasing the average overlap of the ensemble in two dimensions for any number of states. We will show this by giving an explicit formula of von Neumann entropy as a function of perimeter. We can also rewrite it as a function of geometric phase (modulated by the visibility as will be defined later in this section) but the three quantities will not appear together in the function. We must first find the eigenvalues x_{\pm} of the density operator which will give $S_{vN} = -x_+ \ln x_+ - x_- \ln x_-$. Introduce $\mathbf{n} = \frac{1}{t}(\mathbf{n}_1 + \mathbf{n}_2 + \dots + \mathbf{n}_t) = (n_1, n_2, n_3)$ where $n_i = \frac{1}{t}(n_{1i} + n_{2i} + n_{3i} + \dots + n_{ti})$. The first subscript refers to the state, the second subscript refers to the vector component and t denotes the number of states. The eigenvalues are $x_{\pm} = (1 \pm \sqrt{n_1^2 + n_2^2 + n_3^2})/2$. Note that $n_1^2 + n_2^2 + n_3^2 = \mathbf{n} \cdot \mathbf{n}$. Since $\mathbf{n} \cdot \mathbf{n} = (t + 2\mathbf{n}_1 \cdot \mathbf{n}_2 + 2\mathbf{n}_2 \cdot \mathbf{n}_3 + 2\mathbf{n}_3 \cdot \mathbf{n}_1 + \dots + 2\mathbf{n}_{t-1} \cdot \mathbf{n}_t)/t^2$ and generalizing the definition of P above to t states (6 becomes $t(t-1)$), $\mathbf{n} \cdot \mathbf{n} = (t^2 - P)/t^2$. This gives:

$$S_{vN} = -\frac{1 + \sqrt{\frac{t^2 - P}{t^2}}}{2} \ln \frac{1 + \sqrt{\frac{t^2 - P}{t^2}}}{2} - \frac{1 - \sqrt{\frac{t^2 - P}{t^2}}}{2} \ln \frac{1 - \sqrt{\frac{t^2 - P}{t^2}}}{2} \quad (27)$$

Figure 4 plots this. We see that the von Neumann entropy is a monotonically increasing function of perimeter. Using equation (18), we can also write $P = 8 - 2V_{123} \cos \gamma_{123}$ for $t = 3$ where $V_{123} \cos \gamma_{123} = 1 + \mathbf{n}_1 \cdot \mathbf{n}_2 + \mathbf{n}_2 \cdot \mathbf{n}_3 + \mathbf{n}_3 \cdot \mathbf{n}_1$. We find that in two dimensions, increasing the geometric phase corresponds to an increase in entropy (negative values of $\cos \gamma$ become unphysical since at

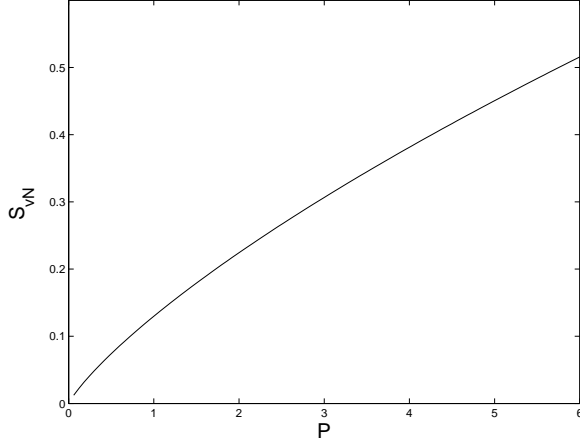

Figure 4: von Neumann entropy versus perimeter in two dimensions for $t = 3$

most $P = 9$ and this corresponds to all three states being orthogonal which is not possible in two dimensions). Likewise, decreasing V corresponds to an increase in P and hence entropy. For larger number of states, we can define the perimeter as a function of $V_{ijk} \cos \gamma_{ijk}$ for all the combinations of three states:

$$P = t(t-1) + \frac{2(t!)}{3!(t-3)!(t-2)} - \frac{2\Gamma}{t-2} \quad (28)$$

where

$$\Gamma = \sum_{k>j>i=1}^t V_{ijk} \cos \gamma_{ijk} \quad (29)$$

We can see that even for larger number of states in two dimensions, since the perimeter increases as geometric phase increases, the von Neumann entropy also increases. Note that in the case of unequal prior probabilities, there is no straightforward method of relating the perimeter to the geometric phase unless we redefine the geometric phase by incorporating the unequal prior probabilities.

The above calculations were for equal prior probabilities ($p = 1/t$). If we consider instead unequal prior probabilities p_i , we must redefine the perimeter:

$$\tilde{P} = |p_1 \mathbf{n}_1 - p_2 \mathbf{n}_2|^2 + |p_2 \mathbf{n}_2 - p_3 \mathbf{n}_3|^2 + |p_3 \mathbf{n}_3 - p_1 \mathbf{n}_1|^2 + \dots + |p_t \mathbf{n}_t - p_{t-1} \mathbf{n}_{t-1}|^2$$

and then we obtain:

$$\mathbf{n} \cdot \mathbf{n} = t \sum_{j=1}^t p_j^2 - \tilde{P} \quad (30)$$

and therefore entropy is still just a function of the perimeter. We can see that this reduces to the equal prior probability result above and when $p_i = 1$, $\mathbf{n} \cdot \mathbf{n} = 1$ thus $S_{vN} = 0$, as it should be for a pure state.

3.2 Three States in Three Dimensions

Similar steps are taken as the previous subsection. First we introduce the coherence vector $\mathbf{n} = (n_1, n_2, n_3, n_4, n_5, n_6, n_7, n_8) = \frac{1}{3}(\mathbf{n}_1 + \mathbf{n}_2 + \mathbf{n}_3)$ with equal prior probabilities. The perimeter is given by $\mathbf{n} \cdot \mathbf{n} = \frac{1}{9}(9 - P)$. Our density matrix is now a three by three matrix, and in order to compute its entropy we need to be able to find the eigenvalues first. This leads to solving the following cubic equation:

$$x^3 + Ax^2 + Bx + C = 0 \quad (31)$$

where

$$A = -1 \quad (32)$$

$$B = \frac{1 - \mathbf{n} \cdot \mathbf{n}}{3} \quad (33)$$

$$C = \frac{\mathbf{n} \cdot \mathbf{n}}{9} - \frac{1}{27} - \frac{2}{27} V_{123} \cos \gamma_{123} \quad (34)$$

with $V_{123} \cos \gamma_{123} = (\mathbf{n}_1 + \mathbf{n}_2 + \mathbf{n}_3)^2 + 2\mathbf{n}_1 \cdot \mathbf{n}_2 \star \mathbf{n}_3 - 2$. The solution is given by [13, 14]:

$$\begin{aligned} x_1 &= 2\sqrt{-T} \cos \frac{\theta}{3} - \frac{A}{3} \\ x_2 &= 2\sqrt{-T} \cos \frac{\theta + 2\pi}{3} - \frac{A}{3} \\ x_3 &= 2\sqrt{-T} \cos \frac{\theta + 4\pi}{3} - \frac{A}{3} \end{aligned} \quad (35)$$

where

$$R = \frac{9AB - 27C - 2A^3}{54} = \frac{V_{123} \cos \gamma_{123}}{27} \quad (36)$$

$$T = \frac{3B - A^2}{9} = -\frac{\mathbf{n} \cdot \mathbf{n}}{9} \quad (37)$$

$$\theta = \arccos \frac{R}{\sqrt{-T^3}} = \arccos \frac{V_{123} \cos \gamma_{123}}{(\mathbf{n} \cdot \mathbf{n})^{3/2}} \quad (38)$$

The von Neumann entropy is:

$$S_{vN} = -x_1 \ln x_1 - x_2 \ln x_2 - x_3 \ln x_3 \quad (39)$$

Let us look at a couple of examples. The first example uses the three states given in [9]:

$$|\psi_1\rangle = |2\rangle \quad (40)$$

$$|\psi_2\rangle = \sin \xi |1\rangle + \cos \xi |2\rangle \quad (41)$$

$$|\psi_3\rangle = \sin \eta \cos \zeta |0\rangle + e^{i\chi} \sin \eta \sin \zeta |1\rangle + \cos \eta |2\rangle \quad (42)$$

where $0 \leq \xi, \eta, \zeta \leq \pi/2$ and $0 \leq \chi < 2\pi$. By setting $\xi = \pi/2$, $\chi = 0$ and $\eta = \pi/2$, we can set the geometric phase γ and visibility V to vanish. Then by varying ζ , we can observe the dependence of von Neumann entropy S_{vN} on perimeter P between $6 \leq P \leq 9$ as is shown in Figure 5. As is the case in two

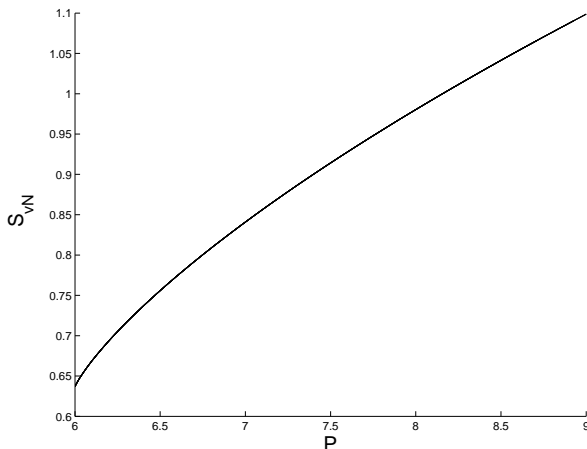

Figure 5: von Neumann entropy versus perimeter in three dimensions

dimensions (Figure 4), S_{vN} increases monotonically when P increases. Note that S_{vN} is bounded by the maximum entropy allowable in a d dimensional system $S_{max} = \ln d$. In fact the monotonically increasing property can be explicitly checked by differentiating equation (39) with respect to P and realizing the result to be positive for the above range of P . In order to inspect smaller values of P , we must also vary V or γ .

The second example uses the three states given in [3]:

$$|\psi_1\rangle = |0\rangle \quad (43)$$

$$|\psi_2\rangle = \frac{1}{\sqrt{2}}|0\rangle + \frac{1}{\sqrt{2}}|1\rangle \quad (44)$$

$$|\psi_3\rangle = \frac{1}{\sqrt{3}}|0\rangle + \frac{2e^{i\gamma} - 1}{\sqrt{3}}|1\rangle + \sqrt{\frac{4}{3}\cos\gamma - 1}|2\rangle \quad (45)$$

where γ is the geometric phase which is bounded here by $\gamma_{max} = 0.72$ radians. These three states keep V and P fixed so that we can inspect how S_{vN} depends on γ alone. By calculating the perimeter, geometric phase and visibility and using equation (39), we obtain Figure 6 which is identical to the graph given in [3]. In contrast to the two dimensional case where we can

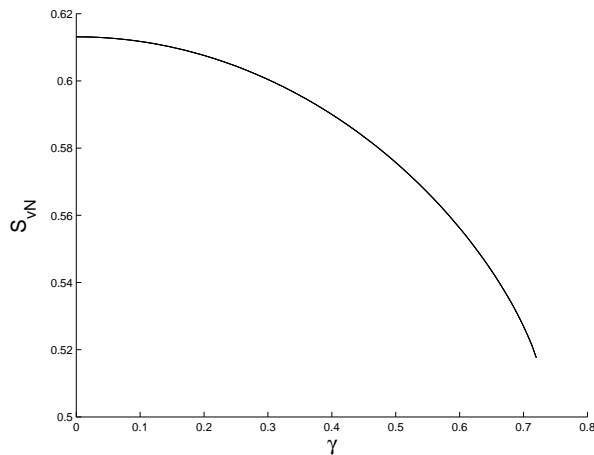

Figure 6: von Neumann entropy versus geometric phase in three dimensions

only increase/decrease the entropy as we increase/decrease the geometric phase, we also have that the entropy decreases/increases as the geometric phase increases/decreases.

Why should there be a transition between the two to the three dimensional case? Mathematically speaking, the distinctions are that the symmetric tensor does not exist in two dimensions and the isomorphism between $SU(2)$ and $SO(3)$ does not exist between $SU(3)$ and $SO(8)$. This means that in the eight dimensional ball, there are patches corresponding to unphysical states and therefore our intuition of what the phase is geometrically as well as how the perimeter changes is lost. A precise formulation of this remark is left for future research.

3.3 Three States in Any Dimensions

We can increase the number of dimensions arbitrarily by considering three general states $|\alpha\rangle$, $|\beta\rangle$ and $|\delta\rangle$. We can construct the density operator with equal prior probabilities, $\rho = \frac{1}{3}(|\alpha\rangle\langle\alpha| + |\beta\rangle\langle\beta| + |\delta\rangle\langle\delta|)$. As the above states are not orthogonal, we use the Gram-Schmidt procedure to obtain the following orthogonal states:

$$|v_1\rangle = \frac{|\alpha\rangle}{\| |\alpha\rangle \|} = |\alpha\rangle \quad (46)$$

$$|v_2\rangle = \frac{|\beta\rangle - \langle v_1|\beta\rangle|v_1\rangle}{\| |\beta\rangle - \langle v_1|\beta\rangle|v_1\rangle \|} = \frac{|\beta\rangle - \langle v_1|\beta\rangle|v_1\rangle}{\sqrt{1 - |\langle\alpha|\beta\rangle|^2}} \quad (47)$$

$$|v_3\rangle = \frac{|\delta\rangle - \langle v_2|\delta\rangle|v_2\rangle - \langle v_1|\delta\rangle|v_1\rangle}{\| |\delta\rangle - \langle v_2|\delta\rangle|v_2\rangle - \langle v_1|\delta\rangle|v_1\rangle \|} = \frac{|\delta\rangle - \langle v_2|\delta\rangle|v_2\rangle - \langle v_1|\delta\rangle|v_1\rangle}{\sqrt{1 - |\langle v_2|\delta\rangle|^2 - |\langle\alpha|\delta\rangle|^2}} \quad (48)$$

We can invert these and substitute into the density operator. By noting that $Q = |\langle\alpha|\beta\rangle|^2 + |\langle\beta|\delta\rangle|^2 + |\langle\delta|\alpha\rangle|^2$ (used instead of perimeter) and $V \cos \gamma = \Re\{\langle\alpha|\delta\rangle\langle\delta|\beta\rangle\langle\beta|\alpha\rangle\}$ we find that:

$$A = -1 \quad (49)$$

$$B = \frac{3 - Q}{9} \quad (50)$$

$$C = \frac{-1 + Q - 2V_{123} \cos \gamma_{123}}{27} \quad (51)$$

which give:

$$R = \frac{V_{123} \cos \gamma_{123}}{27} \quad (52)$$

$$T = -\frac{Q}{27} \quad (53)$$

$$\theta = \arccos \frac{\sqrt{27}V_{123} \cos \gamma_{123}}{Q^{3/2}} \quad (54)$$

By noting that $\mathbf{n} \cdot \mathbf{n} = 1 - P/9$ and $Q = (9 - P)/3$ gives $\mathbf{n} \cdot \mathbf{n} = Q/3$, we find that these equations are identical to the equivalent ones appearing in the previous subsection. This is not surprising because three states in arbitrary dimensions can be represented by a rank three matrix. The important point to observe is that we do not require any other quantity to define entropy. We still only require the total overlap (or perimeter), geometric phase and visibility.

For unequal prior probabilities, we do not get a simple generalization as in the two dimensional case because we have a mixture of probabilities to

the power of two and to the power of three which cannot be factored out. We have explicitly:

$$A = -1 \quad (55)$$

$$B = p_1 p_2 + p_2 p_3 + p_1 p_3 - p_1 p_2 |\langle \alpha | \beta \rangle|^2 - p_2 p_3 |\langle \beta | \delta \rangle|^2 - p_1 p_3 |\langle \alpha | \delta \rangle|^2 \quad (56)$$

$$C = p_1 p_2 p_3 (-1 + Q - 2V_{123} \cos \gamma_{123}) \quad (57)$$

They reduce to the equal prior probability case and for a pure state, $B = C = 0$ therefore when substituting into equation (35), we obtain the desired $S_{vN} = 0$. It is interesting to note that now R contains the overlap as well as the visibility and geometric phase, hence altering the above form of entropy. Since the probabilities directly influence how mixed the ensemble is, it is not surprising that the form of the entropy should change.

3.4 Any Number of States in Three Dimensions

We have so far looked at only three states in effectively three dimensions. We will now consider the three dimensional case with N number of states. We now have $\mathbf{n} = (n_1, n_2, \dots, n_8) = \frac{1}{N}(\mathbf{n}_1 + \mathbf{n}_2 + \dots + \mathbf{n}_{N-1} + \mathbf{n}_N)$. The perimeter can be written in a compact form as:

$$P = N(N-1) - 2 \sum_{i>j=1}^N \mathbf{n}_i \cdot \mathbf{n}_j \quad (58)$$

Note that this is also true for any dimensions. Another useful formula is:

$$\mathbf{n} \cdot \mathbf{n} = \frac{1}{N^2} [N + 2 \sum_{i>j=1}^N \mathbf{n}_i \cdot \mathbf{n}_j] \quad (59)$$

also true for any dimensions. We know that the cubic coefficients A and B remain the same as before. C is the only one that needs to be modified. We find that:

$$C = \frac{\mathbf{n} \cdot \mathbf{n}}{9} - \frac{1}{27} - \frac{2}{9N^3} \sum_{i>j>k=1}^N V_{ijk} \cos \gamma_{ijk} + \frac{2}{9N^3} \left(\frac{N!}{(N-3)!3!} + (N-3) \left(N(N-1) - P \right) - \frac{N}{3} \right) \quad (60)$$

Notice that when $N = 3$, this reduces to the aforementioned three state case. It is interesting to note that the geometric phase term still contains only three states albeit with all the possible combinations of three states.

3.5 Any Number of States in any Dimension

We know that the von Neumann entropy can be expanded in a power series $S_{vN} = \sum_{i=1}^{\infty} c_i Tr \rho^i$ where c_i are the expansion coefficients. The exact values of the c_i 's are not relevant for our discussion. Keyl and Werner [15] have shown that in order to calculate the eigenvalues of a d dimensional density matrix, it is necessary and sufficient to obtain all the traces of the powers of the density matrix up to the d th power. $Tr \rho^2$ contains the perimeter and $Tr \rho^3$ contains the geometric phase with three states as is shown in the next section. With a d dimensional system, the entropy will contain geometric phase terms up to d states. Obtaining a closed-form solution of the entropy for higher than four dimensions is difficult because there is no equation using only radicals to solve the quintic or higher equation. However, Chumakov et. al. [12] have a closed-form solution for arbitrary dimensional systems which requires traces of powers of the density matrices up to d . In turn, these traces contain only the perimeter and all combinations of the product of visibility and the cosine of the geometric phase up to d states, e.g. $V_{ab\dots d} \cos \gamma_{ab\dots d}$. So we conclude that even for higher dimensional systems, the entropy can be expressed as a function of perimeter and the product of visibility and the cosine of the geometric phases. Also, this is a natural way to view the fact that entropy should be a function of perimeter and geometric phases as will be also clear from the next section.

4 Experimental Measurements of Entropy, Perimeter and Phase

We use the simple quantum network based on the controlled-SWAP gate presented in [10] which extracts properties of quantum states bypassing the need for quantum tomography. Physically, the network is a representation of the Mach-Zehnder interferometer [16].

Since we have shown the von Neumann entropy as a function of perimeter (overlap), geometric phase and visibility, we can experimentally measure this entropy by calculating $Tr(\rho^2)$ for the perimeter and $Tr(\rho^3)$ for the visibility and geometric phase where $\rho = \frac{1}{3}(\rho_1 + \rho_2 + \rho_3)$ with equal prior probabilities for three states in three dimensions. However, we can generalize this experimental procedure for any dimensions and any number of states by calculating the traces of up to the d th power of the density matrix $\rho = \frac{1}{N} \sum_{i=1}^N \rho_i$ where N is the number of states. Consider a setup with two separable subsystems $\rho \otimes \rho$ and three separable subsystems $\rho \otimes \rho \otimes \rho$. We now introduce the swap operator W , $W|a\rangle \otimes |b\rangle = |b\rangle \otimes |a\rangle$ and the shift

operator F , $F|a\rangle \otimes |b\rangle \otimes |c\rangle = |c\rangle \otimes |a\rangle \otimes |b\rangle$ for any pure states $|a\rangle$, $|b\rangle$ and $|c\rangle$. The experimental procedure which will be described shortly measures $TrW(\rho \otimes \rho) = Tr(\rho^2)$ [10] and similarly $TrF(\rho \otimes \rho \otimes \rho) = Tr(\rho^3)$. This can be readily generalized to the d th power of ρ using the general shift operator S where $S|a\rangle \otimes \dots \otimes |c\rangle \otimes |d\rangle = |d\rangle \otimes |a\rangle \dots \otimes |c\rangle$ so that $TrS(\rho^{\otimes d}) = Tr(\rho^d)$.

We find on expansion:

$$Tr\rho^2 = \frac{1}{9}(3 + 2Tr\rho_1\rho_2 + 2Tr\rho_2\rho_3 + 2Tr\rho_1\rho_3) = \frac{1}{9}(3 + 2Q) \quad (61)$$

$$\begin{aligned} Tr\rho^3 &= \frac{1}{27}(3 + 6Tr\rho_1\rho_2 + 6Tr\rho_2\rho_3 + 6Tr\rho_1\rho_3 + 3Tr\rho_1\rho_2\rho_3 + 3Tr\rho_1\rho_3\rho_2) \\ &= \frac{1}{27}(3 + 6Q + 6V_{123} \cos \gamma_{123}) \end{aligned} \quad (62)$$

The last line follows from $Tr\rho_1\rho_2\rho_3 = V_{123}e^{i\gamma_{123}}$ and $Tr\rho_1\rho_3\rho_2 = V_{123}e^{-i\gamma_{123}}$. Hence on obtaining Q and $V_{123} \cos \gamma_{123}$, we can calculate S_{vN} for three states in three dimensions. In principle, we can also expand $Tr\rho^d$ to show that it contains Q and all the combinations of the product of visibility and the cosine of the geometric phase. Figure 7 shows the experimental set up that may be used to measure the von Neumann entropy (the diagram shows the case for two inputs of ρ but for a rank d density matrix, we must inspect up to d inputs of ρ). We will briefly describe how it calculates $Tr\rho^2$, and

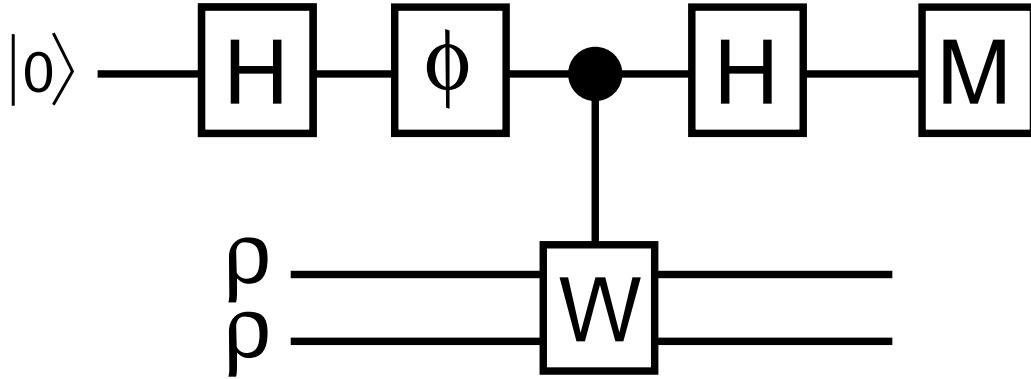

Figure 7: Experimental set up to ascertain $Tr\rho^2$. We must exchange the swap operator W with a shift operator S and input d ρ s to obtain $Tr\rho^d$.

then $Tr\rho^d$ is a straightforward extension. We begin with the initial state

$\rho_{in} = |0\rangle\langle 0| \otimes \rho \otimes \rho$. We apply the first Hadamard gate $H = \frac{1}{2} \begin{pmatrix} 1 & 1 \\ 1 & -1 \end{pmatrix}$:

$$\rho_H = (H \otimes \mathbb{I} \otimes \mathbb{I})(|0\rangle\langle 0| \otimes \rho \otimes \rho)(H^\dagger \otimes \mathbb{I} \otimes \mathbb{I}) \quad (63)$$

$$= \frac{1}{2} \begin{pmatrix} 1 & 1 \\ 1 & 1 \end{pmatrix} \otimes \rho \otimes \rho \quad (64)$$

Then we apply the phase shift $\Phi = \begin{pmatrix} e^{i\phi} & 0 \\ 0 & 1 \end{pmatrix}$ to get $\rho_\Phi = \frac{1}{2} \begin{pmatrix} 1 & e^{i\phi} \\ e^{-i\phi} & 1 \end{pmatrix} \otimes \rho \otimes \rho$. Next is the controlled-swap operation:

$$U_{cs} = \begin{pmatrix} 1 & 0 \\ 0 & 0 \end{pmatrix} \otimes \mathbb{I} \otimes \mathbb{I} + \begin{pmatrix} 0 & 0 \\ 0 & 1 \end{pmatrix} \otimes W \quad (65)$$

and finally another Hadamard to obtain:

$$\begin{aligned} \rho_{out} = & \frac{1}{4} \left[\begin{pmatrix} 1 & 1 \\ 1 & 1 \end{pmatrix} \otimes \rho \otimes \rho + \begin{pmatrix} 1 & -1 \\ -1 & 1 \end{pmatrix} \otimes W(\rho \otimes \rho)W^\dagger \right. \\ & \left. + e^{i\phi} \begin{pmatrix} 1 & -1 \\ 1 & -1 \end{pmatrix} \otimes (\rho \otimes \rho)W^\dagger + e^{-i\phi} \begin{pmatrix} 1 & 1 \\ -1 & -1 \end{pmatrix} \otimes W(\rho \otimes \rho) \right] \end{aligned} \quad (66)$$

Since measuring the intensity I is proportional to the probability, we can measure in the computational basis $|0\rangle$ to get:

$$\begin{aligned} I & \propto Tr \left[|0\rangle\langle 0| \otimes \mathbb{I} \otimes \mathbb{I} \rho_{out} \right] \\ & \propto Tr \rho Tr \rho + Tr(W\rho \otimes \rho W^\dagger) + e^{i\phi} Tr(\rho \otimes \rho W^\dagger) + e^{-i\phi} Tr(W\rho \otimes \rho) \\ & = 1 + 1 + e^{i\phi} [Tr W\rho \otimes \rho]^* + e^{-i\phi} Tr W\rho \otimes \rho \end{aligned} \quad (67)$$

$$= 2 + e^{i\phi} |Tr \rho^2| e^{-i \arg Tr \rho^2} + e^{-i\phi} |Tr \rho^2| e^{i \arg Tr \rho^2} \quad (68)$$

$$= 2 + 2|Tr \rho^2| \cos[\phi - \arg Tr \rho^2] \quad (69)$$

We are able to adjust the phase ϕ so as to obtain the largest intensity yielding $|Tr \rho^2|$ and $\phi = \arg Tr \rho^2$. Then we acquire $Tr \rho^2 = |Tr \rho^2| e^{i \arg Tr \rho^2}$. We also obtain $Tr \rho^3$ following similar steps. We can obtain the von Neumann entropy via (61) and (62) for three dimensions. Naturally, we can calculate the von Neumann entropy for d dimensional systems by calculating the trace of the powers of ρ up to d and utilizing the formula given in [12]. So we see that the set up in Figure 7 allows us to measure both the entropy and the product of the visibility and the cosine of the geometric phase.

5 Summary and Conclusions

We have explicitly shown the dependence of entropy on the perimeter, geometric phase and the visibility. For an arbitrary number of states in the two dimensional case, entropy is solely a function of perimeter whereas for three states in three dimensions and more states in higher dimensions, entropy is no longer just a function of perimeter but also of geometric phase and visibility. Finally we have shown a possible way to obtain the von Neumann entropy experimentally. The same experimental interferometric set up can also be used to measure the visibility and geometric phase associated with a set of pure states. This clarifies why physically the two seemingly unrelated concepts of entropy and geometric phase should in fact depend on each other.

Finally, we would like to speculate on the possibility of the geometric phase playing a role in black hole entropy [17]. It is well established that Black hole entropy is proportional to the area of its event horizon. Similarly, in the two dimensional Hilbert space, the geometric phase is given by half the solid angle subtended by states involved. Moreover, we have shown that the entropy in this case is only a function of the geometric phase (modulated by the visibility), and as the phase increases so does the entropy. So, we have the same kind of behaviour as for black holes, namely that the larger the area the larger the entropy. This dependence breaks down in higher dimensions (as we have seen we can increase the phase and decrease the entropy). Of course, the two areas do not live in the same space. The black hole area arises from the physical boundary separating the black hole from the rest of the universe whereas the geometric phase is an area in Hilbert space. A very interesting theme for future research would be to investigate if this fact has any deeper significance and whether it implies that the information in a black hole is made up of basic two dimensional units (qubits) rather than higher dimensional units. Alternatively we can explore the possibility of having states in higher dimensional Hilbert spaces whose contribution to the entropy from the perimeter would be small while dominated by the geometric phase.

Acknowledgements. We would like to thank Arvind for clarifying a few points about his paper, Angelo Carollo, Olaf Dreyer, Damian Markham, Mio Murao, Soonmie Park and Andrei Soklakov for fruitful discussions. We also acknowledge the hospitality of Perimeter Institute where part of the work was completed and the financial support from the Engineering and Physical Sciences Research Council of UK, the European Union and the Elsig S.p.a.

References

- [1] J. v. Neumann. *Mathematical Foundations of Quantum Mechanics*. Princeton University Press, Princeton, 1955.
- [2] A. Shapere and F. Wilczek, editors. *Geometric Phases in Physics*. World Scientific, Singapore, 1989.
- [3] R. Jozsa and J. Schlienz. Distinguishability of states and von neumann entropy. *Phys. Rev. A* **62**, 012301, (2000).
- [4] G. Kimura. The bloch vector for n-level systems. *Phys. Lett. A* **314**, 339 (2003); (quant-ph/0301152).
- [5] M. S. Byrd and N. Khaneja. Characterization of the density matrix in terms of the coherence vector representation. (quant-ph/0302024).
- [6] M. V. Berry. Quantal phase factor accompanying adiabatic changes. *Proc. R. Soc. Lond. A* **392**, 45, (1984).
- [7] S. Pancharatnam. *Proc. Indian Acad. Sci. A* **44**, 247, (1956).
- [8] E. Sjoqvist. Pancharatnam revisited. (quant-ph/0202078).
- [9] Arvind, K. S. Mallesh, and N. Mukunda. A generalized pancharatnam geometric phase formula for three level quantum systems. (quant-ph/9605042).
- [10] A. K. Ekert et. al. Direct estimations of linear and nonlinear functionals of a quantum state. *Phys. Rev. Lett.* **88**, 217901, (2002).
- [11] E. Sjoqvist et. al. Geometric phases for mixed states in interferometry. *Phys. Rev. Lett.* **85**, 2845, (2000).
- [12] S. M. Chumakov, K.-E. Hellwig, and A. B. Klimov. The entropy of open finite-level systems. *Int. J. Theo. Phys.* **37**, 471, (1998).
- [13] E. W. Weisstein. Cubic equation. <http://mathworld.wolfram.com>.
- [14] R. W. D. Nickalls. A new approach to solving the cubic: Cardan's solution revealed. *The Mathematical Gazette* **77**, 354, (1993).
- [15] M. Keyl and R. F. Werner. Estimating the spectrum of a density operator. *Phys. Rev. A* **64**, 052311, (2001).

- [16] V. Vedral. Geometric phases and topological quantum computation. *Int. J. Quant. Inf.* **1**, 1, (2003); (quant-ph/0212133)
- [17] R. M. Wald. The thermodynamics of black holes. (gr-qc/9912119).