

International Journal of Modern Physics C
 © World Scientific Publishing Company

Modeling the Co-occurrence Principles of the Consonant Inventories: A Complex Network Approach

Animesh Mukherjee, Monojit Choudhury, Anupam Basu and Niloy Ganguly

*Department of Computer Science and Engineering
 Indian Institute of Technology, Kharagpur-721302
 {animeshm, monojit, anupam, niloy}@cse.iitkgp.ernet.in*

Received Day Month Year

Revised Day Month Year

Speech sounds of the languages all over the world show remarkable patterns of co-occurrence. In this work, we attempt to automatically capture the patterns of co-occurrence of the consonants across languages and at the same time figure out the nature of the force leading to the emergence of such patterns. For this purpose we define a weighted network where the consonants are the nodes and an edge between two nodes (read consonants) signify their co-occurrence likelihood over the consonant inventories. Through this network we identify communities of consonants that essentially reflect their patterns of co-occurrence across languages. We test the goodness of the communities and observe that the constituent consonants frequently occur in such groups in real languages also. Interestingly, the consonants forming these communities reflect strong correlations in terms of their features, which indicate that the principle of feature economy acts as a driving force towards community formation. In order to measure the strength of this force we propose an information theoretic definition of feature economy and show that indeed the feature economy exhibited by the consonant communities are substantially better than those if the consonant inventories had evolved just by chance.

Keywords: Consonants; complex network; community structure; feature economy; feature entropy.

PACS Nos.: 89.75.-k, 89.75.Fb

1. Introduction

Sound inventories of the world's languages show remarkable regularities. Any randomly chosen set of consonants and vowels does not make up the sound inventory of a particular language. In fact one of the earliest observations about the consonant inventories has been that consonants tend to occur in pairs that exhibit strong correlation in terms of their *features*^a ²⁵. In other words, consonants have a tendency to form groups or communities that effectively reflect their patterns of

^aIn linguistics, features are the elements, which distinguish one phoneme from another. The features that distinguish the phonemes can be broadly categorized into three different classes namely the *manner of articulation*, the *place of articulation* and *phonation*. Manner of articulation specifies how the flow of air takes place in the vocal tract during articulation of a phoneme whereas

Table 1. The table shows four plosives two of which are voiced, and, the other two are voiceless. It also indicates the two different places of articulation (dental and bilabial) for these plosives. If a language has in its consonant inventory any three of the four entries of this table, then there is a higher than average chance that it will also have the fourth entry of the table in its inventory.

plosive	voiced	voiceless
dental	/d/	/t/
bilabial	/b/	/p/

co-occurrence across the languages of the world. In order to explain these trends, *feature economy* was proposed as the basic organizing principle of the consonant inventories^{10,17}. According to this principle, languages tend to maximize the combinatorial possibilities of a few distinctive features to generate a large number of consonants. Stated differently, a given consonant will have a higher than expected frequency in inventories in which all of its features have distinctively occurred in other sounds. The idea is illustrated, with an example, through Table 1. Although there have been several attempts to explain the observed co-occurrence patterns⁷ through linguistic insights³, as far as our knowledge goes there has been no work to identify the communities of consonants algorithmically.

In this work, we propose *a method to automatically capture the patterns of co-occurrence of the consonants across languages* and at the same time *quantify the driving force leading to the emergence of such patterns*. For this purpose, we define the “Phoneme-Phoneme Network” or **PhoNet**, which is a weighted network where the consonants are the nodes and an edge between two nodes (read consonants) signify their co-occurrence likelihood over the consonant inventories. We conduct empirical studies of PhoNet and analyze it from the perspective of a social network where consonants exhibit community structures. Recently, several complex phenomena observed in the social, biological and physical worlds have been modeled as networks, which provides a comprehensive view of their underlying organizational principles. See^{1,18} for a review on modeling and analysis of such networked systems. There have been some attempts as well to model the intricacies of human languages through complex networks. Word networks based on synonymy²⁷, co-occurrence⁴, and phonemic edit-distance²⁶ are examples of such attempts. As a matter of fact, the distribution of the consonants across languages have also been modeled as a complex bipartite network in⁶, but the study is limited to the occurrence of the consonants and not their co-occurrence.

This article is organized as follows: Section 2 formally defines PhoNet and out-

place of articulation specifies the active speech organ and also the place where it acts. Phona-tion describes the activity regarding the vibration of the vocal cords during the articulation of a phoneme.

lines its construction procedure. In section 3 we employ the extended Radicchi et al. ²² algorithm, to find the communities in PhoNet. In section 4 we test the goodness of the communities and observe that the constituent consonants of these communities frequently occur in such groups in real languages also. Interestingly, the consonants forming these communities reflect strong correlations in terms of their features, which points to the fact that feature economy binds these communities. In order to quantify feature economy we propose an information theoretic approach in section 5. In the same section we show that the feature economy exhibited by the consonant communities obtained from PhoNet are indeed substantially better than those, if the consonant inventories had evolved just by chance. We also show that the number of languages in which the consonants of a community occur together increases with increasing feature economy. Finally we conclude in section 6 by summarizing our contributions, pointing out some of the implications of the current work and indicating the possible future directions.

2. PhoNet: The Phoneme-Phoneme Network

We define PhoNet as a network of consonants, represented as $G = \langle V_C, E \rangle$ where V_C is the set of nodes labeled by the consonants and E is the set of edges occurring in PhoNet. There is an edge $e \in E$ between two nodes, if and only if there exists one or more language(s) where the nodes (read consonants) co-occur. The weight of the edge e (also *edge-weight*) is the number of languages in which the consonants connected by e co-occur. The weight of a node u (also *node-weight*) is the number of languages in which the consonant represented by u occurs. In other words, if a consonant c_i represented by the node u occurs in the inventory of n languages then the node-weight of u is assigned the value n . Also if the consonant c_j is represented by the node v and there are w languages in which consonants c_i and c_j occur together then the weight of the edge connecting u and v is assigned the value w . Figure 1 illustrates this structure by reproducing some of the nodes and edges of PhoNet.

2.1. Construction of PhoNet

Many typological studies ^{11,14,15} of segmental inventories have been carried out in past on the UCLA Phonological Segment Inventory Database (UPSID) ¹⁶. UPSID initially had 317 languages and was later extended to include 451 languages covering all the major language families of the world. In this work we have used the older version of UPSID comprising of 317 languages and 541 consonants (henceforth UPSID₃₁₇), for constructing PhoNet. Consequently, the set V_C comprises of 541 elements (nodes) and the set E comprises of 34012 elements (edges). At this point it is important to mention that in order to avoid any confusion in the construction of PhoNet, we have appropriately filtered out the *anomalous* and the *ambiguous* segments ¹⁶ from it. In UPSID, a segment has been classified as anomalous if any of the following conditions holds: the segment is (1) rare (very low frequency), (2) occurs

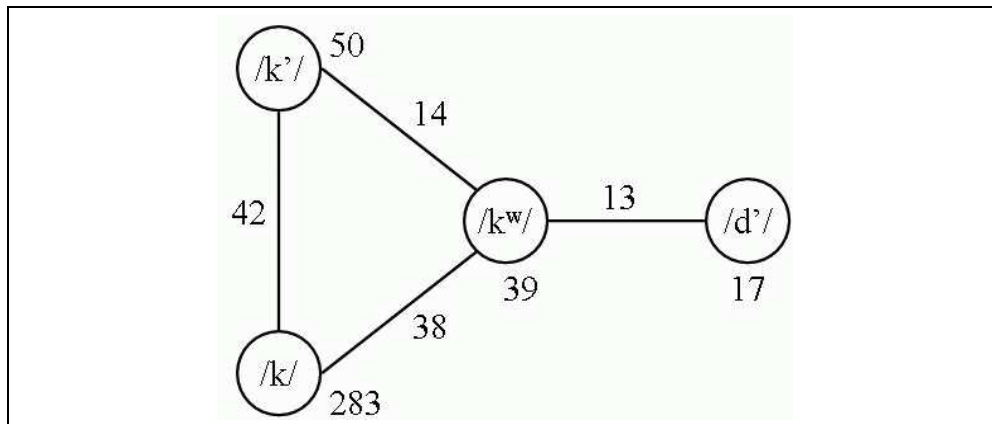

Fig. 1. A partial illustration of the nodes and edges in PhoNet. The labels of the nodes denote the consonants represented in IPA (International Phonetic Alphabet). The numerical values against the edges and nodes represent their corresponding weights. For example $/k/$ occurs in 283 languages; $/k^w/$ occurs in 39 languages while they co-occur in 38 languages.

only in loans, (3) is existent only in underlying forms, (4) is derivable from other segments, or (5) obscure in description. We have completely ignored the anomalous segments from the data set. Ambiguous segments are those for which UPSID provides insufficient information. For example, the presence of both the palatalized dental plosive and the palatalized alveolar plosive are represented in UPSID as palatalized dental-alveolar plosive. In absence of any descriptive sources explaining how such ambiguities might be resolved, we have decided to include them as distinct segments. A similar treatment of anomalous and ambiguous segments has also been described in Pericliev and Valdés-Pérez²⁰. Figure 2 presents a partial illustration of PhoNet as constructed from UPSID₃₁₇.

3. Identification of Community Structures

There is a large volume of literature suggested by computer scientists, physicists as well as sociologists that speaks about identifying communities in a network^{8,12,13,19,21,22}. This is mainly because, the ability to find communities within large networks in some automated fashion could be of considerable use. Communities in a web graph for instance might correspond to sets of web sites dealing with related topics⁸, while communities in a biochemical network might correspond to functional units of some kind¹².

In this work we attempt to identify the communities appearing in PhoNet by extending the Radicchi et al.²² algorithm for weighted networks^b. The algorithm of Radicchi et al. (applied on unweighted networks) counts, for each edge, the number

^bWe have tried a few other community finding algorithms but this algorithm performs slightly better. Moreover, we found it easier to extend this algorithm to weighted networks.

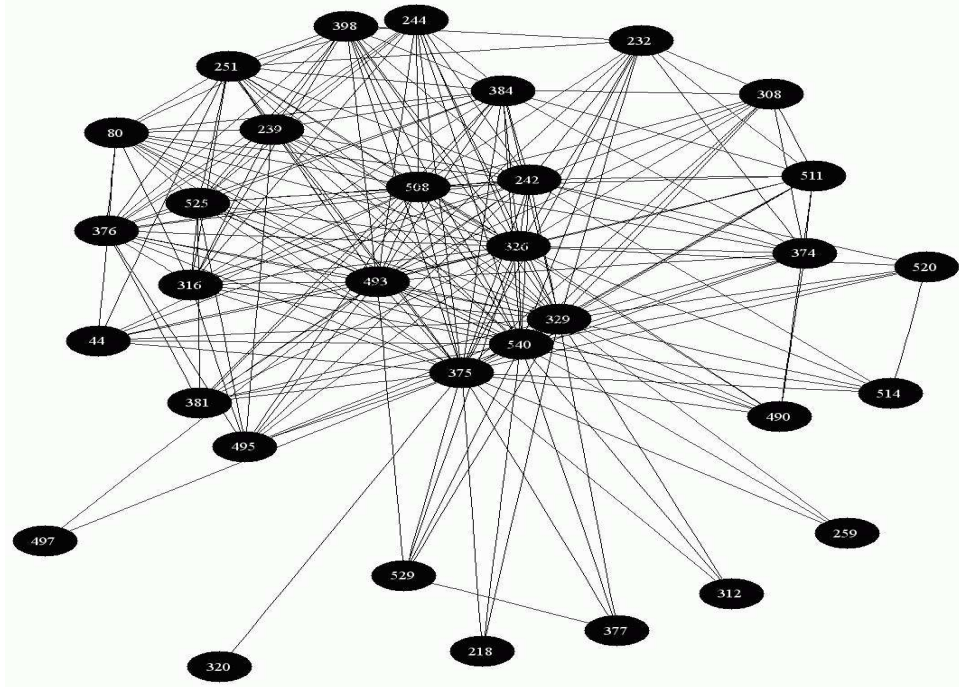

Fig. 2. A partial illustration of PhoNet. All edges in this figure have an edge-weight greater than or equal to 50. The number on each node corresponds to a particular consonant. For instance, node number 508 corresponds to /g/ whereas node number 540 represents /k/.

of loops of length three it is a part of and declares that edges with very low counts as inter-community edges.

Basis: Edges that run between communities are unlikely to belong to many short loops, because to complete a loop containing such an edge there needs to be another edge that runs between the same two communities, and such other edges are rare.

Modification for Weighted Network: Nevertheless, for weighted networks, rather than considering simply the triangles (loops of length three) we need to consider the weights on the edges forming these triangles. The basic idea is that if the weights on the edges forming a triangle are comparable then the group of consonants represented by this triangle highly occur together rendering a pattern of co-occurrence while if these weights are not comparable then there is no such pattern. In order to capture this property we define a strength metric S for each of the edges of PhoNet as follows. Let the weight of the edge (u,v) , where $u, v \in V_C$, be denoted by w_{uv} . We define S as,

$$S = \frac{w_{uv}}{\sqrt{\sum_{i \in V_C - \{u,v\}} (w_{ui} - w_{vi})^2}} \quad (1)$$

if $\sqrt{\sum_{i \in V_C - \{u,v\}} (w_{ui} - w_{vi})^2} > 0$ else $S = \infty$. The denominator in this expression essentially tries to capture whether or not the weights on the edges forming triangles are comparable. If the weights are not comparable then this denominator will be high, thus reducing the overall value of S . PhoNet may be then partitioned into clusters or communities by removing edges that have S close to zero.

In this algorithm we have neglected the edges in PhoNet that are connected to nodes having very low or very high node-weights since they are either insignificant^c or assortative^d (see 18 for a reference) respectively. Henceforth we will refer to this version of PhoNet as PhoNet_{red}. The entire idea is summarized in Algorithm 1. Figure 3 illustrates the clustering process. We can obtain different sets of communities by varying the threshold η . As the value of η decreases, new nodes keep joining the communities and the process is similar to hierarchical clustering²³. Figure 4 shows a dendrogram, which illustrates the formation of the community of the consonants /d/, /t/, /n/, /l/ and /ɹ/ with the change in the value of η .

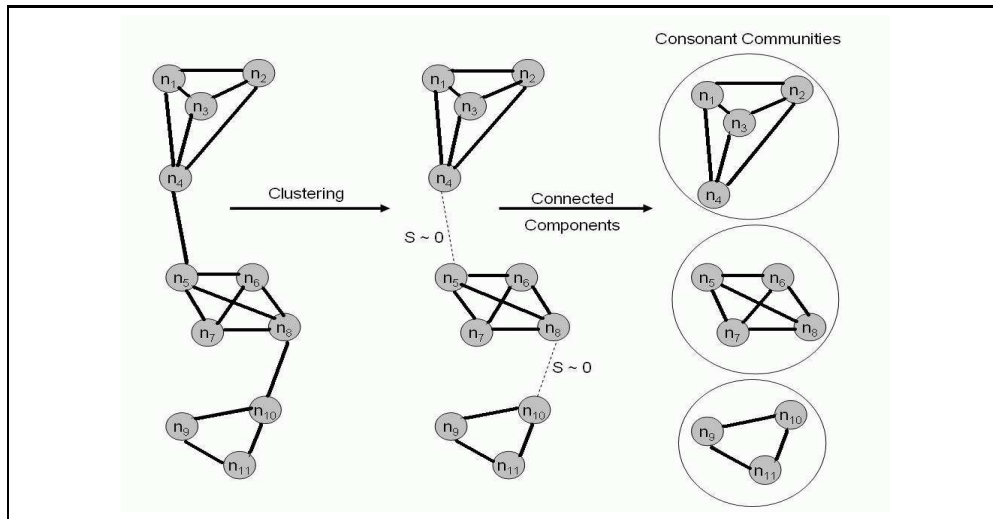

Fig. 3. The process of community formation

^cWe have neglected nodes with node-weight less than 5 since these nodes correspond to consonants that occur in less than 5 languages in UPSID₃₁₇ and the communities they form are therefore statistically insignificant.

^dWe have neglected nodes with node-weight greater than 130. These nodes correspond to consonants that occur in more than 130 languages in UPSID₃₁₇ and therefore they co-occur with almost every other consonant. Hence the strength metric S is likely to be high for an edge connecting nodes (read consonants) with high node-weights. This edge (owing to its high strength) might then force two otherwise disjoint communities to form a single community. For instance, we have observed that since the consonants /m/ and /k/ are very frequent, the nodes corresponding to both of them have a high node-weight and consequently the edge between them also has a high edge-weight. The strong link between /m/ and /k/ then forces the respective bilabial and velar communities to merge into a single community.

```

Input: PhoNetred
repeat
  for each edge (u,v) do
    Compute
    
$$S = \frac{w_{uv}}{\sqrt{\sum_{i \in V_G - \{u,v\}} (w_{ui} - w_{vi})^2}}$$

    if  $\sqrt{\sum_{i \in V_G - \{u,v\}} (w_{ui} - w_{vi})^2} > 0$  else  $S = \infty$ ;
  end
  Redefine the edge-weight for each edge (u,v) by S;
  Remove edges with edge-weights less than or equal to a threshold  $\eta$ ;
  Call this new version of PhoNet, PhoNet $\eta$ ;
  Find the connected components in PhoNet $\eta$ ;
   $\eta = \frac{\eta}{\delta}$  where  $\delta$  is the diminishing factor;
until PhoNet $\eta$  gets fully connected ;

```

Algorithm 1: Algorithm for finding communities based on edge strength

Table 2. Consonant communities

Community	Features in Common
/t/, /d/, /n/	dental
/d/, /t/, /n/, /l/, /ɹ/	retroflex
/w/, /j/, /m/	laryngealized

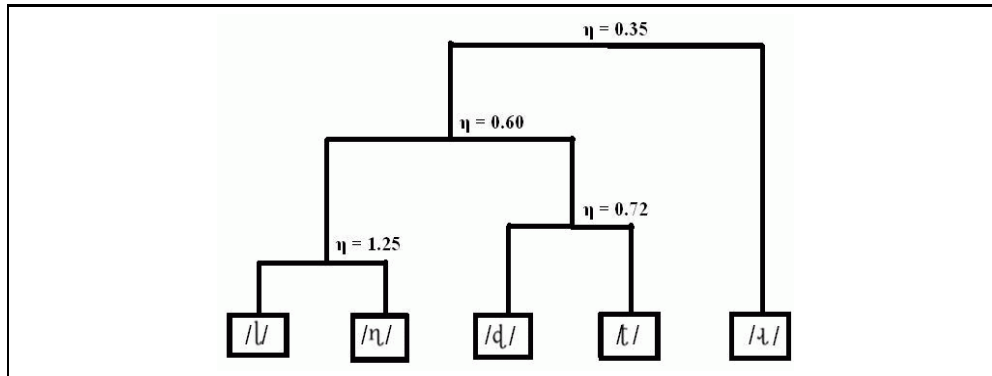

Fig. 4. The dendrogram illustrates how the retroflex community of /d/, /t/, /r/, /l/ and /ɹ/ is formed with the change in the value of η

Some of the example communities obtained from our algorithm are noted in Table 2. In this table, the consonants in the first community are dentals, those in the second community are retroflexes, while the ones in the third are all laryngealized.

4. Evaluation of the Communities based on their Occurrence in Languages

In the earlier section we have mainly described the methods of extracting the consonant communities from PhoNet. In this section we look into the languages included in UPSID₃₁₇ and inspect whether or not the consonants forming the communities in PhoNet actually occur in such groups.

For this purpose we first arrange the consonants forming a community C , of size N , in an ascending order of their frequency of occurrence in UPSID₃₁₇. We associate a rank R with each of the consonants in C where the least frequency consonant gets a rank $R = 1$, the second least gets a rank $R = 2$ and so on. Starting from rank $R = 1$ we count how many of the consonants in C , occur in a language $L \in \text{UPSID}_{317}$. Let the number of such consonants be M . We define the *occurrence ratio* O_L of the community C for the language L to be

$$O_L = \frac{M}{N - (R_{top} - 1)} \quad (2)$$

where R_{top} is the rank of the highest ranking consonant that is found in L . The denominator of this ratio is $N - (R_{top} - 1)$ instead of N since it is not mandatory for a language to have a low frequency member of a community if it has the high frequency member; nevertheless if the language already has the low frequency member of the community then it is highly expected to also have the high frequency member^e 7. The average occurrence ratio O_{av} for the community C can be obtained as follows,

$$O_{av} = \frac{\sum_{L \in \text{UPSID}_{317}} O_L}{L_{occur}} \quad (3)$$

where L_{occur} is the number of languages in UPSID₃₁₇ that have at least one or more consonants occurring in C . Figure 5 shows the average O_{av} of the communities obtained at a particular threshold η versus the threshold η . The curve clearly shows that the average O_{av} of the communities obtained from our algorithm for $\eta > 0.3$ is always more than 0.8. This in turn implies that on an average the communities, obtained at thresholds above 0.3, occur in more than 80%^f of the languages in UPSID₃₁₇. At thresholds below 0.3 the average O_{av} falls gradually since giant components start forming and the probability of all the consonants in the giant component occurring together in languages is very low. Hence the community structures obtained from our algorithm are true representatives of the patterns of co-occurrence of the consonants across languages.

^eFor instance let the community C be formed of the consonants $/k^w/$, $/k^h/$ and $/k/$ as shown in Figure 1. When we inspect the language L it is not necessary for it to have $/k^w/$ or $/k^h/$ if it has $/k/$ in its inventory; nevertheless it is highly expected that if it already has $/k^w/$, it should also have $/k/$ and $/k^h/$ in its inventory.

^fThe expectation that a randomly chosen set of consonants representing a community of size between 2 to 5, occurs in a language, is 70% whereas the same is 89% for the communities observed in PhoNet.

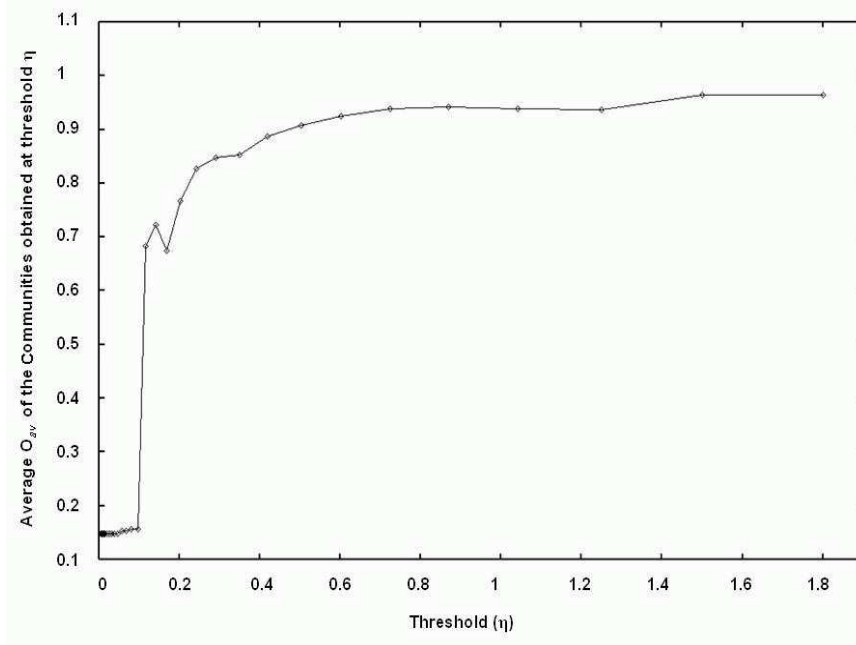

Fig. 5. Average O_{av} of the communities obtained at a particular threshold η versus the threshold η

5. Feature Economy: The Binding Force of the Communities

In the earlier sections we have mainly focused ourselves to the detection and evaluation of the communities emerging from PhoNet. In this section we attempt to explore whether or not the driving force, which leads to the emergence of these communities, is feature economy. For this reason we introduce a quantitative measure of feature economy. The basic idea is borrowed from the concept of entropy in information theory ²⁴.

For a community C of size N let there be p_f consonants, which have a particular feature f (where f is assumed to be boolean in nature) in common and q_f other consonants, which lack the feature f . Thus the probability that a particular consonant chosen uniformly at random from C has the feature f is $\frac{p_f}{N}$ and the probability that the consonant lacks the feature f is $\frac{q_f}{N}$ ($=1 - \frac{p_f}{N}$). If F be the set of all features present in the consonants in C then *feature entropy* F_E can be defined as

$$F_E = \sum_{f \in F} \left(-\frac{p_f}{N} \log \frac{p_f}{N} - \frac{q_f}{N} \log \frac{q_f}{N} \right) \quad (4)$$

The process of computing the values of F_E for two different communities of consonants is illustrated in Figure 6.

F_E is essentially the measure of the minimum number of bits that are required to communicate the information about the entire community C through a channel.

$C_1 = \{/bl, /dl, /gl\}$ $N_1 = 3$ $F_1 = \{\text{voiced, dental, bilabial, velar, plosive}\}$						$C_2 = \{/bl, /nl, /ql\}$ $N_2 = 3$ $F_2 = \{\text{voiced, dental, bilabial, nasal, retroflex, plosive}\}$						
F_1	voiced	dental	bilabial	velar	plosive	F_2	voiced	dental	bilabial	nasal	retroflex	plosive
$/bl$	1	0	1	0	1	$/bl$	1	0	1	0	0	1
$/dl$	1	1	0	0	1	$/nl$	1	1	0	1	0	0
$/gl$	1	0	0	1	1	$/ql$	1	1	0	0	1	0
p/N_1	1	0.33	0.33	0.33	1	p/N_2	1	0.67	0.33	0.33	0.33	0.33
q/N_1	0	0.67	0.67	0.67	0	q/N_2	0	0.33	0.67	0.67	0.67	0.67
$F_{E_1} = 2.75$						$F_{E_2} = 4.58$						

Fig. 6. The process of computing the value of F_E for the two different communities C_1 and C_2

Thus, the lower the value of F_E , the better it is in terms of information transmission overhead. To have more information conveyed using a fewer number of bits, maximization of the combinatorial possibilities of the features used by the constituent consonants in the community C is needed. This is precisely the prediction made by the principle of feature economy^g. In fact, it is due to this reason that in Figure 6, F_E exhibited by the community C_1 is better than that of the community C_2 , since in C_1 the combinatorial possibilities of the features is better utilized by the consonants than in C_2 .

Figure 7 illustrates, for all the communities obtained from the clustering of PhoNet, the average feature entropy exhibited by the communities of a particular size^h (y-axis), versus the community size in log scale (x-axis).

We next investigate whether or not the communities obtained from PhoNet are better in terms of feature entropy than they would have been, if the consonant inventories had evolved just by chance. For this purpose we construct a random version of PhoNet and call it PhoNet_{rand}.

Construction of PhoNet_{rand}: For each consonant c let the frequency of occurrence in UPSID₃₁₇ be denoted by f_c . Let there be 317 bins each corresponding to a language in UPSID₃₁₇. f_c bins are then chosen uniformly at random and the consonant c is packed into these bins. Thus the consonant inventories of the 317 languages corresponding to the bins are generated. PhoNet_{rand} can be then constructed from

^gThe lower the feature entropy the higher is the feature economy.

^hLet there be n communities of a particular size k picked up at various thresholds. The average feature entropy of the communities of size k is therefore $\frac{1}{n} \sum_{i=1}^n F_{E_i}$ where F_{E_i} signifies the feature entropy of the i^{th} community.

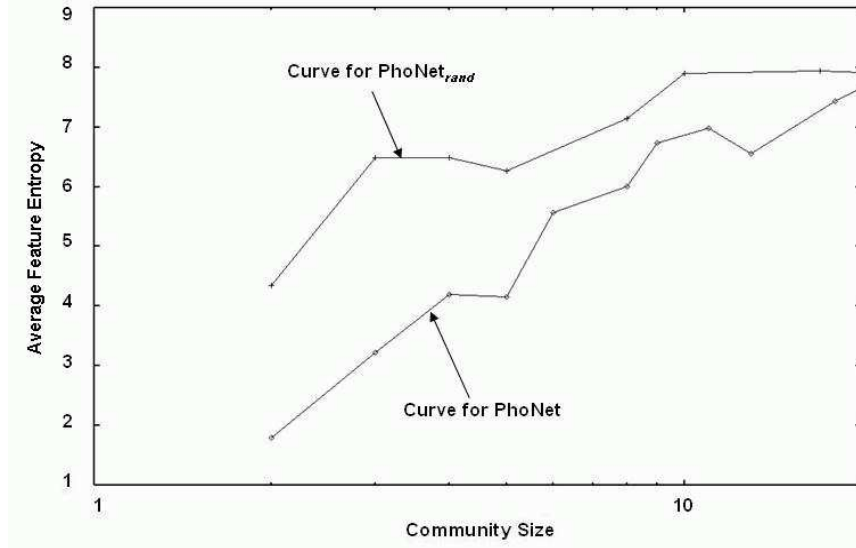

Fig. 7. Curves showing average feature entropy of the communities of a particular size versus the community size (in log scale) for PhoNet and $PhoNet_{rand}$.

these new consonant inventories similarly as PhoNet. The method is summarized in Algorithm 2.

```

for each consonant  $c$  do
  for  $i = 1$  to  $f_c$  do
    Choose one of the 317 bins, corresponding to the languages in
    UPSID317, uniformly at random;
    Pack the consonant  $c$  into the bin so chosen if it has not been already
    packed into this bin earlier;
  end
end

Construct  $PhoNet_{rand}$ , similarly as PhoNet, from the new consonant
inventories (each bin corresponds to a new inventory);

```

Algorithm 2: Algorithm to construct $PhoNet_{rand}$

We apply Algorithm 1 in order to find the communities appearing in $PhoNet_{rand}$. The average feature entropy for the communities of a particular size (y-axis), versus the community size in log scale (x-axis) are shown in Figure 7 (along with the curve for PhoNet). A closer inspection of the curves immediately makes it clear that the average feature entropy exhibited by the communities of PhoNet are substantially better than that of $PhoNet_{rand}$ especially when the community size remains less

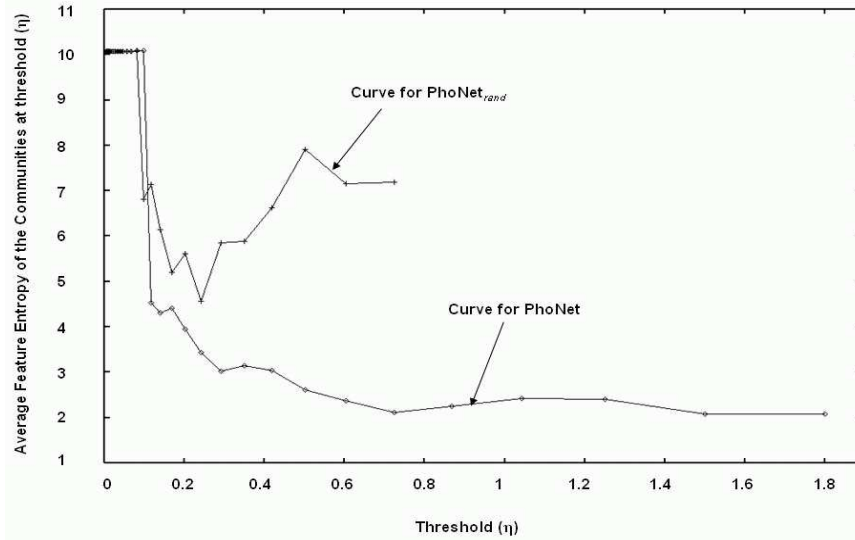

Fig. 8. Average feature entropy of the communities obtained at threshold η versus the threshold η for both PhoNet and PhoNet_{rand}

than 15. As this size increases, the difference in the average feature entropy of the communities of PhoNet and PhoNet_{rand} gradually diminishes. This is because, the community then comprises of almost all the nodes of PhoNet which are also the nodes of PhoNet_{rand}. Hence the average feature entropy exhibited by the respective giant components of PhoNet and PhoNet_{rand} is close and this closeness increases with the increase in the size of the giant component.

Figure 8 (showing the average feature entropy of the communities for different values of η in the y-axis versus the threshold η in the x-axis) further strengthens the fact that feature entropy exhibited by the communities occurring in PhoNet are substantially better than those occurring in PhoNet_{rand}. It clearly shows that the average feature entropy of the communities, obtained at all thresholds greater than 0.2, are significantly lower in case of PhoNet than in PhoNet_{rand}. Below this threshold, gradually the average feature entropy of the communities of PhoNet and PhoNet_{rand} come closer, until they are identical. Another important observation is that the communities of PhoNet_{rand} do not emerge at thresholds greater than 0.8. This points to the fact that strong patterns of co-occurrence would not have surfaced if the consonant inventories had just evolved by chance.

The above results not only validate our definition of feature entropy but is also indicative of the fact that the community structures observed in PhoNet are not arbitrary and are true representatives of feature economy claimed to be observed across languages. In fact, the argument can be further validated by looking into the languages recorded in UPSID₃₁₇ and examining whether or not the consonants forming the communities in PhoNet occur in these languages so as to minimize

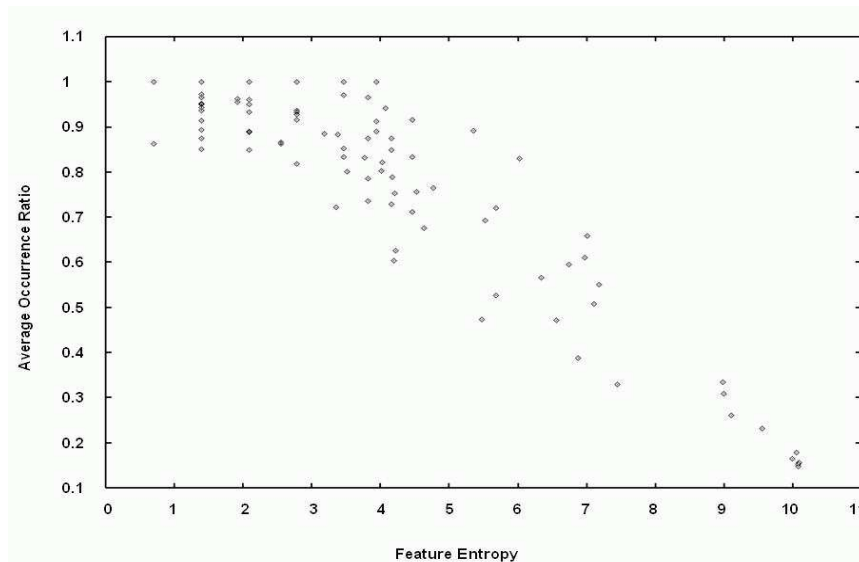

Fig. 9. Average occurrence ratio (O_{av}) versus the feature entropy of the communities. Each point corresponds to a single community

feature entropy.

Figure 9 shows the scatter plot of the average occurrence ratio of the communities obtained from PhoNet (y-axis) versus the feature entropy of these communities (x-axis). Each point in this plot corresponds to a single community. The plot clearly indicates that the communities exhibiting lower feature entropy have a higher average occurrence ratio. For communities having feature entropy less than or equal to 3 the average occurrence ratio is never less than 0.7 which means that the consonants forming these communities occur together on an average in 70% or more of the world's languages. As feature entropy increases this ratio gradually decreases until it is almost close to 0 when feature entropy is around 10. This again attests the fact that the driving force behind the formation of these communities is the principle of feature economy and languages indeed tend to choose consonants in order to maximize the use of the distinctive features, which are already available in their inventory.

6. Conclusions and Discussions

In this paper we have explored the co-occurrence principles of the consonants, across the inventories of the world's languages. Firstly, we have presented an automatic procedure to capture the co-occurrence patterns of the consonants across languages. It is important to mention here that this automation also provides an algorithmic definition of *natural classes*⁵ of phonemes (Table 1 is a natural class of plosives). This is significant because there is no single satisfactory definition of such natural classes in literature⁹. The communities that we obtained from PhoNet are such

natural classes and we can derive them just by regulating the threshold of our algorithm.

Secondly, in order to quantify feature economy we have introduced the notion of feature entropy. This quantification immediately allows us to validate the explanation of the organizational principles of the sound inventories in terms of feature economy, provided by the earlier researchers.

Some of our important findings from this work are,

- The patterns of co-occurrence of the consonants, reflected through communities in PhoNet, are observed in 80% or more of the world's languages;
- Such patterns of co-occurrence would not have emerged if the consonant inventories had evolved just by chance;
- The consonant communities that maximize feature economy tend to occur more frequently (70% or higher number of times) in the languages of the world.

Until now we have emphasized on the fact that feature economy is the driving force behind the formation of consonant communities. An issue which draws attention is that how such a force might have originated. One possible reason could be due to certain general principles like *maximal perceptual contrast*¹⁵ and *articulatory ease*^{2,15} and *ease of learnability*². For instance, maximal perceptual contrast, which is desirable between the phonemes of a language for proper perception of each individual phoneme in a noisy environment, would try to reduce feature economy (since better perception calls for use of a larger number of distinctive features). On the other hand, ease of learnability, which is required so that a speaker can learn a language with minimum effort, tries to increase feature economy (since learnability increases if there are only a few distinctive features to be learnt). It would be interesting to see how the quantification of feature economy can help us in understanding the interplay, between these principles, that goes on in shaping the structure of the consonant inventories. We look forward to do the same as a part of our future work.

References

1. R. Albert and A.-L. Barabási. 2002. Statistical mechanics of complex networks. *Reviews of Modern Physics* 74, 47–97.
2. Bart de Boer. 2000. Self-organisation in Vowel Systems. *Journal of Phonetics*, 28(4), 441–465.
3. P. Boersma. 1998. *Functional Phonology. (Doctoral thesis, University of Amsterdam)*, The Hague: Holland Academic Graphics.
4. R. Ferrer i Cancho and R. V. Solé. 2001. Santa Fe working paper 01-03-016.
5. N. Chomsky and M. Halle. 1968. *The Sound Pattern of English*, New York: Harper and Row.
6. M. Choudhury, A. Mukherjee, A. Basu, and N. Ganguly. 2006. Analysis and Synthesis of the Distribution of Consonants over Languages: A Complex Network Approach. *Proceedings of COLING-ACL*, Sydney, Australia.

7. N. Clements. 2004. Features and Sound Inventories. *Symposium on Phonological Theory: Representations and Architecture*, CUNY.
8. G. W. Flake, S. R. Lawrence, C. L. Giles, and F. M. Coetzee. 2002. Self-organization and Identification of Web communities. *IEEE Computer*, 35, 66–71.
9. E. Flemming. 2005. Deriving Natural Classes in Phonology. *Lingua*, 115(3), 287–309.
10. A.W. de Groot. 1931. Phonologie und Phonetik als Funktionswissenschaften. *Travaux du Cercle Linguistique de Prague* 4, 116–147.
11. F. Hinskens and J. Weijer. 2003. Patterns of Segmental Modification in Consonant Inventories: A Cross-linguistic Study. *Linguistics*, 41, 6.
12. P. Holme, M. Huss, and H. Jeong. 2003. Subnetwork Hierarchies of Biochemical Pathways. *Bioinformatics* 19, 532–538.
13. B. W. Kernighan and S. Lin. 1970. An Efficient Heuristic Procedure for Partitioning Graphs. *Bell System Technical Journal*, 49, 291–307.
14. P. Ladefoged and I. Maddieson. 1996. *Sounds of the Worlds Languages*, Oxford: Blackwell.
15. B. Lindblom and I. Maddieson. 1988. Phonetic Universals in Consonant Systems. In L.M. Hyman and C.N. Li, eds., *Language, Speech, and Mind*, Routledge, London, 62–78.
16. I. Maddieson. 1984. *Patterns of Sounds*, Cambridge University Press, Cambridge.
17. A. Martinet 1955. *Économie des Changements Phonétiques*, Berne: A. Francke.
18. M. E. J. Newman. 2003. The Structure and Function of Complex Networks. *SIAM Review* 45, 167–256.
19. M. E. J. Newman and M. Girvan. 2004. Finding and Evaluating Community Structure in Networks. *Phys. Rev. E* 69, 026113.
20. V. Pericliev and R. E. Valdés-Pérez. 2002. Differentiating 451 Languages in Terms of their Segment Inventories. *Studia Linguistica*, 56(1), 1–27.
21. A. Pothen, H. Simon, and K.-P. Liou. 1990. Partitioning Sparse Matrices With Eigenvectors of Graphs. *SIAM J. Matrix Anal. Appl.*, 11, 430–452.
22. F. Radicchi, C. Castellano, F. Cecconi, V. Loreto, and D. Parisi. 2003. Defining and Identifying Communities in Networks. *PNAS*, 101(9), 2658–2663.
23. J. Scott. 2000. *Social Network Analysis: A Handbook*, Sage, London, 2nd edition.
24. C. E. Shannon and W. Weaver. 1949. *The Mathematical Theory of Information*, Urbana: University of Illinois Press.
25. N. Trubetzkoy. 1930. Die Phonologische Systeme. *TCLP*, 4, 96–116.
26. M. S. Vitevitch. 2005. Phonological neighbors in a small world: What can graph theory tell us about word learning? *Spring 2005 Talk Series on Networks and Complex Systems*, Indiana University, Bloomington.
27. S. Yook, H. Jeong and A.-L. Barabási. 2001b. preprint.