

# Measurement of the sensitivity function in time-domain atomic interferometer

P. Cheinet, B. Canuel, F. Pereira Dos Santos, A. Gauguet, F. Leduc, A. Landragin

## Abstract

We present here an analysis of the sensitivity of a time-domain atomic interferometer to the phase noise of the lasers used to manipulate the atomic wave-packets. The sensitivity function is calculated in the case of a three pulse Mach-Zehnder interferometer, which is the configuration of the two inertial sensors we are building at BNM-SYRTE. We successfully compare this calculation to experimental measurements. The sensitivity of the interferometer is limited by the phase noise of the lasers, as well as by residual vibrations. We evaluate the performance that could be obtained with state of the art quartz oscillators, as well as the impact of the residual phase noise of the phase-lock loop. Requirements on the level of vibrations is derived from the same formalism.

## Index Terms

Atom interferometry, Cold atoms, Sensitivity function, Stimulated Raman transition

## I. INTRODUCTION

ATOM optics is a mean to realize precision measurements in various fields. Atomic microwave clocks are the most precise realization of a SI unit, the second [1], and high sensitivity inertial sensors [2], [3], [4], based on atomic interferometry [5], already reveal accuracies comparable with state of the art sensors [6], [7]. Two cold atom inertial sensors are currently under construction at BNM-SYRTE, a gyroscope [8] which already reaches a sensitivity of  $2.5 \times 10^{-6} \text{ rad.s}^{-1}.\text{Hz}^{-1/2}$ , and an absolute gravimeter [9] which will be used in the BNM Watt Balance project [10]. Although based on different atoms and geometries, the atomic gyroscope and gravimeter rely on the same principle, which is presented in figure 1. Atoms are collected in a three dimensional magneto-optical trap (3D-MOT) in which the atoms are cooled down to a few  $\mu\text{K}$ . In the gyroscope,  $^{133}\text{Cs}$  atoms are launched upwards with an angle of  $8^\circ$  with respect to verticality using the technic of moving molasses, whereas in the gravimeter,  $^{87}\text{Rb}$  atoms are simply let to fall. Then the initial quantum state is prepared by a combination of microwave and optical pulses. The manipulation of the atoms is realized by stimulated Raman transition pulses [11], using two counter-propagating lasers, which drive coherent transitions between the two hyperfine levels of the alkali atom. Three laser pulses, of durations  $\tau_R - 2\tau_R - \tau_R$ , separated in time by  $T$ , respectively split, redirect and recombine the atomic wave-packets, creating an atomic interferometer [12]. Finally, a fluorescence detection gives a measurement of the transition probability from one hyperfine level to the other, which is given by  $P = \frac{1}{2}(1 - \cos(\Phi))$ ,  $\Phi$  being the interferometric phase. The phase difference between the two Raman lasers (which we will call the Raman phase throughout this article, and denote  $\phi$ ) is printed at each pulse on the phase of the atomic

P. Cheinet, B. Canuel, F. Pereira Dos Santos, A. Gauguet, F. Leduc and A. Landragin are with Laboratoire BNM-SYRTE, 75014 Paris, France (e-mail: patrick.cheinet@obspm.fr)

wave function [13]. As  $\phi$  depends on the position of the atoms, the interferometer is sensitive to inertial forces, and can thus measure rotation rates and accelerations. A drawback of this technic is that the measurement of the interferometric phase is affected by the phase noise of the Raman lasers, as well as parasitic vibrations. The aim of this article is to investigate both theoretically and experimentally how these noise sources limit the sensitivity of such an atomic interferometer.

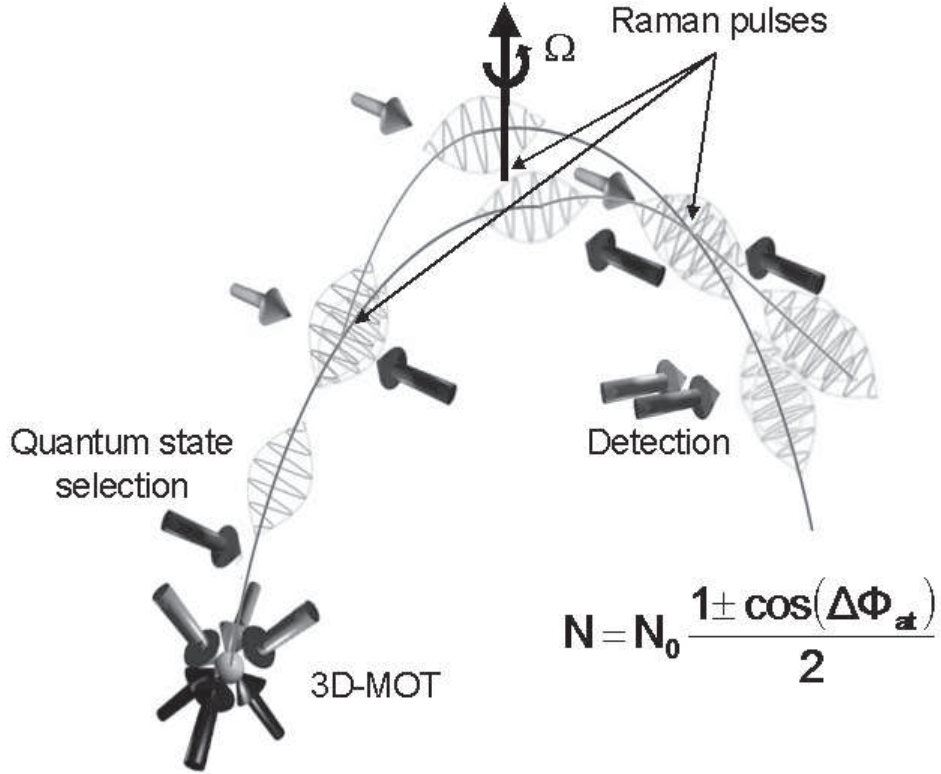

Fig. 1

SCHEME OF PRINCIPLE OF OUR INERTIAL SENSORS, ILLUSTRATED FOR THE GYROSCOPE EXPERIMENT.

COLD ATOMS FROM THE 3D-MOT ARE LAUNCHED UPWARDS AND A PURE QUANTUM STATE IS SELECTED. AT THE TOP OF THEIR TRAJECTORY, WE APPLY THREE RAMAN LASER PULSES REALIZING THE INTERFEROMETER. FINALLY A FLUORESCENCE DETECTION ALLOWS TO MEASURE THE TRANSITION PROBABILITY. SUCH AN INTERFEROMETER IS SENSITIVE TO THE ROTATION ( $\Omega$ ) PERPENDICULAR TO THE AREA ENCLOSED BETWEEN THE TWO ARMS AND TO THE ACCELERATION ALONG THE LASER'S AXIS.

## II. SENSITIVITY FUNCTION

The sensitivity function is a natural tool to characterize the influence of the fluctuations in the Raman phase  $\phi$  on the transition probability [14], and thus on the interferometric phase. Let's assume a phase jump  $\delta\phi$  occurs on the Raman phase  $\phi$  at time  $t$  during the interferometer sequence, inducing a change of  $\delta P(\delta\phi, t)$  in the transition probability. The

sensitivity function is then defined by :

$$g(t) = 2 \lim_{\delta\phi \rightarrow 0} \frac{\delta P(\delta\phi, t)}{\delta\phi}. \quad (1)$$

The sensitivity function can easily be calculated for infinitesimally short Raman pulses. In this case, the interferometric phase  $\Phi$  can be deduced from the Raman phases  $\phi_1, \phi_2, \phi_3$  during the three laser interactions, taken at the position of the center of the atomic wavepacket:  $\Phi = \phi_1 - 2\phi_2 + \phi_3$  [15]. Usually, the interferometer is operated at  $\Phi = \pi/2$ , for which the transition probability is  $1/2$ , to get the highest sensitivity to interferometric phase fluctuations. If the phase step  $\delta\phi$  occurs for instance between the first and the second pulses, the interferometric phase changes by  $\delta\Phi = -\delta\phi$ , and the transition probability by  $\delta P = -\cos(\pi/2 + \delta\Phi)/2 \sim -\delta\phi/2$  in the limit of an infinitesimal phase step. Thus, in between the first two pulses, the sensitivity function is  $-1$ . The same way, one finds for the sensitivity function between the last two pulses :  $+1$ .

In the general case of finite duration Raman laser pulses, the sensitivity function depends on the evolution of the atomic state during the pulses. In order to calculate  $g(t)$ , we make several assumptions. First, the laser waves are considered as pure plane waves. The atomic motion is then quantized in the direction parallel to the laser beams. Second, we restrict our calculation to the case of a constant Rabi frequency (square pulses). Third, we assume the resonance condition is fulfilled. The Raman interaction then couples the two states  $|a\rangle = |g_1, \vec{p}\rangle$  and  $|b\rangle = |g_2, \vec{p} + \hbar \vec{k}_{eff}\rangle$  where  $|g_1\rangle$  and  $|g_2\rangle$  are the two hyperfine levels of the ground state,  $\vec{p}$  is the atomic momentum,  $\vec{k}_{eff}$  is the difference between the wave vectors of the two lasers.

We develop the atomic wave function on the basis set  $\{|a\rangle, |b\rangle\}$  so that  $|\Psi(t)\rangle = C_a(t)|a\rangle + C_b(t)|b\rangle$ , and choose the initial state to be  $|\Psi(t_i)\rangle = |\Psi_i\rangle = |a\rangle$ . At the output of the interferometer, the transition probability is given by  $P = |C_b(t_f)|^2$ , where  $t_f = t_i + 2T + 4\tau_R$ . The evolution of  $C_a$  and  $C_b$  from  $t_i$  to  $t_f$  is given by

$$\begin{pmatrix} C_a(t_f) \\ C_b(t_f) \end{pmatrix} = M \begin{pmatrix} C_a(t_i) \\ C_b(t_i) \end{pmatrix} \quad (2)$$

where  $M$  is the evolution matrix through the whole interferometer. Solving the Schrödinger equation gives the evolution matrix during a Raman pulse [16], from time  $t_0$  to time  $t$ :

$$M_p(t_0, t, \Omega_R, \phi) = \begin{pmatrix} e^{-i\omega_a(t-t_0)} \cos(\frac{\Omega_R}{2}(t-t_0)) & -ie^{-i\omega_a(t-t_0)} e^{i(\omega_L t_0 + \phi)} \sin(\frac{\Omega_R}{2}(t-t_0)) \\ -ie^{-i\omega_b(t-t_0)} e^{-i(\omega_L t_0 + \phi)} \sin(\frac{\Omega_R}{2}(t-t_0)) & e^{-i\omega_b(t-t_0)} \cos(\frac{\Omega_R}{2}(t-t_0)) \end{pmatrix} \quad (3)$$

where  $\Omega_R/2\pi$  is the Rabi frequency and  $\omega_L$ , the effective frequency, is the frequency difference between the two lasers,  $\omega_L = \omega_2 - \omega_1$ . Setting  $\Omega_R = 0$  in  $M_p(t_0, t, \Omega_R, \phi)$  gives the free evolution matrix, which determines the evolution between the pulses. The evolution matrix for the full evolution is obtained by taking the product of several matrices. When  $t$  occurs during the  $i$ -th laser pulse, we split the evolution matrix of this pulse at time  $t$  into two successive matrices, the first one with  $\phi_i$ , and the second one with  $\phi = \phi_i + \delta\phi$ .

Finally, we choose the time origin at the middle of the second Raman pulse. We thus have  $t_i = -(T + 2\tau_R)$  and  $t_f = T + 2\tau_R$ . We then calculate the change in the transition probability for a infinitesimally small phase jump at any time  $t$  during the interferometer, and deduce  $g(t)$ . It is an odd function, whose expression is given here for  $t > 0$ :

$$g(t) = \begin{cases} \sin(\Omega_R t) & 0 < t < \tau_R \\ 1 & \tau_R < t < T + \tau_R \\ -\sin(\Omega_R(T - t)) & T + \tau_R < t < T + 2\tau_R \end{cases} \quad (4)$$

When the phase jump occurs outside the interferometer, the change in the transition probability is null, so that  $g(t) = 0$  for  $|t| > T + 2\tau_R$ .

In order to validate this calculation, we use the gyroscope experiment to measure experimentally the sensitivity function. About  $10^8$  atoms from a background vapor are loaded in a 3D-MOT within 125 ms, with 6 laser beams tuned to the red of the  $F = 4 \rightarrow F' = 5$  transition at 852 nm. The atoms are then launched upwards at  $\sim 2.4$  m/s within 1 ms, and cooled down to an effective temperature of  $\sim 2.4\mu\text{K}$ . After launch, the atoms are prepared into the  $|F = 3, m_F = 0\rangle$  state using a combination of microwave and laser pulses : they first enter a selection cavity tuned to the  $|F = 4, m_F = 0\rangle \rightarrow |F = 3, m_F = 0\rangle$  transition. The atoms left in the  $F = 4$  state are pushed away by a laser beam tuned to the  $F = 4 \rightarrow F' = 5$  transition, 11 cm above the selection cavity. The selected atoms then reach the apogee 245 ms after the launch, where they experience three interferometer pulses of duration  $\tau_R - 2\tau_R - \tau_R$  with  $\tau_R = 20 \mu\text{s}$  separated in time by  $T = 4.97$  ms. The number of atoms  $N_{F=3}$  and  $N_{F=4}$  are finally measured by detecting the fluorescence induced by a pair of laser beams located 7 cm below the apogee. From these measurements, we deduce the transition probability  $N_{F=4}/(N_{F=3} + N_{F=4})$ . The total number of detected atoms is about  $10^5$ . The repetition rate of the experiment is 2 Hz.

The set-up for the generation of the two Raman laser beams is displayed in figure 2. Two slave diode lasers of 150 mW output power are injected with extended cavity diode lasers. The polarizations of the slave diodes output beams are made orthogonal so that the two beams can be combined onto a polarization beam splitter cube. The light at this cube is then split in two distinct unbalanced paths.

On the first path, most of the power of each beam is sent through an optical fiber to the vacuum chamber. The two beams are then collimated with an objective attached onto the chamber (waist  $w_0 = 15$  mm). They enter together through a viewport, cross the atomic cloud, and are finally retroreflected by a mirror fixed outside the vacuum chamber. In this geometry, four laser beams are actually sent onto the atoms, which interact with only two of them, because of selection rules and resonance conditions. The interferometer can also be operated with co-propagating Raman laser beams by simply blocking the light in front of the retroreflecting mirror. A remarkable feature of this experiment is that the three interferometer pulses are realized by this single pair of Raman lasers that is turned on and off three times, the middle pulse being at the top of the atoms' trajectory. For all the measurements described in this article, the Raman lasers are used in the *co-propagating* configuration. The interferometer is then no longer sensitive to inertial forces, but remains sensitive to the relative phase of the Raman lasers. Moreover, as such Raman transitions are not velocity selective, more atoms contribute to the signal. All this allows us to reach a

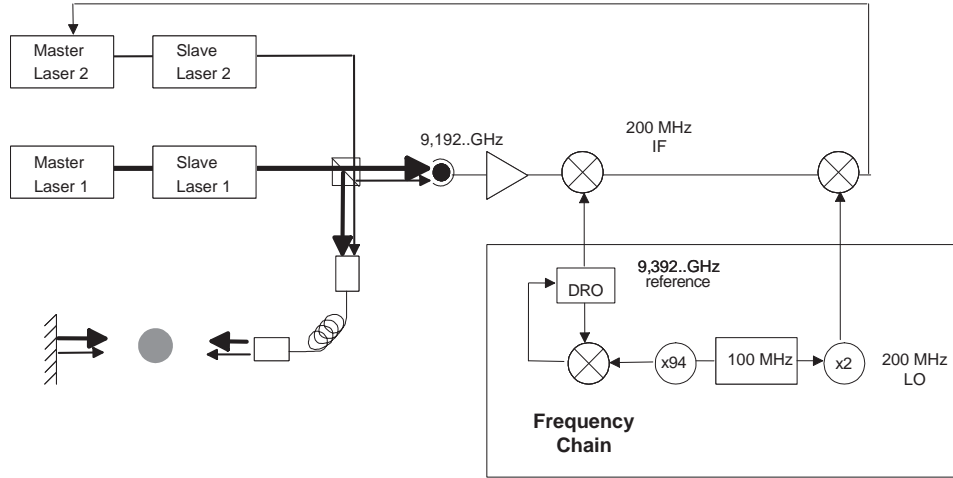

Fig. 2

PRINCIPLE OF THE LASER PHASE-LOCK: THE BEATNOTE AT 9.192 GHz BETWEEN THE TWO RAMAN LASERS IS OBSERVED ON A FAST RESPONSE PHOTODETECTOR. AFTER AMPLIFICATION, THIS BEATNOTE IS MIXED WITH THE REFERENCE FREQUENCY AT 9.392 GHz FROM THE FREQUENCY CHAIN, TO OBTAIN A SIGNAL AT 200 MHz. THIS SIGNAL IS COMPARED WITH THE REFERENCE FREQUENCY AT 200 MHz FROM THE SAME FREQUENCY CHAIN TO GET AN ERROR SIGNAL. THIS ERROR SIGNAL IS THEN PROCESSED AND SENT TO THE CURRENT OF THE LASER AND TO THE PZT THAT CONTROLS THE LASER CAVITY LENGTH.

good signal to noise ratio of 150 per shot.

The second path is used to control the Raman lasers phase difference, which needs to be locked [17] onto the phase of a very stable microwave oscillator. The phase lock loop scheme is also displayed in figure 2. The frequency difference is measured by a fast photodetector, which detects a beatnote at 9.192 GHz. This signal is then mixed with the signal of a Dielectric Resonator Oscillator (DRO) tuned at 9.392 GHz. The DRO itself is phase locked onto the 94th harmonics of a very stable 100 MHz quartz. The output of the mixer (IF) is 200 MHz. A local oscillator (LO) at 200 MHz is generated by doubling the same 100 MHz quartz. IF and LO are compared using a digital phase and frequency detector, whose output is used as the error signal of the phase-locked loop. The relative phase of the lasers is stabilized by reacting on the current of one of the two diode lasers, as well as on the voltage applied to the PZT that controls the length of the extended cavity diode laser [17].

To measure  $g(t)$ , a small phase step of  $\delta\phi = 0.107$  rad is applied at time  $t$  on the local oscillator. The phase lock loop copies this phase step onto the Raman phase within a fraction of  $\mu s$ , which is much shorter than the Raman pulse duration of  $\tau_R = 20 \mu s$ . Finally we measured the transition probability as a function of  $t$  and deduced the sensitivity function. We display in figure 3 the measurement of the sensitivity function compared with the theoretical calculation. We also realized a precise measurement during each pulse and clearly obtained the predicted sinusoidal rise of the sensitivity function.

For a better agreement of the experimental data with the theoretical calculation, the data are normalized to take into account the interferometer's contrast, which was measured

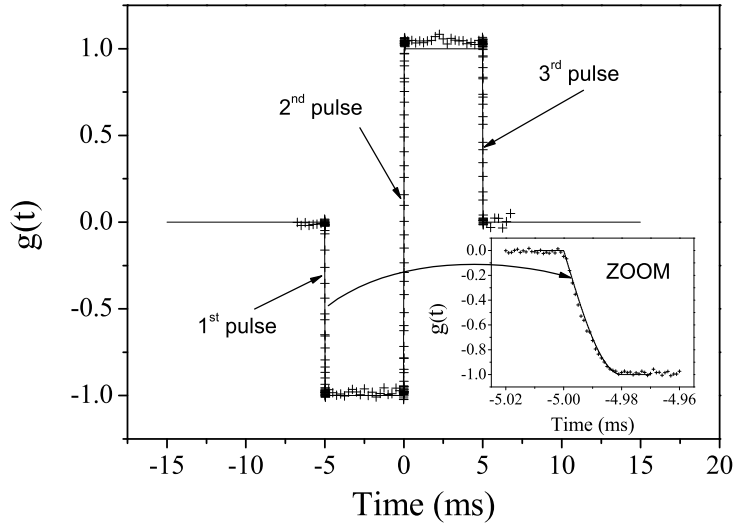

Fig. 3

THE ATOMIC SENSITIVITY FUNCTION  $g(t)$  AS A FUNCTION OF TIME, FOR A THREE PULSES INTERFEROMETER WITH A RABI FREQUENCY  $\Omega_R = \frac{\pi}{2\tau_R}$ . THE THEORETICAL CALCULATION IS DISPLAYED IN SOLID LINE AND THE EXPERIMENTAL MEASUREMENT WITH CROSSES. A ZOOM IS MADE ON THE FIRST PULSE.

to be 78%. This reduction in the contrast with respect to 100% is due to the combined effect of inhomogeneous Rabi frequencies between the atoms, and unbalanced Rabi frequencies between the pulses. Indeed, the atomic cloud size of 8 mm is not negligible with respect to the size of the single pair of Raman gaussian beams,  $w_0 = 15$  mm. Atoms at both sides of the atomic cloud will not see the same intensity, inducing variable transfer efficiency of the Raman transitions. Moreover, the cloud moves by about 3 mm between the first and the last pulse. In order for the cloud to explore only the central part of the gaussian beams, we choose a rather small interaction time of  $T = 4.97$  ms with respect to the maximum interaction time possible of  $T = 40$  ms. Still, the quantitative agreement is not perfect. One especially observes a significant asymmetry of the sensitivity function, which remains to be explained. A full numerical simulation could help in understanding the effect of the experimental imperfections.

### III. TRANSFER FUNCTION OF THE INTERFEROMETER

From the sensitivity function, we can now evaluate the fluctuations of the interferometric phase  $\Phi$  for an arbitrary Raman phase noise  $\phi(t)$  on the lasers

$$\delta\Phi = \int_{-\infty}^{+\infty} g(t)d\phi(t) = \int_{-\infty}^{+\infty} g(t)\frac{d\phi(t)}{dt}dt. \quad (5)$$

The transfer function of the interferometer can be obtained by calculating the response of the interferometer phase  $\Phi$  to a sinusoidal modulation of the Raman phase, given by  $\phi(t) = A_0\cos(\omega_0t + \psi)$ . We find  $\delta\Phi = A_0\omega_0\text{Im}(G(\omega_0))\cos(\psi)$ , where  $G$  is the Fourier transform of the sensitivity function.

$$G(\omega) = \int_{-\infty}^{+\infty} e^{-i\omega t}g(t)dt \quad (6)$$

When averaging over a random distribution of the modulation phase  $\psi$ , the rms value of the interferometer phase is  $\delta\Phi^{rms} = |A_0\omega_0G(\omega_0)|$ . The transfer function is thus given by  $H(\omega) = \omega G(\omega)$ . If we now assume uncorrelated Raman phase noise between successive measurements, the rms standard deviation of the interferometric phase noise  $\sigma_{\Phi}^{rms}$  is given by:

$$(\sigma_{\Phi}^{rms})^2 = \int_0^{+\infty} |H(\omega)|^2 S_{\phi}(\omega)d\omega \quad (7)$$

where  $S_{\phi}(\omega)$  is the power spectral density of the Raman phase.

We calculate the Fourier transform of the sensitivity function and find:

$$G(\omega) = \frac{4i\Omega_R}{\omega^2 - \Omega_R^2} \sin\left(\frac{\omega(T + 2\tau_R)}{2}\right) \left( \cos\left(\frac{\omega(T + 2\tau_R)}{2}\right) + \frac{\Omega_R}{\omega} \sin\left(\frac{\omega T}{2}\right) \right) \quad (8)$$

At low frequency, where  $\omega \ll \Omega_R$ , the sensitivity function can be approximated by

$$G(\omega) = -\frac{4i}{\omega} \sin^2(\omega T/2) \quad (9)$$

The weighting function  $|H(2\pi f)|^2$  versus the frequency  $f$  is displayed in figure 4. It has two important features: the first one is an oscillating behavior at a frequency given by  $1/(T + 2\tau_R)$ , leading to zeros at frequencies given by  $f_k = \frac{k}{T+2\tau_R}$ . The second is a low pass first order filtering due to the finite duration of the Raman pulses, with an effective cutoff frequency  $f_0$ , given by  $f_0 = \frac{\sqrt{3}}{3} \frac{\Omega_R}{2\pi}$ . Above 1 kHz only the mean value over one oscillation is displayed on the figure.

In order to measure the transfer function, a phase modulation  $A_m\cos(2\pi f_m t + \psi)$  is applied on the Raman phase, triggered on the first Raman pulse. The interferometric phase variation is then recorded as a function of  $f_m$ . We then repeat the measurements for the phase modulation in quadrature  $A_m\sin(2\pi f_m t + \psi)$ . From the quadratic sum of these measurement, we extract  $H(2\pi f_m)^2$ . The weighting function was first measured at low frequency. The results, displayed in figure 5 together with the theoretical value, clearly demonstrate the

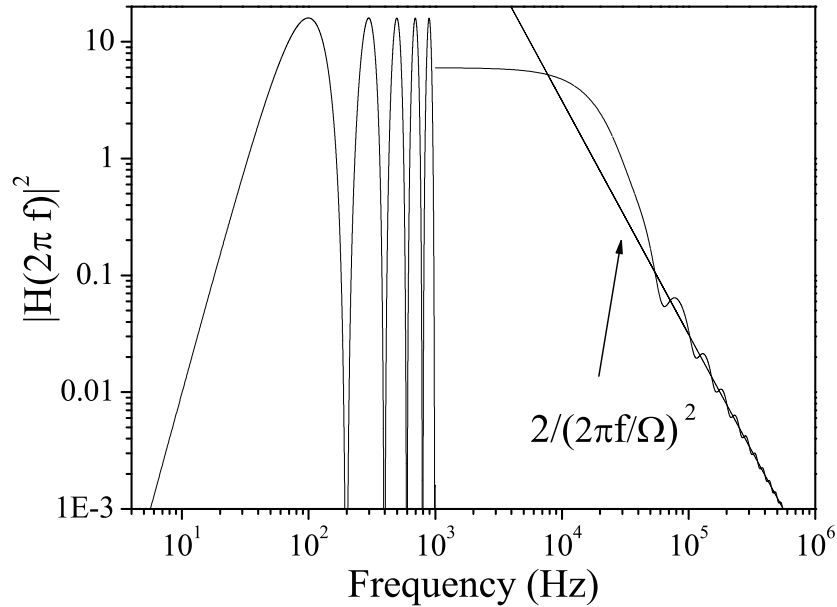

Fig. 4

CALCULATED WEIGHTING FUNCTION FOR THE RAMAN PHASE NOISE AS A FUNCTION OF FREQUENCY. BELOW 1 KHz, THE EXACT WEIGHTING FUNCTION IS DISPLAYED. IT SHOWS AN OSCILLATION WITH A PERIOD FREQUENCY OF  $\delta f = \frac{1}{T+2\tau}$ . ABOVE 1 KHz ONLY THE MEAN VALUE OF THE WEIGHTING FUNCTION OVER  $\delta f$  IS DISPLAYED. THE WEIGHTING FUNCTION ACTS AS A FIRST ORDER LOW PASS FILTER, WITH AN EFFECTIVE CUTOFF FREQUENCY OF  $f_0 = \frac{\sqrt{3}}{3} \frac{\Omega_R}{2\pi}$

oscillating behavior of the weighting function. Figure 6 displays the measurements performed slightly above the cutoff frequency, and shows two zeros. The first one corresponds to a frequency multiple of  $1/(T + 2\tau)$ . The second one is a zero of the last factor of equation 8. Its position depends critically on the value of the Rabi frequency.

When comparing the data with the calculation, the experimental imperfections already mentioned have to be accounted for. An effective Rabi frequency  $\Omega_{eff}$  can be defined by the relation  $\Omega_{eff}\tau_0 = \pi$ , where  $\tau_0$  is the duration of the single pulse, performed at the center of the gaussian Raman beams, that optimizes the transition probability. For homogeneous Raman beams, this pulse would be a  $\pi$  pulse. This effective Rabi frequency is measured with an uncertainty of about 1 %. It had to be corrected by only 1.5 % in order for the theoretical and experimental positions of the second zero to match. The excellent agreement between the theoretical and experimental curves validate our model.



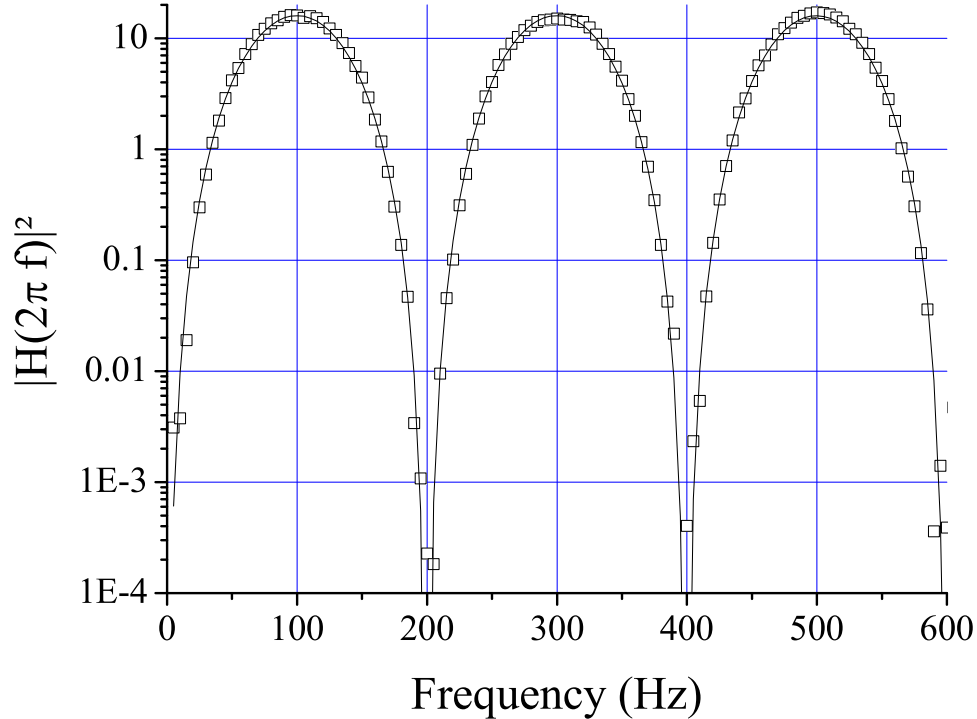

Fig. 5

THE PHASE NOISE WEIGHTING FUNCTION  $|H(2\pi f)|^2$  FOR  $T = 4.97$  MS AND  $\tau_R = 20$   $\mu$ S, AT LOW FREQUENCY. THE THEORETICAL CALCULATION IS DISPLAYED IN SOLID LINE AND THE EXPERIMENTAL RESULTS IN SQUARES. WE CLEARLY SEE THE OSCILLATING BEHAVIOR OF THE WEIGHTING FUNCTION AND THE EXPERIMENTAL MEASUREMENT ARE IN GOOD AGREEMENT WITH THE THEORETICAL CALCULATION.

#### IV. LINK BETWEEN THE SENSITIVITY FUNCTION AND THE SENSITIVITY OF THE INTERFEROMETER

The sensitivity of the interferometer is characterized by the Allan variance of the interferometric phase fluctuations,  $\sigma_{\Phi}^2(\tau)$ , defined as

$$\sigma_{\Phi}^2(\tau) = \frac{1}{2} \langle (\delta\bar{\Phi}_{k+1} - \delta\bar{\Phi}_k)^2 \rangle \quad (10)$$

$$= \frac{1}{2} \lim_{n \rightarrow \infty} \left\{ \frac{1}{n} \sum_{k=1}^n (\delta\bar{\Phi}_{k+1} - \delta\bar{\Phi}_k)^2 \right\}. \quad (11)$$

where  $\delta\bar{\Phi}_k$  is the average value of  $\delta\Phi$  over the interval  $[t_k, t_{k+1}]$  of duration  $\tau$ . The Allan variance is equal, within a factor of two, to the variance of the differences in the successive average values  $\delta\bar{\Phi}_k$  of the interferometric phase. Our interferometer being operated sequentially at a rate  $f_c = 1/T_c$ ,  $\tau$  is a multiple of  $T_c$ :  $\tau = mT_c$ . Without losing generality, we can choose  $t_k = -T_c/2 + kmT_c$ . The average value  $\delta\bar{\Phi}_k$  can now be expressed as

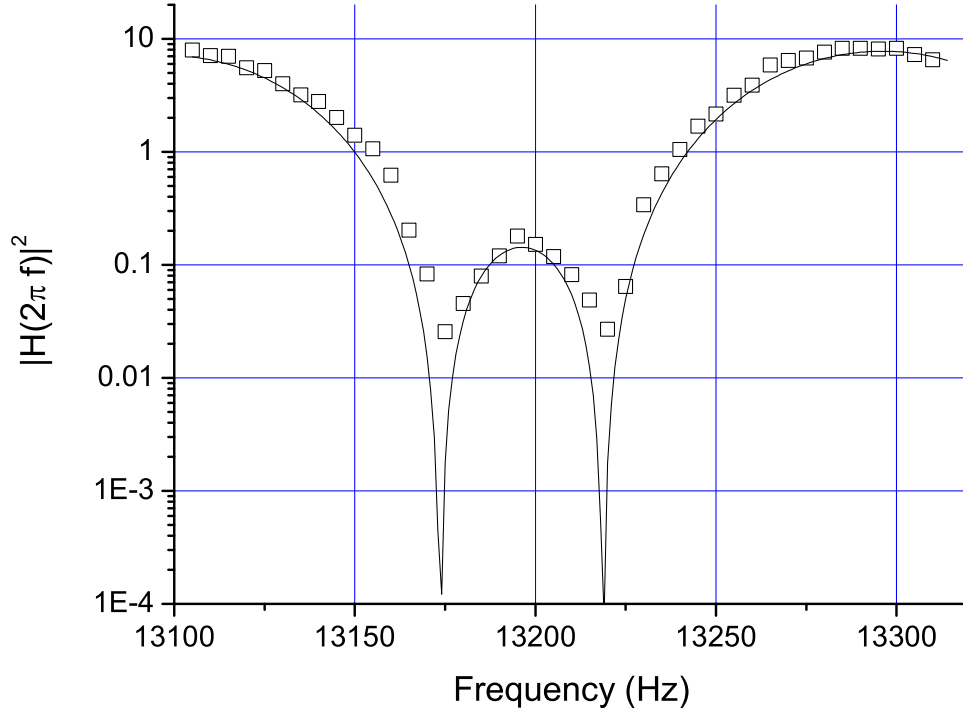

Fig. 6

THE PHASE NOISE WEIGHTING FUNCTION  $|H(2\pi f)|^2$  FOR  $T = 4.97$  MS AND  $\tau_R = 20$   $\mu$ S, DISPLAYED NEAR THE RABI FREQUENCY. THE THEORETICAL CALCULATION IS DISPLAYED IN SOLID LINE AND THE EXPERIMENTAL RESULTS IN SQUARES. WE IDENTIFIED THE ZERO MULTIPLE OF  $\frac{1}{T+2\tau}$  AND OBSERVED EXPERIMENTALLY BOTH ZEROS WITH A GOOD AGREEMENT WITH THEORY.

$$\delta\bar{\Phi}_k = \frac{1}{m} \sum_{i=1}^m \delta\Phi_i = \frac{1}{m} \sum_{i=1}^m \int_{t_k+(i-1)T_c}^{t_k+iT_c} g(t - t_k - (i-1)T_c - T_c/2) \frac{d\phi}{dt} dt \quad (12)$$

$$= \frac{1}{m} \int_{t_k}^{t_{k+1}} g_k(t) \frac{d\phi}{dt} dt \quad (13)$$

where  $g_k(t) = \sum_{i=1}^m g(t - kmT_c - (i-1)T_c)$ . The difference between successive average values is then given by

$$\delta\bar{\Phi}_{k+1} - \delta\bar{\Phi}_k = \frac{1}{m} \int_{-\infty}^{+\infty} (g_{k+1}(t) - g_k(t)) \frac{d\phi}{dt} dt \quad (14)$$

For long enough averaging times, the fluctuations of the successive averages are not correlated and the Allan variance is given by

$$\sigma_{\Phi}^2(\tau) = \frac{1}{2} \frac{1}{m^2} \int_0^{+\infty} |G_m(\omega)|^2 \omega^2 S_{\phi}(\omega) d\omega \quad (15)$$

where  $G_m$  is the Fourier transform of the function  $g_{k+1}(t) - g_k(t)$ . After a few algebra, we find for the squared modulus of  $G_m$  the following expression

$$|G_m(\omega)|^2 = 4 \frac{\sin^4(\omega m T_c / 2)}{\sin^2(\omega T_c / 2)} |G(\omega)|^2 \quad (16)$$

When  $\tau \rightarrow \infty$ ,  $|G_m(\omega)|^2 \sim \frac{2m}{T_c} \sum_{j=-\infty}^{\infty} \delta(\omega - j2\pi f_c) |G(\omega)|^2$ . Thus for large averaging times  $\tau$ , the Allan variance of the interferometric phase is given by

$$\sigma_{\Phi}^2(\tau) = \frac{1}{\tau} \sum_{n=1}^{\infty} |H(2\pi n f_c)|^2 S_{\phi}(2\pi n f_c) \quad (17)$$

Equation 17 shows that the sensitivity of the interferometer is limited by an aliasing phenomenon similar to the Dick effect in atomic clocks [14] : only the phase noise at multiple of the cycling frequency appear in the Allan variance, weighted by the Fourier components of the transfer function.

Let's examine now the case of white Raman phase noise :  $S_{\phi}(\omega) = S_{\phi}^0$ . The interferometer sensitivity is given by:

$$\sigma_{\Phi}^2(\tau) = \left(\frac{\pi}{2}\right)^2 \frac{S_{\phi}^0 T_c}{\tau \tau_R} \quad (18)$$

In that case, the sensitivity of the interferometer depend not only on the Raman phase noise spectral density but also on the pulse duration  $\tau_R$ . For a better sensitivity, one should use the largest pulse duration as possible. But, as the Raman transitions are velocity selective, a very long pulse will reduce the number of useful atoms. This increases the detection noise contribution, so that there is an optimum value of  $\tau_R$  that depends on the experimental parameters. In the case of the gyroscope, the optimum was found to be  $\tau_R = 20 \mu\text{s}$ .

To reach a good sensitivity, the Raman phase needs to be locked to the phase of a very stable microwave oscillator (whose frequency is 6.834 GHz for  $^{87}\text{Rb}$  and 9.192 GHz for  $^{133}\text{Cs}$ ). This oscillator can be generated by a frequency chain, where low phase noise quartz performances are transposed in the microwave domain. At low frequencies ( $f < 10 - 100$  Hz), the phase noise spectral density of such an oscillator is usually well approximated by a  $1/f^3$  power law (flicker noise), whereas at high frequency ( $f > 1$  kHz), it is independent of the frequency (white noise). Using equation 17 and the typical parameters of our experiments ( $\tau_R = 20 \mu\text{s}$  and  $T = 50$  ms), we can calculate the phase noise spectral density required to achieve an interferometric phase fluctuation of 1 mrad per shot. This is equivalent to the quantum projection noise limit for  $10^6$  detected atoms. The flicker noise of the microwave oscillator should be lower than  $-53 \text{ dB}\cdot\text{rad}^2\cdot\text{Hz}^{-1}$  at 1 Hz from the carrier frequency, and its white noise below  $-111 \text{ dB}\cdot\text{rad}^2\cdot\text{Hz}^{-1}$ . Unfortunately, there exists no quartz oscillator combining these two levels of performance. Thus, we plan to lock a SC Premium 100 MHz oscillator (from Wenzel Company) onto a low flicker noise 5 MHz Blue Top oscillator (Wenzel). From the specifications of these quartz, we calculate a contribution of 1.2 mrad to the interferometric phase noise.

Phase fluctuations also arise from residual noise in the servo-lock loop. We have measured experimentally the residual phase noise power spectral density of a phase lock system

analogous to the one described in figure 2. This system has been developed for phase locking the Raman lasers of the gravimeter experiment. The measurement was performed by mixing IF and LO onto an independent RF mixer, whose output phase fluctuations was analyzed onto a Fast Fourier Transform analyzer. The result of the measurement is displayed on figure 7. At low frequencies, below 100 Hz, the phase noise of our phaselock system lies well below the required flicker noise. After a few kHz, it reaches a plateau of  $-119 \text{ dB.rad}^2.\text{Hz}^{-1}$ . The amplitude of this residual noise is not limited by the gain of the servo loop. Above 60 kHz, it increases up to  $-90 \text{ dB.rad}^2.\text{Hz}^{-1}$  at 3.5 MHz, which is the bandwidth of our servo lock loop. Using equation 17, we evaluated to 0.72 mrad its contribution to the interferometer's phase noise.

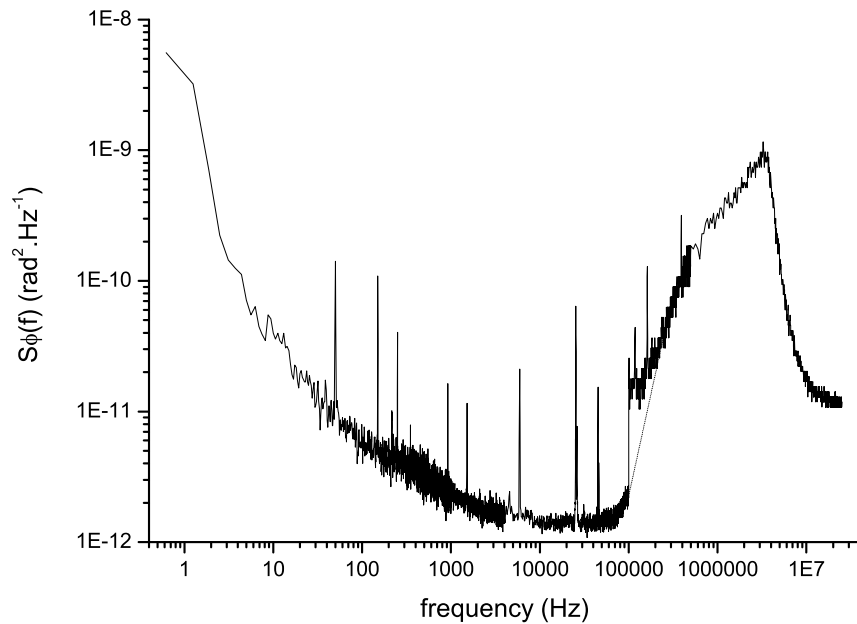

Fig. 7

PHASE NOISE POWER SPECTRAL DENSITY BETWEEN THE TWO PHASE LOCKED DIODE LASERS. UP TO 100 kHz, WE DISPLAY THE RESIDUAL NOISE OF THE PHASELOCK LOOP, OBTAINED BY MEASURING THE PHASE NOISE OF THE DEMODULATED BEATNOTE ON A FAST FOURIER TRANSFORM ANALYZER. THERE, THE PHASE NOISE OF THE REFERENCE OSCILLATOR IS REJECTED. ABOVE 100 kHz, WE DISPLAY THE PHASE NOISE MEASURED DIRECTLY ON THE BEATNOTE OBSERVED ONTO A SPECTRUM ANALYZER. IN THIS CASE, THE REFERENCE OSCILLATOR PHASE NOISE LIMITS THE RAMAN PHASE NOISE TO  $1.5 \times 10^{-11} \text{ rad}^2.\text{Hz}^{-1}$ . IN DOTTED LINE IS DISPLAYED AN EXTRAPOLATION OF THE PHASE NOISE DUE TO THE PHASE-LOCK LOOP ALONE BETWEEN 100 kHz AND 300 kHz.

Other sources of noise are expected to contribute, which haven't been investigated here : noise of the fast photodetector, phase noise due to the propagation of the Raman beams

in free space and in optical fibers [18].

## V. THE CASE OF PARASITIC VIBRATIONS

The same formalism can be used to evaluate the degradation of the sensitivity caused by parasitic vibrations in the usual case of counter-propagating Raman beams. As the two laser beams are first overlapped before being sent onto the atoms, their phase difference is mostly affected by the movements of a single optical element, the mirror that finally retro-reflects them.

A displacement of this mirror by  $\delta z$  induces a Raman phase shift of  $k_{eff}\delta z$ . The sensitivity of the interferometer is then given by

$$\sigma_{\Phi}^2(\tau) = \frac{k_{eff}^2}{\tau} \sum_{n=1}^{\infty} |H(2\pi n f_c)|^2 S_z(2\pi n f_c) \quad (19)$$

where  $S_z(\omega)$  is the power spectral density of position noise. Introducing the power spectral density of acceleration noise  $S_a(\omega)$ , the previous equation can be written

$$\sigma_{\Phi}^2(\tau) = \frac{k_{eff}^2}{\tau} \sum_{n=1}^{\infty} \frac{|H(2\pi n f_c)|^2}{(2\pi n f_c)^4} S_a(2\pi n f_c) \quad (20)$$

It is important to note here that the acceleration noise is severely filtered by the transfer function for acceleration which decreases as  $1/f^4$ .

In the case of white acceleration noise  $S_a$ , and to first order in  $\tau_R/T$ , the limit on the sensitivity of the interferometer is given by :

$$\sigma_{\Phi}^2(\tau) = \frac{k_{eff}^2 T^4}{2} \left( \frac{2T_c}{3T} - 1 \right) \frac{S_a}{\tau} \quad (21)$$

To put this into numbers, we now calculate the requirements on the acceleration noise of the retroreflecting mirror in order to reach a sensitivity of 1 mrad per shot. For the typical parameters of our gravimeter, the amplitude noise should lie below  $10^{-8} \text{ m.s}^{-2}.\text{Hz}^{-1/2}$ . The typical amplitude of the vibration noise measured on the lab floor is  $2 \times 10^{-7} \text{ m.s}^{-2}.\text{Hz}^{-1/2}$  at 1 Hz and rises up to about  $5 \times 10^{-5} \text{ m.s}^{-2}.\text{Hz}^{-1/2}$  at 10 Hz. This vibration noise can be lowered to a few  $10^{-7} \text{ m.s}^{-2}.\text{Hz}^{-1/2}$  in the 1 to 100 Hz frequency band with a passive isolation platform. To fill the gap and cancel the effect of vibrations, one could use the method proposed in [18], which consists in measuring the vibrations of the mirror with a very low noise seismometer and compensate the fluctuations of the position of the mirror by reacting on the Raman lasers phase difference.

## VI. CONCLUSION

We have here calculated and experimentally measured the sensitivity function of a three pulses atomic interferometer. This enables us to determine the influence of the Raman phase noise, as well as of parasitic vibrations, on the noise on the interferometer phase. Reaching a 1 mrad shot to shot fluctuation requires a very low phase noise frequency reference, an optimized phase lock loop of the Raman lasers, together with a very low level of parasitic

vibrations. With our typical experimental parameters, this would result in a sensitivity of  $4 \times 10^{-8} \text{ rad.s}^{-1}.\text{Hz}^{-1/2}$  for the gyroscope and of  $1.5 \times 10^{-8} \text{ m.s}^{-2}.\text{Hz}^{-1/2}$  for the gravimeter.

Improvements are still possible. The frequency reference could be obtained from an ultra stable microwave oscillator, such as a cryogenic sapphire oscillator [19], whose phase noise lies well below the best quartz available. Besides, the requirements on the phase noise would be easier to achieve using atoms with a lower hyperfine transition frequency, such as Na or K. Trapping a very large initial number of atoms in the 3D-MOT would enable a very drastic velocity selection. The duration of the Raman pulses could then be significantly increased, which makes the interferometer less sensitive to high frequency Raman phase noise. The manipulation of the atoms can also be implemented using Bragg pulses [20], [21]. The difference in the frequencies of the two beams being much smaller, the requirements on the relative phase stability is easy to achieve. In that case, a different detection method needs to be implemented as atoms in both exit ports of the interferometer are in the same internal state. Using ultracold atoms with subrecoil temperature, atomic wavepackets at the two exit ports can be spatially separated, which allows for a simple detection based on absorption imaging. Such an interferometer would benefit from the long interaction times available in space to reach a very high sensitivity.

We also want to emphasize that the sensitivity function can also be used to calculate the phase shifts arising from all possible systematic effects, such as the light shifts, the magnetic field gradients and the cold atom collisions.

#### ACKNOWLEDGMENT

The authors would like to thank André Clairon for fruitful discussions and careful reading of the manuscript. This work was supported in part by BNM, CNRS, DGA and CNES. BNM-SYRTE is Unité Associée au CNRS, UMR 8630.

#### REFERENCES

- [1] A. Clairon, Ph. Laurent, G. Santarelli, S. Ghezali, S. N. Lea and M. Bahoura, "A cesium fountain frequency standard: recent result," *IEEE Trans Instrum. Meas.*, vol. 44, pp. 128-, 1995.
- [2] F. Riehle, Th. Kister, A. Witte, J. Helmcke and Ch. J. Bordé, "Optical Ramsey spectroscopy in a rotating frame: Sagnac effect in a matter-wave interferometer," *Phys. Rev. Lett.*, vol. 67, pp. 177-180, 1991.
- [3] T. L. Gustavson, A. Landragin, M. Kasevich, "Rotation sensing with a dual atom-interferometer Sagnac gyroscope," *Class. Quantum. Grav.*, vol. 17, p. 1, 2000.
- [4] A. Peters, K. Y. Chung, S. Chu, "High-precision gravity measurements using atom interferometry," *Metrologia*, vol. 38,p. 25, 2001.
- [5] *Atom interferometry*, P. R. Berman, Ed. Chestnut Hill: Academic Press, 1997.
- [6] T.M. Niebauer, G.S. Sasagawa, J.E. Faller, R. Hilt, F. Klopping, "A new generation of absolute gravimeters," *Metrologia*, vol. 32, p. 159, 1995.
- [7] G. E. Stedman, "Ring-laser tests of fundamental physics and geophysics," *Rep. Prog. Phys.*, vol. 60, pp. 615-688, 1997.

- [8] F. Leduc, D. Holleville, J. Fils, A. Clairon, N. Dimarcq and A. Landragin, "Cold atom gyroscope for precision measurement," in *Proc. ICOLS*, 2003, pp.68-70.
- [9] P. Cheinet, F. Pereira Dos Santos, A. Clairon, N. Dimarcq, D. Holleville and A. Landragin, "Gravimètre à atomes froids," *Journal de Physique 4*, vol. 119, p. 153, 2004.
- [10] G. Genevès, P. Gournay, A. Gosset, M. Lecollinet, F. Villar, P. Pinot, P. Juncar, A. Clairon, A. Landragin, D. Holleville, F. Pereira Dos Santos, J. David, M. Besbes, F. Alves, L. Chassagne, S. Topçu, "The BNM Watt Balance Project," accepted in *IEEE Trans. Inst. Meas.*.
- [11] M. Kasevich and S. Chu, "Atomic interferometry using stimulated Raman transitions," *Phys. Rev. Lett.*, vol. 67, p. 181, 1991.
- [12] Ch. J. Bordé, "Atom interferometry and laser spectroscopy," in *Laser Spectroscopy X*, M. Ducloy, E. Giacobino, G. Camy Ed. Singapore: World Scientific, 1991, p. 239.
- [13] Ch. Antoine, Ch. J. Bordé, "Quantum theory of atomic clocks and gravito-inertial sensors: an update," *J. Opt. B: Quantum Semiclass. Opt.*, vol. 5, pp. 199-207, 2003.
- [14] G. J. Dick, "Local Oscillator induced instabilities," in *Proc. Nineteenth Annual Precise Time and Time Interval*, 1987, pp. 133-147.
- [15] M. Kasevich and S. Chu, "Measurement of the gravitational acceleration of an atom with a light-pulse atom interferometer," *Appl. Phys. B*, vol. 54, pp. 321-332, 1992
- [16] K. A. Moler, D. S. Weiss, M. Kasevich, and S. Chu, "Theoretical analysis of velocity-selective Raman transitions," *Phys. Rev. A*, vol. 45, p. 342, 1992.
- [17] G. Santarelli, A. Clairon, S. N. Lea and G. M. Tino, "Heterodyne optical phase locking of extended-cavity semiconductor lasers at 9 GHz," *Optics Commun.*, vol. 104, pp. 339-344, 1994.
- [18] F. Yver-Leduc, P. Cheinet, J. Fils, A. Clairon, N. Dimarcq, D. Holleville, P. Bouyer, A. Landragin, "Reaching the quantum noise limit in a high-sensitivity cold-atom inertial sensor," *J. Opt. B : Quantum Semiclass. Optics*, vol. 5, pp. S136-S142, 2003.
- [19] A. Mann, C. Sheng and A. Luiten, "Cryogenic sapphire oscillator with exceptionally high frequency stability," *IEEE Trans. Instr. Meas.*, vol. 50, p. 519, 2001.
- [20] E. M. Rasel, M. K. Oberthaler, H. Batelaan, J. Schmiedmayer, and A. Zeilinger, "Atom wave interferometry with diffraction gratings of light," *Phys. Rev. Lett.*, vol. 75, p. 2633, 1995
- [21] D.M. Giltner, R. W. McGowan, and S. A. Lee, "Atom interferometer based on Bragg scattering from standing light waves," *Phys. Rev. Lett.*, vol. 75, p. 2638, 1995.