

Chiral Lagrangians and quark condensate in nuclei

J. Delorme, G. Chanfray and M. Ericson*

Institut de Physique Nucléaire et IN2P3, CNRS, Université Claude Bernard Lyon I,
43 Bd. du 11 Novembre, F-69622 Villeurbanne Cedex, France

Abstract

We study the evolution with density of the quark condensate in the nuclear medium with interacting nucleons and including the short range correlations. We work with two chiral models, the linear sigma model and the non-linear one. For the last one we use two versions, one which does not satisfy PCAC, and another one which does. We show that the quark condensate, as well as the effective pion mass, is independent on the variant selected. The application to physical pions excludes the linear sigma model as a credible one. In the non-linear models our conclusions are the following:

- i) there is no systematic reaction imposed by chiral symmetry against symmetry restoration.
- ii) the quark condensate evolves essentially linearly with density, as if the nucleons were non interacting. We examine here one correction due to the two pion exchange potential and found it to be negligible. The main correction arises from the one pion exchange interaction.
- iii) in the s-wave optical potential chiral symmetry tolerates but does not impose two body terms. On the other hand the effect of correlations linked to the isospin symmetric amplitude is negligible.

PACS numbers: 12.39.Fe 24.85.+p 25.80.Dj

LYCEN 9604
CERN-TH/96-60
nucl-th/9603005

*Also at Theory Division, CERN, CH-1211 Geneva 23, Switzerland

1 Introduction

Nuclear matter produces a restoration of chiral symmetry which is remarkably large. The quark condensate, which is the order parameter of the spontaneous symmetry breaking, decreases in magnitude by about 1/3 at the normal density ρ_0 [1, 2, 3]. The bulk of this restoration comes from the additive effect of independent nucleons. An effort has been made to study the restoration effect due to the interaction between the nucleons [2, 4, 6, 7]. In particular, Chanfray and Ericson [4] made the observation that the quark condensate in a dense medium (of density ρ) is governed by the nuclear sigma commutator with the exact relation:

$$\frac{\langle \bar{q}q(\rho) \rangle}{\langle \bar{q}q(0) \rangle} = 1 - \frac{\rho \Sigma_A}{f_\pi^2 m_\pi^2} \quad (1)$$

where $\langle \bar{q}q(\rho) \rangle$ is the quark condensate density in the medium and $\langle \bar{q}q(0) \rangle$ its vacuum value. The pion mass and decay constant are m_π and f_π ($= 94$ MeV). We have denoted by $\rho \Sigma_A$ the nuclear sigma commutator per unit volume with the definition for a piece of nuclear matter of density ρ :

$$A \Sigma_A(\rho) = \langle \Psi_A | [Q_A, [Q_A, H]] | \Psi_A \rangle \quad (2)$$

where Ψ_A is the nuclear ground state with total nucleon number A , H the Hamiltonian and Q_A the axial charge. In this way the quantity $\Sigma_A(\rho)$, which is a function of the density, is the effective sigma commutator per nucleon in the nuclear medium. Thus the study of the in medium quark condensate amounts to that of the sigma commutator. In the low density limit Σ_A reduces to Σ_N the nucleon sigma commutator and the relation (1) leads to the linear density dependence given in refs. [1, 2, 3].

Using the partially conserved axial current hypothesis (PCAC) Chanfray and Ericson have related Σ_A to the soft pion amplitude on the nucleus. They have thus shown that a correction to the additive assumption, *i.e.* $A \Sigma_A(\rho) = A \Sigma_N$, arises from the contribution of the pions exchanged between the nucleons which also participate in the restoration of chiral symmetry. This simple result does not depend on the original assumption that PCAC holds [4].

Pushing the consequences of PCAC, M. Ericson has suggested the existence of a reaction of the nuclear medium against the restoration of chiral symmetry, arising from the distortion of the soft pion wave [5]. This possibility was examined by Birse and Mc Govern [8] in the linear sigma model where PCAC holds. The distortion effect is indeed present but these authors have shown that it is overcompensated by exchange effects, linked to the σ meson, such that there is an overall acceleration of the restoration instead of a hindrance. On the other hand T. Ericson has shown that the soft pion amplitude can be appreciably affected by the correlations [9], eventually cancelling, as expected, the distortion effect in the limit of nucleons totally confined inside the correlation hole.

The aim of the present work is twofold. We first want to complete the studies of refs. [5, 8, 9] by introducing the correlations in the linear sigma model in a consistent way, which was not done previously. We will show that the effect of the correlations should not be discussed alone, but in connection with those of the σ meson exchange introduced in ref. [8]. Using the information provided by the scattering of physical pions on nuclei we will discuss the limitations of the linear sigma model and show that it cannot be trusted for a quantitative discussion. The second and main aim of this work is then to perform an exploration of the nuclear sigma commutator in the non-linear sigma model, which does not assume the existence of a scalar meson. In the non-linear version the PCAC relation does not automatically hold. This hypothesis is abandoned as a systematic assumption and only the chiral properties of the interaction are emphasized. However for certain representations it is possible to make a transformation on the field in such a way that PCAC is valid. In this case the nuclear sigma commutator coincides with the soft pion amplitude and it is possible to elucidate the interplay between the distortion and the exchange terms. We will show that physical quantities, such as the condensate and the in-medium pion mass are independent of the representation, as expected from a general theorem [10]. We will also introduce the correlations in a consistent way in this model. We limit our discussion to the s-wave isospin symmetric pion-nucleon amplitude.

2 Linear sigma model

We work in the linear sigma model, where the sigma commutator is proportional to the soft pion amplitude. We want to evaluate the scattering amplitude for soft pion on a nucleus, taken for simplicity as a piece of nuclear matter of density ρ . We denote T the amplitude per unit volume so that $T = \Sigma_A \rho / f_\pi^2$. We work up to second order in the density. For simplicity we limit our calculation to the tree level. The graphs contributing to second order in the density to the soft pion scattering amplitude are represented in fig. 1a-d. The coherent rescattering term is represented in fig. 1a. The graphs linked to σ exchange introduced in ref. [8] are shown in the graphs of fig. 1b-d. The short range correlations add the contributions of graphs 2a-d, where the wiggled line may be interpreted as the iterated exchange of a heavy meson, such as the ω meson, responsible for the short range repulsion. We take for the correlation function the convenient schematic form $G(\vec{r}) = -j_0(q_c r)$ (with $q_c = m_\omega$) introduced by Weise [11], which has the simple Fourier transform $G(\vec{q}) = -2\pi^2 \delta(q - q_c) / q_c^2$.

Denoting T_σ the sum of the sigma exchange contributions in the correlated medium we obtain in the Hartree approximation which we follow throughout this paper for the clarity of the argument:

$$T_\sigma = T_b + T_c + T_d = \frac{g^2 \rho^2}{f_\pi^2} \left[\frac{5}{2} \frac{m_\pi^2}{m_\sigma^4} - \frac{5}{2} \frac{m_\pi^2}{(m_\sigma^2 + q_c^2)^2} - \frac{q_c^2}{(m_\sigma^2 + q_c^2)^2} \right] + O(m_\pi^4), \quad (3)$$

where g is the meson-nucleon coupling constant. On the other hand, the sum of the coherent and incoherent rescattering is (fig. 1a and 2a)

$$T_{resc.} = \frac{g^2 \rho^2}{f_\pi^2} \left[-\frac{m_\pi^2}{m_\sigma^4} + \frac{m_\pi^2}{(m_\sigma^2 + q_c^2)^2} + \frac{q_c^2}{(m_\sigma^2 + q_c^2)^2} \right] + O(m_\pi^4). \quad (4)$$

Both terms T_σ and $T_{resc.}$ are strongly affected by the correlations, as apparent from the presence of a term proportional to q_c^2 which does not vanish in the chiral limit $m_\pi \rightarrow 0$. However, when the sum of the second order contributions is performed, the two terms in q_c^2 exactly cancel each other. What this cancellation reveals is that the role of the incoherent rescattering (graph 2a) should not be discussed alone, otherwise chiral symmetry would be violated since the amplitude T would not vanish in the chiral limit. Instead incoherent rescattering should be associated with the contribution of the correlations in the σ meson exchange graphs 2b-d so as to make the soft amplitude go as m_π^2 . This cancellation has not been discussed in the previous works of refs. [8, 9] but it is necessary to reach a consistent description.

Adding the contribution of first order in the density to obtain the total amplitude we arrive at the following expression for the density evolution of the quark condensate :

$$\frac{\langle \bar{q}q(\rho) \rangle}{\langle \bar{q}q(0) \rangle} - 1 = -\frac{T}{m_\pi^2} = -\frac{\rho \Sigma_N}{f_\pi^2 m_\pi^2} - \frac{3}{2} \frac{\rho^2 \Sigma_N^2}{f_\pi^4 m_\pi^4} \left[1 - \frac{1}{\left(1 + \frac{q_c^2}{m_\sigma^2}\right)^2} \right] \left(1 - \frac{m_\pi^2}{m_\sigma^2} \right). \quad (5)$$

Here we have introduced the sigma commutator of the nucleon, Σ_N which in the linear sigma model writes: $\Sigma_N = f_\pi g m_\pi^2 / m_\sigma^2$. Notice that Σ_A could also be obtained directly as the expectation value of the symmetry breaking piece of the Lagrangian, i.e. of $f_\pi m_\pi^2 \sigma$, in a correlated medium. The toy model of Ericson [9] corresponds to the limit of a large correlation hole compared to the extension of the condensate. In the linear sigma model this corresponds to the condition $q_c \ll m_\sigma$. One sees on eq. (5) that the term in ρ^2 then goes to zero and $\Sigma_A = \Sigma_N$. The meson exchange terms disappear as expected, but also the incoherent rescattering cancels the distortion, as found in ref. [9]. In this case the quark condensate density in the nuclear medium evolves linearly with density, as given by the eq. (1) if we replace Σ_A by Σ_N .

This is an extreme situation and the question is how close it is to a realistic one. In fact the size of the condensate, or equivalently the scalar radius of the nucleon, has been extracted from experimental data [12]. Its value, $r_s \approx 1.26 fm$ is sensibly larger than the typical correlation radius $r_c \approx 0.6 fm$. There is indeed a large overlap of the nucleon condensates which is neither reproduced in the linear sigma model nor in the toy model of ref. [9].

We will discuss below in more detail the limitations of the linear sigma model for a proper description of the problems of the quark condensate and physical pion

scattering. We first give in table 1 the value of the quark condensate in this model at nuclear matter density $\rho_0 = 0.17 \text{ fm}^{-3}$. For the numerical evaluation we take the parameters of the linear sigma model in such a way as to reproduce the experimental value of the sigma commutator: $\Sigma_N = 45 \text{ MeV}$ [13]. This fixes the σ mass at $m_\sigma = 740 \text{ MeV}$. On the other hand we take for the cut-off parameter $q_c = m_\omega = 782 \text{ MeV}$. The acceleration of chiral symmetry restoration by σ exchange terms is appreciable, 0.54 instead of 0.65 in the linear approximation eq. (1).

Since the linear sigma model is a consistent one which fulfils the requirements of chiral symmetry we find of interest to give also in table 1 the effective nucleon mass M^* as evaluated from the graphs of fig. 3. Contrary to a common belief it does not follow exactly the same evolution as the condensate even to first order in the density. Correlations do affect the first order in the mass but not in the condensate.

The linear sigma model has serious shortcomings when it comes to a quantitative description of physical quantities. We mention some of the problems.

i) The physics we are discussing is intimately linked to the behaviour of the isospin symmetric πN s-wave amplitude. The sigma model grossly fails to reproduce the corresponding scattering length. The measured value is slightly repulsive $a^+ = -0.010 m_\pi^{-1}$ [14] arising essentially from the pseudovector (PV) nucleon pole terms. The model gives instead a much larger repulsion, $a^+ = -0.059 m_\pi^{-1}$.

ii) in this model, the range of the condensate is determined by the σ mass, which the value of the sigma commutator fixes at 740 MeV. The r.m.s. radius of the condensate follows, $r_s = \sqrt{6}/m_\sigma \approx 0.65 \text{ fm}$. As already mentioned the value deduced from experiments is much larger $r_s = 1.26 \text{ fm}$. With a small extension of the condensate, one is closer to the limit where the condensate remains inside the correlation hole. We have seen that in this limit the incoherent rescattering cancels the coherent one, which is not the case in a realistic situation. The linear sigma model thus overestimates the incoherent rescattering effect, and more generally overstates the role of the correlations.

iii) the last point concerns the σ meson exchange effects. Is their magnitude realistic? We can confront them with the experimental value of the s-wave optical potential. Since the σ exchange graphs of fig. 1c-d are sea-gull terms, they are independent of the energy, thus keeping the same value for physical pions. This implies the existence of a many-body correction due to σ exchange in the s-wave optical potential. The latter is commonly parametrized as [15]:

$$2 m_\pi V_{opt} = - \left(1 + \frac{m_\pi}{M} \right) 4\pi (b_0)_{\text{eff}} \rho . \quad (6)$$

Since the quantity $(b_0)_{\text{eff}}$ incorporates many-body effects of various sources, it is a function of the density. The value of $(b_0)_{\text{eff}}$ deduced from the π -mesic data is $(b_0)_{\text{eff}} = -0.029 m_\pi^{-1}$ [14]. The typical density explored by these data is somewhat

lower than the nuclear matter one [16], *i.e.* $\rho \approx 0.7 \rho_0$. At this density, the linear sigma model predicts an exchange contribution (eq. (3) with the last term in q_c^2 removed) $\Delta_{\sigma \text{exch}} = -0.023 m_\pi^{-1}$. This would mean that most of the observed potential would have this origin. Let us discuss this point in more detail.

In the low density limit the parameter $(b_0)_{\text{eff}}$ should reduce to the free nucleon value $b_0 = -0.010 m_\pi^{-1}$. At finite density, there is one correction of well known origin. It is the rescattering with charge exchange, linked to the Pauli correlations [15]. At $\rho = 0.7\rho_0$ this adds $\Delta_1 b = -0.012 m_\pi^{-1}$. We have also to consider the effect of correlations, $\Delta_2 b$ linked to the isospin symmetric amplitude, *i.e.* the incoherent rescattering term previously discussed and contained in eq. (4). This is not a sea-gull term. Therefore it depends on the energy, but its dependence is mild and we neglect it. Removing the term in q_c and the coherent rescattering in eq. (4), we find:

$$\Delta_2 b = -\frac{1}{4\pi(1 + \frac{m_\pi}{m_N})} \frac{\rho \Sigma_N^2}{f_\pi^4 m_\pi^2} \left(1 + \frac{q_c^2}{m_\sigma^2}\right)^{-2} = -0.003 m_\pi^{-1}, \quad (7)$$

a small contribution. Finally we have to consider also the exchange correction due to pion excess. It represents the s-wave scattering on exchanged pions discussed by Chanfray and Ericson in the case of soft pions [4]. This is also a sea-gull term which keeps the same value for physical ones. With an excess number of pions per nucleon of 0.1 the corresponding contribution is $\Delta_3 b = -0.004 m_\pi^{-1}$.

Adding all the known contributions $b_0 + \Delta_1 b + \Delta_2 b + \Delta_3 b$ we arrive already at $(b_0)_{\text{eff}} = -0.029 m_\pi^{-1}$, exactly the experimental value. Unless there is a large attractive correction (but we do not see from where) there is no room for the large σ meson exchange correction implied by the linear sigma model, which is therefore unrealistic for π -nuclear scattering problem as well.

Thus we can safely conclude that the meson exchange terms in the scattering amplitude of soft, or physical pions, linked to the exchange of a scalar-isoscalar object, cannot be as large as given by the linear sigma model. This was our motivation to investigate the non-linear sigma model.

3 Non-linear sigma model

Though non-linear sigma models have an already long story, their systematic application to nuclear forces and pion nuclear interactions has been recently popularized by Weinberg [17]. We follow the guideline provided by an effective Lagrangian introduced in this spirit by Lynn in his study of nuclear matter [18]. We start from the linear sigma model with the Lagrangian density $\mathcal{L} = \mathcal{L}_0 + \mathcal{L}_{CSB}$ where the chiral symmetric part writes in standard notations:

$$\mathcal{L}_0 = i\bar{\psi}\gamma^\mu\partial_\mu\psi - g\bar{\psi}(\sigma + i\vec{\tau}\cdot\vec{\pi}\gamma_5)\psi + \frac{1}{2}(\partial_\mu\sigma\partial^\mu\sigma + \partial_\mu\vec{\pi}\cdot\partial^\mu\vec{\pi}) - \frac{\lambda}{4}(\sigma^2 + \pi^2 - v^2)^2, \quad (8)$$

where the limit $\lambda \rightarrow \infty$ is to be taken to get the non-linear version. In order to recover the non-linear model of Lynn, we modify the chiral symmetry breaking term by adding a term bilinear in the nucleon field with the same chiral transformation property as the usual term linear in the sigma field:

$$\mathcal{L}_{CSB}^\sigma = f_\pi m_\pi^2 \sigma - \frac{\Sigma_N}{f_\pi^2} \sigma \bar{\psi} (\sigma + i\vec{\tau} \cdot \vec{\pi} \gamma_5) \psi, \quad (9)$$

with, as before, $\Sigma_N = 45$ MeV the nucleon sigma commutator.

We use the standard procedure to go to the non-linear version, writing $\sigma = f_\pi \cos(F)$ and $\vec{\pi} = f_\pi \hat{\phi} \sin(F)$ where F is an arbitrary polynomial in $x = \phi/f_\pi$, which contains only odd powers of x . We also transform the fermion field according to $\psi = S^\dagger N$ where $S^\dagger = \sqrt{(\sigma - i\vec{\tau} \cdot \vec{\pi} \gamma_5)/f_\pi}$. A convenient choice for the function F , introduced by Weinberg is $\sin(F) = x/(1 + x^2/4)$ [19]. The corresponding chiral symmetry breaking Lagrangian is:

$$\mathcal{L}_{CSB}^W = -\frac{1}{2} m_\pi^2 \frac{\phi^2}{(1 + \phi^2/4f_\pi^2)} \left(1 - \frac{\Sigma_N \bar{N} N}{f_\pi^2 m_\pi^2} \right). \quad (10)$$

In this representation the divergence of the axial current does not satisfy PCAC since one has:

$$\partial_\mu \vec{A}^\mu = f_\pi m_\pi^2 \frac{\vec{\phi}}{(1 + \phi^2/4f_\pi^2)} \left(1 - \frac{\Sigma_N \bar{N} N}{f_\pi^2 m_\pi^2} \right). \quad (11)$$

The commutator of the axial charge operator with its time derivative, *i.e.* the σ -term, reads:

$$\begin{aligned} \int d^3r \sigma_{op}(r) &= [Q_A, [Q_A, H]] \\ &= \frac{1}{2} m_\pi^2 f_\pi^2 \int d^3r \left(\frac{\phi^2(r)/f_\pi^2}{(1 + \phi^2(r)/4f_\pi^2)} - 2 \right) \left(1 - \frac{\Sigma_N \bar{N} N(r)}{f_\pi^2 m_\pi^2} \right) \end{aligned} \quad (12)$$

We calculate its expectation value, $\rho \Sigma_A(\rho)$, per unit volume of nuclear matter. To lowest order in the density the value of Σ_A is that of the free nucleon, Σ_N . We use perturbation theory to evaluate the second order terms in the density. We retain only in eq. (12) the lowest order terms in the pion field. The expectation value of the part $\frac{1}{2} m_\pi^2 \phi^2$ of σ_{op} has been discussed by Chanfray and Ericson [4], restricting the interaction hamiltonian to the pseudovector πNN (and also $\pi N\Delta$) coupling. They showed that this contribution to the sigma commutator is nothing else than the sigma commutator of the pion excess. We extend here their calculation to incorporate the s-wave contact term $-\frac{1}{2} (\Sigma_N/f_\pi^2) \bar{N} N \phi^2$ of the interaction Hamiltonian. There are interference terms between the s-wave and p-wave operators, as represented in the graph of fig. 4. We ignore them in the present work. Our result for uniform nuclear matter, in the Hartree approximation, is expressed as the following integral:

$$\Delta\Sigma_1^{2\pi} = -\frac{3}{2} \frac{\rho^2 \Sigma_N^2 m_\pi^2}{f_\pi^4} \int \frac{(-i)d^4k}{(2\pi)^4(k^2 - m_\pi^2)^3} = \frac{3}{2} \frac{\rho^2 \Sigma_N^2}{f_\pi^4} \frac{1}{(4\pi)^2} \int_{4m_\pi^2}^{\infty} \frac{m_\pi^2 dt}{t^2(1 - 4m_\pi^2/t)^{-1/2}}. \quad (13)$$

We have introduced the dispersive form in the right hand side of the second equality in order to facilitate the comparison with the Feynman-Hellmann theorem. The physical interpretation of this term is the same as the one given in ref. [4]. It is the contribution of the excess pions linked to the s-wave contact term, as represented in the graph 5.

Another contribution arises from the term $-\frac{1}{2} (\Sigma_N/f_\pi^2) \bar{N}N\phi^2$ of σ_{op} . It leads to a logarithmically divergent integral:

$$\Delta\Sigma_2^{2\pi} = -\frac{3}{2} \frac{\rho^2 \Sigma_N^2}{f_\pi^4} \int \frac{(-i)d^4k}{(2\pi)^4(k^2 - m_\pi^2)^2} = -\frac{3}{2} \frac{\rho^2 \Sigma_N^2}{f_\pi^4} \frac{1}{(4\pi)^2} \int_{4m_\pi^2}^{\infty} \frac{(1 - 4m_\pi^2/t)^{1/2} dt}{t}. \quad (14)$$

The sum of these two contributions could also be obtained by the Feynman-Hellmann theorem from the expectation value of the part of the two pion exchange potential linked to the s-wave contact term:

$$V_{ct}^{2\pi}(r) = -\frac{3}{2} \frac{\Sigma_N^2}{f_\pi^4 (4\pi)^3} \int_{4m_\pi^2}^{\infty} (1 - 4m_\pi^2/t)^{1/2} \frac{e^{-\sqrt{t}r}}{r} dt. \quad (15)$$

We have to derive this expression with respect to the squared pion mass. The derivation of the integrand leads to the pion excess contribution discussed previously eq. (13). It adds a very small relative correction to Σ_N : $\Delta\Sigma_1^{2\pi}/\Sigma_N\rho = 3.6 \cdot 10^{-3}$, which is not surprising since the s-wave term (15) is only a weak component of the two pion exchange potential. A second piece arises from the derivation of the quantity Σ_N^2 , Σ_N being proportional to m_π^2 ; it leads to the previous diverging integral eq. (14). In order to evaluate it we introduce a cut-off mass $\Lambda = 1$ GeV. The corresponding value of $\Delta\Sigma_2^{2\pi}$ is again small (a relative correction of $-1.4 \cdot 10^{-2}$ to $\Sigma_N\rho$).

Summarizing the results obtained with the Weinberg type Lagrangian, the evolution of the quark condensate with the density is mostly given, up to the normal density, by the linear term in the density:

$$\frac{\langle \bar{q}q(\rho) \rangle}{\langle \bar{q}q(0) \rangle} = 1 - \frac{\rho \Sigma_N}{f_\pi^2 m_\pi^2}. \quad (16)$$

The higher order corrections arise essentially from the modification of the pion number in the nucleus, which is expected to produce at normal density a mild acceleration of the restoration process (at density ρ_0 , Σ_A differs from Σ_N by $\approx 10\%$). There is no reaction against the restoration, contrary to what can be expected from

PCAC. In the next paragraph we go to a representation which possesses PCAC, so as to elucidate the role of the distortion.

The PCAC representation corresponds to $\sin(F) = x$, with a subsequent transformation of the pion field:

$$\vec{\varphi} = \vec{\phi} \left(1 - \frac{\Sigma_N \bar{N} N}{f_\pi^2 m_\pi^2} \right).$$

The chiral symmetry breaking lagrangian, expressed in the new variable $\vec{\varphi}$ reads:

$$\begin{aligned} \mathcal{L}'_{CSB} &= f_\pi^2 m_\pi^2 \left(1 - \frac{\Sigma_N \bar{N} N}{f_\pi^2 m_\pi^2} \right) \left[1 - \frac{\varphi^2 / f_\pi^2}{(1 - \Sigma_N \bar{N} N / f_\pi^2 m_\pi^2)^2} \right]^{1/2} \\ &\approx f_\pi^2 m_\pi^2 \left(1 - \frac{\Sigma_N \bar{N} N}{f_\pi^2 m_\pi^2} \right) - \frac{1}{2} m_\pi^2 \frac{\varphi^2}{(1 - \Sigma_N \bar{N} N / f_\pi^2 m_\pi^2)} + O(\varphi^4). \end{aligned} \quad (17)$$

Note that in this representation the contact term $-\frac{1}{2} (\Sigma_N / f_\pi^2) \varphi^2 \bar{N} N$, and hence also the soft pion amplitude on the nucleon, has the opposite sign as compared to the previous Weinberg type representation. However the physical amplitude is the same as will be shown below. The PCAC relation which is now valid, allows the calculation of the nuclear sigma commutator as a soft pion amplitude. If we ignore for the moment the one pion and two pion exchange contributions, the soft amplitude per unit volume is in the Born approximation:

$$T_s^{Born} = \frac{\rho \Sigma_N / f_\pi^2}{(1 - \rho \Sigma_N / f_\pi^2 m_\pi^2)} \quad (18)$$

as follows readily from the interaction part of the Lagrangian eq. (17). It displays a renormalization by higher order terms in the density, similar, but not equal, to the σ meson exchange terms of Birse and Mc Govern [8]. Here they appear from contact terms in the Lagrangian since the σ meson mass is sent to infinity in the non-linear version. The distortion of the soft pion wave modifies the Born amplitude in such a way that the free nucleon amplitude is recovered:

$$T_s = \frac{T_s^{Born}}{(1 + T_s^{Born} / m_\pi^2)} = \frac{\rho \Sigma_N}{f_\pi^2}. \quad (19)$$

The soft pion amplitude per nucleon and hence the sigma commutator Σ_A is the same as the free one. Here the distortion is exactly cancelled by the contact term, contrary to what happens in the linear sigma model where it is overcompensated. The expression of the quark condensate density is the same as in the Weinberg representation, as it should [10]. The introduction of pion exchange effects does not alter this result at least to second order in the density. Indeed the one pion

contribution is obviously the same. As for the two pion exchange eqs. (13) and (14), the change of sign of the contact term does not influence the result as it appears quadratically in $V_{ct}^{2\pi}$. It is illustrative to check the independence on the Lagrangian also on the pion effective mass in the medium, m_π^* , which obeys the equation

$$m_\pi^{*2} = m_\pi^2 + \Pi(m_\pi^*, 0) \quad (20)$$

where $\Pi(m_\pi^*, 0)$ is the pion self energy, taken at the energy $\omega = m_\pi^*$ and at zero three momentum. To find this last quantity we need the off-shell πN amplitude. For simplicity, we neglect the small nucleon pole terms which would not change the validity of the argument. In the representation of Weinberg the amplitude keeps the same value, $-\Sigma_N/f_\pi^2$, off- and on-shell. In this case the effective mass has a very simple linear density dependence:

$$\frac{m_\pi^{*2}}{m_\pi^2} = 1 - \frac{\rho \Sigma_N}{f_\pi^2 m_\pi^2}. \quad (21)$$

In the PCAC representation instead, the πN amplitude has a complex off shell behaviour. Indeed it gets also a contribution from the pion kinetic energy term, $\frac{1}{2} D_\mu \vec{\phi} \cdot D^\mu \vec{\phi}$ which expressed in the new field $\vec{\varphi}$ variable writes:

$$\begin{aligned} \frac{1}{2} D_\mu \vec{\phi} \cdot D^\mu \vec{\phi} &\approx \frac{1}{2} \frac{\partial_\mu \vec{\varphi} \cdot \partial^\mu \vec{\varphi}}{(1 - \Sigma_N \bar{N} N / f_\pi^2 m_\pi^2)^2} + \frac{\Sigma_N}{f_\pi^2 m_\pi^2} \frac{\vec{\varphi} \cdot \partial_\mu \vec{\varphi} \partial^\mu (\bar{N} N)}{(1 - \Sigma_N \bar{N} N / f_\pi^2 m_\pi^2)^3} \\ &+ \frac{\Sigma_N^2}{2 f_\pi^4 m_\pi^4} \frac{\varphi^2 \partial_\mu (\bar{N} N) \partial^\mu (\bar{N} N)}{(1 - \Sigma_N \bar{N} N / f_\pi^2 m_\pi^2)^4} + O(\varphi^4), \end{aligned} \quad (22)$$

where the operators $D_\mu = \partial_\mu \phi / (1 + \phi^2 / 4 f_\pi^2)$ are covariant derivatives acting on the pion field. The presence of the nucleon fields in this expression leads to new contributions to the πN amplitude which takes the form:

$$\bar{t}_{\pi N} = \frac{\Sigma_N}{f_\pi^2} \left(1 - \frac{q^2 + q'^2}{m_\pi^2} \right) \quad (23)$$

where q and q' are the initial and final pion four momenta ($q^2 \equiv \omega^2 - \vec{q}^2$) and the bar over $t_{\pi N}$ indicates that the PV nucleon poles have not been considered. This expression satisfies Adler consistency conditions, together with the well known sign change between the soft and Cheng-Dashen points. Notice that the physical amplitude is $\bar{t}_{\pi N} = -\Sigma_N/f_\pi^2$ as in the Weinberg representation. The nuclear Born amplitude T^{Born} , which is also the pion self-energy Π , writes:

$$T^{Born}(q^2) \equiv \Pi(\omega, \vec{q}) = m_\pi^2 \frac{x}{(1-x)} - q^2 \frac{2x-x^2}{(1-x)^2} \quad (24)$$

where $x = \rho\Sigma_N/f_\pi^2 m_\pi^2$. In this expression, as in eq. (18), the first piece in m_π^2 derives from the interaction part in the pion mass term of eq. (17). The second piece in q^2 arises in the same way from the interaction part of the kinetic energy term (eq. (22), first term).

The effective mass then obeys the equation:

$$m_\pi^{*2} \left(1 + \frac{2x - x^2}{(1-x)^2} \right) = \frac{m_\pi^2}{(1-x)} \quad (25)$$

which leads to the same result as the Weinberg Lagrangian eq. (21), with the linear density dependence of m_π^{*2} . The mass is indeed independent on the representation.

Notice however that the simple linear drop of eq. (21) which could lead to s-wave pion condensation [20] does not occur in reality, because the non-linear Lagrangian as introduced previously is incomplete. It fails to reproduce the (nearly) vanishing observed of the non-Born πN amplitude at threshold (see ref. [21] for a general low energy amplitude with this property). It is then necessary to introduce extra terms, which are chirally invariant, so as to produce the threshold cancellation. Following refs. [22, 23], we add to the previous Lagrangian a piece $\Delta\mathcal{L}$:

$$\Delta\mathcal{L} = \left(\frac{c_2}{f_\pi^2} (v_\mu D^\mu \vec{\phi})^2 + \frac{c_3}{f_\pi^2} D_\mu \vec{\phi} \cdot D^\mu \vec{\phi} \right) \bar{N} N, \quad (26)$$

where v_μ is the nucleon four-velocity which reduces to (1,0,0,0) in the nucleon rest frame. This extra piece does not change the condensate but it modifies the effective mass:

$$\frac{m_\pi^{*2}}{m_\pi^2} = \frac{1 - \rho\Sigma_N/f_\pi^2 m_\pi^2}{1 + 2\rho(c_2 + c_3)/f_\pi^2}. \quad (27)$$

The threshold cancellation of the non-Born amplitude implies $2(c_2 + c_3)m_\pi^2 \approx -\Sigma_N$ such that $m_\pi^{*2}/m_\pi^2 \approx 1$. This last relation was first derived by Delorme *et al.* on a multiple scattering basis [21]. It was later found by Thorsson and Wirzba in a chiral Lagrangian approach [24].

We summarize the discussion of this section in table 2 where we compare the results obtained with the Weinberg and PCAC Lagrangians for the amplitudes and the observables. We also give there the expression of the inverse pion propagator $D_\pi^{-1}(\omega, \vec{q})$ in the two cases. They are identical up to a factor $(1-x)^2$, with in particular the same dispersion law. In the case of the PCAC Lagrangian we recover the propagator already given by Thorsson and Wirzba [24]. We could have discussed also the behaviour of the nucleon effective mass M^* . Retaining only the s-wave pion-nucleon interaction we would get to first order in the density: $M^*/M = 1 + \Delta\Sigma_2^\pi/\rho M +$ terms in c_2, c_3 . It is seen that this is a very small correction which bears no resemblance with the evolution of the condensate (16). In fact, in the effective Lagrangian approach [17],[18] the nucleon effective mass is mainly governed by a contact term $\frac{1}{2}C_S^2(\bar{\psi}\psi)(\bar{\psi}\psi)$ which is a chiral invariant and thus does not contribute

to the σ term (12). We get then: $M^*/M = 1 - \rho C_S^2/M$ with no relation to the condensate, contrary to what occurred, at least in the absence of correlations, in the linear sigma model (see table 1). The latter situation is however quite peculiar in that the nucleon mass is generated by spontaneous symmetry breaking. It may happen of course that, at the deeper level of QCD, the phenomenological coefficients $M, C_S^2, \Sigma_N \dots$ of the non linear Lagrangians are connected so that the evolution of the nucleon effective mass and that of the quark condensate become similar.

We will now discuss the influence of the correlations on the condensate. In the representation of Weinberg it is clear that the quark condensate cannot be affected by the incoherent rescattering of the soft pions discussed in ref. [9] since the nuclear sigma commutator bears no relation to the soft pion amplitude. On the other hand it is interesting to understand in the representation in which PCAC holds how the effect of incoherent rescattering can be cancelled in the soft pion amplitude which is the sigma commutator. This investigation is also interesting in connection with the scattering of physical pions. Indeed the isospin symmetric optical potential is strongly influenced by the correlations, as the corresponding πN scattering length is very small. The incoherent rescattering effect linked to the charge-exchange amplitude has been discussed a long time ago [15]. The one linked to the isospin-symmetric amplitude is more debatable as the off-shell behaviour of this amplitude is model dependent. In the PCAC representation it is given by expression (23). We will first discuss the role of the correlations on the soft pion amplitude and then we extend the result to the physical threshold pions.

We limit our consideration to two-body correlations and hence we work to second order in the density. To this order and in the soft limit the relevant pieces of the Lagrangian in the PCAC representation are:

$$\begin{aligned} \mathcal{L}_{soft} \approx & \frac{1}{2} \frac{\Sigma_N}{f_\pi^2} \varphi^2 \bar{N} N \\ & + \frac{1}{2} \frac{\Sigma_N^2}{f_\pi^4 m_\pi^2} \varphi^2 (\bar{N} N)^2 - \frac{1}{2} \frac{\Sigma_N^2}{f_\pi^4 m_\pi^4} \varphi^2 \partial_\mu (\bar{N} N) \partial^\mu (\bar{N} N) \end{aligned} \quad (28)$$

In a correlated medium the amplitude can be evaluated from the graphs of fig. 6 and 7. Those of fig. 6 are the contact terms while those of fig. 7 represent the coherent and incoherent rescattering. The latter corresponds to the Lorentz-Lorenz effect well known in the p-wave case. In the absence of correlations and in the static approximation only the first two pieces of the Lagrangian eq. (28) contribute an amount (graphs 6a and 6b):

$$T_1 = m_\pi^2 x(1+x) \quad (29)$$

which is nothing else than the expansion of $x/(1-x)$ of formula (18). With correlations the graph 6c gives:

$$T_2 = m_\pi^2 x^2 \int \frac{d\vec{q}''}{(2\pi)^3} (m_\pi^2 + q''^2) G(\vec{q}'') \quad (30)$$

where the two parts in the integrand arise from the second and third pieces of the Lagrangian respectively. The rescattering terms 7a and 7b add:

$$T_3 = -m_\pi^2 x^2 \left(1 + \int \frac{d\vec{q}''}{(2\pi)^3} \frac{(m_\pi^2 + q''^2)^2}{(m_\pi^2 + q''^2)} G(\vec{q}'') \right). \quad (31)$$

Summing all the pieces the total soft pion amplitude thus reduces to:

$$T = T_1 + T_2 + T_3 = \rho \Sigma_N / f_\pi^2. \quad (32)$$

The overall effect of the correlations disappears due to cancellation between the Lorentz-Lorenz term (*i.e.* the incoherent rescattering of graph 7b) and the correlation contribution in the contact terms. The soft amplitude and hence the sigma commutator are affected neither by distortion nor by correlations. Thus we recover the result of the Weinberg type Lagrangian.

It is natural to extend our study to the case of threshold physical pions, as we did in the linear sigma model. Our aim is first to understand if, in the non-linear model, chiral symmetry imposes the existence of two-body terms in the s-wave optical potential. This was the case in the linear sigma model. The second point is to make a quantitative evaluation of the influence of the correlations linked to the isospin symmetric πN amplitude.

Concerning the first point we recall that in the PCAC representation and for soft pions contact terms are needed to cancel the distortion. The question is then: are these contact terms present in the s-wave optical potential as it is the case in the linear sigma model? In the Weinberg representation contact terms are totally absent. Their cancellation is therefore plausible in the PCAC representation. The problem is to understand the mechanism for cancellation. For simplicity we ignore the extra terms in c_2 and c_3 which do not change the essence of the discussion.

In the PCAC representation the pion self energy has been given in eq. (24). It displays a priori many body terms. Threshold pions correspond to the situation where $\omega = m_\pi$, $\vec{q} = 0$ which are valid outside the nucleus. For the inside conditions we take the example of a spherical nucleus with a uniform density. In the interior of the nucleus the pion keeps its energy and acquires a momentum q_{eff} solution of the dispersion equation:

$$m_\pi^2 = q_{eff}^2 + m_\pi^2 + \Pi(m_\pi, q_{eff}), \quad (33)$$

which gives $q_{eff}^2 = -m_\pi^2 x$ such that $q^2 = m_\pi^2(1 - x)$. In the usual expression of the potential $2m_\pi V_{opt} = -\left(1 + \frac{m_\pi}{M}\right) 4\pi b_0 \rho$ the momentum dependence is not explicitly taken into account but it has to be implicitly incorporated in the parameter b_0 as follows:

$$-\left(1 + \frac{m_\pi}{M}\right) 4\pi b_0 \rho = \Pi(m_\pi, q_{eff}) = m_\pi^2 \left[\frac{x}{(1-x)} - (1-x) \frac{2x-x^2}{(1-x)^2} \right] = -\rho \Sigma_N f_\pi^2. \quad (34)$$

This expression displays no two-body terms and is the same as for the Weinberg Lagrangian. Thus in the PCAC representation of the non-linear sigma model the momentum dependence of the self energy is such that many body terms are absent in the s-wave optical potential. In the linear model instead, the πN amplitude $\bar{t}_{\pi N} = \frac{g}{f_\pi} ; \frac{m_\pi^2 - t}{m_\sigma^2 - t}$ which also satisfies the Adler condition, depends only on the four momentum transfer variable t so that in the forward direction there is no three momentum dependence. Hence the self energy is momentum independent and there is no cancellation of the contact terms. In that respect the non-linear and linear sigma models are quite different.

We now turn to the influence of correlations on the s-wave pion-nucleus optical potential. For this purpose it is simpler to use the Weinberg Lagrangian supplemented with the $\Delta\mathcal{L}$ term introduced previously in eq. (26). Indeed in this case there are no two-body contact terms and correlations enter only as a Lorentz-Lorenz effect. For pions at rest with energy ω the amplitude in the Born approximation (*i.e.* the pion self-energy) takes the following form in a correlated medium:

$$T^{Born} \equiv \Pi(\omega, 0) = \rho t_{\pi N}(\omega, 0) \left[1 - \rho t_{\pi N}(\omega, 0) \int d\vec{q}'' \frac{G(\vec{q}'')}{(q''^2 + m_\pi^2 - \omega^2)} \right]. \quad (35)$$

Here $t_{\pi N}(\omega, 0)$ is the full off-shell πN amplitude including the nucleon poles in pseudovector coupling (first term on the right hand side of the following equation):

$$t_{\pi N}(\omega, 0) = g^2 \frac{\omega^2}{4M^3} - \frac{\Sigma_N}{f_\pi^2} \left(1 + \frac{2(c_2 + c_3)\omega^2}{\Sigma_N} \right). \quad (36)$$

The s-wave pion optical potential is obtained from the self-energy eq. (35) taken at $\omega = m_\pi$: $2m_\pi V_{opt} = \Pi(m_\pi, 0)$. The pole terms can be ignored in the part with the correlation integral which gives a very small contribution. As for the remaining terms the effect of the correlations is totally negligible due to the cancellation which occurs at threshold $\Sigma_N + 2(c_2 + c_3)m_\pi^2 \approx 0$. The same conclusion would be obtained in a more complicated way with the PCAC representation. Thus we can conclude that only the incoherent rescattering with charge exchange, which has not been introduced in the present discussion, is relevant for the s-wave optical potential, at variance with the findings of Salcedo *et al.* [25].

One conclusion of our study with the non-linear sigma model is the absence of two-body terms in the nuclear sigma commutator Σ_A (apart from those due to pion exchange) and in the s-wave optical potential. The meaning of this statement is that chiral symmetry does not impose them. They can nevertheless be present. Indeed we have used the simplest forms of the chiral Lagrangians. At the same order in the chiral expansion one can add terms quadratic in the nucleon density, either breaking chiral symmetry such as $\phi^2/(1+\phi^2/4f_\pi^2)(\bar{\psi}\psi)^2$ or conserving it as e.g. $D_\mu \vec{\phi} \cdot D^\mu \vec{\phi} (\bar{\psi}\psi)^2$. In the spirit of chiral perturbation expansions their coefficients are

phenomenological and should be determined by experiment though their order of magnitude can be guessed by dimensional counting arguments [18, 26]. A priori they can be of any sign, accelerating or hindering chiral symmetry restoration. We are planning to explore which experiments can be informative on these terms, beyond the obvious one of pion-nucleus scattering.

4 Conclusion

To conclude the present study, we have investigated the evolution with density of the quark condensate beyond the approximation of non interacting nucleons. In the non-linear sigma model we have found that the calculable correction to the linear dependence of the quark condensate arises from the one pion and two pion exchange potentials. The first one has been already discussed by Chanfray and Ericson [4]. As for the latter we have evaluated it in the framework of the non linear model and found it to be small. However we stress that this is only a part of the two pion exchange potential, the part linked to the contact s-wave π -nucleon amplitude. The bulk of the potential arises from the p-wave coupling terms which is outside the present approach. The evaluation of its role is in progress. Chiral symmetry does not impose other two-body contributions contrary to what occurs in the linear sigma model. They can nevertheless be present but have to be determined empirically. In particular there is no systematic reaction against the restoration of chiral symmetry.

Since the quark condensate is the order parameter of chiral symmetry, it is intimately linked to the physics of the pion which is the Goldstone boson of this symmetry in the broken phase. It is thus natural to search for relations between the modification of the condensate in the nuclear medium and the pion nucleus interaction. The absence of two-body terms imposed by chiral symmetry in the condensate reflects in their absence in the π -nucleus optical potential. The possible ones have to be determined empirically. We have also found that correlations act only through the well known incoherent rescattering with charge exchange.

5 Acknowledgement

We are grateful to Dr. T. Ericson for stimulating discussions.

References

- [1] E.G. Drukarev and E.M. Levin, Nucl. Phys. A511 (1990) 679; Progr.Part.Nucl. 27 (1991) 77.
- [2] T.D. Cohen, R.J. Furnstahl and D.K. Griegel, Phys. Rev. C45 (1992) 1881.
- [3] M. Lutz, S. Klimt and W. Weise, Nucl. Phys. A542 (1992) 521.
- [4] G. Chanfray and M. Ericson, Nucl. Phys. A556 (1993) 427.
- [5] M. Ericson, Phys. Lett. B301 (1993) 11.
- [6] G. Q. Li and C. M. Ko, Phys. Lett. B338 (1994) 118.
- [7] R. Brockmann and W. Weise, Phys. Lett. B367 (1996) 40.
- [8] M.C. Birse and J.A. Mc Govern, Phys. Lett. B309 (1993) 231.
- [9] T. Ericson, Phys. Lett. B321 (1994) 312.
- [10] S. Coleman, J. Wess and B. Zumino, Phys. Rev. 177 (1969) 2239.
- [11] W. Weise, Nucl. Phys. A278 (1977) 402.
- [12] J. Gasser, H. Leutwyler and M.E. Sainio, Phys. Lett. B253 (1991) 260.
- [13] J. Gasser, H. Leutwyler and M.E. Sainio, Phys. Lett. B253 (1991) 252.
- [14] T. Ericson and W. Weise, Pions in Nuclei (Clarendon Press, Oxford 1988).
- [15] M. Ericson and T. Ericson, Annals of Physics (N.Y.) 36 (1966) 323.
- [16] R. Seki and K. Masutani, Phys. Rev. C27 (1983) 2799.
- [17] S. Weinberg, Phys. Lett. B251 (1990) 288; Nucl. Phys. B363 (1991) 3.
- [18] B.W. Lynn, Nucl. Phys. B402 (1993) 281.
- [19] S. Weinberg, Phys. Rev. 33 (1968) 1568.
- [20] G.E. Brown, V. Koch and M. Rho, Nucl. Phys. A535 (1991) 701.
- [21] J. Delorme, M. Ericson and T. Ericson, Phys. Lett. B291 (1992) 379.
- [22] J. Gasser, M.E. Sainio and A. Švarc, Nucl. Phys. B307 (1988) 779.
- [23] V. Bernard, N. Kaiser and U.-G. Meißner, Phys. Lett. B309 (1993) 421.
- [24] V. Thorsson and A. Wirzba, Nucl. Phys. A589 (1995) 633.

[25] L.L. Salcedo, K. Holinde, E. Oset and C. Schütz, Phys. Lett. B353 (1995) 1.

[26] A. Manohar and H. Georgi, Nucl. Phys. B234 (1984) 189.

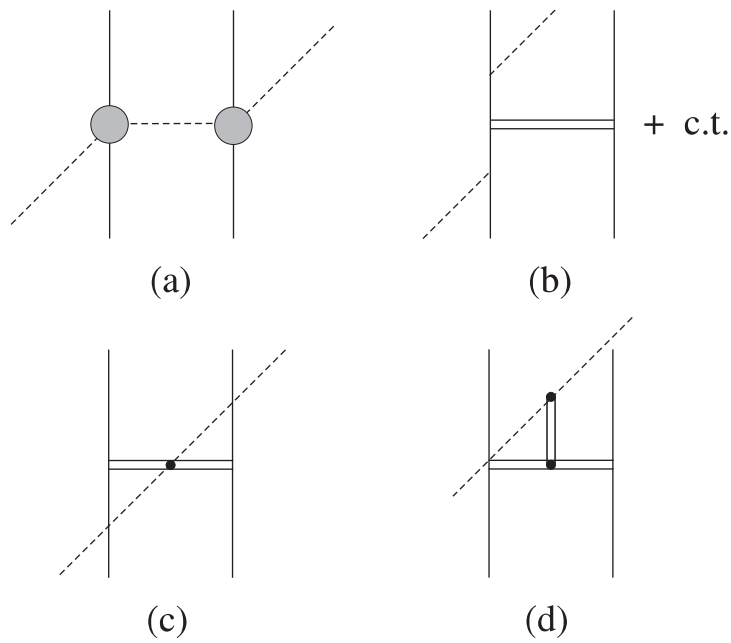

Figure 1: Two-body contributions to soft pion scattering in the linear sigma model. Graph (a) is the coherent rescattering term where the round boxes represent the pion-nucleon scattering amplitude. Exchange of the σ meson (double lines) gives rise to graphs (b) to (d).

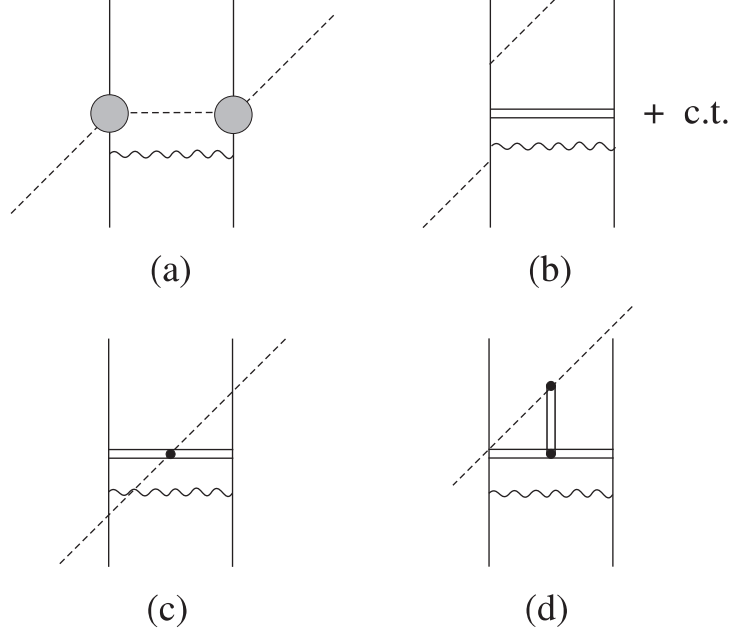

Figure 2: Same as for fig. 1 with wiggled lines standing for short-range correlations. Here graph (a) represents incoherent rescattering.

Table 1: Evolution of the quark condensate and the effective nucleon mass to second order in the nuclear density in the linear sigma model. The third term in the formula for M^*/M is obtained after approximated treatment of the graphs with 2 and 3 correlation functions. The numbers in third column are given for density $\rho = \rho_0$.

$\langle \bar{q}q(\rho) \rangle / \langle \bar{q}q(0) \rangle$ (condensate)	$1 - \frac{\rho \Sigma_N}{f_\pi^2 m_\pi^2} - \frac{3}{2} \frac{\rho^2 \Sigma_N^2}{f_\pi^4 m_\pi^4} \left(1 - \frac{1}{(1 + q_c^2/m_\sigma^2)^2} \right)$	0.54
M^*/M	$1 - \frac{\rho \Sigma_N}{f_\pi^2 m_\pi^2} \left(1 - \frac{1}{(1 + q_c^2/m_\sigma^2)} \right) - \frac{3}{2} \frac{\rho^2 \Sigma_N^2}{f_\pi^4 m_\pi^4} \left(1 - \frac{1}{(1 + q_c^2/m_\sigma^2)^2} \right)$	0.71

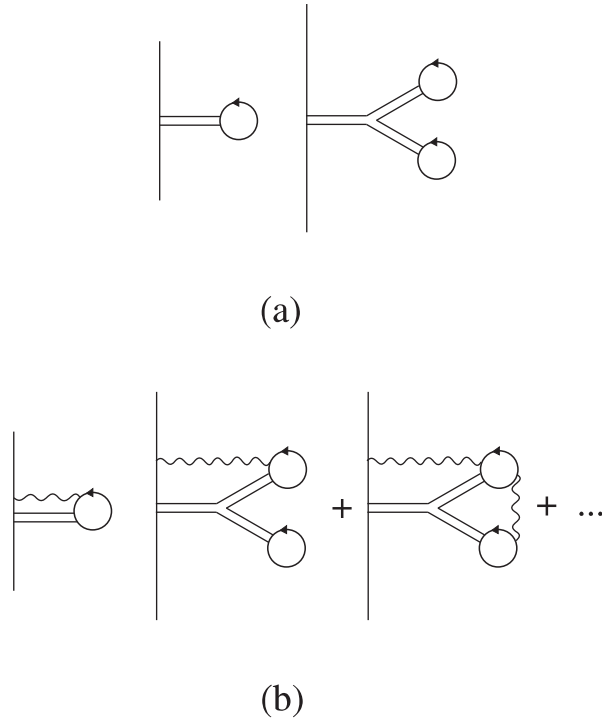

Figure 3: Contributions to the effective nucleon mass up to second order in density in the linear sigma model without (a) and with (b) correlations. At the order ρ^2 there are three graphs with one correlation functions, three with two and one with three (not shown).

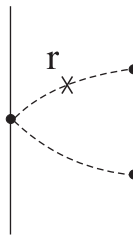

Figure 4: Interference between s- and p-wave pion nucleon couplings not considered in the evaluation of the σ -term (12). The cross marked with an r denotes the place where the operator σ_{op} acts.

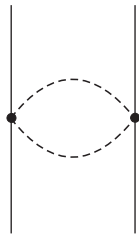

Figure 5: Two pion exchange potential linked to the s-wave contact term $V_{ct}^{2\pi}$ (15).

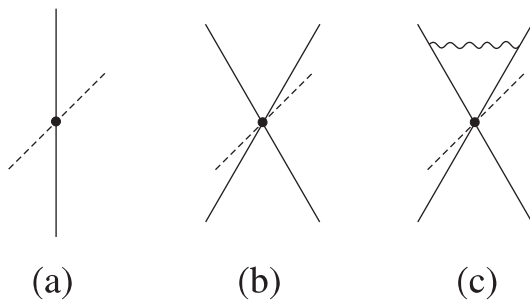

Figure 6: Soft pion scattering up to second order in density in a non-linear Lagrangian satisfying PCAC (28). Graph (a) and (b) are one- and two-body contact terms with correlations absent in the latter. Correlations (wiggly line) are instead accounted for by graph (c).

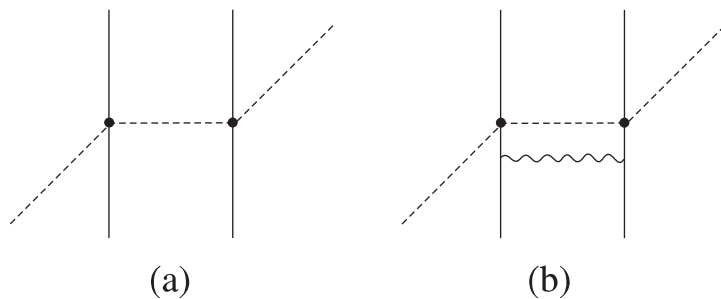

Figure 7: Same as fig. 6 but for the case of coherent (a) and incoherent (b) rescattering.

Table 2: Comparison of the results obtained with two non-linear Lagrangians, \mathcal{L}^W which does not satisfies PCAC and \mathcal{L}' which does. The successive lines give the pion-nucleon amplitude, soft pion-nucleus amplitude, pion self-energy (or Born pion-nucleus amplitude), inverse pion propagator, squared pion effective mass and density evolution of the quark condensate. For simplicity the nucleon PV pole terms are not included in the calculation. We use $x = \rho\Sigma_N/f_\pi^2 m_\pi^2$ as in the text and we define $x_{2,3} = \rho c_{2,3}/f_\pi^2$.

	\mathcal{L}^W	\mathcal{L}'
$\bar{t}_{\pi N}$	$-\frac{\Sigma_N}{f_\pi^2}$	$\frac{\Sigma_N}{f_\pi^2} \left(1 - \frac{q^2 + q'^2}{m_\pi^2}\right) - \frac{2(c_2\nu^2 + c_3 2M\nu_B)}{f_\pi^2}$
$\frac{T_s}{m_\pi^2}$	$-x/(1-x)$	$\frac{x/(1-x)}{1+x/(1-x)} = x$
$\frac{\Pi(\omega, \vec{q})}{m_\pi^2}$	$-x - 2(x_2 + x_3) \frac{\omega^2}{m_\pi^2} + 2x_3 \frac{\vec{q}^2}{m_\pi^2}$	$\frac{x}{(1-x)} - \frac{2(x+x_2+x_3) - x^2}{(1-x)^2} \frac{\omega^2}{m_\pi^2} + \frac{2(x+x_3) - x^2}{(1-x)^2} \frac{\vec{q}^2}{m_\pi^2}$
$D_\pi^{-1}(\omega, \vec{q})$	$[1 + 2(x_2 + x_3)]\omega^2 - (1 + 2x_3)\vec{q}^2 - (1-x)m_\pi^2$	$\left[[1 + 2(x_2 + x_3)]\omega^2 - (1 + 2x_3)\vec{q}^2 - (1-x)m_\pi^2 \right] / (1-x)^2$
$\frac{m_\pi^{*2}}{m_\pi^2}$	$\frac{1-x}{1+2(x_2+x_3)}$	$\frac{1-x}{1+2(x_2+x_3)}$
$\frac{\langle \bar{q}q(\rho) \rangle}{\langle \bar{q}q(0) \rangle}$	$1-x$	$1-x$