

# General Operads and Multicategories

Tom Leinster

Department of Pure Mathematics, University of Cambridge

Email: leinster@dpmms.cam.ac.uk

Web: <http://www.dpmms.cam.ac.uk/~leinster>

12 October, 1997

Minor amendments Dec 97, Oct 98

## Abstract

Notions of ‘operad’ and ‘multicategory’ abound. This work provides a single framework in which many of these various notions can be expressed. Explicitly: given a monad  $*$  on a category  $\mathcal{S}$ , we define the term  $(\mathcal{S}, *)$ -*multicategory*, subject to certain conditions on  $\mathcal{S}$  and  $*$ . Different choices of  $\mathcal{S}$  and  $*$  give some of the existing notions. We then describe the *algebras* for an  $(\mathcal{S}, *)$ -multicategory and, finally, present a tentative selection of further developments. Our approach makes possible concise descriptions of Baez and Dolan’s opetopes and Batanin’s operads; both of these are included.

## Contents

	Introduction	1
1	Cartesian Monads	3
2	Multicategories	9
3	Algebras	17
4	Further Developments	23
	References	34

## Introduction

Operads, multicategories and the like have appeared in many different guises, especially recently. Investigators of  $n$ -categories (Baez-Dolan, Batanin, Hermida-Makkai-Power) have had cause to resurrect and generalize in various ways the original May definition of c.1970. The work of Soibelman and of Borchers, related to topological quantum field theory and vertex algebras, calls upon still different ideas of multicategory.

It is the aim of this article to unify some, if not all, of these approaches. Where it works, it provides a single formalism in which these various notions can be expressed simply and perhaps compared. It does succeed in capturing the ‘traditional’ definitions of (non-symmetric) operad and multicategory, the Batanin operads, and at least some of the flavour of Baez-Dolan, Soibelman and Borchers. (An optimist might even imagine that it would facilitate the comparison of different definitions of weak  $n$ -category.) A notable failure is that the symmetric group actions often included in definitions of ‘operad’ are not easily expressed in our system, for the time being at least.

The central idea is simple. In a plain category, an arrow  $a$  is written

$$s' \xrightarrow{a} s,$$

where  $s'$  and  $s$  are elements of the set  $S$  of objects. In an ‘ordinary’ multicategory, an arrow  $a$  is written

$$s_1, \dots, s_n \xrightarrow{a} s,$$

where  $s$  is an element of the set  $S$  of objects,  $\langle s_1, \dots, s_n \rangle$  is an element of  $S^*$ , and  $*$  is the free-monoid monad (‘word monad’) on **Sets**. Thus the graph structure of the multicategory is a diagram

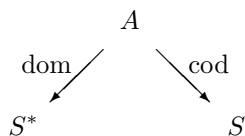

in **Sets**, where  $A$  is the set of arrows. Now, just as a (small) category can be described as a diagram

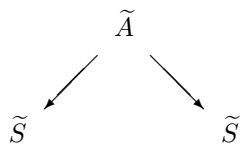

in **Sets** together with identity and composition functions

$$\tilde{S} \longrightarrow \tilde{A}, \quad \tilde{A} \times_{\tilde{S}} \tilde{A} \longrightarrow \tilde{A}$$

satisfying some axioms, so we may describe the multicategory structure on

$A$

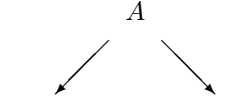

by manipulation of certain diagrams in **Sets**. In general,

$S^*$  we take a category  $\mathcal{S}$  and a monad  $*$  on  $\mathcal{S}$ , and, subject to certain conditions, define ‘ $(\mathcal{S}, *)$ -multicategory’. Thus a category is a  $(\mathbf{Sets}, id)$ -multicategory, and an ordinary multicategory is a  $(\mathbf{Sets}, \text{free monoid})$ -multicategory.

Section 1 describes the simple conditions needed on  $\mathcal{S}$  and  $*$  in order that everything that follows will work. Many examples are given. Section 2 explains what an  $(\mathcal{S}, *)$ -multicategory is and how the examples relate to existing notions of multicategory. In particular, a concise definition of Batanin operads is given. Most of these existing notions carry with them the concept of an *algebra* for an operad/multicategory; section 3 defines algebras in our general setting. Finally, this being work in motion, section 4 is a collection of loose topics and possible further developments, of assorted merit. Included is a compact construction of Baez and Dolan’s opetopes.

## Related Work

Since the original posting of this document, various pieces of related work have been pointed out to me. The basic construction of  $(\mathcal{S}, *)$ -multicategories was carried out by Burroni ([Bur]) in 1971, under the (better?) name of  $T$ -categories, where  $T = *$  is the monad concerned. He develops the theory extensively, although in what direction I do not yet know. This reference was passed on to me by Claudio Hermida, who also, independently, made this definition (and more). Notes from talks he has given on the subject are available ([Her]). The present work is also connected to Kelly’s theory of clubs, for which see [Kel1] and [Kel2].

## Acknowledgements

This work was supported by a PhD grant from EPSRC. It was prepared in  $\LaTeX$  using Paul Taylor’s commutative diagrams package. My thanks go to Martin Hyland for encouraging me to pursue this line of enquiry. I am also grateful to Peter Johnstone, Craig Snyder and Robin Cockett, for help and useful discussions.

# 1 Cartesian Monads

In this section we introduce the conditions required on a monad  $(( )^*, \eta, \mu)$  on a category  $\mathcal{S}$ , in order that we may (in Section 2) define the notion of an  $(\mathcal{S}, *)$ -multicategory. Like most conditions that follow, the demand is that certain things are or preserve pullbacks.

**Definition 1.1** *A monad  $(( )^*, \eta, \mu)$  on a category  $\mathcal{S}$  will be called cartesian if*

- i.  $\eta$  and  $\mu$  are cartesian natural transformations, i.e. for any  $X \xrightarrow{f} Y$  in  $\mathcal{S}$  the naturality squares*

$$\begin{array}{ccc} X & \xrightarrow{\eta_X} & X^* \\ f \downarrow & & \downarrow f^* \\ Y & \xrightarrow{\eta_Y} & Y^* \end{array} \quad \text{and} \quad \begin{array}{ccc} X^{**} & \xrightarrow{\mu_X} & X^* \\ f^{**} \downarrow & & \downarrow f^* \\ Y^{**} & \xrightarrow{\mu_Y} & Y^* \end{array}$$

*are pullbacks, and*

- ii.  $(( )^*$  preserves pullbacks.*

(Conditions i and ii ensure that not just  $\eta$  and  $\mu$ , but *all* natural transformations  $(( )^{*n} \rightarrow (( )^{*m})$  arising from the monad, are cartesian. For instance,  $\mu * \eta^* : (( )^{***} \rightarrow (( )^{***})$  is cartesian.)

Checking that a particular monad is cartesian can be eased slightly by employing:

**Lemma 1.2** *Let  $\mathcal{S}$  be a category with a terminal object  $1$ . Then a monad  $(( )^*, \eta, \mu)$  on  $\mathcal{S}$  satisfies condition i of Definition 1.1 iff for any object  $Z$  of  $\mathcal{S}$ , the squares*

$$\begin{array}{ccc} Z & \xrightarrow{\eta_Z} & Z^* \\ ! \downarrow & & \downarrow !^* \\ 1 & \xrightarrow{\eta_1} & 1^* \end{array} \quad \text{and} \quad \begin{array}{ccc} Z^{**} & \xrightarrow{\mu_Z} & Z^* \\ !^{**} \downarrow & & \downarrow !^* \\ 1^{**} & \xrightarrow{\mu_1} & 1^* \end{array}$$

*are pullbacks, where  $!$  is the unique map  $Z \rightarrow 1$ .*

**Proof** Just use the fact that if in a commutative diagram

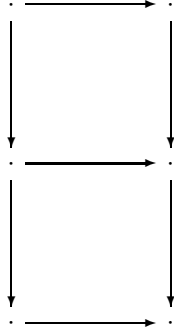

the outer rectangle and lower square are pullbacks, then so too is the upper square.  $\square$

The condition that  $\mathcal{S}$  must satisfy is:

**Definition 1.3** A category is called cartesian if it has all finite limits.

**Examples 1.4**

- i. The identity monad on any category is clearly cartesian.
- ii. Let  $\mathcal{S} = \mathbf{Sets}$  and let  $*$  be the monoid monad, i.e. the monad arising from the adjunction

$$\mathbf{Monoids} \begin{array}{c} \xrightarrow{\quad} \\ \lrcorner \\ \xleftarrow{\quad} \end{array} \mathbf{Sets}.$$

Certainly  $\mathcal{S}$  is cartesian. We show that  $*$ , too, is cartesian, using Lemma 1.2.

*Unit:* Observe that  $1^* = \mathbb{N}$ , that  $1 \xrightarrow{\eta_1} \mathbb{N}$  has image  $\{1\}$ , and that  $X^* \xrightarrow{!^*} \mathbb{N}$  sends a word  $\langle x_1, x_2, \dots, x_n \rangle$  to  $n \in \mathbb{N}$ . The square

$$\begin{array}{ccc}
 X & \xrightarrow{\eta_X} & X^* \\
 \downarrow ! & & \downarrow !^* \\
 1 & \xrightarrow{\eta_1} & 1^*
 \end{array}$$

is a pullback, as  $X \cong \{\langle x_1, \dots, x_n \rangle \in X^* \mid n = 1\}$ .

*Multiplication:* The map  $\mathbb{N}^* \xrightarrow{\mu_1} \mathbb{N}$  is  $\langle n_1, \dots, n_k \rangle \mapsto n_1 + \dots + n_k$ , and  $X^{**} \xrightarrow{!^{**}} \mathbb{N}^*$  is  $\langle \langle x_1^1, \dots, x_{n_1}^1 \rangle, \dots, \langle x_1^k, \dots, x_{n_k}^k \rangle \rangle \mapsto \langle n_1, \dots, n_k \rangle$ . The square

$$\begin{array}{ccc}
 X^{**} & \xrightarrow{\mu_X} & X^* \\
 \downarrow !^{**} & & \downarrow !^* \\
 \mathbb{N}^* & \xrightarrow{\mu_1} & \mathbb{N}
 \end{array}$$

is a pullback: for

$$\begin{aligned}
X^* \times_{\mathbb{N}} \mathbb{N}^* &\cong \{(\langle x_1, \dots, x_m \rangle, \langle n_1, \dots, n_k \rangle) \mid m = n_1 + \dots + n_k\} \\
&\cong \{(\langle x_1, \dots, x_{n_1} \rangle, \langle x_{n_1+1}, \dots, x_{n_1+n_2} \rangle, \dots, \langle \dots, x_{n_1+\dots+n_k} \rangle)\} \\
&\cong X^{**}.
\end{aligned}$$

*Pullback Preservation:* Let

$$\begin{array}{ccc}
P & \xrightarrow{\quad} & Y \\
\downarrow & & \downarrow g \\
X & \xrightarrow{\quad f \quad} & Z
\end{array}$$

be a pullback square: then

$$\begin{aligned}
X^* \times_{Z^*} Y^* &\cong \{(\langle x_1, \dots, x_n \rangle, \langle y_1, \dots, y_m \rangle) \mid \langle fx_1, \dots, fx_n \rangle = \langle gy_1, \dots, gy_m \rangle\} \\
&\cong \{(\langle x_1, y_1 \rangle, \dots, \langle x_n, y_n \rangle) \mid fx_i = gy_i \text{ for each } i\} \\
&\cong P^*.
\end{aligned}$$

- iii. A non-example. Let  $\mathcal{S} = \mathbf{Sets}$  and let  $((\ )^*, \eta, \mu)$  be the free commutative monoid monad. This is not cartesian: e.g. the naturality square for  $\mu$  at  $2 \longrightarrow 1$  is not a pullback.
- iv. Let  $\mathcal{S} = \mathbf{Sets}$ . Any finitary algebraic theory gives a monad on  $\mathcal{S}$ ; which are cartesian? Without answering this question completely, we indicate a certain class of theories which do give cartesian monads. An equation (made up of variables and finitary operators) is said to be *strongly regular* if the same variables appear in the same order, without repetition, on each side. Thus

$$(x.y).z = x.(y.z) \quad \text{and} \quad (x \uparrow y) \uparrow z = x \uparrow (y.z),$$

but not

$$x + (y + (-y)) = x, \quad x.y = y.x \quad \text{or} \quad (x.x).y = x.(x.y),$$

qualify. A theory is called *strongly regular* if it can be presented by operators and strongly regular equations. It may be apparent from Example ii that the only property we used of the theory of monoids was its strong regularity, and that in a similar way we could prove that any strongly regular theory yields a cartesian monad.

This last result, and the notion of strong regularity, are due to Carboni and Johnstone. They show in [CJ, Proposition 3.2 via Theorem 2.6] that a theory is strongly regular iff  $\eta$  and  $\mu$  are cartesian natural transformations

and  $(\ )^*$  preserves wide pullbacks. A *wide pullback* is by definition a limit of shape

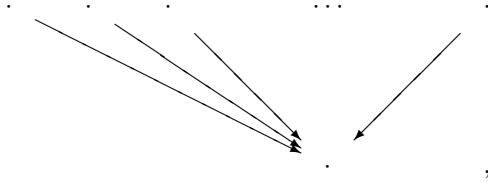



where the top row is a set of any size (perhaps infinite). When the set is of size 2 this is an ordinary pullback, so the monad from a strongly regular theory is indeed cartesian. (Examples v, vi, and vii can also be found in [CJ].)

- v. Let  $\mathcal{S} = \mathbf{Sets}$ , let  $E$  be a fixed set, and let  $+$  denote binary coproduct: then the endofunctor  $\_ + E$  on  $\mathcal{S}$  has a natural monad structure. This monad is cartesian, corresponding to the algebraic theory consisting only of one constant for each member of  $E$ .
- vi. Let  $\mathcal{S} = \mathbf{Sets}$  and let  $M$  be a monoid: then the endofunctor  $M \times \_$  on  $\mathcal{S}$  has a natural monad structure. This monad is cartesian, corresponding to an algebraic theory consisting only of unary operations.
- vii. Let  $\mathcal{S} = \mathbf{Sets}$ , and consider the finitary algebraic theory on  $\mathcal{S}$  generated by one  $n$ -ary operation for each  $n \in \mathbb{N}$ , and no equations. This theory is strongly regular, so the induced monad  $((\ )^*, \eta, \mu)$  on  $\mathcal{S}$  is cartesian.

If  $X$  is any set then  $X^*$  can be described inductively by:

- if  $x \in X$  then  $x \in X^*$
- if  $t_1, \dots, t_n \in X^*$  then  $\langle t_1, \dots, t_n \rangle \in X^*$ .

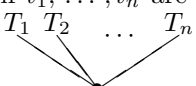
We can draw any element of  $X^*$  as a tree with leaves labelled by elements of  $X$ :

- $x \in X$  is drawn as  $\bullet^x$
- if  $t_1, \dots, t_n$  are drawn as  $T_1, \dots, T_n$  then  $\langle t_1, \dots, t_n \rangle$  is drawn as , or if  $n = 0$ , as .

Thus the element  $\langle \langle x_1, x_2, \langle \rangle \rangle, x_3, \langle x_4, x_5 \rangle \rangle$  of  $X^*$  is drawn as

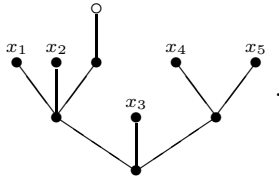

The unit  $X \longrightarrow X^*$  is  $x \mapsto \bullet^x$ , and multiplication  $X^{**} \longrightarrow X^*$  takes an  $X^*$ -labelled tree (e.g.

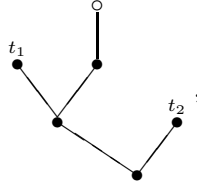

with

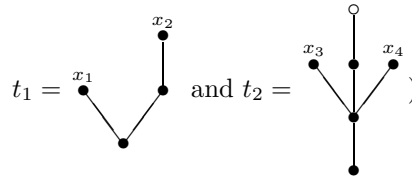

and gives an  $X$ -labelled tree by substituting at the leaves (here,

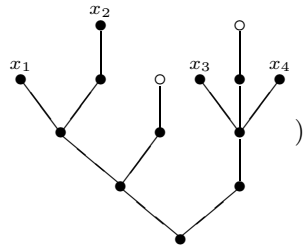

viii. On the category **Cat** of small categories and functors, there is the free strict monoidal category monad. Both **Cat** and the monad are cartesian.

ix. A *globular set* is a diagram

$$\cdots \rightrightarrows X_n \begin{array}{c} \xrightarrow{s} \\ \xrightarrow{t} \end{array} X_{n-1} \begin{array}{c} \xrightarrow{s} \\ \xrightarrow{t} \end{array} \cdots \rightrightarrows X_1 \begin{array}{c} \xrightarrow{s} \\ \xrightarrow{t} \end{array} X_0$$

in **Sets** satisfying the ‘globularity equations’  $ss = st$  and  $ts = tt$ . The underlying graph of a strict  $\omega$ -category is a globular set:  $X_n$  is the set of  $n$ -cells, and  $s$  and  $t$  are the source and target functions. One can construct the free strict  $\omega$ -category monad on the category of globular sets and show that it is cartesian. Moreover, the category of globular sets is cartesian, being a presheaf category.

x. A *double category* may be defined as a category object in **Cat**. More descriptively, the graph structure consists of collections of

- 0-cells  $A$
- horizontal 1-cells  $f$
- vertical 1-cells  $p$



- 2-cells  $\alpha$

and various source and target functions, as illustrated by the picture

$$\begin{array}{ccc}
 A_1 & \xrightarrow{f_1} & A_2 \\
 p_1 \downarrow & & \downarrow p_2 \\
 A_3 & \xrightarrow{f_2} & A_4
 \end{array}
 \quad .$$

The category structure consists of identities and composition functions for 2-cells and both kinds of 1-cell, obeying strict associativity, identity and interchange laws; see [KS] for more details.

More generally, let us define *n-cubical set* for any  $n \in \mathbb{N}$ ; the intention is that a 2-cubical set will be the underlying graph of a double category. So, let  $\mathbf{Cube}_n$  be the category with

**objects:** subsets  $D$  of  $\{0, 1, \dots, n-1\}$

**map**  $D \longrightarrow D'$ : the inclusion  $D \subseteq D'$ , together with a function  $D' \setminus D \longrightarrow \{0, 1\}$

**composition:** place functions side-by-side.

Then we define an *n-cubical set* to be a presheaf on  $\mathbf{Cube}_n$ . For instance, we may think of a 2-cubical set  $X$  as:

- $X\emptyset = \{0\text{-cells}\}$
- $X\{0\} = \{\text{horizontal 1-cells}\}$
- $X\{1\} = \{\text{vertical 1-cells}\}$
- $X\{0, 1\} = \{2\text{-cells}\}$

and, for instance, the map  $\{1\} \longrightarrow \{0, 1\}$  given by

$$\{0, 1\} \setminus \{1\} = \{0\} \xrightarrow{0} \{0, 1\}$$

sends  $\alpha \in X\{0, 1\}$  to  $p_1 \in X\{1\}$ , in the diagram above. In the context of functions  $D' \setminus D \longrightarrow \{0, 1\}$ , 0 should be read as ‘source’ and 1 as ‘target’.

We may now define a (*strict*) *n-tuple category* to be an *n-cubical set* together with various compositions and identities, as for double categories, all obeying strict laws. The category of *n-cubical sets* has on it the free strict *n-tuple category monad*; both category and monad are cartesian.

## 2 Multicategories

We now describe what an  $(\mathcal{S}, *)$ -multicategory is, where  $*$  is a cartesian monad on a cartesian category  $\mathcal{S}$ . As mentioned in the Introduction, this description is a generalization of the (well-known) description of a small category as a monad object in the bicategory of spans.

We will use the phrase ‘ $(\mathcal{S}, *)$  is cartesian’ to mean that  $\mathcal{S}$  is a cartesian category and  $((\ )^*, \eta, \mu)$  is a cartesian monad on  $\mathcal{S}$ .

### Construction 2.1

Let  $(\mathcal{S}, *)$  be cartesian. We construct a bicategory  $\mathcal{B}$  from  $(\mathcal{S}, *)$ , which in the case  $* = id$  is the bicategory of spans in  $\mathcal{S}$ .

**0-cell:** Object  $S$  of  $\mathcal{S}$ .

**1-cell**  $R \longrightarrow S$ : Diagram

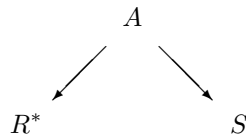

in  $\mathcal{S}$ .

**2-cell**  $A \longrightarrow A'$ : Commutative diagram

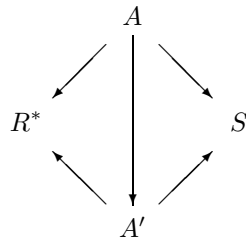

in  $\mathcal{S}$ .

**1-cell composition:** To define this we need to choose particular pullbacks in  $\mathcal{S}$ , and in everything that follows we assume this has been done. Take

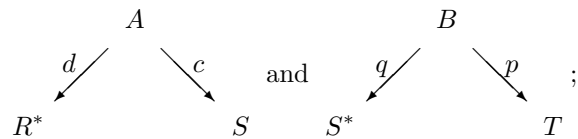

then their composite is given by the diagram

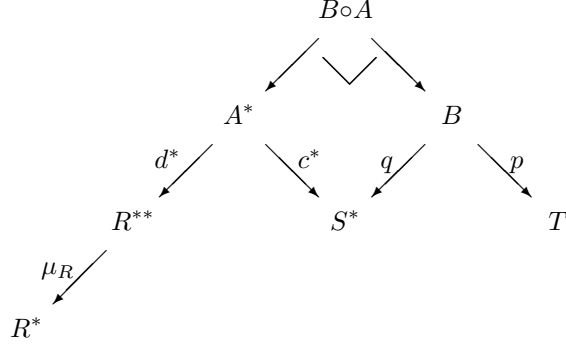

where the right-angle mark in the top square indicates that the square is a pullback.

**1-cell identities:** The identity on  $S$  is

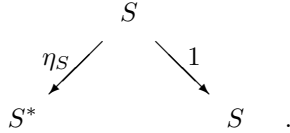

**2-cell identities and compositions:** Identities and vertical composition are as in  $\mathcal{S}$ . Horizontal composition is given in an obvious way.

Because the choice of pullbacks is arbitrary, 1-cell composition does not obey strict associative and identity laws. That it obeys them up to invertible 2-cells is a consequence of the fact that  $((\ )^*, \eta, \mu)$  is cartesian.  $\square$

**Definition 2.2** A monad in a bicategory consists of a 0-cell  $S$ , a 1-cell  $S \xrightarrow{t} S$ , and 2-cells

$$\begin{array}{ccc}
 & \xrightarrow{1} & \\
 & \Downarrow \eta & \\
 S & \xrightarrow{t} & S, \\
 & \Uparrow \mu & \\
 & \xrightarrow{tot} & 
 \end{array}$$

such that the diagrams

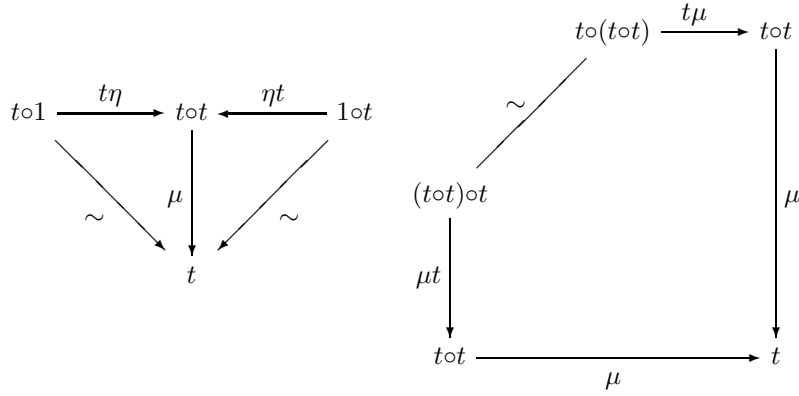

commute.

**Definition 2.3** Let  $(\mathcal{S}, *)$  be cartesian. Then an  $(\mathcal{S}, *)$ -multicategory is a monad in the associated bicategory  $\mathcal{B}$  of Construction 2.1.

An  $(\mathcal{S}, *)$ -multicategory therefore consists of a diagram  $S^* \xleftarrow{d} A \xrightarrow{c} S$  in  $\mathcal{S}$  and maps  $S \xrightarrow{ids} A$ ,  $A \circ A \xrightarrow{comp} A$  satisfying associative and identity laws. Think of  $S$  as ‘objects’,  $A$  as ‘arrows’,  $d$  as ‘domain’ and  $c$  as ‘codomain’. Such an  $A$  will be called an  $(\mathcal{S}, *)$ -multicategory on  $S$ , or if  $S = 1$  an  $(\mathcal{S}, *)$ -operad. (Baez and Dolan, in [BD], use ‘operad’ or ‘typed operad’ for the same kind of purpose as we use ‘multicategory’, and ‘untyped operad’ where we use ‘operad’.)

It is inherent that everything is small: when  $\mathcal{S} = \mathbf{Sets}$ , for instance, the objects and arrows form sets, not classes. Dealing with large multicategories instead does not appear to present any problem in practice. If we wanted to perform category theory enriched over a multicategory (in the place of a monoidal category), then the use of large multicategories would be necessary. (See 4.3 for further remarks on the relationship between multicategories and monoidal categories.)

**Definition 2.4** Let  $(\mathcal{S}, *)$  be cartesian.

i. An  $(\mathcal{S}, *)$ -graph (on  $S$ ) is a diagram  $S^* \longleftarrow A \longrightarrow S$  in  $\mathcal{S}$ . A map of  $(\mathcal{S}, *)$ -graphs

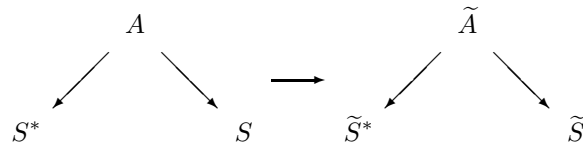

is a pair  $(A \xrightarrow{f} \tilde{A}, S \xrightarrow{g} \tilde{S})$  of maps in  $\mathcal{S}$  such that

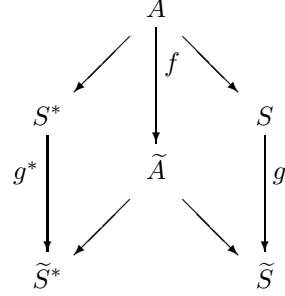

commutes.

ii. A map of  $(\mathcal{S}, *)$ -multicategories  $A \longrightarrow \tilde{A}$  (with graphs as in i) is a map  $(f, g)$  of their graphs such that the diagrams

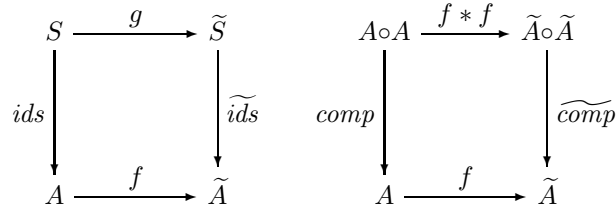

commute.

**Remarks 2.5**

i. The map  $A \circ A \xrightarrow{f * f} \tilde{A} \circ \tilde{A}$  just mentioned is the horizontal composite of 2-cells in the bicategory  $\mathcal{B}$  of Construction 2.1. That is,  $f * f$  is the unique map in  $\mathcal{S}$  making

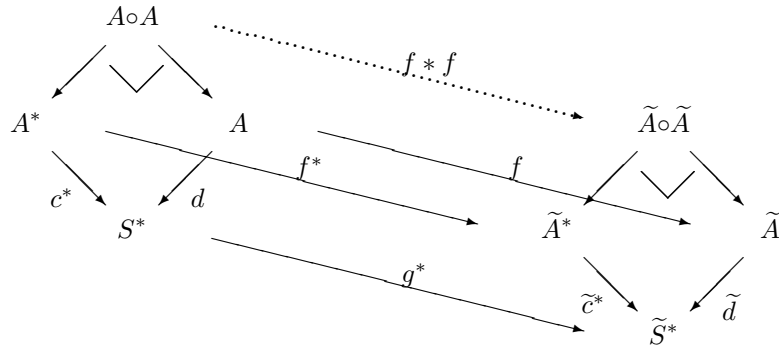

commute.

ii. Fix  $S \in \mathcal{S}$ . Then we may consider the category of  $(\mathcal{S}, *)$ -graphs on  $S$ , whose morphisms  $(A \xrightarrow{f} \tilde{A}, S \xrightarrow{g} S)$  all have  $g = 1$ . This is just the

slice category  $\frac{\mathcal{S}}{\mathcal{S}^* \times \mathcal{S}}$ . It is also the full sub-bicategory of  $\mathcal{B}$  whose only object is  $\mathcal{S}$ , and is therefore a monoidal category. The category of  $(\mathcal{S}, *)$ -multicategories on  $\mathcal{S}$  is then the category  $\mathbf{Mon}(\frac{\mathcal{S}}{\mathcal{S}^* \times \mathcal{S}})$  of monoids in  $\frac{\mathcal{S}}{\mathcal{S}^* \times \mathcal{S}}$ .

- iii. A choice of pullbacks in  $\mathcal{S}$  was made; changing that choice gives an isomorphic category of  $(\mathcal{S}, *)$ -multicategories.

**Examples 2.6**

- i. Let  $(\mathcal{S}, *) = (\mathbf{Sets}, id)$ . Then  $\mathcal{B}$  is the bicategory of spans, and a monad in  $\mathcal{B}$  is just a (small) category. Thus categories are  $(\mathbf{Sets}, id)$ -multicategories. Functors are maps of such.
- ii. Let  $(\mathcal{S}, *) = (\mathbf{Sets}, \text{free monoid})$ . Specifying an  $(\mathcal{S}, *)$ -graph  $S^* \xleftarrow{d} A \xrightarrow{c} S$  is equivalent to specifying a set  $A(s_1, \dots, s_n; s)$  for each  $s_1, \dots, s_n, s \in \mathcal{S}$  ( $n \geq 0$ ); if  $a \in A(s_1, \dots, s_n; s)$  then we write

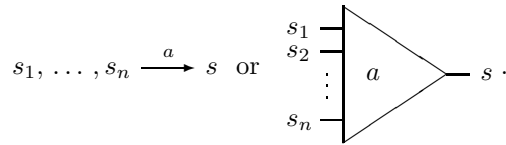

In the associated bicategory, the identity 1-cell  $S^* \xleftarrow{\eta_S} S \xrightarrow{1} S$  on  $S$  has

$$S(s_1, \dots, s_n; s) = \begin{cases} 1 & \text{if } n = 1 \text{ and } s_1 = s \\ \emptyset & \text{otherwise.} \end{cases}$$

The composite 1-cell  $A \circ A$  is

$$\{ \langle (a_1, \dots, a_n), a \rangle \mid da = \langle ca_1, \dots, ca_n \rangle \},$$

i.e. is the set of diagrams

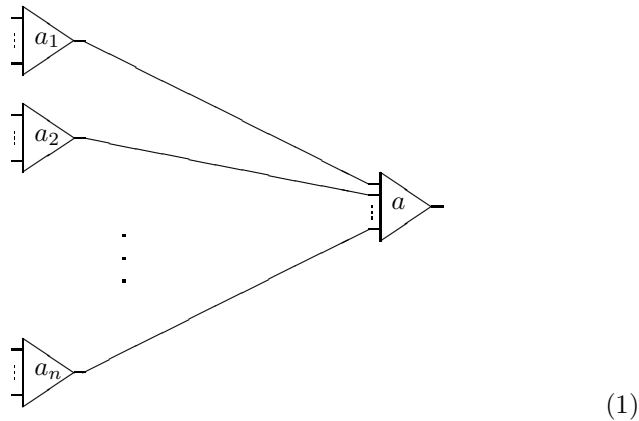

with the evident domain and codomain functions.

We then have a function  $ids$  assigning to each  $s \in S$  a member of  $A(s; s)$ , and a function  $comp$  composing diagrams like (1). These are required to obey associative and identity laws. Thus a **(Sets, free monoid)**-multicategory is just an ‘ordinary’ non-symmetric multicategory. A **(Sets, free monoid)**-operad is a non-symmetric May operad (on **Sets**).

- iii. One should not conclude from Example 1.4(iii) that it is impossible in our system to describe the symmetric operads of [May] or [BD]. The reason why not lies in the difference between having an isomorphism

$$A(s_1, \dots, s_n; s) \cong A(s_{\sigma 1}, \dots, s_{\sigma n}; s)$$

for each permutation  $\sigma$ , and having actual equalities.

- iv. Let  $\mathcal{S} = \mathbf{Sets}$ , and consider the exceptions monad  $\underline{\quad} + 1$  of 1.4(v). A **(Sets,  $\underline{\quad} + 1$ )**-graph is a diagram  $S + 1 \xleftarrow{d} A \xrightarrow{c} S$  of sets; this is like an ordinary **(Sets,  $id$ )**-graph on  $S$ , except that some arrows have domain  $0$ —an extra element not in  $S$ . (Thus  $1 = \{0\}$  here.) If we set

$$Y(s) = \{a \in A \mid da = 0\}$$

for each  $s \in S$ , then a multicategory structure on the graph provides a function

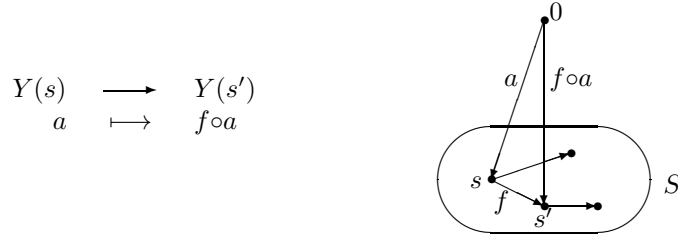

for each  $f \in A$  with  $d(f) = s \in S$  and  $c(f) = s'$ . It also provides a category structure on  $S \xleftarrow{d} C \xrightarrow{c} S$ , where  $C = \{a \in A \mid da \in S\}$ . Thus a **(Sets,  $\underline{\quad} + 1$ )**-multicategory turns out to be just a (small) category  $\mathbb{C}$  together with a functor  $\mathbb{C} \longrightarrow \mathbf{Sets}$ . (Similarly, a **(Sets,  $\underline{\quad} + E$ )**-multicategory is a category  $\mathbb{C}$  together with an  $E$ -indexed family of functors  $\mathbb{C} \longrightarrow \mathbf{Sets}$ .)

Another way to put this is that a **(Sets,  $\underline{\quad} + 1$ )**-multicategory is a discrete fibration (between small categories, where the codomain here is  $\mathbb{C}^{\text{op}}$ ). In fact, the category of **(Sets,  $\underline{\quad} + 1$ )**-multicategories is the category of discrete fibrations.

- v. Let  $M$  be a monoid and  $(\mathcal{S}, *) = (\mathbf{Sets}, M \times \underline{\quad})$ . Then an  $(\mathcal{S}, *)$ -multicategory consists of a category  $\mathbb{C}$  together with a functor  $\mathbb{C} \longrightarrow M$ .

- vi. Let  $(\mathcal{S}, *) = (\mathbf{Sets}, \text{tree monad})$ , as in 1.4(vii). An  $(\mathcal{S}, *)$ -multicategory consists of a set  $S$  of objects, and sets like

$$A \left( \begin{array}{c} \text{graph with root } \bullet, \text{ children } \bullet, \bullet, \text{ and } \circ \\ \text{left child } \bullet \text{ has children } s_1, \bullet \\ \text{right child } \bullet \text{ has child } s_2 \\ \text{right child } \bullet \text{ has child } s_2, S \end{array} \right)$$

$(s_1, s_2, s \in S)$ , together with a unit element of each  $A(\bullet, s)$  and composition functions like

$$\left\{ A \left( \begin{array}{c} \text{graph with root } \bullet, \text{ children } \bullet, \bullet \\ \text{left child } \bullet \text{ has children } r_1, \bullet \\ \text{right child } \bullet \text{ has child } r_2 \\ \text{right child } \bullet \text{ has child } s_1 \end{array} \right) \times A \left( \begin{array}{c} \text{graph with root } \bullet, \text{ children } \bullet, \bullet, \bullet, \circ \\ \text{left child } \bullet \text{ has children } r_3, \bullet \\ \text{right child } \bullet \text{ has children } r_4, \bullet \\ \text{right child } \bullet \text{ has child } s_2 \end{array} \right) \right\} \times A \left( \begin{array}{c} \text{graph with root } \bullet, \text{ children } \bullet, \bullet \\ \text{left child } \bullet \text{ has children } s_1, \bullet \\ \text{right child } \bullet \text{ has child } s_2, S \end{array} \right)$$

$$\longrightarrow A \left( \begin{array}{c} \text{graph with root } \bullet, \text{ children } \bullet, \bullet, \bullet, \bullet, \circ \\ \text{left child } \bullet \text{ has children } r_1, \bullet \\ \text{right child } \bullet \text{ has children } r_2, \bullet \\ \text{right child } \bullet \text{ has children } r_3, \bullet \\ \text{right child } \bullet \text{ has children } r_4, \bullet \\ \text{right child } \bullet \text{ has child } s \end{array} \right)$$

$(r_1, r_2, r_3, r_4 \in S)$ . These are to satisfy associativity and identity laws.

When  $S = 1$ , so that we're considering  $(\mathcal{S}, *)$ -operads, the graph structure

is comprised of sets like  $A \left( \begin{array}{c} \text{graph with root } \bullet, \text{ children } \bullet, \bullet, \circ \\ \text{left child } \bullet \text{ has children } \bullet, \bullet \\ \text{right child } \bullet \text{ has child } \bullet \\ \text{right child } \bullet \text{ has child } \bullet \end{array} \right)$ .

The  $(\mathcal{S}, *)$ -multicategories are a simpler version of Soibelman's pseudo-monoidal categories ([Soi]); they omit the aspect of maps between trees. A similar relation is borne to Borchers' relaxed multilinear categories ([Bor]).

- vii. When  $\mathcal{S} = \mathbf{Cat}$  and  $*$  is the free strict monoidal category monad, an  $(\mathcal{S}, *)$ -operad is what Soibelman calls a strict monoidal 2-operad in [Soi, 2.1].
- viii. Let  $(\mathcal{S}, *) = (\text{Globular sets}, \text{free strict } \omega\text{-category})$ . An  $(\mathcal{S}, *)$ -operad is exactly what Batanin calls an operad (or 'an  $\omega$ -operad in *Span*'; see [Bat]).



- ix. Operads for  $(\mathcal{S}, *) = (n\text{-cubical sets, free strict } n\text{-tuple category})$  can be understood in much the same way as Batanin's operads. For instance, a cell in the free strict  $\omega$ -category on the terminal globular set can be represented as a tree<sup>1</sup>; a cell in the free strict  $n$ -tuple category on the terminal  $n$ -cubical set can be represented as a cuboid (or the sequence of natural numbers which are its edges' lengths). A Batanin operad associates to each tree a set, and has composition functions corresponding to the combining of trees; a cubical operad associates to each cuboid a set, and has composition functions corresponding to the combining of cuboids.

---

<sup>1</sup>These are not the same kind of trees as in 1.4(vii); see [Bat]

### 3 Algebras

We want to define a category of algebras for any  $(\mathcal{S}, *)$ -multicategory. In the case  $(\mathcal{S}, *) = (\mathbf{Sets}, id)$ , where we are dealing with a plain category  $\mathbb{C}$ , the category of algebras should be  $[\mathbb{C}, \mathbf{Sets}]$ . We will take inspiration from the following:

**Lemma 3.1** *Let  $\mathbb{C}$  be a small category, and let  $\mathbb{C}_0$  denote the set of objects of  $\mathbb{C}$  or the discrete category thereon. Then the forgetful functor  $[\mathbb{C}, \mathbf{Sets}] \longrightarrow [\mathbb{C}_0, \mathbf{Sets}]$  is monadic.*

**Proof** This is easily verified without use of the adjoint functor or monadicity theorems. Here, we just describe what the induced monad  $T$  does to an object  $X$  of  $[\mathbb{C}_0, \mathbf{Sets}]$ : if  $C \in \mathbb{C}$  then

$$(TX)C = \coprod_{D \xrightarrow[f \text{ in } \mathbb{C}]{} C} XD.$$

□

#### Discussion 3.2

Lemma 3.1 describes  $[\mathbb{C}, \mathbf{Sets}]$  as the category of algebras for a certain monad  $T$  on  $[\mathbb{C}_0, \mathbf{Sets}]$ . But there is an equivalence

$$[\mathbb{C}_0, \mathbf{Sets}] \simeq \mathbf{Sets}/\mathbb{C}_0$$

of categories, so we also obtain a monad  $T'$  on  $\mathbf{Sets}/\mathbb{C}_0$ . How can  $T'$  be described directly? Take an object  $(X \xrightarrow{p} \mathbb{C}_0)$  of  $\mathbf{Sets}/\mathbb{C}_0$ : this corresponds to the object  $X$  of  $[\mathbb{C}_0, \mathbf{Sets}]$  with  $XC = p^{-1}\{C\}$ . Now

$$\begin{aligned} (TX)C &= \coprod_{D \xrightarrow{f} C} XD \\ &= \{(f, v) \mid f \in \mathbb{C}_1, v \in X(\text{dom}f), \text{cod}f = C\} \\ &= \{(f, v) \in \mathbb{C}_1 \times X \mid p(v) = \text{dom}f, \text{cod}f = C\} \end{aligned}$$

(where  $\mathbb{C}_1 = \{\text{arrows of } \mathbb{C}\}$ ), so if  $T'X = (X' \xrightarrow{p'} \mathbb{C}_0)$  then  $X'$  is the pullback

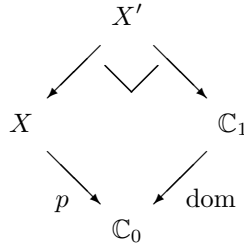

and  $p'(f, v) = \text{cod}f$ . Thus  $T'X$  is the right-hand diagonal of the diagram

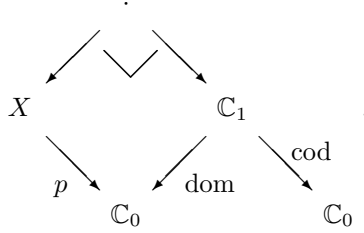

We are now ready to generalize to any cartesian  $(\mathcal{S}, *)$ .

### Construction 3.3

Let  $(\mathcal{S}, *)$  be cartesian and  $S \in \mathcal{S}$ : then any  $(\mathcal{S}, *)$ -multicategory on  $S$  gives rise to a monad on  $\mathcal{S}/S$ .

Let  $S^* \xleftarrow{d} A \xrightarrow{c} S$  be the multicategory. We describe a monad  $(\cdot)^*$  on  $\mathcal{S}/S$ ; in what follows, we'll write  $(X \xrightarrow{p} S)^\bullet = (X_\bullet \xrightarrow{p_\bullet} S)$ , etc.

- $(X_\bullet \xrightarrow{p_\bullet} S)$  is the right-hand diagonal of the diagram

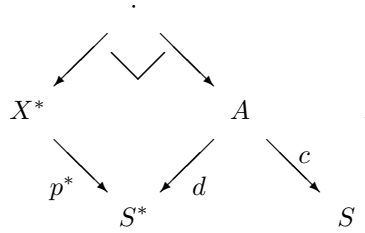

- If  $\begin{array}{ccc} X & \xrightarrow{f} & Y \\ \searrow & & \swarrow \\ & S & \end{array}$  is a map in  $\mathcal{S}/S$ , then  $\begin{array}{ccc} X_\bullet & \xrightarrow{f_\bullet} & Y_\bullet \\ \searrow & & \swarrow \\ & S & \end{array}$  is the unique map making

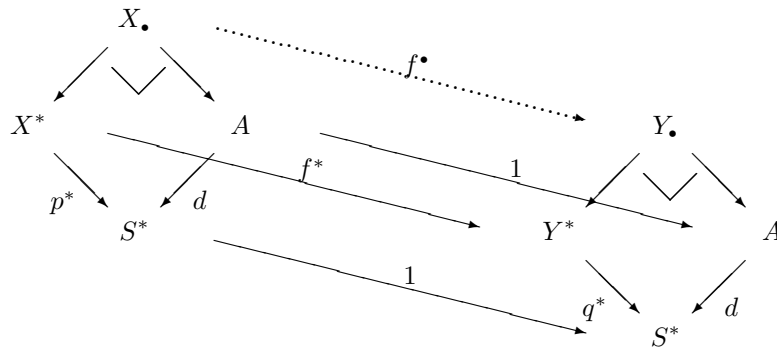

commute.

- The unit at  $(X \xrightarrow{p} S)$  is given by

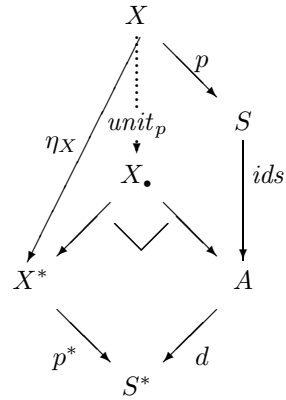

- For multiplication, we have a commutative diagram

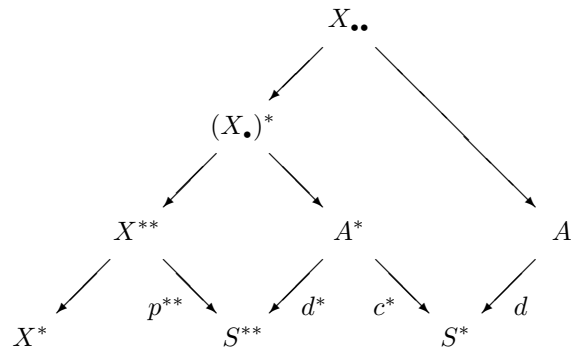

and a pullback square

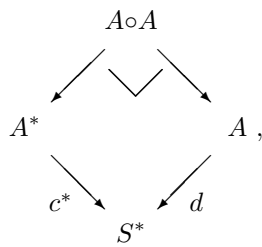

and so in particular there are maps

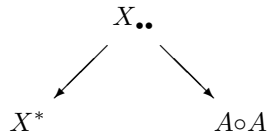

The multiplication at  $(X \xrightarrow{p} S)$  is given by

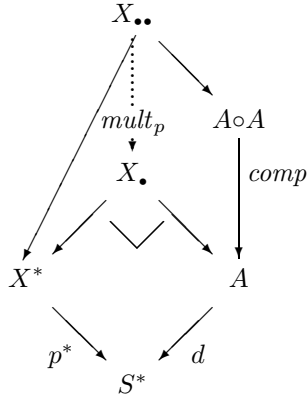

It is now straightforward to check that  $((\ )^{\bullet}, unit, mult)$  forms a monad on  $\mathcal{S}/\mathcal{S}$ , and that when  $(\mathcal{S}, *) = (\mathbf{Sets}, id)$  this is the monad of Discussion 3.2.  $\square$

**Definition 3.4** Let  $(\mathcal{S}, *)$  be cartesian and  $S^* \longleftarrow A \longrightarrow S$  an  $(\mathcal{S}, *)$ -multicategory on  $S \in \mathcal{S}$ . Then the category of algebras for the multicategory,  $\mathbf{Alg}(A)$ , is the category of algebras for the associated monad on  $\mathcal{S}/\mathcal{S}$ .

With the  $(\mathbf{Sets}, id)$  case of plain categories in mind, we would expect a map  $A \longrightarrow A'$  of multicategories to yield a functor  $\mathbf{Alg}(A) \longleftarrow \mathbf{Alg}(A')$ . This is indeed the case; moreover, one can define a *transformation* between two maps of multicategories, and such a transformation leads to a natural transformation

$$\mathbf{Alg}(A) \xleftarrow{\quad} \mathbf{Alg}(A') \text{ .}$$

The question also arises of ‘Kan extensions’: left and right adjoints to the functor  $\mathbf{Alg}(A) \longleftarrow \mathbf{Alg}(A')$ . These issues will not be discussed any further here.

### Examples 3.5

- i. When  $(\mathcal{S}, *) = (\mathbf{Sets}, id)$ ,  $\mathbf{Alg}(\mathbb{C}) \cong [\mathbb{C}, \mathbf{Sets}]$ .
- ii. When  $(\mathcal{S}, *) = (\mathbf{Sets}, \text{free monoid})$ , so that an  $(\mathcal{S}, *)$ -multicategory is a multicategory of the familiar kind, we already have an idea of what an algebra for  $A$  should be: a ‘multifunctor  $A \longrightarrow \mathbf{Sets}$ ’. That is, an algebra for  $A$  should consist of:
  - for each  $s \in S$ , a set  $X(s)$
  - for each  $s_1, \dots, s_n \xrightarrow{f} s$  in  $A$ , a function  $X(s_1) \times \dots \times X(s_n) \longrightarrow X(s)$ , preserving identities and composition.

In fact, this is the same as the definition of algebra just given. One way to see this is to work through Lemma 3.1 and Discussion 3.2, changing ‘category’ to ‘(ordinary) multicategory’:  $[A, \mathbf{Sets}]$  is monadic over  $[S, \mathbf{Sets}]$ , the monad  $T$  being given by

$$(TX)_s = \coprod_{s_1, \dots, s_n \xrightarrow{f} s} X(s_1) \times \cdots \times X(s_n).$$

Alternatively, one can calculate directly: if  $(X \xrightarrow{p} S)$  and we put  $X(s) = p^{-1}\{s\}$  then

$$\begin{aligned} X_\bullet &= \{(\langle x_1, \dots, x_n \rangle, f) \mid df = \langle px_1, \dots, px_n \rangle\} \\ &= \{X(s_1) \times \cdots \times X(s_n) \times A(s_1, \dots, s_n; s) \mid s_1, \dots, s_n, s \in S\}, \end{aligned}$$

and an algebra structure on  $(X \xrightarrow{p} S)$  therefore consists of a function

$$X(s_1) \times \cdots \times X(s_n) \longrightarrow X(s)$$

for each member of  $A(s_1, \dots, s_n; s)$ , subject to certain laws.

- iii. When  $(\mathcal{S}, *) = (\mathbf{Sets}, \underline{\quad} + 1)$ , an  $(\mathcal{S}, *)$ -multicategory is an ordinary category  $\mathbb{C}$  together with a functor  $\mathbb{C} \xrightarrow{Y} \mathbf{Sets}$ . A  $(\mathbb{C}, Y)$ -algebra is then a functor  $\mathbb{C} \longrightarrow \mathbf{Sets}$  together with a natural transformation

$$\begin{array}{ccc} & Y & \\ \mathbb{C} & \xrightarrow{\quad} & \mathbf{Sets} \\ & \Downarrow & \\ & \xrightarrow{\quad} & \end{array}$$

In terms of fibrations, an  $(\mathcal{S}, *)$ -multicategory is a discrete fibration  $Y$  over a small category  $\mathbb{B} (= \mathbb{C}^{\text{op}})$ , and an algebra for  $Y$  consists of another discrete fibration  $X$  over  $\mathbb{B}$  together with a map from  $Y$  to  $X$  (of fibrations over  $\mathbb{B}$ ).

- iv. Let  $(\mathcal{S}, *)$  be the tree monad on  $\mathbf{Sets}$ ; for simplicity, let us just consider *operads*  $A$  for  $(\mathcal{S}, *)$ —thus the object-set  $S$  is 1. An algebra for  $A$  consists of a set  $X$  together with a function  $X_\bullet \longrightarrow X$  satisfying some axioms. One can calculate that an element of  $X_\bullet$  consists of an  $X$ -labelling of a tree  $T$  together with a member of  $A(T)$ . An  $X$ -labelling of an  $n$ -leafed tree  $T$  is just a member of  $X^n$ , so one can view the algebra structure  $X_\bullet \longrightarrow X$  on  $X$  as: for each number  $n$ ,  $n$ -leafed tree  $T$ , and element of  $A(T)$ , a function  $X^n \longrightarrow X$ . These functions are required to be compatible with glueing of trees in an evident way.
- v. For  $(\mathcal{S}, *) = (\text{Globular sets, free strict } \omega\text{-category})$ , Batanin constructs a certain operad  $K$ , the ‘universal contractible operad’ (see [Bat]). He then defines a weak  $\omega$ -category to be an algebra for  $K$ .

- vi. The graph  $1^* \xleftarrow{1} 1^* \xrightarrow{!} 1$  is terminal amongst all  $(\mathcal{S}, *)$ -graphs. It carries a unique multicategory structure, since a terminal object in a monoidal category always carries a unique monoid structure. It then becomes the terminal  $(\mathcal{S}, *)$ -multicategory. The induced monad on  $\mathcal{S}/1$  is just  $(( )^*, \eta, \mu)$ , and so an algebra for the terminal multicategory is just an algebra for  $*$ . This can aid recognition of when a theory of operads or multicategories fits into our scheme. For instance, if we were to read Batanin's paper and learn that, in his terminology, an algebra for the terminal operad is a strict  $\omega$ -category ([Bat, p. 51, example 3]), then we might suspect that his operads were  $(\mathcal{S}, *)$ -operads for the free strict  $\omega$ -category monad  $*$  on some suitable category  $\mathcal{S}$ —as indeed they are.

## 4 Further Developments

We finish with a collection of loose topics. Some of them have not been worked out in full detail; others have, but their relevance is unclear.

Section 4.1 is a brief explanation of the process of forming the free multicategory on a graph, and allows descriptions of both the set of opetopes and, for any cartesian  $(\mathcal{S}, *)$ , a multicategory whose algebras are the  $(\mathcal{S}, *)$ -multicategories. Section 4.2 explains ‘slicing’, a generalization of the Grothendieck construction and another important component of the Baez-Dolan theory. In 4.3 we discuss the relationship between multicategories and monoidal categories; 4.4 throws more light on this by describing the ways in which the assignment

$$(\mathcal{S}, *) \longmapsto (\mathcal{S}, *)\text{-Multicat}$$

is functorial. Next, in 4.5, we associate to any object of  $\mathcal{S}/S$  an  $(\mathcal{S}, *)$ -multicategory on  $S$ ; this relates to the usual definition of ‘algebra’ for the operads of May, Baez-Dolan and Batanin. Sections 4.6 and 4.7 each provide an alternative description of what an  $(\mathcal{S}, *)$ -multicategory is, one in terms of monads and the other in terms of bicategories.

Each section can be read independently of the others. Throughout, we will denote by  $(\mathcal{S}, *)\text{-Graph}$  and  $(\mathcal{S}, *)\text{-Multicat}$  the categories of  $(\mathcal{S}, *)$ -graphs and  $(\mathcal{S}, *)$ -multicategories. Sections 4.4 and 4.6 also need the definitions in the following paragraphs; the rest do not.

Let  $T$  and  $\tilde{T}$  be monads on respective categories  $\mathcal{C}$  and  $\tilde{\mathcal{C}}$ . Then a *monad functor*  $(\mathcal{C}, T) \xrightarrow{(P, \phi)} (\tilde{\mathcal{C}}, \tilde{T})$  consists of a functor  $\mathcal{C} \xrightarrow{P} \tilde{\mathcal{C}}$  together with a natural transformation

$$\begin{array}{ccc} \mathcal{C} & \xrightarrow{T} & \mathcal{C} \\ P \downarrow & \nearrow \phi & \downarrow P \\ \tilde{\mathcal{C}} & \xrightarrow{\tilde{T}} & \tilde{\mathcal{C}} \end{array}$$

such that

$$\begin{array}{ccccc} \tilde{T}^2 P & \xrightarrow{\tilde{T}\phi} & \tilde{T} P T & \xrightarrow{\phi T} & P T^2 \\ \tilde{\mu} P \downarrow & & & & \downarrow P\mu \\ \tilde{T} P & \xrightarrow{\phi} & P T & & \end{array}$$

and a similar diagram involving units commute. If  $(\mathcal{C}, T) \xrightarrow{(Q, \psi)} (\tilde{\mathcal{C}}, \tilde{T})$  is another monad functor then a *monad functor transformation*  $(P, \phi) \longrightarrow (Q, \psi)$



is a natural transformation  $P \xrightarrow{\alpha} Q$  such that  $(\alpha T) \circ \phi = \psi \circ (\tilde{T}\alpha)$ . There is consequently a 2-category  $\mathbf{Mnd}$ , whose 0-cells are pairs  $(\mathcal{C}, T)$ , whose 1-cells are monad functors, and whose 2-cells are monad functor transformations.

There is the dual notion of a *monad opfunctor*, which is just like a monad functor except that  $\phi$  travels in the opposite direction; similarly, *monad opfunctor transformations*. This gives another 2-category,  $\mathbf{Mnd}'$ . All of these definitions are taken directly from Street's paper [St].

A monad opfunctor  $(P, \phi)$  will be called *cartesian* if  $P$  preserves pullbacks and  $\phi$  is a cartesian natural transformation, but a monad functor  $(P, \phi)$  will be called *cartesian* just if  $P$  preserves pullbacks. (This is an unhappy situation; the reason for these definitions is that they give the conditions necessary for the constructions of 4.4 to work.) We then define  $\mathbf{CartMnd}$ , the sub-2-category of  $\mathbf{Mnd}$  consisting of cartesian pairs  $(\mathcal{C}, T)$ , cartesian monad functors, and all monad functor transformations; similarly, the sub-2-category  $\mathbf{CartMnd}'$  of  $\mathbf{Mnd}'$ .

## 4.1 Free Multicategories

### The Free Multicategory Functor

Let  $(\mathcal{S}, *)$  be cartesian. Subject to certain further conditions on  $(\mathcal{S}, *)$ , which I won't mention except to say that they hold for the opetopic construction below, the following are true:

- the forgetful functor

$$(\mathcal{S}, *)\text{-Multicat} \longrightarrow (\mathcal{S}, *)\text{-Graph}$$

has a left adjoint, the 'free  $(\mathcal{S}, *)$ -multicategory functor'

- the adjunction is monadic
- the monad on  $(\mathcal{S}, *)\text{-Graph}$  is cartesian
- all of the above statements are also true for the forgetful functor

$$(\mathcal{S}, *)\text{-Multicats on } S \longrightarrow (\mathcal{S}, *)\text{-Graphs on } S,$$

for any  $S \in \mathcal{S}$ .

(It follows from this and the general theory of monads that any multicategory is a quotient of a free multicategory; this corresponds to the presentation of a multicategory by generators and relations.)

### The Multicategory Multicategory

Take the free  $(\mathcal{S}, *)$ -multicategory monad  $\sharp$  on the category  $\mathcal{S}' = (\mathcal{S}, *)\text{-Graph}$  (for suitable  $(\mathcal{S}, *)$ ). Then  $(\mathcal{S}, *)$ -multicategories are algebras for  $\sharp$ . By Example 3.5(vi), this means that the terminal  $(\mathcal{S}', \sharp)$ -multicategory has as its algebras the  $(\mathcal{S}, *)$ -multicategories.

(Related to this is the Baez-Dolan construction of the ‘ $S$ -operad operad’ for any object-set  $S$ : an operad whose algebras are the operads on  $S$ . To make sense of the last sentence in our language, read ‘multicategory’ for ‘operad’.)

### Opetopes

The free multicategory functor enables us to construct the sets  $S_n$  of  $n$ -opetopes ( $n \in \mathbb{N}$ ), as developed in [BD]. (See also [Baez] for a softer account.) Start with  $S_0 = 1$  and  $T_0 = id$ ; that is,  $T_0$  is the identity monad on  $\mathbf{Sets} = \mathbf{Sets}/S_0$ . Now suppose we have a set  $S_n$  and a cartesian monad  $T_n$  on  $\mathbf{Sets}/S_n$ . The terminal object of  $\mathbf{Sets}/S_n$  is  $(S_n \xrightarrow{1} S_n)$ ; write

$$T_n \left( \begin{array}{c} S_n \\ \downarrow 1 \\ S_n \end{array} \right) = \begin{array}{c} S_{n+1} \\ \downarrow \\ S_n \end{array} .$$

The category of  $(\mathbf{Sets}/S_n, T_n)$ -graphs on  $(S_n \xrightarrow{1} S_n)$  is

$$\frac{\mathbf{Sets}/S_n}{T_n(S_n \longrightarrow S_n)} = \frac{\mathbf{Sets}/S_n}{S_{n+1} \longrightarrow S_n} \cong \frac{\mathbf{Sets}}{S_{n+1}},$$

so the monad ‘free  $(\mathbf{Sets}/S_n, T_n)$ -multicategory on 1’,  $T_{n+1}$ , is a cartesian monad on the category  $\mathbf{Sets}/S_{n+1}$ .

This defines the sets  $S_n$ ; let us look at  $n = 0, 1$  and  $2$ . First of all,  $S_0 = 1$  and  $T_0 = id$ . Then

$$\begin{array}{c} S_1 \\ \downarrow \\ S_0 \end{array} = T_0 \left( \begin{array}{c} S_0 \\ \downarrow \\ S_0 \end{array} \right),$$

i.e.  $S_1 = 1$ , and  $T_1$  is the monad ‘free  $(\mathbf{Sets}/S_0, T_0)$ -multicategory on 1’, i.e. the free monoid monad. Next,

$$\begin{array}{c} S_2 \\ \downarrow \\ S_1 \end{array} = T_1 \left( \begin{array}{c} S_1 \\ \downarrow \\ S_1 \end{array} \right),$$

i.e.  $S_2$  is the free monoid  $\mathbb{N}$  on the set  $S_1 = 1$ ;  $T_2$  is the monad ‘free  $(\mathbf{Sets}/S_1, T_1)$ -multicategory on 1’, or ‘free  $(\mathbf{Sets}, \text{free monoid})$ -operad’, on  $\mathbf{Sets}/\mathbb{N}$ . If  $Y = (Y(n))_{n \in \mathbb{N}}$  is an object of  $\mathbf{Sets}/\mathbb{N}$ , then a member  $y$  of  $Y(n)$  can be drawn as

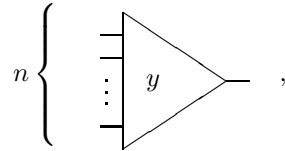

or for Baez-Dolan adherents, as

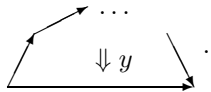

The monad  $T_2$  sends  $Y$  to the family of pictures obtained by sticking together members of the  $Y(n)$ 's.

A description of opetopic sets can also be given, in a manner similar to that for opetopes. Opetopic sets are central to the Baez-Dolan development [BD] of  $n$ -category theory; the explanation of opetopic sets most convenient to us here is closer to that formulated in [HMP], as interpreted to me by Martin Hyland from a conversation with John Power.

## 4.2 The Grothendieck Construction, or Slicing

Given an ordinary category  $\mathbb{C}$  and a functor  $\mathbb{C} \xrightarrow{h} \mathbf{Sets}$ , the Grothendieck construction produces a category  $\mathbb{C}_h$  such that

$$[\mathbb{C}_h, \mathbf{Sets}] \cong [\mathbb{C}, \mathbf{Sets}]/h.$$

In general, given an  $(\mathcal{S}, *)$ -multicategory  $A$  and an algebra

$$\left( \begin{array}{c} X \\ \downarrow p \\ S \end{array} \right)^\bullet \xrightarrow{h} \left( \begin{array}{c} X \\ \downarrow p \\ S \end{array} \right)$$

for  $A$  (with  $\bullet$  as in Construction 3.3), we may describe a new  $(\mathcal{S}, *)$ -multicategory  $A_h$  such that

$$\mathbf{Alg}(A_h) = \mathbf{Alg}(A)/h.$$

The graph of  $A_h$  is

$$\begin{array}{ccc} & X_\bullet & \\ \phi_p \swarrow & & \searrow h \\ X^* & & X \end{array}$$

where  $\phi_p$  is part of the pullback square defining  $X_\bullet$  (see 3.3); identities and composition are given via the unit and multiplication of the monad  $\bullet$ . (The natural map  $A_h \longrightarrow A$  is, in a suitable sense, a discrete opfibration, and one can go on to show that algebras for  $A$  correspond exactly to discrete opfibrations over  $A$ .)

In [BD, section 2.5],  $A_h$  would be called a ‘slice operad’; slicing plays an essential part in their theory.

It is perhaps worth noting that the slicing of multicategories corresponds to the slicing of monads, in the following sense. Given a monad  $T$  on a category  $\mathbb{C}$  and an algebra  $TC \xrightarrow{h} C$  for  $T$ , there is a monad  $T_h$  on  $\mathbb{C}/C$  such that

$$\mathbf{Alg}(T_h) = \mathbf{Alg}(T)/h,$$

where  $\mathbf{Alg}(\ )$  denotes the category of algebras for a monad. Now suppose we start with an  $(\mathcal{S}, *)$ -multicategory  $A$  and an algebra  $h$  for  $A$ , as above. We get the monad  $(\ )^\bullet$  on  $\mathcal{S}/S$ , and therefore a monad  $(\ )^\bullet_h$  on  $\frac{\mathcal{S}/S}{X} \xrightarrow{h} S \cong \frac{\mathcal{S}}{X}$ . But we also get the  $(\mathcal{S}, *)$ -multicategory  $A_h$  on  $X$ , and therefore another monad on  $\mathcal{S}/X$ . The reader will not be surprised to learn that these two monads on  $\mathcal{S}/X$  are the same.

### 4.3 Structured Categories

The observation from which this section takes off is that any strict monoidal category has an underlying (ordinary) multicategory. (All monoidal categories and maps between them will be strict in this section; one could consider similar issues for lax versions, but this is not done here. For the time being, ‘multicategory’ means **(Sets, free monoid)**-multicategory.) Explicitly, if  $(\mathbb{C}, \otimes)$  is a monoidal category, then the underlying multicategory  $A$  has the same object-set as  $\mathbb{C}$  and has homsets defined by

$$\text{Hom}_A(C_1, \dots, C_n; C) = \text{Hom}_{\mathbb{C}}(C_1 \otimes \dots \otimes C_n, C)$$

for objects  $C_1, \dots, C_n, C$ . Composition and identities in  $A$  are easily defined.

There is a converse process: given any multicategory  $A$  with objects  $S$ , there is a ‘free’ monoidal category  $\mathbb{C}$  on it. Informally, an object/arrow of  $\mathbb{C}$  is a sequence of objects/arrows of  $A$ . Thus the objects of  $\mathbb{C}$  are of form  $\langle s_1, \dots, s_n \rangle$  ( $s_i \in S$ ), and a typical arrow  $\langle s_1, s_2, s_3, s_4, s_5 \rangle \longrightarrow \langle s'_1, s'_2, s'_3 \rangle$  is a sequence  $\langle a_1, a_2, a_3 \rangle$  of elements of  $A$  with domains and codomains as illustrated:

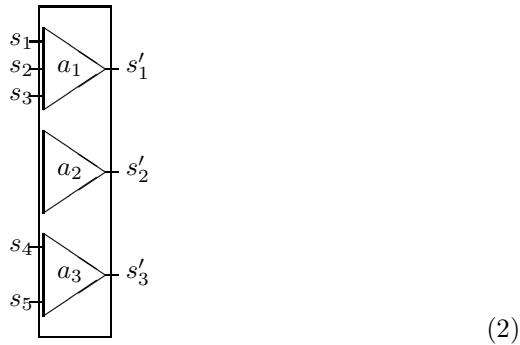

The tensor in  $\mathbb{C}$  is just juxtaposition.

For example, the terminal multicategory  $\mathbf{1}$  has one object and, for each  $n \in \mathbb{N}$ , one arrow of form

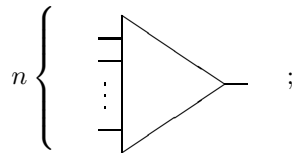

figure 2 (above) indicates that the ‘free’ monoidal category on the multicategory  $\mathbf{1}$  is  $\Delta$ , the category of finite ordinals, with addition as  $\otimes$ .

The name ‘free’ is justified: that is, there is an adjunction

$$\begin{array}{c} \text{Monoidal categories} \\ \uparrow \dashv \downarrow \\ \text{Multicategories} \end{array}$$

where the two functors are those described above. Moreover, this adjunction is monadic. (But the forgetful functor does *not* provide a full embedding of Monoidal categories into Multicategories. It is faithful, but not full: there is a multicategory map  $\mathbf{1} \longrightarrow \Delta$  sending the unique object of  $\mathbf{1}$  to the object 1 of  $\Delta$ , and this map does not preserve the monoidal structure.)

Naturally, we would like to generalize from  $(\mathcal{S}, *) = (\mathbf{Sets}, \text{free monoid})$  to any cartesian  $(\mathcal{S}, *)$ . To do this, we need a notion of ‘ $(\mathcal{S}, *)$ -structured category’, which in the case  $(\mathbf{Sets}, \text{free monoid})$  just means monoidal category. One can view a monoidal category either as a monoid in  $\mathbf{Cat}$ , i.e. an algebra for the monoid monad on  $\mathbf{Cat}$ , or as a category object in  $\mathbf{Monoids}$ . The latter view is more convenient here: if  $\mathcal{S}^{(\ )^*}$  is the category of algebras for the monad  $(\ )^*$  on  $\mathcal{S}$ , then define an  $(\mathcal{S}, *)$ -structured category to be an  $(\mathcal{S}^{(\ )^*}, id)$ -multicategory, i.e. a category object in  $\mathcal{S}^{(\ )^*}$ . (Alternatively, as in the motivating case,  $\mathcal{S}, *$  can be extended to give a monad on  $\mathcal{S}\text{-Cat}$ , and an  $(\mathcal{S}, *)$ -structured category defined as an algebra for this monad. It comes to the same thing.)

It is now possible to describe a monadic adjunction

$$\begin{array}{c}
 (\mathcal{S}, *)\text{-Structured categories} \\
 \uparrow \quad \downarrow \\
 F \quad \dashv \quad U \\
 \downarrow \quad \uparrow \\
 (\mathcal{S}, *)\text{-Multicat}
 \end{array}$$

generalizing that above. The effect of the functors  $F$  and  $U$  on objects is as outlined now. Given an  $(\mathcal{S}, *)$ -multicategory  $S^* \xleftarrow{d} A \xrightarrow{c} S^*$ , the category  $FA$  has graph

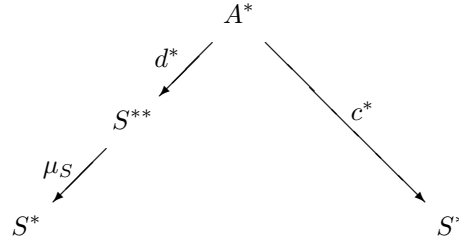

and the monoidal structures  $A^{**} \xrightarrow{\otimes} A^*$ ,  $S^{**} \xrightarrow{\otimes} S^*$  are components of  $\mu$ . Given an  $(\mathcal{S}, *)$ -structured category  $R \xleftarrow{q} B \xrightarrow{p} R$ , with monoidal structure  $R^* \xrightarrow{\otimes} R$  and  $B^* \xrightarrow{\otimes} B$ , the graph  $R^* \longleftarrow A \longrightarrow R$  of  $UB$  is given by

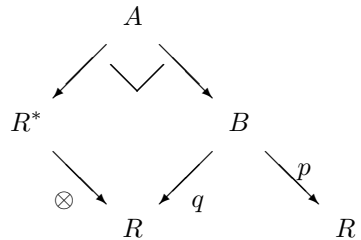

In fact, all of the above can be seen as a certain instance of the functorial action of **Multicat**, as described in the next section.

#### 4.4 Functoriality of Multicat

Any cartesian pair  $(\mathcal{S}, *)$  yields the category of  $(\mathcal{S}, *)$ -multicategories; it would be reasonable to expect a map  $(\mathcal{R}, \bullet) \longrightarrow (\mathcal{S}, *)$  of cartesian monads to yield a functor

$$(\mathcal{R}, \bullet)\text{-Multicat} \longrightarrow (\mathcal{S}, *)\text{-Multicat}.$$

As explained on page 23, ‘map’ might mean either monad functor or monad opfunctor. Whichever meaning we take, we do get the kind of functoriality desired, as long as the monad (op)functor is cartesian (page 24). All this extends to 2-cells, so we have two 2-functors

$$\begin{array}{ccc} \mathbf{CartMnd} & \longrightarrow & \mathbf{Cat} \\ \mathbf{CartMnd}' & \longrightarrow & \mathbf{Cat} \end{array}$$

agreeing on 0-cells.

We now sketch out how a cartesian monad (op)functor yields a functor between multicategory categories. If  $(\mathcal{R}, \bullet) \xrightarrow{(P, \phi)} (\mathcal{S}, *)$  is a cartesian monad functor, then

$$(\mathcal{R}, \bullet)\text{-Multicat} \xrightarrow{\overline{P}} (\mathcal{S}, *)\text{-Multicat}$$

is defined by pullback: for an  $(\mathcal{R}, \bullet)$ -multicategory with graph  $R^\bullet \xleftarrow{q} B \xrightarrow{p} R$ , the graph of the multicategory  $\overline{P}B$  is given by the diagram

$$\begin{array}{ccc} & \overline{PB} & \\ & \swarrow \quad \searrow & \\ (PR)^* & & PB \\ & \searrow \phi_R \quad \swarrow Pq \quad \searrow Pp & \\ & P(R^\bullet) & PR \end{array}$$

If  $(\mathcal{R}, \bullet) \xrightarrow{(P, \phi)} (\mathcal{S}, *)$  is a cartesian monad opfunctor, then  $\overline{P}$  is defined by composition:  $\overline{P}B$  has graph

$$\begin{array}{ccc} & PB & \\ & \swarrow Pq & \searrow Pp \\ & P(R^\bullet) & \\ & \swarrow \phi_R & \\ (PR)^* & & PR \end{array}$$

We have described two categories, **CartMnd** and **CartMnd'**, on which **Multicat** acts as a functor, but there is still another. Suppose we have a diagram

$$\begin{array}{ccc} & (\mathcal{R}, \bullet) & \\ \text{opfunctor } (P, \phi) \uparrow & \parallel & \downarrow \text{functor } (Q, \psi) \\ & (\mathcal{S}, *) & \end{array}$$

in which everything is cartesian,  $P \dashv Q$  (as plain functors), and the unit and counit of the adjunction commute suitably with  $\phi$  and  $\psi$ . Then there arises an adjunction

$$\begin{array}{ccc} (\mathcal{R}, \bullet)\text{-Multicat} & & \\ \bar{P} \uparrow \dashv \downarrow \bar{Q} & , & \\ (\mathcal{S}, *)\text{-Multicat} & & \end{array}$$

defined in an evident way (with  $\bar{P}$  and  $\bar{Q}$  as above). In particular, we can apply this to

$$\begin{array}{ccc} (\mathcal{S}^{(\cdot)*}, id) & & \\ (F, \phi) \uparrow \dashv \downarrow (U, \psi) & & \\ (\mathcal{S}, *) & & \end{array}$$

for any cartesian  $(\mathcal{S}, *)$ , where  $\mathcal{S}^{(\cdot)*}$  is the category of algebras for the monad  $*$  on  $\mathcal{S}$ ,  $F$  and  $U$  are the free algebra and forgetful functors, and  $\phi$  and  $\psi$  are certain canonical natural transformations. This gives the adjunction

$$\begin{array}{ccc} (\mathcal{S}, *)\text{-Structured categories} & & \\ \uparrow \dashv \downarrow & & \\ (\mathcal{S}, *)\text{-Multicat} & & \end{array}$$

of 4.3.

## 4.5 The Endomorphism Multicategory

Any set  $X$  gives rise to an operad  $E = \text{End}(X)$  (for the free monoid monad on **Sets**); it is defined by

$$E(n) = \mathbf{Sets}(X^n, X),$$

with evident units and composition functions. (Recall that for us, an operad is a multicategory with just one object.) Given any operad  $A$ , one may define an algebra for  $A$  to be a set  $X$  together with an operad map  $A \longrightarrow \text{End}(X)$ , and, of course, this is equivalent to the definition of algebra given above. Many theories of operads, e.g. [Bat], define ‘algebra’ in this fashion, so we indicate here how it fits into the general theory.

Suppose we have an  $(\mathcal{S}, *)$ -multicategory  $S^* \longleftarrow A \longrightarrow S$ , and that the category  $\frac{\mathcal{S}}{S^* \times S}$  of  $(\mathcal{S}, *)$ -graphs on  $S$  has exponentials. This occurs, for instance, if  $\mathcal{S}$  is a topos. Let  $(X \xrightarrow{p} S)$  be an object of  $\mathcal{S}/S$ , and put

$$E = \left[ \begin{array}{cc} X^* \times S & S^* \times X \\ \downarrow p^* \times 1, & \downarrow 1 \times p \\ S^* \times S & S^* \times S \end{array} \right]$$

where  $[ \ , \ ]$  indicates exponential. Then  $E$  carries a natural  $(\mathcal{S}, *)$ -multicategory structure, and algebra structures on  $X$  correspond to multicategory maps  $A \longrightarrow E$ .

## 4.6 Characterization of Multicategories by Monads

A traditional May-style operad induces a monad on **Sets**, whose algebras are the algebras of the operad. In our general setting, an  $(\mathcal{S}, *)$ -multicategory on  $\mathcal{S}$  induces a monad on  $\mathcal{S}/S$ . In both cases, one may ask precisely which monads arise from multicategories/operads. Here we answer the question by giving a complete description of multicategories in terms of monads (Lemma 4.6.2).

**Lemma 4.6.1** *Let  $(\mathcal{S}, *)$  be cartesian,  $S^* \longleftarrow A \longrightarrow S$  an  $(\mathcal{S}, *)$ -multicategory, and  $\bullet$  the induced monad on  $\mathcal{S}/S$ . Then the forgetful functor  $\mathcal{S}/S \xrightarrow{U} \mathcal{S}$  naturally carries the structure of a monad opfunctor, this opfunctor is cartesian, and  $\bullet$  is a cartesian monad.*

(For the definition of cartesian monad opfunctor, see page 23 ff.)

**Proof** The data required is a natural transformation

$$\begin{array}{ccc} \mathcal{S}/S & \xrightarrow{\bullet} & \mathcal{S}/S \\ U \downarrow & \swarrow \phi & \downarrow U \\ \mathcal{S} & \xrightarrow{*} & \mathcal{S} \end{array} .$$



That is, for each object  $(X \xrightarrow{p} S)$  of  $\mathcal{S}/S$ , we need a map  $X_{\bullet} \xrightarrow{\phi_p} X^*$ ; this map is part of the pullback square defining  $X_{\bullet}$  in 3.3. The rest of the proof is easy checking.  $\square$

In fact, this monad data arising from  $A$  characterizes completely  $(\mathcal{S}, *)$ -multicategories on  $S$ :

**Lemma 4.6.2** *Let  $(\mathcal{S}, *)$  be cartesian and  $S \in \mathcal{S}$ . Then an  $(\mathcal{S}, *)$ -multicategory on  $S$  is the same thing as a cartesian monad on  $\mathcal{S}/S$  together with the structure of a cartesian monad opfunctor on  $\mathcal{S}/S \xrightarrow{U} \mathcal{S}$ .*

**Proof** Lemma 4.6.1 shows how an  $(\mathcal{S}, *)$ -multicategory  $A$  yields the monad data  $(\mathcal{S}/S, \bullet) \xrightarrow{(U, \phi)} (\mathcal{S}, *)$ . It is easy to see that  $(S \xrightarrow{1} S)_{\bullet} = (A \xrightarrow{c} S)$  and that  $\phi \xrightarrow{1}_{(S \xrightarrow{1} S)}$  is  $A \xrightarrow{d} S^*$ , so from this monad data we can recover the graph structure of the multicategory. Similarly, *ids* and *comp* are recovered as the unit and multiplication of  $\bullet$  at  $(S \xrightarrow{1} S)$ . This tells us how to pass from monad data to a multicategory.  $\square$

As an application of this result, consider the strongly regular algebraic theories (1.4(iv)). If  $\bullet$  is the monad on **Sets** from some strongly regular theory and  $*$  the free monoid monad, then any strongly regular presentation of the theory gives rise to a cartesian natural transformation  $\bullet \longrightarrow *$ , which commutes with the monad structure. We therefore have a cartesian monad  $\bullet$  on **Sets** = **Sets**/1, and the structure of a cartesian monad opfunctor on the forgetful functor **Sets**/1  $\longrightarrow$  **Sets**. By Lemma 4.6.2,  $\bullet$  arises from a  $(\mathbf{Sets}, \text{free monoid})$ -multicategory on 1. Thus, given a strongly regular theory, there is an (ordinary) operad whose algebras are the same as those of the theory.

Lemma 4.6.1 says in particular that the monad  $\bullet$  on  $\mathcal{S}/S$  arising from an  $(\mathcal{S}, *)$ -multicategory  $A$  on  $S$  is cartesian; one may therefore ask what an  $(\mathcal{S}/S, \bullet)$ -multicategory is. The answer is simple:

$$(\mathcal{S}/S, \bullet)\text{-Multicat} \cong (\mathcal{S}, *)\text{-Multicat}/A.$$

## 4.7 A Bicategorical Description

In this section I will give an alternative definition of  $(\mathcal{S}, *)$ -multicategory, using weak 2-monads on bicategories. The significance of this description eludes me, and a notable omission is a definition in this framework of an algebra for a multicategory.

Let  $(\mathcal{S}, *)$  be cartesian. Then there is a kind of weak 2-monad  $*$  induced on the bicategory  $\mathbf{Spans}_{\mathcal{S}}$  of spans in  $\mathcal{S}$ , as follows. The ‘functor’ part is illustrated

by the picture

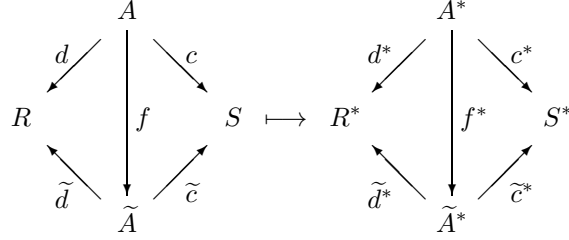

for 2-cells. This ‘functor’ preserves 1-cell composition up to isomorphism; that is, it is a homomorphism of bicategories. The rest of the ‘monad’ structure is described in a similar manner, and it turns out that what we have is:

- a homomorphism  $\mathbf{Spans}_{\mathcal{S}} \xrightarrow{(\ )^*} \mathbf{Spans}_{\mathcal{S}}$
- strong transformations  $1 \xrightarrow{\eta} (\ )^* \xleftarrow{\mu} (\ )^{**}$

such that the monad axioms are satisfied up to invertible modification. (The meaning of these technical terms is that all the 1-cell diagrams stating naturality, associativity, etc., hold up to isomorphism.) Such a structure on a bicategory will just be called a “*monad*”, in inverted commas.

Given a “monad”  $*$  on a bicategory  $\mathcal{B}$ , define an “*algebra*” for  $*$  to be a 0-cell  $S$  together with a 1-cell  $S^* \xrightarrow{h} S$  and 2-cells

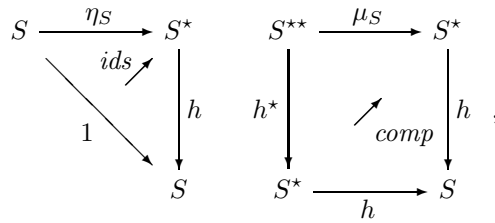

such that the 2-cells satisfy equations looking like associativity and identity laws.

An  $(\mathcal{S}, *)$ -multicategory is then the same thing as an “algebra” for the “monad”  $*$  on  $\mathbf{Spans}_{\mathcal{S}}$ : the 1-cell  $S^* \xrightarrow{h} S$  is a diagram  $S^* \xleftarrow{d} A \xrightarrow{c} S$  in  $\mathcal{S}$ , and the 2-cells  $ids$  and  $comp$  have the roles suggested by their names.

## References

- [Baez] J. Baez, An introduction to  $n$ -categories (1997). In: *7th Conference on Category Theory and Computer Science*, ed. E. Moggi and G. Rosolini, Springer Lecture Notes in Computer Science vol. 1290. Also available via <http://math.ucr.edu/home/baez>.
- [BD] J. Baez, J. Dolan, Higher-dimensional algebra III:  $n$ -categories and the algebra of opetopes (1998). *Adv. Math.* 135, pp. 145–206. Also available via <http://math.ucr.edu/home/baez>.
- [Bat] M. Batanin, Monoidal globular categories as a natural environment for the theory of weak  $n$ -categories (1997). *Adv. Math.* 136, pp. 39–103. Also available via <http://www-math.mpce.mq.edu.au/~mbatanin/papers.html>.
- [Bor] R. Borcherds, Vertex algebras (1997). Available as preprint `q-alg/9706008` (via <http://xxx.soton.ac.uk>, amongst others).
- [Bur] A. Burroni,  $T$ -catégories (1971). *Cahiers Top. Geom. Diff.*, vol. XII, no. 3, pp 215–321 . In French.
- [CJ] A. Carboni, P. Johnstone, Connected limits, familial representability and Artin glueing (1995). *Math. Struct. in Comp. Science*, vol. 5, pp 441–459.
- [Her] C. Hermida, Higher-dimensional multicategories (1997). Lecture slides, available via <http://www.math.mcgill.ca/~hermida>.
- [HMP] C. Hermida, M. Makkai, J. Power, On weak higher dimensional categories (1997). Available via <http://triples.math.mcgill.ca>.
- [Kel1] G. M. Kelly, Many variable functorial calculus I, and An abstract approach to coherence (1972). In: *Coherence in Categories*, ed. Kelly, Laplaza, Lewis, Mac Lane, Springer LNM 281.
- [Kel2] G. M. Kelly, On clubs and data-type constructors (1992). In: *Applications of Categories in Computer Science*, LMS lecture notes 177, CUP, pp 163–190.
- [KS] G. M. Kelly, R. Street, Review of the elements of 2-categories (1974). In: *Category Seminar*, Springer LNM 420, pp 75–103.
- [May] J. P. May, *The Geometry of Iterated Loop Spaces* (1972). Springer LNM 271.
- [Soi] Y. Soibelman, Meromorphic tensor categories (1997). Available as preprint `q-alg/9709030` (via <http://xxx.soton.ac.uk>, amongst others).
- [St] R. Street, The formal theory of monads (1972). *Journal of Pure and Applied Algebra* 2, pp 149–168.