

CLUSTER ALGEBRA STRUCTURES AND SEMICANONICAL BASES FOR UNIPOTENT GROUPS

CHRISTOF GEISS, BERNARD LECLERC, AND JAN SCHRÖER

ABSTRACT. Let Q be a finite quiver without oriented cycles, and let Λ be the associated preprojective algebra. To each terminal $\mathbb{C}Q$ -module M (these are certain preinjective $\mathbb{C}Q$ -modules), we attach a natural subcategory \mathcal{C}_M of $\text{mod}(\Lambda)$. We show that \mathcal{C}_M is a Frobenius category, and that its stable category $\underline{\mathcal{C}}_M$ is a Calabi-Yau category of dimension two.

Then we develop a theory of mutations of maximal rigid objects of \mathcal{C}_M , analogous to the mutations of clusters in Fomin and Zelevinsky's theory of cluster algebras. We also provide an explicit quasi-hereditary structure on the endomorphism algebra of a distinguished maximal rigid object of \mathcal{C}_M , and we use it to describe the combinatorics of mutations.

Next, we show that \mathcal{C}_M yields a categorification of a cluster algebra $\mathcal{A}(\mathcal{C}_M)$, which is not acyclic in general. We give a realization of $\mathcal{A}(\mathcal{C}_M)$ as a subalgebra of the graded dual of the enveloping algebra $U(\mathfrak{n})$, where \mathfrak{n} is a maximal nilpotent subalgebra of the symmetric Kac-Moody Lie algebra \mathfrak{g} associated to the quiver Q .

Let \mathcal{S}^* be the dual of Lusztig's semicanonical basis \mathcal{S} of $U(\mathfrak{n})$. We show that all cluster monomials of $\mathcal{A}(\mathcal{C}_M)$ belong to \mathcal{S}^* , and that $\mathcal{S}^* \cap \mathcal{A}(\mathcal{C}_M)$ is a \mathbb{C} -basis of $\mathcal{A}(\mathcal{C}_M)$.

Next, we prove that $\mathcal{A}(\mathcal{C}_M)$ is naturally isomorphic to the coordinate ring $\mathbb{C}[N(w)]$ of the finite-dimensional unipotent subgroup $N(w)$ of the Kac-Moody group G attached to \mathfrak{g} . Here $w = w(M)$ is the adaptable element of the Weyl group of \mathfrak{g} which we associate to each terminal $\mathbb{C}Q$ -module M .

Moreover, we show that the cluster algebra obtained from $\mathcal{A}(\mathcal{C}_M)$ by formally inverting the generators of the coefficient ring is isomorphic to the algebra $\mathbb{C}[N^w]$ of regular functions on the unipotent cell $N^w := N \cap (B_- w B_-)$ of G . We obtain a corresponding dual semicanonical basis of $\mathbb{C}[N^w]$.

Finally, by "specializing coefficients" we obtain a dual semicanonical basis for a coefficient free cluster algebra \mathcal{A}_w associated to w . As a special case, we obtain a dual semicanonical basis of the (coefficient free) acyclic cluster algebras \mathcal{A}_Q associated to Q , which naturally extends the set of cluster monomials in \mathcal{A}_Q .

CONTENTS

| | |
|--|-----------|
| Part 1. Introduction and main results | 2 |
| 1. Introduction | 2 |
| 2. Main results: Rigid modules over preprojective algebras | 6 |
| 3. Main results: Cluster algebras and semicanonical bases | 9 |
| Part 2. The category \mathcal{C}_M | 18 |
| 4. Representations of quivers and preprojective algebras | 18 |
| 5. Selfinjective torsion classes in $\text{nil}(\Lambda)$ | 20 |
| 6. Lifting homomorphisms from $\text{mod}(KQ)$ to $\text{mod}(\Lambda)$ | 23 |
| 7. Construction of some \mathcal{C}_M -complete rigid modules | 26 |
| 8. \mathcal{C}_M is a cluster torsion class and is stably 2-Calabi-Yau | 31 |

Date: April 5, 2008.

Mathematics Subject Classification (2000): 14M99, 16G20, 17B35, 17B67, 20G05, 81R10.

| | |
|--|-----|
| 9. Relative homology and \mathcal{C} -maximal rigid modules | 36 |
| 10. Tilting and \mathcal{C} -maximal rigid modules | 38 |
| 11. A functor from \mathcal{C}_M to the cluster category \mathcal{C}_Q | 40 |
| Part 3. Mutations | 46 |
| 12. Mutation of \mathcal{C} -maximal rigid modules | 46 |
| 13. Endomorphism algebras of \mathcal{C} -maximal rigid modules | 47 |
| 14. From mutation of modules to mutation of matrices | 50 |
| 15. Mutations of clusters via dimension vectors | 52 |
| 16. The algebra $\text{End}_\Lambda(T_M)$ is quasi-hereditary | 57 |
| 17. Mutations of clusters via Δ -dimension vectors | 72 |
| 18. A sequence of mutations from T_M to T_M^\vee | 74 |
| Part 4. Cluster algebras | 87 |
| 19. Kac-Moody Lie algebras and semicanonical bases | 87 |
| 20. A dual PBW-basis and a dual semicanonical basis for $\mathcal{A}(\mathcal{C}_M)$ | 95 |
| 21. Acyclic cluster algebras | 102 |
| 22. The coordinate rings $\mathbb{C}[N(w)]$ and $\mathbb{C}[N^w]$ | 103 |
| 23. Open problems | 117 |
| References | 119 |

Part 1. Introduction and main results

1. INTRODUCTION

1.1. Introduction. This is the continuation of an extensive project to obtain a better understanding of the relations between the following topics:

- (i) Representation theory of quivers,
- (ii) Representation theory of preprojective algebras,
- (iii) Lusztig's (semi)canonical basis of universal enveloping algebras,
- (iv) Fomin and Zelevinsky's theory of cluster algebras,
- (v) Frobenius categories and 2-Calabi-Yau categories,
- (vi) Cluster algebra structures on coordinate algebras of unipotent groups, Bruhat cells and flag varieties.

The topics (i) and (iii) are closely related. The numerous connections have been studied by many authors. Let us just mention Lusztig's work on canonical bases of quantum groups, and Ringel's Hall algebra approach to quantum groups. An important link between (ii) and (iii), due to Lusztig [L1, L3] and Kashiwara and Saito [KS] is that the elements of the (semi)canonical basis are naturally parametrized by the irreducible components of the varieties of nilpotent representations of a preprojective algebra.

Cluster algebras were invented by Fomin and Zelevinsky [BFZ, FZ2, FZ3], with the aim of providing a new algebraic and combinatorial setting for canonical bases and total positivity. One important breakthrough was the insight that the class of acyclic cluster algebras with a skew-symmetric exchange matrix can be categorified using the so-called cluster categories. Cluster categories were introduced by Buan, Marsh, Reineke, Reiten and Todorov [BMRRT]. In a series of papers by some of these authors and also by

Caldero and Keller [CK1, CK2], it was established that cluster categories have all necessary properties to provide the mentioned categorification. We refer to the nice overview article [BM] for more details on the development of this beautiful theory which established a strong connection between the topics (i), (iv) and (v).

In [GLS5] we showed that the representation theory of preprojective algebras Λ of Dynkin type (i.e. type \mathbb{A} , \mathbb{D} or \mathbb{E}) is also closely related to cluster algebras. We proved that $\text{mod}(\Lambda)$ can be regarded as a categorification of a natural cluster structure on the polynomial algebra $\mathbb{C}[N]$. Here N is a maximal unipotent subgroup of a complex Lie group of the same type as Λ . Let \mathfrak{n} be its Lie algebra, and $U(\mathfrak{n})$ be the universal enveloping algebra of \mathfrak{n} . The graded dual $U(\mathfrak{n})_{\text{gr}}^*$ can be identified with the coordinate algebra $\mathbb{C}[N]$. By means of our categorification, we were able to prove that all the cluster monomials of $\mathbb{C}[N]$ belong to the dual of Lusztig's semicanonical basis of $U(\mathfrak{n})$. Note that the cluster algebra $\mathbb{C}[N]$ is in general not acyclic.

The aim of this article is to extend these results to the more general setting of Kac-Moody groups and their unipotent cells. We also provide additional tools for studying these categories and cluster structures. For example we show that the endomorphism algebras of certain maximal rigid modules are quasi-hereditary and deduce from this a new combinatorial algorithm for mutations.

More precisely, we consider preprojective algebras $\Lambda = \Lambda_Q$ attached to quivers Q which are not necessarily of Dynkin type. These algebras are therefore infinite-dimensional in general. The category $\text{nil}(\Lambda)$ of all finite-dimensional nilpotent representations of Λ is then too large to be related to a cluster algebra of finite rank. Moreover, it does not have projective or injective objects, and it lacks an Auslander-Reiten translation. However, we give a general procedure to attach to certain preinjective representations M of Q a natural subcategory \mathcal{C}_M of $\text{nil}(\Lambda)$. We show that these subcategories \mathcal{C}_M are Frobenius categories and that the corresponding stable categories $\underline{\mathcal{C}}_M$ are Calabi-Yau categories of dimension two. Each subcategory \mathcal{C}_M comes with two distinguished maximal rigid modules T_M and T_M^\vee described combinatorially. In the special case where Q is of Dynkin type and M is the sum of all indecomposable representations of Q (up to isomorphism) we have $\mathcal{C}_M = \text{mod}(\Lambda)$, the modules T_M and T_M^\vee are those constructed in [GLS2], and we recover the setting of [GLS5]. In another direction, if Q is an arbitrary (acyclic) quiver and $M = I \oplus \tau(I)$, where I is the sum of the indecomposable injective representations of Q and τ is the Auslander-Reiten translation, it follows from a result of Keller and Reiten [KR] that the stable category $\underline{\mathcal{C}}_M$ is triangle equivalent to the cluster category \mathcal{C}_Q of [BMRRT]. We provide in this case a natural functor $G: \mathcal{C}_M \rightarrow \mathcal{C}_Q$ inducing an equivalence $\underline{G}: \underline{\mathcal{C}}_M \rightarrow \mathcal{C}_Q$ of additive categories.

We then develop, as in [GLS5], a theory of mutations for maximal rigid objects T in \mathcal{C}_M , and we study their endomorphism algebras $\text{End}_\Lambda(T)$. We show that these algebras have global dimension 3 and that their quiver has neither loops nor 2-cycles. Special attention is given to the algebra $B := \text{End}_\Lambda(T_M)$ for which we provide an explicit quasi-hereditary structure. We prove that \mathcal{C}_M is anti-equivalent to the category of Δ -filtered B -modules. This allows us to describe the mutations of maximal rigid Λ -modules in terms of the Δ -dimension vectors of the corresponding $\text{End}_\Lambda(T_M)$ -modules. We also exhibit a simple sequence of mutations between T_M and T_M^\vee and describe all the maximal rigid modules arising from this sequence.

In the last part we associate to the subcategory \mathcal{C}_M a cluster algebra $\mathcal{A}(\mathcal{C}_M)$ which in general is not acyclic, and we show that \mathcal{C}_M can be seen as a categorification of $\mathcal{A}(\mathcal{C}_M)$. (As

a very special case, we also obtain in this way a new categorification of every acyclic cluster algebra with a skew-symmetric exchange matrix and a certain choice of coefficients.) The proof relies on the fact that the algebra $\mathcal{A}(\mathcal{C}_M)$ has a natural realization as a certain subalgebra of the graded dual $U(\mathfrak{n})_{\text{gr}}^*$, where \mathfrak{n} is now the positive part of the Kac-Moody Lie algebra $\mathfrak{g} = \mathfrak{n}_- \oplus \mathfrak{h} \oplus \mathfrak{n}$ of the same type as Λ . We show that again all the cluster monomials belong to the dual of Lusztig's semicanonical basis of $U(\mathfrak{n})$. Next, we prove that $\mathcal{A}(\mathcal{C}_M)$ has a simple monomial basis coming from the objects of the additive closure $\text{add}(M)$ of M . We call it the *dual PBW-basis* of $\mathcal{A}(\mathcal{C}_M)$, and regard it as a generalization (in the dual setting) of the bases of $U(\mathfrak{n})$ constructed by Ringel in terms of quiver representations, when \mathfrak{g} is finite-dimensional [Ri6]. We use this to prove that $\mathcal{A}(\mathcal{C}_M)$ is spanned by a subset of the dual semicanonical basis of $U(\mathfrak{n})_{\text{gr}}^*$. Thus, we obtain another natural basis of $\mathcal{A}(\mathcal{C}_M)$ containing all the cluster monomials. We call it the *dual semi-canonical basis* of $\mathcal{A}(\mathcal{C}_M)$. Finally, we prove that $\mathcal{A}(\mathcal{C}_M)$ is isomorphic to the coordinate ring of a finite-dimensional unipotent subgroup of the Kac-Moody group G attached to \mathfrak{g} . Moreover, we show that the cluster algebra obtained from $\mathcal{A}(\mathcal{C}_M)$ by formally inverting the generators of the coefficient ring is isomorphic to the algebra of regular functions on a certain unipotent cell of G . This solves Conjecture III.3.1 of [BIRS] for all unipotent cells attached to an *adaptable* element w of the Weyl group of G (the definition of adaptable is given below, see § 3.7). Note also that in the Dynkin case, we recover a result of [BFZ] for the double Bruhat cells of type (e, w) with w adaptable, but our proof is different and shows that the coordinate ring of the cell is not only an upper cluster algebra but a genuine cluster algebra. In the last section, we explain how the results of this paper are related to those of [GLS6], in which a cluster algebra structure on the coordinate ring of the unipotent radical N_K of a parabolic subgroup of a complex simple algebraic group of type $\mathbb{A}, \mathbb{D}, \mathbb{E}$ was introduced. We give a proof of Conjecture 9.6 of [GLS6] in the case where the Weyl group element $w_0 w_0^K$ is adaptable.

Our results have some overlap with the recent work of Buan, Iyama, Reiten and Scott [BIRS]. Up to a simple duality, our categories \mathcal{C}_M coincide with the categories \mathcal{C}_w introduced in [BIRS], but only for adaptable Weyl group elements w , and our maximal rigid modules T_M^\vee are some of the cluster-tilting objects of the categories \mathcal{C}_w described in [BIRS]. However our methods are very different, and for our smaller class of categories we can prove stronger results, like the existence of quasi-hereditary endomorphism algebras or the existence of semicanonical bases for the corresponding cluster algebras.

1.2. Plan of the paper. This article is organized as follows.

In Sections 2, 3, we give a more detailed presentation of our results.

Part 2 is devoted to the study of the subcategories \mathcal{C}_M . Some known results on quiver representations and preprojective algebras are collected in Section 4. In Section 5 we introduce the important concept of a *selfinjective torsion class* of $\text{mod}(\Lambda)$. Some technical but crucial results on the lifting of certain KQ -module homomorphisms to Λ -module homomorphisms are proved in Section 6. These results are used in Section 7 to construct a \mathcal{C}_M -complete rigid module T_M and to compute the quiver of its endomorphism algebra. Then we show in Section 8 that \mathcal{C}_M is a Frobenius category whose stable category $\underline{\mathcal{C}}_M$ is a 2-Calabi-Yau category. In particular, it turns out that \mathcal{C}_M is a selfinjective torsion class of $\text{mod}(\Lambda)$. In Sections 9 and 10 we prove some basic properties of \mathcal{C} -maximal rigid modules, where \mathcal{C} is now an arbitrary selfinjective torsion class of $\text{mod}(\Lambda)$. In Section 11 we show that for every quiver Q without oriented cycles there exists a terminal KQ -module M such that the stable category $\underline{\mathcal{C}}_M$ is triangle equivalent to the cluster category \mathcal{C}_Q as defined in [BMRRT]. This uses a recent result by Keller and Reiten [KR]. We

also construct an explicit functor $\mathcal{C}_M \rightarrow \mathcal{C}_Q$ which then yields an equivalence of additive categories $\underline{\mathcal{C}}_M \rightarrow \mathcal{C}_Q$.

Part 3 develops the theory of mutations of rigid objects of \mathcal{C}_M . Sections 12, 13 and 14 contain the adaptation of the results in [GLS5, Sections 5, 6, 7] to our more general situation of selfinjective torsion classes. In Section 15 we prove that cluster variables are determined by their dimension vector, in the appropriate sense, and that one can describe the mutation of clusters in terms of these dimension vectors. We also obtain a characterization of all short exact sequences of Λ -modules which become split exact sequences of KQ -modules after applying the restriction functor π_Q . We show in Section 16 that $\text{End}_\Lambda(T_M)$ is a quasi-hereditary algebra. This can be used to reformulate the results in Section 15 in terms of Δ -dimension vectors, see Section 17. In Section 18 we construct a sequence of mutations starting with our module T_M which yields generalizations of classical determinantal identities.

Part 4 contains the applications of the previous constructions to cluster algebras. In Section 19 we repeat several known results on Kac-Moody Lie algebras, and also recall our results about the multiplicative behaviour of the functions δ_X . One of the central parts of our theory is the construction of dual PBW- and dual semicanonical bases for the cluster algebras $\mathcal{R}(\mathcal{C}_M)$. This is done in Section 20. The special case of acyclic cluster algebras is discussed in Section 21. In Section 22 we prove all our results on cluster algebra structures of coordinate rings. Finally, we present some open problems in Section 23.

1.3. Notation. Throughout let K be an algebraically closed field. For a K -algebra A let $\text{mod}(A)$ be the category of finite-dimensional left A -modules. By a *module* we always mean a finite-dimensional left module. Often we do not distinguish between a module and its isomorphism class. Let $D = \text{Hom}_K(-, K): \text{mod}(A) \rightarrow \text{mod}(A^{\text{op}})$ be the usual duality.

For a quiver Q let $\text{rep}(Q)$ be the category of finite-dimensional representations of Q over K . It is well known that we can identify $\text{rep}(Q)$ and $\text{mod}(KQ)$.

By a *subcategory* we always mean a full subcategory. For an A -module M let $\text{add}(M)$ be the subcategory of all A -modules which are isomorphic to finite direct sums of direct summands of M . A subcategory \mathcal{U} of $\text{mod}(A)$ is an *additive subcategory* if any finite direct sum of modules in \mathcal{U} is again in \mathcal{U} . By $\text{Fac}(M)$ (resp. $\text{Sub}(M)$) we denote the subcategory of all A -modules X such that there exists some $t \geq 1$ and some epimorphism $M^t \rightarrow X$ (resp. monomorphism $X \rightarrow M^t$).

For an A -module M let $\Sigma(M)$ be the number of isomorphism classes of indecomposable direct summands of M . An A -module is called *basic* if it can be written as a direct sum of pairwise non-isomorphic indecomposable modules.

For a vector space V we sometimes write $|V|$ for the dimension of V . If $f: X \rightarrow Y$ and $g: Y \rightarrow Z$ are maps, then the composition is denoted by $gf = g \circ f: X \rightarrow Z$.

If U is a subset of a K -vector space V , then let $\text{Span}_K\langle U \rangle$ be the subspace of V generated by U .

By $K(X_1, \dots, X_r)$ (resp. $K[X_1, \dots, X_r]$) we denote the field of rational functions (resp. the polynomial ring) in the variables X_1, \dots, X_r with coefficients in K .

Let \mathbb{C} be the field of complex numbers, and let $\mathbb{N} = \{0, 1, 2, \dots\}$ be the natural numbers, including 0. Set $\mathbb{N}_1 := \mathbb{N} \setminus \{0\}$. For natural numbers $a \leq b$ let $[a, b] = \{i \in \mathbb{N} \mid a \leq i \leq b\}$.

Recommended introductions to representation theory of finite-dimensional algebras and Auslander-Reiten theory are the books [ARS, ASS, GR, Ri1].

2. MAIN RESULTS: RIGID MODULES OVER PREPROJECTIVE ALGEBRAS

2.1. Preprojective algebras. Throughout, let Q be a finite quiver without oriented cycles, and let

$$\Lambda = \Lambda_Q = K\overline{Q}/(c)$$

be the associated *preprojective algebra*. We assume that Q is connected and has vertices $\{1, \dots, n\}$ with n at least two. Here K is an algebraically closed field, $K\overline{Q}$ is the path algebra of the *double quiver* \overline{Q} of Q which is obtained from Q by adding to each arrow $a: i \rightarrow j$ in Q an arrow $a^*: j \rightarrow i$ pointing in the opposite direction, and (c) is the ideal generated by the element

$$c = \sum_{a \in Q_1} (a^*a - aa^*)$$

where Q_1 is the set of arrows of Q . Clearly, the path algebra KQ is a subalgebra of Λ . We denote by

$$\pi_Q: \text{mod}(\Lambda) \rightarrow \text{mod}(KQ)$$

the corresponding restriction functor.

2.2. Terminal KQ -modules. Let $\tau = \tau_Q$ be the Auslander-Reiten translation of KQ , and let I_1, \dots, I_n be the indecomposable injective KQ -modules. A KQ -module M is called *preinjective* if M is isomorphic to a direct sum of modules of the form $\tau^j(I_i)$ where $j \geq 0$ and $1 \leq i \leq n$. There is the dual notion of a preprojective module.

A KQ -module $M = M_1 \oplus \dots \oplus M_r$ with M_i indecomposable and $M_i \not\cong M_j$ for all $i \neq j$ is called a *terminal KQ -module* if the following hold:

- (i) M is preinjective;
- (ii) If X is an indecomposable KQ -module with $\text{Hom}_{KQ}(M, X) \neq 0$, then $X \in \text{add}(M)$;
- (iii) $I_i \in \text{add}(M)$ for all indecomposable injective KQ -modules I_i .

In other words, the indecomposable direct summands of M are the vertices of a subgraph of the preinjective component of the Auslander-Reiten quiver of KQ which is closed under successor. We define

$$t_i := t_i(M) := \max \{j \geq 0 \mid \tau^j(I_i) \in \text{add}(M) \setminus \{0\}\}.$$

2.3. The subcategory \mathcal{C}_M . Let M be a terminal KQ -module, and let

$$\mathcal{C}_M := \pi_Q^{-1}(\text{add}(M))$$

be the subcategory of all Λ -modules X with $\pi_Q(X) \in \text{add}(M)$. Notice that if Q is a Dynkin quiver and M is the sum of all indecomposable representations of Q then $\mathcal{C}_M = \text{mod}(\Lambda)$.

Theorem 2.1. *Let M be a terminal KQ -module. Then the following hold:*

- (i) \mathcal{C}_M is a Frobenius category with n indecomposable \mathcal{C}_M -projective-injectives;
- (ii) The stable category $\underline{\mathcal{C}}_M$ is a 2-Calabi-Yau category;
- (iii) If $t_i(M) = 1$ for all i , then $\underline{\mathcal{C}}_M$ is triangle equivalent to the cluster category \mathcal{C}_Q associated to Q .

Part (i) and (ii) of Theorem 2.1 are proved in Section 8. Based on results in Section 7, Part (iii) is shown in Section 10.

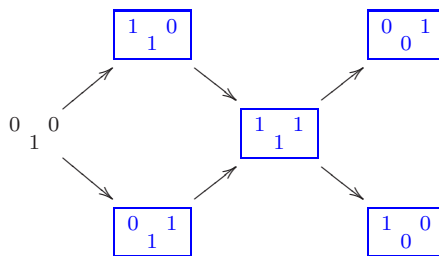

FIGURE 1. A terminal module in type \mathbb{A}_3

2.4. **An example of type \mathbb{A}_3 .** Let Q be the quiver



Figure 1 shows the Auslander-Reiten quiver of KQ . The indecomposable direct summands of a terminal KQ -module M are marked in blue colour. In Figure 2 we show the Auslander-Reiten quiver of the preprojective algebra Λ of type \mathbb{A}_3 . We display the graded dimension vectors of the indecomposable Λ -modules. (There is a Galois covering of Λ , and the associated push-down functor is dense, a property which only holds for Dynkin types \mathbb{A}_n , $n \leq 4$. In this case, all Λ -modules are uniquely determined (up to \mathbb{Z} -shift) by their dimension vector in the covering. See [GLS1] for more details.) Note that one has to identify the objects on the two dotted vertical lines. The indecomposable \mathcal{C}_M -projective-injective modules are marked in red colour, all other indecomposable modules in \mathcal{C}_M are marked in blue. Observe that \mathcal{C}_M contains 7 indecomposable modules, and three of these are \mathcal{C}_M -projective-injective. The stable category $\underline{\mathcal{C}}_M$ is triangle equivalent to the product $\mathcal{C}_{\mathbb{A}_1} \times \mathcal{C}_{\mathbb{A}_1}$ of two cluster categories of type \mathbb{A}_1 .

2.5. **Maximal rigid modules and their endomorphism algebras.** A Λ -module T is *rigid* if $\text{Ext}_\Lambda^1(T, T) = 0$. For a module X let $\Sigma(X)$ be the number of isomorphism classes of indecomposable direct summands of X .

Let \mathcal{C} be a subcategory of $\text{mod}(\Lambda)$. Define the *rank* of \mathcal{C} as

$$\text{rk}(\mathcal{C}) = \max\{\Sigma(T) \mid T \text{ rigid in } \mathcal{C}\}$$

if such a maximum exists, and set $\text{rk}(\mathcal{C}) = \infty$, otherwise.

The category \mathcal{C} is called *Q -finite* if there exists some $M \in \text{mod}(KQ)$ such that

$$\pi_Q(\mathcal{C}) \subseteq \text{add}(M).$$

In this case, if \mathcal{C} is additive, one can imitate the proof of [GS, Theorem 1.1] to show that $\text{rk}(\mathcal{C}) \leq \Sigma(M)$. If M is a terminal KQ -module, then we prove that $\text{rk}(\mathcal{C}_M) = \Sigma(M)$, see Corollary 7.4.

Recall that for all $X, Y \in \text{mod}(\Lambda)$ we have $\dim \text{Ext}_\Lambda^1(X, Y) = \dim \text{Ext}_\Lambda^1(Y, X)$, see [CB1] and also [GLS4]. Assume that T is a rigid Λ -module in an additive subcategory \mathcal{C} of $\text{mod}(\Lambda)$ with $\text{rk}(\mathcal{C}) < \infty$. We need the following definitions:

- T is *\mathcal{C} -complete rigid* if $\Sigma(T) = \text{rk}(\mathcal{C})$;
- T is *\mathcal{C} -maximal rigid* if $\text{Ext}_\Lambda^1(T \oplus X, X) = 0$ with $X \in \mathcal{C}$ implies $X \in \text{add}(T)$;
- T is *\mathcal{C} -maximal 1-orthogonal* if $\text{Ext}_\Lambda^1(T, X) = 0$ with $X \in \mathcal{C}$ implies $X \in \text{add}(T)$.

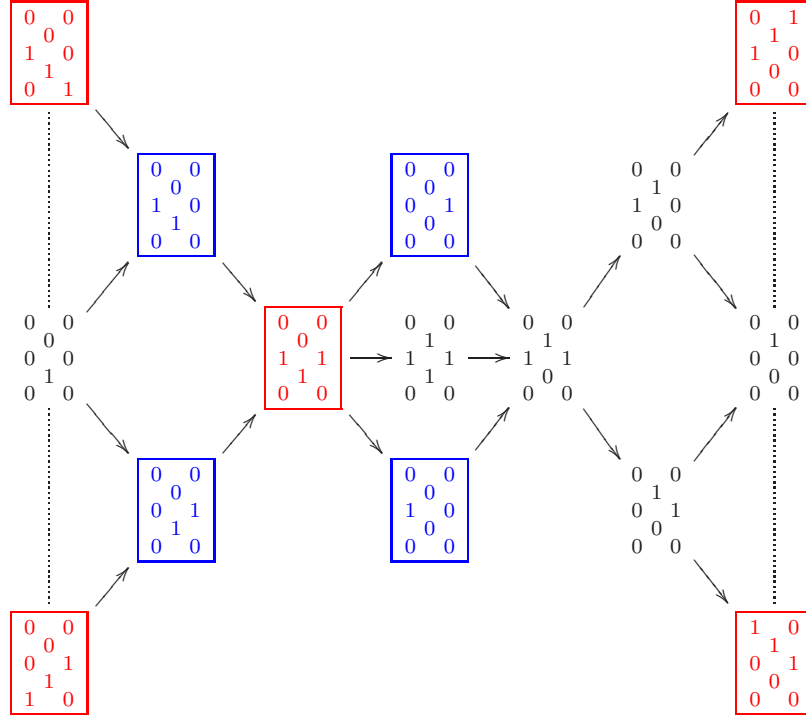

FIGURE 2. A category $\mathcal{C}_M \subset \text{mod}(\Lambda)$ with $\underline{\mathcal{C}}_M$ triangle equivalent to $\mathcal{C}_{\mathbb{A}_1 \times \mathbb{A}_1}$

The notion of a maximal 1-orthogonal module is due to Iyama [Iy1]. These modules are also called *cluster tilting objects*.

Theorem 2.2. *Let M be a terminal KQ -module. For a Λ -module T in \mathcal{C}_M the following are equivalent:*

- (i) T is \mathcal{C}_M -complete rigid;
- (ii) T is \mathcal{C}_M -maximal rigid;
- (iii) T is \mathcal{C}_M -maximal 1-orthogonal.

If T satisfies one of the above equivalent conditions, then the following hold:

- $\text{gl. dim}(\text{End}_\Lambda(T)) = 3$;
- The quiver Γ_T of $\text{End}_\Lambda(T)$ has no loops and no 2-cycles.

The proof of Theorem 2.2 can be found in Section 13.

2.6. The complete rigid modules T_M and T_M^\vee . Let $M = M_1 \oplus \cdots \oplus M_r$ be a terminal KQ -module. Without loss of generality assume that M_{r-n+1}, \dots, M_r are injective. Let Γ_M be the quiver of $\text{End}_{KQ}(M)$. Its vertices $1, \dots, r$ correspond to M_1, \dots, M_r , and the number of arrows $i \rightarrow j$ equals the number of arrows in the Auslander-Reiten quiver of $\text{mod}(KQ)$ which start in M_i and end in M_j .

Let Γ_M^* be the quiver which is obtained from Γ_M by adding an arrow $i \rightarrow j$ whenever $M_j = \tau(M_i)$. Our results in Sections 6 and 7 yield the following theorem:

Theorem 2.3. *There exist two \mathcal{C}_M -complete rigid Λ -modules T_M and T_M^\vee such that*

$$\Gamma_{T_M} = \Gamma_{T_M^\vee} = \Gamma_M^*.$$

For the explicit description of T_M and T_M^\vee see Section 7. Here we just note that the \mathcal{C}_M -projective direct summands of T_M correspond to the rightmost vertices of Γ_M^* , whereas the \mathcal{C}_M -projective direct summands of T_M^\vee correspond to the leftmost vertices of Γ_M^* .

2.7. A quasi-hereditary algebra. Now consider $B := \text{End}_\Lambda(T_M)$. We prove in Section 16 the following theorem:

Theorem 2.4. (i) *B is a quasi-hereditary algebra;*
(ii) *The restriction of the contravariant functor $\text{Hom}_\Lambda(-, T_M): \text{mod}(\Lambda) \rightarrow \text{mod}(B)$ induces an anti-equivalence $F: \mathcal{C}_M \rightarrow \mathcal{F}(\Delta)$ where $\mathcal{F}(\Delta)$ is the category of Δ -filtered B -modules and*

$$\Delta := \{F(M_i) \mid 1 \leq i \leq r\}$$

is the set of standard modules. (We interpret M_i as a Λ -module using the obvious embedding functor.);

(iii) *For a short exact sequence $0 \rightarrow X \rightarrow Y \rightarrow Z \rightarrow 0$ in \mathcal{C}_M the following are equivalent:*
(a) *The short exact sequence $0 \rightarrow \pi_Q(X) \rightarrow \pi_Q(Y) \rightarrow \pi_Q(Z) \rightarrow 0$ splits;*
(b) *The sequence $0 \rightarrow F(Z) \rightarrow F(Y) \rightarrow F(X) \rightarrow 0$ is exact.*

It turns out that $\text{Hom}_\Lambda(T_M^\vee, T_M)$ is the characteristic tilting module over B . In particular, $\text{End}_\Lambda(T_M^\vee)$ is also quasi-hereditary.

3. MAIN RESULTS: CLUSTER ALGEBRAS AND SEMICANONICAL BASES

3.1. The cluster algebra $\mathcal{A}(\mathcal{C}_M)$. We refer to [FZ4] for an excellent survey on cluster algebras. Here we only recall the main definitions and introduce a cluster algebra $\mathcal{A}(\mathcal{C}_M, T)$ associated to a terminal KQ -module M and any \mathcal{C}_M -maximal rigid module T .

If $\tilde{B} = (b_{ij})$ is any $r \times (r - n)$ -matrix with integer entries, then the *principal part* B of \tilde{B} is obtained from \tilde{B} by deleting the last n rows. Given some $k \in [1, r - n]$ define a new $r \times (r - n)$ -matrix $\mu_k(\tilde{B}) = (b'_{ij})$ by

$$b'_{ij} = \begin{cases} -b_{ij} & \text{if } i = k \text{ or } j = k, \\ b_{ij} + \frac{|b_{ik}|b_{kj} + b_{ik}|b_{kj}|}{2} & \text{otherwise,} \end{cases}$$

where $i \in [1, r]$ and $j \in [1, r - n]$. One calls $\mu_k(\tilde{B})$ a *mutation* of \tilde{B} . If \tilde{B} is an integer matrix whose principal part is skew-symmetric, then it is easy to check that $\mu_k(\tilde{B})$ is also an integer matrix with skew-symmetric principal part. In this case, Fomin and Zelevinsky define a cluster algebra $\mathcal{A}(\tilde{B})$ as follows. Let $\mathcal{F} = \mathbb{C}(y_1, \dots, y_r)$ be the field of rational functions in r commuting variables $\mathbf{y} = (y_1, \dots, y_r)$. One calls (\mathbf{y}, \tilde{B}) the *initial seed* of $\mathcal{A}(\tilde{B})$. For $1 \leq k \leq r - n$ define

$$(1) \quad y_k^* = \frac{\prod_{b_{ik} > 0} y_i^{b_{ik}} + \prod_{b_{ik} < 0} y_i^{-b_{ik}}}{y_k}.$$

The pair $(\mu_k(\mathbf{y}), \mu_k(\tilde{B}))$, where $\mu_k(\mathbf{y})$ is obtained from \mathbf{y} by replacing y_k by y_k^* , is the *mutation in direction k* of the seed (\mathbf{y}, \tilde{B}) .

Now one can iterate this process of mutation and obtain inductively a set of seeds. Thus each seed consists of an r -tuple of algebraically independent elements of \mathcal{F} called a *cluster* and of a matrix called the *exchange matrix*. The elements of a cluster are its *cluster variables*. A seed has $r - n$ neighbours obtained by mutation in direction $1 \leq k \leq r - n$. One does not mutate the last n elements of a cluster, they serve as "coefficients" and belong to every cluster. The *cluster algebra* $\mathcal{A}(\tilde{B})$ is by definition the subalgebra of \mathcal{F} generated by the set of all cluster variables appearing in all seeds obtained by iterated mutation starting with the initial seed.

It is often convenient to define a cluster algebra using an oriented graph, as follows. Let Γ be a quiver without loops or 2-cycles with vertices $\{1, \dots, r\}$. We can define an $r \times r$ -matrix $B(\Gamma) = (b_{ij})$ by setting

$$b_{ij} = (\text{number of arrows } j \rightarrow i \text{ in } \Gamma) - (\text{number of arrows } i \rightarrow j \text{ in } \Gamma).$$

Let $B(\Gamma)^\circ$ be the $r \times (r - n)$ -matrix obtained by deleting the last n columns of $B(\Gamma)$. The principal part of $B(\Gamma)^\circ$ is skew-symmetric, hence this yields a cluster algebra $\mathcal{A}(B(\Gamma)^\circ)$.

We apply this procedure to our subcategory \mathcal{C}_M . Let $T = T_1 \oplus \dots \oplus T_r$ be a basic \mathcal{C}_M -maximal rigid Λ -module with T_i indecomposable for all i . Without loss of generality assume that T_{r-n+1}, \dots, T_r are \mathcal{C}_M -projective. By Γ_T we denote the quiver of the endomorphism algebra $\text{End}_\Lambda(T)$. We then define the cluster algebra

$$\mathcal{A}(\mathcal{C}_M, T) := \mathcal{A}(B(\Gamma_T)^\circ).$$

In particular, we denote by $\mathcal{A}(\mathcal{C}_M)$ the cluster algebra $\mathcal{A}(\mathcal{C}_M, T_M)$ attached to the complete rigid module T_M of Section 2.6. Thus $\mathcal{A}(\mathcal{C}_M) := \mathcal{A}(B(\Gamma_M^*)^\circ)$.

3.2. Mutation of rigid modules. Let T be a basic \mathcal{C}_M -maximal rigid Λ -module. Write $B(T) = B(\Gamma_T) = (t_{ij})_{1 \leq i, j \leq r}$. For $k \in [1, r - n]$ there is a short exact sequence

$$0 \rightarrow T_k \xrightarrow{f} \bigoplus_{t_{ik} > 0} T_i^{t_{ik}} \rightarrow T_k^* \rightarrow 0$$

where f is a minimal left $\text{add}(T/T_k)$ -approximation of T_k , i.e. the map $\text{Hom}_\Lambda(f, T)$ is surjective, and every morphism h with $hf = f$ is an isomorphism. Set

$$\mu_{T_k}(T) = T_k^* \oplus T/T_k.$$

We show that $\mu_{T_k}(T)$ is again a basic \mathcal{C}_M -maximal rigid module. In particular, T_k^* is indecomposable. We call $\mu_{T_k}(T)$ the *mutation of T in direction T_k* .

There is also a short exact sequence

$$0 \rightarrow T_k^* \rightarrow \bigoplus_{t_{ik} < 0} T_i^{-t_{ik}} \xrightarrow{g} T_k \rightarrow 0$$

where g is now a minimal right $\text{add}(T/T_k)$ -approximation of T_k .

It turns out that the quivers of the endomorphism algebras $\text{End}_\Lambda(T)$ and $\text{End}_\Lambda(\mu_{T_k}(T))$ are related via Fomin and Zelevinsky's mutation rule:

Theorem 3.1. *Let M be a terminal KQ -module. For a basic \mathcal{C}_M -maximal rigid Λ -module T as above and $k \in [1, r - n]$ we have*

$$B(\mu_{T_k}(T))^\circ = \mu_k(B(T)^\circ).$$

The proof can be found in Section 14.

We conjecture that, given two basic \mathcal{C}_M -maximal rigid Λ -modules T and T' , there always exists a sequence of mutations changing T into T' . Using Theorem 3.1, this would imply that the cluster algebras $\mathcal{A}(\mathcal{C}_M, T)$ do not depend on T . The following weaker result is given and illustrated with examples in Section 18:

Theorem 3.2. *There is a sequence of mutations changing T_M into T_M^\vee . Therefore*

$$\mathcal{A}(\mathcal{C}_M, T_M^\vee) = \mathcal{A}(\mathcal{C}_M, T_M) = \mathcal{A}(\mathcal{C}_M).$$

3.3. The dual semicanonical basis. We recall the definition of the dual semicanonical basis and its multiplicative properties, following [L1, L3, GLS1, GLS4]

From now on, assume that $K = \mathbb{C}$. Let Λ_d be the affine variety of nilpotent Λ -modules with dimension vector $d \in \mathbb{N}^n$. For a module $X \in \Lambda_d$ and an m -tuple $\mathbf{i} = (i_1, \dots, i_m)$ with $1 \leq i_j \leq n$ for all j , let $\mathcal{F}_{\mathbf{i}, X}$ denote the projective variety of composition series of X of type \mathbf{i} . Thus an element in $\mathcal{F}_{\mathbf{i}, X}$ is a flag

$$(0 = X_0 \subset X_1 \subset \dots \subset X_m = X)$$

of submodules X_j of X such that for all $1 \leq j \leq m$ the subfactor X_j/X_{j-1} is isomorphic to the simple Λ -module S_{i_j} associated to the vertex i_j of Q . Let

$$d_{\mathbf{i}}: \Lambda_d \rightarrow \mathbb{C}$$

be the map which sends $X \in \Lambda_d$ to $\chi_c(\mathcal{F}_{\mathbf{i}, X})$, the topological Euler characteristic of $\mathcal{F}_{\mathbf{i}, X}$ with respect to cohomology with compact support. Let \mathcal{M}_d be the \mathbb{C} -vector space spanned by the maps $d_{\mathbf{i}}$ and set

$$\mathcal{M} := \bigoplus_{d \in \mathbb{N}^n} \mathcal{M}_d.$$

Lusztig [L1, L3] has introduced a ‘‘convolution product’’ $\star: \mathcal{M} \times \mathcal{M} \rightarrow \mathcal{M}$ such that $d_{\mathbf{i}} \star d_{\mathbf{j}} = d_{\mathbf{k}}$, where $\mathbf{k} := (i_1, \dots, i_m, j_1, \dots, j_l)$ is the concatenation of \mathbf{i} and \mathbf{j} . (The definition of \star is recalled in Section 19.4.) He proved that \mathcal{M} equipped with this product is isomorphic to the enveloping algebra $U(\mathfrak{n})$ of the maximal nilpotent subalgebra \mathfrak{n} of the Kac-Moody Lie algebra \mathfrak{g} associated to Q .

Since $U(\mathfrak{n})$ is a cocommutative Hopf algebra, the graded dual

$$U(\mathfrak{n})_{\text{gr}}^* \cong \mathcal{M}^* := \bigoplus_{d \in \mathbb{N}^n} \mathcal{M}_d^*$$

is a commutative \mathbb{C} -algebra. For $X \in \Lambda_d$ we have an evaluation map $\delta_X \in \mathcal{M}_d^* \subset \mathcal{M}^*$, given by

$$\delta_X(f) := f(X)$$

for $f \in \mathcal{M}_d$. In particular, $\delta_X(d_{\mathbf{i}}) := \chi_c(\mathcal{F}_{\mathbf{i}, X})$. It is shown in [GLS1] that

$$\delta_X \delta_Y = \delta_{X \oplus Y}.$$

In [GLS4] a more complicated formula is given, expressing $\delta_X \delta_Y$ as a linear combination of δ_Z where Z runs over all possible middle terms of non-split short exact sequences with end terms X and Y . The formula is especially useful when $\dim \text{Ext}_{\Lambda}^1(X, Y) = 1$ (see Section 19.5).

Let $\text{Irr}(\Lambda_d)$ be the set of irreducible components of Λ_d . For each $Z \in \text{Irr}(\Lambda_d)$ there exists a dense open subset U in Z such that $\delta_X = \delta_Y$ for all $X, Y \in U$. If $X \in U$ we say that X is a *generic* point of Z . Define $\rho_Z := \delta_X$ for some $X \in U$. By [L1, L3],

$$\mathcal{S}^* := \{\rho_Z \mid Z \in \text{Irr}(\Lambda_d), d \in \mathbb{N}^n\}$$

is a basis of \mathcal{M}^* , the dual of Lusztig's semicanonical basis \mathcal{S} of \mathcal{M} . In case X is a rigid Λ -module, the orbit of X in Λ_d is open, its closure is an irreducible component Z , and $\delta_X = \rho_Z$ belongs to \mathcal{S}^* .

3.4. The cluster algebra $\mathcal{A}(\mathcal{C}_M)$ as a subalgebra of $\mathcal{M}^* \equiv U(\mathfrak{n})_{\text{gr}}^*$. For a terminal $\mathbb{C}Q$ -module $M = M_1 \oplus \cdots \oplus M_r$ let $\mathcal{T}(\mathcal{C}_M)$ be the graph with vertices the isomorphism classes of basic \mathcal{C}_M -maximal rigid Λ -modules and with edges given by mutations. Let $T = T_1 \oplus \cdots \oplus T_r$ be a vertex of $\mathcal{T}(\mathcal{C}_M)$, and let $\mathcal{T}(\mathcal{C}_M, T)$ denote the connected component of $\mathcal{T}(\mathcal{C}_M)$ containing T . Denote by $\mathcal{R}(\mathcal{C}_M, T)$ the subalgebra of \mathcal{M}^* generated by the δ_{R_i} ($1 \leq i \leq r$) where $R = R_1 \oplus \cdots \oplus R_r$ runs over all vertices of $\mathcal{T}(\mathcal{C}_M, T)$.

Theorem 3.3. *Let $M = M_1 \oplus \cdots \oplus M_r$ be a terminal $\mathbb{C}Q$ -module. Then the following hold:*

(i) *There is a unique isomorphism $\iota: \mathcal{A}(\mathcal{C}_M, T) \rightarrow \mathcal{R}(\mathcal{C}_M, T)$ such that*

$$\iota(y_i) = \delta_{T_i} \quad (1 \leq i \leq r);$$

(ii) *If we identify the two algebras $\mathcal{A}(\mathcal{C}_M, T)$ and $\mathcal{R}(\mathcal{C}_M, T)$ via ι , then the clusters of $\mathcal{A}(\mathcal{C}_M, T)$ are identified with the r -tuples $\delta(R) = (\delta_{R_1}, \dots, \delta_{R_r})$, where R runs over the vertices of the graph $\mathcal{T}(\mathcal{C}_M, T)$. Moreover, all cluster monomials belong to the dual semicanonical basis \mathcal{S}^* of $\mathcal{M}^* \equiv U(\mathfrak{n})_{\text{gr}}^*$.*

The proof relying on Theorem 3.1 and the multiplication formula of [GLS4] is given in Section 20.1.

We call (\mathcal{C}_M, T) a *categorification* of the cluster algebra $\mathcal{A}(\mathcal{C}_M, T) = \mathcal{A}(B(\Gamma_T)^\circ)$.

Write $\mathcal{R}(\mathcal{C}_M) := \mathcal{R}(\mathcal{C}_M, T_M)$. By Theorem 3.2, we also have $\mathcal{R}(\mathcal{C}_M) = \mathcal{R}(\mathcal{C}_M, T_M^\vee)$. Theorem 3.3 shows that the cluster algebra $\mathcal{A}(\mathcal{C}_M)$ is canonically isomorphic to the subalgebra $\mathcal{R}(\mathcal{C}_M)$ of $U(\mathfrak{n})_{\text{gr}}^*$.

3.5. Which cluster algebras did we categorify? The reader who is not familiar with representation theory of quivers will ask which cluster algebras are now categorified by our approach. We explain this in purely combinatorial terms.

As before, let $Q = (Q_0, Q_1, s, t)$ be a finite quiver without oriented cycles. Here $Q_0 = \{1, \dots, n\}$ denotes the set of vertices and Q_1 the set of arrows of Q . An arrow $a \in Q_1$ starts in a vertex $s(a)$ and terminates in a vertex $t(a)$. Let Q^{op} be the *opposite quiver* of Q . This is obtained from Q by just reversing the direction of all arrows.

Assume that Q is not a Dynkin quiver. Then the preinjective component \mathcal{I}_Q of the Auslander-Reiten quiver of KQ can be identified with the translation quiver $\mathbb{N}Q^{\text{op}}$ which is defined as follows. The vertices of $\mathbb{N}Q^{\text{op}}$ are (i, z) with $1 \leq i \leq n$ and $z \in \mathbb{N} = \{0, 1, 2, 3, \dots\}$. For each arrow $a^*: j \rightarrow i$ in Q^{op} there are arrows $(a^*, z): (j, z) \rightarrow (i, z)$ and $(a, z): (i, z+1) \rightarrow (j, z)$ for all $z \in \mathbb{N}$. Let $\tau(i, z) := (i, z+1)$ be the *translation* in $\mathbb{N}Q^{\text{op}}$. The vertices $(1, 0), \dots, (n, 0)$ are the *injective vertices* of $\mathbb{N}Q^{\text{op}}$.

Now take any finite successor closed full subquiver Γ of $\mathbb{N}Q^{\text{op}}$ such that Γ contains all n injective vertices. Define a new quiver Γ^* which is obtained from Γ by adding an arrow from (i, z) to $(i, z+1)$ whenever these vertices are both in Γ . Then Theorem 3.3 provides a categorification of the cluster algebra $\mathcal{A}(B(\Gamma^*)^\circ)$.

For example, if Γ is the full subquiver of $\mathbb{N}Q^{\text{op}}$ with vertices

$$\{(1, 1), (1, 0), (2, 1), (2, 0), \dots, (n, 1), (n, 0)\},$$

then $\mathcal{A}(B(\Gamma^*)^\circ)$ is the acyclic cluster algebra associated to the quiver Q . But note that this cluster algebra comes along with n coefficients labelled by the vertices $(1, 0), \dots, (n, 0)$.

If Q is a Dynkin quiver, then one obtains categorifications of cluster algebras $\mathcal{A}(B(\Gamma^*)^\circ)$ in a similar way. The only difference is that now we have to work with successor closed full subquivers Γ of the *finite* Auslander-Reiten quiver of KQ . We will not repeat here how to construct this quiver in this case, but see e.g. [GLS2].

Let us discuss another example. If Q is the quiver

$$1 \rightrightarrows 2 \longrightarrow 3$$

then the quiver $\mathbb{N}Q^{\text{op}}$ looks as indicated in the following picture:

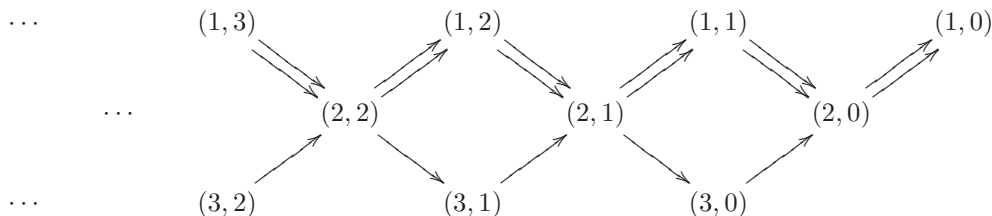

Now let Γ be the full subquiver with vertices

$$\{(1, 2), (1, 1), (1, 0), (2, 1), (2, 0), (3, 1), (3, 0)\}.$$

Clearly, Γ is successor closed. Then Γ^* looks as follows:

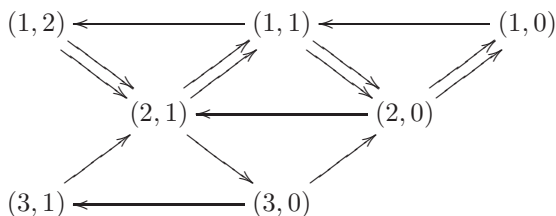

3.6. Dual PBW-bases and dual semicanonical bases. In the spirit of Ringel’s construction of PBW-bases for quantum groups [Ri6], we construct dual PBW-bases for our cluster algebras $\mathcal{A}(\mathcal{C}_M)$. This yields the following result, which we prove in Section 20.

Theorem 3.4. *Let $M = M_1 \oplus \dots \oplus M_r$ be a terminal $\mathbb{C}Q$ -module.*

- (i) *The cluster algebra $\mathcal{R}(\mathcal{C}_M)$ is a polynomial ring in r variables. More precisely, we have*

$$\mathcal{R}(\mathcal{C}_M) = \mathbb{C}[\delta_{M_1}, \dots, \delta_{M_r}] = \text{Span}_{\mathbb{C}}\langle \delta_X \mid X \in \mathcal{C}_M \rangle,$$

where we interpret M_i as a Λ -module using the obvious embedding functor;

- (ii) *The set $\mathcal{P}_M^* := \{\delta_{M'} \mid M' \in \text{add}(M)\}$ is a \mathbb{C} -basis of $\mathcal{R}(\mathcal{C}_M)$;*
- (iii) *The subset of the dual semicanonical basis $\mathcal{S}_M^* := \mathcal{S}^* \cap \mathcal{R}(\mathcal{C}_M)$ is a \mathbb{C} -basis of $\mathcal{R}(\mathcal{C}_M)$ containing all cluster monomials.*

Let $\tilde{\mathcal{R}}(\mathcal{C}_M)$ be the algebra obtained from $\mathcal{R}(\mathcal{C}_M)$ by formally inverting the elements δ_P for all \mathcal{C}_M -projectives P . In other words, $\tilde{\mathcal{R}}(\mathcal{C}_M)$ is the cluster algebra obtained from $\mathcal{R}(\mathcal{C}_M)$ by inverting the generators of its coefficient ring. Similarly, let $\underline{\mathcal{R}}(\mathcal{C}_M)$ be the cluster algebra obtained from $\mathcal{R}(\mathcal{C}_M)$ by specializing the elements δ_P to 1. For both cluster algebras $\tilde{\mathcal{R}}(\mathcal{C}_M)$ and $\underline{\mathcal{R}}(\mathcal{C}_M)$ we get a \mathbb{C} -basis which is easily obtained from the dual semicanonical basis \mathcal{S}_M^* and again contains all cluster monomials, see Sections 20.5 and 20.6.

3.7. Adaptable elements of W . Let W be the Weyl group of \mathfrak{g} , with Coxeter generators s_1, \dots, s_n . We say that $w \in W$ is *Q -adaptable* if there exists a reduced decomposition $w = s_{i_t} \cdots s_{i_2} s_{i_1}$ such that i_1 is a sink of Q , and i_{k+1} is a sink of $\sigma_{i_k} \cdots \sigma_{i_2} \sigma_{i_1}(Q)$ for every $1 \leq k \leq t-1$. Here σ_i is the operation on quivers which changes the orientation of all the arrows incident to the vertex i . In this case (i_t, \dots, i_1) is called a *Q -adapted reduced expression* of w . We say that w is *adaptable* if it is Q -adaptable for some (acyclic) orientation Q of the Dynkin diagram of \mathfrak{g} .

For example if W is finite, the longest element w_0 of W is always adaptable. If Q has only two vertices, for instance if Q is a (generalized) Kronecker quiver, then every w in W is adaptable. On the other hand, if Q is a Dynkin quiver of type \mathbb{D}_4 with central node labelled 3, then $w = s_3 s_1 s_2 s_3$ is not adaptable.

It is easy to associate to a terminal $\mathbb{C}Q$ -module M a Q^{op} -adaptable element w . Indeed, let $\Delta_M^+ := \{\underline{\dim}(M_1), \dots, \underline{\dim}(M_r)\}$ be the set of dimension vectors of the indecomposable direct summands of M . It is well known that Δ_M^+ is a subset of the set Δ^+ of positive real roots of \mathfrak{g} . In fact $\Delta_M^+ = \{\alpha \in \Delta^+ \mid w(\alpha) < 0\}$ for a unique $w = w(M) \in W$, and $w(M)$ is Q^{op} -adaptable, see Lemma 19.3. Conversely any Q^{op} -adaptable w (not contained in a proper parabolic subgroup of W) comes from a unique terminal $\mathbb{C}Q$ -module M . Moreover, if Q' is a quiver obtained from Q by changing the orientation and if w is also Q'^{op} -adaptable, then $\mathcal{C}_M = \mathcal{C}_{M'}$ where M' is the terminal $\mathbb{C}Q'$ -module attached to w (see Section 22.7). This implies that \mathcal{C}_M depends only on the adaptable element w of W , and we sometimes write $\mathcal{C}_M = \mathcal{C}_w$.

3.8. Unipotent subgroups and cells. Let M be a terminal $\mathbb{C}Q$ -module, and let $w = w(M)$ be the associated Weyl group element. Let

$$\mathfrak{n}_M = \mathfrak{n}(w) = \bigoplus_{\alpha \in \Delta_M^+} \mathfrak{n}_\alpha$$

be the corresponding sum of root subspaces of \mathfrak{n} . This is a finite-dimensional nilpotent Lie algebra. Let $N_M = N(w)$ be the corresponding finite-dimensional unipotent group.

If G is the Kac-Moody group attached to \mathfrak{g} as in [Ku, Chapter 6], which comes with a pair of subgroups N and N_- (denoted by \mathcal{U} and \mathcal{U}_- in [Ku]), then

$$N(w) = N \cap (w^{-1}N_-w).$$

We also define the unipotent cell

$$N^w = N \cap (B_- w B_-)$$

where B_- is the standard negative Borel subgroup of G .

The following theorem, proved in Section 22, is one of our main results. It shows that \mathcal{C}_M can be regarded as a categorification of both $N(w)$ and N^w .

Theorem 3.5. *The algebras of regular functions on $N(w)$ and N^w have a cluster algebra structure. More precisely, we have natural isomorphisms*

$$\begin{aligned} \mathbb{C}[N(w)] &\cong \mathcal{R}(\mathcal{C}_M), \\ \mathbb{C}[N^w] &\cong \tilde{\mathcal{R}}(\mathcal{C}_M). \end{aligned}$$

Note that in the Dynkin case the cluster algebra structure on $\mathbb{C}[N^w]$ was already known by work of Berenstein, Fomin and Zelevinsky [BFZ], but our proof is different and yields the additional result that the upper cluster algebra is in fact a cluster algebra.

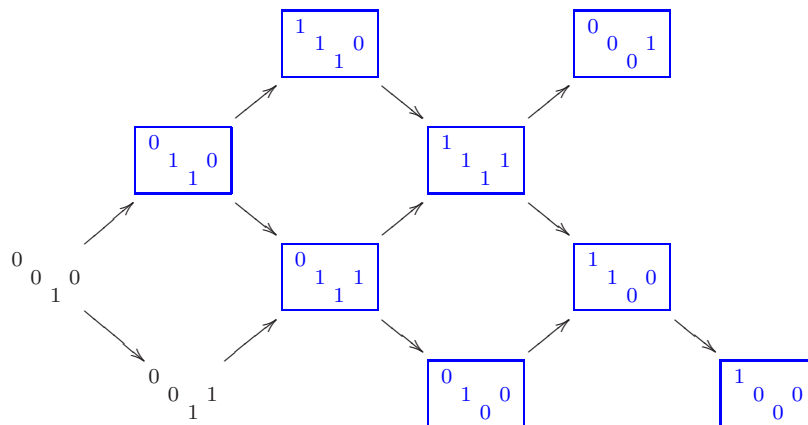

FIGURE 3. The Auslander-Reiten quiver of a path algebra of type \mathbb{A}_4

3.9. An example. We are going to illustrate some of the previous results on an example. Let Q be the quiver

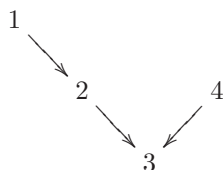

Figure 3 shows the Auslander-Reiten quiver of $\mathbb{C}Q$. The indecomposable direct summands of a terminal $\mathbb{C}Q$ -module M are marked in blue colour. In Figure 4 we show the Auslander-Reiten quiver of the preprojective algebra Λ of type \mathbb{A}_4 . As in Section 2.4, we display the graded dimension vectors of the indecomposable Λ -modules. One has to identify the objects on the two dotted vertical lines. The indecomposable \mathcal{C}_M -projective-injective modules are marked in red colour, all other indecomposable modules in \mathcal{C}_M are marked in blue. Observe that \mathcal{C}_M contains 18 indecomposable modules, and 4 of these are \mathcal{C}_M -projective-injective. The stable category $\underline{\mathcal{C}}_M$ is triangle equivalent to the cluster category \mathcal{C}_Q .

The maximal rigid module T_M has 8 indecomposable direct summands, namely, the 4 indecomposable \mathcal{C}_M -projective-injective modules

$$I_4 = \begin{pmatrix} 1 & 0 & 0 \\ 0 & 1 & 1 \\ 0 & 0 & 1 \end{pmatrix} \quad I_3 = \begin{pmatrix} 1 & 1 & 0 \\ 0 & 1 & 1 \\ 0 & 0 & 1 \end{pmatrix} \quad I_2 = \begin{pmatrix} 1 & 1 & 1 \\ 1 & 1 & 0 \\ 0 & 0 & 0 \end{pmatrix} \quad I_1 = \begin{pmatrix} 0 & 0 & 0 \\ 1 & 1 & 0 \\ 0 & 0 & 0 \end{pmatrix}$$

and the modules

$$T_1 = \begin{pmatrix} 1 & 0 & 0 \\ 0 & 1 & 0 \\ 0 & 0 & 0 \end{pmatrix} \quad T_2 = \begin{pmatrix} 0 & 0 & 0 \\ 0 & 1 & 0 \\ 0 & 0 & 0 \end{pmatrix} \quad T_3 = \begin{pmatrix} 0 & 0 & 1 \\ 0 & 1 & 1 \\ 0 & 0 & 0 \end{pmatrix} \quad T_4 = \begin{pmatrix} 0 & 0 & 0 \\ 0 & 1 & 0 \\ 0 & 0 & 0 \end{pmatrix}.$$

Similarly, T_M^\vee has 4 non-projective indecomposable direct summands, namely,

$$T_1^\vee = \begin{pmatrix} 0 & 0 & 1 \\ 0 & 0 & 0 \\ 0 & 0 & 0 \end{pmatrix} \quad T_2^\vee = \begin{pmatrix} 1 & 0 & 0 \\ 0 & 1 & 1 \\ 0 & 0 & 0 \end{pmatrix} \quad T_3^\vee = \begin{pmatrix} 1 & 0 & 0 \\ 0 & 1 & 0 \\ 0 & 0 & 0 \end{pmatrix} \quad T_4^\vee = \begin{pmatrix} 1 & 0 & 0 \\ 0 & 0 & 0 \\ 0 & 0 & 0 \end{pmatrix}.$$

Here, the group N can be taken to be the group of upper unitriangular 5×5 matrices with complex coefficients. Given two subsets I and J of $\{1, 2, \dots, 5\}$ with $|I| = |J|$, we denote by $D_{IJ} \in \mathbb{C}[N]$ the regular function mapping an element $x \in N$ to its minor $D_{IJ}(x)$ with row subset I and column subset J . Every Λ -module X in \mathcal{C}_M gives rise to a linear form

$\delta_X \in U(\mathfrak{n})_{\text{gr}}^*$ and by means of the isomorphism $U(\mathfrak{n})_{\text{gr}}^* \cong \mathbb{C}[N]$ to a regular function φ_X . For example,

$$\begin{aligned} \varphi_{I_4} &= D_{1234,2345}, & \varphi_{I_3} &= D_{123,345}, & \varphi_{I_2} &= D_{12,35}, & \varphi_{I_1} &= D_{1,3}, \\ \varphi_{T_1} &= D_{123,234}, & \varphi_{T_2} &= D_{123,134}, & \varphi_{T_3} &= D_{123,135}, & \varphi_{T_4} &= D_{12,13}, \\ \varphi_{T_1^\vee} &= D_{1234,1235}, & \varphi_{T_2^\vee} &= D_{123,235}, & \varphi_{T_3^\vee} &= D_{12,23}, & \varphi_{T_4^\vee} &= D_{1,2}. \end{aligned}$$

The Weyl group element attached to \mathcal{C}_M is $w = s_3s_4s_2s_1s_3s_4s_2s_1$. The corresponding unipotent subgroup $N(w)$ consists of all 5×5 matrices of the form

$$\begin{bmatrix} 1 & u_1 & u_2 & u_7 & u_4 \\ 0 & 1 & u_5 & u_8 & u_6 \\ 0 & 0 & 1 & 0 & 0 \\ 0 & 0 & 0 & 1 & u_3 \\ 0 & 0 & 0 & 0 & 1 \end{bmatrix}, \quad (u_1, \dots, u_8 \in \mathbb{C}).$$

The unipotent cell N^w is a locally closed subset of N defined by the following equations and inequalities:

$$\begin{aligned} N^w &= \{x \in N \mid D_{1,4}(x) = D_{1,5}(x) = D_{12,45}(x) = 0, \\ &\quad D_{1234,2345}(x) \neq 0, D_{123,345}(x) \neq 0, D_{12,35}(x) \neq 0, D_{1,3}(x) \neq 0\} \end{aligned}$$

Note that the 4 inequalities are given by the non-vanishing of the 4 regular functions φ_{I_k} ($k = 1, \dots, 4$) attached to the indecomposable \mathcal{C}_M -projective-injective modules.

Our results show that the polynomial algebra $\mathbb{C}[N(w)]$ has a cluster algebra structure, of which $(\varphi_{T_1}, \varphi_{T_2}, \varphi_{T_3}, \varphi_{T_4}, \varphi_{I_1}, \varphi_{I_2}, \varphi_{I_3}, \varphi_{I_4})$ and $(\varphi_{T_1^\vee}, \varphi_{T_2^\vee}, \varphi_{T_3^\vee}, \varphi_{T_4^\vee}, \varphi_{I_1}, \varphi_{I_2}, \varphi_{I_3}, \varphi_{I_4})$ are two distinguished clusters. Its coefficient ring is the polynomial ring in the four variables $(\varphi_{I_1}, \varphi_{I_2}, \varphi_{I_3}, \varphi_{I_4})$. The cluster mutations of this algebra come from mutations of maximal rigid modules in \mathcal{C}_M . Moreover, if we replace the coefficient ring by the ring of Laurent polynomials in the four variables $(\varphi_{I_1}, \varphi_{I_2}, \varphi_{I_3}, \varphi_{I_4})$, we obtain the coordinate ring $\mathbb{C}[N^w]$.

Part 2. The category \mathcal{C}_M

4. REPRESENTATIONS OF QUIVERS AND PREPROJECTIVE ALGEBRAS

4.1. Nilpotent varieties. A Λ -module M is called *nilpotent* if a composition series of M contains only the simple modules S_1, \dots, S_n associated to the vertices of Q . Let $\text{nil}(\Lambda)$ be the abelian category of finite-dimensional nilpotent Λ -modules.

Let $d = (d_1, \dots, d_n) \in \mathbb{N}^n$. By

$$\text{rep}(Q, d) = \prod_{a \in Q_1} \text{Hom}_K(K^{d_{s(a)}}, K^{d_{t(a)}})$$

we denote the affine space of representations of Q with dimension vector d . Furthermore, let $\text{mod}(\Lambda, d)$ be the affine variety of elements

$$(f_a, f_{a^*})_{a \in Q_1} \in \prod_{a \in Q_1} \left(\text{Hom}_K(K^{d_{s(a)}}, K^{d_{t(a)}}) \times \text{Hom}_K(K^{d_{t(a)}}, K^{d_{s(a)}}) \right)$$

such that the following holds:

(i) For all $i \in Q_0$ we have

$$\sum_{a \in Q_1: s(a)=i} f_{a^*} f_a = \sum_{a \in Q_1: t(a)=i} f_a f_{a^*}.$$

By $\Lambda_d = \text{nil}(\Lambda, d)$ we denote the variety of all $(f_a, f_{a^*})_{a \in Q_1} \in \text{mod}(\Lambda, d)$ such that the following condition holds:

(ii) There exists some N such that for each path $a_1 a_2 \cdots a_N$ of length N in the double quiver \overline{Q} of Q we have $f_{a_1} f_{a_2} \cdots f_{a_N} = 0$.

If Q is a Dynkin quiver, then (ii) follows already from condition (i). One can regard (ii) as a nilpotency condition, which explains why the varieties Λ_d are often called *nilpotent varieties*. Note that $\text{rep}(Q, d)$ can be considered as a subvariety of Λ_d . In fact $\text{rep}(Q, d)$ forms an irreducible component of Λ_d . Lusztig [L1, Section 12] proved that all irreducible components of Λ_d have the same dimension, namely

$$\dim \text{rep}(Q, d) = \sum_{a \in Q_1} d_{s(a)} d_{t(a)}.$$

One can interpret Λ_d as the variety of nilpotent Λ -modules with dimension vector d . The group

$$\text{GL}_d = \prod_{i=1}^n \text{GL}(d_i, K)$$

acts on $\text{mod}(\Lambda, d)$, Λ_d and $\text{rep}(Q, d)$ by conjugation. Namely, for $g = (g_1, \dots, g_n) \in \text{GL}_d$ and $x = (f_a, f_{a^*})_{a \in Q_1} \in \text{mod}(\Lambda, d)$ define

$$g \cdot x := (g_{t(a)} f_a g_{s(a)}^{-1}, g_{s(a)} f_{a^*} g_{t(a)}^{-1})_{a \in Q_1}.$$

The action on Λ_d and $\text{rep}(Q, d)$ is obtained via restriction. The isomorphism classes of Λ -modules in $\text{mod}(\Lambda, d)$ and Λ_d , and KQ -modules in $\text{rep}(Q, d)$, respectively, correspond to the orbits of these actions. For a module M with dimension vector d over Λ or over KQ let \mathcal{O}_M be its GL_d -orbit in $\text{mod}(\Lambda, d)$, Λ_d or $\text{rep}(Q, d)$, respectively.

4.2. Dimension formulas for nilpotent varieties. The restriction functor

$$\pi_Q: \text{mod}(\Lambda) \rightarrow \text{mod}(KQ)$$

induces a surjective morphism of varieties $\pi_{Q,d}: \text{mod}(\Lambda, d) \rightarrow \text{rep}(Q, d)$. There is a bilinear form $\langle -, - \rangle: \mathbb{Z}^n \times \mathbb{Z}^n \rightarrow \mathbb{Z}$ associated to Q defined by

$$\langle d, e \rangle = \sum_{i \in Q_0} d_i e_i - \sum_{a \in Q_1} d_{s(a)} e_{t(a)}.$$

The dimension vector of a KQ -module M is denoted by $\underline{\dim}(M)$. For KQ -modules M and N set

$$\langle M, N \rangle := \dim \text{Hom}_{KQ}(M, N) - \dim \text{Ext}_{KQ}^1(M, N).$$

It is known that $\langle M, N \rangle = \langle \underline{\dim}(M), \underline{\dim}(N) \rangle$. Let $(-, -): \mathbb{Z}^n \times \mathbb{Z}^n \rightarrow \mathbb{Z}$ be the symmetrization of the bilinear form $\langle -, - \rangle$, i.e. $(d, e) := \langle d, e \rangle + \langle e, d \rangle$. Thus for Λ -modules X and Y we have

$$(\underline{\dim}(X), \underline{\dim}(Y)) = \langle \pi_Q(X), \pi_Q(Y) \rangle + \langle \pi_Q(Y), \pi_Q(X) \rangle.$$

Lemma 4.1 ([CB1, Lemma 1]). *For any Λ -modules X and Y we have*

$$\dim \text{Ext}_{\Lambda}^1(X, Y) = \dim \text{Hom}_{\Lambda}(X, Y) + \dim \text{Hom}_{\Lambda}(Y, X) - (\underline{\dim}(X), \underline{\dim}(Y)).$$

Corollary 4.2. *$\dim \text{Ext}_{\Lambda}^1(X, X)$ is even, and $\dim \text{Ext}_{\Lambda}^1(X, Y) = \dim \text{Ext}_{\Lambda}^1(Y, X)$.*

For a GL_d -orbit \mathcal{O} in Λ_d let $\text{codim } \mathcal{O} = \dim \Lambda_d - \dim \mathcal{O}$ be its codimension.

Lemma 4.3. *For any nilpotent Λ -module M we have $\dim \text{Ext}_{\Lambda}^1(M, M) = 2 \text{codim } \mathcal{O}_M$.*

Proof. Set $d = \underline{\dim}(M)$. By Lemma 4.1 we have

$$\dim \text{Ext}_{\Lambda}^1(M, M) = 2 \dim \text{End}_{\Lambda}(M) - (d, d).$$

Furthermore, $\dim \mathcal{O}_M = \dim \text{GL}_d - \dim \text{End}_{\Lambda}(M)$. Thus

$$\text{codim } \mathcal{O}_M = \dim \Lambda_d - \dim \mathcal{O}_M = \sum_{\alpha \in Q_1} d_{s(\alpha)} d_{t(\alpha)} - \sum_{i=1}^n d_i^2 + \dim \text{End}_{\Lambda}(M).$$

Combining these equations yields the result. \square

Corollary 4.4. *For a nilpotent Λ -module M with dimension vector d the following are equivalent:*

- The closure $\overline{\mathcal{O}_M}$ of \mathcal{O}_M is an irreducible component of Λ_d ;
- The orbit \mathcal{O}_M is open in Λ_d ;
- $\text{Ext}_{\Lambda}^1(M, M) = 0$.

Lemma 4.5 ([CB2, Theorem 3.3]). *For each $N \in \text{rep}(Q, d)$ the fibre $\pi_{Q,d}^{-1}(N)$ is isomorphic to $\text{DExt}_{KQ}^1(N, N)$.*

Corollary 4.6 ([CB2, Lemma 3.4]). *For $N \in \text{rep}(Q, d)$ we have*

$$\begin{aligned} \dim \pi_{Q,d}^{-1}(\mathcal{O}_N) &= \dim \mathcal{O}_N + \dim \text{Ext}_{KQ}^1(N, N) \\ &= \sum_{i \in Q_0} d_i^2 - \dim \text{End}_{KQ}(N) + \dim \text{Ext}_{KQ}^1(N, N) \\ &= \sum_{i \in Q_0} d_i^2 - \langle d, d \rangle = \sum_{a \in Q_1} d_{s(a)} d_{t(a)} = \dim \text{rep}(Q, d). \end{aligned}$$

Furthermore, $\pi_{Q,d}^{-1}(\mathcal{O}_N)$ is locally closed and irreducible in $\text{mod}(\Lambda, d)$.

Corollary 4.7. *Let $N \in \text{rep}(Q, d)$ such that $\pi_{Q,d}^{-1}(N) \subseteq \Lambda_d$. Then*

$$\overline{\pi_{Q,d}^{-1}(\mathcal{O}_N)}$$

is an irreducible component of Λ_d .

4.3. Terminal KQ -modules and irreducible components. Following Ringel [Ri5] we define a K -category $\mathcal{C}(1, \tau)$ as follows: The objects are of the form (X, f) where X is in $\text{mod}(KQ)$ and $f: X \rightarrow \tau(X)$ is a KQ -module homomorphism. Here $\tau = \tau_Q$ denotes the Auslander-Reiten translation in $\text{mod}(KQ)$. The morphisms from (X, f) to (Y, g) are just the KQ -module homomorphisms $h: X \rightarrow Y$ such that the diagram

$$\begin{array}{ccc} X & \xrightarrow{h} & Y \\ \downarrow f & & \downarrow g \\ \tau(X) & \xrightarrow{\tau(h)} & \tau(Y) \end{array}$$

commutes. Then the categories $\text{mod}(\Lambda)$ and $\mathcal{C}(1, \tau)$ are isomorphic [Ri5, Theorem B]. More precisely, there exists an isomorphism of categories

$$\Psi: \text{mod}(\Lambda) \rightarrow \mathcal{C}(1, \tau)$$

such that $\Psi(X) = (Y, f)$ implies $\pi_Q(X) = Y$ for all $X \in \text{mod}(\Lambda)$.

Lemma 4.8. *Let M be a terminal KQ -module. Assume $N \in \text{add}(M)$. Then*

$$\overline{\pi_{Q,d}^{-1}(\mathcal{O}_N)}$$

is an irreducible component of Λ_d . In particular, $\mathcal{C}_M \subseteq \text{nil}(\Lambda)$.

Proof. Since M is a terminal KQ -module and $N \in \text{add}(M)$, we know that $\pi_{Q,d}^{-1}(N)$ is contained in Λ_d . Indeed, by [Ri5] for every KQ -module X the intersection

$$\pi_{Q,d}^{-1}(X) \cap \Lambda_d$$

can be identified with the space of KQ -module homomorphisms $f: X \rightarrow \tau(X)$ such that the composition

$$X \xrightarrow{f} \tau(X) \xrightarrow{\tau(f)} \tau^2(X) \xrightarrow{\tau^2(f)} \dots \xrightarrow{\tau^{m-1}(f)} \tau^m(X)$$

is zero for some $m \geq 1$. Since N is preinjective, such an m always exists, namely we have $\text{Hom}_{KQ}(N, \tau^m(N)) = 0$ for m large enough. Then use Corollary 4.7. \square

5. SELF-INJECTIVE TORSION CLASSES IN $\text{nil}(\Lambda)$

5.1. Tilting modules and torsion classes. We need to recall some facts on torsion theories and tilting modules. Let A be a K -algebra, and let \mathcal{U} be a subcategory of $\text{mod}(A)$.

A module C in \mathcal{U} is a *generator* (resp. *cogenerator*) of \mathcal{U} if for each $X \in \mathcal{U}$ there exists some $t \geq 1$ and an epimorphism $C^t \rightarrow X$ (resp. a monomorphism $X \rightarrow C^t$).

Let

$$\begin{aligned} \mathcal{U}^\perp &= \{X \in \text{mod}(A) \mid \text{Hom}_A(U, X) = 0 \text{ for all } U \in \mathcal{U}\}, \\ {}^\perp\mathcal{U} &= \{X \in \text{mod}(A) \mid \text{Hom}_A(X, U) = 0 \text{ for all } U \in \mathcal{U}\}. \end{aligned}$$

The following lemma is well known:

Lemma 5.1 ([Bo2, Section 1.1]). *For a subcategory \mathcal{T} of $\text{mod}(A)$ the following are equivalent:*

- (i) $\mathcal{T} = {}^\perp(\mathcal{T}^\perp)$;
- (ii) \mathcal{T} is closed under extensions and factor modules.

A pair $(\mathcal{F}, \mathcal{T})$ of subcategories of $\text{mod}(A)$ is called a *torsion theory* in $\text{mod}(A)$ if $\mathcal{T}^\perp = \mathcal{F}$ and $\mathcal{T} = {}^\perp\mathcal{F}$. The modules in \mathcal{F} are called *torsion-free modules* and the ones in \mathcal{T} are called *torsion modules*. A subcategory \mathcal{T} of $\text{mod}(A)$ is a *torsion class* if it satisfies one of the equivalent conditions in Lemma 5.1.

An A -module T is a *tilting module* if there exists some $d \geq 1$ such that the following three conditions hold:

- (1) $\text{proj. dim}(T) \leq d$;
- (2) $\text{Ext}_A^i(T, T) = 0$ for all $i \geq 1$;
- (3) There exists a short exact sequence $0 \rightarrow {}_A A \rightarrow T_0 \rightarrow T_1 \rightarrow \cdots \rightarrow T_d \rightarrow 0$ with $T_i \in \text{add}(T)$ for all $i \geq 0$.

Such a module T is a *classical tilting module* if we can take $d = 1$. Note that over path algebras KQ every tilting module is a classical tilting module.

Any classical tilting module T over an algebra A yields a torsion theory $(\mathcal{F}, \mathcal{T})$ where

$$\begin{aligned} \mathcal{F} &= \{N \in \text{mod}(A) \mid \text{Hom}_A(T, N) = 0\}, \\ \mathcal{T} &= \{N \in \text{mod}(A) \mid \text{Ext}_A^1(T, N) = 0\}. \end{aligned}$$

It is a well known result from tilting theory that $\mathcal{T} = \text{Fac}(T)$. As a reference for tilting theory we recommend [ASS, Bo1, HR, Ri1].

Let A and B be finite-dimensional K -algebras. The algebras A and B are *derived equivalent* if their derived categories $D^b(\text{mod}(A))$ and $D^b(\text{mod}(B))$ are equivalent as triangulated categories, see for example [H1, Section 0]. We need the following results:

Theorem 5.2 ([H1, Section 1.7]). *If T is a tilting module over A , then A and $\text{End}_A(T)^{\text{op}}$ are derived equivalent.*

Theorem 5.3 ([H1, Section 1.4]). *If A and B are derived equivalent, then $\text{gl. dim}(A) < \infty$ if and only if $\text{gl. dim}(B) < \infty$.*

5.2. Approximations of modules. Let A be a K -algebra, and let M be an A -module. A homomorphism $f: X \rightarrow M'$ in $\text{mod}(A)$ is a *left $\text{add}(M)$ -approximation* of X if $M' \in \text{add}(M)$ and the induced map

$$\text{Hom}_A(f, M): \text{Hom}_A(M', M) \rightarrow \text{Hom}_A(X, M)$$

is surjective. A morphism $f: V \rightarrow W$ is called *left minimal* if every morphism $g: W \rightarrow W$ with $gf = f$ is an isomorphism. Dually, one defines right $\text{add}(M)$ -approximations and right minimal morphisms. Some well known basic properties of approximations can be found in [GLS5, Section 3.1].

5.3. Frobenius subcategories. Let \mathcal{C} be a subcategory of $\text{mod}(\Lambda)$ which is closed under extensions. A Λ -module C in \mathcal{C} is called *\mathcal{C} -projective* (resp. *\mathcal{C} -injective*) if $\text{Ext}_\Lambda^1(C, X) = 0$ (resp. $\text{Ext}_\Lambda^1(X, C) = 0$) for all $X \in \mathcal{C}$. If C is \mathcal{C} -projective and \mathcal{C} -injective, then C is also called *\mathcal{C} -projective-injective*.

We say that \mathcal{C} has *enough projectives* (resp. *enough injectives*) if for each $X \in \mathcal{C}$ there exists a short exact sequence $0 \rightarrow Y \rightarrow C \rightarrow X \rightarrow 0$ (resp. $0 \rightarrow X \rightarrow C \rightarrow Y \rightarrow 0$) where C is \mathcal{C} -projective (resp. \mathcal{C} -injective) and $Y \in \mathcal{C}$.

Lemma 5.4. *For a Λ -module C in \mathcal{C} the following are equivalent:*

- C is \mathcal{C} -projective;
- C is \mathcal{C} -injective.

Proof. This follows immediately from Corollary 4.2. □

If \mathcal{C} has enough projectives and enough injectives, then \mathcal{C} is called a *Frobenius subcategory* of $\text{mod}(\Lambda)$. In particular, \mathcal{C} is a Frobenius category in the sense of Happel [H2].

5.4. Cluster torsion classes. Let \mathcal{C} be a subcategory of $\text{nil}(\Lambda)$. We call \mathcal{C} a *selfinjective torsion class* if the following hold:

- (i) \mathcal{C} is closed under extensions;
- (ii) \mathcal{C} is closed under factor modules;
- (iii) There exists a generator-cogenerator $I_{\mathcal{C}}$ of \mathcal{C} which is \mathcal{C} -projective-injective;
- (iv) $\text{rk}(\mathcal{C}) < \infty$.

It follows from the definitions and Lemma 5.1 that for a selfinjective torsion class \mathcal{C} of $\text{nil}(\Lambda)$ we have ${}^{\perp}(\mathcal{C}^{\perp}) = \mathcal{C}$. In particular, $(\mathcal{C}^{\perp}, \mathcal{C})$ is a torsion theory in $\text{mod}(\Lambda)$.

We will show that each selfinjective torsion class \mathcal{C} of $\text{nil}(\Lambda)$ can be interpreted as a categorification of a certain cluster algebra, provided the following holds:

- (\star) There exists a \mathcal{C} -complete rigid module $T_{\mathcal{C}}$ such that the quiver $\Gamma_{T_{\mathcal{C}}}$ of $\text{End}_{\Lambda}(T_{\mathcal{C}})$ has no loops.

A selfinjective torsion class satisfying (\star) will be called a *cluster torsion class*.

We will prove in Proposition 8.11 that for every terminal KQ -module M , the subcategory \mathcal{C}_M is a cluster torsion class. For simplicity, in the introduction, Theorems 3.1 and 3.3 were only stated for subcategories of the form \mathcal{C}_M . But the proofs (Sections 14 and 20.1) are carried out more generally for cluster torsion classes.

5.5. \mathcal{C}_M is a torsion class. Let $M = M_1 \oplus \cdots \oplus M_r$ be a terminal KQ -module as defined in Section 2.2. Set

$$T := \bigoplus_{i=1}^n \tau^{t_i(M)}(I_i).$$

Note that the KQ -module T is a basic tilting module with $\text{Fac}(T) = \text{add}(M)$. We can identify \mathcal{C}_M with the category of pairs (X, f) with $X \in \text{add}(M)$ and $f: X \rightarrow \tau(X)$ a KQ -module homomorphism. Clearly, \mathcal{C}_M is an additive subcategory.

Lemma 5.5. *\mathcal{C}_M is closed under extensions.*

Proof. Let $0 \rightarrow (X, f) \rightarrow (Y, g) \rightarrow (Z, h) \rightarrow 0$ be a short exact sequence of Λ -modules with $(X, f), (Z, h) \in \mathcal{C}_M$. Applying the functor π_Q we get a short exact sequence

$$0 \rightarrow X \rightarrow Y \rightarrow Z \rightarrow 0$$

in $\text{mod}(KQ)$ with $X, Z \in \text{add}(M)$. For each indecomposable direct summand Y_i of Y there exists a non-zero map $X \rightarrow Y_i$, which implies that $Y_i \in \text{add}(M)$, or Y_i is a non-zero direct summand of Z , which also implies $Y_i \in \text{add}(M)$. Thus $(Y, g) \in \mathcal{C}_M$. □

Lemma 5.6. \mathcal{C}_M is closed under factor modules.

Proof. Let (Y, g) be a factor module of some $(X, f) \in \mathcal{C}_M$. Then for every indecomposable direct summand Y_i of Y there exists a non-zero map $X \rightarrow Y_i$, which implies $Y_i \in \text{add}(M)$. It follows that $(Y, g) \in \mathcal{C}_M$. \square

Corollary 5.7. For a terminal KQ -module M the following hold:

- (i) $\mathcal{C}_M = {}^\perp(\mathcal{C}_M^\perp)$;
- (ii) For each $(X, f) \in \mathcal{C}_M$ there exists a short exact sequence

$$0 \rightarrow (X_1, f_1) \rightarrow (X, f) \rightarrow (X_2, f_2) \rightarrow 0$$

with $(X_1, f_1) \in \mathcal{C}_M$ and $(X_2, f_2) \in \mathcal{C}_M^\perp$;

- (iii) $\mathcal{C}_M^\perp = \{(Y, g) \in \text{mod}(\Lambda) \mid Y \cap \text{add}(M) = 0\}$.

Proof. Part (i) follows from Lemma 5.1, Lemma 5.5 and Lemma 5.6. To prove (ii), let (X, f) be a Λ -module. We can write

$$X = X_1 \oplus X_2$$

where X_1 is a maximal direct summand of X such that $X_1 \in \text{add}(M)$, and X_2 is some complement. Note that X_1 and X_2 are uniquely determined up to isomorphism. By f_1 we denote the restriction of f to X_1 . Since M is a terminal KQ -module, we get $\text{Hom}_{KQ}(X_1, \tau(X_2)) = 0$. Thus, the image of f_1 is contained in $\tau(X_1)$. So we can regard (X_1, f_1) as a Λ -module. In particular, (X_1, f_1) is a submodule of (X, f) . We get a short exact sequence of the form

$$0 \rightarrow (X_1, f_1) \rightarrow (X, f) \rightarrow (X_2, f_2) \rightarrow 0$$

with $(X_1, f_1) \in \mathcal{C}_M$ and $(X_2, f_2) \in \mathcal{C}_M^\perp$. Also (iii) follows easily from these considerations. \square

6. LIFTING HOMOMORPHISMS FROM $\text{mod}(KQ)$ TO $\text{mod}(\Lambda)$

As before, let I_1, \dots, I_n be the indecomposable injective KQ -modules. For natural numbers $a \leq b$ define

$$I_{i,[a,b]} = \bigoplus_{j=a}^b \tau^j(I_i),$$

and let

$$e_{i,[a,b]} = \begin{pmatrix} 0 & 1 & & \\ & \ddots & \ddots & \\ & & 0 & 1 \end{pmatrix} : I_{i,[a,b]} \rightarrow \tau(I_{i,[a,b]})$$

be the KQ -module homomorphism with $e_{i,[a,b]}(\tau^a(I_i)) = 0$ and whose restriction to $\tau^j(I_i)$ is the identity for $a+1 \leq j \leq b$. The Λ -modules of the form $(I_{i,[a,b]}, e_{i,[a,b]})$ are crucial for our theory.

Let $(X, f) \in \text{mod}(\Lambda)$. Define $\text{Hom}_{KQ}(X, \tau^a(I_i))_b$ as the subspace of $\text{Hom}_{KQ}(X, \tau^a(I_i))$ consisting of all morphisms h such that

$$0 = \tau^{b-a+1}(h) \circ \tau^{b-a}(f) \circ \dots \circ \tau(f) \circ f : X \rightarrow \tau^{b+1}(I_i).$$

Lemma 6.1. For $1 \leq i \leq n$ and $a \leq b$ there is an isomorphism of vector spaces

$$\text{Hom}_{KQ}(X, \tau^a(I_i))_b \rightarrow \text{Hom}_\Lambda((X, f), (I_{i,[a,b]}, e_{i,[a,b]}))$$

$$h_a \mapsto \widetilde{h}_a := \begin{bmatrix} h_a \\ h_{a+1} \\ \vdots \\ h_b \end{bmatrix}$$

where

$$h_{a+j} := \tau^j(h_a) \circ \tau^{j-1}(f) \circ \cdots \circ \tau^2(f) \circ \tau(f) \circ f: X \rightarrow \tau^{a+j}(I_i)$$

for $1 \leq j \leq b - a$.

Proof. Let $h \in \text{Hom}_\Lambda((X, f), (I_{i,[a,b]}, e_{i,[a,b]}))$. Thus

$$h = \begin{bmatrix} h_a \\ h_{a+1} \\ \vdots \\ h_b \end{bmatrix}: X \rightarrow \bigoplus_{j=a}^b \tau^j(I_i)$$

is a KQ -module homomorphism such that the diagram

$$\begin{array}{ccc} X & \xrightarrow{h} & I_{i,[a,b]} \\ \downarrow f & & \downarrow e_{i,[a,b]} \\ \tau(X) & \xrightarrow{\tau(h)} & \tau(I_{i,[a,b]}) \end{array}$$

commutes, in other words

$$\begin{bmatrix} h_{a+1} \\ \vdots \\ h_b \\ 0 \end{bmatrix} = \begin{pmatrix} 0 & 1 & & \\ & \ddots & \ddots & \\ & & 0 & 1 \\ & & & 0 \end{pmatrix} \cdot \begin{bmatrix} h_a \\ h_{a+1} \\ \vdots \\ h_b \end{bmatrix} = \begin{bmatrix} \tau(h_a)f \\ \tau(h_{a+1})f \\ \vdots \\ \tau(h_b)f \end{bmatrix}.$$

Thus $h_a: X \rightarrow \tau^a(I_i)$ determines h_{a+1}, \dots, h_b . So the homomorphisms space

$$\text{Hom}_\Lambda((X, f), (I_{i,[a,b]}, e_{i,[a,b]}))$$

can be identified with the space of all homomorphisms $h_a: X \rightarrow \tau^a(I_i)$ such that

$$0 = \tau(h_b) \circ f = \tau^{b-a+1}(h_a) \circ \tau^{b-a}(f) \circ \cdots \circ \tau(f) \circ f: X \rightarrow \tau^{b+1}(I_i).$$

In this case, set

$$\widetilde{h}_a = \begin{bmatrix} h_a \\ h_{a+1} \\ \vdots \\ h_b \end{bmatrix}: (X, f) \rightarrow (I_{i,[a,b]}, e_{i,[a,b]})$$

where $h_{a+j} = \tau^j(h_a) \circ \tau^{j-1}(f) \circ \cdots \circ \tau^2(f) \circ \tau(f) \circ f$ for $1 \leq j \leq b - a$. \square

In the above lemma we call \widetilde{h}_a the *lift* of $h_a: X \rightarrow \tau^a(I_i)$. The lift of a KQ -module homomorphism

$$h = (h_j)_j: X \rightarrow \bigoplus_{j \in J} Y_j$$

with Y_j indecomposable preinjective for all j is defined by lifting every component h_j of this homomorphism. (Each indecomposable direct summand Y_j is of the form $\tau^a(I_i)$ for some $1 \leq i \leq n$ and $a \geq 0$. Of course, we also have to specify with respect to which $b \geq a$ we want to lift $h_j: X \rightarrow \tau^a(I_i)$.)

Corollary 6.2. *Let $(X, f) \in \mathcal{C}_M$. Then for $1 \leq i \leq n$ and $0 \leq a \leq t_i(M)$ we get isomorphisms of vector spaces*

$$\text{Hom}_{KQ}(X, \tau^a(I_i)) \rightarrow \text{Hom}_\Lambda((X, f), (I_{i,[a,t_i(M)]}, e_{i,[a,t_i(M)]}))$$

$$h_a \mapsto \widetilde{h}_a = \begin{bmatrix} h_a \\ h_{a+1} \\ \vdots \\ h_{t_i(M)} \end{bmatrix}$$

where $h_{a+j} = \tau^j(h_a) \circ \tau^{j-1}(f) \circ \cdots \circ \tau^2(f) \circ \tau(f) \circ f$ for $1 \leq j \leq t_i(M) - a$.

Proof. In Lemma 6.1 take $b = t_i(M)$. We have $X \in \text{add}(M)$, but $\tau^{t_i(M)+1}(I_i)$ is not in $\text{add}(M)$. Thus

$$\text{Hom}_{KQ}(X, \tau^{t_i(M)+1}(I_i)) = 0.$$

So there is no condition on the choice of h_a . \square

Let again $(X, f) \in \text{mod}(\Lambda)$. For $1 \leq i \leq n$ and $a \leq b$, define $\text{Hom}_{KQ}(\tau^b(I_i), X)_a$ as the subspace of $\text{Hom}_{KQ}(\tau^b(I_i), X)$ consisting of all morphisms h such that

$$0 = f \circ \tau^{-1}(f) \circ \tau^{-2}(f) \circ \cdots \circ \tau^{-(b-a)}(f) \circ \tau^{-(b-a)}(h): \tau^a(I_i) \rightarrow \tau(X).$$

Lemma 6.3. *There is an isomorphism of vector spaces*

$$\text{Hom}_{KQ}(\tau^b(I_i), X)_a \rightarrow \text{Hom}_\Lambda((I_{i,[a,b]}, e_{i,[a,b]}), (X, f))$$

$$h_b \mapsto \widetilde{h}_b = (h_a, h_{a+1}, \dots, h_b)$$

where

$$h_{b-j} := \tau^{-1}(f) \circ \tau^{-2}(f) \circ \cdots \circ \tau^{-j}(f) \circ \tau^{-j}(h_b): \tau^{b-j}(I_i) \rightarrow X$$

for $1 \leq j \leq b - a$.

Proof. Let $h \in \text{Hom}_\Lambda((I_{i,[a,b]}, e_{i,[a,b]}), (X, f))$ for some $a \leq b$. Thus

$$h = (h_a, h_{a+1}, \dots, h_b): \bigoplus_{j=a}^b \tau^j(I_i) \rightarrow X$$

is a KQ -module homomorphism such that the diagram

$$\begin{array}{ccc} I_{i,[a,b]} & \xrightarrow{h} & X \\ \downarrow e_{i,[a,b]} & & \downarrow f \\ \tau(I_{i,[a,b]}) & \xrightarrow{\tau(h)} & \tau(X) \end{array}$$

commutes. In other words

$$\begin{aligned} (0, \tau(h_a), \dots, \tau(h_{b-1})) &= (\tau(h_a), \tau(h_{a+1}), \dots, \tau(h_b)) \cdot \begin{pmatrix} 0 & 1 & & \\ & \ddots & \ddots & \\ & & 0 & 1 \\ & & & 0 \end{pmatrix} \\ &= (fh_a, fh_{a+1}, \dots, fh_b). \end{aligned}$$

Thus $h_b: \tau^b(I_i) \rightarrow X$ determines h_a, \dots, h_{b-1} . So the homomorphism space

$$\text{Hom}_\Lambda((X, f), (I_{i,[a,b]}, e_{i,[a,b]}))$$

can be identified with the space of all homomorphisms $h_b: \tau^b(I_i) \rightarrow X$ such that

$$0 = f \circ h_a = f \circ \tau^{-1}(f) \circ \tau^{-2}(f) \circ \cdots \circ \tau^{-(b-a)}(f) \circ \tau^{-(b-a)}(h_b): \tau^a(I_i) \rightarrow \tau(X).$$

In this case, set

$$\widetilde{h}_b = (h_a, h_{a+1}, \dots, h_b): (I_{i,[a,b]}, e_{i,[a,b]}) \rightarrow (X, f)$$

where $h_{b-j} = \tau^{-1}(f) \circ \tau^{-2}(f) \circ \cdots \circ \tau^{-j}(f) \circ \tau^{-j}(h_b)$ for $1 \leq j \leq b - a$. \square

Corollary 6.4. *Let $(X, f) \in \text{mod}(\Lambda)$. Then for $1 \leq i \leq n$ and $b \geq 0$ we get an isomorphism of vector spaces*

$$\text{Hom}_{KQ}(\tau^b(I_i), X) \rightarrow \text{Hom}_{\Lambda}((I_{i,[0,b]}, e_{i,[0,b]}), (X, f))$$

$$h_b \mapsto \tilde{h}_b = (h_0, h_1, \dots, h_b)$$

where $h_{b-j} = \tau^{-1}(f) \circ \tau^{-2}(f) \circ \dots \circ \tau^{-j}(f) \circ \tau^{-j}(h_b)$ for $1 \leq j \leq b$.

Proof. In Lemma 6.3 take $a = 0$. We have identified $\text{Hom}_{\Lambda}((I_{i,[0,b]}, e_{i,[0,b]}), (X, f))$ with the space of all homomorphisms $h_b: \tau^b(I_i) \rightarrow X$ such that

$$0 = fh_0: I_i \rightarrow \tau(X),$$

where h_0 is obtained from h_b as described in Lemma 6.3. But for every $X \in \text{mod}(KQ)$ we have $\text{Hom}_{KQ}(I_i, \tau(X)) = 0$. Thus there is no condition on the choice of h_b . \square

7. CONSTRUCTION OF SOME \mathcal{C}_M -COMPLETE RIGID MODULES

7.1. The modules T_M and T_M^{\vee} . In this section, let $M = M_1 \oplus \dots \oplus M_r$ be a terminal KQ -module, and for $1 \leq i \leq n$ and $a \leq b$ let $(I_{i,[a,b]}, e_{i,[a,b]})$ be the Λ -module defined in Section 6. For brevity, let $t_i := t_i(M)$. Define

$$T_M := \bigoplus_{i=1}^n \bigoplus_{a=0}^{t_i} (I_{i,[a,t_i]}, e_{i,[a,t_i]}) \quad \text{and} \quad T_M^{\vee} := \bigoplus_{i=1}^n \bigoplus_{b=0}^{t_i} (I_{i,[0,b]}, e_{i,[0,b]}).$$

Lemma 7.1. *For $1 \leq i, j \leq n$, $0 \leq a \leq t_i$ and $0 \leq c \leq t_j$ we have*

$$\text{Ext}_{\Lambda}^1((I_{i,[a,t_i]}, e_{i,[a,t_i]}), (I_{j,[c,t_j]}, e_{j,[c,t_j]})) = 0.$$

Proof. By Lemma 4.1 we know that

$$\begin{aligned} |\text{Ext}_{\Lambda}^1((I_{i,[a,t_i]}, e_{i,[a,t_i]}), (I_{j,[c,t_j]}, e_{j,[c,t_j]}))| &= |\text{Hom}_{\Lambda}((I_{i,[a,t_i]}, e_{i,[a,t_i]}), (I_{j,[c,t_j]}, e_{j,[c,t_j]}))| \\ &\quad + |\text{Hom}_{\Lambda}((I_{j,[c,t_j]}, e_{j,[c,t_j]}), (I_{i,[a,t_i]}, e_{i,[a,t_i]}))| \\ &\quad - |\text{Hom}_{KQ}(I_{i,[a,t_i]}, I_{j,[c,t_j]})| \\ &\quad - |\text{Hom}_{KQ}(I_{j,[c,t_j]}, I_{i,[a,t_i]})| \\ &\quad + |\text{Ext}_{KQ}^1(I_{i,[a,t_i]}, I_{j,[c,t_j]})| \\ &\quad + |\text{Ext}_{KQ}^1(I_{j,[c,t_j]}, I_{i,[a,t_i]})|. \end{aligned}$$

From Corollary 6.2 we get

$$\text{Hom}_{\Lambda}((I_{i,[a,t_i]}, e_{i,[a,t_i]}), (I_{j,[c,t_j]}, e_{j,[c,t_j]})) \cong \text{Hom}_{KQ}(I_{i,[a,t_i]}, \tau^c(I_j)).$$

Furthermore, the Auslander-Reiten formula yields

$$\begin{aligned} \text{Ext}_{KQ}^1(I_{j,[c,t_j]}, I_{i,[a,t_i]}) &\cong \text{D Hom}_{KQ}(I_{i,[a,t_i]}, \tau(I_{j,[c,t_j]})) \\ &= \text{D Hom}_{KQ} \left(I_{i,[a,t_i]}, \tau \left(\bigoplus_{l=c}^{t_j} \tau^l(I_j) \right) \right) \\ &= \text{D Hom}_{KQ} \left(I_{i,[a,t_i]}, \bigoplus_{l=c+1}^{t_j+1} \tau^l(I_j) \right). \end{aligned}$$

Note that, since $\tau^{t_j+1}(I_j) \notin \text{add}(M)$, we have $\text{Hom}_{KQ}(I_{i,[a,t_i]}, \tau^{t_j+1}(I_j)) = 0$. This implies

$$|\text{Ext}_{KQ}^1(I_{j,[c,t_j]}, I_{i,[a,t_i]})| = |\text{Hom}_{KQ}(I_{i,[a,t_i]}, I_{j,[c,t_j]})| - |\text{Hom}_{\Lambda}((I_{i,[a,t_i]}, e_{i,[a,t_i]}), (I_{j,[c,t_j]}, e_{j,[c,t_j]}))|.$$

We also have a similar equality where i and j are exchanged, as well as a and c . Summing up these two equalities, we get $\text{Ext}_{\Lambda}^1((I_{i,[a,t_i]}, e_{i,[a,t_i]}), (I_{j,[c,t_j]}, e_{j,[c,t_j]})) = 0$. \square

By Corollary 6.2 there is an isomorphism

$$\Phi_{[a,t_i],[c,t_j]}: \bigoplus_{l=a}^{t_i} \text{Hom}_{KQ}(\tau^l(I_i), \tau^c(I_j)) \rightarrow \text{Hom}_{\Lambda}((I_{i,[a,t_i]}, e_{i,[a,t_i]}), (I_{j,[c,t_j]}, e_{j,[c,t_j]}))$$

defined by

$$h_{l,c} := (0, \dots, 0, h_c, 0, \dots, 0) \mapsto \widetilde{h}_{l,c} = \begin{bmatrix} h_{l,c} \\ h_{l,c+1} \\ \vdots \\ h_{l,t_j} \end{bmatrix}$$

where

$$h_c \in \text{Hom}_{KQ}(\tau^l(I_i), \tau^c(I_j))$$

and

$$h_{l,c+k} := \tau^k(h_{l,c}) \circ \tau^{k-1}(e_{i,[a,t_i]}) \circ \dots \circ \tau(e_{i,[a,t_i]}) \circ e_{i,[a,t_i]} : I_{i,[a,t_i]} \rightarrow \bigoplus_{u=c}^{t_j} \tau^u(I_j)$$

for $1 \leq k \leq t_j - c$. An easy calculation shows that

$$\widetilde{h}_{l,c} = \begin{pmatrix} h_c & & & \\ & \tau(h_c) & & \\ & & \ddots & \\ & & & \tau^m(h_c) \end{pmatrix} : (I_{i,[a,t_i]}, e_{i,[a,t_i]}) \rightarrow (I_{j,[c,t_j]}, e_{j,[c,t_j]})$$

where $m = \max\{t_i - l, t_j - c\}$. Here, the entries of the $(t_j - c + 1) \times (t_i - a + 1)$ -matrix $\widetilde{h}_{l,c}$ are homomorphisms between the indecomposable direct summands of the KQ -modules $I_{i,[a,t_i]}$ and $I_{j,[c,t_j]}$. The only non-zero entries are the maps $\tau^k(h_c)$, $0 \leq k \leq m$. (To be more precise, these are non-zero if and only if $h_c \neq 0$.)

Lemma 7.2. *For $1 \leq i \leq n$ and $a \leq b$ the endomorphism ring*

$$\text{End}_{\Lambda}((I_{i,[a,b]}, e_{i,[a,b]}))$$

is local.

Proof. In the above situation, assume $a = c$, $i = j$ and $t_i = t_j$. Let $a \leq l \leq t_i$. If $a < l$, then it follows easily that $\widetilde{h}_{l,c}$ is nilpotent for all $h_c \in \text{Hom}_{KQ}(\tau^l(I_i), \tau^c(I_j))$. It is also clear that these homomorphisms form an ideal I in $\text{End}_{\Lambda}((I_{i,[a,b]}, e_{i,[a,b]}))$. (If we write $\widetilde{h}_{l,c}$ again as a $(t_j - c + 1) \times (t_i - a + 1)$ -matrix, then this matrix is upper triangular with zero entries on the diagonal. If $a = l$, then we obtain a diagonal matrix.) Every ideal consisting

only of nilpotent elements is contained in the radical of $\text{End}_\Lambda((I_{i,[a,b]}, e_{i,[a,b]}))$. Now the factor algebra $\text{End}_\Lambda((I_{i,[a,b]}, e_{i,[a,b]}))/I$ is 1-dimensional with basis the residue class of

$$\begin{pmatrix} 1_{\tau^a(I_i)} & & & \\ & \tau(1_{\tau^a(I_i)}) & & \\ & & \ddots & \\ & & & \tau^{t_i-a}(1_{\tau^a(I_i)}) \end{pmatrix}.$$

Here we use that $\text{Hom}_{KQ}(X, X) \cong K$ for all indecomposable preinjective KQ -modules X . This finishes the proof. \square

Corollary 7.3. *For $1 \leq i \leq n$ and $a \leq b$, the Λ -module $(I_{i,[a,b]}, e_{i,[a,b]})$ is indecomposable.*

Corollary 7.4. *T_M and T_M^\vee are basic \mathcal{C}_M -complete rigid Λ -modules.*

Proof. Clearly, the modules T_M and T_M^\vee are contained in \mathcal{C}_M . By Lemma 7.1 we know that T_M is rigid. Similarly one shows that T_M^\vee is rigid. Each Λ -module of the form $(I_{i,[a,b]}, e_{i,[a,b]})$ is indecomposable, and we have $(I_{i,[a,b]}, e_{i,[a,b]}) \cong (I_{j,[c,d]}, e_{j,[c,d]})$ if and only if $i = j$ and $[a, b] = [c, d]$. Thus we get

$$\Sigma(T_M) = \Sigma(T_M^\vee) = r.$$

Imitating the proof of [GS, Theorem 1.1] it is easy to show that $\text{rk}(\mathcal{C}_M) \leq r$. Thus we get $\text{rk}(\mathcal{C}_M) = \Sigma(M) = r$. This finishes the proof. \square

Corollary 7.5. $\text{rk}(\mathcal{C}_M) = r$.

For later use, let us introduce the following abbreviations: For $1 \leq i \leq n$ and $0 \leq a \leq b \leq t_i$ set

$$\begin{aligned} T_{i,[a,b]} &:= (I_{i,[a,b]}, e_{i,[a,b]}), \\ T_{i,a} &:= (I_{i,[a,t_i]}, e_{i,[a,t_i]}), \\ T_{i,b}^\vee &:= (I_{i,[0,b]}, e_{i,[0,b]}). \end{aligned}$$

7.2. The quivers of $\text{End}_\Lambda(T_M)$ and $\text{End}_\Lambda(T_M^\vee)$. Let Γ_M^* be defined as in Section 2.6. As before, let Γ_{T_M} be the quiver of $\text{End}_\Lambda(T_M)$.

Lemma 7.6. *We have $\Gamma_{T_M} = \Gamma_M^*$, where for $1 \leq i \leq n$ and $0 \leq a \leq t_i$ the vertex $\tau^a(I_i)$ of Γ_M^* corresponds to the vertex $(I_{i,[a,t_i]}, e_{i,[a,t_i]})$ of Γ_{T_M} .*

Proof. Let $(I_{i,[a,t_i]}, e_{i,[a,t_i]})$ and $(I_{j,[c,t_j]}, e_{j,[c,t_j]})$ be indecomposable direct summands of T_M .

We want to construct a well behaved basis $B_{(i,a),(j,c)}$ of

$$\text{Hom}_\Lambda((I_{i,[a,t_i]}, e_{i,[a,t_i]}), (I_{j,[c,t_j]}, e_{j,[c,t_j]})).$$

We write $B_{(i,a),(j,c)}$ as a disjoint union

$$B_{(i,a),(j,c)} = \bigcup_{l=a}^{t_i} B_{(i,l),(j,c)}.$$

where $B_{(i,l),(j,c)}$ are the images (under the map $\Phi_{[a,t_i],[c,t_j]}$) of residue classes of paths (in the path category of \mathcal{I}_Q) from $\tau^l(I_i)$ to $\tau^c(I_j)$.

Here we use that the mesh category of \mathcal{I}_Q is obtained from the path category by factoring out the mesh relations, and that the full subcategory of indecomposable preinjective KQ -modules is equivalent to the mesh category of \mathcal{I}_Q . For details on mesh categories we refer to [GR, Chapter 10] and [Ri2, Lecture 1].

Now it is easy to check that the homomorphisms $\widetilde{h}_{l,c}$ we constructed above are irreducible in $\text{add}(T_M)$ if and only if $h_c \in \text{Hom}_{KQ}(\tau^l(I_i), \tau^c(I_j))$ is irreducible in \mathcal{I}_Q , or $l = a + 1$, $i = j$, $c = a + 1$ and $\widetilde{h}_{l,c}$ is a non-zero multiple of

$$\begin{pmatrix} 0 & 1_{\tau^{a+1}(I_i)} & & & \\ 0 & & \tau(1_{\tau^{a+1}(I_i)}) & & \\ \vdots & & & \ddots & \\ 0 & & & & \tau^m(1_{\tau^{a+1}(I_i)}) \end{pmatrix} : (I_{i,[a,t_i]}, e_{i,[a,t_i]}) \rightarrow (I_{i,[a+1,t_i]}, e_{i,[a+1,t_i]})$$

where $m = t_i - a - 1$. In other words, $h_c \in \text{Hom}_{KQ}(\tau^{a+1}(I_i), \tau^{a+1}(I_i))$ is a non-zero multiple of $1_{\tau^{a+1}(I_i)}$. This implies $\Gamma_{T_M} = \Gamma_M^*$. \square

The following Lemma is proved similarly as Lemma 7.6.

Lemma 7.7. *We have $\Gamma_{T_M^\vee} = \Gamma_M^*$, where for $1 \leq i \leq n$ and $0 \leq b \leq t_i$ the vertex $\tau^b(I_i)$ of Γ_M^* corresponds to the vertex $(I_{i,[0,b]}, e_{i,[0,b]})$ of $\Gamma_{T_M^\vee}$.*

Note that the \mathcal{C}_M -projective direct summands of T_M correspond to the rightmost vertices of Γ_M^* , whereas the \mathcal{C}_M -projective summands of T_M^\vee correspond to the leftmost vertices of Γ_M^* .

One could also use covering methods to prove Lemma 7.6 and Lemma 7.7, compare [GLS2]. But note that in [GLS2] we only deal with Q being a Dynkin quiver and for M we take the direct sum of all indecomposable KQ -modules. In this case, we have $T_M = P_{Q^{\text{op}}}$ and $T_M^\vee = I_{Q^{\text{op}}}$, where P_Q and I_Q are defined in [GLS2, Sections 1.7 and 1.2].

7.3. Dimension vectors of some $\text{End}_\Lambda(T_M)$ -modules. As before, let $M = M_1 \oplus \cdots \oplus M_r$ be a terminal KQ -module, and set $B := \text{End}_\Lambda(T_M)$. For a Λ -module $(X, f) \in \mathcal{C}_M$ we want to compute the dimension vector of the B -module $\text{Hom}_\Lambda((X, f), T_M)$. Since the indecomposable projective B -modules are just the modules $\text{Hom}_\Lambda(T_{i,a}, T_M)$, $1 \leq i \leq n$, $0 \leq a \leq t_i$, we know that the entries of the dimension vector $\underline{\dim}(\text{Hom}_\Lambda((X, f), T_M))$ are

$$\dim \text{Hom}_B(\text{Hom}_\Lambda(T_{i,a}, T_M), \text{Hom}_\Lambda((X, f), T_M))$$

where $1 \leq i \leq n$, $0 \leq a \leq t_i$. We have

$$\begin{aligned} \text{Hom}_B(\text{Hom}_\Lambda(T_{i,a}, T_M), \text{Hom}_\Lambda((X, f), T_M)) &\cong \text{Hom}_\Lambda((X, f), T_{i,a}) \\ &\cong \text{Hom}_{KQ}(X, \tau^a(I_i)). \end{aligned}$$

The first isomorphism follows from Corollary 9.5 and Lemma 9.11. For the second isomorphism we use Corollary 6.2.

In other words, the entries of $\underline{\dim}(\text{Hom}_\Lambda((X, f), T_M))$ are $\dim \text{Hom}_{KQ}(X, M_s)$ where $1 \leq s \leq r$. We can easily calculate $\dim \text{Hom}_{KQ}(X, M_s)$ using the mesh category of \mathcal{I}_Q , see [GR, Chapter 10], [Ri2, Lecture 1].

7.4. An example of type \mathbb{A}_3 . Let Q be the quiver

$$1 \longleftarrow 2 \longrightarrow 3$$

and let M be the direct sum of all six indecomposable KQ -modules. Thus $\Gamma_M = \Gamma_Q$ looks as follows:

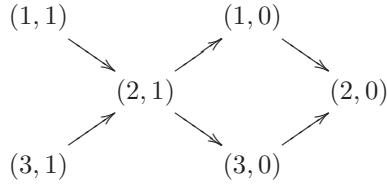

The following picture shows the quiver of $\text{End}_\Lambda(T_M)$ where the vertices corresponding to the $T_{i,a}$ are labelled by the dimension vectors $\underline{\dim}(\text{Hom}_\Lambda(T_{i,a}, T_M))$.

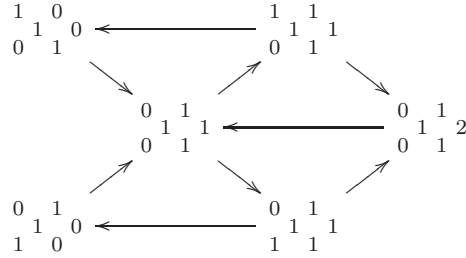

Similarly, the quiver of $\text{End}_\Lambda(T_M^\vee)$ looks as follows:

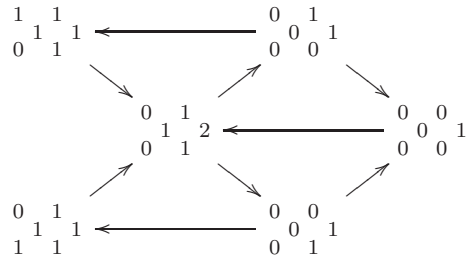

The vertices corresponding to the $T_{i,b}^\vee$ are labelled by the vectors $\underline{\dim}(\text{Hom}_\Lambda(T_{i,b}^\vee, T_M))$.

7.5. An example of type \tilde{A}_2 . Let Q be the quiver

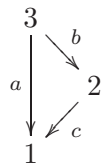

and let M be the terminal KQ -module with $t_i(M) = 1$ for all i . Then the quiver of $\text{End}_\Lambda(T_M)$ looks as follows:

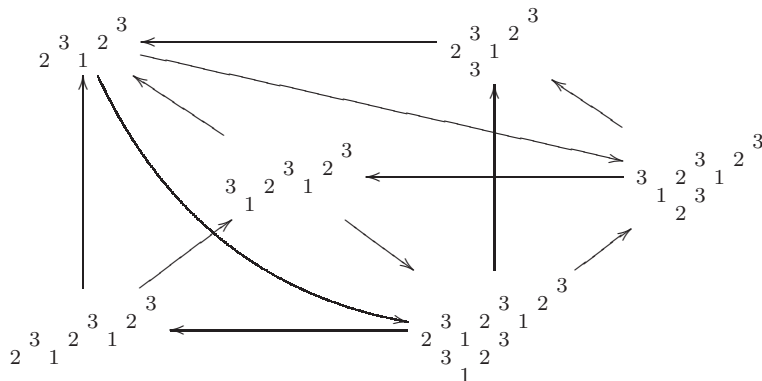

As vertices we display the indecomposable direct summands of the Λ -module T_M . The numbers can be interpreted as basis vectors or as composition factors. For example,

$$X := \begin{matrix} & & 3 & 2 & 3 \\ & & 1 & 2 & 1 \\ & & & 2 & & 3 \end{matrix}$$

stands for a 9-dimensional Λ -module with dimension vector $(2, 3, 4)$. More precisely, one could display the module X as follows:

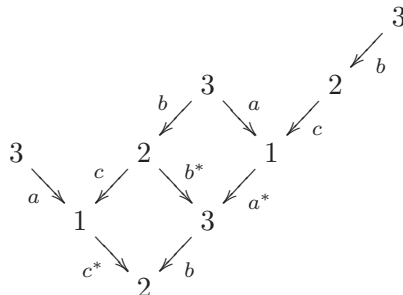

This picture shows how the different arrows of the quiver \overline{Q} of Λ act on the 9 basis vectors of the module. For example, one can see immediately that the socle of X is isomorphic to S_2 , and the top is isomorphic to $S_3 \oplus S_3 \oplus S_3$. One can also clearly see how the 2-dimensional indecomposable injective KQ -module I_2 is “glued from below” to the indecomposable KQ -module $\tau(I_2)$ using the arrows a^*, b^*, c^* . This gives a short exact sequence

$$0 \rightarrow (I_2, 0) \rightarrow X \rightarrow (\tau(I_2), 0) \rightarrow 0$$

of Λ -modules.

Using the same notation, the quiver of $\text{End}_\Lambda(T_M^\vee)$ looks as follows:

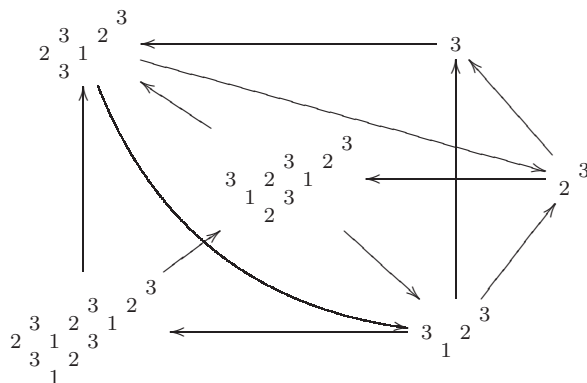

8. \mathcal{C}_M IS A CLUSTER TORSION CLASS AND IS STABLY 2-CALABI-YAU

8.1. \mathcal{C}_M is a cluster torsion class. As before, let $M = M_1 \oplus \cdots \oplus M_r$ be a terminal KQ -module. Set

$$I_M = \bigoplus_{i=1}^n (I_{i, [0, t_i(M)]}, e_{i, [0, t_i(M)]}).$$

The following two lemmas are a direct consequence of Lemma 6.1 and Corollary 6.2.

Lemma 8.1. *For all $1 \leq i \leq n$ and $b \geq 0$, the Λ -module $(I_{i,[0,b]}, e_{i,[0,b]})$ has a simple socle which is isomorphic to $(S_i, 0)$.*

Lemma 8.2. *For $X \in \mathcal{C}_M$ we have $\dim \operatorname{Hom}_\Lambda(X, I_M) = \dim X$.*

Lemma 8.3. *Let $(X, f) \in \mathcal{C}_M$. Then there exists a short exact sequence*

$$0 \rightarrow (X, f) \rightarrow (I, e) \rightarrow (Y, g) \rightarrow 0$$

of Λ -modules with $(I, e) \in \operatorname{add}(I_M)$ and $(Y, g) \in \mathcal{C}_M$.

Proof. Let

$$h: X \rightarrow \bigoplus_{i=1}^n I_i^{m_i}$$

be a monomorphism of KQ -modules. Such a monomorphism exists, since I_1, \dots, I_n are the indecomposable injective KQ -modules. It follows from Corollary 6.2 that the lift

$$\tilde{h}: (X, f) \rightarrow (I, e) := \bigoplus_{i=1}^n (I_{i,[0,t_i(M)]}, e_{i,[0,t_i(M)]})^{m_i}$$

of h is a monomorphism of Λ -modules. We denote its cokernel by (Y, g) . Since \mathcal{C}_M is closed under factor modules, (Y, g) is contained in \mathcal{C}_M . \square

Corollary 8.4. *I_M is a cogenerator of \mathcal{C}_M .*

Lemma 8.5. *I_M is \mathcal{C}_M -injective.*

Proof. It is enough to show that for $1 \leq i \leq n$ the module $(I_{i,[0,t_i(M)]}, e_{i,[0,t_i(M)]})$ is \mathcal{C}_M -injective. Suppose $h': (X, f) \rightarrow (Y, g)$ is a monomorphism in \mathcal{C}_M , and let

$$h: (X, f) \rightarrow (I_{i,[0,t_i(M)]}, e_{i,[0,t_i(M)]})$$

be an arbitrary homomorphism. By Corollary 6.2 we know that

$$h = \tilde{h}_0 = \begin{bmatrix} h_0 \\ h_1 \\ \vdots \\ h_{t_i(M)} \end{bmatrix}$$

for some KQ -module homomorphism $h_0: X \rightarrow I_i$. Since I_i is injective (as a KQ -module), and since $h': X \rightarrow Y$ is a monomorphism, there exists some KQ -module homomorphism $h''_0: Y \rightarrow I_i$ such that $h''_0 \circ h' = h_0$.

$$\begin{array}{ccc} X & \xrightarrow{h'} & Y \\ h_0 \downarrow & \swarrow h''_0 & \\ I_i & & \end{array}$$

We want to show that there exists a homomorphism $h'': (Y, g) \rightarrow (I_{i,[0,t_i(M)]}, e_{i,[0,t_i(M)]})$ such that the diagram

$$\begin{array}{ccc} (X, f) & \xrightarrow{h'} & (Y, g) \\ \downarrow h & \swarrow h'' & \\ (I_{i,[0,t_i(M)]}, e_{i,[0,t_i(M)]}) & & \end{array}$$

commutes.

Recall that a homomorphism $(X, f) \rightarrow (I_{i,[0,t_i(M)]}, e_{i,[0,t_i(M)]})$ is already determined by its component $X \rightarrow I_i$.

Let

$$h'' := \widetilde{h''_0} = \begin{bmatrix} h''_0 \\ h''_1 \\ \vdots \\ h''_{t_i(M)} \end{bmatrix}$$

be the lift of h''_0 . It follows that the component $X \rightarrow I_i$ of the homomorphisms $h'' \circ h'$ and h is equal, namely $h''_0 \circ h' = h_0$, thus $h'' \circ h' = h$.

For brevity, let $I := (I_{i,[0,t_i(M)]}, e_{i,[0,t_i(M)]})$. Assume $Z \in \mathcal{C}_M$. We have to show that $\text{Ext}_\Lambda^1(Z, I) = 0$. Let

$$0 \rightarrow I \xrightarrow{f} E \rightarrow Z \rightarrow 0$$

be a short exact sequence of Λ -modules. By the above considerations, we know that $\text{Hom}_\Lambda(f, I)$ is surjective. In particular, there exists a homomorphism $f': E \rightarrow I$ such that $f'f = \text{id}_I$. Thus f is a split monomorphism and the above sequence splits. This finishes the proof. \square

Lemma 8.6. *If C is a cogenerator of \mathcal{C}_M , then $\text{add}(C)$ contains all modules which are \mathcal{C}_M -injective.*

Proof. Let I be \mathcal{C}_M -injective. Then there exists a short exact sequence

$$0 \rightarrow I \xrightarrow{f} C' \rightarrow \text{Coker}(f) \rightarrow 0$$

of Λ -modules with $C' \in \text{add}(C)$. We know that $\text{Coker}(f) \in \mathcal{C}_M$, because \mathcal{C}_M is closed under factor modules. Since I is \mathcal{C}_M -injective, the above sequence splits. Therefore, $I \in \text{add}(C') \subseteq \text{add}(C)$. \square

Summarizing, we obtain the following:

Proposition 8.7. *If M is a terminal KQ -module, then*

$$\text{add}(I_M) = \{\mathcal{C}_M\text{-projectives}\} = \{\mathcal{C}_M\text{-injectives}\}.$$

Now, let

$$T := \bigoplus_{i=1}^n \tau^{t_i(M)}(I_i).$$

Recall that T is a tilting module over KQ , and that

$$\text{add}(M) = \text{Fac}(T) = \{N \in \text{mod}(KQ) \mid \text{Ext}_{KQ}^1(T, N) = 0\}.$$

Lemma 8.8. *Let X be a KQ -module in $\text{add}(M)$. Then there exists a short exact sequence*

$$0 \rightarrow T'' \rightarrow T' \xrightarrow{h} X \rightarrow 0$$

of KQ -modules with $T', T'' \in \text{add}(T)$ and h a right $\text{add}(T)$ -approximation.

Proof. We deduce the result from the proof of [Bo1, Prop. 1.4 (b)]. Let $h: T' \rightarrow X$ be a right $\text{add}(T)$ -approximation of X . Since $X \in \text{add}(M) = \text{Fac}(T)$, we know that h is an epimorphism. Let $T'' = \text{Ker}(h)$. We obtain a short exact sequence

$$0 \rightarrow T'' \rightarrow T' \xrightarrow{h} X \rightarrow 0.$$

Applying $\text{Hom}_{KQ}(T, -)$ to this sequence yields an exact sequence

$$\text{Hom}_{KQ}(T, T') \xrightarrow{\text{Hom}_{KQ}(T, h)} \text{Hom}_{KQ}(T, X) \rightarrow \text{Ext}_{KQ}^1(T, T'') \rightarrow \text{Ext}_{KQ}^1(T, T') = 0.$$

Since h is a right $\text{add}(T)$ -approximation, $\text{Hom}_{KQ}(T, h)$ is surjective. It follows that $\text{Ext}_{KQ}^1(T, T'') = 0$. Thus $T'' \in \text{add}(M)$. Every indecomposable direct summand of T'' maps non-trivially to a module in $\text{add}(T)$. But the only modules in $\text{add}(M)$ with this property lie in $\text{add}(T)$. Thus $T'' \in \text{add}(T)$. This finishes the proof. \square

Lemma 8.9. *Let $(X, f) \in \mathcal{C}_M$. Then there exists a short exact sequence*

$$0 \rightarrow (Y, g) \rightarrow (I, e) \rightarrow (X, f) \rightarrow 0$$

of Λ -modules with $(I, e) \in \text{add}(I_M)$ and $(Y, g) \in \mathcal{C}_M$.

Proof. Let

$$0 \rightarrow T'' \rightarrow T' \xrightarrow{h} X \rightarrow 0$$

be the short exact sequence appearing in Lemma 8.8. It follows that

$$T' = \bigoplus_{i=1}^n (\tau^{t_i(M)}(I_i))^{m_i}$$

for some $m_i \geq 0$. Set

$$(I, e) = \bigoplus_{i=1}^n (I_{i, [0, t_i(M)]}, e_{i, [0, t_i(M)]})^{m_i}.$$

Note that $(I, e) \in \text{add}(I_M)$. By Corollary 6.4 we can lift h to a Λ -module homomorphism

$$\tilde{h}: (I, e) \rightarrow (X, f).$$

We denote the kernel of \tilde{h} by (Y, g) . Thus we obtain a short exact sequence of KQ -modules

$$0 \rightarrow Y \rightarrow I \xrightarrow{\tilde{h}} X \rightarrow 0.$$

Since h occurs as a component of the homomorphism \tilde{h} and since h is a right $\text{add}(T)$ -approximation of X , we know that the map

$$\text{Hom}_{KQ}(T, \tilde{h}): \text{Hom}_{KQ}(T, I) \rightarrow \text{Hom}_{KQ}(T, X)$$

is surjective. The module I lies in $\text{add}(M)$, thus $\text{Ext}_{KQ}^1(T, I) = 0$. So we get

$$\text{Ext}_{KQ}^1(T, Y) = 0.$$

This implies $Y \in \text{add}(M)$, and therefore $(Y, g) \in \mathcal{C}_M$. \square

Corollary 8.10. *I_M is a generator of \mathcal{C}_M .*

Proposition 8.11. *Let M be a terminal KQ -module. Then \mathcal{C}_M is a cluster torsion class of $\text{nil}(\Lambda)$ with $\text{rk}(\mathcal{C}_M) = \Sigma(M)$.*

Proof. Combine Lemma 5.5, Lemma 5.6, Proposition 8.7, Corollary 8.4, Corollary 8.10, Corollary 7.4 and Lemma 7.6. \square

Corollary 8.12. *Let T be a \mathcal{C}_M -maximal rigid Λ -module, and let $X \in \mathcal{C}_M$. Then there exists an exact sequence $T'' \rightarrow T' \rightarrow X \rightarrow 0$ with $T', T'' \in \text{add}(T)$.*

Proof. Every \mathcal{C}_M -maximal rigid Λ -module contains I_M as a direct summand. Then use Lemma 8.9 to get a surjective map $h: T' \rightarrow X$ with $T' \in \text{add}(T)$ and $\text{Ker}(h) \in \mathcal{C}_M$, and a second time to get a surjective map $T'' \rightarrow \text{Ker}(h)$ with $T'' \in \text{add}(T)$. \square

Corollary 8.13. *Let M be a terminal KQ -module. Then \mathcal{C}_M is a Frobenius category.*

Proof. Combine Proposition 8.7, Lemma 8.3 and Lemma 8.9. \square

8.2. **The stable category $\underline{\mathcal{C}}_M$ is 2-Calabi-Yau.** Let $\underline{\mathcal{C}}_M$ be the *stable category* of \mathcal{C}_M .

By definition the objects in $\underline{\mathcal{C}}_M$ are the same as the objects in \mathcal{C}_M , and the morphism spaces are the morphism spaces in \mathcal{C}_M modulo morphisms factoring through \mathcal{C}_M -projective-injective objects. The category $\underline{\mathcal{C}}_M$ is a triangulated category in a natural way [H2]. The shift is given by the relative syzygy functor

$$\Omega_M^{-1} : \underline{\mathcal{C}}_M \rightarrow \underline{\mathcal{C}}_M.$$

We know that \mathcal{C}_M is closed under extensions. This implies

$$\text{Ext}_{\mathcal{C}_M}^1(X, Y) = \text{Ext}_{\Lambda}^1(X, Y)$$

for all objects X and Y in \mathcal{C}_M .

Since \mathcal{C}_M is a Frobenius category, there is a functorial isomorphism

$$(2) \quad \underline{\mathcal{C}}_M(X, \Omega_M^{-1}(Y)) \cong \text{Ext}_{\mathcal{C}_M}^1(X, Y)$$

for all X and Y in \mathcal{C}_M : Every $f \in \mathcal{C}_M(X, \Omega_M^{-1}(Y))$ gives rise to a commutative diagram

$$\eta_f : \begin{array}{ccccccc} 0 & \longrightarrow & Y & \longrightarrow & E & \longrightarrow & X \longrightarrow 0 \\ & & \parallel & & \downarrow & & \downarrow f \\ 0 & \longrightarrow & Y & \longrightarrow & I_Y & \longrightarrow & \Omega_M^{-1}(Y) \longrightarrow 0. \end{array}$$

The lower sequence is obtained from the embedding of Y into its injective hull I_Y in \mathcal{C}_M , and the upper short exact sequence is just the pull-back of f . Then $f \mapsto \eta_f$ yields the isomorphism (2).

Furthermore, using the canonical projective bimodule resolution of Λ , it is not difficult to show that for all Λ -modules X and Y there exists a functorial isomorphism

$$(3) \quad \text{Ext}_{\Lambda}^1(X, Y) \cong \text{D Ext}_{\Lambda}^1(Y, X),$$

see [GLS4, §8].

Let \mathcal{T} be a K -linear Hom-finite triangulated category with shift functor [1]. Then \mathcal{T} is a *2-Calabi-Yau category* if for all $X, Y \in \mathcal{T}$ there is a functorial isomorphism

$$\mathcal{T}(X, Y) \cong \text{DT}(Y, X[2]).$$

If additionally $\mathcal{T} = \underline{\mathcal{C}}$ for some Frobenius category \mathcal{C} , then \mathcal{T} is called *algebraic*.

Proposition 8.14. *$\underline{\mathcal{C}}_M$ is an algebraic 2-Calabi-Yau category.*

Proof. We have

$$\begin{aligned} \underline{\mathcal{C}}_M(X, Y) &\cong \text{Ext}_{\mathcal{C}_M}^1(X, \Omega_M(Y)) \\ &\cong \text{D Ext}_{\mathcal{C}_M}^1(\Omega_M(Y), X) \\ &\cong \text{D Ext}_{\mathcal{C}_M}^1(Y, \Omega_M^{-1}(X)) \\ &\cong \text{D}\underline{\mathcal{C}}_M(Y, \Omega_M^{-2}(X)), \end{aligned}$$

and all these isomorphisms are functorial. □

9. RELATIVE HOMOLOGY AND \mathcal{C} -MAXIMAL RIGID MODULES

In this section, we recall some notions from relative homology theory which, for Artin algebras, was developed by Auslander and Solberg [AS1, AS2].

9.1. Relative homology theory. Let A be a K -algebra, and let $X, Y, Z, T \in \text{mod}(A)$. Set

$$F^T := \text{Hom}_A(-, T): \text{mod}(A) \rightarrow \text{mod}(\text{End}_A(T)).$$

A short exact sequence

$$0 \rightarrow X \rightarrow Y \rightarrow Z \rightarrow 0$$

is F^T -exact if $0 \rightarrow F^T(Z) \rightarrow F^T(Y) \rightarrow F^T(X) \rightarrow 0$ is exact. By $F^T(Z, X)$ we denote the set of equivalence classes of F^T -exact sequences.

Let \mathcal{X}_T be the subcategory of all $X \in \text{mod}(A)$ such that there exists an exact sequence

$$(4) \quad 0 \rightarrow X \rightarrow T_0 \xrightarrow{f_0} T_1 \xrightarrow{f_1} T_2 \xrightarrow{f_2} \dots$$

where $T_i \in \text{add}(T)$ for all i and

$$0 \rightarrow \text{Ker}(f_i) \rightarrow T_i \rightarrow \text{Im}(f_i) \rightarrow 0$$

are F^T -exact for all $i \geq 0$. Sequence (4) is an F^T -injective coresolution of X in the sense of [AS2]. Note that

$$\text{add}(T) \subseteq \mathcal{X}_T.$$

For $X \in \mathcal{X}_T$ and $Z \in \text{mod}(A)$ let $\text{Ext}_{F^T}^i(Z, X)$, $i \geq 0$ be the cohomology groups obtained from the complex

$$(5) \quad 0 \rightarrow T_0 \xrightarrow{f_0} T_1 \xrightarrow{f_1} T_2 \xrightarrow{f_2} \dots$$

by applying the functor $\text{Hom}_A(Z, -)$.

Lemma 9.1 ([AS1]). *For $X \in \mathcal{X}_T$ and $Z \in \text{mod}(A)$ there is a functorial isomorphism*

$$\text{Ext}_{F^T}^1(Z, X) = F^T(Z, X).$$

Proposition 9.2 ([AS2, Prop 3.7]). *For $X \in \mathcal{X}_T$ and $Z \in \text{mod}(A)$ there is a functorial isomorphism*

$$\text{Ext}_{F^T}^i(Z, X) \rightarrow \text{Ext}_{\text{End}_A(T)}^i(\text{Hom}_A(X, T), \text{Hom}_A(Z, T))$$

for all $i \geq 0$.

Corollary 9.3. *For $X \in \mathcal{X}_T$ and $Z \in \text{mod}(A)$ there is a functorial isomorphism*

$$i_{Z, X, T}: \text{Hom}_A(Z, X) \rightarrow \text{Hom}_{\text{End}_A(T)}(\text{Hom}_A(X, T), \text{Hom}_A(Z, T))$$

$$h \mapsto (h' \mapsto h'h).$$

If $X = Z$, we define $i_{X, T} := i_{X, X, T}$.

Corollary 9.4. *For $X \in \mathcal{X}_T$ and $Z \in \text{mod}(A)$ the map*

$$i_{X, T}: \text{End}_A(X) \rightarrow \text{Hom}_{\text{End}_A(T)}(\text{Hom}_A(X, T), \text{Hom}_A(X, T))$$

is an anti-isomorphism of rings. In other words, we get a ring isomorphism

$$\text{End}_A(X) \rightarrow \text{End}_{\text{End}_A(T)}(\text{Hom}_A(X, T))^{\text{op}}.$$

Proof. It follows from the definitions that $i_{X, T}(h_1 \circ h_2) = i_{X, T}(h_2) \circ i_{X, T}(h_1)$. \square

Corollary 9.5. *The functor*

$$\mathrm{Hom}_A(-, T): \mathcal{X}_T \rightarrow \mathrm{mod}(\mathrm{End}_A(T))$$

is fully faithful. In particular, $\mathrm{Hom}_A(-, T)$ has the following properties:

- (i) *If $X \in \mathcal{X}_T$ is indecomposable, then $\mathrm{Hom}_A(X, T)$ is indecomposable;*
- (ii) *If $\mathrm{Hom}_A(X, T) \cong \mathrm{Hom}_A(Y, T)$ for some $X, Y \in \mathcal{X}_T$, then $X \cong Y$.*

Note that Corollary 9.5 follows already from [A, Section 3], see also [APR, Lemma 1.3 (b)].

Corollary 9.6. *Let $T \in \mathrm{mod}(A)$, and let \mathcal{C} be an extension closed subcategory of \mathcal{X}_T . If*

$$\psi: 0 \rightarrow \mathrm{Hom}_A(Z, T) \xrightarrow{\mathrm{Hom}_A(g, T)} \mathrm{Hom}_A(Y, T) \xrightarrow{\mathrm{Hom}_A(f, T)} \mathrm{Hom}_A(X, T) \rightarrow 0$$

is a short exact sequence of $\mathrm{End}_A(T)$ -modules with $X, Y, Z \in \mathcal{C}$, then

$$\eta: 0 \rightarrow X \xrightarrow{f} Y \xrightarrow{g} Z \rightarrow 0$$

is a short exact sequence in $\mathrm{mod}(A)$.

Proof. By Proposition 9.2 there exists an F^T -exact sequence

$$\eta': 0 \rightarrow X \xrightarrow{f'} E \xrightarrow{g'} Z \rightarrow 0$$

with $F^T(\eta') = \psi$. Since \mathcal{C} is closed under extensions, we know that $E \in \mathcal{C}$. Now Corollary 9.5 implies that $E \cong Y$. So there is a short exact sequence

$$\eta'': 0 \rightarrow X \xrightarrow{f''} Y \xrightarrow{g''} Z \rightarrow 0$$

with $F^T(\eta'') = \psi$. Again by Corollary 9.5 we get $f'' = f$ and $g'' = g$. □

9.2. Relative homology for selfinjective torsion classes. The following lemma is stated in [GLS5, Lemma 5.1] for preprojective algebras of Dynkin type. But the same proof works for arbitrary preprojective algebras.

Lemma 9.7. *Let T and X be rigid Λ -modules. If*

$$0 \rightarrow X \xrightarrow{f} T' \rightarrow Y \rightarrow 0$$

is a short exact sequence with f a left $\mathrm{add}(T)$ -approximation, then $T \oplus Y$ is rigid.

Corollary 9.8. *Let T and X be rigid Λ -modules in a selfinjective torsion class \mathcal{C} of $\mathrm{nil}(\Lambda)$. If T is \mathcal{C} -maximal rigid, then there exists a short exact sequence*

$$0 \rightarrow X \rightarrow T' \rightarrow T'' \rightarrow 0$$

with $T', T'' \in \mathrm{add}(T)$.

Proof. In the situation of Lemma 9.7, if T is \mathcal{C} -maximal rigid, we get $Y \in \mathrm{add}(T)$. □

Corollary 9.9. *Let T and X be rigid Λ -modules in a selfinjective torsion class \mathcal{C} of $\mathrm{nil}(\Lambda)$. If T is \mathcal{C} -maximal rigid, then $\mathrm{Hom}_\Lambda(X, T)$ is an $\mathrm{End}_\Lambda(T)$ -module with projective dimension at most one.*

Proof. Applying $\mathrm{Hom}_\Lambda(-, T)$ to the short exact sequence in Corollary 9.8 yields a projective resolution

$$0 \rightarrow \mathrm{Hom}_\Lambda(T'', T) \rightarrow \mathrm{Hom}_\Lambda(T', T) \rightarrow \mathrm{Hom}_\Lambda(X, T) \rightarrow 0$$

of the $\mathrm{End}_\Lambda(T)$ -module $\mathrm{Hom}_\Lambda(X, T)$. □

Lemma 9.10. *Let \mathcal{C} be a selfinjective torsion class of $\text{nil}(\Lambda)$. If T is a \mathcal{C} -maximal 1-orthogonal Λ -module, then for all $X \in \mathcal{C}$ the $\text{End}_\Lambda(T)$ -module $\text{Hom}_\Lambda(X, T)$ has projective dimension at most one.*

Proof. Let $X \in \mathcal{C}$, and let $f: X \rightarrow T'$ be a left $\text{add}(T)$ -approximation of X . Clearly, f is injective, since T is a cogenerator of \mathcal{C} . We obtain a short exact sequence

$$0 \rightarrow X \xrightarrow{f} T' \rightarrow T'' \rightarrow 0$$

where $T'' = \text{Coker}(f)$. Applying $\text{Hom}_\Lambda(-, T)$ yields an exact sequence

$$\eta: 0 \rightarrow \text{Hom}_\Lambda(T'', T) \rightarrow \text{Hom}_\Lambda(T', T) \rightarrow \text{Hom}_\Lambda(X, T) \rightarrow 0$$

of $\text{End}_\Lambda(T)$ -modules. It also follows that $\text{Ext}_\Lambda^1(T'', T) = 0$. Since \mathcal{C} is closed under factor modules, we know that $T'' \in \mathcal{C}$. This implies $T'' \in \text{add}(T)$, because T is \mathcal{C} -maximal 1-orthogonal. Thus η is a projective resolution of $\text{Hom}_\Lambda(X, T)$. \square

Lemma 9.11. *Let \mathcal{C} be a selfinjective torsion class of $\text{nil}(\Lambda)$. If T is a \mathcal{C} -maximal rigid Λ -module, then $\mathcal{C} \subseteq \mathcal{X}_T$.*

Proof. For $X \in \mathcal{C}$, let $f: X \rightarrow T'$ be a left $\text{add}(T)$ -approximation, and let Y be the cokernel of f . Since T is a cogenerator of \mathcal{C} , we know that f is injective. The selfinjective torsion class \mathcal{C} is closed under factor modules, thus $Y \in \mathcal{C}$. This yields the required F^T -injective coresolution of X . \square

10. TILTING AND \mathcal{C} -MAXIMAL RIGID MODULES

In this section, we adapt some results due to Iyama [Iy1, Iy2] to our situation of selfinjective torsion classes.

Theorem 10.1. *Let M be a terminal KQ -module, and let T be a Λ -module in \mathcal{C}_M such that the following hold:*

- (i) T is rigid;
- (ii) T is a \mathcal{C}_M -generator-cogenerator;
- (iii) $\text{gl. dim}(\text{End}_\Lambda(T)) \leq 3$.

Then T is \mathcal{C}_M -maximal 1-orthogonal.

Proof. Let $X \in \mathcal{C}_M$ with $\text{Ext}_\Lambda^1(T, X) = 0$. We have to show that $X \in \text{add}(T)$. By Corollary 8.12, there exists an exact sequence $T'' \rightarrow T' \rightarrow X \rightarrow 0$ with $T', T'' \in \text{add}(T)$. (For an arbitrary selfinjective torsion class of $\text{nil}(\Lambda)$, the existence of such an exact sequence is not known.) Applying $\text{Hom}_\Lambda(-, T)$ yields an exact sequence

$$0 \rightarrow \text{Hom}_\Lambda(X, T) \rightarrow \text{Hom}_\Lambda(T', T) \rightarrow \text{Hom}_\Lambda(T'', T) \rightarrow Z \rightarrow 0$$

of $\text{End}_\Lambda(T)$ -modules. Since $\text{gl. dim}(\text{End}_\Lambda(T)) \leq 3$ we get $\text{proj. dim}(Z) \leq 3$ and therefore $\text{proj. dim}(\text{Hom}_\Lambda(X, T)) \leq 1$. Let

$$0 \rightarrow \text{Hom}_\Lambda(T_2, T) \xrightarrow{G} \text{Hom}_\Lambda(T_1, T) \xrightarrow{F} \text{Hom}_\Lambda(X, T) \rightarrow 0$$

be a projective resolution of $\text{Hom}_\Lambda(X, T)$. Thus $T_1, T_2 \in \text{add}(T)$. Furthermore, we know by Corollary 9.3 that $F = \text{Hom}_\Lambda(f, T)$ and $G = \text{Hom}_\Lambda(g, T)$ for some homomorphisms f and g . By Corollary 9.6,

$$0 \rightarrow X \xrightarrow{f} T_1 \xrightarrow{g} T_2 \rightarrow 0$$

is a short exact sequence. Since we assumed $\text{Ext}_\Lambda^1(T, X) = 0$, we know that this sequence splits. Thus X is isomorphic to a direct summand of T_1 , and therefore $X \in \text{add}(T)$. This finishes the proof. \square

Theorem 10.2. *Let \mathcal{C} be a selfinjective torsion class of $\text{nil}(\Lambda)$. If T_1 and T_2 are \mathcal{C} -maximal rigid modules in \mathcal{C} , then $\text{Hom}_\Lambda(T_2, T_1)$ is a classical tilting module over $\text{End}_\Lambda(T_1)$, and we have*

$$\text{End}_{\text{End}_\Lambda(T_1)}(\text{Hom}_\Lambda(T_2, T_1)) \cong \text{End}_\Lambda(T_2)^{\text{op}}.$$

Proof. Without loss of generality we assume $\Sigma(T_2) \geq \Sigma(T_1)$. Set

$$T := \text{Hom}_\Lambda(T_2, T_1) \quad \text{and} \quad B := \text{End}_\Lambda(T_1).$$

Let $f: T_2 \rightarrow T'_1$ be a left $\text{add}(T_1)$ -approximation of T_2 . Since T_1 is a cogenerator of \mathcal{C} , we know that f is a monomorphism. Since T_2 is rigid we can use Lemma 9.7 and get a short exact sequence

$$(6) \quad 0 \rightarrow T_2 \xrightarrow{f} T'_1 \xrightarrow{g} T''_1 \rightarrow 0$$

with $T'_1, T''_1 \in \text{add}(T_1)$. This yields a projective resolution

$$(7) \quad 0 \rightarrow \text{Hom}_\Lambda(T''_1, T_1) \xrightarrow{\text{Hom}_\Lambda(g, T_1)} \text{Hom}_\Lambda(T'_1, T_1) \xrightarrow{\text{Hom}_\Lambda(f, T_1)} \text{Hom}_\Lambda(T_2, T_1) \rightarrow 0.$$

So the B -module $\text{Hom}_\Lambda(T_2, T_1)$ has projective dimension at most one, which is the first defining property of a classical tilting module.

Next, we show that $\text{Ext}_B^1(T, T) = 0$. Applying $\text{Hom}_B(-, T)$ to Sequence (7) yields an exact sequence

$$(8) \quad 0 \rightarrow \text{End}_B(T) \xrightarrow{F} \text{Hom}_B(\text{Hom}_\Lambda(T'_1, T_1), T) \xrightarrow{G} \text{Hom}_B(\text{Hom}_\Lambda(T''_1, T_1), T) \\ \rightarrow \text{Ext}_B^1(T, T) \rightarrow \text{Ext}_B^1(\text{Hom}_\Lambda(T'_1, T_1), T)$$

where

$$F = \text{Hom}_B(\text{Hom}_\Lambda(f, T_1), T) \quad \text{and} \quad G = \text{Hom}_B(\text{Hom}_\Lambda(g, T_1), T).$$

Lemma 10.3. $\text{Ext}_B^1(\text{Hom}_\Lambda(T'_1, T_1), T) = 0$.

Proof. This is clear, since $\text{Hom}_\Lambda(T'_1, T_1)$ is a projective B -module. \square

Lemma 10.4. *The map G is surjective and $\text{Ext}_B^1(T, T) = 0$.*

Proof. One easily checks that the diagram

$$\begin{array}{ccc} \text{Hom}_\Lambda(T_2, T'_1) & \xrightarrow{\text{Hom}_\Lambda(T_2, g)} & \text{Hom}_\Lambda(T_2, T''_1) \\ \downarrow i_{T_2, T'_1, T_1} & & \downarrow i_{T_2, T''_1, T_1} \\ \text{Hom}_B(\text{Hom}_\Lambda(T'_1, T_1), T) & \xrightarrow{G} & \text{Hom}_B(\text{Hom}_\Lambda(T''_1, T_1), T) \end{array}$$

is commutative. The morphism $\text{Hom}_\Lambda(T_2, g)$ is surjective, since T_2 is rigid. Thus

$$i_{T_2, T''_1, T_1} \circ \text{Hom}_\Lambda(T_2, g) = G \circ i_{T_2, T'_1, T_1}$$

is surjective, since i_{T_2, T''_1, T_1} is an isomorphism. This implies that G is surjective. Now the result follows from Lemma 10.3. \square

The number $\Sigma(T)$ of isomorphism classes of indecomposable direct summands of T is equal to $\Sigma(T_2)$. We proved that T is a partial tilting module over B . This implies $\Sigma(T) \leq \Sigma(T_1)$. By our assumption, $\Sigma(T_2) \geq \Sigma(T_1)$. It follows that $\Sigma(T_1) = \Sigma(T_2)$.

Thus we proved that T is a classical tilting module over B . Now apply $\text{Hom}_\Lambda(T_2, -)$ to Sequence (6). This yields a short exact sequence

$$0 \rightarrow \text{End}_\Lambda(T_2) \xrightarrow{\text{Hom}_\Lambda(T_2, f)} \text{Hom}_\Lambda(T_2, T'_1) \xrightarrow{\text{Hom}_\Lambda(T_2, g)} \text{Hom}_\Lambda(T_2, T''_1) \rightarrow 0.$$

Lemma 10.5. *There exists an anti-isomorphism of ring*

$$\xi: \text{End}_\Lambda(T_2) \rightarrow \text{End}_{\text{End}_\Lambda(T_1)}(T)$$

such that the diagram

$$\begin{array}{ccccccccc} 0 & \longrightarrow & \text{End}_\Lambda(T_2) & \xrightarrow{\text{Hom}_\Lambda(T_2, f)} & \text{Hom}_\Lambda(T_2, T'_1) & \xrightarrow{\text{Hom}_\Lambda(T_2, g)} & \text{Hom}_\Lambda(T_2, T''_1) & \longrightarrow & 0 \\ & & \downarrow \xi & & \downarrow i_{T_2, T'_1, T_1} & & \downarrow i_{T_2, T''_1, T_1} & & \\ 0 & \longrightarrow & \text{End}_B(T) & \xrightarrow{F} & \text{Hom}_B(\text{Hom}_\Lambda(T'_1, T_1), T) & \xrightarrow{G} & \text{Hom}_B(\text{Hom}_\Lambda(T''_1, T_1), T) & \longrightarrow & 0 \end{array}$$

commutes and has exact rows.

Proof. Set $\xi(h)(h'') = h''h$ for all $h \in \text{End}_\Lambda(T_2)$ and $h'' \in \text{Hom}_\Lambda(T_2, T_1)$. Now one easily checks that

$$(F \circ \xi)(h) = (i_{T_2, T'_1, T_1} \circ \text{Hom}_\Lambda(T_2, f))(h): h' \mapsto h'fh.$$

□

Lemma 10.5 implies that $\text{End}_{\text{End}_\Lambda(T_1)}(T) \cong \text{End}_\Lambda(T_2)^{\text{op}}$. This finishes the proof of Theorem 10.2. □

Corollary 10.6. *Let \mathcal{C} be a selfinjective torsion class of $\text{nil}(\Lambda)$. If T_1 and T_2 are \mathcal{C} -maximal rigid Λ -modules, then $\Sigma(T_1) = \Sigma(T_2)$.*

Corollary 10.7. *Let \mathcal{C} be a selfinjective torsion class of $\text{nil}(\Lambda)$. For a Λ -module T the following are equivalent:*

- T is \mathcal{C} -maximal rigid;
- T is \mathcal{C} -complete rigid.

11. A FUNCTOR FROM \mathcal{C}_M TO THE CLUSTER CATEGORY \mathcal{C}_Q

11.1. A triangle equivalence. Assume in this section that M is a terminal KQ -module with $t_i(M) = 1$ for all i . (Note that this assumption excludes the linearly oriented quiver of Dynkin type \mathbb{A}_n .) Thus

$$M = \bigoplus_{i=1}^n (I_i \oplus \tau(I_i))$$

where I_1, \dots, I_n are the indecomposable injective KQ -modules. By \mathcal{C}_Q we denote the cluster category associated to Q . Cluster categories were invented by Buan, Marsh, Reineke, Reiten and Todorov [BMRRT]. Keller [K] proved that they are triangulated categories in a natural way.

Theorem 11.1. *Under the assumptions above, the categories $\underline{\mathcal{C}}_M$ and \mathcal{C}_Q are triangle equivalent.*

Proof. We proved already that $\underline{\mathcal{C}}_M$ is an algebraic 2-Calabi-Yau category. According to an important result by Keller and Reiten [KR], it is enough to construct a \mathcal{C}_M -maximal 1-orthogonal module T in \mathcal{C}_M such that the quiver of the stable endomorphism algebra $\text{End}_{\underline{\mathcal{C}}_M}(T)$ is isomorphic to Q^{op} . Using Lemma 7.6, it is easy to check that the module T_M we constructed in Section 7 has this property. \square

The proof of Keller and Reiten's theorem is quite involved and it does not seem to provide an explicit functor. Here we present an elementary construction of a K -linear functor $G: \mathcal{C}_M \rightarrow \mathcal{C}_Q$ such that the kernel of G consists precisely of the morphisms which factor through \mathcal{C}_M -projective-injective modules. Thus we obtain a K -linear equivalence $\underline{G}: \underline{\mathcal{C}}_M \rightarrow \underline{\mathcal{C}}_Q$. Note however that we do not discuss the possible triangulated structures of $\underline{\mathcal{C}}_M$ and $\underline{\mathcal{C}}_Q$.

11.2. Derived categories of path algebras. Let us review a few facts about the derived category of a path algebra which we will use without further reference. This material can be found in Happel's book [H2]. Write $\mathcal{D} := \mathcal{D}^b(\text{mod}(KQ))$ for the bounded derived category of $\text{mod}(KQ)$. Recall that

$$\mathcal{D} = \bigvee_{i \in \mathbb{Z}} (\text{mod}(KQ))[i]$$

since KQ is hereditary, see also Figure 5. As usual, we identify $\text{mod}(KQ)$ with the full subcategory $\text{mod}(KQ)[0]$ of \mathcal{D} .

If $I \in \text{mod}(KQ)$ is injective, then $\tau_{\mathcal{D}}^{-1}(I) = (\nu^{-1}(I))[1]$ may be considered as a complex of projective KQ -modules which is concentrated in degree -1 . Here $\nu: \text{mod}(KQ) \rightarrow \text{mod}(KQ)$ is the Nakayama functor, see for example [ASS, Ri1]. More generally, if

$$0 \rightarrow L \rightarrow I' \xrightarrow{\iota} I'' \rightarrow 0$$

is an injective resolution of a KQ -module L , then

$$\tau_{\mathcal{D}}^{-1}(L) = (\nu^{-1}(I') \xrightarrow{\nu^{-1}(\iota)} \nu^{-1}(I''))[1]$$

may be viewed as a complex of projectives concentrated in degree -1 and 0 . This is essentially the same as saying that $\tau_{\mathcal{D}}^{-1}$ is the right derived functor

$$\mathbf{R} \text{Hom}_{KQ}(DKQ, -)[1] \cong \mathbf{R} \text{Hom}_{KQ}(DKQ[-1], -).$$

Here, we consider the injective cogenerator $DKQ := \text{Hom}_K(KQ, K)$ of $\text{mod}(KQ)$ as a bimodule.

In particular, if $L \in \text{mod}(KQ)$ has no projective direct summand, then $\tau_{\mathcal{D}}(L) = \tau_Q(L)$. This follows from the usual construction of the Auslander-Reiten translation $\tau = \tau_Q$ in $\text{mod}(KQ)$.

11.3. Cluster categories. Let us review the construction of the cluster category \mathcal{C}_Q as a K -linear category. It is by definition the orbit category of \mathcal{D} by the action of the group $\langle F \rangle$ generated by the self-equivalence $F := \tau_{\mathcal{D}}^{-1} \circ [1]$ of \mathcal{D} . Keller [K] proved that this is in fact a triangulated category.

Now, let \mathcal{F} be the full subcategory of \mathcal{D} which consists of all objects which are isomorphic to a complex $0 \rightarrow I' \rightarrow I'' \rightarrow 0$ of injective KQ -modules concentrated in degree 0 and 1 . So each object C in \mathcal{F} is naturally of the form $C_{\text{inj},1} \oplus C_{\text{mod},0}$ where $C_{\text{mod},0}$ is isomorphic to a KQ -module concentrated in degree 0 , and $C_{\text{inj},1}$ is isomorphic to an injective KQ -module concentrated in degree 1 .

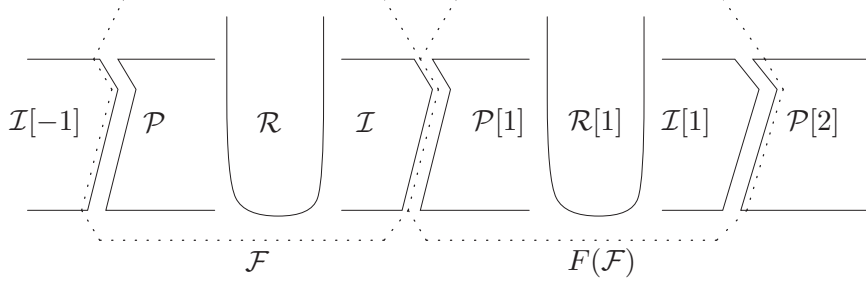
FIGURE 5. $\mathcal{D}^b(\text{mod}(KQ))$ and \mathcal{F}

Thus the indecomposable objects in \mathcal{F} are just the indecomposable KQ -modules L and the shifts $I_i[-1]$ of the indecomposable injective KQ -modules I_1, \dots, I_n . (Recall that we identify $\text{mod}(KQ)$ and $\text{mod}(KQ)[0]$.)

Note that $F(\mathcal{F})$ consists of those objects in \mathcal{D} which are isomorphic to a complex $0 \rightarrow P' \rightarrow P'' \rightarrow 0$ of projective KQ -modules concentrated in degree -2 and -1 . In fact, $F(I' \rightarrow I'') = (\nu^{-1}(I') \rightarrow \nu^{-1}(I''))[2]$ which is a complex of projectives concentrated in degree -2 and -1 , where ν is again the Nakayama functor of $\text{mod}(KQ)$.

We conclude that we may consider \mathcal{F} as a fundamental domain of the action of the group $\langle F \rangle$ on \mathcal{D} . Thus we can identify the objects of \mathcal{C}_Q and \mathcal{F} . Note that with this identification we have

$$\mathcal{C}_Q(X, Y) = \mathcal{D}(X, Y) \oplus \mathcal{D}(X, F(Y))$$

for $X, Y \in \mathcal{F}$. The composition is given by

$$(\phi_0, \phi_1) \circ (\psi_0, \psi_1) = (\phi_0\psi_0, (F\phi_0)\psi_1 + \phi_1\psi_0)$$

Recall that for $M, N \in \text{mod}(KQ)$ we have $\text{Hom}_{\mathcal{D}}(M, N[i]) = 0$ unless $i \in \{0, 1\}$, see also Figure 5.

11.4. Description of \mathcal{C}_M . Recall that the objects in \mathcal{C}_M are of the form $X = (I'' \oplus \tau(I'), f)$, where I' and I'' are injective KQ -modules and

$$f \in \text{Hom}_{KQ}(I'' \oplus \tau(I'), \tau(I'') \oplus \tau^2(I')).$$

For obvious reasons we can and will identify f with a homomorphism $f: \tau(I') \rightarrow \tau(I'')$. If $Y = (J'' \oplus \tau(J'), g)$ is another object in \mathcal{C}_M , then we have

$$\mathcal{C}_M(X, Y) = \left\{ \begin{pmatrix} \varphi'' & \tilde{\varphi} \\ 0 & \varphi' \end{pmatrix} \in \text{Hom}_{KQ}(I'' \oplus \tau(I'), J'' \oplus \tau(J')) \mid g \circ \varphi' = \tau(\varphi'') \circ f \right\}.$$

Thus the diagram

$$\begin{array}{ccc} \tau(I') & \xrightarrow{\varphi'} & \tau(J') \\ \downarrow f & & \downarrow g \\ \tau(I'') & \xrightarrow{\tau(\varphi'')} & \tau(J'') \end{array}$$

commutes. Note that there is no condition on $\tilde{\varphi} \in \text{Hom}_{KQ}(\tau(I'), J'')$.

11.5. Description of the functor G . Using the above conventions and notations we define $G: \mathcal{C}_M \rightarrow \mathcal{C}_Q$ on objects as

$$G(X) := (0 \rightarrow I' \xrightarrow{\tau^{-1}(f)} I'' \rightarrow 0) \in \mathcal{F}.$$

For a morphism $\varphi \in \mathcal{C}_M(X, Y)$ we define

$$G(\varphi) := ((\tau^{-1}(\varphi'), \varphi''), \tau_{\mathcal{D}}^{-1}(\tilde{\varphi}))$$

The first component, $(\tau^{-1}(\varphi'), \varphi'')$ is by the definition of the homomorphisms in \mathcal{C}_M a homomorphism between complexes of injective modules. So this is well defined. As for the second component consider the following diagram for morphisms $G(X) \rightarrow FG(Y)$ in \mathcal{D} :

$$\begin{array}{ccc} 0 & \longrightarrow & \tau_{\mathcal{D}}^{-1}(J') \\ \downarrow & & \downarrow \tau_{\mathcal{D}}^{-2}(g) \\ I' & \xrightarrow{\tau_{\mathcal{D}}^{-1}(\tilde{\varphi})} & \tau_{\mathcal{D}}^{-1}(J'') \\ \downarrow \tau^{-1}(f) & & \downarrow \\ I'' & \longrightarrow & 0 \end{array}$$

Theorem 11.2. *The functor G is an epivalence. For $\varphi \in \mathcal{C}_M(X, Y)$ we have $G(\varphi) = 0$ if and only if there exists*

$$\eta = \begin{pmatrix} \eta_2 & 0 \\ \tilde{\eta} & \eta_1 \end{pmatrix} \in \mathcal{D}(I'' \oplus \tau(I'), \tau_{\mathcal{D}}^{-1}(J'') \oplus J')$$

such that

$$(9) \quad \varphi = \begin{pmatrix} \varphi'' & \tilde{\varphi} \\ 0 & \varphi' \end{pmatrix} = \begin{pmatrix} \tau^{-1}(g) \circ \tilde{\eta} & \tau^{-1}(g) \circ \eta_1 + \tau(\eta_1) \circ f \\ 0 & \tau(\tilde{\eta}) \circ f \end{pmatrix}.$$

Moreover, the condition (9) is equivalent to the condition that φ factors through a \mathcal{C}_M -projective-injective module. This implies that $\underline{G}: \underline{\mathcal{C}}_M \rightarrow \mathcal{C}_Q$ is an equivalence.

Proof. (a) Obviously, G is dense. On morphisms, G is surjective in the first component because $(\tau^{-1}(\varphi'), \varphi'')$ can be any morphism between the two complexes of injectives which are concentrated in degree 0 and 1. Moreover, in the derived category \mathcal{D} homomorphisms between bounded complexes of injectives are just given by morphisms of complexes modulo homotopy.

(b) In order to see that G is also surjective in the second component, we consider the standard triangles

$$I' \xrightarrow{\tau^{-1}(f)} I'' \rightarrow G(X)[1] \rightarrow I'[1]$$

and

$$\tau_{\mathcal{D}}^{-1}(J') \xrightarrow{\tau_{\mathcal{D}}^{-2}(g)} \tau_{\mathcal{D}}^{-1}(J'') \rightarrow FG(Y) \rightarrow \tau_{\mathcal{D}}^{-1}(J')[1]$$

in \mathcal{D} . For $i \neq j$ and $a, b \in \{', ''\}$ we get $\mathcal{D}(I^a[i], \tau_{\mathcal{D}}^{-1}(J^b)[j]) = 0$. From the corresponding long exact sequences we obtain the following commutative diagram with exact rows and

columns:

$$\begin{array}{ccccccc}
\mathcal{D}(I'', \tau_{\mathcal{D}}^{-1}(J')) & \longrightarrow & \mathcal{D}(I'', \tau_{\mathcal{D}}^{-1}(J'')) & \longrightarrow & \mathcal{D}(I'', FG(Y)) & \longrightarrow & 0 \\
\downarrow & & \downarrow & & \downarrow & & \downarrow \\
\mathcal{D}(I', \tau_{\mathcal{D}}^{-1}(J')) & \longrightarrow & \mathcal{D}(I', \tau_{\mathcal{D}}^{-1}(J'')) & \longrightarrow & \mathcal{D}(I', FG(Y)) & \longrightarrow & 0 \\
\downarrow & & \downarrow & & \downarrow & & \downarrow \\
\mathcal{D}(G(X), \tau_{\mathcal{D}}^{-1}(J')) & \longrightarrow & \mathcal{D}(G(X), \tau_{\mathcal{D}}^{-1}(J'')) & \longrightarrow & \mathcal{D}(G(X), FG(Y)) & \longrightarrow & \mathcal{D}(G(X), \tau_{\mathcal{D}}^{-1}(J')[1]) \\
\downarrow & & \downarrow & & \downarrow & & \downarrow \\
0 & \longrightarrow & 0 & \longrightarrow & \mathcal{D}(I''[-1], FG(Y)) & \longrightarrow & 0
\end{array}$$

Thus, $\mathcal{D}(I''[1], FG(Y)) = 0 = \mathcal{D}(G(X), \tau_{\mathcal{D}}^{-1}(J')[1])$, and we conclude that

$$\mathcal{D}(G(X), FG(Y)) \cong \frac{\mathcal{D}(I', \tau_{\mathcal{D}}^{-1}(J''))}{(\tau_{\mathcal{D}}^{-2}(g))\mathcal{D}(I', \tau_{\mathcal{D}}^{-1}(J')) + \mathcal{D}(I'', \tau_{\mathcal{D}}^{-1}(J''))(\tau^{-1}(f))}.$$

(c) Our claim on the kernel of G follows from the end of steps (a) and (b), respectively. Now one can use our results in Section 6 to describe the morphisms in \mathcal{C}_M which factor through \mathcal{C}_M -projective-injectives. It follows that this is equivalent to the description of the kernel of G in (9). \square

In practice, the functor $G: \mathcal{C}_M \rightarrow \mathcal{C}_Q$ is (at least on objects) easy to handle: Take an indecomposable KQ -module L , and let

$$0 \rightarrow L \rightarrow I' \xrightarrow{f} I'' \rightarrow 0$$

be a minimal injective resolution of L . Define a Λ -module

$$\tilde{L} := \left(I'' \oplus \tau(I'), \begin{pmatrix} 0 & \tau(f) \\ 0 & 0 \end{pmatrix} \right).$$

Then we have $G(\tilde{L}) = L$. In particular, if $L = I_i$ is injective, then $\tilde{L} = (\tau(I_i), 0)$. Note that there is a short exact sequence

$$0 \rightarrow (I'', 0) \rightarrow \tilde{L} \rightarrow (\tau(I'), 0) \rightarrow 0.$$

of Λ -modules.

Next, let $L := I_i[-1]$ be the $[-1]$ -shift of an indecomposable injective KQ -module I_i . Set $\tilde{L} := (I_i, 0)$. Again, we have $G(\tilde{L}) = L$.

This describes the preimages of the indecomposable objects in \mathcal{C}_Q under the equivalence $\underline{G}: \underline{\mathcal{C}}_M \rightarrow \mathcal{C}_Q$.

Example: Let Q be the quiver

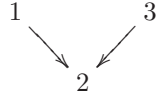

and let

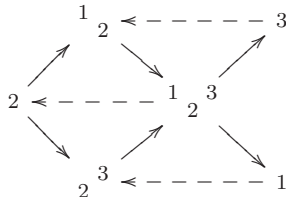

be the Auslander-Reiten quiver of KQ . (The dotted arrows show how the Auslander-Reiten translation τ acts on the non-projective indecomposable KQ -modules.) Then

$$0 \rightarrow {}^1_2 \rightarrow {}^1_2 \oplus {}^3 \xrightarrow{f} {}^3 \rightarrow 0$$

is a minimal injective resolution of the KQ -module $L := {}^1_2$, where f is just the obvious projection map. It follows that

$$\tilde{L} = \left({}^3 \oplus {}^2, \begin{pmatrix} 0 & \tau(f) \\ 0 & 0 \end{pmatrix} \right) = {}^2_3.$$

Note that $\tau(f): {}^2 \rightarrow {}^1_2$ is the obvious inclusion map. (Here we are using the same notation as in Section 7.5: The numbers 1, 2, 3 correspond to composition factors of KQ -modules and Λ -modules, respectively. For example 2_3 is the 2-dimensional indecomposable Λ -module with top S_2 and socle S_3 .)

Part 3. Mutations

12. MUTATION OF \mathcal{C} -MAXIMAL RIGID MODULES

Proposition 12.1. *Let $T \oplus X$ be a basic rigid Λ -module such that the following hold:*

- X is indecomposable;
- $X \in \text{Sub}(T)$.

Then there exists a short exact sequence

$$0 \rightarrow X \xrightarrow{f} T' \xrightarrow{g} Y \rightarrow 0$$

such that the following hold:

- f is a minimal left $\text{add}(T)$ -approximation;
- g is a minimal right $\text{add}(T)$ -approximation;
- $T \oplus Y$ is basic rigid;
- Y is indecomposable and $X \not\cong Y$.

Proof. Let $f: X \rightarrow T'$ be a minimal left $\text{add}(T)$ -approximation of X . Since $X \in \text{Sub}(T)$, it follows that f is a monomorphism. Now copy the proof of [GLS5, Proposition 5.6]. \square

In the situation of the above proposition, we call $\{X, Y\}$ an *exchange pair associated to T* , and we write

$$\mu_X(T \oplus X) = T \oplus Y.$$

We say that $T \oplus Y$ is the mutation of $T \oplus X$ in direction X . The short exact sequence

$$0 \rightarrow X \xrightarrow{f} T' \xrightarrow{g} Y \rightarrow 0$$

is the *exchange sequence* starting in X and ending in Y .

Proposition 12.2. *Let X and Y be indecomposable rigid Λ -modules with*

$$\dim \text{Ext}_{\Lambda}^1(Y, X) = 1,$$

and let

$$0 \rightarrow X \xrightarrow{f} E \xrightarrow{g} Y \rightarrow 0$$

be a non-split short exact sequence. Then the following hold:

- (i) $E \oplus X$ and $E \oplus Y$ are rigid and $X, Y \notin \text{add}(E)$.
- (ii) *If we assume additionally that $T \oplus X$ and $T \oplus Y$ are basic \mathcal{C} -maximal rigid Λ -modules for some selfinjective torsion class \mathcal{C} of $\text{nil}(\Lambda)$, then f is a minimal left $\text{add}(T)$ -approximation and g is a minimal right $\text{add}(T)$ -approximation.*

Proof. If X and Y are in some selfinjective torsion class \mathcal{C} , then $E \in \mathcal{C}$, since \mathcal{C} is closed under extensions. Now copy the proof of [GLS5, Proposition 5.7]. \square

Corollary 12.3. *Let \mathcal{C} be a selfinjective torsion class of $\text{nil}(\Lambda)$. Let $\{X, Y\}$ be an exchange pair associated to some basic rigid Λ -module T such that $T \oplus X$ and $T \oplus Y$ are \mathcal{C} -maximal rigid, and assume $\dim \text{Ext}_{\Lambda}^1(Y, X) = 1$. Then*

$$\mu_Y(\mu_X(T \oplus X)) = T \oplus X.$$

Proof. Copy the proof of [GLS5, Corollary 5.8]. \square

13. ENDOMORPHISM ALGEBRAS OF \mathcal{C} -MAXIMAL RIGID MODULES

In this section, let \mathcal{C} be a selfinjective torsion class of $\text{nil}(\Lambda)$. We denote by $I_{\mathcal{C}}$ its \mathcal{C} -projective generator-cogenerator. We work mainly with basic rigid Λ -modules in \mathcal{C} . However, all our results on their endomorphism algebras are Morita invariant, thus they hold for endomorphism algebras of arbitrary rigid Λ -modules in \mathcal{C} .

Let A be a K -algebra, and let $M = M_1^{n_1} \oplus \cdots \oplus M_t^{n_t}$ be a finite-dimensional A -module, where the M_i are pairwise non-isomorphic indecomposable modules and $n_i \geq 1$. As before let $S_i = S_{M_i}$ be the simple $\text{End}_A(M)$ -module corresponding to M_i . Then $\text{Hom}_A(M_i, M)$ is the indecomposable projective $\text{End}_A(M)$ -module with top S_i . The basic facts on the quiver Γ_M of the endomorphism algebra $\text{End}_A(M)$ are collected in [GLS5, Section 3.2].

Theorem 13.1 ([Ig]). *Let A be a finite-dimensional K -algebra. If $\text{gl. dim}(A) < \infty$, then the quiver of A has no loops.*

Proposition 13.2 ([GLS5, Proposition 3.11]). *Let A be a finite-dimensional K -algebra. If $\text{gl. dim}(A) < \infty$ and if the quiver of A has a 2-cycle, then $\text{Ext}_A^2(S, S) \neq 0$ for some simple A -module S .*

Lemma 13.3 ([GLS5, Lemma 6.1]). *Let $\{X, Y\}$ be an exchange pair associated to a basic rigid Λ -module T . Then the following are equivalent:*

- *The quiver of $\text{End}_{\Lambda}(T \oplus X)$ has no loop at X ;*
- *Every non-isomorphism $X \rightarrow X$ factors through $\text{add}(T)$;*
- $\dim \text{Ext}_{\Lambda}^1(Y, X) = 1$.

Lemma 13.4. *Let T be a basic \mathcal{C} -maximal rigid Λ -module. If the quiver of $\text{End}_{\Lambda}(T)$ has no loops, then every indecomposable \mathcal{C} -projective module has a simple socle.*

Proof. Let P be an indecomposable \mathcal{C} -projective module. Let $h: P \rightarrow T'$ be a minimal left $\text{add}(T/P)$ -approximation, and set $X := P/\text{Ker}(h)$. Since P is \mathcal{C} -projective, $\text{Ker}(h) \neq 0$.

Let U be a non-zero submodule of P , and set $X' := P/U$. Since \mathcal{C} is closed under factor modules, we get $X' \in \mathcal{C}$. By $p: P \rightarrow X'$ we denote the canonical projection morphism.

We know that T is a cogenerator of \mathcal{C} . Thus there exists a monomorphism

$$\phi = \begin{bmatrix} \phi_1 \\ \vdots \\ \phi_m \\ \theta \end{bmatrix} : X' \rightarrow P^m \oplus T''$$

with $T'' \in \text{add}(T/P)$. Since $U \neq 0$, none of the homomorphisms $\phi_i: X' \rightarrow P$ is invertible. In particular, none of the ϕ_i is an epimorphism. The image of

$$\phi \circ p = \begin{bmatrix} \phi_1 \circ p \\ \vdots \\ \phi_m \circ p \\ \theta \circ p \end{bmatrix} : P \rightarrow P^m \oplus T''$$

is isomorphic to X' , and $\phi_i \circ p: P \rightarrow P$ is not invertible for all i . Since the quiver of $\text{End}_{\Lambda}(T)$ has no loops, there exist homomorphisms $\phi'_i: P \rightarrow T'_i$ and $\phi''_i: T'_i \rightarrow P$ with $T'_i \in \text{add}(T/P)$ such that

$$\phi_i \circ p = \phi''_i \circ \phi'_i$$

for all i . Set

$$\phi' = \begin{bmatrix} \phi'_1 \\ \vdots \\ \phi'_m \\ \theta \circ p \end{bmatrix} : P \rightarrow \left(\bigoplus_{i=1}^m T'_i \right) \oplus T''.$$

It follows that $\phi \circ p = \phi'' \circ \phi'$ where

$$\phi'' = \begin{bmatrix} \phi''_1 & & & \\ & \ddots & & \\ & & \phi''_m & \\ & & & 1_{T''} \end{bmatrix}.$$

Thus the image of ϕ' has at least the dimension of X' , and we have

$$\text{Ker}(\phi') \subseteq \text{Ker}(\phi \circ p) = \text{Ker}(p) = U.$$

Now h is a left $\text{add}(T/P)$ -approximation, thus ϕ' factors through h . Therefore $\dim X' \leq \dim \text{Im}(h) = \dim X$. It follows that $\text{Ker}(h)$ must be simple.

Next, assume that U_1 and U_2 are simple submodules of P with $U_1 \neq U_2$. Thus there exists a monomorphism $P \rightarrow P/U_1 \oplus P/U_2$. From the above considerations we know that P/U_1 and P/U_2 are both in $\text{Sub}(T/P)$. This implies that P is in $\text{Sub}(T/P)$, a contradiction. We conclude that P has a simple socle. \square

Proposition 13.5. *Let T be a basic \mathcal{C} -maximal rigid Λ -module. If the quiver of $\text{End}_\Lambda(T)$ has no loops, then*

$$\text{gl. dim}(\text{End}_\Lambda(T)) = 3.$$

Proof. Set $B = \text{End}_\Lambda(T)$. By assumption, the quiver of B has no loops. It follows that $\text{Ext}_B^1(S, S) = 0$ for all simple B -modules S . Let $T = T_1 \oplus \cdots \oplus T_r$ with T_i indecomposable for all i . As before, denote the simple B -module corresponding to T_i by S_{T_i} .

Assume that $X = T_i$ is not \mathcal{C} -projective. Let $\{X, Y\}$ be the exchange pair associated to T/X . Note that $I_{\mathcal{C}} \in \text{add}(T/X)$. This implies $X \in \text{Fac}(T/X)$ and $X \in \text{Sub}(T/X)$.

By Lemma 13.3 we have $\dim \text{Ext}_\Lambda^1(Y, X) = 1$. Let

$$0 \rightarrow X \rightarrow T' \rightarrow Y \rightarrow 0$$

and

$$0 \rightarrow Y \rightarrow T'' \rightarrow X \rightarrow 0$$

be the corresponding non-split short exact sequences. As in the proof of [GLS5, Proposition 6.2] we obtain a minimal projective resolution

$$0 \rightarrow \text{Hom}_\Lambda(X, T) \rightarrow \text{Hom}_\Lambda(T'', T) \rightarrow \text{Hom}_\Lambda(T', T) \rightarrow \text{Hom}_\Lambda(X, T) \rightarrow S_X \rightarrow 0.$$

In particular, $\text{proj. dim}_B(S_X) = 3$.

Next, assume that $P = T_i$ is \mathcal{C} -projective. By Lemma 13.4 we know that P has a simple socle, say S . As in [GLS5, Proposition 9.4] one shows that $X := P/S$ is rigid. Note also that $X \in \mathcal{C}$. Let $f: X \rightarrow T'$ be a minimal left $\text{add}(T/P)$ -approximation. It is easy to show that f is injective. We get a short exact sequence

$$0 \rightarrow X \xrightarrow{f} T' \rightarrow Y \rightarrow 0.$$

It follows that $Y \in \text{add}(T)$. The projection $\pi: P \rightarrow X$ yields an exact sequence

$$P \xrightarrow{h} T' \rightarrow Y \rightarrow 0$$

where $h = f\pi$. One can easily check that h is a minimal left $\text{add}(T/P)$ -approximation. Applying $\text{Hom}_\Lambda(-, T)$ to this sequence gives a projective resolution

$$0 \rightarrow \text{Hom}_\Lambda(Y, T) \rightarrow \text{Hom}_\Lambda(T', T) \xrightarrow{\text{Hom}_\Lambda(h, T)} \text{Hom}_\Lambda(P, T) \rightarrow S_P \rightarrow 0.$$

This implies $\text{proj. dim}(S_P) \leq 2$. For details we refer to the proof of [GLS5, Proposition 6.2]. This finishes the proof. \square

Recall the definition of a cluster torsion class of $\text{nil}(\Lambda)$ (see Section 5.4). The statements in the following theorem are presented in the order in which we prove them.

Theorem 13.6. *Let \mathcal{C} be a cluster torsion class of $\text{nil}(\Lambda)$. Let T be a basic \mathcal{C} -maximal rigid Λ -module, and set $B = \text{End}_\Lambda(T)$. Then the following hold:*

- (1) *The quiver of B has no loops;*
- (2) *$\text{gl. dim}(B) = 3$;*
- (3) *For all simple B -modules S we have $\text{Ext}_B^1(S, S) = 0$ and $\text{Ext}_B^2(S, S) = 0$;*
- (4) *The quiver of B has no 2-cycles.*

Proof. By Theorem 10.2 we know that $\text{End}_\Lambda(T_{\mathcal{C}})$ and $\text{End}_\Lambda(T)$ are derived equivalent, since every \mathcal{C} -complete rigid module is obviously \mathcal{C} -maximal rigid. Since the quiver of $\text{End}_\Lambda(T_{\mathcal{C}})$ has no loops, Proposition 13.5 implies that $\text{gl. dim}(\text{End}_\Lambda(T_{\mathcal{C}})) = 3 < \infty$. This implies $\text{gl. dim}(\text{End}_\Lambda(T)) < \infty$. Thus by Theorem 13.1 the quiver of $\text{End}_\Lambda(T)$ has no loops. Then again Proposition 13.5 yields $\text{gl. dim}(\text{End}_\Lambda(T)) = 3$. This proves (1) and (2).

Since the quiver of B has no loops, we have $\text{Ext}_B^1(S, S) = 0$ for all simple B -modules S . Let X be a direct summand of T such that X is not \mathcal{C} -projective. In the proof of Proposition 13.5, we constructed a projective resolution

$$0 \rightarrow \text{Hom}_\Lambda(X, T) \rightarrow \text{Hom}_\Lambda(T'', T) \rightarrow \text{Hom}_\Lambda(T', T) \rightarrow \text{Hom}_\Lambda(X, T) \rightarrow S_X \rightarrow 0,$$

and we also know that $X \notin \text{add}(T'')$. Thus applying $\text{Hom}_B(-, S_X)$ to this resolution yields $\text{Ext}_B^2(S_X, S_X) = 0$. Next, assume P is an indecomposable \mathcal{C} -projective direct summand of T . As in the proof of Proposition 13.5 we have a projective resolution

$$0 \rightarrow \text{Hom}_\Lambda(Y, T) \rightarrow \text{Hom}_\Lambda(T', T) \xrightarrow{\text{Hom}_\Lambda(h, T)} \text{Hom}_\Lambda(P, T) \rightarrow S_P \rightarrow 0$$

where $P \notin \text{add}(T')$. Since the module T' projects onto Y , we conclude that $P \notin \text{add}(Y)$. Applying $\text{Hom}_B(-, S_P)$ to the above resolution of S_P yields $\text{Ext}_B^2(S_P, S_P) = 0$. This finishes the proof of (3).

We proved that for all simple B -modules S we have $\text{Ext}_B^2(S, S) = 0$. We also know that $\text{gl. dim}(B) = 3 < \infty$. Then it follows from Proposition 13.2 that the quiver of B cannot have 2-cycles. Thus (4) holds. This finishes the proof. \square

Corollary 13.7. *Let \mathcal{C} be a cluster torsion class of $\text{nil}(\Lambda)$. Let T be a basic \mathcal{C} -maximal rigid Λ -module, and let X be an indecomposable direct summand of T which is not \mathcal{C} -projective. Let*

$$0 \rightarrow X \rightarrow T' \rightarrow Y \rightarrow 0$$

be the corresponding exchange sequence starting in X . Then the following hold:

- *We have $\dim \text{Ext}_\Lambda^1(Y, X) = \dim \text{Ext}_\Lambda^1(X, Y) = 1$, and the exchange sequence ending in X is of the form*

$$0 \rightarrow Y \rightarrow T'' \rightarrow X \rightarrow 0$$

for some $T'' \in \text{add}(T/X)$;

- *The simple $\text{End}_\Lambda(T)$ -module S_X has a minimal projective resolution of the form*

$$0 \rightarrow \text{Hom}_\Lambda(X, T) \rightarrow \text{Hom}_\Lambda(T'', T) \rightarrow \text{Hom}_\Lambda(T', T) \rightarrow \text{Hom}_\Lambda(X, T) \rightarrow S_X \rightarrow 0;$$
- *We have $\text{add}(T') \cap \text{add}(T'') = 0$.*

Proof. Copy the proof of [GLS5, Corollary 6.5]. \square

Theorem 13.8. *Let M be a terminal KQ -module. For a Λ -module T in \mathcal{C}_M the following are equivalent:*

- (i) T is \mathcal{C}_M -maximal rigid;
- (ii) T is \mathcal{C}_M -complete rigid;
- (iii) T is \mathcal{C}_M -maximal 1-orthogonal.

Proof. Since \mathcal{C}_M is a selfinjective torsion class of $\text{nil}(\Lambda)$, we know from Corollary 10.7 that (i) and (ii) are equivalent. Every \mathcal{C}_M -maximal 1-orthogonal module is obviously \mathcal{C}_M -maximal rigid. Vice versa, assume that T is \mathcal{C}_M -maximal rigid. We know that there exists some \mathcal{C}_M -complete rigid module T_M such that the quiver of $\text{End}_\Lambda(T_M)$ has no loops. By Theorem 13.6 we get that $\text{gl. dim}(\text{End}_\Lambda(T)) = 3$. Thus we can use Theorem 10.1 and get that T is \mathcal{C}_M -maximal 1-orthogonal. \square

We conjecture that Theorem 13.8 can be generalized to the case where \mathcal{C} is a cluster torsion class of $\text{nil}(\Lambda)$. Note however that in this article (and also in [GLS5]) we do not make any use of the fact that every \mathcal{C}_M -maximal rigid module is \mathcal{C}_M -maximal 1-orthogonal.

Proposition 13.9. *Let \mathcal{C} be a cluster torsion class of $\text{nil}(\Lambda)$. Let T be a basic \mathcal{C} -maximal rigid Λ -module, and let X be an indecomposable direct summand of T which is not \mathcal{C} -projective. Set $B = \text{End}_\Lambda(T)$. Then for any simple B -module S we have*

$$\dim \text{Ext}_B^{3-i}(S_X, S) = \dim \text{Ext}_B^i(S, S_X)$$

where $0 \leq i \leq 3$.

Proof. Copy the proof of [GLS5, Proposition 6.6]. \square

14. FROM MUTATION OF MODULES TO MUTATION OF MATRICES

In this section, let \mathcal{C} be a cluster torsion class of $\text{nil}(\Lambda)$.

Let $T = T_1 \oplus \cdots \oplus T_r$ be a basic \mathcal{C} -maximal rigid Λ -module with T_i indecomposable for all i . Without loss of generality we assume that T_{r-n+1}, \dots, T_r are \mathcal{C} -projective. For $1 \leq i \leq r$ let $S_i = S_{T_i}$ be the simple $\text{End}_\Lambda(T)$ -module corresponding to T_i . The matrix

$$C_T = (c_{ij})_{1 \leq i, j \leq r}$$

where

$$c_{ij} = \dim \text{Hom}_{\text{End}_\Lambda(T)}(\text{Hom}_\Lambda(T_i, T), \text{Hom}_\Lambda(T_j, T)) = \dim \text{Hom}_\Lambda(T_j, T_i)$$

is the Cartan matrix of the algebra $\text{End}_\Lambda(T)$.

By Theorem 13.6 we know that $\text{gl. dim}(\text{End}_\Lambda(T)) = 3$. As in [GLS5, Section 7] this implies that

$$(10) \quad R_T = (r_{ij})_{1 \leq i, j \leq r} = C_T^{-t}$$

is the matrix of the Ringel form of $\text{End}_\Lambda(T)$, where

$$r_{ij} = \langle S_i, S_j \rangle = \sum_{i=0}^3 (-1)^i \dim \text{Ext}_{\text{End}_\Lambda(T)}^i(S_i, S_j).$$

Lemma 14.1. *Assume that $i \leq r - n$ or $j \leq r - n$. Then the following hold:*

- $r_{ij} = \dim \text{Ext}_{\text{End}_\Lambda(T)}^1(S_j, S_i) - \dim \text{Ext}_{\text{End}_\Lambda(T)}^1(S_i, S_j)$;
- $r_{ij} = -r_{ji}$;

$$\bullet r_{ij} = \begin{cases} \text{number of arrows } j \rightarrow i \text{ in } \Gamma_T & \text{if } r_{ij} > 0, \\ -(\text{number of arrows } i \rightarrow j \text{ in } \Gamma_T) & \text{if } r_{ij} < 0, \\ 0 & \text{otherwise.} \end{cases}$$

Proof. Copy the proof of [GLS5, Lemma 7.3]. \square

Recall that $B(T) = B(\Gamma_T) = (t_{ij})_{1 \leq i, j \leq r}$ is the $r \times r$ -matrix defined by

$$t_{ij} = (\text{number of arrows } j \rightarrow i \text{ in } \Gamma_T) - (\text{number of arrows } i \rightarrow j \text{ in } \Gamma_T).$$

Let $B(T)^\circ = (t_{ij})$ and $R_T^\circ = (r_{ij})$ be the $r \times (r - n)$ -matrices obtained from $B(T)$ and R_T , respectively, by deleting the last n columns. As a consequence of Lemma 14.1 we get the following:

Corollary 14.2. $R_T^\circ = B(T)^\circ$.

The dimension vector of the indecomposable projective $\text{End}_\Lambda(T)$ -module $\text{Hom}_\Lambda(T_i, T)$ is the i th column of the matrix C_T .

For $1 \leq k \leq r - n$ let

$$(11) \quad 0 \rightarrow T_k \rightarrow T' \rightarrow T_k^* \rightarrow 0$$

and

$$(12) \quad 0 \rightarrow T_k^* \rightarrow T'' \rightarrow T_k \rightarrow 0$$

be exchange sequences associated to the direct summand T_k of T . Keeping in mind the remarks in [GLS5, Section 3.2], it follows from Lemma 14.1 that

$$T' = \bigoplus_{r_{ik} > 0} T_i^{r_{ik}} \quad \text{and} \quad T'' = \bigoplus_{r_{ik} < 0} T_i^{-r_{ik}}.$$

Set

$$T^* = \mu_{T_k}(T) = T_k^* \oplus T/T_k.$$

For an $m \times m$ -matrix B and some $k \in [1, m]$ we define an $m \times m$ -matrix $S = S(B, k) = (s_{ij})$ by

$$s_{ij} = \begin{cases} -\delta_{ij} + \frac{|b_{ij}| - b_{ij}}{2} & \text{if } i = k, \\ \delta_{ij} & \text{otherwise.} \end{cases}$$

By S^t we denote the transpose of the matrix $S = S(B, k)$.

Now let $S = S(R_T, k)$. The proofs of the following proposition and its corollaries are identical to the ones in [GLS5].

Proposition 14.3. *With the above notation we have*

$$C_{T^*} = SC_T S^t.$$

Corollary 14.4. $R_{T^*} = S^t R_T S$.

Corollary 14.5. $R_{T^*}^\circ = \mu_k(R_T^\circ)$.

Now we combine Corollary 14.2 and Corollary 14.5 and obtain the following theorem:

Theorem 14.6. $B(\mu_{T_k}(T))^\circ = \mu_k(B(T)^\circ)$.

In particular, applying Theorem 14.6 to the cluster torsion class \mathcal{C}_M we have proved Theorem 3.1.

15. MUTATIONS OF CLUSTERS VIA DIMENSION VECTORS

Let \mathcal{C} be a cluster torsion class of $\text{nil}(\Lambda)$ of rank r . Let $T_{\mathcal{C}}$ be a fixed basic \mathcal{C} -maximal rigid module and set $B = \text{End}_{\Lambda}(T_{\mathcal{C}})$. In this section we prove that every indecomposable rigid module X in \mathcal{C} is determined by the dimension vector \mathbf{d}_X of the B -module $\text{Hom}_{\Lambda}(X, T_{\mathcal{C}})$. If $\{X, Y\}$ is an exchange pair associated to $U = U_1 \oplus \cdots \oplus U_{r-1}$, we also give an easy combinatorial rule to calculate \mathbf{d}_Y in terms of \mathbf{d}_X and the vectors \mathbf{d}_{U_i} .

15.1. Dimension vectors of rigid modules. Let A be a finite-dimensional K -algebra, and assume that K is algebraically closed. For $d \geq 1$ let A^d be the free A -module of rank d . Let U be an A -module which is isomorphic to a submodule of A^d , and set

$$\mathbf{e} = \underline{\dim}(A^d) - \underline{\dim}(U).$$

By $\text{mod}(A, \mathbf{e})$ we denote the affine variety of A -modules with dimension vector \mathbf{e} .

The *Richmond stratum* $\mathcal{S}(U, A^d)$ is the subset of $\text{mod}(A, \mathbf{e})$ consisting of the modules M such that there exists a short exact sequence

$$0 \rightarrow U \rightarrow A^d \rightarrow M \rightarrow 0.$$

Theorem 15.1 ([R, Theorem 1]). *The Richmond stratum $\mathcal{S}(U, A^d)$ is a smooth, irreducible, locally closed subset of $\text{mod}(A, \mathbf{e})$, and*

$$\dim \mathcal{S}(U, A^d) = \dim \text{Hom}_A(U, A^d) - \dim \text{End}_A(U).$$

Corollary 15.2. *Assume that $\text{gl. dim}(A) < \infty$. Let M and N be A -modules such that the following hold:*

- $\underline{\dim}(M) = \underline{\dim}(N)$;
- M and N are rigid;
- $\text{proj. dim}(M) \leq 1$ and $\text{proj. dim}(N) \leq 1$;

Then $M \cong N$.

Proof. Let $\mathbf{d} = (d_1, \dots, d_n)$ be the dimension vector of the modules M and N , and set $d = d_1 + \cdots + d_n$. So there are epimorphisms $f: A^d \rightarrow M$ and $g: A^d \rightarrow N$. Since the projective dimensions of M and N are at most one, we get two short exact sequences

$$0 \rightarrow P' \rightarrow A^d \rightarrow M \rightarrow 0 \quad \text{and} \quad 0 \rightarrow P'' \rightarrow A^d \rightarrow N \rightarrow 0$$

with P' and P'' projective modules which have the same dimension vector.

Since $\text{gl. dim}(A) < \infty$, the Cartan matrix of A is invertible. Thus the dimension vectors of the indecomposable projective A -modules are linearly independent. These two facts yield that P' and P'' are isomorphic. Since M and N are rigid, the orbits \mathcal{O}_M and \mathcal{O}_N are dense in the Richmond stratum $\mathcal{S}(P', A^d)$, thus $\mathcal{O}_M = \mathcal{O}_N$ and therefore $M \cong N$. Here we use the fact that Richmond strata are irreducible. \square

Corollary 15.2 is in some sense optimal as the following two examples show. Let Q be the quiver with two vertices 1 and 2, and two arrows $a: 1 \rightarrow 2$ and $b: 2 \rightarrow 1$.

Let $A_1 = KQ/I_1$ where the ideal I_1 of the path algebra KQ is generated by the path ba . Let $M = \frac{1}{2}$ and $N = \frac{2}{1}$. Obviously, $\underline{\dim}(M) = \underline{\dim}(N) = (1, 1)$ and $M \not\cong N$. The following hold:

- M and N are rigid;
- $\text{proj. dim}(M) = 1$ and $\text{proj. dim}(N) = 2$;
- $\text{gl. dim}(A) = 2$.

Next, let $A_2 = KQ/I_2$ where the ideal I_2 of the path algebra KQ is generated by the paths ab and ba . Define the modules M and N as above. Then the following hold:

- M and N are rigid;
- $\text{proj. dim}(M) = \text{proj. dim}(N) = 0$;
- $\text{gl. dim}(A) = \infty$.

Corollary 15.3. *Let X and Y be indecomposable rigid modules in \mathcal{C} . If $\mathbf{d}_X = \mathbf{d}_Y$ then $X \cong Y$.*

Proof. Let $M = \text{Hom}_\Lambda(X, T_{\mathcal{C}})$ and $N = \text{Hom}_\Lambda(Y, T_{\mathcal{C}})$. Since M and N are direct summands of tilting modules over B they are rigid, and by Corollary 9.9 they have projective dimension at most one. Hence by Corollary 15.2 we have $M \cong N$. Now applying Lemma 9.11 and Corollary 9.5 we get that $X \cong Y$. \square

15.2. Mutations via dimension vectors. We now explain how to calculate mutations of clusters via dimension vectors. We start with some notation: For $\mathbf{d} = (d_1, \dots, d_r)$ and $\mathbf{e} = (e_1, \dots, e_r)$ in \mathbb{Z}^r define

$$\max\{\mathbf{d}, \mathbf{e}\} := (f_1, \dots, f_r)$$

where $f_i = \max\{d_i, e_i\}$ for $1 \leq i \leq r$. Set $\text{Max}\{\mathbf{d}, \mathbf{e}\} := \mathbf{d}$ if $d_i \geq e_i$ for all i . In this case, we write $\mathbf{d} \geq \mathbf{e}$. Of course, $\text{Max}\{\mathbf{d}, \mathbf{e}\} = \mathbf{d}$ implies $\max\{\mathbf{d}, \mathbf{e}\} = \mathbf{d}$. By $|\mathbf{d}|$ we denote the sum of the entries of \mathbf{d} .

Let Γ^* be a quiver as constructed in Section 3.5. We assume that Γ^* has r vertices. Now replace each vertex i of Γ^* by some $\mathbf{d}_i \in \mathbb{Z}^r$. Thus we obtain a new quiver $(\Gamma^*)'$ whose vertices are elements in \mathbb{Z}^r .

For $k \neq (i, 0)$ define the mutation $\mu_{\mathbf{d}_k}((\Gamma^*)')$ of $(\Gamma^*)'$ at the vertex \mathbf{d}_k in two steps:

- (1) Replace the vertex \mathbf{d}_k of $(\Gamma^*)'$ by

$$\mathbf{d}_k^* := -\mathbf{d}_k + \max \left\{ \sum_{\mathbf{d}_k \rightarrow \mathbf{d}_i} \mathbf{d}_i, \sum_{\mathbf{d}_j \rightarrow \mathbf{d}_k} \mathbf{d}_j \right\}$$

where the sums are taken over all arrows in $(\Gamma^*)'$ which start, respectively end in the vertex \mathbf{d}_k ;

- (2) Change the arrows of $(\Gamma^*)'$ following Fomin and Zelevinsky's quiver mutation rule for the vertex \mathbf{d}_k .

Thus starting with $(\Gamma^*, (\mathbf{d}_i)_i)$ we can use iterated mutation and obtain quivers whose vertices are elements in \mathbb{Z}^r . It is an important and interesting question, if these quivers parametrize the seeds or clusters of the cluster algebra $\mathcal{A}(B(\Gamma^*)^\circ)$ associated to Γ^* , and if the elements in \mathbb{Z}^r appearing as vertices are in bijection with the cluster variables of $\mathcal{A}(B(\Gamma^*)^\circ)$.

For example, if for each i we choose $\mathbf{d}_i = -\mathbf{e}_i$, where \mathbf{e}_i is the i th canonical basis vector of \mathbb{Z}^r , then the resulting vertices (i.e. elements in \mathbb{Z}^r) are the denominator vectors of the cluster variables of $\mathcal{A}(B(\Gamma^*)^\circ)$, compare [FZ5, Section 7, Equation (7.7)]. (The variables attached to the vertices $(i, 0)$ serve as (non-invertible) coefficients. To obtain the denominator vectors as defined in [FZ5] one has to ignore the entries corresponding to these n coefficients.) It is an open problem, if these denominator vectors actually parametrize the cluster variables of $\mathcal{A}(B(\Gamma^*)^\circ)$.

We will show that for an appropriate choice of the initial vectors \mathbf{d}_i , the quivers obtained by iterated mutation of $(\Gamma^*)'$ are in bijection with the seeds and clusters of $\mathcal{A}(B(\Gamma^*)^\circ)$. All resulting vertices (including the \mathbf{d}_i) will be elements in \mathbb{N}^r , and we will show that for our particular choice of initial vectors, we can use “Max” instead of “max” in the formula above. (This holds for all iterated mutations.)

Proposition 15.4. *Let T and R be \mathcal{C} -maximal rigid Λ -modules, and assume that R is basic. Let*

$$\eta' : 0 \rightarrow R_k \xrightarrow{f'} R' \xrightarrow{g'} R_k^* \rightarrow 0 \quad \text{and} \quad \eta'' : 0 \rightarrow R_k^* \xrightarrow{f''} R'' \xrightarrow{g''} R_k \rightarrow 0$$

be the two exchange sequences associated to an indecomposable direct summand R_k of R which is not \mathcal{C} -projective. Then $\dim \operatorname{Hom}_\Lambda(R', T) \neq \dim \operatorname{Hom}_\Lambda(R'', T)$, and we have

$$\underline{\dim}(\operatorname{Hom}_\Lambda(R_k, T)) + \underline{\dim}(\operatorname{Hom}_\Lambda(R_k^*, T)) = \max\{\underline{\dim}(\operatorname{Hom}_\Lambda(R', T)), \underline{\dim}(\operatorname{Hom}_\Lambda(R'', T))\}.$$

Furthermore, the following are equivalent:

- (i) η' is F^T -exact;
- (ii) $\dim \operatorname{Hom}_\Lambda(R', T) > \dim \operatorname{Hom}_\Lambda(R'', T)$;
- (iii) $\underline{\dim}(\operatorname{Hom}_\Lambda(R', T)) \geq \underline{\dim}(\operatorname{Hom}_\Lambda(R'', T))$.

Proof. Set $B = \operatorname{End}_\Lambda(T)$. By [H3, Lemma 2.2] we may assume without loss of generality that $\operatorname{Ext}_B^1(\operatorname{Hom}_\Lambda(R_k^*, T), \operatorname{Hom}_\Lambda(R_k, T)) = 0$. By Proposition 9.2,

$$\begin{aligned} 1 &= \dim \operatorname{Ext}_\Lambda^1(R_k^*, R_k) \geq \dim \operatorname{Ext}_{F^T}^1(R_k^*, R_k) \\ &= \dim \operatorname{Ext}_B^1(\operatorname{Hom}_\Lambda(R_k, T), \operatorname{Hom}_\Lambda(R_k^*, T)) > 0. \end{aligned}$$

This implies $\operatorname{Ext}_\Lambda^1(R_k^*, R_k) = \operatorname{Ext}_{F^T}^1(R_k^*, R_k)$. Thus η' is F^T -exact, and

$$\eta : 0 \rightarrow \operatorname{Hom}_\Lambda(R_k^*, T) \xrightarrow{\operatorname{Hom}_\Lambda(g', T)} \operatorname{Hom}_\Lambda(R', T) \xrightarrow{\operatorname{Hom}_\Lambda(f', T)} \operatorname{Hom}_\Lambda(R_k, T) \rightarrow 0$$

is a (non-split) short exact sequence. If we apply $\operatorname{Hom}_\Lambda(-, T)$ to η'' , we obtain an exact sequence

$$0 \rightarrow \operatorname{Hom}_\Lambda(R_k, T) \xrightarrow{\operatorname{Hom}_\Lambda(g'', T)} \operatorname{Hom}_\Lambda(R'', T) \xrightarrow{\operatorname{Hom}_\Lambda(f'', T)} \operatorname{Hom}_\Lambda(R_k^*, T).$$

Now $\operatorname{Hom}_\Lambda(f'', T)$ cannot be an epimorphism, since that would yield a non-split extension and we know that $\operatorname{Ext}_B^1(\operatorname{Hom}_\Lambda(R_k^*, T), \operatorname{Hom}_\Lambda(R_k, T)) = 0$. Thus for dimension reasons we get $\dim \operatorname{Hom}_\Lambda(R', T) > \dim \operatorname{Hom}_\Lambda(R'', T)$. Using the functors $\operatorname{Hom}_B(P, -)$ where P runs through the indecomposable projective B -modules, it also follows that $\underline{\dim}(\operatorname{Hom}_\Lambda(R', T)) > \underline{\dim}(\operatorname{Hom}_\Lambda(R'', T))$. Finally, the formula for dimension vectors follows from the exactness of η . \square

Proposition 15.4 yields an easy combinatorial rule for the mutation of \mathcal{C} -maximal rigid modules. Let $T = T_1 \oplus \cdots \oplus T_r$ be a \mathcal{C} -maximal rigid Λ -module. We assume that T_{r-n+1}, \dots, T_r are \mathcal{C} -projective. For $1 \leq i \leq r$ let $\mathbf{d}_i := \underline{\dim}(\operatorname{Hom}_\Lambda(T_i, T_{\mathcal{C}}))$.

As before, let Γ_T be the quiver of $\operatorname{End}_\Lambda(T)$. The vertices of Γ_T are labelled by the modules T_i . For each i we replace the vertex labelled by T_i by the dimension vector \mathbf{d}_i . The resulting quiver is denoted by Γ_T' .

For $k \in [1, r-n]$ let

$$0 \rightarrow T_k \rightarrow T' \rightarrow T_k^* \rightarrow 0 \quad \text{and} \quad 0 \rightarrow T_k^* \rightarrow T'' \rightarrow T_k \rightarrow 0$$

be the two resulting exchange sequences. We can now easily compute the dimension vector of the $\text{End}_\Lambda(T_{\mathcal{C}})$ -module $\text{Hom}_\Lambda(T_k^*, T_{\mathcal{C}})$, namely Proposition 15.4 yields that

$$\mathbf{d}_k^* := \underline{\dim}(\text{Hom}_\Lambda(T_k^*, T_{\mathcal{C}})) = \begin{cases} -\mathbf{d}_k + \sum_{\mathbf{d}_k \rightarrow \mathbf{d}_i} \mathbf{d}_i & \text{if } \sum_{\mathbf{d}_k \rightarrow \mathbf{d}_i} |\mathbf{d}_i| > \sum_{\mathbf{d}_j \rightarrow \mathbf{d}_k} |\mathbf{d}_j|, \\ -\mathbf{d}_k + \sum_{\mathbf{d}_j \rightarrow \mathbf{d}_k} \mathbf{d}_j & \text{otherwise,} \end{cases}$$

where the sums are taken over all arrows in Γ'_T which start, respectively end in the vertex \mathbf{d}_k . More precisely, we have

$$(13) \quad \mathbf{d}_k^* = -\mathbf{d}_k + \max \left\{ \sum_{\mathbf{d}_k \rightarrow \mathbf{d}_i} \mathbf{d}_i, \sum_{\mathbf{d}_j \rightarrow \mathbf{d}_k} \mathbf{d}_j \right\}$$

and we know that

$$(14) \quad \max \left\{ \sum_{\mathbf{d}_k \rightarrow \mathbf{d}_i} \mathbf{d}_i, \sum_{\mathbf{d}_j \rightarrow \mathbf{d}_k} \mathbf{d}_j \right\} = \text{Max} \left\{ \sum_{\mathbf{d}_k \rightarrow \mathbf{d}_i} \mathbf{d}_i, \sum_{\mathbf{d}_j \rightarrow \mathbf{d}_k} \mathbf{d}_j \right\}.$$

15.3. Example. Let M be a terminal KQ -module such that Γ_M is the quiver

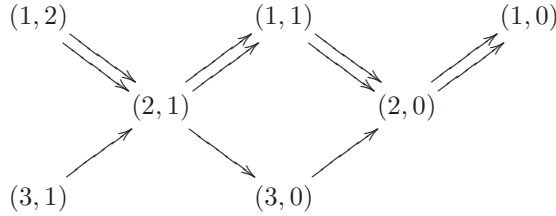

which appeared already in Section 3.5. Let $T_M = T_1 \oplus \dots \oplus T_7$. As always we assume without loss of generality that T_5, T_6, T_7 are \mathcal{C}_M -projective. The following picture shows the quiver Γ'_{T_M} . Its vertices are the dimension vectors of the $\text{End}_\Lambda(T_M)$ -modules $\text{Hom}_\Lambda(T_i, T_M)$. These dimension vectors can be constructed easily by standard calculations inside the mesh category of $\mathbb{N}Q^{\text{op}}$, see also Section 7.3. The dimension vectors associated to the indecomposable \mathcal{C}_M -projectives are labelled in red colour.

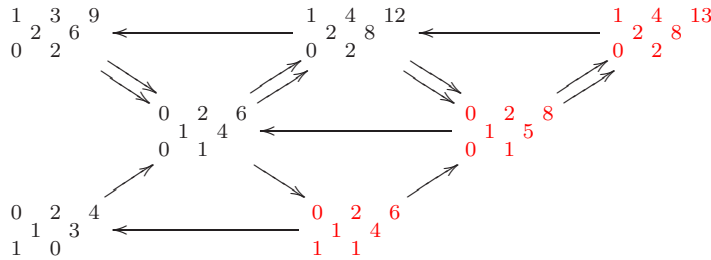

Compare this also to the example in Section 7.4.

Now let us mutate the Λ -module T_k where

$$\underline{\dim}(\text{Hom}_\Lambda(T_k, T_M)) = \begin{pmatrix} 1 & 4 & 12 \\ 2 & 2 & 8 \\ 0 & 2 & 2 \end{pmatrix}.$$

We have to look at all arrows starting and ending in the corresponding vertex of Γ'_{T_M} , and add up the entries of the attached dimension vectors, as explained in the previous section. Since

$$\left| \begin{pmatrix} 1 & 4 & 13 \\ 2 & 4 & 8 \\ 0 & 2 & 2 \end{pmatrix} \right| + 2 \cdot \left| \begin{pmatrix} 0 & 2 & 6 \\ 1 & 4 & 4 \\ 0 & 1 & 1 \end{pmatrix} \right| = 58 > 57 = \left| \begin{pmatrix} 1 & 3 & 9 \\ 2 & 2 & 6 \\ 0 & 2 & 2 \end{pmatrix} \right| + 2 \cdot \left| \begin{pmatrix} 0 & 2 & 8 \\ 1 & 5 & 8 \\ 0 & 1 & 1 \end{pmatrix} \right|,$$

we get

$$\underline{\dim}(\text{Hom}_\Lambda(T_k^*, T_M)) = \begin{pmatrix} 1 & 4 & 13 \\ 2 & 4 & 8 \\ 0 & 2 & 2 \end{pmatrix} + 2 \cdot \begin{pmatrix} 0 & 2 & 6 \\ 1 & 4 & 4 \\ 0 & 1 & 1 \end{pmatrix} - \begin{pmatrix} 1 & 3 & 9 \\ 2 & 2 & 8 \\ 0 & 2 & 2 \end{pmatrix} = \begin{pmatrix} 0 & 4 & 8 \\ 2 & 2 & 8 \\ 0 & 2 & 2 \end{pmatrix}$$

and the quiver $\Gamma'_{\mu_{T_k}(T_M)}$ looks as follows:

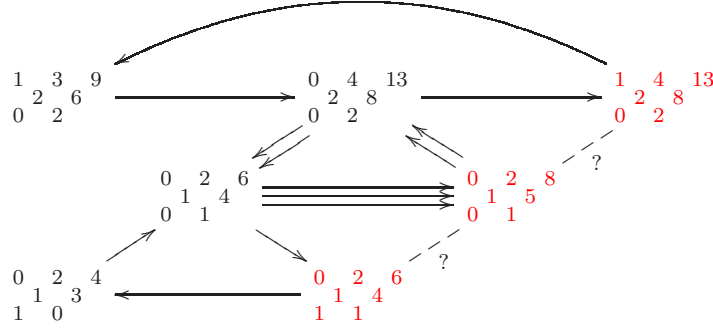

Note that we cannot control how the arrows between vertices corresponding to the three indecomposable \mathcal{C}_M -projectives behave under mutation. But this does not matter, because these arrows are not needed for the mutation of seeds and clusters. In the picture, we indicate the missing information by lines of the form $- - -$. This process can be iterated, and our theory says that each of the resulting dimension vectors determines uniquely a cluster variable.

15.4. Characterization of Q -split exact sequences. In this section, let $M = M_1 \oplus \cdots \oplus M_r$ be a terminal KQ -module. We need the following result.

Lemma 15.5. *Let $N_1, N_2 \in \text{add}(M)$. If $\dim \text{Hom}_{KQ}(N_1, M_i) = \dim \text{Hom}_{KQ}(N_2, M_i)$ for all $1 \leq i \leq r$, then $N_1 \cong N_2$.*

Proof. For $i = 1, 2$ we have $\text{Hom}_{KQ}(N_i, N) = 0$ for all indecomposable KQ -modules N with $N \notin \text{add}(M)$. It is a well known result by Auslander that for any finite-dimensional algebra A the numbers $\dim \text{Hom}_A(X, Z)$, where Z runs through all finite-dimensional indecomposable A -modules, determine a finite-dimensional A -module X uniquely up to isomorphism. Applying this to $X = N_i$ yields the result. \square

As before let $\pi_Q: \text{mod}(\Lambda) \rightarrow \text{mod}(KQ)$ be the restriction functor, which is obviously exact. Let

$$T_M = \bigoplus_{i=1}^n \bigoplus_{a=0}^{t_i} T_{i,a}$$

be the \mathcal{C}_M -complete rigid module we constructed before. Set $B := \text{End}_\Lambda(T_M)$.

We know that the contravariant functor $\text{Hom}_\Lambda(-, T_M)$ yields an embedding

$$\mathcal{C}_M \rightarrow \text{mod}(B).$$

If $X \in \mathcal{C}_M$, then the entries of the dimension vector $\underline{\dim}_B(\text{Hom}_\Lambda(X, T_M))$ are

$$\dim \text{Hom}_B(\text{Hom}_\Lambda(T_{i,a}, T_M), \text{Hom}_\Lambda(X, T_M)) = \dim \text{Hom}_{KQ}(\pi_Q(X), \tau^a(I_i))$$

where $1 \leq i \leq n$ and $0 \leq a \leq t_i$, compare Section 7.3. This together with Lemma 15.5 yields the following result:

Lemma 15.6. *For Λ -modules $X, Y \in \mathcal{C}_M$ the following are equivalent:*

- $\pi_Q(X) \cong \pi_Q(Y)$;
- $\underline{\dim}_B(\text{Hom}_\Lambda(X, T_M)) = \underline{\dim}_B(\text{Hom}_\Lambda(Y, T_M))$.

A short exact sequence $\eta: 0 \rightarrow X \rightarrow Y \rightarrow Z \rightarrow 0$ of Λ -modules is called *Q -split* if the short exact sequence $0 \rightarrow \pi_Q(X) \rightarrow \pi_Q(Y) \rightarrow \pi_Q(Z) \rightarrow 0$ splits.

Proposition 15.7. *For a short exact sequence $\eta: 0 \rightarrow X \rightarrow Y \rightarrow Z \rightarrow 0$ of Λ -modules in \mathcal{C}_M the following are equivalent:*

- η is F^{T_M} -exact;
- η is Q -split.

Proof. Clearly, η is F^{T_M} -exact if and only if

$$\underline{\dim}_B(\mathrm{Hom}_\Lambda(X, T_M)) + \underline{\dim}_B(\mathrm{Hom}_\Lambda(Z, T_M)) = \underline{\dim}_B(\mathrm{Hom}_\Lambda(Y, T_M)).$$

By Lemma 15.6 this is equivalent to $\pi_Q(X) \oplus \pi_Q(Z) \cong \pi_Q(Y)$. This is the case if and only if η is Q -split. \square

Proposition 15.7 singles out a distinguished class of short exact sequences of modules over preprojective algebras. We believe that these sequences are important and deserve much attention.

For each indecomposable direct summand $(I_{i,[a,t_i]}, e_{i,[a,t_i]})$ of T_M we know its projection to $\mathrm{mod}(KQ)$, namely

$$\pi_Q(I_{i,[a,t_i]}, e_{i,[a,t_i]}) = I_{i,[a,t_i]} = \bigoplus_{j=a}^{t_i} \tau^j(I_i).$$

Using the mesh category of \mathcal{I}_Q we can compute $\underline{\dim}_B(\mathrm{Hom}_\Lambda((I_{i,[a,t_i]}, e_{i,[a,t_i]}), T_M))$. Thus, combining Propositions 15.4 and 15.7 we can inductively determine the KQ -module $\pi_Q(R)$ for each cluster monomial δ_R in $\mathcal{R}(\mathcal{C}_M, T_M)$.

15.5. Example. Let Λ be of Dynkin type \mathbb{A}_3 . Then the short exact sequences

$$\eta': 0 \rightarrow 1 \xrightarrow{2} 3 \rightarrow 1 \xrightarrow{2} 3 \rightarrow 2 \rightarrow 0 \quad \text{and} \quad \eta'': 0 \rightarrow 2 \rightarrow 1 \xrightarrow{2} 3 \oplus 2 \rightarrow 1 \xrightarrow{2} 3 \rightarrow 0$$

are exchange sequences in $\mathrm{mod}(\Lambda)$. There are four Dynkin quivers of type \mathbb{A}_3 . In each case, we determine if η' or η'' is Q -split:

| Q | η' | η'' |
|---------------------------------|------------|------------|
| $1 \leftarrow 2 \leftarrow 3$ | - | Q -split |
| $1 \rightarrow 2 \rightarrow 3$ | - | Q -split |
| $1 \leftarrow 2 \rightarrow 3$ | - | Q -split |
| $1 \rightarrow 2 \leftarrow 3$ | Q -split | - |

16. THE ALGEBRA $\mathrm{End}_\Lambda(T_M)$ IS QUASI-HEREDITARY

16.1. The partial ordering of tilting modules. Let \mathcal{T}_A (resp. $\mathcal{T}_A^{\mathrm{cl}}$) be a set of representatives of isomorphism classes of all basic tilting modules (resp. basic classical tilting modules) over A .

For a tilting module $T \in \mathcal{T}_A$ let

$$T^\perp := \{Y \in \mathrm{mod}(A) \mid \mathrm{Ext}_A^i(T, Y) = 0 \text{ for all } i \geq 1\},$$

$${}^\perp T := \{X \in \mathrm{mod}(A) \mid \mathrm{Ext}_A^i(X, T) = 0 \text{ for all } i \geq 1\}.$$

From now on we use \perp only in this sense, so there is no danger of confusing it with the notation in Section 5.1.

For $R, T \in \mathcal{T}_A$ define $R \leq T$ if $R^\perp \subseteq T^\perp$. Thus (\mathcal{T}_A, \leq) and also $(\mathcal{T}_A^{\text{cl}}, \leq)$ become partially ordered sets. It follows that there is a unique maximal element, namely we have $T \leq {}_A A$ for all $T \in \mathcal{T}_A$. Minimal elements need not exist in general.

Riedtmann and Schofield [RS] define a quiver \mathcal{K}_A as follows: The vertices of \mathcal{K}_A are the elements in \mathcal{T}_A , and there is an arrow $T \rightarrow R$ if and only if the following hold:

- (i) $T = N \oplus X$ and $R = N \oplus Y$ with X and Y indecomposable and $X \not\cong Y$;
- (ii) There exists a short exact sequence

$$0 \rightarrow X \rightarrow N' \rightarrow Y \rightarrow 0$$

with $N' \in \text{add}(N)$.

In this case, we have $\text{Ext}_A^1(X, Y) = 0$. Here are some known facts:

- (a) If T and R are basic tilting modules satisfying (i), then there is an arrow $T \rightarrow R$ or $R \rightarrow T$ in \mathcal{K}_A ;
- (b) The quiver \mathcal{K}_A is the Hasse quiver of the partially order set (\mathcal{T}_A, \leq) , see [HU2];
- (c) If there is an arrow $T \rightarrow R$ in \mathcal{K}_A , then $R \leq T$ and $\text{proj. dim}(R) \geq \text{proj. dim}(T)$;
- (d) If $R \in T^\perp$, then $R \leq T$, see [HU1, Lemma 2.1, (a)] and [HU2, Proof of Theorem 2.1].

16.2. Quasi-hereditary algebras. Let A be a finite-dimensional algebra. By P_1, \dots, P_r and Q_1, \dots, Q_r and S_1, \dots, S_r we denote the indecomposable projective, indecomposable injective and simple A -modules, respectively, where $S_i = \text{top}(P_i) = \text{soc}(Q_i)$.

For a class \mathcal{U} of A -modules let $\mathcal{F}(\mathcal{U})$ be the class of all A -modules X which have a filtration

$$X = X_0 \supseteq X_1 \supseteq \dots \supseteq X_t = 0$$

of submodules such that all factors X_{j-1}/X_j belong to \mathcal{U} for all $1 \leq j \leq t$. Such a filtration is called a \mathcal{U} -filtration of X . We call these modules the \mathcal{U} -filtered modules.

Let Δ_i be the largest factor module of P_i in $\mathcal{F}(S_1, \dots, S_i)$, and set

$$\Delta = \{\Delta_1, \dots, \Delta_r\}.$$

The modules Δ_i are called *standard modules*. The algebra A is called *quasi-hereditary* if $\text{End}_A(\Delta_i) \cong K$ for all i , and if ${}_A A$ belongs to $\mathcal{F}(\Delta)$. Quasi-hereditary algebras first occurred in Cline, Parshall and Scott's [CPS] study of highest weight categories.

Note that the definition of a quasi-hereditary algebra depends on the chosen ordering of the simple modules. If we reorder them, it could happen that our algebra is no longer quasi-hereditary.

Now assume A is a quasi-hereditary algebra, and let $\mathcal{F}(\Delta)$ be the subcategory of Δ -filtered A -modules. For $X \in \mathcal{F}(\Delta)$ let $[X : \Delta_i]$ be the number of times that Δ_i occurs as a factor in a Δ -filtration of X . Then

$$\underline{\dim}_\Delta(X) = ([X : \Delta_1], \dots, [X : \Delta_r]) \in \mathbb{N}^r$$

is the Δ -dimension vector of X .

Let ∇_i be the largest submodule of Q_i in $\mathcal{F}(S_1, \dots, S_i)$, and let

$$\nabla = \{\nabla_1, \dots, \nabla_n\}.$$

The modules ∇_i are called *costandard modules*.

Let A be a quasi-hereditary algebra. The following results (and the missing definitions) can be found in [Ri3, Ri4]:

- (i) There is a unique (up to isomorphism) basic tilting module $T^{\Delta \cap \nabla}$ over A such that

$$\text{add}(T^{\Delta \cap \nabla}) = \mathcal{F}(\Delta) \cap \mathcal{F}(\nabla).$$
- (ii) We have $\mathcal{F}(\Delta) = {}^\perp(T^{\Delta \cap \nabla})$ and $\mathcal{F}(\nabla) = (T^{\Delta \cap \nabla})^\perp$.
- (iii) $\mathcal{F}(\Delta)$ is closed under extensions and under direct summands.
- (iv) $\mathcal{F}(\Delta)$ is a resolving and functorially finite subcategory of $\text{mod}(A)$.
- (v) $\mathcal{F}(\Delta)$ has Auslander-Reiten sequences.
- (vi) $[P_i : \Delta_j] = [\nabla_j : S_i]$ for all $1 \leq i, j \leq r$, where $[\nabla_j : S_i]$ is the Jordan-Hölder multiplicity of S_i in ∇_j .
- (vii) If $X \in \mathcal{F}(\Delta)$, then $[X : \Delta_i] = \dim \text{Hom}_A(X, \nabla_i)$ for all i .
- (viii) $\text{Hom}_A(\Delta_i, \Delta_j) = 0$ for all $i > j$.
- (ix) $\text{Ext}_A^1(\Delta_i, \Delta_j) = 0$ for all $i \geq j$.
- (x) The $\mathcal{F}(\Delta)$ -projective modules are the projective A -modules. The $\mathcal{F}(\nabla)$ -injective modules are the injective A -modules.
- (xi) The $\mathcal{F}(\Delta)$ -injective modules are the modules in $\text{add}(T^{\Delta \cap \nabla})$. The $\mathcal{F}(\nabla)$ -projective modules are the modules in $\text{add}(T^{\Delta \cap \nabla})$.
- (xii) If $\text{Ext}_A^1(X, \nabla_i) = 0$ for all i , then $X \in \mathcal{F}(\Delta)$. Similarly, if $\text{Ext}_A^1(\Delta_i, Y) = 0$ for all i , then $Y \in \mathcal{F}(\nabla)$.

The module $T^{\Delta \cap \nabla}$ is called the *characteristic tilting module* of A . In general, $T^{\Delta \cap \nabla}$ is not a classical tilting module. The endomorphism algebra $\text{End}_A(T^{\Delta \cap \nabla})$ is called the *Ringel dual* of A . It is again a quasi-hereditary algebra in a natural way, see [Ri3].

16.3. Γ_M -adapted orderings. Let $M = M_1 \oplus \cdots \oplus M_r$ be a terminal KQ -module. An ordering $x(1) < x(2) < \cdots < x(r)$ of the vertices of the quiver Γ_M is called Γ_M -adapted if the following hold: If there exists an oriented path from $x(j)$ to $x(i)$ in Γ_M we must have $j > i$. Such orderings always exist since Γ_M is a quiver without oriented cycles.

16.4. The algebra $\text{End}_\Lambda(T_M)$ is quasi-hereditary. As before, let $M = M_1 \oplus \cdots \oplus M_r$ be a terminal KQ -module, and let $t_i = t_i(M)$ for all $1 \leq i \leq r$. For brevity set

$$B := \text{End}_\Lambda(T_M).$$

Recall that there is an inclusion functor $\iota_Q: \text{mod}(KQ) \rightarrow \text{mod}(\Lambda)$ defined by $\iota_Q(X) = (X, 0)$. For every Λ -module (X, f) we have $\iota_Q(\pi_Q(X, f)) = (X, 0)$.

Assume that $x(1) < x(2) < \cdots < x(r)$ is a Γ_M -adapted ordering of the vertices of Γ_M , compare Section 22.4. Thus we get a bijection

$$v: \{x(1), \dots, x(r)\} \rightarrow \{M_1, \dots, M_r\}.$$

Set $M(x(i)) := v(x(i))$. It follows that $\text{Hom}_{KQ}(M(x(i)), M(x(j))) = 0$ if $i < j$.

For each $x(j)$ we have

$$M(x(j)) = \tau^a(I_i)$$

for some uniquely determined $1 \leq i \leq n$ and $0 \leq a \leq t_i$. Define

$$\begin{aligned} M_{i,a} &:= M(x(j)), \\ P_{x(j)} &:= P_{i,a} := \text{Hom}_\Lambda(T_{i,a}, T_M), \\ \Delta_{x(j)} &:= \Delta_{i,a} := \text{Hom}_\Lambda((M(x(j)), 0), T_M), \\ S_{x(j)} &:= S_{i,a} := \text{top}(P_{x(j)}). \end{aligned}$$

For the definition of $T_{i,a}$ we refer to Section 7.1. Recall that $P_{x(j)}$ is an indecomposable projective B -module, so its top $S_{x(j)}$ is simple. We get an ordering

$$S_{x(1)} < S_{x(2)} < \cdots < S_{x(r)}$$

of the simple B -modules.

Set

$$\Delta := \{\Delta_{x(1)}, \dots, \Delta_{x(r)}\}.$$

Lemma 16.1. *For each $x(j)$ the following hold:*

- (i) $\text{proj. dim}(\Delta_{x(j)}) \leq 1$;
- (ii) $\text{top}(\Delta_{x(j)}) \cong S_{x(j)}$;
- (iii) $\text{End}_B(\Delta_{x(j)}) \cong K$.

Proof. For $1 \leq i \leq n$ and $0 \leq a \leq t_i$ we get a Q -split short exact sequence

$$0 \rightarrow (\tau^a(I_i), 0) \rightarrow T_{i,a} \rightarrow T_{i,a+1} \rightarrow 0$$

of Λ -modules. This follows easily from the construction of $T_{i,a}$. Applying $\text{Hom}_\Lambda(-, T_M)$ yields a short exact sequence

$$(15) \quad 0 \rightarrow P_{i,a+1} \rightarrow P_{i,a} \rightarrow \Delta_{i,a} \rightarrow 0$$

of B -modules. Here we set $T_{i,t_i+1} = 0$ and $P_{i,t_i+1} = 0$. Clearly, the exact sequence (15) is a projective resolution of $\Delta_{i,a}$. Thus $\text{proj. dim}(\Delta_{i,a}) \leq 1$. Furthermore, $P_{i,a}$ is an indecomposable projective module and therefore has a simple top. It follows that $\text{top}(\Delta_{i,a}) \cong S_{i,a}$. Finally, we have

$$\text{End}_B(\Delta_{x(j)}) \cong \text{End}_\Lambda((M(x(j)), 0)) \cong \text{End}_{KQ}(M(x(j))) \cong K.$$

(The KQ -module $M(x(j))$ is indecomposable preinjective, and therefore its endomorphism ring is K .) \square

Lemma 16.2. *We have ${}_B B \in \mathcal{F}(\Delta)$.*

Proof. The short exact sequence (15) in the proof of Lemma 16.1 yields a filtration

$$0 = P_{i,t_i+1} \subset P_{i,t_i} \subset \cdots \subset P_{i,a+1} \subset P_{i,a}$$

such that $P_{i,k}/P_{i,k+1} \cong \Delta_{i,k}$ for all $a \leq k \leq t_i$. Since each indecomposable projective B -module is of the form $P_{i,a}$ for some i and a , this implies ${}_B B \in \mathcal{F}(\Delta)$. \square

Lemma 16.3. *A simple B -module $S_{x(i)}$ occurs with multiplicity*

$$[\Delta_{x(j)} : S_{x(i)}] = \dim \text{Hom}_{KQ}(M(x(j)), M(x(i)))$$

in every composition series of $\Delta_{x(j)}$.

Proof. Clearly, for each i and a we have

$$[\Delta_{x(j)} : S_{i,a}] = \dim \text{Hom}_B(\text{Hom}_\Lambda(T_{i,a}, T_M), \Delta_{x(j)}).$$

Then by the considerations in Section 7.3 we know that $S_{i,a}$ occurs

$$\dim \text{Hom}_{KQ}(M(x(j)), \tau^a(I_i))$$

times in every composition series of $\Delta_{x(j)}$. \square

Let $(X, f) \in \mathcal{C}_M$, and let

$$X = M(x(1))^{m_{x(1)}} \oplus \cdots \oplus M(x(r))^{m_{x(r)}}$$

be a direct sum decomposition of X into indecomposables. We assume that $X \neq 0$. Let k be minimal such that $m_{x(k)} > 0$. It follows that

$$\mathrm{Hom}_{KQ}(M(x(k)), \tau M(x(j))) = 0$$

for all j with $m_{x(j)} > 0$. For some direct summand $M(x(k))$ of X let $\iota: M(x(k)) \rightarrow X$ be the canonical inclusion map, and let $\pi: X \rightarrow X/M(x(k))$ be the corresponding projection. Furthermore, let $i: X/M(x(k)) \rightarrow X$ be the obvious inclusion.

We obtain a short exact sequence

$$(16) \quad \begin{array}{ccccccccc} 0 & \longrightarrow & M(x(k)) & \xrightarrow{\iota} & X & \xrightarrow{\pi} & X/M(x(k)) & \longrightarrow & 0 \\ \downarrow 0 & & \downarrow 0 & & \downarrow f & & \downarrow f' & & \downarrow 0 \\ \tau(0) & \longrightarrow & \tau(M(x(k))) & \xrightarrow{\tau(\iota)} & \tau(X) & \xrightarrow{\tau(\pi)} & \tau(X/M(x(k))) & \longrightarrow & \tau(0) \end{array}$$

of Λ -modules, where $f' = \tau(\pi) \circ f \circ i$. Clearly, the short exact sequence (16) is Q -split. It follows that it stays exact if we apply $\mathrm{Hom}_\Lambda(-, T_M)$.

For an algebra A let $\mathcal{P}_{\leq 1}(A)$ be the subcategory of all modules $X \in \mathrm{mod}(A)$ with $\mathrm{proj. dim}(X) \leq 1$.

The main result of this section is the following:

Theorem 16.4. *Let M be a terminal KQ -module. The following hold:*

(i) *The algebra $B := \mathrm{End}_\Lambda(T_M)$ is quasi-hereditary with standard modules*

$$\Delta = \{\Delta_{x(1)}, \dots, \Delta_{x(r)}\};$$

(ii) $\mathcal{F}(\Delta) = \mathrm{Hom}_\Lambda(\mathcal{C}_M, T_M)$;

(iii) $T^{\Delta \cap \nabla} = \mathrm{Hom}_\Lambda(T_M^\nabla, T_M)$;

(iv) $\mathcal{F}(\Delta) \subseteq \mathcal{P}_{\leq 1}(B)$.

Proof. (i): By Lemma 16.3 we know that $[\Delta_{x(j)} : S_{x(i)}] \neq 0$ implies $j \geq i$. Furthermore, we have $S_{i,a+1} > S_{i,a}$. Using this and the short exact sequence

$$0 \rightarrow P_{i,a+1} \rightarrow P_{i,a} \rightarrow \Delta_{i,a} \rightarrow 0$$

and the fact $\mathrm{top}(P_{i,a+1}) \cong S_{i,a+1}$, we get that $\Delta_{i,a}$ is the largest factor module of $P_{i,a}$ in $\mathcal{F}(\{S \mid S \leq S_{i,a}\})$ where S runs through the simple B -modules. By Lemma 16.2 we know that ${}_B B \in \mathcal{F}(\Delta)$. Now Lemma 16.1, (iii) yields that B is quasi-hereditary.

(ii): For $X, Z \in \mathcal{C}_M$ and we have a functorial isomorphism

$$\mathrm{Ext}_{F T_M}^1(Z, X) \rightarrow \mathrm{Ext}_B^1(\mathrm{Hom}_\Lambda(X, T_M), \mathrm{Hom}_\Lambda(Z, T_M)).$$

Thus the image of the functor

$$F := \mathrm{Hom}_\Lambda(-, T_M): \mathcal{C}_M \rightarrow \mathrm{mod}(B)$$

is extension closed. Clearly, for all $x(j)$ the standard module $\Delta_{x(j)}$ is in the image of F . It follows that $\mathcal{F}(\Delta) \subseteq \mathrm{Im}(F)$.

Using the short exact sequence (16) and induction on the number of indecomposable direct summands of X one shows that

$$\mathrm{Hom}_\Lambda((X, f), T_M) \in \mathcal{F}(\Delta)$$

for all $(X, f) \in \mathcal{C}_M$. Here one uses that $\mathcal{F}(\Delta)$ is closed under extensions. Thus $\text{Im}(F) \subseteq \mathcal{F}(\Delta)$.

(iii): Let $1 \leq i \leq n$ and $0 \leq b \leq t_i$. Recall that $T_{i,b}^\vee = (I_{i,[0,b]}, e_{i,[0,b]})$ and

$$T_M^\vee = \bigoplus_{i=1}^n \bigoplus_{b=0}^{t_i} T_{i,b}^\vee.$$

Thus $\text{Hom}_\Lambda(T_{i,b}^\vee, T_M) \in \mathcal{F}(\Delta)$. To prove that $\text{Hom}_\Lambda(T_{i,b}^\vee, T_M) \in \mathcal{F}(\nabla)$ we have to show that

$$\text{Ext}_B^1(\Delta_{x(j)}, \text{Hom}_\Lambda(T_{i,b}^\vee, T_M)) = 0$$

for all $x(j)$, compare Section 16.2, (xii). This is equivalent to showing that

$$\text{Ext}_{F^{T_M}}^1(T_{i,b}^\vee, (M(x(j)), 0)) = 0$$

for all $x(j)$. In other words, we have to show that every Q -split short exact sequence

$$(17) \quad 0 \rightarrow (M(x(j)), 0) \xrightarrow{f} E \rightarrow T_{i,b}^\vee \rightarrow 0$$

splits. Without loss of generality we can assume that

$$f = \begin{bmatrix} 1 \\ 0 \end{bmatrix} : M(x(j)) \rightarrow M(x(j)) \oplus I_{i,[0,b]}.$$

Let N be the terminal KQ -module defined by $t_k(N) = b$ for all $1 \leq k \leq n$. (If we are in the Dynkin case, it can happen that $\tau^b(I_j) = 0$ for some j . In this case, let $t_j(N)$ be the minimal l such that $\tau^l(I_j) \neq 0$.)

Case 1: If $M(x(j)) \in \text{add}(N)$, then $T_{i,b}^\vee = T_{i,0}$ is \mathcal{C}_M -projective-injective. Thus the sequence (17) splits.

Case 2: Assume that $M(x(j)) \notin \text{add}(N)$. This implies $\text{Hom}_{KQ}(I_{i,[0,b]}, \tau(M(x(j)))) = 0$. Since the sequence (17) is Q -split we know that E is isomorphic to $(M(x(j)) \oplus I_{i,[0,b]}, h)$ where h is of the form

$$h = \begin{pmatrix} 0 & h' \\ h'' & e_{i,[0,b]} \end{pmatrix} : M(x(j)) \oplus I_{i,[0,b]} \rightarrow \tau(M(x(j))) \oplus \tau(I_{i,[0,b]}).$$

It follows that $h'' = 0$, otherwise f would not yield a homomorphism in \mathcal{C}_M . We also have $h' = 0$, since $\text{Hom}_{KQ}(I_{i,[0,b]}, \tau(M(x(j)))) = 0$. This implies that the short exact sequence (17) splits.

So we proved that

$$\text{Hom}_\Lambda(T_M^\vee, T_M) \in \mathcal{F}(\Delta) \cap \mathcal{F}(\nabla).$$

Since T_M^\vee has the correct number of isomorphism classes of indecomposable direct summands, namely r , we know that $\text{Hom}_\Lambda(T_M^\vee, T_M) = T^{\Delta \cap \nabla}$. This finishes the proof of (iii).

(iv): This follows directly from Lemma 16.1, (i). \square

Corollary 16.5. *Let M be a terminal KQ -module. Then $\text{Hom}_\Lambda(-, T_M)$ yields an anti-equivalence*

$$\mathcal{C}_M \rightarrow \mathcal{F}(\Delta).$$

Proof. Combine Corollary 9.5, Lemma 9.11 and Theorem 16.4, (ii). \square

One can easily construct examples of the form $B = \text{End}_\Lambda(T_M)$ such that $\mathcal{F}(\Delta)$ is a proper subcategory of $\mathcal{P}_{\leq 1}(B)$, see Example 2 in Section 16.7.

Next, we describe the B -modules $\nabla_{i,a}$. By Section 16.2, (vi) and the proof of Lemma 16.2 we know that

$$[\nabla_{i,a} : S_{j,b}] = [P_{j,b} : \Delta_{i,a}] = \begin{cases} 1 & \text{if } i = j \text{ and } b \leq a \leq t_j, \\ 0 & \text{otherwise.} \end{cases}$$

Thus the B -modules $\nabla_{i,a}$ are very easy to describe, namely $\nabla_{i,a}$ is a serial B -module which has a unique composition series

$$0 = U_{i,a+1} \subset U_{i,a} \subset U_{i,a-1} \subset \cdots \subset U_{i,1} \subset U_{i,0} = \nabla_{i,a}$$

such that $U_{i,k}/U_{i,k+1} \cong S_{i,k}$ for all $0 \leq k \leq a$. In particular, we have

$$\text{top}(\nabla_{i,a}) \cong S_{i,0}.$$

There is no other indecomposable B -module U with $\underline{\dim}(U) = \underline{\dim}(\nabla_{i,a})$, since the support of $\nabla_{i,a}$ is a quiver of type \mathbb{A}_{a+1} .

It follows from the proof of Lemma 16.2 and Section 16.2, (ix) that each Δ -filtration of the indecomposable projective B -module $P_{i,a}$ is structured as follows:

$$\frac{\Delta_{i,a}}{\frac{\Delta_{i,a+1}}{\frac{\cdots}{\Delta_{i,t_i}}}}$$

(We just display the factors of the Δ -filtration of $P_{i,a}$.)

Next, let us analyse the structure of the characteristic tilting module

$$T^{\Delta \cap \nabla} = \bigoplus_{i=1}^n \bigoplus_{b=0}^{t_i} \text{Hom}_\Lambda(T_{i,b}^\vee, T_M)$$

in more detail: It follows easily from the definitions that for all $1 \leq i \leq n$ and $0 \leq b \leq t_i$ there is a Q -split short exact sequence

$$0 \rightarrow T_{i,b}^\vee \rightarrow T_{i,0} \rightarrow T_{i,b+1} \rightarrow 0$$

of Λ -modules. Applying $\text{Hom}_\Lambda(-, T_M)$ yields a short exact sequence

$$0 \rightarrow P_{i,b+1} \rightarrow P_{i,0} \rightarrow \text{Hom}_\Lambda(T_{i,b}^\vee, T_M) \rightarrow 0$$

of B -modules. (Again, we set $T_{i,t_i+1} = 0$ and $P_{i,t_i+1} = 0$.) It follows that each Δ -filtration of the B -module $\text{Hom}_\Lambda(T_{i,b}^\vee, T_M)$ has the following structure:

$$\frac{\Delta_{i,0}}{\frac{\Delta_{i,1}}{\frac{\cdots}{\Delta_{i,b}}}}$$

Thus, it is enough to know the structure of the $\mathcal{F}(\Delta)$ -projective-injective B -modules $P_{i,0} = \text{Hom}_\Lambda(T_{i,0}, T_M)$, in order to describe all indecomposable direct summands of ${}_B B$ and $T^{\Delta \cap \nabla}$.

Next, let Q_M^{op} be the full subquiver of Γ_{T_M} with vertices $T_{i,[t_i,t_i]}$ where $1 \leq i \leq n$. (For example, if $t_i = t_j$ for all i and j , then $Q_M^{\text{op}} \cong Q^{\text{op}}$.) Let M' be the terminal KQ_M^{op} -module defined by $t_i(M') = t_i(M)$ for all $1 \leq i \leq n$. Then one can check that

$$\text{End}_\Lambda(T_M^\vee)^{\text{op}} \cong \text{End}_\Lambda(T_{M'}).$$

Note that $\text{End}_\Lambda(T_M^\vee)^{\text{op}}$ is the endomorphism algebra of our characteristic tilting module $T^{\Delta \cap \nabla}$. In other words, $\text{End}_\Lambda(T_M^\vee)^{\text{op}}$ is the Ringel dual of $\text{End}_\Lambda(T_M)$. It follows that $\text{End}_\Lambda(T_M^\vee)^{\text{op}}$ (and therefore also $\text{End}_\Lambda(T_M^\vee)$) is again a quasi-hereditary algebra.

We conclude that $\text{End}_\Lambda(T_M)$ belongs to a rather special and interesting class of quasi-hereditary algebras:

- (a) The characteristic tilting module $T^{\Delta \cap \nabla}$ has projective dimension one.
- (b) Each indecomposable projective $\text{End}_\Lambda(T_M)$ -module and each indecomposable direct summand of $T^{\Delta \cap \nabla}$ is “ Δ -serial”, i.e. it has a unique Δ -filtration. In particular, its Δ -dimension vector has only entries 0 or 1.
- (c) All modules in ∇ are serial modules.

Lemma 16.6. *The characteristic tilting module $T^{\Delta \cap \nabla}$ is the unique minimal element in the poset $(\mathcal{T}_B^{\text{cl}} \cap \mathcal{F}(\Delta), \leq)$.*

Proof. Let $T \in \mathcal{T}_B^{\text{cl}} \cap \mathcal{F}(\Delta)$ with $T \leq T^{\Delta \cap \nabla}$. This implies $\text{Ext}_B^1(T^{\Delta \cap \nabla}, T) = 0$. By Section 16.2, (ii) we get

$$T \in \mathcal{F}(\Delta) \cap \mathcal{F}(\nabla) = \text{add}(T^{\Delta \cap \nabla}).$$

Therefore $T = T^{\Delta \cap \nabla}$. This shows that $T^{\Delta \cap \nabla}$ is a minimal element in $(\mathcal{T}_B^{\text{cl}} \cap \mathcal{F}(\Delta), \leq)$.

To show uniqueness, assume T is a minimal element in $(\mathcal{T}_B^{\text{cl}} \cap \mathcal{F}(\Delta), \leq)$. Since $T \in \mathcal{F}(\Delta)$ we know again by Section 16.2, (ii) that $T^{\Delta \cap \nabla} \in T^\perp$. Now Section 16.1, (d) yields that $T^{\Delta \cap \nabla} \leq T$. This implies $T = T^{\Delta \cap \nabla}$. \square

Lemma 16.7. *The modules $\text{Hom}_\Lambda(T_{i,0}, T_M)$, $1 \leq i \leq n$ are the indecomposable $\mathcal{F}(\Delta)$ -projective-injective modules.*

Proof. The modules $\text{Hom}_\Lambda(T_{i,0}, T_M)$ are the only indecomposable projective B -modules, which are direct summands of $T^{\Delta \cap \nabla}$. Therefore, by Section 16.2, (xi) we know that $\text{Hom}_\Lambda(T_{i,0}, T_M)$ is $\mathcal{F}(\Delta)$ -injective. Furthermore, any $\mathcal{F}(\Delta)$ -projective module is projective by Section 16.2, (x). This finishes the proof. \square

Corollary 16.8. *If T is a tilting module in $\mathcal{F}(\Delta)$, then T has a direct summand isomorphic to*

$$\bigoplus_{i=1}^n \text{Hom}_\Lambda(T_{i,0}, T_M).$$

It is straightforward to construct examples where the B -module $\text{Hom}_\Lambda(T_{i,0}, T_M)$ is not injective in $\text{mod}(B)$, see Example 2 in Section 16.7.

Conjecture 16.9. *The Hasse diagram of $(\mathcal{T}_B^{\text{cl}} \cap \mathcal{F}(\Delta), \leq)$ is connected.*

Lemma 16.10. *For a Λ -module $(X, f) \in \mathcal{C}_M$ the following hold:*

- (i) $[\text{Hom}_\Lambda((X, f), T_M) : \Delta_{x(j)}] = [\text{Hom}_\Lambda((X, 0), T_M) : \Delta_{x(j)}]$;
- (ii) $\underline{\dim}_\Delta(\text{Hom}_\Lambda((X, f), T_M)) = \underline{\dim}_\Delta(\text{Hom}_\Lambda((X, 0), T_M))$;
- (iii) $\underline{\dim}(\text{Hom}_\Lambda((X, f), T_M)) = \underline{\dim}(\text{Hom}_\Lambda((X, 0), T_M))$.

Proof. Using the short exact sequence (16) one shows by induction on the number of indecomposable direct summands of X that (i) holds. It follows from the definitions that (i) and (ii) are equivalent. Modules having the same Δ -dimension vector, also have the same dimension vectors, i.e. (ii) implies (iii). \square

16.5. **Examples of type \mathbb{A}_3 .** Every finite-dimensional algebra A with global dimension at most two is quasi-hereditary, i.e. one can find an ordering of the simple A -modules such that A becomes quasi-hereditary with respect to that ordering. If T is a \mathcal{C}_M -maximal rigid Λ -module, then $\text{gl. dim}(\text{End}_\Lambda(T)) = 3$. It seems to be difficult to determine when $\text{End}_\Lambda(T)$ is quasi-hereditary and when not.

Even if Q is a quiver of type \mathbb{A}_3 there are maximal rigid modules whose endomorphism algebra is not quasi-hereditary: Let T be the maximal rigid Λ -module

$${}^2_3 \oplus {}^1_2 {}^2_3 \oplus {}^1_2 \oplus {}^1_2 {}^2_3 \oplus {}^1_2 {}^2_3 \oplus {}^1_2 {}^3_1.$$

The quiver of $\text{End}_\Lambda(T)$ looks as follows:

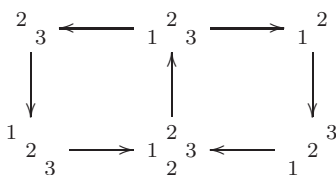

It is not difficult to show that $\text{End}_\Lambda(T)$ is not a quasi-hereditary algebra.

As another example (also in the type \mathbb{A}_3 case), let T be the maximal rigid Λ -module

$${}^2_3 \oplus {}^1_2 {}^2_3 \oplus 3 \oplus {}^1_2 {}^2_3 \oplus {}^1_2 {}^2_3 \oplus {}^1_2 {}^3_1.$$

The quiver of $\text{End}_\Lambda(T)$ looks as follows:

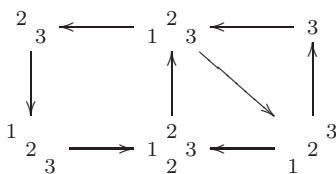

The algebra $\text{End}_\Lambda(T)$ can be equipped with the structure of a quasi-hereditary algebra. However, it turns out that for each of these structures, there are standard modules Δ_i with $\text{proj. dim}(\Delta_i) = 2$. Thus the image of the functor $\text{Hom}_\Lambda(-, T)$ does not coincide with the category $\mathcal{F}(\Delta)$ of Δ -filtered $\text{End}_\Lambda(T)$ -modules.

16.6. **An example of type \mathbb{A}_4 .** Let Q be the quiver

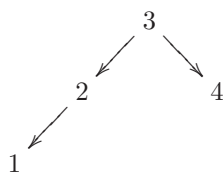

of Dynkin type \mathbb{A}_4 .

The Auslander-Reiten quiver $\text{AR}(KQ)$ of KQ looks as follows:

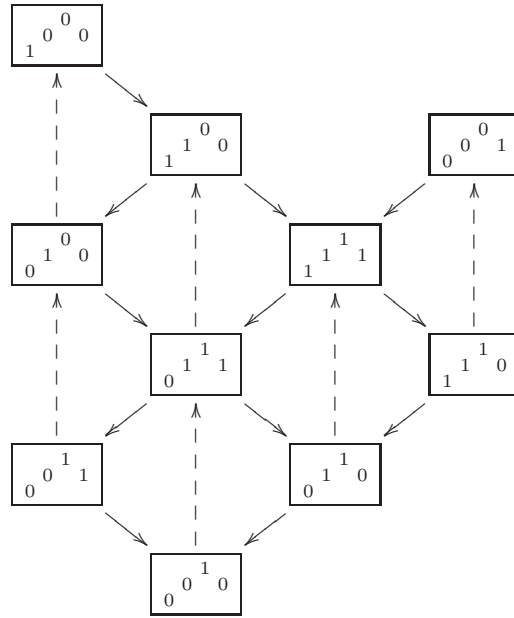

As usual, the solid arrows correspond to the irreducible maps between the indecomposable KQ -modules, and the dotted arrows describe the Auslander-Reiten translation in $\text{mod}(KQ)$.

Next, let $M(x(1)), \dots, M(x(10))$ be the 10 indecomposable KQ -modules labelled in such a way that $x(1) < x(2) < \dots < x(10)$ is a Γ_M -adapted ordering of the vertices of Γ_M , where M is just the direct sum of all indecomposable KQ -modules. For example,

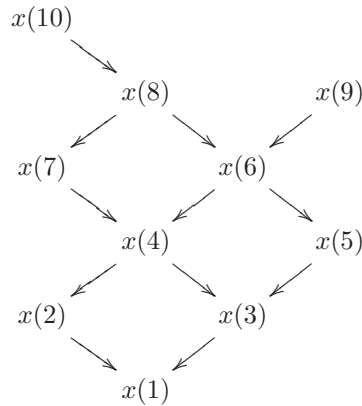

is such a labelling. This labelling of the indecomposable KQ -modules will be fixed for the rest of this section.

Now we replace the dotted arrows in $\text{AR}(KQ)$ by solid arrows, and for simplicity we label the vertices by i instead of $x(i)$. In this way we obtain the quiver $\Gamma_{TM} = \Gamma_M^*$ of the

algebra $\text{End}_\Lambda(T_M)$, where $M := M(x(1)) \oplus \dots \oplus M(x(10))$:

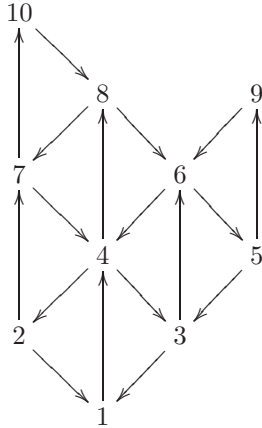

Note that $\text{End}_\Lambda(T_M)$ contains as a subalgebra the Auslander algebra of KQ (just delete the solid arrows which came from the dotted arrows of $\text{AR}(KQ)$).

For each vertex $x(i)$ of the quiver of $\text{End}_\Lambda(T_M)$ let $\Delta_{x(i)}$ be the associated standard module. It turns out that $\Delta_{x(i)}$ is just the indecomposable projective module over the Auslander algebra of KQ considered as an $\text{End}_\Lambda(T_M)$ -module.

For example, as a quiver representation the $\text{End}_\Lambda(T_M)$ -module $\Delta_{x(8)}$ looks as follows:

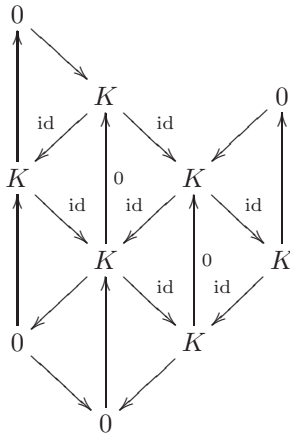

The arrows without a label are just zero maps. Another way of displaying this module would be

$$\begin{matrix} & 8 & & & \\ & 7 & 4 & 6 & 5 \\ & & & 3 & \\ & & & & \end{matrix}$$

The numbers correspond to composition factors. Here is a table of all the modules $\Delta_{x(i)}$ and $\nabla_{x(i)}$:

| | | | | | | | | | | |
|-----------------|---|--------------------------------------|-------------------------------------|--|---|--|---|--|---|--|
| $\Delta_{x(i)}$ | 1 | $\begin{matrix} 2 \\ 1 \end{matrix}$ | $\begin{matrix} 1 & 3 \end{matrix}$ | $\begin{matrix} 2 & 4 & 3 \\ 1 \end{matrix}$ | $\begin{matrix} 1 & 3 & 5 \end{matrix}$ | $\begin{matrix} 2 & 4 & 6 & 5 \\ 1 & 3 \end{matrix}$ | $\begin{matrix} 7 & 4 & 3 \end{matrix}$ | $\begin{matrix} 7 & 8 & 6 & 5 \\ 4 & 3 \end{matrix}$ | $\begin{matrix} 2 & 4 & 6 & 9 \end{matrix}$ | $\begin{matrix} 10 & 8 & 6 & 5 \end{matrix}$ |
| $\nabla_{x(i)}$ | 1 | 2 | 3 | $\begin{matrix} 1 \\ 4 \end{matrix}$ | 5 | $\begin{matrix} 3 \\ 6 \end{matrix}$ | $\begin{matrix} 2 \\ 7 \end{matrix}$ | $\begin{matrix} 1 \\ 4 \\ 8 \end{matrix}$ | 5 | $\begin{matrix} 2 \\ 7 \\ 10 \end{matrix}$ |

Here are pictures describing the structure of the indecomposable projective $\text{End}_\Lambda(T_M)$ -modules. The factors of a Δ -filtration of the modules $P_{x(i)}$ are marked by different colours.

The top $S_{x(i)}$ of a standard module $\Delta_{x(i)}$ is displayed as \boxed{i} . Note that $P_{x(8)} \subset P_{x(4)} \subset P_{x(1)}$, $P_{x(10)} \subset P_{x(7)} \subset P_{x(2)}$, $P_{x(6)} \subset P_{x(3)}$ and $P_{x(9)} \subset P_{x(5)}$.

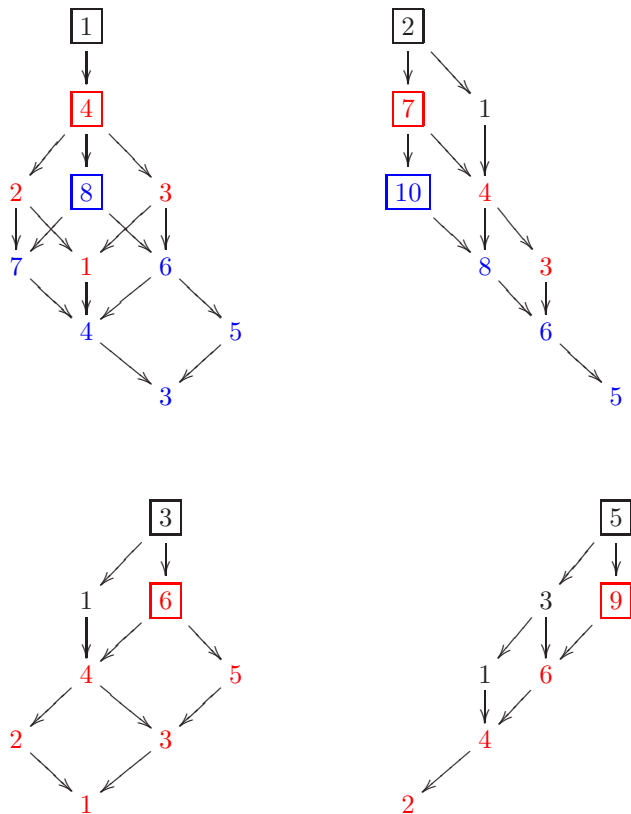

Next, we would like to construction T_M explicitly. First, observe that the Auslander-Reiten quiver $\text{AR}(KQ^{\text{op}})$ of KQ^{op} looks as follows:

$\text{AR}(KQ^{\text{op}})$:

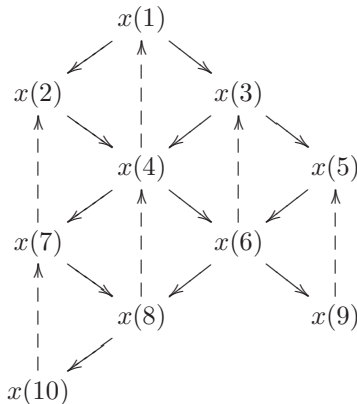

Q^{op} :

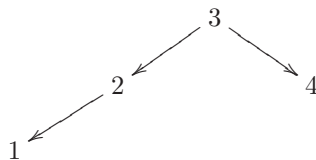

Again, we will just write i instead of $x(i)$.

Denote the Auslander algebra of KQ^{op} by C , and let $P(i)$, $1 \leq i \leq r$ be the indecomposable projective C -modules. Set

$$T_i := F_\lambda(P(i)) \quad \text{and} \quad T_M = T_1 \oplus \cdots \oplus T_r.$$

Here F_λ is the push-down functor $\text{mod}(\tilde{\Lambda}) \rightarrow \text{mod}(\Lambda)$ where $\tilde{\Lambda}$ is the obvious covering (with Galois group \mathbb{Z}) of Λ . We can consider C as a subalgebra of $\tilde{\Lambda}$, so the expression $F_\lambda(P(i))$ makes sense. The following table illustrates how the modules $P(i)$ and T_i look like:

| | | | | | | | | | | |
|--------|--|--|--|--|---|---|---|--|---|--|
| $P(i)$ | $\begin{matrix} & 1 & & & \\ & 2 & 3 & 5 & \\ & 4 & 6 & & \end{matrix}$ | $\begin{matrix} & 2 & & & \\ & 4 & 6 & 9 & \end{matrix}$ | $\begin{matrix} & 7 & 4 & 3 & 5 & \\ & 8 & 6 & & & \end{matrix}$ | $\begin{matrix} & 7 & 4 & 6 & 9 & \\ & 8 & & & & \end{matrix}$ | $\begin{matrix} & & & & 5 & \\ & & & & 8 & 6 & 9 & \\ & & & & 10 & & & \end{matrix}$ | $\begin{matrix} & & & & & & 6 & 9 & \\ & & & & & & 10 & & & \end{matrix}$ | $\begin{matrix} & & & & & & 7 & 8 & \end{matrix}$ | $\begin{matrix} & & & & & & & 8 & \\ & & & & & & & 10 & & \end{matrix}$ | $\begin{matrix} & & & & & & & & 9 & \end{matrix}$ | $\begin{matrix} & & & & & & & & & 10 \end{matrix}$ |
| T_i | $\begin{matrix} & 1 & 2 & 3 & 4 & \\ & 1 & 2 & 3 & & \\ & & 2 & 3 & 4 & \\ & & & 3 & & \end{matrix}$ | $\begin{matrix} & 1 & & & & \\ & 2 & 3 & 4 & & \\ & & 3 & & & \\ & & & 4 & & \end{matrix}$ | $\begin{matrix} & 1 & 2 & 3 & 4 & \\ & 1 & 2 & 3 & & \\ & & 2 & 3 & 4 & \\ & & & 3 & & \end{matrix}$ | $\begin{matrix} & 1 & 2 & 3 & 4 & \\ & 1 & 2 & 3 & & \\ & & 2 & 3 & 4 & \\ & & & 3 & & \end{matrix}$ | $\begin{matrix} & & & & 3 & 4 & \\ & & & & 1 & 2 & 3 & 4 & \\ & & & & 1 & 2 & 3 & & \end{matrix}$ | $\begin{matrix} & & & & & & 3 & 4 & \\ & & & & & & 1 & 2 & 3 & 4 & \\ & & & & & & 1 & 2 & 3 & & \end{matrix}$ | $\begin{matrix} & & & & & & 1 & 2 & \end{matrix}$ | $\begin{matrix} & & & & & & & 1 & 2 & \\ & & & & & & & 1 & & & \end{matrix}$ | $\begin{matrix} & & & & & & & & 4 & \end{matrix}$ | $\begin{matrix} & & & & & & & & & 1 \end{matrix}$ |

Note that Q could be identified with the full subquiver given by the vertices $\{10, 8, 6, 9\}$. Then one easily checks that the restriction of T_i to the full subquiver given by $\{10, 8, 6, 9\}$ is just the module $M(x(i))$.

16.7. **Examples of type \mathbb{D}_4 .** Let Q be the quiver

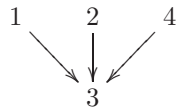

of Dynkin type \mathbb{D}_4 . The Auslander-Reiten quiver of KQ looks as follows:

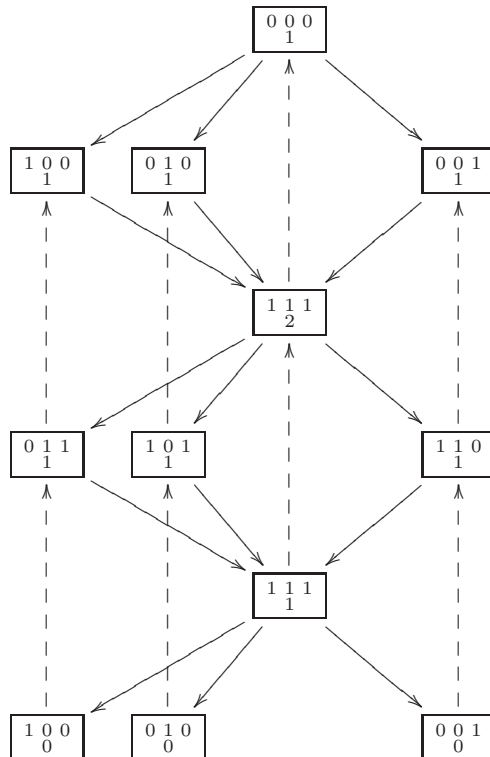

As before, we label the indecomposable KQ -modules $M(x(1)), \dots, M(x(12))$ such that $x(1) < x(2) < \dots < x(12)$ is a Γ_M -adapted ordering:

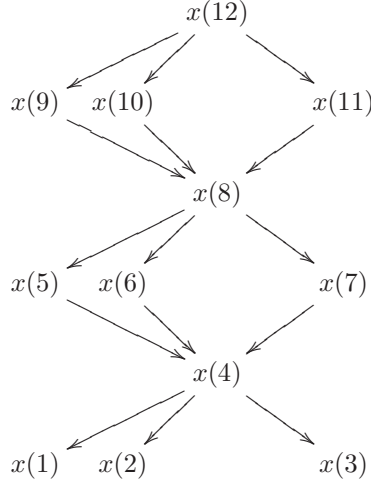

For simplicity we write again just i instead of $x(i)$.

Example 1: Let

$$M := \bigoplus_{i=1}^{12} M(x(i)).$$

The following picture describes the indecomposable projective $\text{End}_\Lambda(T_M)$ -modules $P_{x(1)}$ and $P_{x(4)}$. Up to symmetry, the projectives $P_{x(2)}$ and $P_{x(3)}$ look like $P_{x(1)}$. The factors of a Δ -filtration of each of these modules is highlighted by different colours.

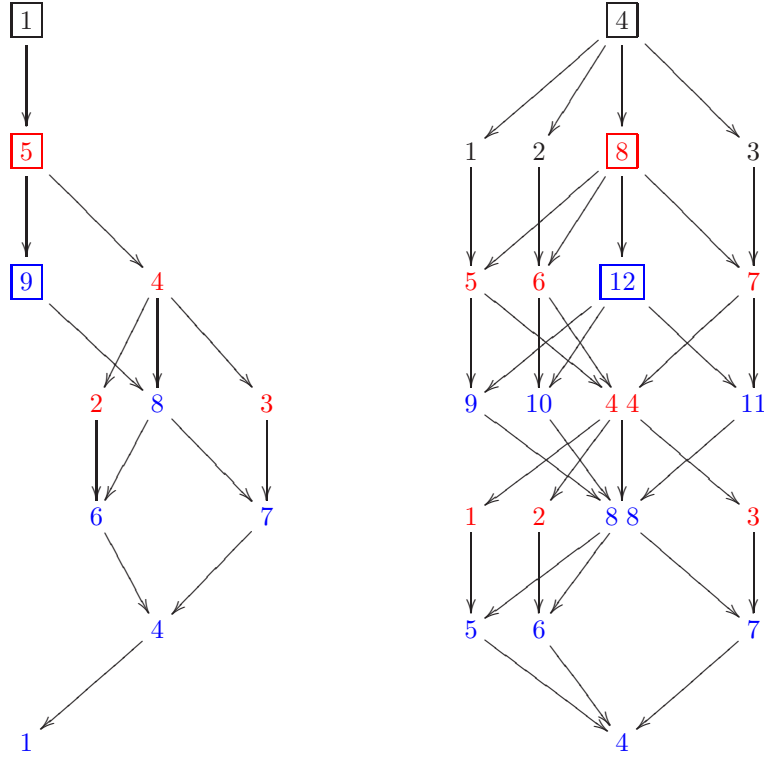

Note that

$$\underline{\dim}(P_{x(4)}) = (2, 2, 2, 4, 2, 2, 3, 1, 1, 1, 1).$$

Thus $\dim P_{x(4)} = 23$. We know that $P_{x(4)} \in \mathcal{F}(\Delta) \cap \mathcal{F}(\nabla)$. We leave it as an easy exercise to work out that $P_{x(4)}$ has a ∇ -filtration of the following structure:

$$\frac{\nabla_{12}}{\nabla_9 \oplus \nabla_{10} \oplus \nabla_{11}} \frac{\nabla_8 \oplus \nabla_8}{\nabla_5 \oplus \nabla_6 \oplus \nabla_7} \frac{\nabla_4}{\nabla_4}$$

Example 2: We keep the notation from above, but now we define

$$M := \bigoplus_{i=1}^8 M(x(i)).$$

Again, set $B := \text{End}_\Lambda(T_M)$. The following picture describes the indecomposable projective B -modules $P_{x(i)}$. The factors of a Δ -filtration are marked by different colours. Note that $P_{x(8)} \subset P_{x(4)}$, $P_{x(5)} \subset P_{x(1)}$, $P_{x(6)} \subset P_{x(2)}$ and $P_{x(7)} \subset P_{x(3)}$.

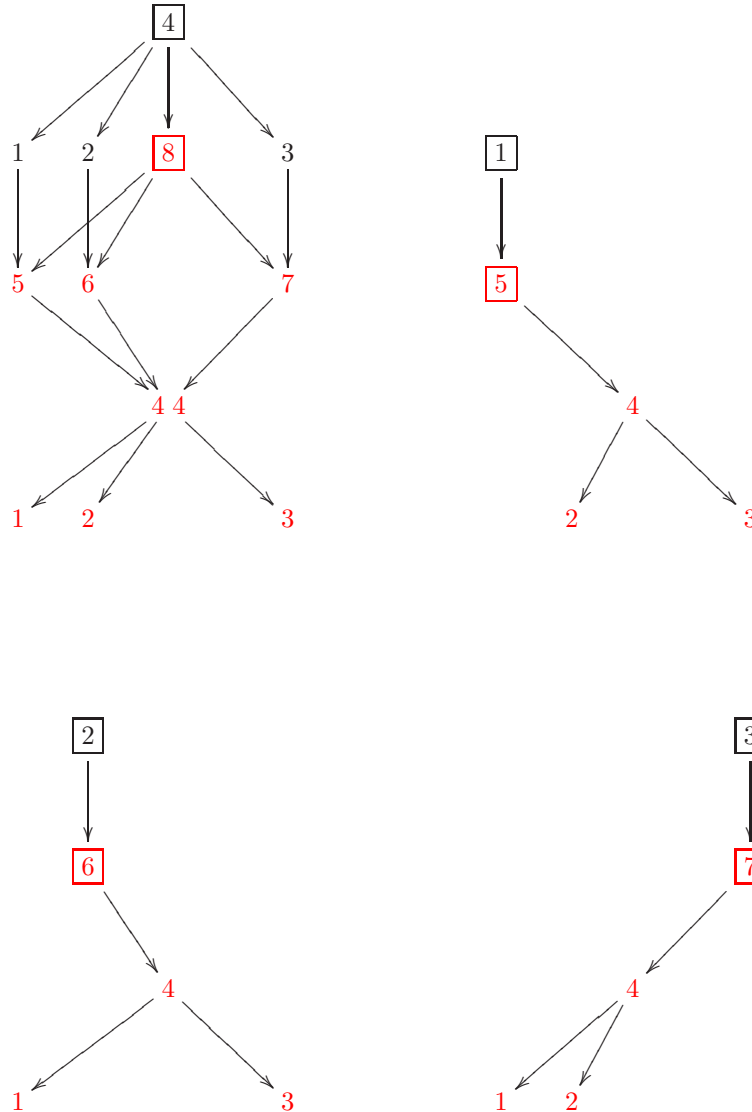

Note that none of the modules $P_{x(i)}$ has a simple socle. Thus there are no non-zero projective-injective B -modules.

This time there is a ∇ -filtration of $P_{x(4)}$ which is structured as follows:

$$\frac{\nabla_8}{\frac{\nabla_5 \oplus \nabla_6 \oplus \nabla_7}{\frac{\nabla_4 \oplus \nabla_4}{\nabla_1 \oplus \nabla_2 \oplus \nabla_3}}}$$

There is an obvious embedding $\iota: P_{x(1)} \rightarrow P_{x(4)}$ such that the cokernel Z of ι looks as follows:

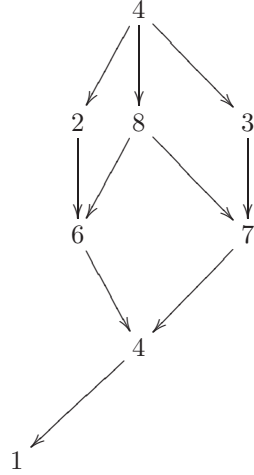

Thus we obtain a short exact sequence

$$0 \rightarrow P_{x(1)} \xrightarrow{\iota} P_{x(4)} \rightarrow Z \rightarrow 0.$$

This shows that $\text{proj. dim}(Z) \leq 1$.

Next, we apply $\text{Hom}_B(-, Z)$ to the short exact sequence above. Up to scalars there is only one homomorphism $f: P_{x(1)} \rightarrow Z$. (The image of f is the socle $S_{x(1)}$ of Z .) It is also obvious that f factors through ι , i.e. there exists a homomorphism $g: P_{x(4)} \rightarrow Z$ such that $g \circ \iota = f$. (The image of g is the unique 2-dimensional submodule of Z .) It follows that

$$\text{Hom}_B(P_{x(4)}, Z) \xrightarrow{\text{Hom}_B(\iota, Z)} \text{Hom}_B(P_{x(1)}, Z)$$

is surjective. Since $P_{x(4)}$ is projective, we have $\text{Ext}_B^1(P_{x(4)}, Z) = 0$. It follows that $\text{Ext}_B^1(Z, Z) = 0$.

It is also clear that Z does not lie in $\mathcal{F}(\Delta)$. (The top of Z is isomorphic to $S_{x(4)}$, so if $Z \in \mathcal{F}(\Delta)$, then $\Delta_{x(4)}$ has to be a factor module of Z , which is not the case.)

Taking the Bongartz completion of Z we obtain a classical tilting module in $\mathcal{T}_B^{\text{cl}}$ which is not contained in $\mathcal{F}(\Delta)$. In particular, $\mathcal{F}(\Delta)$ and $\mathcal{P}_{\leq 1}(B)$ do not coincide.

17. MUTATIONS OF CLUSTERS VIA Δ -DIMENSION VECTORS

For $\mathbf{d} = (d_1, \dots, d_r)$ and $\mathbf{e} = (e_1, \dots, e_r)$ in \mathbb{Z}^r define

$$\mathbf{d} \cdot \mathbf{e} := \sum_{i=1}^r d_i e_i.$$

Let $M = M_1 \oplus \cdots \oplus M_r$ be a terminal KQ -module, and let $x(1) < x(2) < \cdots < x(r)$ be a Γ_M -adapted ordering of the vertices of Γ_M . Set $B := \text{End}_\Lambda(T_M)$.

We know that the K -dimension of the standard module $\Delta_{x(i)}$ is

$$\begin{aligned} \dim \Delta_{x(i)} &= \dim \text{Hom}_\Lambda((M(x(i)), 0), T_M) \\ &= \sum_{j=1}^r \dim \text{Hom}_{KQ}(M(x(i)), M(x(j))) \\ &= \sum_{j=1}^i \dim \text{Hom}_{KQ}(M(x(i)), M(x(j))) \end{aligned}$$

for all i . So $\dim \Delta_{x(i)}$ can be calculated in the mesh category. Define

$$d_\Delta := (\dim \Delta_{x(1)}, \dots, \dim \Delta_{x(r)}).$$

As before, for a Λ -module $X \in \mathcal{C}_M$ let $\underline{\dim}_\Delta(\text{Hom}_\Lambda(X, T_M))$ be the Δ -dimension vector of the B -module $\text{Hom}_\Lambda(X, T_M)$.

Now let $T = T_1 \oplus \cdots \oplus T_r$ be a basic \mathcal{C}_M -maximal rigid Λ -module, and suppose that T_k is not \mathcal{C}_M -projective-injective. Then we can mutate T in direction T_k . We obtain two exchange sequences

$$0 \rightarrow T_k \rightarrow T' \rightarrow T_k^* \rightarrow 0 \quad \text{and} \quad 0 \rightarrow T_k^* \rightarrow T'' \rightarrow T_k \rightarrow 0$$

with $T', T'' \in \text{add}(T/T_k)$.

For brevity, set

$$\mathbf{d}_i := \underline{\dim}_\Delta(\text{Hom}_\Lambda(T_i, T_M))$$

for all $1 \leq i \leq r$. Similarly to the definition of Γ'_T in Section 15 let Γ''_T be the quiver which is obtained from the quiver of $\text{End}_\Lambda(T)$ by replacing the vertex corresponding to T_i by the Δ -dimension vector $\underline{\dim}_\Delta(\text{Hom}_\Lambda(T_i, T_M))$.

Proposition 17.1. *The Δ -dimension vector of the B -module $\text{Hom}_\Lambda(T_k^*, T_M)$ is*

$$\mathbf{d}_k^* := \begin{cases} -\mathbf{d}_k + \sum_{\mathbf{d}_k \rightarrow \mathbf{d}_i} \mathbf{d}_i & \text{if } \sum_{\mathbf{d}_k \rightarrow \mathbf{d}_i} \mathbf{d}_i \cdot d_\Delta > \sum_{\mathbf{d}_j \rightarrow \mathbf{d}_k} \mathbf{d}_j \cdot d_\Delta, \\ -\mathbf{d}_k + \sum_{\mathbf{d}_j \rightarrow \mathbf{d}_k} \mathbf{d}_j & \text{otherwise.} \end{cases}$$

Here the sums are taken over all arrows of the quiver of Γ''_T which start, respectively end in the vertex \mathbf{d}_k .

Proof. This follows immediately from our results in Section 15. □

In the example in Section 15.3, the graph Γ''_{T_M} looks as follows:

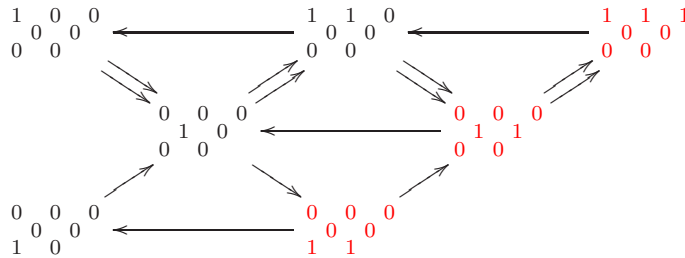

The Δ -dimension vectors associated to the indecomposable \mathcal{C}_M -projectives are labelled in red colour.

An easy calculation in the mesh category shows that

$$d_\Delta = \begin{matrix} 23 & 6 & 1 \\ 11 & 14 & 3 \\ & 4 & \end{matrix}.$$

Again, we mutate the Λ -module T_k where

$$\underline{\dim}_\Delta(\mathrm{Hom}_\Lambda(T_k, T_M)) = \begin{matrix} 1 & 1 & 0 \\ 0 & 0 & 0 \end{matrix}.$$

We get

$$\underline{\dim}_\Delta(\mathrm{Hom}_\Lambda(T_k^*, T_M)) = -\begin{matrix} 1 & 1 & 0 \\ 0 & 0 & 0 \end{matrix} + \begin{matrix} 1 & 1 & 0 \\ 0 & 2 & 0 \end{matrix} = \begin{matrix} 0 & 0 & 1 \\ 0 & 2 & 0 \end{matrix}$$

since

$$\begin{matrix} 1 & 1 & 0 \\ 0 & 0 & 0 \end{matrix} \cdot d_\Delta + 2 \cdot \begin{matrix} 0 & 0 & 0 \\ 0 & 1 & 0 \end{matrix} \cdot d_\Delta = 58 > 57 = \begin{matrix} 1 & 0 & 0 \\ 0 & 0 & 0 \end{matrix} \cdot d_\Delta + 2 \cdot \begin{matrix} 0 & 1 & 0 \\ 0 & 1 & 0 \end{matrix} \cdot d_\Delta.$$

In this easy example, the calculation of the above inequality was not necessary. Using Δ -dimension vectors one can see immediately that

$$-\begin{matrix} 1 & 1 & 0 \\ 0 & 0 & 0 \end{matrix} + \begin{matrix} 1 & 0 & 0 \\ 0 & 0 & 0 \end{matrix} + 2 \cdot \begin{matrix} 0 & 0 & 0 \\ 0 & 1 & 0 \end{matrix}$$

contains a negative entry, so the other option, namely taking the arrows in Γ_T'' ending in

$$\begin{matrix} 1 & 1 & 0 \\ 0 & 0 & 0 \end{matrix},$$

is the correct one.

This shows that in some situations it can be more convenient to calculate mutations using Δ -dimension vectors in contrast to using ordinary dimension vectors as in Section 15.

18. A SEQUENCE OF MUTATIONS FROM T_M TO T_M^\vee

18.1. The algorithm. Let $M = M_1 \oplus \cdots \oplus M_r$ be a terminal KQ -module, and (as before) let Q_M^{op} be the full subquiver of Γ_{T_M} with vertices $T_{i, [t_i, t_i]}$ where $1 \leq i \leq n$.

Without loss of generality we assume that the vertices $1, \dots, n$ of Q_M are numbered in such a way that 1 is a sink of Q_M and $k+1$ is a sink of the quiver

$$\sigma_k \cdots \sigma_2 \sigma_1(Q_M)$$

for all $1 \leq k \leq n-1$. We call $1 < 2 < \cdots < n$ a Q_M -adapted ordering of the vertices of Q_M . (If k is a vertex of a quiver Γ , then $\sigma_k(\Gamma)$ is the quiver obtained from Γ by reversing all arrows ending or starting at k . For brevity we just wrote i for the vertex $T_{i, [t_i, t_i]}$ of Q_M and Q_M^{op} .)

Now we describe an algorithm which will yield a directed path in the Hasse quiver of the partial ordering $\mathcal{T}_B^{\mathrm{cl}}$ from the (unique) maximal element T_M to the (unique) minimal element T_M^\vee . The proof is done by induction on the number $r-n$ of indecomposable non-injective direct summands of M . This is left as an exercise to the reader.

In the following, we just ignore the symbols of the form $T_{i, [a, b]}$ in case $a < 0$ or $b < 0$.

Step 1: We mutate the following

$$r_1 := \sum_{i=1}^n t_i$$

vertices of Γ_{T_M} in the given order:

$$\begin{aligned} & T_{1,[t_1,t_1]}, T_{1,[t_1-1,t_1]}, T_{1,[t_1-2,t_1]}, \dots, T_{1,[1,t_1]}, \\ & T_{2,[t_2,t_2]}, T_{2,[t_2-1,t_2]}, T_{2,[t_2-2,t_2]}, \dots, T_{2,[1,t_2]}, \\ & \dots \\ & T_{n,[t_n,t_n]}, T_{n,[t_n-1,t_n]}, T_{n,[t_n-2,t_n]}, \dots, T_{n,[1,t_n]} \end{aligned}$$

We obtain a new quiver $\Gamma_{T_M}^1$ with r_1 new vertices

$$\begin{aligned} & T_{1,[t_1-1,t_1-1]}, T_{1,[t_1-2,t_1-1]}, T_{1,[t_1-3,t_1-1]}, \dots, T_{1,[0,t_1-1]}, \\ & T_{2,[t_2-1,t_2-1]}, T_{2,[t_2-2,t_2-1]}, T_{2,[t_2-3,t_2-1]}, \dots, T_{2,[0,t_2-1]}, \\ & \dots \\ & T_{n,[t_n-1,t_n-1]}, T_{n,[t_n-2,t_n-1]}, T_{n,[t_n-3,t_n-1]}, \dots, T_{n,[0,t_n-1]} \end{aligned}$$

Step 2: We mutate the following

$$r_2 := \sum_{i=1}^n \max\{0, t_i - 1\}$$

vertices of $\Gamma_{T_M}^1$ in the following order:

$$\begin{aligned} & T_{1,[t_1-1,t_1-1]}, T_{1,[t_1-2,t_1-1]}, T_{1,[t_1-3,t_1-1]}, \dots, T_{1,[1,t_1-1]}, \\ & T_{2,[t_2-1,t_2-1]}, T_{2,[t_2-2,t_2-1]}, T_{2,[t_2-3,t_2-1]}, \dots, T_{2,[1,t_2-1]}, \\ & \dots \\ & T_{n,[t_n-1,t_n-1]}, T_{n,[t_n-2,t_n-1]}, T_{n,[t_n-3,t_n-1]}, \dots, T_{n,[1,t_n-1]} \end{aligned}$$

We obtain a new quiver $\Gamma_{T_M}^2$ with r_2 new vertices

$$\begin{aligned} & T_{1,[t_1-2,t_1-2]}, T_{1,[t_1-3,t_1-2]}, T_{1,[t_1-4,t_1-2]}, \dots, T_{1,[0,t_1-2]}, \\ & T_{2,[t_2-2,t_2-2]}, T_{2,[t_2-3,t_2-2]}, T_{2,[t_2-4,t_2-2]}, \dots, T_{2,[0,t_2-2]}, \\ & \dots \\ & T_{n,[t_n-2,t_n-2]}, T_{n,[t_n-3,t_n-2]}, T_{n,[t_n-4,t_n-2]}, \dots, T_{n,[0,t_n-2]} \end{aligned}$$

Step k: We mutate the following

$$r_k := \sum_{i=1}^n \max\{0, t_i - (k-1)\}$$

vertices of $\Gamma_{T_M}^{k-1}$ in the following order:

$$\begin{aligned} & T_{1,[t_1-(k-1),t_1-(k-1)]}, T_{1,[t_1-k,t_1-(k-1)]}, T_{1,[t_1-(k+1),t_1-(k-1)]}, \dots, T_{1,[1,t_1-(k-1)]}, \\ & T_{2,[t_2-(k-1),t_2-(k-1)]}, T_{2,[t_2-k,t_2-(k-1)]}, T_{2,[t_2-(k+1),t_2-(k-1)]}, \dots, T_{2,[1,t_2-(k-1)]}, \\ & \dots \\ & T_{n,[t_n-(k-1),t_n-(k-1)]}, T_{n,[t_n-k,t_n-(k-1)]}, T_{n,[t_n-(k+1),t_n-(k-1)]}, \dots, T_{n,[1,t_n-(k-1)]} \end{aligned}$$

We obtain a new quiver $\Gamma_{T_M}^k$ with r_k new vertices

$$\begin{aligned} & T_{1,[t_1-k,t_1-k]}, T_{1,[t_1-(k+1),t_1-k]}, T_{1,[t_1-(k+2),t_1-k]}, \dots, T_{1,[0,t_1-k]}, \\ & T_{2,[t_2-k,t_2-k]}, T_{2,[t_2-(k+1),t_2-k]}, T_{2,[t_2-(k+2),t_2-k]}, \dots, T_{2,[0,t_2-k]}, \\ & \dots \\ & T_{n,[t_n-k,t_n-k]}, T_{n,[t_n-(k+2),t_n-k]}, T_{n,[t_n-(k+3),t_n-k]}, \dots, T_{n,[0,t_n-k]} \end{aligned}$$

The algorithm stops when all vertices are of the form $T_{i,[0,b]}$ where $1 \leq i \leq n$ and $0 \leq b \leq t_i$. This will happen after

$$r(M) := \sum_{i=1}^n \frac{t_i(t_i + 1)}{2}$$

mutations.

As an example, assume Q is a Dynkin quiver of type \mathbb{E}_8 , and let M be the direct sum of all 120 indecomposable KQ -modules. In this case, we get $t_i = 14$ for all 8 vertices i of Q . Then our algorithm says that starting with T_M we can reach T_M^\vee after $r(M) = 8 \cdot 105 = 840$ mutations.

Note that if we start with our initial maximal rigid module T_M , and if we only perform the $r(M)$ mutations described in the algorithm, then we obtain the subset

$$\{T_{i,[a,b]} \mid 1 \leq i \leq n, 0 \leq a \leq b \leq t_i\}$$

of the set of indecomposable rigid modules of \mathcal{C}_M . In particular, this subset contains all modules $(M_i, 0)$ where $1 \leq i \leq r$, namely

$$\{(M_i, 0) \mid 1 \leq i \leq r\} = \{T_{l,[c,c]} \mid 1 \leq l \leq n, 0 \leq c \leq t_l\}.$$

It follows that a given rigid module of \mathcal{C}_M has at most n indecomposable direct summands of the form $(M_i, 0)$. (Otherwise we would get a rigid $\mathbb{C}Q$ -module with more than n isomorphism classes of indecomposable direct summands, and this is not possible.)

18.2. Generalized determinantal identities. Recall from Section 3.3 the definition of δ_X for $X \in \text{nil}(\Lambda)$. The known multiplicative properties of these functions are reviewed below in Theorem 19.7. In view of these properties, the previous explicit sequence of mutations from T_M to T_M^\vee yields an interesting family of identities satisfied by the $\delta_{T_{i,[c,d]}}$. To avoid cumbersome notation, in the following theorem, for Λ -modules X and Y we write $X \cdot Y$ instead of $\delta_X \cdot \delta_Y$. If $c > d$, then set $T_{i,[c,d]} := 1$.

Theorem 18.1 (Generalized determinantal identities). *Let $M = M_1 \oplus \cdots \oplus M_r$ be a terminal KQ -module. Then for $1 \leq i \leq n$ and $1 \leq a \leq b \leq t_i$ we have*

$$(18) \quad T_{i,[a-1,b]} \cdot T_{i,[a,b-1]} = T_{i,[a,b]} \cdot T_{i,[a-1,b-1]} - \prod_{i \rightarrow j} T_{j,[a+(t_j-t_i),b+(t_j-t_i)]} \prod_{k \rightarrow i} T_{k,[a-1+(t_k-t_i),b-1+(t_k-t_i)]}$$

where the products are taken over all arrows of the quiver Q_M^{op} which start and end in i , respectively.

Proof. This follows immediately from Theorem 19.7 and the algorithm described in Section 18.1. Formula (18) is just an exchange relation corresponding to the mutation of $T_{i,[a,b]}$ with $T_{i,[a,b]}^* = T_{i,[a-1,b-1]}$. \square

If M is a terminal KQ -module such that all t_i 's are equal to a fixed t , then the formula in Theorem 18.1 simplifies as follows:

$$(19) \quad T_{i,[a-1,b]} \cdot T_{i,[a,b-1]} = T_{i,[a,b]} \cdot T_{i,[a-1,b-1]} - \prod_{i \rightarrow j} T_{j,[a,b]} \prod_{k \rightarrow i} T_{k,[a-1,b-1]}$$

where the products are taken over all arrows of the quiver $Q_M^{\text{op}} = Q^{\text{op}}$, which start and end in i , respectively.

Remark 18.2. Fomin and Zelevinsky [FZ1, Theorem 1.17] prove generalized determinantal identities associated to pairs of Weyl group elements for all Dynkin cases (including the non-simply laced cases). Using the material of Sections 22.3, 22.4 below, the formula (18) can be seen as a generalization of some of their identities to the symmetric Kac-Moody case.

Note that the intervals appearing on the right hand side of Formula (18) all have length $b - a + 1$. On the left hand side we have the interval $[a - 1, b]$ of length $b - a + 2$ and the interval $[a, b - 1]$ of length $b - a$. Thus we obtain a recursive description of any $\delta_{T_{i,[a,b]}}$ in terms of the $\delta_{T_{i,[c,c]}}$. This shows that every $\delta_{T_{i,[a,b]}}$ is a rational function of the $\delta_{T_{i,[c,c]}}$. Recall that each $\delta_{T_{i,[c,c]}}$ is of the form $\delta_{(M_i,0)}$ for some i .

In fact, we will show that for any Λ -module $X \in \mathcal{C}_M$ we have $\delta_X \in \mathbb{C}[\delta_{(M_1,0)}, \dots, \delta_{(M_r,0)}]$, see Theorem 20.1. In particular, for all $1 \leq i \leq n$ and $0 \leq a \leq b \leq t_i$ the rational function $\delta_{T_{i,[a,b]}}$ is a polynomial in $\delta_{(M_1,0)}, \dots, \delta_{(M_r,0)}$.

Another proof of the polynomiality of the $\delta_{T_{i,[a,b]}}$ was found by Kedem and Di Francesco [DFK], using ideas of Fomin and Zelevinsky (in particular [BFZ, Lemma 4.2]). We thank these four mathematicians for communicating their insights to us at MSRI in March 2008.

18.3. **Examples.** Let Q be the quiver

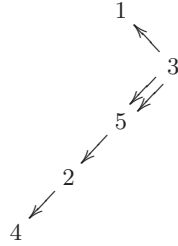

Let M be the terminal KQ -module with $t_1 = t_3 = 3$, $t_2 = t_5 = 2$ and $t_4 = 1$. In the following we just write $i,[a,b]$ instead of $T_{i,[a,b]}$. Then the quiver Γ_{T_M} of $\text{End}_\Lambda(T_M)$ looks as follows:

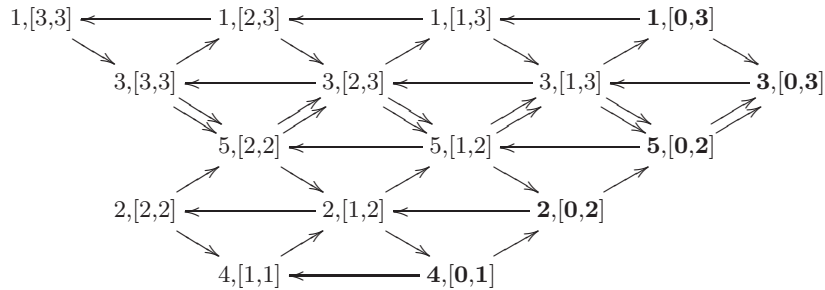

Clearly, Q_M^{op} looks like this:



(Note that we have chosen the numbering of the vertices of Q in such a way that the ordering of the vertices of Q_M is Q_M -adapted.)

Starting at Γ_{T_M} , it takes 19 mutations to reach the quiver of $\text{End}_\Lambda(T_M^\vee)$. In the following pictures we perform sometimes two mutations at the same time, in case these mutations do not affect each other. The vertices we are going to mutate are marked in different colours.

Step 1:

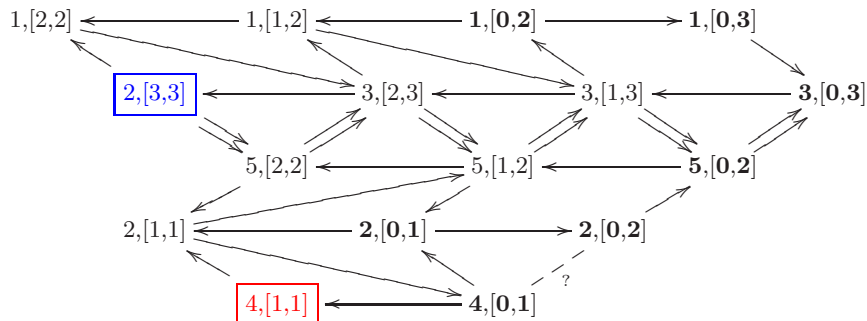
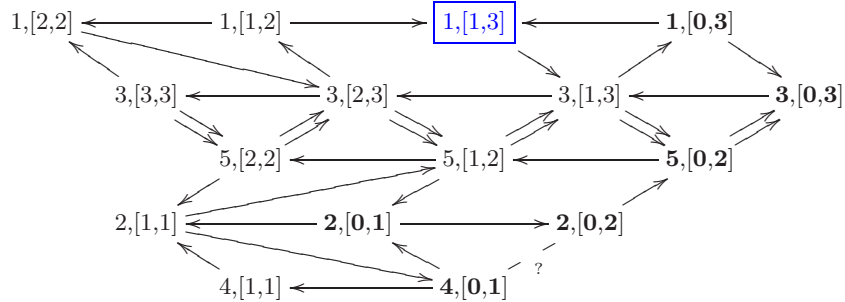
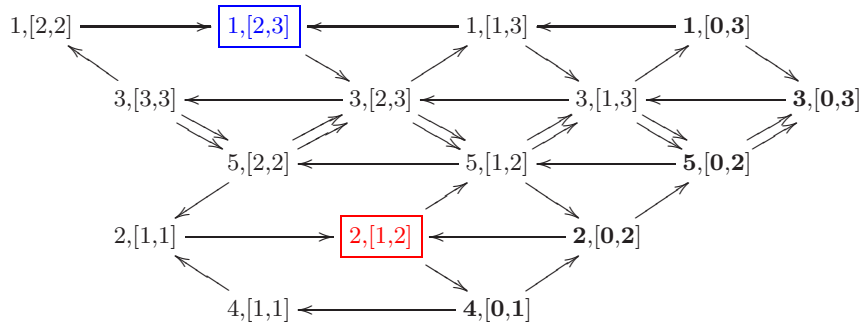
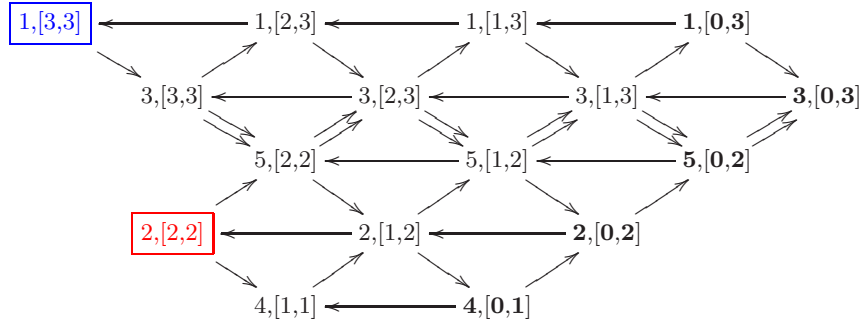

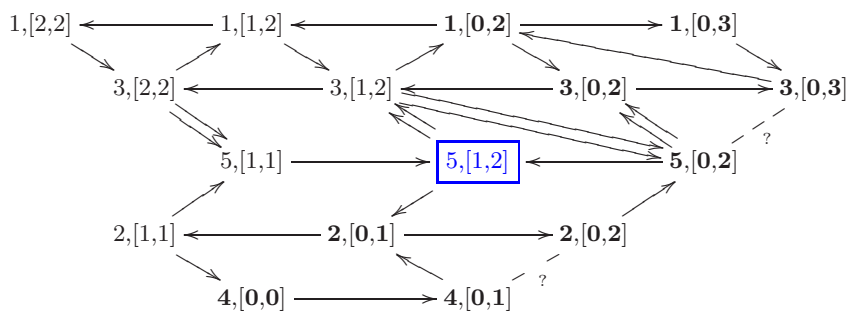
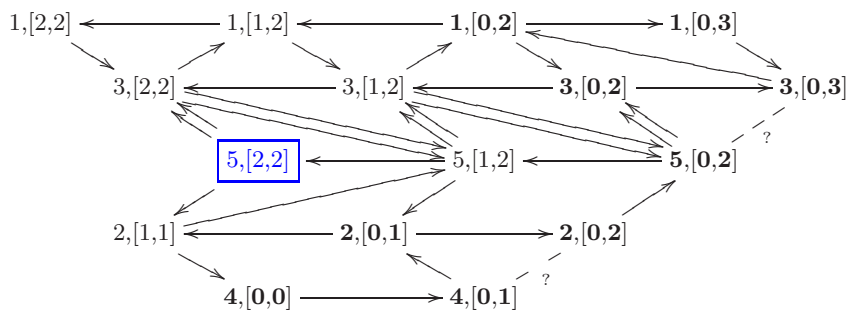
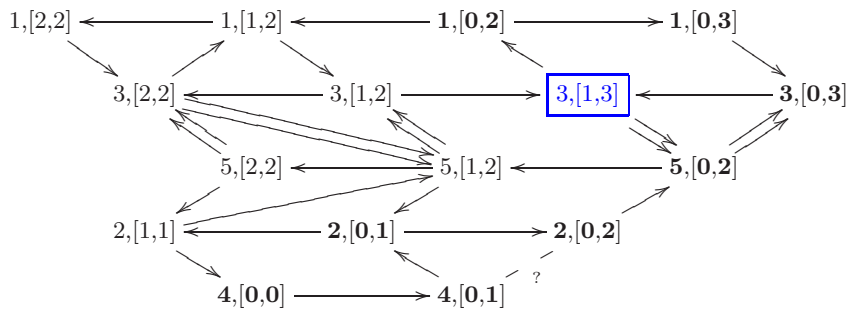
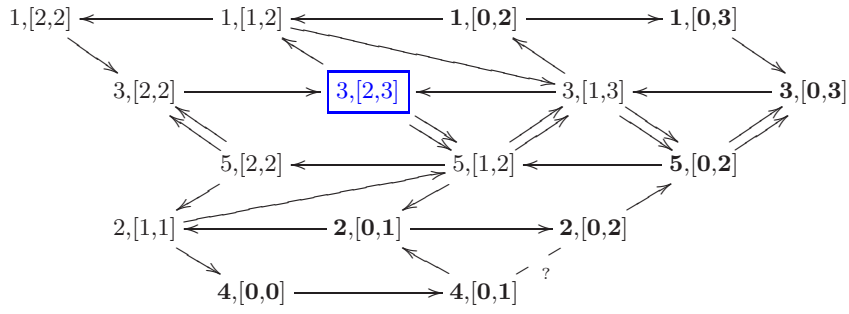

Step 2:

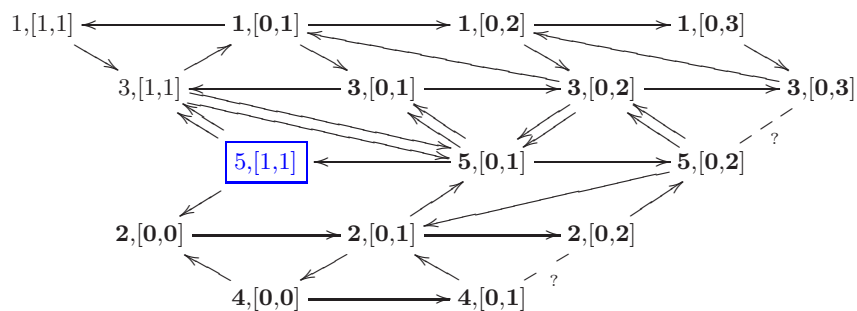
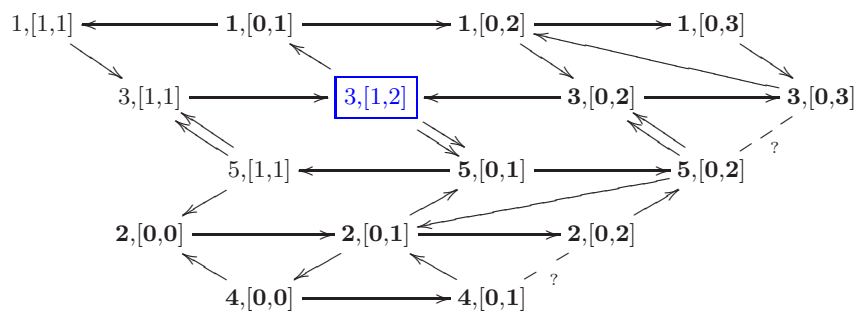
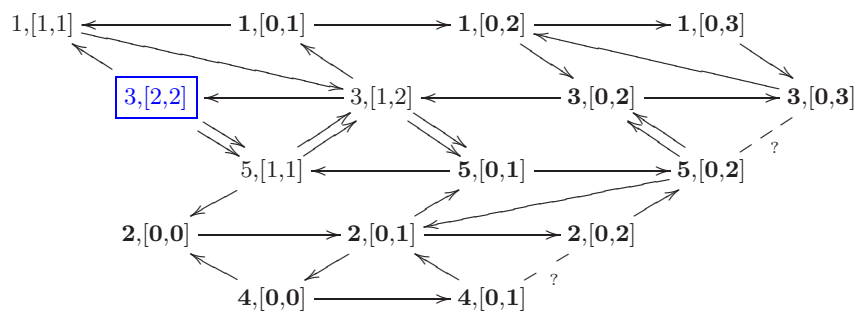
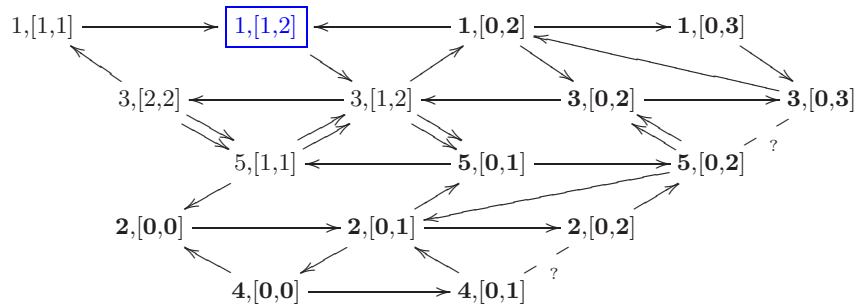
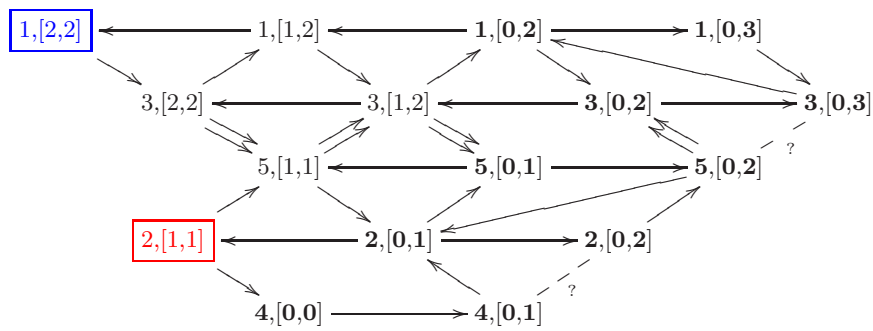

Step 3:

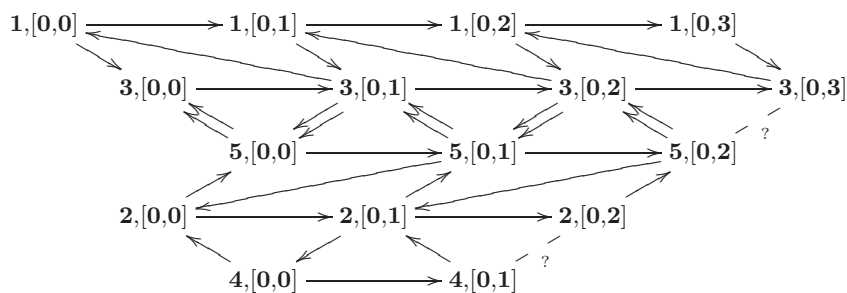
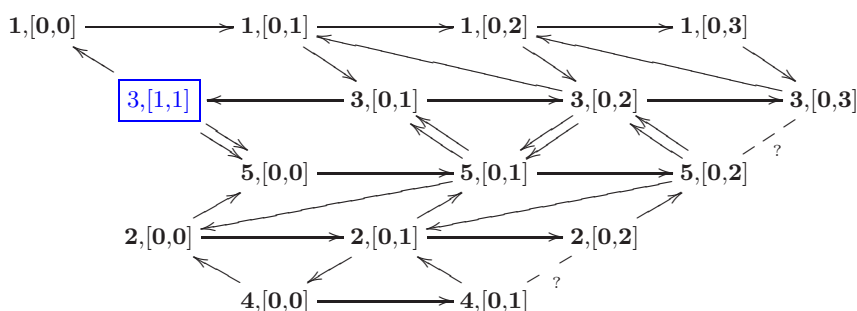
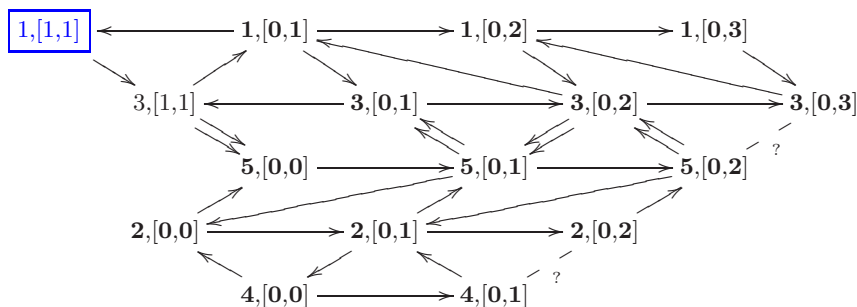

We finally arrived at a quiver whose vertices correspond to the indecomposable direct summands of T_M^\vee . Since we know how the quiver of $\text{End}_\Lambda(T_M^\vee)$ looks like, we also obtain the missing arrows marked by $- - -$. Namely we have an arrow $3,[0,3] \implies 5,[0,2]$ and two arrows $2,[0,2] \implies 4,[0,1]$.

Next, we discuss another example, which illustrates why we call the formula in Theorem 18.1 a generalized determinantal identity. This time we will display explicitly the Λ -modules occurring in our sequence of mutations from T_M to T_M^\vee . Let Q be the quiver

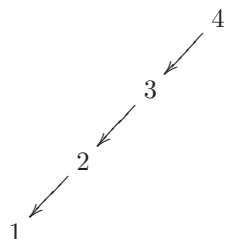

The Auslander-Reiten quiver of $\mathbb{C}Q$ is:

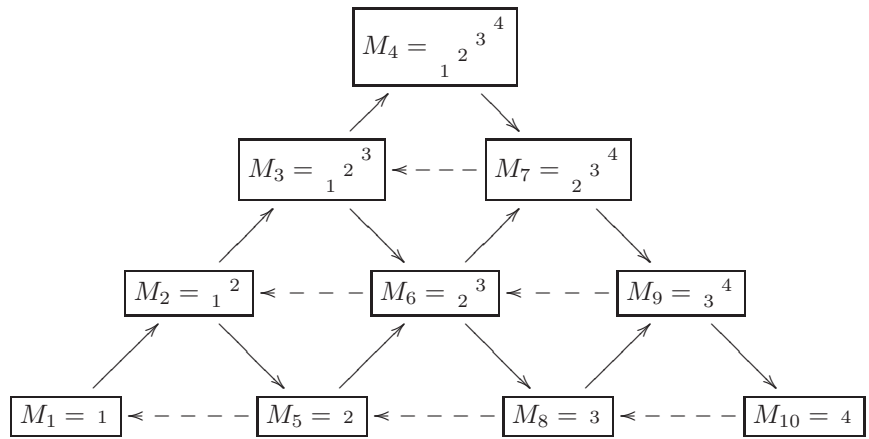

Let us display a sequence of mutations from T_M to T_M^\vee :

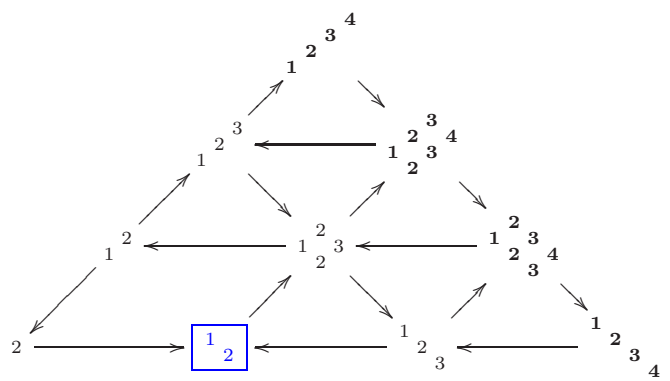
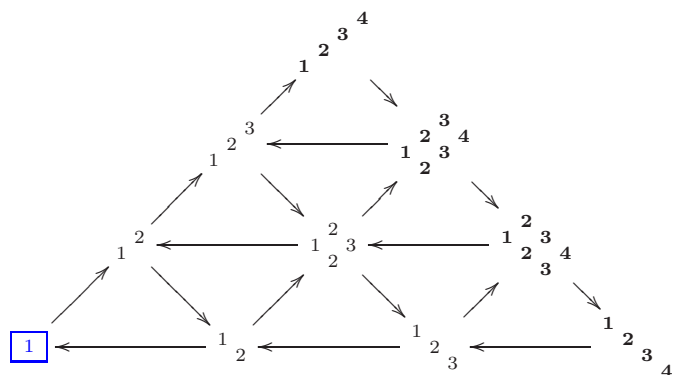

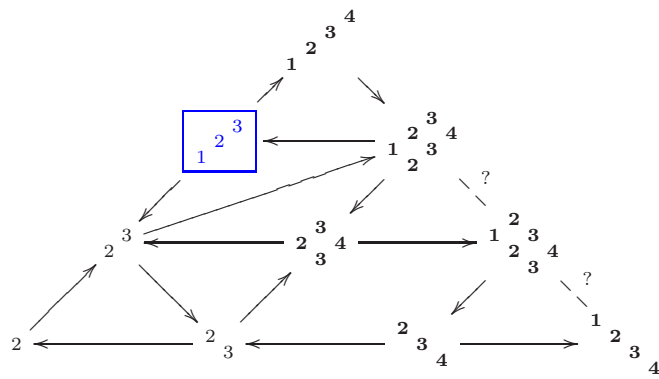
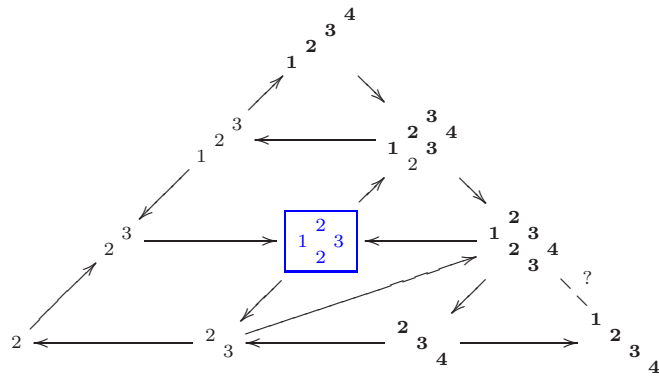
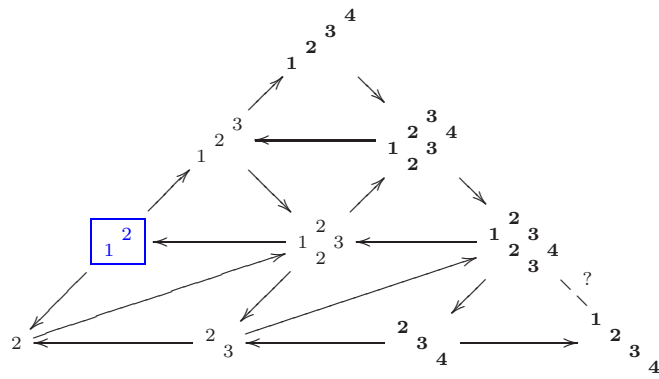
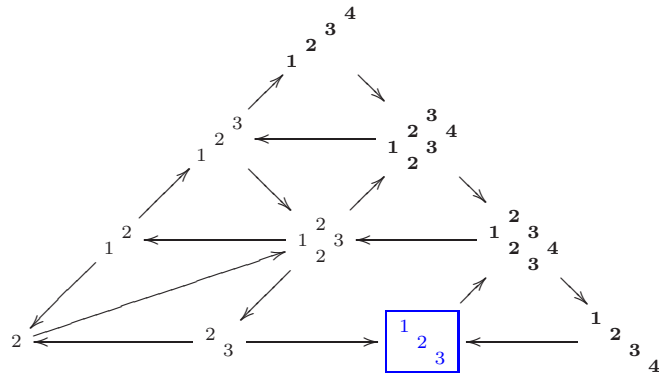

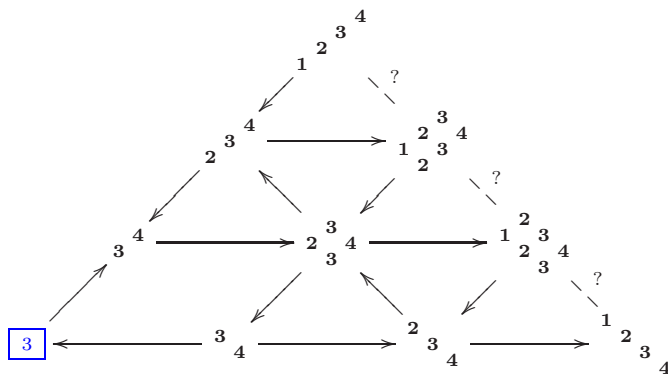
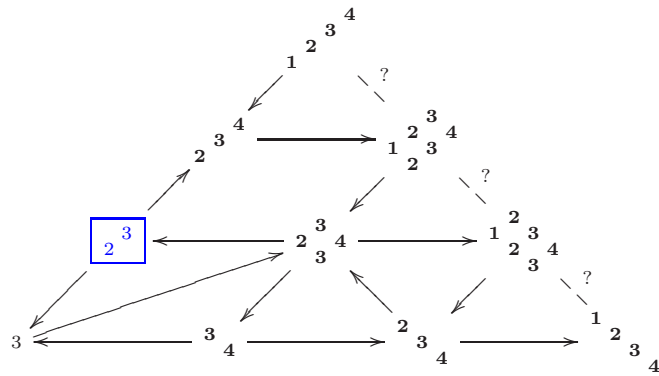
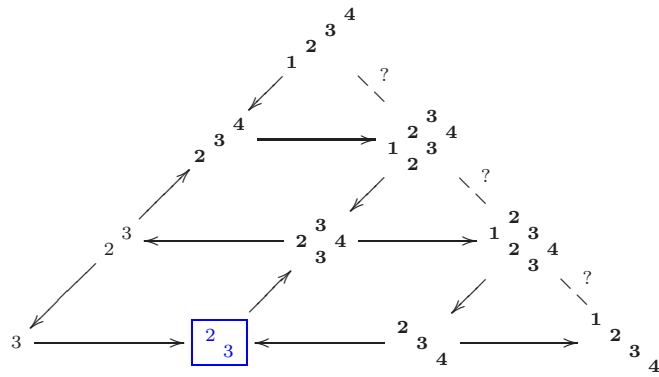
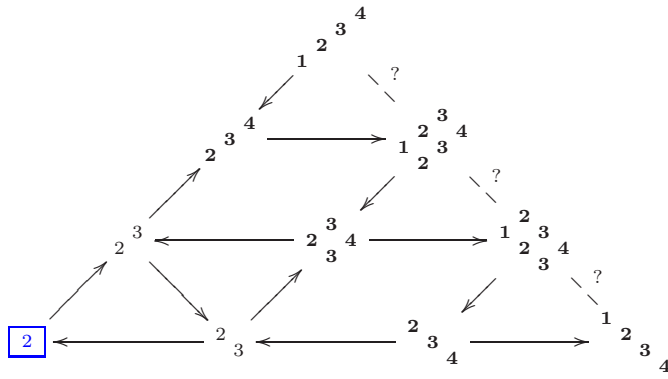

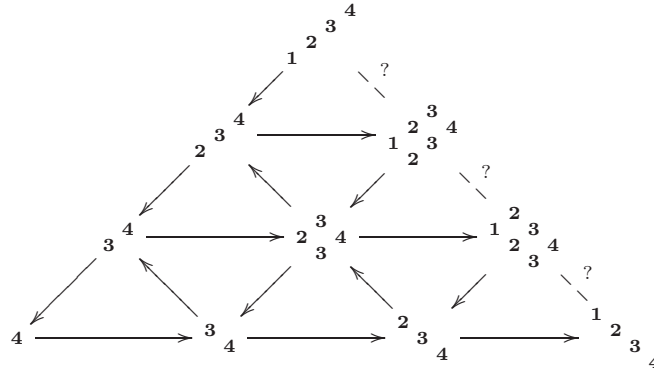

The first quiver on the list above is the quiver of the endomorphism algebra $\text{End}_A(T_M)$, and the last quiver on the list is the quiver of $\text{End}_\Lambda(T_M^\vee)$.

Define a matrix

$$X := \begin{pmatrix} 1 & x_1 & x_2 & x_3 & x_4 \\ 0 & 1 & x_5 & x_6 & x_7 \\ 0 & 0 & 1 & x_8 & x_9 \\ 0 & 0 & 0 & 1 & x_{10} \\ 0 & 0 & 0 & 0 & 1 \end{pmatrix}$$

The matrix X has columns and rows indexed by $[1, 5]$. For two subsets $I, J \subseteq [1, 5]$ with the same cardinality k let

$$\Delta_{I,J} \in \mathbb{C}[x_1, \dots, x_{10}]$$

be the minor of X with respect to the rows I and columns J . For example,

$$\Delta_{23,35} = \det \begin{pmatrix} x_5 & x_7 \\ 1 & x_9 \end{pmatrix} = x_5x_9 - x_7.$$

If $I = [1, b] \cup I'$ and $J = [1, b] \cup J'$, then we have $\Delta_{I,J} = \Delta_{I',J'}$. Also, for some subsets I and J of $[1, 5]$, the minor $\Delta_{I,J}$ will be zero. If $I = [1, k]$, we will just write Δ_J instead of $\Delta_{I,J}$.

We now take the quiver of $\text{End}_\Lambda(T_M)$ as displayed in the list above and replace the vertices by polynomials in $\mathbb{C}[x_1, \dots, x_{10}]$ as follows:

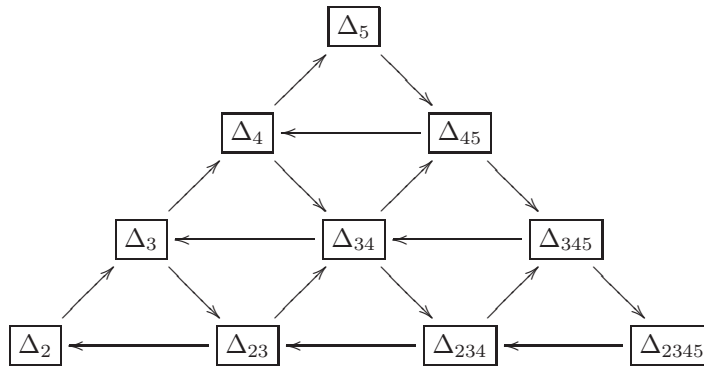

There is an isomorphism

$$\eta: \mathbb{C}[x_1, \dots, x_{10}] \rightarrow \mathbb{C}[\delta_{(M_1,0)}, \dots, \delta_{(M_{10},0)}] = \mathcal{R}(\mathcal{C}_M)$$

which is defined by $x_i \mapsto \delta_{(M_i,0)}$. Note that

$$\begin{aligned}
x_1 &= \Delta_2, & x_2 &= \Delta_3, & x_3 &= \Delta_4, & x_4 &= \Delta_5, \\
x_5 &= \Delta_{13}, & x_6 &= \Delta_{14}, & x_7 &= \Delta_{15}, \\
x_8 &= \Delta_{124}, & x_9 &= \Delta_{125}, \\
x_{10} &= \Delta_{1235}
\end{aligned}$$

Now one can easily show that for $1 \leq i \leq 4$ and $0 \leq a \leq b \leq i - 1$ we have

$$\eta: \Delta_{[1, i-a], [1, i-b-1] \cup [4-b+1, 4-a+1]} \mapsto \delta_{T_{i, [a, b]}}.$$

(We assume that $[1, 0] := \emptyset$.) Thus all cluster variables appearing in the above sequence of mutations from T_M to T_M^\vee are images of minors of the matrix X .

On the other hand, there are cluster variables δ_R in $\mathcal{R}(\mathcal{C}_M)$ which are not images of minors of the matrix X , compare [GLS1, Section 13.1].

Part 4. Cluster algebras

In this part, let $K = \mathbb{C}$ be the field of complex numbers.

19. KAC-MOODY LIE ALGEBRAS AND SEMICANONICAL BASES

In this section we recall known results on Kac-Moody Lie algebras and semicanonical bases.

19.1. Kac-Moody Lie algebras. Let $\Gamma = (\Gamma_0, \Gamma_1, \gamma)$ be a finite graph (without loops). It has as set of vertices Γ_0 , edges Γ_1 and $\gamma: \Gamma_1 \rightarrow \mathcal{P}_2(\Gamma_0)$ determining the adjacency of the edges; here $\mathcal{P}_2(\Gamma_0)$ denotes the set of two-element subsets of Γ_0 . If $\Gamma_0 = \{1, 2, \dots, n\}$ we can assign to Γ a *symmetric generalized Cartan matrix* $C_\Gamma = (c_{ij})_{i,j=1,2,\dots,n}$, which is an $n \times n$ -matrix with integer entries

$$c_{ij} := \begin{cases} 2 & \text{if } i = j, \\ -|\gamma^{-1}(\{i, j\})| & \text{if } i \neq j. \end{cases}$$

Obviously, the assignment $\Gamma \mapsto C_\Gamma$ induces a bijection between isomorphism classes of graphs with vertex set $\{1, 2, \dots, n\}$ and symmetric generalized Cartan matrices in $\mathbb{Z}^{n \times n}$ up to simultaneous permutation of rows and columns.

If $Q = (Q_0, Q_1, s, t)$ is a quiver without oriented cycles (in particular without loops) its underlying graph $|Q| := (Q_0, Q_1, q)$ is given by $q(a) = \{s(a), t(a)\}$ for all $a \in Q_1$ i.e. it is obtained by “forgetting” the orientation of the edges. We write then also $C_Q := C_{|Q|}$.

It will be convenient for us to consider $\mathfrak{g} := \mathfrak{g}_Q := \mathfrak{g}(C_Q)$ the (symmetric) *Kac-Moody Lie algebra* associated to Q , which is defined as follows: Let \mathfrak{h} be a \mathbb{C} -vector space of dimension $2n - \text{rank}(C_Q)$, and let $\Pi := \{\alpha_1, \dots, \alpha_n\} \subset \mathfrak{h}^*$ and $\Pi^\vee := \{\alpha_1^\vee, \dots, \alpha_n^\vee\} \subset \mathfrak{h}$ be linearly independent subsets of the vector spaces \mathfrak{h}^* and \mathfrak{h} , respectively, such that

$$\alpha_i(\alpha_j^\vee) = c_{ij}$$

for all i, j . Then $\mathfrak{g} = (\mathfrak{g}, [-, -])$ is the Lie algebra over \mathbb{C} generated by \mathfrak{h} and the symbols e_i and f_i ($1 \leq i \leq n$) satisfying the following defining relations:

- (L1) $[h, h'] = 0$ for all $h, h' \in \mathfrak{h}$,
- (L2) $[h, e_i] = \alpha_i(h)e_i$, and $[h, f_i] = -\alpha_i(h)f_i$,
- (L3) $[e_i, f_i] = \alpha_i^\vee$ and $[e_i, f_j] = 0$ for all $i \neq j$,
- (L4) $(\text{ad}(e_i)^{1-c_{ij}})(e_j) = 0$ for all $i \neq j$,
- (L5) $(\text{ad}(f_i)^{1-c_{ij}})(f_j) = 0$ for all $i \neq j$.

(For $x, y \in \mathfrak{g}$ and $m \geq 1$ we set $\text{ad}(x)(y) := \text{ad}(x)^1(y) := [x, y]$ and $\text{ad}(x)^{m+1}(y) := \text{ad}(x)^m([x, y])$.)

The Lie algebra \mathfrak{g} is finite-dimensional if and only if Q is a Dynkin quiver. In this case, \mathfrak{g} is the usual simple Lie algebra associated to Q .

Conversely, if $\mathfrak{g} = \mathfrak{g}(C)$ is a Kac-Moody Lie algebra defined by a symmetric generalized Cartan matrix C , we say that \mathfrak{g} is of type Γ if $C = C_\Gamma$. This is well defined for symmetric Kac-Moody Lie algebras. We call Γ the *Dynkin graph* of \mathfrak{g} .

For $\alpha \in \mathfrak{h}^*$ let

$$\mathfrak{g}_\alpha := \{x \in \mathfrak{g} \mid [h, x] = \alpha(h)x \text{ for all } h \in \mathfrak{h}\}.$$

One can show that $\dim \mathfrak{g}_\alpha < \infty$ for all α . By $R := \mathbb{Z}\alpha_1 \oplus \cdots \oplus \mathbb{Z}\alpha_n$ we denote the *root lattice* of \mathfrak{g} . Define $R^+ := \mathbb{N}\alpha_1 \oplus \cdots \oplus \mathbb{N}\alpha_n$. The *roots* of \mathfrak{g} are defined as the elements in

$$\Delta := \{\alpha \in R \setminus \{0\} \mid \mathfrak{g}_\alpha \neq 0\}.$$

Set $\Delta^+ := \Delta \cap R^+$ and $\Delta^- := \Delta \cap (-R^+)$. One can show that $\Delta = \Delta^+ \cup \Delta^-$. The elements in Δ^+ and Δ^- are the *positive roots* and the *negative roots*, respectively. The elements in $\{\alpha_1, \dots, \alpha_n\}$ are positive roots of \mathfrak{g} and are called *simple roots*.

One has the triangular decomposition $\mathfrak{g} = \mathfrak{n}_- \oplus \mathfrak{h} \oplus \mathfrak{n}$ with

$$\mathfrak{n}_- = \bigoplus_{\alpha \in \Delta^+} \mathfrak{g}_{-\alpha} \quad \text{and} \quad \mathfrak{n} = \bigoplus_{\alpha \in \Delta^+} \mathfrak{g}_\alpha.$$

The Lie algebra \mathfrak{n} is generated by e_1, \dots, e_n with defining relations (L4). Set $\mathfrak{n}_\alpha := \mathfrak{g}_\alpha$ if $\alpha \in R^+ \setminus \{0\}$.

For $1 \leq i \leq n$ define an element s_i in the automorphism group $\text{Aut}(\mathfrak{h}^*)$ of \mathfrak{h}^* by

$$s_i(\alpha) := \alpha - \alpha(\alpha_i^\vee)\alpha_i$$

for all $\alpha \in \mathfrak{h}^*$. The subgroup $W \subset \text{Aut}(\mathfrak{h}^*)$ generated by s_1, \dots, s_n is the *Weyl group* of \mathfrak{g} . The elements s_i are called *Coxeter generators* of W . The identity element of W is denoted by 1. The *length* $l(w)$ of some $w \neq 1$ in W is the smallest number $t \geq 1$ such that $w = s_{i_t} \cdots s_{i_2} s_{i_1}$ for some $1 \leq i_j \leq n$. In this case (i_t, \dots, i_2, i_1) is a *reduced expression* for w . Let $R(w)$ be the set of all reduced expressions for w . We set $l(1) = 0$.

Let us repeat the following definition from Section 3.7. A Weyl group element w is *Q-adaptable* if there exists a reduced expression $(i_t, \dots, i_2, i_1) \in R(w)$ such that i_1 is a sink of Q , and i_{k+1} is a sink of $\sigma_{i_k} \cdots \sigma_{i_2} \sigma_{i_1}(Q)$ for all $1 \leq k \leq t-1$. If this is the case, we say that (i_t, \dots, i_2, i_1) is a *Q-adapted* reduced expression. A Weyl group element w is *adaptable* if there exists an orientation Q of the Dynkin graph of \mathfrak{g} such that w is *Q-adaptable*.

A root $\alpha \in \Delta$ is a *real root* if $\alpha = w(\alpha_i)$ for some $w \in W$ and some i . It is well known that $\dim \mathfrak{g}_\alpha = 1$ if α is a real root. By Δ_{re} we denote the set of real roots of \mathfrak{g} . Define $\Delta_{\text{re}}^+ := \Delta_{\text{re}} \cap \Delta^+$.

Finally, let us fix a \mathbb{Z} -basis $\{\varpi_j \mid 1 \leq j \leq 2n - \text{rank}(C_Q)\}$ of $\mathfrak{h}_{\mathbb{Z}}^*$ such that

$$\varpi_j(\alpha_i^\vee) = \delta_{ij}, \quad (1 \leq i \leq n, 1 \leq j \leq 2n - \text{rank}(C_Q)),$$

(see [Ku, §6.1.6]). The ϖ_j are the *fundamental weights*. We denote by

$$P := \bigoplus_{i=1}^{2n - \text{rank}(C_Q)} \mathbb{Z}\varpi_i$$

the integral weight lattice, and we set

$$P^+ := \{\nu \in P \mid \nu(\alpha_i^\vee) \geq 0 \text{ for } 1 \leq i \leq n\}.$$

19.2. The universal enveloping algebra $U(\mathfrak{n})$. The universal enveloping algebra $U(\mathfrak{n})$ of the Lie algebra \mathfrak{n} is the associative \mathbb{C} -algebra defined by generators E_1, \dots, E_n and relations

$$\sum_{k=0}^{1-c_{ij}} (-1)^k E_i^{(k)} E_j E_i^{(1-c_{ij}-k)} = 0$$

for all $i \neq j$, where the c_{ij} are the entries of the generalized Cartan matrix C_Q , and

$$E_i^{(k)} := E_i^k / k!.$$

We have a canonical embedding $\iota: \mathfrak{n} \rightarrow U(\mathfrak{n})$ which maps e_i to E_i for all $1 \leq i \leq n$. We consider \mathfrak{n} as a subspace of $U(\mathfrak{n})$, and we also identify e_i and E_i .

Let

$$J = \begin{cases} \mathbb{N}_1 & \text{if } \dim \mathfrak{n} = \infty, \\ [1, d] & \text{if } \dim \mathfrak{n} = d. \end{cases}$$

Let $P := \{p_i \mid i \in J\}$ be a \mathbb{C} -basis of \mathfrak{n} such that $P \cap \mathfrak{n}_\alpha$ is a basis of \mathfrak{n}_α for all positive roots α . We assume that $\{e_1, \dots, e_n\} \subset P$. Thus e_i is a basis vector of the (1-dimensional) space \mathfrak{n}_{α_i} .

For $k \geq 0$ define $p_i^{(k)} := p_i^k/k!$. Let $\mathbb{N}^{(J)}$ be the set of tuples $(m_i)_{i \in J}$ of natural numbers m_i such that $m_i = 0$ for all but finitely many m_i . For $\mathbf{m} = (m_i)_{i \geq 1} \in \mathbb{N}^{(J)}$ define

$$p_{\mathbf{m}} := p_1^{(m_1)} p_2^{(m_2)} \cdots p_s^{(m_s)}$$

where s is chosen such that $m_j = 0$ for all $j > s$.

Theorem 19.1 (Poincaré-Birkhoff-Witt). *The set*

$$\mathcal{P} := \left\{ p_{\mathbf{m}} \mid \mathbf{m} \in \mathbb{N}^{(J)} \right\}$$

is a \mathbb{C} -basis of $U(\mathfrak{n})$.

The basis \mathcal{P} is called a *PBW-basis* of $U(\mathfrak{n})$. For $d = (d_1, \dots, d_n) \in \mathbb{N}^n$ let U_d be the subspace of $U(\mathfrak{n})$ spanned by the elements of the form $e_{i_1} e_{i_2} \cdots e_{i_m}$, where for each $1 \leq i \leq n$ the set $\{i_k \mid i_k = i, 1 \leq k \leq m\}$ contains exactly d_i elements.

It follows that

$$U(\mathfrak{n}) = \bigoplus_{d \in \mathbb{N}^n} U_d.$$

This turns $U(\mathfrak{n})$ into an \mathbb{N}^n -graded algebra.

Furthermore, $U(\mathfrak{n})$ is a cocommutative Hopf algebra with comultiplication

$$\Delta: U(\mathfrak{n}) \rightarrow U(\mathfrak{n}) \otimes U(\mathfrak{n})$$

defined by $\Delta(x) := 1 \otimes x + x \otimes 1$ for all $x \in \mathfrak{n}$. It is easy to check that

$$(20) \quad \Delta(p_{\mathbf{m}}) = \sum_{\mathbf{k}} p_{\mathbf{k}} \otimes p_{\mathbf{m}-\mathbf{k}},$$

where the sum is over all tuples $\mathbf{k} = (k_i)_{i \geq 1}$ with $0 \leq k_i \leq m_i$ for every i .

By U_d^* we denote the vector space dual of U_d . Define the *graded dual* of $U(\mathfrak{n})$ by

$$U(\mathfrak{n})_{\text{gr}}^* := \bigoplus_{d \in \mathbb{N}^n} U_d^*.$$

It follows that $U(\mathfrak{n})_{\text{gr}}^*$ is a commutative associative \mathbb{C} -algebra with multiplication defined via the comultiplication Δ of $U(\mathfrak{n})$: For $f', f'' \in U(\mathfrak{n})_{\text{gr}}^*$ and $x \in U(\mathfrak{n})$, we have

$$(f' \cdot f'')(x) = \sum_{(x)} f'(x_{(1)}) f''(x_{(2)}),$$

where (using the Sweedler notation) we write

$$\Delta(x) = \sum_{(x)} x_{(1)} \otimes x_{(2)}.$$

Let $\mathcal{P}^* := \{p_{\mathbf{m}}^* \mid \mathbf{m} \in \mathbb{N}^{(J)}\}$ be the dual PBW-basis of $U(\mathfrak{n})_{\text{gr}}^*$, where

$$p_{\mathbf{m}}^*(p_{\mathbf{n}}) := \begin{cases} 1 & \text{if } \mathbf{m} = \mathbf{n}, \\ 0 & \text{otherwise.} \end{cases}$$

The element in \mathcal{P}^* corresponding to $p_i \in \mathbb{P}$ is denoted by p_i^* . It follows from (20) that

$$p_{\mathbf{m}}^* \cdot p_{\mathbf{n}}^* = p_{\mathbf{m}+\mathbf{n}}^*,$$

that is, each element $p_{\mathbf{m}}^*$ in \mathcal{P}^* is equal to a monomial in the p_i^* 's. Hence, the graded dual $U(\mathfrak{n})_{\text{gr}}^*$ can be identified with the polynomial algebra $\mathbb{C}[p_1^*, p_2^*, \dots]$ (with countably many variables p_i^*).

19.3. The Lie algebra $\mathfrak{n}(w)$. Let

$$\widehat{\mathfrak{n}} := \prod_{\alpha \in \Delta^+} \mathfrak{n}_{\alpha}$$

be the completion of the Lie algebra \mathfrak{n} .

A subset $\Theta \subseteq \Delta^+$ is *bracket closed* if for all $\alpha, \beta \in \Theta$ with $\alpha + \beta \in \Delta^+$ we have $\alpha + \beta \in \Theta$. One calls Θ *bracket coclosed* if $\Delta^+ \setminus \Theta$ is bracket closed.

For $w \in W$ set

$$\Delta_w^+ := \{\alpha \in \Delta^+ \mid w(\alpha) < 0\}.$$

It follows that for each $(i_t, \dots, i_2, i_1) \in R(w)$ we have

$$\Delta_w^+ = \{\alpha_{i_1}, s_{i_1}(\alpha_{i_2}), \dots, s_{i_1} s_{i_2} \cdots s_{i_{t-1}}(\alpha_{i_t})\}.$$

The set Δ_w^+ contains $l(w)$ positive roots, all of these are real roots. See for example [Ku, 1.3.14]. The next lemma is well known.

Lemma 19.2. *For every $w \in W$, the set Δ_w^+ is bracket closed and bracket coclosed.*

Let

$$\mathfrak{n}(w) := \bigoplus_{\alpha \in \Delta_w^+} \mathfrak{n}_{\alpha}$$

be the *nilpotent Lie algebra associated to w* . Thus $\dim \mathfrak{n}(w) = l(w)$.

The following lemma is also well known (see [Be]).

Lemma 19.3. *Let $M = M_1 \oplus \cdots \oplus M_r$ be a terminal $\mathbb{C}Q$ -module, and let $x(1) < x(2) < \cdots < x(r)$ be a Γ_M -adapted ordering of the vertices of Γ_M . For $1 \leq j \leq r$ set $i_j = i$ where i is the vertex of Q with $x(j) = (i, a)$ for some a . Then*

$$w := w(M) := s_{i_r} \cdots s_{i_2} s_{i_1}$$

is Q^{op} -adaptable, and we have

$$\Delta_w^+ = \Delta_M^+ := \{\underline{\dim}(M_1), \dots, \underline{\dim}(M_r)\}.$$

Moreover, w does not depend on the choice of the adapted ordering.

Let us discuss an example. Let Q be the quiver

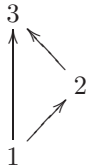

We take a terminal $\mathbb{C}Q$ -module M defined by $t_1 = 2$ and $t_2 = t_3 = 1$. Thus the quiver Γ_M looks as follows:

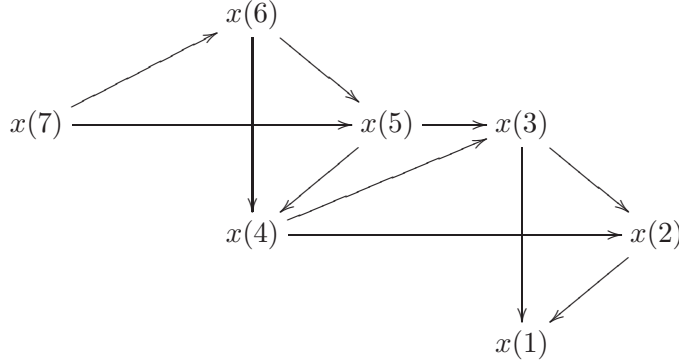

The vertices are labelled such that the ordering $x(1) < x(2) < \dots < x(7)$ is Γ_M -adapted. Thus $w = w(M) := s_1 s_3 s_2 s_1 s_3 s_2 s_1$ is a Q^{op} -adaptable Weyl group element. We get

$$\Delta_w^+ := \left\{ \begin{matrix} 0 & 0 & 1 & 1 & 2 & 2 & 3 \\ 1 & 0 & 1 & 2 & 3 & 3 & 4 \end{matrix} \right\}.$$

These are just the dimension vector of the indecomposable direct summands of M . For example, we have

$$s_1 s_2 s_3(\alpha_1) = s_1 s_2 \begin{pmatrix} 1 \\ 1 \end{pmatrix} = s_1 \begin{pmatrix} 1 \\ 2 \end{pmatrix} = \begin{pmatrix} 1 \\ 2 \end{pmatrix}.$$

The part of the preinjective component of $\mathbb{C}Q$, where the indecomposable direct summands of M lie, looks like this:

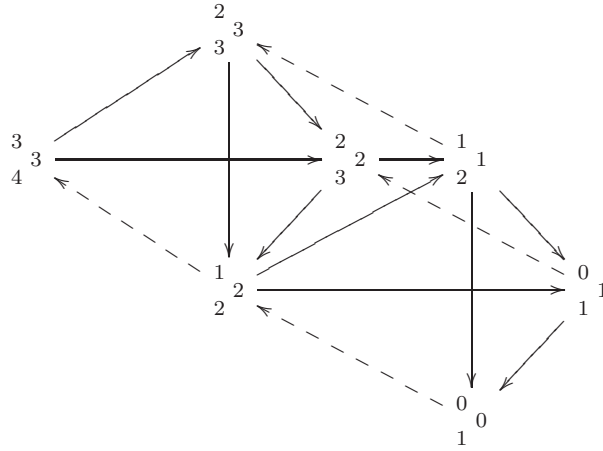

19.4. Semicanonical bases. Recall that for each dimension vector $d = (d_1, \dots, d_n)$ we defined the affine variety Λ_d of nilpotent Λ -modules with dimension vector d . A subset C of Λ_d is said to be constructible if it is a finite union of locally closed subsets. A function

$$f: \Lambda_d \rightarrow \mathbb{C}$$

is *constructible* if the image $f(\Lambda_d)$ is finite and $f^{-1}(m)$ is a constructible subset of Λ_d for all $m \in \mathbb{C}$. The set of constructible functions on Λ_d is denoted by $M(\Lambda_d)$. This is a \mathbb{C} -vector space.

Recall that the group GL_d acts on Λ_d by conjugation. By $M(\Lambda_d)^{\text{GL}_d}$ we denote the subspace of $M(\Lambda_d)$ consisting of the constructible functions which are constant on the

GL_d -orbits in Λ_d . Set

$$\widetilde{\mathcal{M}} := \bigoplus_{d \in \mathbb{N}^n} M(\Lambda_d)^{\mathrm{GL}_d}.$$

For $f' \in M(\Lambda_{d'})^{\mathrm{GL}_{d'}}$, $f'' \in M(\Lambda_{d''})^{\mathrm{GL}_{d''}}$ and $d = d' + d''$ we define a constructible function

$$f := f' \star f'' : \Lambda_d \rightarrow \mathbb{C}$$

in $M(\Lambda_d)^{\mathrm{GL}_d}$ by

$$f(X) := \sum_{m \in \mathbb{C}} m \chi_c(\{U \subseteq X \mid f'(U)f''(X/U) = m\})$$

for all $X \in \Lambda_d$, where U runs over the points of the Grassmannian of all submodules of X with $\underline{\dim}(U) = d'$. Here, for a constructible subset V of a complex variety we denote by $\chi_c(V)$ its (topological) Euler characteristic with respect to cohomology with compact support. This turns $\widetilde{\mathcal{M}}$ into an associative \mathbb{C} -algebra.

Remark 19.4. Note that the product \star defined here is opposite to the convolution product we have used in [GLS1, GLS3, GLS4]. This new convention turns out to be better adapted to our choice of categorifying $\mathbb{C}[N(w)]$ and $\mathbb{C}[N^w]$ by categories closed under factor modules. It is also compatible with our choice in [GLS6] of categorifying coordinate rings of partial flag varieties by categories closed under submodules (see Remark 22.22).

For the canonical basis vector $e_i := \underline{\dim}(S_i)$ we know that Λ_{e_i} is just a point, which (as a Λ -module) is isomorphic to the simple module S_i . Define $\mathbf{1}_i : \Lambda_{e_i} \rightarrow \mathbb{C}$ by $\mathbf{1}_i(S_i) := 1$. By \mathcal{M} we denote the subalgebra of $\widetilde{\mathcal{M}}$ generated by the functions $\mathbf{1}_i$ where $1 \leq i \leq n$. Set $\mathcal{M}_d := \mathcal{M} \cap M(\Lambda_d)^{\mathrm{GL}_d}$. It follows that

$$\mathcal{M} := \bigoplus_{d \in \mathbb{N}^n} \mathcal{M}_d$$

is an \mathbb{N}^n -graded \mathbb{C} -algebra.

Theorem 19.5 (Lusztig [L3]). *There is an isomorphism of \mathbb{N}^n -graded \mathbb{C} -algebras*

$$U(\mathfrak{n}) \rightarrow \mathcal{M}$$

defined by $E_i \mapsto \mathbf{1}_i$ for $1 \leq i \leq n$.

Let $\mathrm{Irr}(\Lambda_d)$ be the set of irreducible components of Λ_d .

Theorem 19.6 (Lusztig [L3]). *For each $Z \in \mathrm{Irr}(\Lambda_d)$ there is a unique $f_Z : \Lambda_d \rightarrow \mathbb{C}$ in \mathcal{M}_d such that f_Z takes value 1 on some dense open subset of Z and value 0 on some dense open subset of any other irreducible component Z' of Λ_d . Furthermore, the set*

$$\mathcal{S} := \{f_Z \mid Z \in \mathrm{Irr}(\Lambda_d), d \in \mathbb{N}^n\}$$

is a \mathbb{C} -basis of \mathcal{M} .

The basis \mathcal{S} is called the *semicanonical basis* of \mathcal{M} . By Theorem 19.5 we just identify \mathcal{M} and $U(\mathfrak{n})$ and consider \mathcal{S} also as a basis of $U(\mathfrak{n})$.

Now we turn to the graded dual

$$U(\mathfrak{n})_{\mathrm{gr}}^* = \bigoplus_{d \in \mathbb{N}^n} U_d^*$$

of $U(\mathfrak{n})$. Let \mathcal{M}_d^* be the dual space of \mathcal{M}_d , and set

$$\mathcal{M}^* := \bigoplus_{d \in \mathbb{N}^n} \mathcal{M}_d^*.$$

For $X \in \Lambda_d$ define a linear form

$$\delta_X: \mathcal{M}_d \rightarrow \mathbb{C}$$

by $\delta_X(f) := f(X)$. It is not difficult to show that the map $X \mapsto \delta_X$ from Λ_d to \mathcal{M}_d^* is constructible, i.e. this map has a finite image and the preimage of each element in \mathcal{M}_d^* is constructible in Λ_d . So on every irreducible component $Z \in \text{Irr}(\Lambda_d)$ there is a Zariski open set on which this map is constant. Define $\rho_Z := \delta_X$ for any X in this open set. The \mathbb{C} -vector space \mathcal{M}_d^* is spanned by the functions δ_X with $X \in \Lambda_d$. Then by construction

$$\mathcal{S}^* := \{\rho_Z \mid Z \in \text{Irr}(\Lambda_d), d \in \mathbb{N}^n\}$$

is the basis of $\mathcal{M}^* \equiv U(\mathfrak{n})_{\text{gr}}^*$ dual to Lusztig's semicanonical basis \mathcal{S} of $U(\mathfrak{n})$.

19.5. A cluster character. The map $X \mapsto \delta_X$ from $\text{nil}(\Lambda)$ to $U(\mathfrak{n})_{\text{gr}}^*$ has the following multiplicative properties.

Theorem 19.7 ([GLS1, Lemma 7.2] and [GLS4, Theorem 2]). *Let $X, Y \in \text{nil}(\Lambda)$.*

(i) *We have*

$$\delta_X \delta_Y = \delta_{X \oplus Y}.$$

(ii) *If $\dim \text{Ext}_{\Lambda}^1(X, Y) = 1$ with*

$$0 \rightarrow X \rightarrow E' \rightarrow Y \rightarrow 0 \text{ and } 0 \rightarrow Y \rightarrow E'' \rightarrow X \rightarrow 0$$

the corresponding non-split short exact sequences, then

$$\delta_X \delta_Y = \delta_{E'} + \delta_{E''}.$$

In fact, the main result of [GLS4] is a more general multiplication formula (without the restriction to the case $\dim \text{Ext}_{\Lambda}^1(X, Y) = 1$). However, in this paper we do not need this.

19.6. Dual Verma modules. We present some of the results of [GLS3] in a form convenient for our present purpose. For $i = 1, \dots, n$, let \widehat{I}_i denote the injective Λ -module with simple socle S_i . If Λ is not of Dynkin type, \widehat{I}_i is infinite-dimensional. For $\nu \in P^+$ we write

$$\widehat{I}_{\nu} := \bigoplus_{i=1}^n \widehat{I}_i^{\nu(\alpha_i^{\vee})}.$$

For $i = 1, \dots, n$ and a nilpotent Λ -module X we denote by $\mathcal{G}(i, X)$ the variety of submodules Y of X such that $X/Y \cong S_i$. Similarly, if

$$\text{soc}(X) = \bigoplus_{i=1}^n S_i^{m_i}$$

and $\nu \in P^+$ is such that $\nu(\alpha_i^{\vee}) \geq m_i$ for $1 \leq i \leq n$, then we have an embedding $X \hookrightarrow \widehat{I}_{\nu}$. In this case, we denote by $\mathcal{G}(i, \nu, X)$ the variety of submodules Y of \widehat{I}_{ν} such that $X \subset Y$ and $Y/X \cong S_i$. Hence, if $\underline{\dim}(X) = \beta$ and $f \in \mathcal{M}_{\beta - \alpha_i}$, we can form the following sum

$$S = \sum_{m \in \mathbb{Z}} m \chi_c(\{Y \in \mathcal{G}(i, X) \mid f(Y) = m\}).$$

For convenience we shall denote such an expression by an integral, for example,

$$S = \int_{Y \in \mathcal{G}(i, X)} f(Y).$$

Similarly, there exists a partition

$$\mathcal{G}(i, X) = \bigsqcup_{j=1}^m A_j$$

into constructible subsets such that $\delta_Y = \delta_{Y'}$ for all $Y, Y' \in A_j$. Then, choosing arbitrary $Y_j \in A_j$ for $j = 1, \dots, m$, we can also denote by an integral the following element of $\mathcal{M}_{\beta-\alpha_i}^*$

$$\int_{Y \in \mathcal{G}(i, X)} \delta_Y = \sum_{j=1}^m \chi_c(A_j) \delta_{Y_j}.$$

Theorem 19.8. *Let $\lambda \in P$ be an integral weight, and let $M_{\text{low}}(\lambda)$ be the lowest weight Verma right $U(\mathfrak{g})$ -module, with lowest weight λ . Under the identifications*

$$M_{\text{low}}(\lambda) \equiv U(\mathfrak{n}) \equiv \mathcal{M}$$

we equip \mathcal{M} with the structure of a right $U(\mathfrak{g})$ -module as follows. The generators $e_i \in \mathfrak{n}$, $f_i \in \mathfrak{n}_-$, $h \in \mathfrak{h}$ act on $g \in \mathcal{M}(\beta)$ by

$$\begin{aligned} (g \cdot e_i)(X') &= \int_{Y \in \mathcal{G}(i, X')} g(Y), \\ (g \cdot f_i)(X) &= \int_{Y \in \mathcal{G}(i, \nu, X)} g(Y) - (\nu - \lambda)(\alpha_i^\vee) g(X \oplus S_i), \\ g \cdot h &= (\lambda - \beta)(h)g, \end{aligned}$$

where $X' \in \Lambda_{\beta+\alpha_i}$, $X \in \Lambda_{\beta-\alpha_i}$ and $\nu \in P^+$ are as above.

Note that $g \cdot e_i = g * \mathbf{1}_i$ by our convention for the multiplication in \mathcal{M} . Moreover, the formula for $g \cdot f_i \in \mathcal{M}_{\beta-\alpha_i}$ is in fact independent of the choice of ν .

Recall, that for each \mathfrak{h} -diagonalizable right $U(\mathfrak{g})$ -module

$$M = \bigoplus_{\mu \in \mathfrak{h}^*} M_\mu$$

one can consider the *dual* representation

$$M^* = \bigoplus_{\mu \in \mathfrak{h}^*} M_\mu^*$$

defined by $M_\mu^* := \text{Hom}_{\mathbb{C}}(M_\mu, \mathbb{C})$ and

$$(x \cdot \phi)(m) := \phi(m \cdot x), \quad (x \in \mathfrak{g}, m \in M).$$

Consider the canonical epimorphism from the Verma module $M_{\text{low}}(\lambda)$ to the irreducible lowest weight right $U(\mathfrak{n})$ -module $L_{\text{low}}(\lambda)$. For the corresponding dual representations we obtain an inclusion

$$L_{\text{low}}^*(\lambda) \hookrightarrow M_{\text{low}}^*(\lambda).$$

It is well known that $L_{\text{low}}^*(\lambda)$ is isomorphic to the irreducible highest weight left module $L(\lambda)$. This yields the following realization of $L(\lambda)$ in terms of δ -functions.

Theorem 19.9. *Let $\lambda \in P^+$ be a dominant weight. The subspace of $U(\mathfrak{n})_{\text{gr}}^*$ spanned by all δ_X such that X is isomorphic to a submodule of \widehat{I}_λ carries the above-mentioned structure*

of an irreducible highest weight module $L(\lambda)$. For such X with $\underline{\dim}(X) = \beta$ the action of the Chevalley generators of $U(\mathfrak{g})$ is given by

$$\begin{aligned} e_i \cdot \delta_X &= \int_{Y \in \mathcal{G}(i, X)} \delta_Y, \\ f_i \cdot \delta_X &= \int_{Y' \in \mathcal{G}(i, \lambda, X)} \delta_{Y'}, \\ h \cdot \delta_X &= (\lambda - \beta)(h)\delta_X. \end{aligned}$$

Note that $U(\mathfrak{n})_{\text{gr}}^*$ carries also a *right* $U(\mathfrak{n})$ -module structure coming from the left regular representation of $U(\mathfrak{n})$. In order to describe it, we introduce the following definition. For $X \in \Lambda_\beta$ we denote by $\mathcal{G}'(i, X)$ the variety of submodules Y of X such that $\underline{\dim}(Y) = \alpha_i$. Each element of this space is isomorphic to S_i and clearly $\mathcal{G}'(i, X)$ is a projective space. It is easy to see that

$$\delta_X \cdot e_i = \int_{S \in \mathcal{G}'(i, X)} \delta_{X/S}.$$

Under the above identification $M_{\text{low}}^*(\lambda) \equiv U(\mathfrak{n})_{\text{gr}}^*$, the subspace of $U(\mathfrak{n})_{\text{gr}}^*$ carrying the $U(\mathfrak{g})$ -module $L(\lambda)$ can be described as follows.

Corollary 19.10. *We have*

$$L(\lambda) = \left\{ \phi \in U(\mathfrak{n})_{\text{gr}}^* \mid \phi \cdot e_i^{\lambda(\alpha_i^\vee)+1} = 0, (i = 1, \dots, n) \right\}.$$

Proof. The nilpotent Λ -module X is isomorphic to a submodule of \widehat{I}_λ if and only if $\delta_X \cdot e_i^{\lambda(\alpha_i^\vee)+1} = 0$ for every i . The claim then follows from Theorem 19.9. \square

20. A DUAL PBW-BASIS AND A DUAL SEMICANONICAL BASIS FOR $\mathcal{A}(\mathcal{C}_M)$

In this section we prove Theorem 3.3 and Theorem 3.4. We also deduce from these results the existence of semicanonical bases for the cluster algebras $\widetilde{\mathcal{R}}(\mathcal{C}_M)$ and $\underline{\mathcal{R}}(\mathcal{C}_M)$ obtained by inverting and specializing coefficients, respectively.

20.1. Proof of Theorem 3.3. By the definition of the cluster algebra $\mathcal{A}(\mathcal{C}_M, T)$, its initial seed is $(\mathbf{y}, B(T)^\circ)$. Let $\mathcal{F} = \mathbb{C}(y_1, \dots, y_r)$. Since T is rigid, by Theorem 19.7 (i) every monomial in the δ_{T_i} belongs to the dual semicanonical basis \mathcal{S}^* , hence the δ_{T_i} are algebraically independent and $(\delta_{T_1}, \dots, \delta_{T_r})$ is a transcendence basis of the subfield \mathcal{G} it generates inside the fraction field of $U(\mathfrak{n})_{\text{gr}}^*$. Let $\iota: \mathcal{F} \rightarrow \mathcal{G}$ be the field isomorphism defined by $\iota(y_i) = \delta_{T_i}$ ($1 \leq i \leq r$). Combining Theorem 3.1 and Theorem 19.7 (ii) we see that the cluster variable z of $\mathcal{A}(\mathcal{C}_M, T)$ obtained from the initial seed $(\mathbf{y}, B(T)^\circ)$ through a sequence of seed mutations in successive directions k_1, \dots, k_s will be mapped by ι to δ_X , where $X \in \mathcal{C}_M$ is the indecomposable rigid module obtained by the same sequence of mutations of rigid modules. It follows that ι restricts to an isomorphism from $\mathcal{A}(\mathcal{C}_M, T)$ to $\mathcal{R}(\mathcal{C}_M, T)$. This isomorphism is completely determined by the images of the elements y_i , hence the unicity. The cluster monomials are mapped to elements δ_R where R is a (not necessarily maximal or basic) rigid module in \mathcal{C}_M , hence an element of \mathcal{S}^* . This finishes the proof of Theorem 3.3.

20.2. Proof of Theorem 3.4. Let $M = M_1 \oplus \cdots \oplus M_r$ be a terminal $\mathbb{C}Q$ -module. We fix for this section a Γ_M -adapted ordering $x(1) < x(2) < \cdots < x(r)$ of the vertices of Γ_M and we may assume that M_i corresponds to the vertex $x(i)$ for $1 \leq i \leq r$. Moreover, we write $\alpha(i) := \underline{\dim}(M_i)$.

We have

$$\mathbb{C}[\delta_{(M_1,0)}, \dots, \delta_{(M_r,0)}] \subseteq \mathcal{R}(\mathcal{C}_M) \subseteq \text{Span}_{\mathbb{C}}\langle \delta_X \mid X \in \mathcal{C}_M \rangle,$$

where the first inclusion follows from the observation that each of the Λ -modules $(M_i, 0)$ for $1 \leq i \leq r$ is the direct summand of a maximal rigid module on the mutation path from T_M to T_M^\vee , see Section 18. The second inclusion follows from the observation that $\text{Span}_{\mathbb{C}}\langle \delta_X \mid X \in \mathcal{C}_M \rangle$ is an algebra. This follows from the fact that \mathcal{C}_M is an additive category together with Theorem 19.7 (i).

For each $M' \in \text{add}(M)$ we can choose a $\mathbb{C}Q$ -module homomorphism

$$f_{M'}: M' \rightarrow \tau(M')$$

such that $(M', f_{M'})$ is generic in $\pi_{Q,d}^{-1}(\mathcal{O}_{M'})$, where $d = \underline{\dim}(M')$. It follows that $\delta_{(M', f_{M'})}$ belongs to the dual semicanonical basis \mathcal{S}^* of $U(\mathfrak{n})_{\text{gr}}^*$. If $M' = M_i$ is an indecomposable direct summand of M , then $\text{Hom}_{\mathbb{C}Q}(M', \tau(M')) = 0$ and therefore $f_{M'} = 0$.

The following theorem is a slightly more explicit statement of Theorem 3.4:

Theorem 20.1. *Let M be a terminal $\mathbb{C}Q$ -module. Then the following hold:*

(i) *We have*

$$\mathcal{R}(\mathcal{C}_M) = \mathbb{C}[\delta_{(M_1,0)}, \dots, \delta_{(M_r,0)}] = \text{Span}_{\mathbb{C}}\langle \delta_X \mid X \in \mathcal{C}_M \rangle;$$

(ii) *The set*

$$\mathcal{P}_M^* := \{\delta_{(M',0)} \mid M' \in \text{add}(M)\}$$

is a \mathbb{C} -basis of $\mathcal{R}(\mathcal{C}_M)$;

(iii) *The subset*

$$\mathcal{S}_M^* := \{\delta_{(M', f_{M'})} \mid M' \in \text{add}(M)\}$$

of the dual semicanonical basis is a \mathbb{C} -basis of $\mathcal{R}(\mathcal{C}_M)$, and all cluster monomials of $\mathcal{R}(\mathcal{C}_M)$ belong to \mathcal{S}_M^ .*

The basis \mathcal{P}_M^* will be called *dual PBW-basis* of $\mathcal{R}(\mathcal{C}_M)$, and \mathcal{S}_M^* the *dual semicanonical basis* of $\mathcal{R}(\mathcal{C}_M)$. The proof of this theorem will be given after a series of lemmas.

Let $\mathcal{M}_{Q,d}$ be the \mathbb{C} -vector space of GL_d -invariant constructible functions $\text{rep}(Q, d) \rightarrow \mathbb{C}$. Set

$$\mathcal{M}_Q := \bigoplus_{d \in \mathbb{N}^n} \mathcal{M}_{Q,d}.$$

Note that the affine space $\text{rep}(Q, d)$ of representations of Q with dimension vector d can be viewed as an irreducible component of Λ_d . In fact, $\dim \text{rep}(Q, d) = \dim \Lambda_d$, and we have

$$\text{rep}(Q, d) = \{(f_a, f_{a^*})_{a \in Q_1} \in \Lambda_d \mid f_{a^*} = 0 \text{ for all } a \in Q_1\},$$

compare Section 4. Thus we have a natural restriction $\text{Res}_Q: \mathcal{M} \rightarrow \mathcal{M}_Q$, which is an algebra homomorphism.

Lemma 20.2 ([L1, S]). *Let $f \in \mathcal{M}_d$. If $\text{Res}_Q(f) = 0$, then $f = 0$.*

Let

$$\mathfrak{n} = \bigoplus_{d \in \Delta^+} \mathfrak{n}_d$$

be the root space decomposition of \mathfrak{n} . We consider \mathfrak{n} as a subspace of the universal enveloping algebra $U(\mathfrak{n})$. Since we identify $U(\mathfrak{n})$ and \mathcal{M} , we can think of an element f in \mathfrak{n}_d as a constructible function $f: \Lambda_d \rightarrow \mathbb{C}$ in \mathcal{M}_d .

Lemma 20.3. *Let $f \in \mathfrak{n}_d$. If $d \notin \{\alpha(i) \mid 1 \leq i \leq r\}$, then*

$$f(X) = 0 \text{ for all } X \in \mathcal{C}_M.$$

Proof. We know from Lemma 19.2 and Lemma 19.3 that $\{\alpha(i) \mid 1 \leq i \leq r\}$ is a bracket closed subset of Δ^+ . Thus if $X \in \mathcal{C}_M$ has a dimension vector d' in Δ^+ we must have $d' \in \{\alpha(i) \mid 1 \leq i \leq r\}$. Therefore, since $f \in \mathcal{M}_d$ with $d \in \Delta^+$ and $d \notin \{\alpha(i) \mid 1 \leq i \leq r\}$, we have $f(X) = 0$ for every $X \in \mathcal{C}_M$. \square

Next, we construct a PBW-basis of $U(\mathfrak{n})$ as follows. Choose a \mathbb{C} -basis

$$P := \{p_j \mid j \in J\}$$

of \mathfrak{n} consisting of weight vectors for the adjoint representation. We number it so that for $1 \leq j \leq r$ the vector p_j belongs to $\mathfrak{n}_{\alpha(j)}$. We denote by $\mathcal{P} = \{p_{\mathbf{m}} \mid \mathbf{m} \in \mathbb{N}^{(J)}\}$ the PBW-basis of $U(\mathfrak{n})$ with respect to P (see Theorem 19.1).

Lemma 20.4. *Let $p_{\mathbf{m}} \in \mathcal{P}$ where $\mathbf{m} = (m_j)_{j \in J}$. If $m_j > 0$ for some $j > r$, then*

$$p_{\mathbf{m}}(X) = 0 \text{ for all } X \in \mathcal{C}_M.$$

Equivalently, $\delta_X(p_{\mathbf{m}}) = 0$ for all $X \in \mathcal{C}_M$.

Proof. We regard $p_{\mathbf{m}}$ as an element of \mathcal{M} , hence as a convolution product

$$p_{\mathbf{m}} = p_1^{(m_1)} \star p_2^{(m_2)} \star \cdots \star p_s^{(m_s)}.$$

Let us assume that $s > r$ and $m_s > 0$. It follows that $p_{\mathbf{m}} = p \star p_s$ where

$$p := \frac{1}{m_s} \left(p_1^{(m_1)} \star p_2^{(m_2)} \star \cdots \star p_{s-1}^{(m_{s-1})} \star p_s^{(m_s-1)} \right).$$

Now let $X \in \mathcal{C}_M$. Then

$$p_{\mathbf{m}}(X) = (p \star p_s)(X) = \sum_{m \in \mathbb{C}} m \chi_c(\{U \subseteq X \mid p(U)p_s(X/U) = m\}).$$

Since \mathcal{C}_M is closed under factor modules, we get $X/U \in \mathcal{C}_M$ for all submodules U of X . Now Lemma 20.3 yields $p_s(X/U) = 0$ for all such U . Thus we proved that $p_{\mathbf{m}}(X) = 0$ for all $X \in \mathcal{C}_M$. \square

We denote by \mathcal{P}^* the dual of the PBW-basis \mathcal{P} of $U(\mathfrak{n})$. Define

$$\mathcal{P}_M^* := \{(p_1^*)^{m_1} \cdots (p_r^*)^{m_r} \mid m_i \geq 0\} \subseteq \mathcal{P}^*.$$

Recall that the dimension vectors of the indecomposable representations of the quiver Q are known ([K1]):

Theorem 20.5 (Kac). *There is an indecomposable representation in $\text{rep}(Q, d)$ if and only if $d \in \Delta^+$. Furthermore, there is (up to isomorphism) exactly one indecomposable representation in $\text{rep}(Q, d)$ if and only if $d \in \Delta_{\text{re}}^+$.*

Let $\Delta: U(\mathfrak{n}) \rightarrow U(\mathfrak{n}) \otimes U(\mathfrak{n})$ be the comultiplication of $U(\mathfrak{n})$. For $f \in U(\mathfrak{n})$ it is well known that

$$\Delta(f) = 1 \otimes f + f \otimes 1$$

if and only if $f \in \mathfrak{n}$, see for example [D]. As before, we identify $U(\mathfrak{n})$ and \mathcal{M} , and we denote the comultiplication of \mathcal{M} also by Δ . If $f \in \mathcal{M}_d$, $X' \in \Lambda_{d'}$ and $X'' \in \Lambda_{d''}$ with $d = d' + d''$, then

$$f(X' \oplus X'') = \Delta(f)(X', X''),$$

see [GLS1]. Thus, if $f \in \mathfrak{n}_d$ for some d , and $X \in \Lambda_d$ is not indecomposable, we can write $X = X' \oplus X''$ with $X' \neq 0 \neq X''$ and

$$f(X) = (1 \otimes f)(X', X'') + (f \otimes 1)(X', X'') = f(X') + f(X'') = 0,$$

since $\underline{\dim}(X') \neq d \neq \underline{\dim}(X'')$. Therefore we proved the following result:

Lemma 20.6. *For a dimension vector d , let Λ_d^{ind} be the constructible subset of Λ_d consisting of the indecomposable Λ -modules in Λ_d . If $f \in \mathfrak{n}_d$, then $\text{supp}(f) \subseteq \Lambda_d^{\text{ind}}$.*

We know by Lemma 20.2 that the map $\text{Res}_Q: \mathcal{M}_d \rightarrow \mathcal{M}_{Q,d}$ is injective. Thus, if $0 \neq f \in \mathcal{M}_d$, then $\text{Res}_Q(f) \neq 0$. Let d be a real root. Thus $\text{ind}(Q, d) = \mathcal{O}_{M'}$ for some $\mathbb{C}Q$ -module M' . Therefore, if $f \in \mathfrak{n}_d$, then

$$\text{Res}_Q(f) = c_{M'} \mathbf{1}_{\mathcal{O}_{M'}}$$

for some $c_{M'} \neq 0$. In particular, for the functions p_1, \dots, p_r in \mathbf{P} we get

$$\text{Res}_Q(p_i) = c_i \mathbf{1}_{\mathcal{O}(M_i)}$$

(for typographical reasons we write here $\mathcal{O}(M_i) = \mathcal{O}_{M_i}$). We can assume (after possibly rescaling the p_i) that $c_i = 1$ for all $1 \leq i \leq r$.

Lemma 20.7. *We have*

$$\text{Res}_Q(p_1^{(m_1)} \star \dots \star p_r^{(m_r)}) = \mathbf{1}_{\mathcal{O}(M_1)}^{(m_1)} \star \dots \star \mathbf{1}_{\mathcal{O}(M_r)}^{(m_r)} = \mathbf{1}_{\mathcal{O}_{M'}}$$

where $M' := M_1^{m_1} \oplus \dots \oplus M_r^{m_r}$.

Proof. Since $x(1) < x(2) < \dots < x(r)$ is a Γ_M -adapted ordering of the vertices of Γ_M , we get that $\text{Ext}_{\mathbb{C}Q}^1(M_i, M_j) = 0$ for all $i \geq j$. Now the result follows from the definition of the multiplication \star of constructible functions. \square

Lemma 20.8. *We have $\mathcal{P}_M^* = \{\delta_{(M',0)} \mid M' \in \text{add}(M)\}$.*

Proof. For $M', M'' \in \text{add}(M)$ with $M' := M_1^{m_1} \oplus \dots \oplus M_r^{m_r}$ we have

$$\begin{aligned} \delta_{(M'',0)}(p_1^{(m_1)} \star \dots \star p_r^{(m_r)}) &= (p_1^{(m_1)} \star \dots \star p_r^{(m_r)})(M'', 0) \\ &= \text{Res}_Q(p_1^{(m_1)} \star \dots \star p_r^{(m_r)})(M'') \\ &= \mathbf{1}_{\mathcal{O}_{M'}}(M'') = \begin{cases} 1 & \text{if } M' \cong M'', \\ 0 & \text{otherwise.} \end{cases} \end{aligned}$$

This follows from Lemma 20.7, and the fact that $(M'', 0)$ is the image of M'' under the natural inclusion $\text{rep}(Q) \rightarrow \text{nil}(\Lambda)$ which sends a $\mathbb{C}Q$ -module L to the Λ -module $(L, 0)$. Hence, using also Lemma 20.4, the claim is proved. \square

Proof of Theorem 20.1. Let $X \in \mathcal{C}_M$. By Lemma 20.4 and Lemma 20.8, δ_X is a linear combination of dual PBW-basis vectors of the form $\delta_{(M',0)}$ with $M' \in \text{add}(M)$. Hence $\delta_X \in \mathbb{C}[\delta_{(M_1,0)}, \dots, \delta_{(M_r,0)}]$, and

$$\text{Span}_{\mathbb{C}}\langle \delta_X \mid X \in \mathcal{C}_M \rangle \subseteq \mathbb{C}[\delta_{(M_1,0)}, \dots, \delta_{(M_r,0)}] \subseteq \mathcal{R}(\mathcal{C}_M).$$

Using the known reverse inclusions we get (i) and (ii) of Theorem 20.1.

Next, let $M' \in \text{add}(M)$. Thus $\delta_{(M',f_{M'})}$ is an element in the dual semicanonical basis \mathcal{S}^* . Since $(M', f_{M'}) \in \mathcal{C}_M$, we know that $\delta_{(M',f_{M'})} \in \mathcal{R}(\mathcal{C}_M)$. For dimension reasons this implies that

$$\mathcal{S}_M^* := \{ \delta_{(M',f_{M'})} \mid M' \in \text{add}(M) \} = \mathcal{S}^* \cap \mathcal{R}(\mathcal{C}_M)$$

is a \mathbb{C} -basis of $\mathcal{R}(\mathcal{C}_M)$. By what we proved before, the cluster monomials of $\mathcal{R}(\mathcal{C}_M)$ are a subset of \mathcal{S}_M^* . This proves (iii). \square

20.3. Example. Let us discuss an example of base change between \mathcal{P}_M^* and \mathcal{S}_M^* . Let Q be the quiver

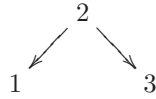

The Auslander-Reiten quiver of $\text{mod}(\mathbb{C}Q)$ looks as follows:

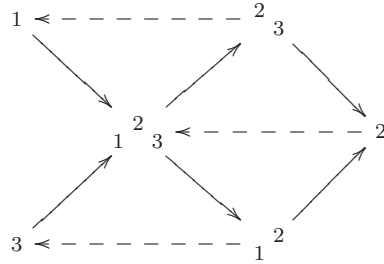

The Λ -modules $T_{i,[a,b]}$ are the following:

$$\begin{aligned} T_{1,[0,0]} &= \begin{matrix} 2 \\ 1 \end{matrix}, & T_{1,[1,1]} &= 3, & T_{1,[0,1]} &= \begin{matrix} 3 \\ 1 \ 2 \end{matrix}, \\ T_{2,[0,0]} &= 2, & T_{2,[1,1]} &= \begin{matrix} 2 \\ 1 \ 3 \end{matrix}, & T_{2,[0,1]} &= \begin{matrix} 2 \\ 1 \ 2 \ 3 \end{matrix}, \\ T_{3,[0,0]} &= \begin{matrix} 2 \\ 3 \end{matrix}, & T_{3,[1,1]} &= 1, & T_{3,[0,1]} &= \begin{matrix} 1 \\ 2 \\ 3 \end{matrix}. \end{aligned}$$

Let $M = M_1 \oplus \dots \oplus M_6$ be the direct sum of all six indecomposable $\mathbb{C}Q$ -modules. For each indecomposable Λ -module of the form $(M_i, 0)$ one easily checks that $\mathcal{F}_{i,X}$ is either empty or a single point, so $\chi_c(\mathcal{F}_{i,X})$ is either 0 or 1.

Thus the functions $\delta_{(M_i,0)}$ are known. Using Theorem 18.1 we get

$$\begin{aligned} \delta_{T_{1,[0,1]}} &= \delta_{T_{1,[1,1]}} \cdot \delta_{T_{1,[0,0]}} - \delta_{T_{2,[1,1]}}, \\ \delta_{T_{2,[0,1]}} &= \delta_{T_{2,[1,1]}} \cdot \delta_{T_{2,[0,0]}} - \delta_{T_{1,[0,0]}} \cdot \delta_{T_{3,[0,0]}}, \\ \delta_{T_{3,[0,1]}} &= \delta_{T_{3,[1,1]}} \cdot \delta_{T_{3,[0,0]}} - \delta_{T_{2,[1,1]}}. \end{aligned}$$

The initial cluster of our cluster algebra $\mathcal{R}(\mathcal{C}_M)$ looks as follows:

$$\begin{array}{ccccc}
 \delta_{T_{3,[1,1]}} & \xleftarrow{\delta_{T_{3,[1,1]}} \cdot \delta_{T_{3,[0,0]} - \delta_{T_{2,[1,1]}}} & & & \\
 & \searrow & \nearrow & & \\
 & \delta_{T_{2,[1,1]}} & & \delta_{T_{2,[1,1]}} \cdot \delta_{T_{2,[0,0]} - \delta_{T_{1,[0,0]} \cdot \delta_{T_{3,[0,0]}} & \\
 & \nearrow & \searrow & & \\
 \delta_{T_{1,[1,1]}} & \xleftarrow{\delta_{T_{1,[1,1]}} \cdot \delta_{T_{1,[0,0]} - \delta_{T_{2,[1,1]}}} & & &
 \end{array}$$

The cluster variables in $\mathcal{R}(\mathcal{C}_M)$ are

$$\left\{ \delta_{T_{i,[c,c]}}, \delta_{T_{i,[0,1]}} \mid 1 \leq i \leq 3 \text{ and } c = 0, 1 \right\} \cup \left\{ \delta_{1 \ 2}, \delta_{2 \ 3}, \delta_{1 \ 2 \ 3} \right\}.$$

(Here we consider the three coefficients $\delta_{T_{i,[0,1]}}$ also as cluster variables.) Beginning with our initial cluster we can mutate several times and get

$$\begin{aligned}
 \delta_{1 \ 2} &= \delta_1 \cdot \delta_2 - \delta_{1 \ 2}, \\
 \delta_{2 \ 3} &= \delta_2 \cdot \delta_3 - \delta_{2 \ 3}, \\
 \delta_{1 \ 2 \ 3} &= \delta_{1 \ 2 \ 3} + \delta_1 \cdot \delta_2 \cdot \delta_3 - \delta_1 \cdot \delta_{2 \ 3} - \delta_3 \cdot \delta_{1 \ 2}.
 \end{aligned}$$

So we wrote all cluster variables as linear combinations of dual PBW-basis vectors.

20.4. Non-adaptable Weyl group elements: an example. Let Γ be the graph

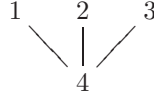

of type \mathbb{D}_4 . Let w be the Weyl group element $s_3 s_4 s_2 s_1 s_4$. The set of reduced expressions for w is $R(w) = \{(3, 4, 2, 1, 4), (3, 4, 1, 2, 4)\}$. It follows that w is not adaptable. Furthermore, an easy calculation shows that

$$\Delta_w^+ = \left\{ \begin{smallmatrix} 0 & 0 & 0 \\ 1 & 0 & 0 \end{smallmatrix}, \begin{smallmatrix} 1 & 0 & 0 \\ 0 & 1 & 0 \end{smallmatrix}, \begin{smallmatrix} 1 & 1 & 0 \\ 0 & 1 & 1 \end{smallmatrix} \right\}.$$

Let $\mathbf{i} = (3, 4, 2, 1, 4)$. Using a construction dual to the one in [BIRS, Section II.2], we obtain a subcategory \mathcal{C}_w of $\text{mod}(\Lambda)$, which by definition has a generator

$$T_{\mathbf{i}} := T_1 \oplus \cdots \oplus T_5 := 4 \oplus \begin{smallmatrix} 4 \\ 1 \end{smallmatrix} \oplus \begin{smallmatrix} 4 \\ 2 \end{smallmatrix} \oplus 1 \begin{smallmatrix} 4 \\ 2 \end{smallmatrix} \oplus 1 \begin{smallmatrix} 4 \\ 4 \\ 2 \\ 3 \end{smallmatrix}.$$

It follows that

$$\mathcal{C}_w = \text{add} \left(T_{\mathbf{i}} \oplus 1 \begin{smallmatrix} 4 \\ 2 \end{smallmatrix} \right).$$

We can think of \mathcal{C}_w as a categorification of a cluster algebra of type \mathbb{A}_1 with four coefficients.

Now let Q be any quiver with $|Q| = \Gamma$. By M_1, \dots, M_5 we denote the five indecomposable KQ -modules with $\Delta_w^+ = \{\dim(M_i) \mid 1 \leq i \leq 5\}$. Then the projection $\pi_Q(T_5)$ is not in $\text{add}(M)$. Note also that the dimension vector of T_5 is a root, but $\pi_Q(T_5)$ is a decomposable KQ -module. Another calculation shows that

$$\pi_Q^{-1}(\pi_Q(\mathcal{C}_w)) \neq \mathcal{C}_w.$$

This indicates that our proof of Theorem 20.1 does not work for non-adaptable Weyl group elements.

20.5. **Some generalities on bases of algebras.** We start with the following:

Lemma 20.9. *Let $M' = M'_1 \oplus M'_2$ be in $\text{add}(M)$ such that*

$$M'_2 \cong \bigoplus_{a=0}^{t_i} \tau^a(I_i)$$

for some i . Then we have $\delta_{(M', f_{M'})} = \delta_{(M'_1, f_{M'_1})} \cdot \delta_{(M'_2, f_{M'_2})}$.

Proof. Note that the Λ -module $(M'_2, f_{M'_2})$ is a projective-injective object in \mathcal{C}_M . The claim then follows easily from [GLS1, Theorem 1.1] in combination with explanations in [GLS1, Section 2.6]. \square

This lemma gives rise to the following definition: A $\mathbb{C}Q$ -module $M' \in \text{add}(M)$ is called *interval-free* if M' does not have a direct summand isomorphic to $I_i \oplus \tau(I_i) \oplus \cdots \oplus \tau^{t_i}(I_i)$.

Let $B := \{b_i \mid i \geq 1\}$ be a K -basis of a commutative K -algebra A . For some fixed $n \geq 1$ let $C := \{b_1, \dots, b_n\}$. A basis vector $b \in B$ is called *C-free* if $b \notin b_i B$ for some $b_i \in C$. Assume that the following hold:

- (i) For all $b_i \in C$ we have $b_i B \subseteq B$;
- (ii) If $b_1^{z_1} \cdots b_n^{z_n} b = b_1^{z'_1} \cdots b_n^{z'_n} b'$ for some $z_i, z'_i \geq 0$ and some C-free elements $b, b' \in B$, then $b = b'$ and $z_i = z'_i$ for all i .

It follows that

$$B = \{b_1^{z_1} \cdots b_n^{z_n} b \mid b \in B \text{ is C-free, } z_i \geq 0\}.$$

Define

$$\underline{A} := A/(b_1 - 1, \dots, b_n - 1).$$

For $a \in A$, let \underline{a} be the residue class of a in \underline{A} . Furthermore, let A_{b_1, \dots, b_n} be the localization of A at b_1, \dots, b_n . The following lemma is easy to show:

Lemma 20.10. *With the notation above, the following hold:*

- (1) The set $\underline{B} := \{\underline{b} \mid b \text{ is C-free}\}$ is a K -basis of \underline{A} ;
- (2) The set $B_{b_1, \dots, b_n} := \{b_1^{z_1} \cdots b_n^{z_n} b \mid b \text{ is C-free, } z_i \in \mathbb{Z}\}$ is a K -basis of A_{b_1, \dots, b_n} .

20.6. **Inverting and specializing coefficients.** One can rewrite the basis \mathcal{S}_M^* appearing in Theorem 3.4 as

$$\mathcal{S}_M^* = \left\{ (\delta_{T_{1, [0, t_1]}})^{z_1} \cdots (\delta_{T_{n, [0, t_n]}})^{z_n} \delta_{(M', f_{M'})} \mid M' \in \text{add}(M), M' \text{ interval-free, } z_i \geq 0 \right\}.$$

The next two theorems deal with the situation of invertible coefficients and specialized coefficients.

Theorem 20.11 (Invertible coefficients). *Let M be a terminal $\mathbb{C}Q$ -module. Then*

$$\tilde{\mathcal{S}}_M^* := \left\{ (\delta_{T_{1, [0, t_1]}})^{z_1} \cdots (\delta_{T_{n, [0, t_n]}})^{z_n} \delta_{(M', f_{M'})} \mid M' \in \text{add}(M), M' \text{ interval-free, } z_i \in \mathbb{Z} \right\}$$

is a \mathbb{C} -basis of $\tilde{\mathcal{R}}(\mathcal{C}_M)$, and $\tilde{\mathcal{S}}_M^*$ contains all cluster monomials of the cluster algebra $\tilde{\mathcal{R}}(\mathcal{C}_M)$.

Next, we specialize all n coefficients $\delta_{T_{i, [0, t_i]}}$ of the cluster algebra $\mathcal{R}(\mathcal{C}_M)$ to 1. We obtain a new cluster algebra $\underline{\mathcal{R}}(\mathcal{C}_M)$ which does not have any coefficients. The residue class of $\delta_X \in \mathcal{R}(\mathcal{C}_M)$ is denoted by $\underline{\delta}_X$.

Theorem 20.12 (No coefficients). *Let M be a terminal $\mathbb{C}Q$ -module. Then*

$$\underline{\mathcal{S}}_M^* := \left\{ \underline{\delta}_{(M', f_{M'})} \mid M' \in \text{add}(M), M' \text{ interval-free} \right\}$$

is a \mathbb{C} -basis of $\underline{\mathcal{R}}(\mathcal{C}_M)$, and $\underline{\mathcal{S}}_M^$ contains all cluster monomials of the cluster algebra $\underline{\mathcal{R}}(\mathcal{C}_M)$.*

Proof of Theorem 20.11 and Theorem 20.12. Let $B := \{b_i \mid i \geq 1\} := \mathcal{S}_M^*$ be the dual semicanonical basis of $\mathcal{R}(\mathcal{C}_M)$. We can label the b_i such that

$$\{b_1, \dots, b_n\} = \left\{ \delta_{T_{1, [0, t_1]}}, \dots, \delta_{T_{n, [0, t_n]}} \right\}.$$

Using Lemma 20.9 it is easy to check that the elements b_i satisfy the properties (i) and (ii) mentioned in Section 20.5. Then apply Lemma 20.10. \square

21. ACYCLIC CLUSTER ALGEBRAS

In this section we will study the case of acyclic cluster algebras, which is of special interest. Assume that M is a terminal $\mathbb{C}Q$ -module with $t_i(M) = 1$ for all i . Thus M is of the form

$$M = \bigoplus_{i=1}^n (I_i \oplus \tau(I_i)),$$

then $\mathcal{R}(\mathcal{C}_M)$ is an acyclic cluster algebra associated to Q having n coefficients, whereas $\underline{\mathcal{R}}(\mathcal{C}_M)$ is the acyclic cluster algebra associated to Q having no coefficients.

Theorem 21.1. *Let $M = M_1 \oplus \dots \oplus M_{2n}$ be a terminal $\mathbb{C}Q$ -module with $t_i(M) = 1$ for all i . Then the following hold:*

- (i) $\mathcal{R}(\mathcal{C}_M) = \mathbb{C}[\delta_{(M_1, 0)}, \dots, \delta_{(M_{2n}, 0)}] = \text{Span}_{\mathbb{C}} \langle \delta_X \mid X \in \mathcal{C}_M \rangle$;
- (ii) $\{\delta_{(M', 0)} \mid M' \in \text{add}(M)\}$ is a \mathbb{C} -basis of $\mathcal{R}(\mathcal{C}_M)$;
- (iii) $\{\underline{\delta}_{(M', 0)} \mid M' \in \text{add}(M), M' \text{ interval-free}\}$ is a \mathbb{C} -basis of $\underline{\mathcal{R}}(\mathcal{C}_M)$;
- (iv) There is an isomorphism of cluster algebras $\underline{\mathcal{R}}(\mathcal{C}_M) \cong \mathcal{A}_Q$, where \mathcal{A}_Q is the coefficient free acyclic cluster algebra associated to Q .

Proof. Part (i) and (ii) were already proved before for M arbitrary. Part (iv) is clear from our description of the initial seed (labelled by T_M) for the cluster algebra $\mathcal{R}(\mathcal{C}_M)$. It remains to prove (iii): We have

$$\mathcal{R}(\mathcal{C}_M) = \bigoplus_{d \in \mathbb{N}^n} \mathcal{R}_d$$

where \mathcal{R}_d is the \mathbb{C} -vector space with basis $\{\delta_{(M', f_{M'})} \mid M' \in \text{add}(M) \cap \text{rep}(Q, d)\}$. We know that $\{\delta_{(M', 0)} \mid M' \in \text{add}(M) \cap \text{rep}(Q, d)\}$ is a basis of \mathcal{R}_d as well. After specializing the coefficients $\delta_{T_{i, [0, 1]}}$ to 1, we get

$$\underline{\mathcal{R}}(\mathcal{C}_M) = \bigoplus_{d \in \mathbb{N}^n} \underline{\mathcal{R}}_d$$

where $\underline{\mathcal{R}}_d$ is the \mathbb{C} -vector space with basis

$$\left\{ \underline{\delta}_{(M', f_{M'})} \mid M' \in \text{add}(M) \cap \text{rep}(Q, d), M' \text{ interval-free} \right\}.$$

Now one can use the formula

$$\delta_{T_{i,[0,1]}} = \delta_{T_{i,[1,1]}} \cdot \delta_{T_{i,[0,0]}} - \prod_{i \rightarrow j} \delta_{T_{j,[1,1]}} \cdot \prod_{k \rightarrow i} \delta_{T_{k,[0,0]}}$$

(where the products are taken over all arrows of Q^{op} which start and end in i , respectively) and induction on the vertices of Q to show that for every interval-free $M' \in \text{add}(M)$, the vector $\underline{\delta}_{(M', f_{M'})}$ is a linear combination of elements of the form $\underline{\delta}_{(M'', 0)}$ where M'' is interval-free in $\text{add}(M)$ and $|\underline{\dim}(M'')| \leq |\underline{\dim}(M')|$. For dimension reasons we get that the vectors $\underline{\delta}_{(M'', 0)}$ with M'' interval-free form a linearly independent set. This implies (iii). \square

It is interesting to compare (iii) to Berenstein, Fomin and Zelevinsky's construction of a basis for the acyclic cluster algebra \mathcal{A}_Q . Let $\mathbf{y} := \{y_1, \dots, y_n\}$ be the initial cluster whose exchange matrix B_Q is encoded by Q , as in Section 3.1. Let $\{y_1^*, \dots, y_n^*\}$ be the n cluster variables obtained from \mathbf{y} by mutation in the n possible directions.

The n sets $\{y_1, \dots, y_n\} \setminus \{y_k\} \cup \{y_k^*\}$ are the neighbouring clusters of our initial cluster \mathbf{y} . Using a simple Gröbner basis argument, the following is shown in [BFZ]:

Theorem 21.2 (Berenstein, Fomin, Zelevinsky). *The monomials*

$$\{y_1^{p_1}(y_1^*)^{q_1} \cdots y_n^{p_n}(y_n^*)^{q_n} \mid p_i, q_i \geq 0, p_i q_i = 0\}$$

form a \mathbb{C} -basis of the acyclic cluster algebra \mathcal{A}_Q .

Now assume that the vertices $1, \dots, n$ of Q are numbered in such a way that 1 is a sink of Q , and $k + 1$ is a sink of $\sigma_k \cdots \sigma_2 \sigma_1(Q)$ for $1 \leq k \leq n - 1$. We perform n mutations $\mu_k \cdots \mu_2 \mu_1$, $1 \leq k \leq n$ of the initial seed (\mathbf{y}, B_Q) . In each step we obtain a new cluster variable which we denote by y_k^\dagger . Note that $y_1^\dagger = y_1^*$, but already y_2^\dagger and y_2^* may be different. Observe that $\mu_n \cdots \mu_2 \mu_1(B_Q) = B_Q$. We get that

$$(\{y_1^\dagger, \dots, y_n^\dagger\}, B_Q)$$

is a seed of the cluster algebra \mathcal{A}_Q where

$$\{y_1, \dots, y_n\} \cap \{y_1^\dagger, \dots, y_n^\dagger\} = \emptyset.$$

Our version of Theorem 21.2 looks then as follows:

Theorem 21.3. *The monomials*

$$\{y_1^{p_1}(y_1^\dagger)^{q_1} \cdots y_n^{p_n}(y_n^\dagger)^{q_n} \mid p_i, q_i \geq 0, p_i q_i = 0\}$$

form a \mathbb{C} -basis of the acyclic cluster algebra \mathcal{A}_Q .

Note that in our setting, the initial cluster $\{y_1, \dots, y_n\}$ comes from T_M and the cluster $\{y_1^\dagger, \dots, y_n^\dagger\}$ comes from T_M^\vee .

22. THE COORDINATE RINGS $\mathbb{C}[N(w)]$ AND $\mathbb{C}[N^w]$

22.1. Nilpotent Lie algebras and unipotent groups. As before, let

$$\widehat{\mathfrak{n}} := \prod_{\alpha \in \Delta^+} \mathfrak{n}_\alpha$$

be the completion of the Lie algebra \mathfrak{n} . This is a pro-nilpotent pro-Lie algebra. Let N be the pro-unipotent pro-group with Lie algebra $\widehat{\mathfrak{n}}$. We refer to Kumar's book [Ku, Section 4.4] for all missing definitions.

We can assume that $N = \widehat{\mathfrak{n}}$ as a set and that the multiplication of N is defined via the Baker-Campbell-Hausdorff formula. Hence the exponential map $\text{Exp}: \widehat{\mathfrak{n}} \rightarrow N$ is just the identity map.

Put $\mathcal{H} := U(\mathfrak{n})_{\text{gr}}^*$. This is a commutative Hopf algebra. We can regard \mathcal{H} as the coordinate ring $\mathbb{C}[N]$ of N , that is, we can identify N with the set

$$\text{maxSpec}(\mathcal{H}) \equiv \text{Hom}_{\text{alg}}(\mathcal{H}, \mathbb{C})$$

of \mathbb{C} -algebra homomorphisms $\mathcal{H} \rightarrow \mathbb{C}$. An element $f \in \text{Hom}_{\text{alg}}(\mathcal{H}, \mathbb{C})$ is determined by the images $c_i := f(p_i^*)$ for all $i \geq 1$.

It is well known (see e.g. [Ab, §3.4]) that $\text{Hom}_{\text{alg}}(\mathcal{H}, \mathbb{C})$ can also be identified with the group $G(\mathcal{H}^\circ)$ of all group-like elements of the dual Hopf algebra \mathcal{H}° of \mathcal{H} , by mapping $f \in \text{Hom}_{\text{alg}}(\mathcal{H}, \mathbb{C})$ to

$$y_f = \sum_{\mathbf{m}} \left(\prod_i c_i^{m_i} \right) p_{\mathbf{m}} \in G(\mathcal{H}^\circ).$$

Note that the map $f \mapsto y_f$ does not depend on the choice of the PBW-basis $\{p_{\mathbf{m}}\}$. Note also that $G(\mathcal{H}^\circ)$ is contained in the vector space dual \mathcal{H}^* of \mathcal{H} , which is the completion $\widehat{U(\mathfrak{n})}$ of $U(\mathfrak{n})$ with respect to its natural grading. When we use this second identification, an element $x \in N = \widehat{\mathfrak{n}}$ is simply represented by the group-like element

$$\exp(x) := \sum_{k \geq 0} x^k / k!$$

in $\widehat{U(\mathfrak{n})}$. To summarize, we have $\mathcal{H} = U(\mathfrak{n})_{\text{gr}}^* \equiv \mathbb{C}[N]$ and

$$N \equiv \text{maxSpec}(\mathcal{H}) \equiv \text{Hom}_{\text{alg}}(\mathcal{H}, \mathbb{C}) \equiv G(\mathcal{H}^\circ) \subset \mathcal{H}^\circ \subset \mathcal{H}^* = \widehat{U(\mathfrak{n})}.$$

Let Θ be a bracket closed subset of Δ^+ . Recall from Section 19.3 the definition of the Lie subalgebra $\widehat{\mathfrak{n}}(\Theta) \subseteq \widehat{\mathfrak{n}}$. Let $N(\Theta) := \text{Exp}(\widehat{\mathfrak{n}}(\Theta))$ be the corresponding pro-unipotent pro-group. For example, if $\alpha \in \Delta_{\text{re}}^+$, then $\Theta_\alpha := \{\alpha\}$ is bracket closed. In this case, $N(\alpha)$ is called the *one-parameter subgroup* of N associated to α . We have an isomorphism of groups $N(\alpha) \cong (\mathbb{C}, +)$.

If Θ is bracket closed and bracket coclosed, then set $N'(\Theta) := N(\Delta^+ \setminus \Theta)$. In this case, the multiplication yields a bijection [Ku, Lemma 6.1.2]

$$m: N(\Theta) \times N'(\Theta) \rightarrow N.$$

For $w \in W$ let $N(w) := N(\Delta_w^+)$ be the unipotent algebraic group of dimension $l(w)$ associated to the Lie algebra $\mathfrak{n}(w)$. Similarly, define $N'(w) := N'(\Delta_w^+)$.

22.2. The coordinate ring $\mathbb{C}[N(w)]$ as a ring of invariants. We start by noting that the PBW-basis of $U(\mathfrak{n})$ and the dual PBW-basis of $U(\mathfrak{n})^*$ are homogeneous with respect to the (root lattice) \mathbb{N}^n -grading of $U(\mathfrak{n})$. We write $|\mathbf{m}| = d \in \mathbb{N}^n$ in case $p_{\mathbf{m}}$ is a homogeneous element of degree $d \in \mathbb{N}^n$. Let us denote by $(\mathbf{e}_i)_{i \in J}$ the usual coordinate vectors of $\mathbb{Z}^{(J)}$. For example, $|\mathbf{e}_i| = \alpha(i)$ for $1 \leq i \leq r$.

The multiplication $\mu: U(\mathfrak{n}) \otimes U(\mathfrak{n}) \rightarrow U(\mathfrak{n})$ is given by its effect on the PBW-basis, say

$$p_{\mathbf{m}} \cdot p_{\mathbf{n}} = \sum_{|\mathbf{k}|=|\mathbf{m}+\mathbf{n}|} c_{\mathbf{m},\mathbf{n}}^{\mathbf{k}} p_{\mathbf{k}}.$$

Next, the comultiplication $\mu^*: \mathbb{C}[N] \rightarrow \mathbb{C}[N] \otimes \mathbb{C}[N]$ is a ring homomorphism, so it is determined by the value on the generators $p_i^* = p_{\mathbf{e}_i}^*$. By construction, we have

$$\mu^*(p_i^*) = \sum_{|\mathbf{m}+\mathbf{n}|=|\mathbf{e}_i|} c_{\mathbf{m},\mathbf{n}}^{\mathbf{e}_i} p_{\mathbf{m}}^* \otimes p_{\mathbf{n}}^*$$

Lemma 22.1. *Let $1 \leq i \leq r$ and $0 \neq \mathbf{n} \in \mathbb{N}^{(J)}$ such that $n_j = 0$ for $1 \leq j \leq r$. Then $c_{\mathbf{m},\mathbf{n}}^{\mathbf{e}_i} = 0$.*

Proof. Let $\mathbf{m} = \mathbf{m}^< + \mathbf{m}^>$ such that $m_j^< = 0$ for $j > r$ and $m_j^> = 0$ for $1 \leq j \leq r$, so $p_{\mathbf{m}} = p_{\mathbf{m}^<} \cdot p_{\mathbf{m}^>}$. Since Δ_w^+ is bracket closed and coclosed we have

$$p_{\mathbf{m}^>} \cdot p_{\mathbf{n}} = \sum_{|\mathbf{k}'|=|\mathbf{m}^>+\mathbf{n}|} c_{\mathbf{m}^>,\mathbf{n}}^{\mathbf{k}'} p_{\mathbf{k}'}$$

with $k'_j = 0$ for $1 \leq j \leq r$. Thus

$$p_{\mathbf{m}} \cdot p_{\mathbf{n}} = \sum_{|\mathbf{k}'|=|\mathbf{m}^>+\mathbf{n}|} c_{\mathbf{m}^>,\mathbf{n}}^{\mathbf{k}'} p_{\mathbf{k}'+\mathbf{m}^<}$$

Putting $\mathbf{k} = \mathbf{k}' + \mathbf{m}^<$ we get $c_{\mathbf{m},\mathbf{n}}^{\mathbf{k}} = c_{\mathbf{m}^>,\mathbf{n}}^{\mathbf{k}'}$. Thus, if in our situation $c_{\mathbf{m},\mathbf{n}}^{\mathbf{k}} \neq 0$ then $k_j \neq 0$ for some $k > r$. \square

Now, let us turn to the subgroups $N(w)$ and $N'(w)$. Consider the ideals

$$I(w) := (p_{r+1}^*, p_{r+2}^*, \dots), \quad I'(w) = (p_1^*, \dots, p_r^*)$$

in $\mathbb{C}[N]$. Then we have

$$\begin{aligned} N(w) &= \{\nu \in \text{Hom}_{\text{alg}}(\mathbb{C}[N], \mathbb{C}) \mid \nu(I(w)) = 0\}, \text{ and} \\ N'(w) &= \{\nu' \in \text{Hom}_{\text{alg}}(\mathbb{C}[N], \mathbb{C}) \mid \nu'(I'(w)) = 0\}. \end{aligned}$$

In other words we have canonically $\mathbb{C}[N(w)] = \mathbb{C}[N]/I(w)$ and $\mathbb{C}[N'(w)] = \mathbb{C}[N]/I'(w)$.

We consider the action of $N'(w)$ on N via *right* multiplication. By definition, this comes from the left action of $N'(w)$ on $\mathbb{C}[N]$ given by

$$\nu' \cdot f = (\text{id} \otimes \nu') \mu^*(f)$$

for $f \in \mathbb{C}[N]$ and $\nu' \in N'(w)$. (Here we identify $\mathbb{C}[N] \otimes \mathbb{C} \equiv \mathbb{C}[N]$ in the canonical way.)

We denote by $\mathbb{C}[N]^{N'(w)}$ the invariant subring for this group action.

Proposition 22.2. *Consider the injective ring homomorphism*

$$\tilde{\pi}_w^*: \mathbb{C}[N(w)] \rightarrow \mathbb{C}[N]$$

defined by $p_i^ + I(w) \mapsto p_i^*$ for $1 \leq i \leq r$. The corresponding morphism (of schemes) $\tilde{\pi}_w: N \rightarrow N(w)$ is $N'(w)$ -invariant and is a retraction for the inclusion of $N(w)$ into N . As a consequence, $\tilde{\pi}_w^*$ identifies $\mathbb{C}[N(w)]$ with $\mathbb{C}[N]^{N'(w)} = \mathbb{C}[p_1^*, \dots, p_r^*]$.*

Proof. We have

$$\mu^*(p_i^*) = 1 \otimes p_i^* + p_i^* \otimes 1 + \sum_{|\mathbf{m}+\mathbf{n}|=|\mathbf{e}_i|} c_{\mathbf{m},\mathbf{n}}^{\mathbf{e}_i} p_{\mathbf{m}}^* \otimes p_{\mathbf{n}}^*$$

where in the last sum $|\mathbf{m}| \neq 0 \neq |\mathbf{n}|$. Thus for $1 \leq i \leq r$ and $\nu' \in N'(w)$ we get

$$\nu' \cdot p_i^* = 1 \cdot 0 + p_i^* \cdot 1 + \sum_{|\mathbf{m}+\mathbf{n}|=|\mathbf{e}_i|} c_{\mathbf{m},\mathbf{n}}^{\mathbf{e}_i} p_{\mathbf{m}}^* \cdot \nu'(p_{\mathbf{n}}^*)$$

with the last sum vanishing by Lemma 22.1 and the definition of $N'(w)$. In other words, $p_i^* \in \mathbb{C}[N]^{N'(w)}$ for $1 \leq i \leq r$. Thus, $\tilde{\pi}_w: N \rightarrow N(w)$ is $N'(w)$ -equivariant, that is, $\tilde{\pi}_w(nn') = \tilde{\pi}_w(n)$ for any $n' \in N'(w)$.

Now, since the multiplication map $N(w) \times N'(w) \rightarrow N$ is bijective, each $N'(w)$ -orbit on N is of the form $n \cdot N'(w)$ for a unique $n \in N(w)$. We conclude that the inclusion $N(w) \hookrightarrow N$ is a section for $\tilde{\pi}_w$. Our claim follows. \square

By Theorem 20.1 we know that $\mathcal{R}(\mathcal{C}_M) = \mathbb{C}[p_1^*, \dots, p_r^*]$. Therefore we have proved:

Corollary 22.3. *Under the identification $U(\mathfrak{n})_{\text{gr}}^* \cong \mathbb{C}[N]$ the cluster algebra $\mathcal{R}(\mathcal{C}_M)$ gets identified to the ring of invariants $\mathbb{C}[N]^{N'(w)}$, which is isomorphic to $\mathbb{C}[N(w)]$.*

22.3. The coordinate ring $\mathbb{C}[N^w]$ as a localization of $\mathbb{C}[N]^{N'(w)}$. We start with some generalities on Kac-Moody groups. Let G^{\min} be the Kac-Moody group with $\text{Lie}(G^{\min}) = \mathfrak{g}$ constructed by Kac-Peterson (see [Ku, 7.4]). It has a refined Tits system

$$(G^{\min}, \text{Norm}_G^{\min}(H), N \cap G^{\min}, N_-, H).$$

Write $N^{\min} := G^{\min} \cap N$. Moreover, G^{\min} is an affine ind-variety in a unique way [Ku, 7.4.8].

For any real root α of \mathfrak{g} , the one-parameter root subgroup $N(\alpha)$ is contained in G^{\min} , and the $N(\alpha)$ together with H generate G^{\min} as a group. We have an anti-automorphism $g \mapsto g^T$ of G^{\min} which maps $N(\alpha)$ to $N(-\alpha)$ for each real root α , and fixes H . We have another anti-automorphism $g \mapsto g^t$ which fixes $N(\alpha)$ for every real root α and such that $h^t = h^{-1}$ for every $h \in H$.

For $i = 1, \dots, n$ we have a unique homomorphism $\varphi_i: SL_2(\mathbb{C}) \rightarrow G^{\min}$ satisfying

$$\varphi_i \begin{pmatrix} 1 & t \\ 0 & 1 \end{pmatrix} = \exp(te_i), \quad \varphi_i \begin{pmatrix} 1 & 0 \\ t & 1 \end{pmatrix} = \exp(tf_i), \quad (t \in \mathbb{C}).$$

We define

$$\bar{s}_i = \varphi_i \begin{pmatrix} 0 & -1 \\ 1 & 0 \end{pmatrix}.$$

For $w \in W$, we define $\bar{w} = \bar{s}_{i_r} \cdots \bar{s}_{i_1}$, where (i_r, \dots, i_1) is a reduced expression for w . Thus, we choose for every $w \in W$ a particular representative \bar{w} of w in the normalizer $\text{Norm}_G(H)$.

We have the following analogue of the Gaussian decomposition.

Proposition 22.4. *Let G_0 be the subset $N_- \cdot H \cdot N^{\min}$ of G^{\min} .*

- (i) *The subset G_0 is dense open in G^{\min} and each element $g \in G_0$ admits a unique factorization $g = [g]_- [g]_0 [g]_+$ with $[g]_- \in N_-$, $[g]_0 \in H$ and $[g]_+ \in N^{\min}$.*
- (ii) *The map $g \mapsto [g]_+$ (resp. $g \mapsto [g]_0$) is a morphism of ind-varieties from G_0 to N^{\min} (resp. to H).*

Part (i) follows from the fundamental properties of a refined Tits system [Ku, Theorem 5.2.3]. For part (ii), see [Ku, Proposition 7.4.11].

Following Fomin and Zelevinsky [FZ1] we can now define for each ϖ_j a generalized minor $\Delta_{\varpi_j, \varpi_j}$ as the regular function on G^{\min} such that

$$\Delta_{\varpi_j, \varpi_j}(g) = [g]_0^{\varpi_j}, \quad (g \in G_0).$$

For $w \in W$, we also define $\Delta_{\varpi_j, w(\varpi_j)}$ by

$$\Delta_{\varpi_j, w(\varpi_j)}(g) = \Delta_{\varpi_j, \varpi_j}(g\bar{w}).$$

The generalized minors have the following alternative description. Let $L(\varpi_j)$ denote the irreducible highest weight \mathfrak{g} -module with highest weight ϖ_j . Let v_j be a highest weight vector of $L(\varpi_j)$. This is an integrable module, so it is also a representation of G^{\min} .

Proposition 22.5. *Let $g \in G$. The coefficient of v_j in the projection of gv_j on the weight space $L(\varpi_j)_{\varpi_j}$ is equal to $\Delta_{\varpi_j, \varpi_j}(g)$.*

Proof. Let $g = [g]_- [g]_0 [g]_+ \in G_0$. We have $[g]_+ v_j = v_j$, and $[g]_0 v_j = [g]_0^{\varpi_j} v_j$. The result then follows from the fact that $[g]_- v_j$ is equal to v_j plus elements in lower weights. \square

Proposition 22.6. *We have*

$$G_0 = \{g \in G^{\min} \mid \Delta_{\varpi_i, \varpi_i}(g) \neq 0 \text{ for } 1 \leq i \leq n\}.$$

Proof. We use the Birkhoff decomposition [Ku, Theorem 5.2.3]

$$G^{\min} = \bigsqcup_{w \in W} N_- \bar{w} H N^{\min},$$

where G_0 is the subset of the right-hand side corresponding to $w = e$. If $g = [g]_- [g]_0 [g]_+ \in G_0$, then $\Delta_{\varpi_j, \varpi_j}(g) = [g]_0^{\varpi_j} \neq 0$. Conversely, if $g \notin G_0$ we have $g = n_- w h n$ for some $n_- \in N_-$, $n \in N^{\min}$, $h \in H$ and $w \neq e$. Then for some j we have $w(\varpi_j) \neq \varpi_j$ and $\bar{w} h n v_j$ is a multiple of the extremal weight vector $\bar{w} v_j$. Since the projection of $n_- \bar{w} v_j$ on the highest weight space of $L(\varpi_j)$ is zero, it follows that $\Delta_{\varpi_j, \varpi_j}(g) = 0$. Finally, note that for any $j > n$ the minor $\Delta_{\varpi_j, \varpi_j}$ does not vanish on G^{\min} . Indeed, the corresponding highest weight irreducible module $L(\varpi_j)$ is one-dimensional since $\varpi_j(\alpha_i) = 0$ for any i . Hence in the above description of G_0 , we may omit the minors $\Delta_{\varpi_j, \varpi_j}$ with $j > n$. \square

Let us now consider the groups $N(w)$ and $N'(w)$ introduced in Section 22.1.

Lemma 22.7. *We have*

$$\begin{aligned} N(w) &= N \cap (w^{-1} N_- w), \\ N'(w) &= N \cap (w^{-1} N w), \\ N'(w) \cap N^{\min} &= N^{\min} \cap (w^{-1} N^{\min} w). \end{aligned}$$

Proof. This follows from [Ku, 5.2.3] and [Ku, 6.2.8]. \square

It follows that $\Delta_{\varpi_j, w^{-1}(\varpi_j)}$ is invariant under the action of $N'(w) \cap N^{\min}$ on G^{\min} via right multiplication. Indeed, for $g \in G^{\min}$ and $n' \in N'(w) \cap N^{\min}$, we have $n' w^{-1} = w^{-1} n''$ for some $n'' \in N'(w) \cap N^{\min}$, hence

$$\begin{aligned} \Delta_{\varpi_j, w^{-1}(\varpi_j)}(gn') &= \Delta_{\varpi_j, \varpi_j}(gn' \bar{w}^{-1}) = \Delta_{\varpi_j, \varpi_j}(g \bar{w}^{-1} n'') \\ &= \Delta_{\varpi_j, \varpi_j}(g \bar{w}^{-1}) = \Delta_{\varpi_j, w^{-1}(\varpi_j)}(g). \end{aligned}$$

Define

$$N_w := \{n \in N^{\min} \mid \Delta_{\varpi_i, w^{-1}(\varpi_i)}(n) \neq 0 \text{ for all } i\}.$$

This is the subset of N^{\min} consisting of elements n such that $\bar{w} n^T \in G_0$. Indeed,

$$\Delta_{\varpi_i, w^{-1}(\varpi_i)}(n) = \Delta_{\varpi_i, \varpi_i}(n \bar{w}^{-1}) = \Delta_{\varpi_i, \varpi_i}((n \bar{w}^{-1})^T) = \Delta_{\varpi_i, \varpi_i}(\bar{w} n),$$

since $\bar{w}^{-1} = \bar{w}^T$.

Following [BZ, Section 5], we can now define the map $\tilde{\eta}_w: N_w \rightarrow N^{\min}$ given by

$$\tilde{\eta}_w(z) = [\overline{wz^T}]_+.$$

Proposition 22.8. *The following properties hold:*

- (i) *The map $\tilde{\eta}_w$ is a morphism of ind-varieties.*
- (ii) *The image of $\tilde{\eta}_w$ is N^w .*
- (iii) *$\tilde{\eta}_w(x) = \tilde{\eta}_w(y)$ if and only if $x = yn'$ for some $n' \in N'(w) \cap N^{\min}$.*
- (iv) *$\tilde{\eta}_w$ restricts to a bijective morphism $N(w) \cap N_w \rightarrow N^w$.*
- (v) *We have $N^w \subset N_w$, and $\tilde{\eta}_w$ restricts to a bijection $\eta_w: N^w \rightarrow N^w$.*
- (vi) *The inverse of η_w is given by $\eta_w^{-1}(x) = \eta_{w^{-1}}(x^t)^t$ for $x \in N^w$. It follows that η_w is an automorphism of N^w .*

Proof. Property (i) follows from Proposition 22.4 (ii). Next, we have

$$[\overline{wz^T}]_+ = ([\overline{wz^T}]_0^{-1}[\overline{wz^T}]_-^{-1})\overline{wz^T} \in B_- \overline{w} B_-.$$

This shows that the image of $\tilde{\eta}_w$ is contained in N^w . The rest of Property (ii) and Property (iii) are proved as in [BZ, Proposition 5.1]. Property (iv) follows from (ii), (iii), and the decomposition $N^{\min} = N(w) \times (N'(w) \cap N^{\min})$. Finally, (v) and (vi) are proved exactly in the same way as in [BZ, Propositions 5.1, 5.2]. \square

Proposition 22.9. *The map $\tilde{\pi}_w$ restricts to a morphism $\pi_w: N^w \rightarrow N_w \cap N(w)$. This is an isomorphism with inverse*

$$\eta_w^{-1} \tilde{\eta}_w: N_w \cap N(w) \rightarrow N^w.$$

In particular, N^w is an affine variety with coordinate ring identified to the localized ring $\mathbb{C}[N]_{\Delta_w}^{N'(w)}$, where

$$\Delta_w = \prod_{i=1}^n \Delta_{\varpi_i, w^{-1}\varpi_i}.$$

Proof. By Proposition 22.8 (iv) and (v), we know that $\eta_w^{-1} \tilde{\eta}_w$ is a bijection. On the other hand $\tilde{\pi}_w(N^w) \subset N(w) \cap N_w$ because $N^w \subset N_w$. Now, by Proposition 22.8 (iii), we have that

$$\tilde{\eta}_w(\pi_w(x)) = \tilde{\eta}_w(x) = \eta_w(x)$$

for every $x \in N^w$. Hence $\eta_w^{-1} \tilde{\eta}_w \pi_w(x) = x$ for every x in N^w . So we have $\eta_w^{-1} \tilde{\eta}_w \pi_w = \text{id}_{N^w}$, and this proves that π_w is the inverse of $\eta_w^{-1} \tilde{\eta}_w$.

These maps are morphisms of varieties so they induce isomorphisms

$$\mathbb{C}[N^w] \xrightarrow{\sim} \mathbb{C}[N(w) \cap N_w] = \mathbb{C}[N(w)]_{\Delta_w} \xrightarrow{\sim} \mathbb{C}[N]_{\Delta_w}^{N'(w)}.$$

\square

22.4. Generalized minors arising from T_M^\vee . For $w \in W$ and $1 \leq j \leq n$, we denote by $D_{\varpi_j, w(\varpi_j)}$ the restriction of the generalized minor $\Delta_{\varpi_j, w(\varpi_j)}$ to N . For example, D_{ϖ_j, ϖ_j} is equal to the constant function 1.

Recall the identifications $\mathcal{M}^* \equiv U(\mathfrak{n})_{\text{gr}}^* = \mathbb{C}[N]$. To every $X \in \text{nil}(\Lambda)$, we have associated a linear form $\delta_X \in U(\mathfrak{n})_{\text{gr}}^*$. We shall also denote δ_X by φ_X when we regard it as a function on N . For $i = 1, \dots, n$, define

$$x_i(t) := \exp(te_i).$$

The following formula shows how to evaluate φ_X on a product of $x_i(t)$'s. To state it, we introduce some notation. Given a sequence $\mathbf{i} = (i_1, \dots, i_k)$ and $X \in \text{nil}(\Lambda)$, we denote by $\mathcal{F}_{\mathbf{i}, X}$ the variety of ascending flags of submodules

$$0 = X_0 \subset X_1 \subset \dots \subset X_k = X$$

with $X_j/X_{j-1} \cong S_{i_j}$ ($j = 1, \dots, k$). Equivalently, a point of $\mathcal{F}_{\mathbf{i}, X}$ can be seen as a composition series of X of type \mathbf{i} .

Proposition 22.10. *Let $X \in \text{nil}(\Lambda)$. We have*

$$\varphi_X(x_{i_1}(t_1) \cdots x_{i_k}(t_k)) = \sum_{\mathbf{a}=(a_1, \dots, a_k) \in \mathbb{N}^k} \chi_c(\mathcal{F}_{\mathbf{i}^{\mathbf{a}}, X}) \frac{t_1^{a_1} \cdots t_k^{a_k}}{a_1! \cdots a_k!}.$$

Here $\mathbf{i}^{\mathbf{a}}$ is short for the sequence $(i_1, \dots, i_1, \dots, i_k, \dots, i_k)$ consisting of a_1 letters i_1 followed by a_2 letters i_2 , etc.

Proof. By Section 22.1 we can regard $x_{i_1}(t_1) \cdots x_{i_k}(t_k)$ as an element of $\widehat{U(\mathfrak{n})}$, namely,

$$x_{i_1}(t_1) \cdots x_{i_k}(t_k) = \sum_{\mathbf{a}=(a_1, \dots, a_k) \in \mathbb{N}^k} \frac{t_1^{a_1} \cdots t_k^{a_k}}{a_1! \cdots a_k!} e_{i_1}^{a_1} \cdots e_{i_k}^{a_k}.$$

It follows from the identification $\varphi_X = \delta_X$ that

$$\varphi_X(x_{i_1}(t_1) \cdots x_{i_k}(t_k)) = \sum_{\mathbf{a}=(a_1, \dots, a_k) \in \mathbb{N}^k} \frac{t_1^{a_1} \cdots t_k^{a_k}}{a_1! \cdots a_k!} \delta_X(e_{i_1}^{a_1} \cdots e_{i_k}^{a_k}).$$

Now, in the geometric realization \mathcal{M} of the enveloping algebra $U(\mathfrak{n})$ in terms of constructible functions, $e_{i_1}^{a_1} \cdots e_{i_k}^{a_k}$ becomes the convolution product $\mathbf{1}_{i_1}^{a_1} \star \cdots \star \mathbf{1}_{i_k}^{a_k}$ and it is easy to see that

$$\delta_X(\mathbf{1}_{i_1}^{a_1} \star \cdots \star \mathbf{1}_{i_k}^{a_k}) = \chi_c(\mathcal{F}_{\mathbf{i}^{\mathbf{a}}, X}).$$

□

Remark 22.11. The formula for φ_X given in [GLS5, §9] involves descending flags instead of ascending flags of submodules of X . This is because in the present paper we have taken a convolution product \star opposite to that of our previous papers (see Remark 19.4).

We are going to show that all generalized minors $D_{\varpi_j, w(\varpi_j)}$ can be expressed as some functions φ_X for certain Λ -modules X . In order to do this, we need to recall some results on Kac-Moody groups.

Let $\mathbb{C}[G^{\min}]_{\text{s.r.}}$ denote the algebra of strongly regular functions on G^{\min} [KP, §2C]. Define the invariant ring

$$\mathbb{C}[N_- \backslash G^{\min}]_{\text{s.r.}} = \{f \in \mathbb{C}[G^{\min}]_{\text{s.r.}} \mid f(ng) = f(g) \text{ for all } n \in N_-, g \in G^{\min}\}.$$

This ring is endowed with the usual left action of G^{\min} given by

$$(g \cdot f)(g') = f(g'g), \quad (f \in \mathbb{C}[N_- \backslash G^{\min}]_{\text{s.r.}}, g, g' \in G^{\min}).$$

It was proved by Kac and Peterson [KP, Cor. 2.2] that as a left G^{\min} -module, it decomposes as follows

$$\mathbb{C}[N_- \backslash G^{\min}]_{\text{s.r.}} = \bigoplus_{\lambda \in P^+} L(\lambda).$$

This is a multiplicity-free decomposition, in which the highest weight irreducible module $L(\lambda)$ is carried by the subspace

$$S(\lambda) = \{f \in \mathbb{C}[N_- \backslash G^{\min}]_{\text{s.r.}} \mid f(hg) = \Delta_{\lambda}(h)f(g) \text{ for all } h \in H, g \in G^{\min}\},$$

where we denote

$$\Delta_\lambda := \prod_j \Delta_{\varpi_j, \varpi_j}^{\lambda(\alpha_j^\vee)}.$$

Clearly, $\Delta_\lambda \in S(\lambda)$ and is a highest weight vector. Moreover, for any $w \in W$, the one-dimensional extremal weight space of $S(\lambda)$ with weight $w(\lambda)$ is spanned by

$$\Delta_{w(\lambda)} := \prod_j \Delta_{\varpi_j, w(\varpi_j)}^{\lambda(\alpha_j^\vee)}.$$

Now consider the restriction map

$$\rho: \mathbb{C}[N_- \backslash G^{\min}]_{\text{s.r.}} \rightarrow \mathbb{C}[N^{\min}]_{\text{s.r.}}$$

given by restriction of functions from G^{\min} to N^{\min} .

Lemma 22.12. *For every $\lambda \in P^+$, the restriction*

$$\rho_\lambda: S(\lambda) \rightarrow \mathbb{C}[N^{\min}]_{\text{s.r.}}$$

of ρ to $S(\lambda)$ is injective.

Proof. We have

$$N^{\min} \subset G_0 = N_- H N^{\min} = B_- N^{\min}.$$

It follows that the natural projection from G^{\min} onto $B_- \backslash G^{\min}$ restricts to an embedding of N^{\min} , with image the open subset of the flag variety $\mathcal{X} = B_- \backslash G^{\min}$ defined by the non-vanishing of the minors $\Delta_{\varpi_j, \varpi_j}$. Now $\mathbb{C}[N_- \backslash G^{\min}]_{\text{s.r.}}$ can be regarded as the multi-homogeneous coordinate ring of \mathcal{X} with homogeneous components $S(\lambda)$ ($\lambda \in P^+$). It follows that $\mathbb{C}[N^{\min}]$ can be identified with the subring of degree 0 homogeneous elements of the localized ring obtained from $\mathbb{C}[N_- \backslash G^{\min}]_{\text{s.r.}}$ by formally inverting the element

$$\Delta = \prod_j \Delta_{\varpi_j, \varpi_j}.$$

Therefore, the restriction ρ_λ of ρ to every homogeneous piece $S(\lambda)$ is an embedding. \square

It follows that we can transport the G^{\min} -module structure from $S(\lambda)$ to $\rho(S(\lambda))$ by setting

$$g \cdot \varphi = \rho(g \cdot \rho_\lambda^{-1}(\varphi)), \quad (g \in G^{\min}, \varphi \in \rho(S(\lambda))).$$

In this way, we can identify the highest weight module $L(\lambda)$ with the subspace $\rho(S(\lambda))$ of $\mathbb{C}[N^{\min}]_{\text{s.r.}}$. The highest weight vector is now $\rho(\Delta_\lambda) = 1$, and the extremal weight vectors are the minors

$$D_{w(\lambda)} := \prod_j D_{\varpi_j, w(\varpi_j)}^{\lambda(\alpha_j^\vee)},$$

for $w \in W$.

At this point, we note that a strongly regular function on N^{\min} is just the same as an element of $U(\mathfrak{n})_{\text{gr}}^*$. Indeed, the elements of $\mathbb{C}[N^{\min}]_{\text{s.r.}}$ are the restrictions to N^{\min} of the linear combinations of matrix coefficients of the irreducible integrable representations $L(\lambda)$ ($\lambda \in P^+$) of G^{\min} (see [KP, Lemma 4.2]). Now, by Theorem 19.9, we can realize every $L(\lambda)$ as a subspace of $U(\mathfrak{n})_{\text{gr}}^*$, and every $f \in U(\mathfrak{n})_{\text{gr}}^*$ belongs to such a subspace for λ sufficiently dominant. It follows that each element of $U(\mathfrak{n})_{\text{gr}}^*$ can be seen as a matrix coefficient for some $L(\lambda)$, and vice-versa. We can therefore identify

$$\mathbb{C}[N^{\min}]_{\text{s.r.}} \equiv U(\mathfrak{n})_{\text{gr}}^* \equiv \mathbb{C}[N].$$

Moreover, these two ways of embedding $L(\lambda)$ in $\mathbb{C}[N]$ coincide.

Lemma 22.13. *Under the identification $U(\mathfrak{n})_{\text{gr}}^* \equiv \mathbb{C}[N^{\min}]_{\text{s.r.}}$, the embedding of $L(\lambda)$ in $U(\mathfrak{n})_{\text{gr}}^*$ given by Theorem 19.9 coincides with $\rho(S(\lambda))$.*

Proof. The natural right action of $U(\mathfrak{n})$ on $U(\mathfrak{n})_{\text{gr}}^*$ defined before Corollary 19.10 coincides with the right action of $U(\mathfrak{n})$ on $\mathbb{C}[N^{\min}]_{\text{s.r.}}$ obtained by differentiating the right regular representation of N^{\min} :

$$(f \cdot n)(x) = f(nx), \quad (x, n \in N^{\min}, f \in \mathbb{C}[N^{\min}]_{\text{s.r.}}).$$

Consider first the case of a fundamental weight $\lambda = \varpi_j$. It is easy to check that

$$\Delta_{\varpi_j, \varpi_j}(x_i(t)g) = \begin{cases} \Delta_{\varpi_j, \varpi_j}(g) & \text{if } i \neq j, \\ \Delta_{\varpi_j, \varpi_j}(g) + t\Delta_{s_j(\varpi_j), \varpi_j}(g) & \text{if } i = j. \end{cases}$$

Now, the subspace $\rho(S(\lambda))$ is spanned by the functions $n \mapsto \Delta_{\varpi_j, \varpi_j}(ng)$, ($n \in N_-, g \in G^{\min}$). By differentiating the previous equation with respect to t and setting $t = 0$, we obtain that

$$\rho(S(\lambda)) \subset \{f \in \mathbb{C}[N^{\min}]_{\text{s.r.}} \mid f \cdot e_i = 0 \text{ for } i \neq j, f \cdot e_j^2 = 0\}.$$

Hence, using Corollary 19.10, we see that $\rho(S(\lambda))$ is contained in the embedding of $L(\varpi_j)$ given by the dual Verma module. Since these spaces have the same graded dimensions, they must coincide. The case of a general λ follows using the fact that

$$\Delta_\lambda = \prod_j \Delta_{\varpi_j, \varpi_j}^{\lambda(\alpha_j^\vee)}$$

and that the e_i 's act as derivations on $\mathbb{C}[N^{\min}]_{\text{s.r.}}$. □

Let $M = M_1 \oplus \dots \oplus M_r$ be a terminal $\mathbb{C}Q$ -module. Let $w = w(M) = s_{i_r} \dots s_{i_1}$ be the element of W attached to M with its reduced expression (i_r, \dots, i_1) obtained from a Γ_M -adapted ordering, as in Lemma 19.3. Set

$$w_{\leq k}^{-1} = s_{i_1} \dots s_{i_k}, \quad (k = 1, \dots, r).$$

Finally, let $T_M^\vee = T_1 \oplus \dots \oplus T_r$ be the \mathcal{C}_M -maximal rigid Λ -module defined in Section 7. Here we number the indecomposable direct summands of T_M^\vee using the same Γ_M -adapted ordering.

Proposition 22.14. *We have*

$$\varphi_{T_k} = D_{\varpi_{i_k}, w_{\leq k}^{-1}(\varpi_{i_k})}, \quad (k = 1, \dots, r).$$

In particular, we have $D_{\varpi_i, w^{-1}(\varpi_i)} = \varphi_{T_{i, [0, t_i]}}$ for every $1 \leq i \leq n$.

Proof. Using Lemma 22.13, we can realize the fundamental module $L(\varpi_{i_k})$ as the subspace $\rho(S(\varpi_{i_k}))$ of $\mathbb{C}[N]$. Then using Theorem 19.9 and arguing as in the proof of [GLS2, Theorem 2], we can check that the function φ_{T_k} is an extremal vector of weight $w_{\leq k}^{-1}(\varpi_{i_k})$ in $L(\varpi_{i_k})$, hence it coincides with $D_{\varpi_{i_k}, w_{\leq k}^{-1}(\varpi_{i_k})}$ up to a scalar. Moreover, its image under $e_{i_k}^{\max} \dots e_{i_1}^{\max}$ is equal to 1, so the normalizations agree and we have $\varphi_{T_k} = D_{\varpi_{i_k}, w_{\leq k}^{-1}(\varpi_{i_k})}$. □

Now, writing $T_{i,[a,b]}$ instead of $\varphi_{T_{i,[a,b]}}$, we obtain immediately

$$\begin{aligned} T_{1,[0,1]} &= T_{1,[1,1]}T_{1,[0,0]} - T_{2,[0,0]}^2, \\ T_{2,[0,1]} &= T_{2,[1,1]}T_{2,[0,0]} - T_{1,[1,1]}^2T_{3,[0,0]}, \\ T_{3,[0,1]} &= T_{3,[1,1]}T_{3,[0,0]} - T_{2,[1,1]}. \end{aligned}$$

Again by Theorem 18.1 and a short calculation we get

$$\begin{aligned} T_{1,[0,2]} &= T_{1,[2,2]}T_{1,[1,1]}T_{1,[0,0]} - T_{1,[2,2]}T_{2,[0,0]}^2 - T_{2,[1,1]}^2T_{1,[0,0]} + \\ &\quad + 2T_{2,[1,1]}T_{2,[0,0]}T_{1,[1,1]}T_{3,[0,0]} - T_{1,[1,1]}^3T_{3,[0,0]}^2. \end{aligned}$$

22.6. Proof of Theorem 3.5. Everything is now ready for the proof of Theorem 3.5. By Proposition 22.9, we know that $\mathbb{C}[N^w]$ is the localization of the ring $\mathbb{C}[N(w)]$ with respect to the minors $D_{\varpi_i, w^{-1}(\varpi_i)}$. By Corollary 22.3, $\mathbb{C}[N(w)]$ is equal to the cluster algebra $\mathcal{R}(\mathcal{C}_M)$. By Proposition 22.14, the minors $D_{\varpi_i, w^{-1}(\varpi_i)}$ coincide with the functions φ_X where X runs through the set of indecomposable \mathcal{C}_M -projective-injective. In other words, the $D_{\varpi_i, w^{-1}(\varpi_i)}$ coincide with the generators of the coefficient ring of $\mathcal{R}(\mathcal{C}_M)$. Hence $\mathbb{C}[N^w]$ is equal to the cluster algebra $\tilde{\mathcal{R}}(\mathcal{C}_M)$.

22.7. The subcategory \mathcal{C}_w . In Lemma 19.3 we have associated to a terminal $\mathbb{C}Q$ -module M a Q^{op} -adaptable element w of the Weyl group. It is not difficult to see that the map $M \mapsto w$ is a bijection from the set of isomorphism classes of terminal $\mathbb{C}Q$ -modules to the set of sincere Q^{op} -adaptable elements w of W . (Here w is called *sincere* if for any reduced expression $(i_t, \dots, i_1) \in R(w)$ we have $i \in \{i_1, \dots, i_t\}$ for all $1 \leq i \leq n$. Looking at sincere Weyl group elements is not really a restriction, since we could just pass from Q to a smaller quiver by deleting the vertices which do not occur in $\{i_1, \dots, i_t\}$.)

On the other hand, an element w of W may be adaptable to several orientations Q of the Dynkin graph of \mathfrak{g} . (For example if \mathfrak{g} is finite-dimensional, the longest element w_0 of W is adaptable to every orientation of the Dynkin graph.) In this case, w is associated with a terminal $\mathbb{C}Q$ -module $M = M_Q$ for several orientations Q of the Dynkin graph.

Lemma 22.15. *Let Q and Q' be two orientations of the Dynkin graph of \mathfrak{g} . Let $w \in W$ be Q^{op} -adaptable and Q'^{op} -adaptable, and let $M \in \text{mod}(\mathbb{C}Q)$ and $M' \in \text{mod}(\mathbb{C}Q')$ be the corresponding terminal modules. Then, the subcategories \mathcal{C}_M and $\mathcal{C}_{M'}$ of $\text{nil}(\Lambda)$ are equal.*

Proof. Recall that, by Proposition 22.14, the elements of $\mathbb{C}[N]$ attached to the \mathcal{C}_M -injective indecomposable direct summands of T_M^\vee are the $D_{\varpi_i, w^{-1}(\varpi_i)}$ for $1 \leq i \leq n$. In particular, they depend only on w and not on the choice of a reduced expression. Now, if X and Y are two rigid modules such that $\varphi_X = \varphi_Y$, we have that X is isomorphic to Y . Otherwise, the closures of their orbits would be different irreducible components of the nilpotent variety on which they lie, and therefore φ_X and φ_Y would be different elements of the dual semicanonical basis. It follows that \mathcal{C}_M and $\mathcal{C}_{M'}$ have the same generator-cogenerator, so they are equal. \square

Therefore we may define $\mathcal{C}_w := \mathcal{C}_M$, and we have associated to every *adaptable* element $w \in W$ a subcategory \mathcal{C}_w of $\text{nil}(\Lambda)$. This subcategory is, up to duality, the same as the one introduced in a different manner in [BIRS]. To check this, one only needs to compare our maximal rigid module T_M^\vee (as described in Proposition 22.14) with the cluster tilting

object

$$\bigoplus_{k=1}^r \Lambda / I_{s_{i_1} \cdots s_{i_k}}$$

defined in [BIRS, Theorem II.2.6]. More precisely, if in our construction we would replace our terminal $\mathbb{C}Q$ -module M in the preinjective component by an “initial” $\mathbb{C}Q$ -module in the preprojective component, then we would get exactly the cluster tilting objects and the subcategories \mathcal{C}_w of [BIRS, Theorem II.2.8], but only for the adaptable elements w of W .

Thus we have proved:

Theorem 22.16. *Conjecture III.3.1 of [BIRS] holds for every adaptable element $w \in W$.*

22.8. Calculation of Euler characteristics. We retain the notation of Section 22.4. In particular $M = M_1 \oplus \cdots \oplus M_r$ is a terminal $\mathbb{C}Q$ -module, and $w = w(M) = s_{i_r} \cdots s_{i_1}$ is the corresponding Weyl group element. Let T be a \mathcal{C}_M -maximal rigid module in the mutation class of T_M , or equivalently in the mutation class of $T_M^\vee = T_1 \oplus \cdots \oplus T_r$. Let X be an indecomposable direct summand of T and let $\mathbf{j} = (j_1, \dots, j_d)$. By Proposition 22.10, the Euler characteristic $\chi_c(\mathcal{F}_{\mathbf{j}, X})$ is equal to the coefficient of $t_1 \cdots t_d$ in $\varphi_X(x_{j_1}(t_1) \cdots x_{j_d}(t_d))$. Using mutations, we can express algorithmically φ_X as a Laurent polynomial in the functions φ_{T_i} ($i = 1, \dots, r$). Again, by Proposition 22.10, to evaluate φ_{T_i} on $x_{j_1}(t_1) \cdots x_{j_d}(t_d)$, we only need to know the Euler characteristic $\chi_c(\mathcal{F}_{\mathbf{k}, T_i})$ for arbitrary types \mathbf{k} of composition series. These Euler characteristics can in turn be calculated via a simple algorithm that we shall now describe.

To this end, it will be convenient to embed $U(\mathfrak{n})_{\text{gr}}^* \cong \mathbb{C}[N]$ in the shuffle algebra F^* , as explained in [Le, §2.8]. As a \mathbb{C} -vector space, F^* has a basis consisting of all words

$$w[\mathbf{k}] = w[k_1, k_2, \dots, k_s] := w_{k_1} w_{k_2} \cdots w_{k_s}, \quad (1 \leq k_1, \dots, k_s \leq n, s \in \mathbb{N}),$$

in the letters w_1, \dots, w_n . The multiplication in F^* is the classical commutative shuffle product \sqcup of words with unit the empty word $w[\]$ (see e.g. [Le, §2.5]). By [Le, Prop. 9, 10], for any $X \in \text{nil}(\Lambda)$ the image of φ_X in this embedding is just the generating function

$$g_X := \sum_{\mathbf{k}} \chi_c(\mathcal{F}_{\mathbf{k}, X}) w[\mathbf{k}]$$

of the Euler characteristics $\chi_c(\mathcal{F}_{\mathbf{k}, X})$ for all types \mathbf{k} of composition series.

Let $\lambda \in P^+$ and $1 \leq i \leq n$. Define endomorphisms $\rho_\lambda(e_i), \rho_\lambda(f_i)$ of the vector space F^* by

$$\rho_\lambda(e_i)(w[j_1, \dots, j_k]) = \delta_{i, j_k} w[j_1, \dots, j_{k-1}],$$

$$\rho_\lambda(f_i)(w[j_1, \dots, j_k]) = \sum_{r=0}^k (\lambda - \alpha_{j_1} - \cdots - \alpha_{j_r})(\alpha_i^\vee) w[j_1, \dots, j_r, i, j_{r+1}, \dots, j_k].$$

Proposition 22.17. *The formulas above extend to a linear representation ρ_λ of \mathfrak{g} on F^* . This turns F^* into a $U(\mathfrak{g})$ -module. The image of $\mathbb{C}[N]$ in its embedding in F^* is a $U(\mathfrak{g})$ -submodule isomorphic to the dual Verma module $M(\lambda)_{\text{low}}^*$ (see Section 19.6). In particular the set*

$$\{\rho_\lambda(f_{i_1} \cdots f_{i_s})(w[\]) \mid s \in \mathbb{N}, 1 \leq i_1, \dots, i_s \leq n\}$$

spans a copy of the irreducible module $L(\lambda)$.

The above formulas for $\rho_\lambda(e_i)$ and $\rho_\lambda(f_i)$ can be obtained by specializing q to 1 in the formulas of the proof of [Le, Prop. 50]. We omit the details.

By Proposition 22.14, we have

$$\varphi_{T_k} = D_{\varpi_{i_k}, w_{\leq k}^{-1}(\varpi_{i_k})}, \quad (k = 1, \dots, r),$$

that is, φ_{T_k} is the (suitably normalized) extremal weight vector of $L(\varpi_{i_k})$ with weight $s_{i_1} \cdots s_{i_k}(\varpi_{i_k})$. This implies that φ_{T_k} is obtained by acting on the highest weight vector of $L(\varpi_{i_k})$ with the product $f_{i_1}^{(b_1)} \cdots f_{i_k}^{(b_k)}$ of divided powers of the Chevalley generators, where $b_k = \varpi_{i_k}(\alpha_{i_k}^\vee) = 1$ and $b_j = (s_{i_{j+1}} \cdots s_{i_k}(\varpi_{i_k}))(\alpha_{i_j}^\vee)$ ($j = 1, \dots, k-1$). Therefore we have

$$(21) \quad g_{T_k} = \rho_{\varpi_{i_k}} \left(f_{i_1}^{(b_1)} \cdots f_{i_k}^{(b_k)} \right) (w[]).$$

Hence to calculate the generating function g_{T_k} one only needs to apply $b_1 + \cdots + b_k = \dim T_k$ times the above combinatorial formula for $\rho_{\varpi_{i_k}}(f_i)$.

Thus we have obtained an algorithm for calculating the Euler characteristics $\chi_c(\mathcal{F}_{\mathbf{k}, T})$ for any rigid module T in the mutation class of T_M^\vee . This applies in particular to every summand M_i of the terminal $\mathbb{C}Q$ -module M . Hence, by varying M , we see that the Euler characteristics $\chi_c(\mathcal{F}_{\mathbf{k}, L})$ are (in principle) computable for any preinjective $\mathbb{C}Q$ -module L .

22.9. Example. We continue the example of Section 22.5. Clearly, we have

$$g_{T_1} = \rho_{\varpi_1}(f_1)(w[]) = \varpi_1(\alpha_1^\vee)w[1] = w[1].$$

Similarly

$$g_{T_2} = \rho_{\varpi_2}(f_1^{(2)} f_2)(w[]).$$

Now we calculate successively

$$\begin{aligned} \rho_{\varpi_2}(f_2)(w[]) &= \varpi_2(\alpha_2^\vee) w[2] = w[2], \\ \rho_{\varpi_2}(f_1)(w[2]) &= \varpi_2(\alpha_1^\vee) w[1, 2] + (\varpi_2 - \alpha_2)(\alpha_1^\vee) w[2, 1] = 2w[2, 1], \\ \rho_{\varpi_2}(f_1)(2w[2, 1]) &= 2(\varpi_2(\alpha_1^\vee) w[1, 2, 1] + (\varpi_2 - \alpha_2)(\alpha_1^\vee) w[2, 1, 1]) \\ &\quad + (\varpi_2 - \alpha_2 - \alpha_1)(\alpha_1^\vee) w[2, 1, 1] \\ &= 4w[2, 1, 1]. \end{aligned}$$

Hence, taking into account that $f_1^{(2)} = f_1^2/2$, we get

$$g_{T_2} = 2w[2, 1, 1].$$

Similar applications of formula (21) yield the following results

$$\begin{aligned} g_{T_3} &= \rho_{\varpi_1} \left(f_1^{(3)} f_2^{(2)} f_1 \right) (w[]) = 4w[1, 2, 1, 2, 1, 1] + 12w[1, 2, 2, 1, 1, 1], \\ g_{T_4} &= \rho_{\varpi_3} \left(f_1^{(2)} f_2 f_3 \right) (w[]) = 2w[3, 2, 1, 1], \\ g_{T_7} &= \rho_{\varpi_3} \left(f_1^{(4)} f_2^{(3)} f_1^{(2)} f_2 f_3 \right) (w[]) \\ &= 288w[3, 2, 1, 1, 2, 2, 1, 1, 1, 1] + 144w[3, 2, 1, 1, 2, 2, 1, 2, 1, 1, 1] \\ &\quad + 96w[3, 2, 1, 2, 1, 2, 2, 1, 1, 1, 1] + 48w[3, 2, 1, 1, 2, 2, 1, 1, 2, 1, 1, 1] \\ &\quad + 48w[3, 2, 1, 2, 1, 1, 2, 2, 1, 1, 1] + 48w[3, 2, 1, 2, 1, 2, 1, 2, 1, 1, 1] \\ &\quad + 48w[3, 2, 1, 1, 2, 1, 2, 2, 1, 1, 1] + 16w[3, 2, 1, 2, 1, 2, 1, 1, 2, 1, 1, 1] \\ &\quad + 16w[3, 2, 1, 2, 1, 1, 2, 1, 2, 1, 1, 1] + 16w[3, 2, 1, 1, 2, 1, 2, 1, 2, 1, 2, 1, 1]. \end{aligned}$$

The generating functions g_{T_5} and g_{T_6} are too large to be included here. For example g_{T_5} is a linear combination of 402 words.

22.10. Coordinate rings of unipotent radicals. In this section, we assume that Q is of finite Dynkin type $\mathbb{A}, \mathbb{D}, \mathbb{E}$. We first recall some standard notation (we refer the reader to [GLS6] for more details). The group G is now a simple complex algebraic group of the same type as Q . Let J be a subset of the set of vertices of Q , and let K be the complementary subset. To K one can attach a standard parabolic subgroup B_K containing the Borel subgroup $B = HN$. We denote by N_K the unipotent radical of B_K . This is a subgroup of N . Let W_K be the subgroup of the Weyl group W generated by the reflexions s_k ($k \in K$). This is a finite Coxeter group and we denote by w_0^K its longest element. The longest element of W is denoted by w_0 .

In finite type, the preprojective algebra Λ is finite-dimensional and self-injective. In agreement with [GLS6], we shall denote by P_i the indecomposable projective Λ -module with top S_i and by Q_i the indecomposable injective module with socle S_i . We write

$$Q_J = \bigoplus_{j \in J} Q_j \quad \text{and} \quad P_J = \bigoplus_{j \in J} P_j.$$

In [GLS6], we have shown that $\mathbb{C}[N_K]$ is naturally isomorphic to the subalgebra

$$R_K := \text{Span}_{\mathbb{C}} \langle \varphi_X \mid X \in \text{Sub}(Q_J) \rangle$$

of $\mathbb{C}[N]$. As before, $\text{Sub}(Q_J)$ is the full subcategory of $\text{mod}(\Lambda)$ whose objects are submodules of direct sums of finitely many copies of Q_J . This allowed us to introduce a cluster algebra $\mathcal{A}_J \subseteq R_K$, whose cluster monomials are of the form φ_X with X a rigid object of $\text{Sub}(Q_J)$. We conjectured that in fact $\mathcal{A}_J = R_K$ [GLS6, Conj. 9.6].

We are going to prove that this conjecture follows from the results of this paper if $w_0 w_0^K$ is adaptable.

Lemma 22.18. *We have $N_K = N'(w_0^K) = N(w_0 w_0^K)$.*

Proof. We know that $N'(w_0^K)$ is the subgroup of N generated by the one-parameter subgroups $N(\alpha)$ with $\alpha > 0$ and $w_0^K(\alpha) > 0$. These are exactly the one-parameter subgroups of N which do not belong to the Levi subgroup of B_K , hence the first equality follows. Now, since $N = w_0 N_- w_0$, we have

$$N'(w_0^K) = N \cap w_0^K N w_0^K = N \cap w_0^K w_0 N_- w_0 w_0^K = N(w_0 w_0^K).$$

□

As before, let $\text{Fac}(P_J)$ be the subcategory of $\text{mod}(\Lambda)$ whose objects are factor modules of direct sums of finitely many copies of P_J .

Lemma 22.19. *We have $\mathcal{C}_{w_0 w_0^K} = \text{Fac}(P_J)$.*

Proof. By Proposition 22.14, we know that the indecomposable projective-injective object I_i of $\mathcal{C}_{w_0 w_0^K}$ with socle S_i satisfies

$$\varphi_{I_i} = D_{\varpi_i, w_0^K w_0(\varpi_i)}, \quad (i \in I).$$

By [GLS6, §6.2], it follows that $I_i = \mathcal{E}_{w_0^K} Q_i$, where $\mathcal{E}_{w_0^K}$ is the functor defined in [GLS6, §5.2]. It readily follows that I_i is the projective-injective indecomposable object of $\text{Fac}(P_J)$ with simple socle S_i . Hence $\mathcal{C}_{w_0 w_0^K}$ and $\text{Fac}(P_J)$ have the same projective-injective generator. □

Let S denote the self-duality of $\text{mod}(\Lambda)$ induced by the involution $a \mapsto a^*$ mapping an arrow a of \overline{Q} to its opposite arrow a^* (see [GLS2, §1.7]). This restricts to an anti-equivalence of categories $\text{Fac}(P_J) \rightarrow \text{Sub}(Q_J)$, that we shall again denote by S .

Lemma 22.20. *For every $X \in \text{mod}(\Lambda)$ and every $n \in N$ we have*

$$\varphi_X(n^{-1}) = (-1)^{\dim X} \varphi_{S(X)}(n).$$

Proof. We know that N is generated by the one-parameter subgroups $x_i(t)$ attached to the simple positive roots. By Proposition 22.10 we have

$$\varphi_X(x_{i_1}(t_1) \cdots x_{i_k}(t_k)) = \sum_{\mathbf{a}=(a_1, \dots, a_k) \in \mathbb{N}^k} \chi_c(\mathcal{F}_{\mathbf{i}^{\mathbf{a}}, X}) \frac{t_1^{a_1} \cdots t_k^{a_k}}{a_1! \cdots a_k!}.$$

Now, if $n = x_{i_1}(t_1) \cdots x_{i_k}(t_k)$, we have $n^{-1} = x_{i_k}(-t_k) \cdots x_{i_1}(-t_1)$ and the result follows from the fact that $\mathcal{F}(\mathbf{i}^{\mathbf{a}}, X) \cong \mathcal{F}(\mathbf{i}_{\text{op}}^{\mathbf{a}_{\text{op}}}, S(X))$, where \mathbf{i}_{op} and \mathbf{a}_{op} denote the sequences obtained by reading \mathbf{i} and \mathbf{a} from right to left. \square

We can now prove:

Theorem 22.21. *Conjecture 9.6 of [GLS6] holds if $w_0 w_0^K$ is adaptable.*

Proof. Suppose that $w_0 w_0^K$ is Q -adapted. Let $\mathcal{C}_M = \mathcal{C}_{w_0 w_0^K}$ be the corresponding subcategory of $\text{mod}(\Lambda)$. The cluster algebra $\mathcal{R}(\mathcal{C}_M) = \mathcal{R}(\text{Fac}(P_J))$ is isomorphic to \mathcal{A}_J via the map $\varphi_X \mapsto \varphi_{S(X)}$. This comes from the fact that $S: \text{Fac}(P_J) \rightarrow \text{Sub}(Q_J)$ is an anti-equivalence which maps the maximal rigid module T_M^\vee used to define the initial seed of $\mathcal{R}(\mathcal{C}_M)$ to the maximal rigid module U_i of [GLS6, §9.2] used to define the initial seed of \mathcal{A}_J . (Here we assume that \mathbf{i} is the reduced word of $w_0^K w_0$ obtained by reading the Q -adapted reduced word of $w_0 w_0^K$ from right to left.) In particular the cluster variables φ_{M_i} which, by Theorem 20.1, generate $\mathcal{R}(\text{Fac}(P_J)) = \mathbb{C}[N(w_0 w_0^K)]$ are mapped to cluster variables $\varphi_{S(M_i)}$ of \mathcal{A}_J . They also form a system of generators of the polynomial algebra $\mathbb{C}[N(w_0 w_0^K)] = \mathbb{C}[N_K]$ by Lemma 22.20, because the map $n \mapsto n^{-1}$ is a biregular automorphism of N_K . Hence $\mathcal{A}_J = \mathbb{C}[N_K]$. \square

Remark 22.22. The previous discussion shows that we obtain two different cluster algebra structures on $\mathbb{C}[N_K]$, coming from the two different subcategories $\text{Fac}(P_J)$ and $\text{Sub}(Q_J)$.

When using $\text{Fac}(P_J) = \mathcal{C}_{w_0 w_0^K}$, we regard $\mathbb{C}[N_K]$ as the subring of $N'(w_0 w_0^K)$ -invariant functions of $\mathbb{C}[N]$ for the action of $N'(w_0 w_0^K)$ on N by *right* translations (see Section 22.2). This allows us to relate the first cluster structure to the cluster structure of the unipotent cell $\mathbb{C}[N^{w_0 w_0^K}]$ (see Proposition 22.9).

When using $\text{Sub}(Q_J)$, we regard $\mathbb{C}[N_K]$ as the subring of $N'(w_0 w_0^K)$ -invariant functions of $\mathbb{C}[N]$ for the action of $N'(w_0 w_0^K) = N(w_0^K)$ on N by *left* translations. These functions can then be “lifted” to B_K^- -invariant functions on G for the action of B_K^- on G by left translations. This allows us to “lift” the second cluster structure to a cluster structure on $\mathbb{C}[B_K^- \backslash G]$ (see [GLS6, §10]).

23. OPEN PROBLEMS

23.1. It is known that the dual canonical basis \mathcal{B}^* and the dual semicanonical basis \mathcal{S}^* of $\mathcal{M}^* \equiv U(\mathfrak{n})_{\text{gr}}^*$ do not coincide, see [GLS1]. But one might at least hope that both bases have some interesting elements in common:

Conjecture 23.1 (Open Orbit Conjecture). *Let Z be an irreducible component of Λ_d , and let b_Z and ρ_Z be the associated dual canonical and dual semicanonical basis vectors of \mathcal{M}^* . If Z contains an open GL_d -orbit, then $b_Z = \rho_Z$.*

We know that each cluster monomial of the cluster algebra $\mathcal{A}(\mathcal{C}_M)$ is of the form ρ_Z , where Z contains an open GL_d -orbit. So if the conjecture is true, then all cluster monomials belong to the dual canonical basis.

23.2. Finally, we would like to ask the following question. Is it possible to realize every element of the dual canonical basis of \mathcal{M}^* as a δ -function? We know several examples of elements b of \mathcal{B}^* which do not belong to \mathcal{S}^* . In all these examples, b is however equal to δ_X for a non-generic Λ -module X .

Let us look at an example. Let Q be the quiver

$$1 \rightleftarrows 2$$

and let Λ be the associated preprojective algebra. For $\lambda \in \mathbb{C}^*$ we define representations $M(\lambda, 1)$ and $M(\lambda, 2)$ of Q as follows:

$$M(\lambda, 1) := \mathbb{C} \begin{array}{c} \xleftarrow{(1)} \\ \xrightarrow{(\lambda)} \end{array} \mathbb{C} \quad \text{and} \quad M(\lambda, 2) := \mathbb{C}^2 \begin{array}{c} \xleftarrow{\begin{pmatrix} 1 & 0 \\ 0 & 1 \end{pmatrix}} \\ \xrightarrow{\begin{pmatrix} \lambda & 1 \\ 0 & \lambda \end{pmatrix}} \end{array} \mathbb{C}^2$$

Let $\iota: \mathrm{rep}(Q, (2, 2)) \rightarrow \Lambda_{(2, 2)}$ be the canonical embedding, defined by $M' \mapsto (M', 0)$. Clearly, the image of ι is an irreducible component of $\Lambda_{(2, 2)}$, which we denote by Z_Q . It is not difficult to check that the set

$$\{(M(\lambda, 1) \oplus M(\mu, 1), 0) \mid \lambda, \mu \in \mathbb{C}^*\}$$

is a dense subset of Z_Q . It follows that

$$\delta_{(M(\lambda, 1) \oplus M(\mu, 1), 0)} = \rho_{Z_Q}$$

is an element of the dual semicanonical basis \mathcal{S}^* . It is easy to check that

$$\delta_{(M(\lambda, 2), 0)} \neq \delta_{(M(\lambda, 1) \oplus M(\mu, 1), 0)}.$$

Indeed the variety of ascending flags of type $(1, 2, 1, 2)$ has Euler characteristic 2 for $(M(\lambda, 1) \oplus M(\mu, 1), 0)$ and Euler characteristic 1 for $(M(\lambda, 2), 0)$. Furthermore, one can show that

$$\delta_{(M(\lambda, 2), 0)} = b_{Z_Q}$$

belongs to the dual canonical basis \mathcal{B}^* of \mathcal{M}^* .

Note that the functions $\delta_{(M(\lambda, 1) \oplus M(\mu, 1), 0)}$ and $\delta_{(M(\lambda, 2), 0)}$ do not belong to any of the subalgebras $\mathcal{R}(\mathcal{C}_M)$, since $M(\lambda, 1)$ and $M(\lambda, 2)$ are regular representations of the quiver Q for all λ .

Acknowledgements. We are grateful to Øyvind Solberg for answering our questions on relative homology theory. We thank Shrawan Kumar for his kind help concerning Kac-Moody groups. It is a pleasure to thank the Mathematisches Forschungsinstitut Oberwolfach (MFO) for two weeks of hospitality in August/September 2006, where part of this work was done. Furthermore, the first and second authors like to thank the Max-Planck Institute for Mathematics in Bonn for a research stay in September - December 2006 and October 2006, respectively. Finally, the three authors are grateful to the Mathematical Sciences Research Institute in Berkeley (MSRI) for an invitation in Spring 2008 during

which this work was finalized. The first author was partially supported by PAPIIT grant IN103507-2.

REFERENCES

- [Ab] *E. Abe*, Hopf algebras. Cambridge Tracts in Mathematics 74. Cambridge University Press, 1980.
- [ASS] *I. Assem, D. Simson, A. Skowroński*, Elements of the representation theory of associative algebras. Vol. 1. Techniques of representation theory. London Mathematical Society Student Texts, 65. Cambridge University Press, Cambridge, 2006. x+458 pp.
- [A] *M. Auslander*, Representation theory of artin algebras. I. Comm. Alg. 1 (1974), 177–268.
- [APR] *M. Auslander, M. Platzeck, I. Reiten*, Coxeter functors without diagrams. Trans. Amer. Math. Soc. 250 (1979), 1–46.
- [ARS] *M. Auslander, I. Reiten, S. Smalø*, Representation theory of Artin algebras. Corrected reprint of the 1995 original. Cambridge Studies in Advanced Mathematics, 36. Cambridge University Press, Cambridge, 1997. xiv+425 pp.
- [AS1] *M. Auslander, Ø. Solberg*, Relative homology and representation theory. I. Relative homology and homologically finite subcategories. Comm. Algebra 21 (1993), no. 9, 2995–3031.
- [AS2] *M. Auslander, Ø. Solberg*, Relative homology and representation theory. II. Relative cotilting theory. Comm. Algebra 21 (1993), no. 9, 3033–3079.
- [BZ] *A. Berenstein, A. Zelevinsky*, Total positivity in Schubert varieties. Comment. Math. Helv. 72 (1997), 128–166.
- [Be] *R. Bédard*, On commutation classes of reduced words in Weyl groups. Europ. J. Combinatorics (1999) 20, 483–505.
- [BFZ] *A. Berenstein, S. Fomin, A. Zelevinsky*, Cluster algebras III: Upper bounds and double Bruhat cells. Duke Math. J. 126 (2005), no. 1, 1–52.
- [Bo1] *K. Bongartz*, Algebras and quadratic forms. J. London Math. Soc. (2) 28 (1983), no. 3, 461–469.
- [Bo2] *K. Bongartz*, Tilted algebras. Representations of algebras (Puebla, 1980), pp. 26–38, Lecture Notes in Math., 903, Springer, Berlin-New York, 1981.
- [BMRRT] *A. Buan, R. Marsh, M. Reineke, I. Reiten, G. Todorov*, Tilting theory and cluster combinatorics. Adv. Math. 204 (2006), no. 2, 572–618.
- [BM] *A. Buan, R. Marsh*, Cluster-tilting theory. In: Trends in Representation Theory of Algebras and Related Topics, Contemp. Math. 406 (2006), 1–30.
- [BIRS] *A. Buan, O. Iyama, I. Reiten, J. Scott*, Cluster structures for 2-Calabi-Yau categories and unipotent groups. arXiv:math.RT/0701557.
- [CK1] *P. Caldero, B. Keller*, From triangulated categories to cluster algebras. Invent. Math. 172 (2008), 169–211.
- [CK2] *P. Caldero, B. Keller*, From triangulated categories to cluster algebras II. Ann. Sci. École Norm. Sup. (4) 39 (2006), no. 6, 983–1009.
- [CR] *P. Caldero, M. Reineke*, On the quiver Grassmannian in the acyclic case. J. Pure Appl. Algebra (to appear).
- [CPS] *E. Cline, B. Parshall, L. Scott*, Finite-dimensional algebras and highest weight categories. J. Reine Angew. Math. 391 (1988), 85–99.
- [CB1] *W. Crawley-Boevey*, On the exceptional fibres of Kleinian singularities. Amer. J. Math. 122 (2000), 1027–1037.
- [CB2] *W. Crawley-Boevey*, Geometry of the moment map for representations of quivers. Compositio Math. 126 (2001), no. 3, 257–293.
- [DFK] *P. Di Francesco, R. Kedem*, Q-systems as cluster algebras II: Cartan matrix of finite type and the polynomial property. arXiv:0803.0362.
- [D] *J. Dixmier*, Enveloping algebras. North-Holland Mathematical Library, Vol. 14. Translated from the French. North-Holland Publishing Co., Amsterdam-New York-Oxford, 1977. xvi+375 pp.
- [FZ1] *S. Fomin, A. Zelevinsky*, Double Bruhat cells and total positivity. J. Amer. Math. Soc. 12 (1999), no. 2, 335–380.
- [FZ2] *S. Fomin, A. Zelevinsky*, Cluster algebras. I. Foundations. J. Amer. Math. Soc. 15 (2002), no. 2, 497–529.
- [FZ3] *S. Fomin, A. Zelevinsky*, Cluster algebras. II. Finite type classification. Invent. Math. 154 (2003), no. 1, 63–121.
- [FZ4] *S. Fomin, A. Zelevinsky*, Cluster algebras: notes for the CDM-03 conference. Current developments in mathematics, 2003, 1–34, Int. Press, Somerville, MA, 2003.
- [FZ5] *S. Fomin, A. Zelevinsky*, Cluster algebras. IV. Coefficients. Compositio Math. 143 (2007), 112–164.

- [GR] *P. Gabriel, A.V. Roiter*, Representations of finite-dimensional algebras. Translated from the Russian. With a chapter by B. Keller. Reprint of the 1992 English translation. Springer-Verlag, Berlin, 1997. iv+177 pp.
- [GLS1] *C. Geiß, B. Leclerc, J. Schröer*, Semicanonical bases and preprojective algebras. Ann. Sci. École Norm. Sup. (4) 38 (2005), no. 2, 193–253.
- [GLS2] *C. Geiß, B. Leclerc, J. Schröer*, Auslander algebras and initial seeds for cluster algebras. J. London Math. Soc. (2) 75 (2007), 718–740.
- [GLS3] *C. Geiß, B. Leclerc, J. Schröer*, Verma modules and preprojective algebras. Nagoya Math. J. 182 (2006), 241–258.
- [GLS4] *C. Geiß, B. Leclerc, J. Schröer*, Semicanonical bases and preprojective algebras II: A multiplication formula. Compositio Math. 143 (2007), 1313–1334.
- [GLS5] *C. Geiß, B. Leclerc, J. Schröer*, Rigid modules over preprojective algebras. Invent. Math. 165 (2006), no. 3, 589–632.
- [GLS6] *C. Geiß, B. Leclerc, J. Schröer*, Partial flag varieties and preprojective algebras. arXiv:math.RT/0609138, Ann. Inst. Fourier (Grenoble) (to appear).
- [GS] *C. Geiß, J. Schröer*, Extension-orthogonal components of preprojective varieties. Trans. Amer. Math. Soc. 357 (2005), 1953–1962.
- [H1] *D. Happel*, On the derived category of a finite-dimensional algebra. Comment. Math. Helv. 62 (1987), no. 3, 339–389.
- [H2] *D. Happel*, Triangulated categories in the representation theory of finite-dimensional algebras. London Mathematical Society Lecture Note Series, 119. Cambridge University Press, Cambridge, 1988. x+208 pp.
- [H3] *D. Happel*, Partial tilting modules and recollement. Proceedings of the International Conference on Algebra, Part 2 (Novosibirsk, 1989), 345–361, Contemp. Math., 131, Part 2, Amer. Math. Soc., Providence, RI, 1992.
- [HR] *D. Happel, C.M. Ringel*, Tilted algebras. Trans. Amer. Math. Soc. 274 (1982), no. 2, 399–443.
- [HU1] *D. Happel, L. Unger*, On the quiver of tilting modules. J. Algebra 284 (2005), 857–868.
- [HU2] *D. Happel, L. Unger*, On a partial order of tilting modules. Algebras and Representation Theory 8 (2005), 147–156.
- [Ig] *K. Igusa*, Notes on the no loops conjecture. J. Pure Appl. Algebra 69 (1990), 161–176.
- [Iy1] *O. Iyama*, Higher dimensional Auslander-Reiten theory on maximal orthogonal subcategories. Adv. Math. 210 (2007), no. 1, 22–50.
- [Iy2] *O. Iyama*, Auslander correspondence. Adv. Math. 210 (2007), no. 1, 51–82.
- [K1] *V. Kac*, Infinite root systems, representations of graphs and invariant theory. Invent. Math. 56 (1980), no. 1, 57–92.
- [K2] *V. Kac*, Infinite-dimensional Lie algebras. Third edition. Cambridge University Press, Cambridge, 1990. xxii+400 pp.
- [KP] *V. Kac, D. Peterson*, Regular functions on certain infinite-dimensional groups. Arithmetic and geometry, Vol II, 141–166, Progr. Math., 36, Birkhäuser Boston, Boston, MA, 1983.
- [KS] *M. Kashiwara, Y. Saito*, Geometric construction of crystal bases. Duke Math. J. 89 (1997), 9–36.
- [K] *B. Keller*, On triangulated orbit categories. Doc. Math. 10 (2005), 551–581 (electronic).
- [KR] *B. Keller, I. Reiten*, Acyclic Calabi-Yau categories. arXiv:math.RT/0610594.
- [Ku] *S. Kumar*, Kac-Moody groups, their flag varieties and representation theory. Progress in Mathematics, 204. Birkhäuser Boston, Inc., Boston, MA, 2002.
- [Le] *B. Leclerc*, Dual canonical bases, quantum shuffles and q -characters. Math. Z. 246 (2004), 691–732.
- [L1] *G. Lusztig*, Quivers, perverse sheaves, and quantized enveloping algebras. J. Amer. Math. Soc. 4 (1991), no. 2, 365–421.
- [L2] *G. Lusztig*, Constructible functions on the Steinberg variety. Adv. Math. 130 (1997), no. 2, 287–310.
- [L3] *G. Lusztig*, Semicanonical bases arising from enveloping algebras. Adv. Math. 151 (2000), no. 2, 129–139.
- [R] *N. Richmond*, A stratification for varieties of modules. Bull. London Math. Soc. 33 (2001), no. 5, 565–577.
- [RS] *C. Riedtmann, A. Schofield*, On a simplicial complex associated with tilting modules. Comment. Math. Helv. 66 (1991), no. 1, 70–78.
- [Ri1] *C.M. Ringel*, Tame algebras and integral quadratic forms. Lecture Notes in Mathematics, 1099. Springer-Verlag, Berlin, 1984. xiii+376 pp.
- [Ri2] *C.M. Ringel*, Representation theory of finite-dimensional algebras. In: Representations of algebras (Durham, 1985), 7–79, London Math. Soc. Lecture Note Ser., 116, Cambridge Univ. Press, Cambridge, 1986.

- [Ri3] *C.M. Ringel*, The category of modules with good filtrations over a quasi-hereditary algebra has almost split sequences. *Math. Z.* 208 (1991), no. 2, 209–223.
- [Ri4] *C.M. Ringel*, The category of good modules over a quasi-hereditary algebra. *Proceedings of the Sixth International Conference on Representations of Algebras (Ottawa, ON, 1992)*, 17 pp., Carleton-Ottawa Math. Lecture Note Ser., 14, Carleton Univ., Ottawa, ON, 1992.
- [Ri5] *C.M. Ringel*, The preprojective algebra of a quiver. *Algebras and modules, II (Geiranger, 1996)*, 467–480, CMS Conf. Proc., 24, Amer. Math. Soc., Providence, RI, 1998.
- [Ri6] *C.M. Ringel*, PBW-bases of quantum groups. *J. Reine Angew. Math.* 470 (1996), 51–88.
- [S] *A. Schofield*, Quivers and Kac-Moody Lie algebras. Unpublished Preprint.
- [SZ] *P. Sherman, A. Zelevinsky*, Positivity and canonical bases in rank 2 cluster algebras of finite and affine type. *Moscow Math. J.* 4 (2004), no. 4, 947–974.

CHRISTOF GEISS
INSTITUTO DE MATEMÁTICAS
UNIVERSIDAD NACIONAL AUTÓNOMA DE MÉXICO
CIUDAD UNIVERSITARIA
04510 MÉXICO D.F.
MÉXICO

E-mail address: `christof@math.unam.mx`

BERNARD LECLERC
LABORATOIRE LMNO
UNIVERSITÉ DE CAEN
F-14032 CAEN CEDEX
FRANCE

E-mail address: `leclerc@math.unicaen.fr`

JAN SCHRÖER
MATHEMATISCHES INSTITUT
UNIVERSITÄT BONN
BERINGSTR. 1
D-53115 BONN
GERMANY

E-mail address: `schroer@math.uni-bonn.de`