

# HAMILTONICITY OF VERTEX-TRANSITIVE GRAPHS OF ORDER $4p$

Klavdija Kutnar<sup>a,1</sup> and Dragan Marušič<sup>a,b,2,\*</sup>

<sup>a</sup>*University of Primorska, Cankarjeva 6, 6000 Koper, Slovenia*

<sup>b</sup>*IMFM, University of Ljubljana, Jadranska 19, 1000 Ljubljana, Slovenia*

## Abstract

It is shown that every connected vertex-transitive graph of order  $4p$ , where  $p$  is a prime, is hamiltonian with the exception of the Coxeter graph which is known to possess a Hamilton path.

*Keywords:* graph, vertex-transitive, Hamilton cycle, automorphism group.

## 1 Introductory remarks

In 1969, Lovász [22] asked if every finite, connected vertex-transitive graph has a Hamilton path, that is, a path going through all vertices of the graph. With the exception of  $K_2$ , only four connected vertex-transitive graphs that do not have a Hamilton cycle are known to exist. These four graphs are the Petersen graph, the Coxeter graph and the two graphs obtained from them by replacing each vertex by a triangle. The fact that none of these four graphs is a Cayley graph has led to a folklore conjecture that every Cayley graph is hamiltonian (see [2, 3, 4, 5, 12, 14, 15, 16, 23, 29, 37, 38, 39] for the current status of this conjecture).

Coming back to vertex-transitive graphs, it was shown in [14] that, with the exception of the Petersen graph, a connected vertex-transitive graph whose automorphism group contains a transitive subgroup with a cyclic commutator subgroup of prime-power order, is hamiltonian. Furthermore, for connected vertex-transitive graphs of orders  $p$ ,  $2p$  (except for the Petersen graph),  $3p$ ,  $p^2$ ,  $p^3$ ,  $p^4$  and  $2p^2$  it was shown that they are hamiltonian (see [1, 9, 10, 30, 31, 32, 35]). (Throughout this paper  $p$  will always denote a prime number.) On the other hand, connected vertex-transitive graphs of orders  $4p$  and  $5p$  are only known to have Hamilton paths (see [27, 28]). It is the object of this paper to complete the analysis of hamiltonian properties of vertex-transitive graphs of order  $4p$  by proving the following result.

**Theorem 1.1** *With the exception of the Coxeter graph, every vertex-transitive graph of order  $4p$ , where  $p$  is a prime, is hamiltonian.*

<sup>1</sup>Supported in part by “Agencija za raziskovalno dejavnost Republike Slovenije”, proj. mladi raziskovalci.

<sup>2</sup>Supported in part by “Agencija za raziskovalno dejavnost Republike Slovenije”, research program P1-0285.

\*Corresponding author e-mail: dragan.marusic@guest.arnes.si

The proof of Theorem 1.1 is carried out over the remaining sections. Our strategy in the search for Hamilton cycles in connected vertex-transitive graphs of order  $4p$  is based on an analysis singling out two facets of the structure of graphs in question.

First, a thorough analysis of various possibilities arising from (im)primitivity of the action of the automorphism group of a vertex-transitive graph of order  $4p$  is done in Section 3. More precisely, a vertex-transitive graph on  $4p$  vertices falls into one (but possibly more than one) of eight classes, depending on various kinds of imprimitivity block systems its automorphism group admits (see Table 1 in Section 3 for details). For some of these classes, sufficient conditions for existence of Hamilton cycles in the corresponding graphs are given (see Lemmas 3.2, 3.4 and 3.5), leading to Proposition 3.8, where we prove that a connected vertex-transitive graphs of order  $4p$  not isomorphic to the Coxeter graph is either hamiltonian or it has an imprimitivity block system with blocks of size  $p$  or  $2p$ .

This result, reducing the total number of classes from the initial eight to three, is then combined in Section 4 with results obtained from our second analysis taking into account the well known fact that every vertex-transitive graph of order  $mp$ , where  $m \leq p$  has an  $(m, p)$ -semiregular automorphism [26]. In particular, letting  $\gamma$  be a  $(4, p)$ -semiregular automorphism of a vertex-transitive graph  $X$  of order  $4p$ , the corresponding quotient graph  $X_\gamma$  of  $X$  with respect to  $\gamma$  is one of six connected graphs of order 4. In [28], a thorough analysis for each of these six cases resulted in the proof that every such graph has a Hamilton path. Of course, as close as the concepts of Hamilton paths and cycles may seem, the difficulties encountered in constructions of Hamilton cycles usually greatly exceed those encountered in similar constructions of Hamilton paths. It is therefore not surprising that this second approach alone had not been enough to complete the result, thus calling for our two way analysis.

## 2 Preliminary observations

Throughout this paper graphs are finite, simple, undirected and connected, unless specified otherwise. By  $p$  we shall always denote a prime number. Also, all groups are assumed to be finite. For adjacent vertices  $u$  and  $v$  in  $X$ , we write  $u \sim v$  and denote the corresponding edge by  $uv$ . Given a graph  $X$  we let  $V(X)$ ,  $E(X)$  and  $\text{Aut}X$  be the vertex set, edge set and the automorphism group of  $X$ , respectively. A graph  $X$  is said to be *vertex-transitive* if its automorphism group  $\text{Aut}X$  acts transitively on  $V(X)$ . Let  $U$  and  $W$  be disjoint subsets of  $V(X)$ . The subgraph of  $X$  induced by  $U$  will be denoted by  $X\langle U \rangle$ ; in short, by  $\langle U \rangle$ , when the graph  $X$  is clear from the context. Similarly, we let  $X[U, W]$  (in short  $[U, W]$ ) denote the bipartite subgraph of  $X$  induced by the edges having one endvertex in  $U$  and the other endvertex in  $W$ .

Given a transitive group  $G$  acting on a set  $V$ , we say that a partition  $\mathcal{B}$  of  $V$  is *G-invariant* if the elements of  $G$  permute the parts, that is, *blocks* of  $\mathcal{B}$ , setwise. If the trivial partitions  $\{V\}$  and  $\{\{v\} : v \in V\}$  are the only  $G$ -invariant partitions of  $V$ , then  $G$  is said to be *primitive*, and is said to be *imprimitive* otherwise. In the latter case we shall refer to a corresponding  $G$ -invariant partition as to an *imprimitivity block system* of  $G$ . If the set  $V$  above is the vertex set of a vertex-transitive graph  $X$ , and  $\mathcal{B}$  is an imprimitivity system of  $G$ , then clearly any two blocks  $B, B' \in \mathcal{B}$  induce isomorphic vertex-transitive subgraphs.

For a graph  $X$  and a partition  $\mathcal{P}$  of  $V(X)$ , we let  $X_{\mathcal{P}}$  be the associated *quotient graph* of  $X$  relative to  $\mathcal{P}$ , that is, the graph with vertex set  $\mathcal{P}$  and edge set induced naturally by the edge set  $E(X)$ . An automorphism of a graph is called  $(m, n)$ -*semiregular*, where  $m \geq 1$  and  $n \geq 2$  are integers, if it has  $m$  orbits of length  $n$  and no other orbit. In the case when  $\mathcal{P}$  corresponds to the

set of orbits of a semiregular automorphism  $\gamma \in \text{Aut}X$ , the symbol  $X_{\mathcal{P}}$  will be replaced by  $X_{\gamma}$ .

Let  $X$  be a connected vertex-transitive graph of order  $4p$ , let  $\mathcal{W} = \{W_i \mid i \in \mathbb{Z}_4\}$  be the set of orbits of a  $(4, p)$ -semiregular automorphism  $\gamma$  of  $X$  and let the vertices of  $X$  be labeled in such a way that  $v_i^r \in W_i$  for  $i \in \mathbb{Z}_4$  and  $r \in \mathbb{Z}_p$ . Then  $X$  may be represented by the notation of Frucht [17] emphasizing the four orbits of  $\gamma$ . (In fact Frucht's notation can be used for any graph that admits a semiregular automorphism but we explain it here just for graphs admitting a  $(4, p)$ -semiregular automorphism.) In particular, the four orbits of  $\gamma$  are represented by four circles. The symbol  $p/x$ , where  $x \in \mathbb{Z}_p^*$ , inside a circle corresponding to the orbit  $W_i$  means that for each  $r \in \mathbb{Z}_p$ , the vertex  $v_i^r$  is adjacent to the vertex  $v_i^{r+x}$ . Similarly the symbol  $p$  inside a circle corresponding to the orbit  $W_i$  means that  $W_i$  is an independent set of vertices. Finally, an arrow pointing from the circle representing the orbit  $W_i$  to the circle representing the orbit  $W_j$ ,  $j \neq i$ , labeled by  $y \in \mathbb{Z}_p$  means that for each  $r \in \mathbb{Z}_p$ , the vertex  $v_i^r \in W_i$  is adjacent to the vertex  $v_j^{r+y}$ . An example illustrating this notation is given in Figure 1.

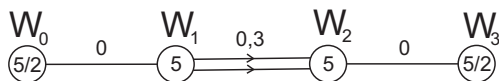

Figure 1: The dodecahedron given in the Frucht's notation relative to a  $(4, 5)$ -semiregular automorphism.

The following classical result, due to Jackson [19] giving a sufficient condition for the existence of Hamilton cycles in regular graphs will be used here and throughout the rest of this paper.

**Proposition 2.1** [19, Theorem 6] *Every 2-connected regular graph of order  $n$  and valency at least  $n/3$  is hamiltonian.*

We end this section with the proof that all vertex-transitive graphs of order  $4p$ ,  $p \leq 5$  a prime, are hamiltonian. This will simplify the hamiltonicity analysis in the subsequent sections. In the proof the so called LCF code [18] will be used. The LCF code of a hamiltonian cubic graph relative to one of its Hamilton cycles  $(v_0, v_1, \dots, v_{n-1}, v_0)$  is a list  $\text{LCF}[a_0, a_1, \dots, a_{n-1}]$  of elements of  $\mathbb{Z}_n \setminus \{0, 1, n-1\}$  such that  $v_i$  is adjacent to  $v_{i+a_i}$  for every  $i \in \mathbb{Z}_n$ . In addition, if there exists a proper divisor  $k$  of  $n$  such that  $a_i = a_{i+rk}$  for all  $i \in \mathbb{Z}_k$  and  $r \in \{1, 2, \dots, \frac{n}{k} - 1\}$  then the notation is simplified to  $\text{LCF}[a_0, a_1, \dots, a_{k-1}]^{\frac{n}{k}}$ .

**Proposition 2.2** *A connected vertex-transitive graph of order  $4p$ , where  $p \leq 5$  is a prime, is hamiltonian.*

PROOF. For  $p = 2$  the result follows from [30]. By [24] every vertex-transitive graph of order 12 is also a Cayley graph. By Proposition 2.1, it suffices to consider only graphs of valency at most 3. There are five such graphs:  $C_{12}$ ,  $C_6 \times K_2$ , a graph obtained from  $K_4$  by replacing each vertex by a triangle,  $\text{Cay}(\mathbb{Z}_{12}, \{1, 6\})$  and the graph with LCF code  $[5, -5]^6$ . All of these graphs are hamiltonian. We may therefore assume that  $p = 5$ . (Note that by [25], there are 1190 connected vertex-transitive graphs of order 20.) Let  $X$  be a connected vertex-transitive graph of order 20. By Proposition 2.1, we may assume that the valency of  $X$  is less than 7. Suppose first that  $X$  is a Cayley graph of a group  $G$  and let  $P$  be a Sylow 5-subgroup of  $G$ . Then  $P$  is normal in  $G$  and the quotient group  $G/P$ , being of order 4, is abelian. Therefore, either  $G$  itself is abelian or the commutator subgroup of  $G$  is cyclic of order 5. Hence by [15, 29]  $X$  has a Hamilton cycle. Let now  $X$  be a non-Cayley graph of order 20. It can be deduced from [25] that there are 80 possibilities



### 3 Analysis with respect to the action of $\text{Aut}X$

An analysis of (im)primitivity of the full automorphism group of a vertex-transitive graph of order  $4p$ ,  $p$  a prime, is crucial in the proof of the main theorem of this paper. Let us first divide all vertex-transitive graphs of order  $4p$  into eight classes in the following way. For a vertex-transitive graph  $X$  of order  $4p$ , let  $A = \text{Aut}X$  and choose  $v \in V(X)$ . Let  $(A_0, A_1, \dots, A_{k-1})$  be a sequence of groups such that  $A_0 = A$ ,  $A_{k-1} = A_v$  is the vertex stabilizer and  $A_i$  is maximal in  $A_{i-1}$ ,  $i \in \{1, \dots, k-1\}$ . The corresponding sequence of indices  $[A_{i-1} : A_i]$ , ( $i \in \{1, \dots, k-1\}$ ), will be called a *type* of the graph  $X$ . In view of these comments we shall say that  $X$  belongs to *Class I*, *Class II*, *Class III*, *Class IV*, *Class V*, *Class VI*, *Class VII* and *Class VIII*, respectively, if it is of type  $(4p)$ ,  $(2 : 2p)$ ,  $(2p : 2)$ ,  $(2 : p : 2)$ ,  $(p : 2 : 2)$ ,  $(p : 4)$ ,  $(4 : p)$  and  $(2 : 2 : p)$  (see also Table 1). For example, *Class I* contains vertex-transitive graphs of order  $4p$  with a primitive automorphism group and *Class II* contains vertex-transitive graphs of order  $4p$  whose automorphism group has an imprimitivity system of two blocks of size  $2p$  and the block stabilizer acts primitively on each of the two blocks. As we shall see in Lemmas 3.6 and 3.7 the above eight classes are not all disjoint.

<i>Class I</i>	$(4p)$
<i>Class II</i>	$(2 : 2p)$
<i>Class III</i>	$(2p : 2)$
<i>Class IV</i>	$(2 : p : 2)$
<i>Class V</i>	$(p : 2 : 2)$
<i>Class VI</i>	$(p : 4)$
<i>Class VII</i>	$(4 : p)$
<i>Class VIII</i>	$(2 : 2 : p)$

Table 1: Eight classes of vertex-transitive graphs of order  $4p$

The following result on primitive groups of degree  $4p$  may be extracted from [20, 21]. By  $D_{2n}$  we denote the dihedral group of order  $2n$ .

**Proposition 3.1** *Let  $G$  be a primitive group of degree  $4p$ , where  $p \geq 7$ , is a prime. Then  $G$  is one of the following:*

- (i)  $A_8$  or  $S_8$  acting on the  $28 = 4p$  unordered pairs of points from an 8-element set;
- (ii)  $PSL(2, 8)$  acting on the  $28 = 4p$  cosets of a subgroup  $D_{18}$ ;
- (iii)  $PGL(2, 7)$  acting on the  $28 = 4p$  cosets of a subgroup  $D_{12}$ ;
- (iv)  $PSL(2, 16) \leq G \leq PGL(2, 16)$  acting on the  $68 = 4p$  cosets of a subgroup  $N_G(PGL(2, 4))$ ;
- (v)  $PSL(3, 3) \leq G \leq PGL(3, 3)$  acting on the  $52 = 4p$  incident point-line pairs of  $PG(2, 3)$ .

Of course, vertex-transitive graphs arising from the above actions in Proposition 3.1 belong to *Class I* and MAGMA program package [7] was used to obtain semiregular automorphisms relative to which a Hamilton cycle in the corresponding quotient graph lifting to a Hamilton cycle in the original graph was found. It turns out that the Coxeter graph, a cubic graph associated with the group action (iii), is the only graph not possessing a Hamilton cycle [6]. For details see Appendix 5. Combining the above arguments with Proposition 2.2 we have the following result.

**Lemma 3.2** *Let  $X$  be a connected vertex-transitive graph of order  $4p$ ,  $p$  a prime, belonging to *Class I*. Then  $X$  is either hamiltonian or it is isomorphic to the Coxeter graph.*

The following result on primitive groups of degree  $2p$  that may be deduced from [21] will be needed here and later on in the paper.

**Proposition 3.3** *A primitive group  $G$  of degree  $2p$ ,  $p$  a prime, is one of the following:*

- (i)  $G$  is simply primitive and  $p = 5$  and  $G = A_5$  or  $G = S_5$ ;
- (ii)  $G = A_{2p}$  or  $G = S_{2p}$ ;
- (iii)  $p = 11$  and  $G = M_{22}$ ;
- (iv)  $p = \frac{1+q^{2^t}}{2}$ , where  $q$  is an odd prime,  $\text{Aut}PSL(2, k)$  containing  $PSL(2, k)$ , where  $k = q^{2^t}$  and  $q$  is an odd prime.

Moreover,  $G$  is simply primitive in case (i) and is doubly transitive in all other cases.

For a permutation group  $G$  acting on a set  $V$  and a subset  $W$  of  $V$  we let  $G_W$  denote the setwise stabilizer of  $W$  in  $G$  and we let  $G_{(W)}$  denote the pointwise stabilizer of  $W$  in  $G$ . The next two results assure the existence of Hamilton cycles in vertex-transitive graphs of order  $4p$  belonging to *Classes II* and *III*.

**Lemma 3.4** *A connected vertex-transitive graph of order  $4p$ ,  $p$  a prime, belonging to Class II is hamiltonian.*

PROOF. By Proposition 2.2, we may assume that  $p \geq 7$ . Let  $X$  be a connected vertex-transitive graph with  $4p$  vertices, let  $A = \text{Aut}X$  be its automorphism group, and let  $\mathcal{B} = \{B, B'\}$  be an imprimitivity block system of  $A$  consisting of two blocks of size  $2p$ . Since  $X$  is of type  $(2 : 2p)$ , the group  $A_B = A_{B'}$  is a primitive group of degree  $2p$ , in its action on  $B$  and  $B'$ . Now, in view of Proposition 3.3, these two actions are equivalent and  $A_B = A_{B'}$  acts doubly transitively on  $B$  and  $B'$ . For regularity reasons, the induced subgraphs on  $B$  and  $B'$  are either both isomorphic to the complete graph  $K_{2p}$  or are totally disconnected. In the first case, the valency of  $X$  is greater than  $2p - 1$ , and hence  $X$  is hamiltonian by Proposition 2.1. If  $X\langle B \rangle$  and  $X\langle B' \rangle$  are totally disconnected then, depending on whether the two actions are faithful or unfaithful, we obtain that either  $X \cong K_{2p, 2p} - 2pK_2$  or  $X \cong K_{2p, 2p}$ . In both cases, Proposition 2.1 gives us a Hamilton cycle in  $X$ . ■

**Lemma 3.5** *A connected vertex-transitive graph of order  $4p$ ,  $p$  a prime, belonging to Class III is hamiltonian.*

PROOF. By Proposition 2.2, we may assume that  $p \geq 7$ . Let  $X$  be a connected vertex-transitive graph with  $4p$  vertices, let  $A = \text{Aut}X$  be its automorphism group, let  $\mathcal{B}$  be an imprimitivity block system of  $A$  consisting of  $2p$  blocks of size 2, and let  $K$  be the kernel of the action of  $A$  on  $\mathcal{B}$ . Since  $X$  is of type  $(2p : 2)$ , it follows that  $\bar{A} = A/K$  is primitive on  $\mathcal{B}$ . By Proposition 3.3,  $\bar{A}$  acts doubly transitively and so the quotient graph  $X_{\mathcal{B}}$  is isomorphic to the complete graph  $K_{2p}$ . Now, the bipartite subgraphs  $X[B, B']$ ,  $B, B' \in \mathcal{B}$ , are all isomorphic and must have, for arithmetic reasons, an even number of edges. Hence  $X[B, B'] \cong 2K_2$  or  $X[B, B'] \cong K_{2, 2}$ . Therefore the valency of the graph  $X$  is at least  $2p - 1$  and Proposition 2.1 gives us a Hamilton cycle in  $X$ . ■

**Lemma 3.6** *Let  $X$  be a connected vertex-transitive graph of order  $4p$ ,  $p \geq 7$  a prime, such that  $\text{Aut}X$  admits an imprimitivity block system  $\mathcal{B}$  with  $p$  blocks of size 4 (and so  $X$  is either in Class V or Class VI). If the kernel  $K$  of the action of  $\text{Aut}X$  on  $\mathcal{B}$  is trivial then  $X$  belongs to Class IV, Class VII or Class VIII, or  $X$  is isomorphic to the graph shown in Figure 3.*

PROOF. Since, by assumption,  $K = 1$  we have that  $A = \text{Aut}X \cong \bar{A} = A/K$  is a group of prime degree. If  $A$  is solvable then, in view of [33, Proposition 2.1], we have that  $A \leq A(1, p)$  and it follows from [13, Theorem 3.5B] that  $A$  has a regular normal Sylow  $p$ -subgroup. Thus, there exists a  $(4, p)$ -semiregular element  $\gamma \in A$  such that  $\langle \gamma \rangle$  is normal in  $A$  and so, by [36, Theorem 8.8],  $X$  belongs to Class VII or Class VIII.

Suppose now that  $A$  is nonsolvable. Then, by [13, Theorem 3.5B],  $A$  is doubly transitive and so  $X_{\mathcal{B}} = K_p$ . Again using Proposition 3.3 and checking all the possibilities for the existence of index 4 subgroups in the block stabilizer  $A_B$ ,  $B \in \mathcal{B}$ , we can see that  $PSL(n, k) \leq A \leq \text{Aut}PSL(n, k)$  for appropriate  $n$  and  $k$ , in view of the fact that  $p \geq 7$ .

If  $A = PSL(n, k)$  or if  $A$  properly contains a copy of  $PSL(n, k)$  acting transitively, then following the argument used in [33] we obtain that the groups  $PSL(3, 2)$  and  $PSL(3, 3)$  acting on cosets of  $S_3$  and  $2S_3$ , respectively, are the only possibilities. The latter is clearly impossible for it would give rise to a graph of order  $468 = 4 \cdot 117$ , which is not of the form  $4p$ . As for the action of  $PSL(3, 2)$  on  $S_3$ , using program package MAGMA [7] we deduce that  $S_3$  has six nontrivial suborbits, two of which are non-self-paired of length 6. Of the four self-paired suborbits, three are of length 3 and one is of length 6. The graph arising from the union of the two non-self-paired suborbits has valency 12 and is isomorphic to the graph arising from the self-paired suborbit of length 12 in the action of  $PGL(2, 7)$  on cosets of  $D_{12}$ . The graph arising from one of the suborbits of length 3 is isomorphic to the Coxeter graph and hence with a primitive automorphism group. Next, the graphs arising from the other two suborbits of length 3 are both disconnected and isomorphic to  $7K_4$ . Furthermore, the union of these two graphs is isomorphic to the graph arising from one of the self-paired suborbits of length 6 in the action of  $PGL(2, 7)$  on the cosets of  $D_{12}$ . As for the graph arising from the union of two self-paired suborbits of length 3, one giving rise to  $7K_4$  and the other giving to the Coxeter graph, it is isomorphic to the graph depicted in Figure 3 using Frucht's notation [17]. Finally, the graph arising from the self-paired suborbit of length 6 is isomorphic to one of the graphs associated with the action of  $PGL(2, 7)$  on cosets of  $D_{12}$ .

If  $A$  properly contains a copy of  $PSL(n, k)$  acting intransitively, then the normality of  $PSL(n, k)$  in  $A$  gives us an imprimitivity block system  $\mathcal{C}$  for  $A$ . Since  $p$  does not divide  $[\text{Aut}PSL(n, k) : PSL(n, k)]$ , it follows that  $\mathcal{C}$  consists of blocks of length  $p$  or  $2p$ , completing the proof of Lemma 3.6. ■

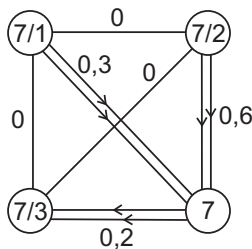

Figure 3: The vertex-transitive graph whose automorphism group is isomorphic to  $PSL(3, 2)$  given in the Frucht's notation relative to a  $(4, 7)$ -semiregular automorphism.

Vertex-transitive graphs of order  $2p$ ,  $p$  a prime, were described in [26]. Among others it was proved there that, provided a vertex-transitive graph  $X$  of order  $2p$  admits an imprimitive group  $G$  (with blocks of size  $p$  or  $2$ ), one can always find an imprimitive subgroup of  $G$  which has blocks of size  $p$ . Moreover, if  $A = \text{Aut}X$  itself has blocks of size  $2$  and no blocks of size  $p$ , it may be deduced from the proof of [26, Theorem 6.2] that  $X$  or its complement is the wreath product  $Y \wr 2K_1$  where  $Y$  is a  $p$ -circulant (Recall that for graphs  $X$  and  $Y$ , the *wreath product*, sometimes also called the *lexicographic product*  $X \wr Y$ , has vertex set  $V(X) \times V(Y)$  with two vertices  $(a, u)$  and  $(b, v)$  adjacent in  $X \wr Y$  if and only if either  $ab \in E(X)$  or  $a = b$  and  $uv \in E(Y)$ ). This enables us to prove the following result.

**Lemma 3.7** *Let  $X$  be a connected vertex-transitive graph of order  $4p$ ,  $p \geq 7$ , belonging to Class V or Class VI and let  $\mathcal{B}$  be an imprimitivity block system of  $\text{Aut}X$  with blocks of size 4. Then one of the following holds*

- (i)  $X$  belongs to Class IV, Class VII or Class VIII;
- (ii)  $X$  is as shown in Figure 3;
- (iii)  $X$  is a Cayley graph of an abelian group;
- (iv)  $X$  is isomorphic to  $Y \wr Z$ , where  $Y$  is a connected vertex-transitive graph of order  $2p$  and  $Z$  is either  $2K_1$  or  $K_2$ ;
- (v)  $X$  is a regular  $\mathbb{Z}_2$ -cover of  $K_p \wr 2K_1$ ; or
- (vi) there exist adjacent blocks  $B, B'$  in  $X_{\mathcal{B}}$  such that  $X[B, B']$  is  $K_{4,4}$  or  $2C_4$ .

PROOF. Let  $K$  be the kernel of the action of  $A = \text{Aut}X$  on  $\mathcal{B}$ . If  $K = 1$ , then Lemma 3.6 implies that  $X$  belongs to Class IV, Class VII or Class VIII, or  $X$  is the graph in Figure 3. Assume now that  $K$  is nontrivial. We shall distinguish two different cases.

CASE 1. If  $K$  is intransitive on each of the blocks in  $\mathcal{B}$ , it follows that  $K^B$  is either  $\mathbb{Z}_2$  for each  $B \in \mathcal{B}$  or  $\mathbb{Z}_2^2$  for each  $B \in \mathcal{B}$ , and further, the orbits of  $K$  form an imprimitivity block system  $\mathcal{E}$  with blocks of size 2. Clearly,  $K$  is also the kernel of the action of  $A$  on  $\mathcal{E}$ . If  $K \neq \mathbb{Z}_2$  then the action of  $K$  on the blocks in  $\mathcal{E}$  is unfaithful and so  $X$  must be the wreath product of the vertex-transitive graph  $X_{\mathcal{E}}$  of order  $2p$  with  $2K_1$  or with  $K_2$ , and so (iv) holds. So let  $K = \mathbb{Z}_2$ . Consider the group  $\bar{A} = A/K$  acting on  $\mathcal{B}$ . If  $\bar{A}$  is solvable, then it has a normal subgroup  $PK/K$  of order  $p$  where  $P$  is a Sylow  $p$ -subgroup of  $A$ . Since  $K = \mathbb{Z}_2$  the Sylow theorems imply that  $P$  is a characteristic subgroup of  $PK$ . Since  $PK$  is normal in  $A$  we have that  $P$  is normal in  $A$ . It follows that  $X$  belongs to Class VII or Class VIII. We may therefore assume that the action of  $\bar{A}$  on  $\mathcal{B}$  is unsolvable and hence doubly transitive, by Burnside's classical result (see [34, Theorem 7.3]). Hence  $X_{\mathcal{B}} = K_p$ . Consider the action of  $\bar{A}$  on the quotient graph  $X_{\mathcal{E}}$ . If apart from blocks of size 2 it also has blocks of size  $p$ , then  $X$  belongs to Class IV. So we may assume that  $\bar{A}$  as well as  $\text{Aut}X_{\mathcal{E}}$  has no blocks of size  $p$ . By the comments preceding the statement of Lemma 3.7 and taking into account the fact that  $X_{\mathcal{B}} = K_p$ , it follows that  $X_{\mathcal{E}}$  is isomorphic to the wreath product  $K_p \wr 2K_1$ . Consequently,  $X$  is isomorphic either to  $X_{\mathcal{E}} \wr 2K_1$  or to  $X_{\mathcal{E}} \wr K_2$ , or it is a regular  $\mathbb{Z}_2$ -cover of  $X_{\mathcal{E}}$ . In short, either (iv) or (v) holds.

CASE 2. Assume now that  $K$  is transitive on each of the blocks  $B \in \mathcal{B}$ . We have  $K^B \in \{\mathbb{Z}_2^2, \mathbb{Z}_4, D_8, A_4, S_4\}$ . Suppose first that  $K$  is faithful. Then  $K \in \{\mathbb{Z}_2^2, \mathbb{Z}_4, D_8, A_4, S_4\}$  and we can assume that there is a characteristic subgroup  $H$  in  $K$  of order 4 (either  $\mathbb{Z}_2^2$  or  $\mathbb{Z}_4$ ). Hence  $H$  is normal in  $A$  and so  $H$  is normal in  $\langle \gamma, H \rangle$ , where  $\gamma$  is some  $(4, p)$ -semiregular element in  $A$ . The Sylow theorems imply that  $\langle \gamma, H \rangle = H \times \langle \gamma \rangle$ . Hence  $X$  is a Cayley graph either of  $\mathbb{Z}_{4p}$  or of  $\mathbb{Z}_{2p} \times \mathbb{Z}_2$ , and so (iii) holds.



We may now assume that  $K$  is unfaithful. Let  $B, B' \in \mathcal{B}$  be adjacent in  $X_{\mathcal{B}}$ . Then  $K_{(B)}^{B'} \neq 1$  and  $K_{(B)}^{B'}$  is normal in  $K^{B'}$ . If  $K_{(B)}^{B'}$  is transitive then  $X[B, B'] = K_{4,4}$ . If  $K_{(B)}^{B'}$  is intransitive then clearly  $K^{B'} = K^B \in \{\mathbb{Z}_2^2, \mathbb{Z}_4, D_8\}$ . Moreover,  $K_{(B)}^{B'}$  must have two orbits on  $B'$  and either  $X[B, B'] = K_{4,4}$  or  $X[B, B'] = 2C_4$ , and so (vi) holds. This completes the proof of Lemma 3.7.  $\blacksquare$

Given a graph  $X$  admitting a  $(4, p)$ -semiregular automorphism with the set of orbits  $\mathcal{W}$  and an imprimitivity block system  $\mathcal{B}$  of  $\text{Aut}X$ , we have that

$$|W \cap B| = 1 \text{ or } W \subseteq B, \quad (1)$$

for each  $W \in \mathcal{W}$  and  $B \in \mathcal{B}$ .

Combining together results of this section we can prove the following proposition that reduces the possible existence of nonhamiltonian graphs of order  $4p$  to *Class IV*, *Class VII* or *Class VIII*.

**Proposition 3.8** *Let  $X$  be a connected vertex-transitive graph of order  $4p$ ,  $p$  a prime not isomorphic to the Coxeter graph. Then either  $X$  is hamiltonian or  $X$  belongs to Class IV, Class VII or Class VIII. In short, either  $X$  is hamiltonian or  $\text{Aut}X$  has an imprimitivity block system with blocks of size  $p$  or  $2p$ .*

PROOF. By Proposition 2.2, we may assume that  $p \geq 7$ . Let  $X$  be a connected vertex-transitive graph of order  $4p$  that belongs to *Class I*, *Class II*, *Class III*, *Class V* or *Class VI*. Then by Lemmas 3.2, 3.4 and 3.5, we may assume that  $X$  belongs to *Class V* or *Class VI*. Then one of the statements (ii)-(vi) in Lemma 3.7 holds.

First, if (ii) holds and  $X$  is as in Figure 3, then clearly  $X$  is hamiltonian. Also, if (iii) holds then  $X$  is hamiltonian too, in view of [29]. If (iv) holds, then  $X$  is hamiltonian in view of the fact that a connected vertex-transitive graph of order  $2p$ ,  $p \geq 7$ , has a Hamilton cycle [1], and the fact that the wreath product of a hamiltonian graph with  $2K_1$  is hamiltonian. If (v) holds and  $X$  is a regular  $\mathbb{Z}_2$ -cover of  $K_p \wr 2K_1$ , then its valency is  $2p - 2$ , and hence, by Proposition 2.1,  $X$  is hamiltonian. Finally, let us assume that (vi) holds. If there exist adjacent blocks  $B, B'$  in  $X_{\mathcal{B}}$  such that  $X[B, B']$  is isomorphic to  $K_{4,4}$  then  $X$  is clearly hamiltonian. We may therefore assume that for any two adjacent blocks  $B, B'$  in  $X_{\mathcal{B}}$  the graph  $X[B, B']$  is isomorphic to  $2C_4$ .

Let  $\mathcal{W} = \{W_i \mid i \in \mathbb{Z}_4\}$  be the set of orbits of a  $(4, p)$ -semiregular automorphism  $\gamma$  of  $X$ . By (1), there are  $v_0 \in W_0, v_1 \in W_1, v_2 \in W_2$  and  $v_3 \in W_3$  such that  $B = \{v_0, v_1, v_2, v_3\}$  is a block. Let  $v_i^r = \gamma^r(v_i)$ , for  $i \in \mathbb{Z}_4$  and  $r \in \mathbb{Z}_p$ . Then  $\mathcal{B} = \{B_r \mid r \in \mathbb{Z}_p\}$  where  $B_r = \gamma^r(B) = \{v_0^r, v_1^r, v_2^r, v_3^r\}$  for  $r \in \mathbb{Z}_p$ . Without loss of generality we may assume that the bipartite graph  $X[B, B']$  is one of the graphs in Figure 4. Now, the bipartite graph  $X[B, B']$  in Figure 4(a) gives rise to a spanning subgraph in  $X$  that is isomorphic to the wreath product of a connected vertex-transitive graph of order  $2p$  with  $2K_1$ . Clearly, in this case  $X$  is hamiltonian. We may therefore assume that  $X[B, B']$  is either the one in Figure 4(b) or the one in Figure 4(c). It follows that  $X$  contains a spanning subgraph isomorphic, respectively, to the graphs shown in Figure 5, using Frucht's notation [17], with  $a \in \mathbb{Z}_p$ . Since

$$\begin{aligned} &v_1^0 v_1^{-1} \dots v_1^l v_3^{l+1} v_3^{l+2} \dots v_3^l v_1^{l-1} v_1^{l-2} \dots v_1^2 v_1^1 v_2^{a+1} v_2^{a+2} \dots \\ &\dots v_2^{a+k} v_0^{a+k+1} v_0^{a+k+2} \dots v_0^{a+k} v_2^{a+k+1} v_2^{a+k+2} \dots v_2^a v_1^0 \end{aligned}$$

is a Hamilton cycle in the graph on the left in Figure 5 and

$$v_0^0, v_2^1 v_3^2 v_1^4 v_0^5 v_2^6 \dots v_0^{p-4} v_2^{p-3} v_3^{p-2} v_1^{p-1} v_0^0$$

is a Hamilton cycle in the graph on the right in Figure 5, the result follows. ■

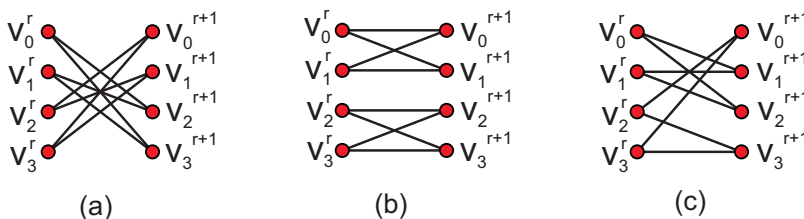

Figure 4: Possible forms of the bipartite graph  $X[B, B']$  where  $B$  and  $B'$  are adjacent blocks of size 4.

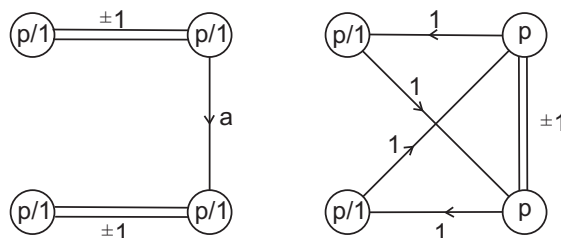

Figure 5: Two possibilities for a spanning subgraph in  $X$ . The graph on the left corresponds to the graph in Figure 4(b) and the graph on the right corresponds to the graph in Figure 4(c). Where  $a \in \mathbb{Z}_p$ .

## 4 Analysis with respect to the quotient graph $X_\gamma$

We shall now combine Proposition 3.8 with an analysis of the quotient graph  $X_\gamma$  of a connected vertex-transitive graph  $X$  of order  $4p$ ,  $p \geq 7$ , relative to a  $(4, p)$ -semiregular automorphism  $\gamma$  which exists in  $X$  in view of [26, Theorem 3.4.]. Let  $\mathcal{W} = \{W_i \mid i \in \mathbb{Z}_4\}$  denote the set of orbits of  $\gamma$ . Now there are six different possibilities for the quotient graph  $X_\gamma$  of  $X$  relative to  $\gamma$  (see Figure 6).

The following easy observations are straightforward. First, for any orbit  $W_i$  of  $\gamma$ , the induced subgraph  $\langle W_i \rangle$  is regular of some even valency  $d(W_i)$ . Moreover, if  $d(W_i) > 0$ , then  $\langle W_i \rangle$  contains a Hamilton cycle. Second, for distinct  $i, j$ , the bipartite graph  $X[W_i, W_j]$  is regular of some valency  $d[W_i, W_j] \geq 0$ . And finally, when  $d[W_i, W_j] \geq 2$ ,  $X[W_i, W_j]$  contains a Hamilton cycle.

A graph is *Hamilton-connected* if for every pair of vertices  $u$  and  $v$  there exists a Hamilton path whose endvertices are  $u$  and  $v$ . The following three results taken, respectively from, [11, Theorem 4], [27, Lemma 5], [2, Theorem 3.9], will play an essential role in the proof of Theorem 1.1.

**Proposition 4.1** ([11]). *Let  $X$  be a connected Cayley graph of an abelian graph of valency at least 3. If  $X$  is not bipartite then  $X$  is Hamilton-connected.*

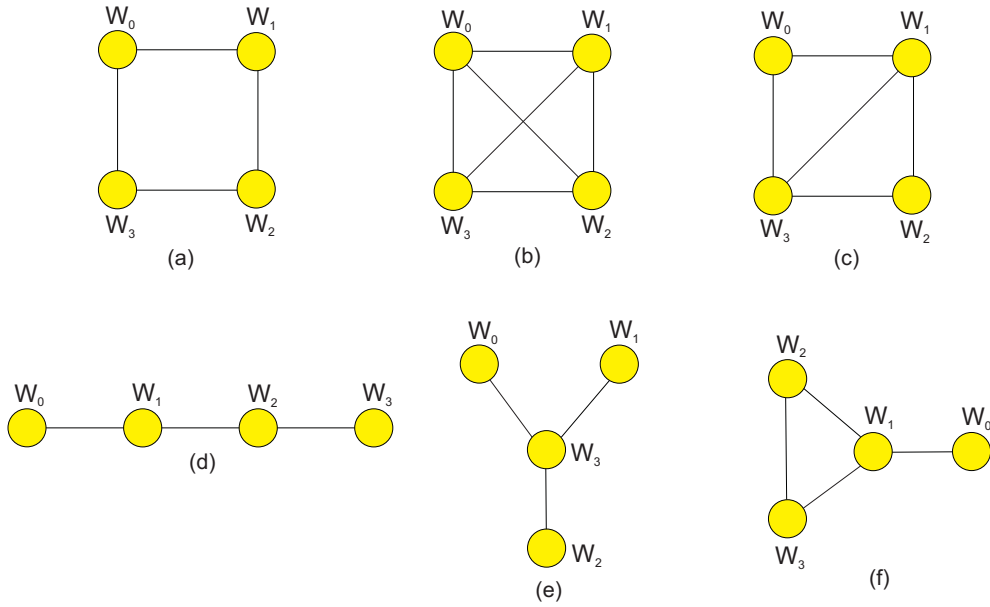

Figure 6: The six possibilities for the quotient graph  $X_\gamma$  of a connected vertex-transitive graph  $X$  of order  $4p$ .

**Proposition 4.2** ([27]). *Let  $\gamma$  be a semiregular automorphism of a graph  $X$  and let  $C = W_0W_1 \cdots W_{k-1}$ ,  $k \geq 3$ , be a cycle in  $X_\gamma$ . If  $\langle C \rangle$  does not contain a Hamilton cycle, then  $d[W_i, W_{i+1}] = 1$  for  $i \in \mathbb{Z}_k$ , and the graph induced by the edges of the graphs  $[W_i, W_{i+1}]$ ,  $i \in \mathbb{Z}_k$ , is a disjoint union of  $p$  cycles of length  $k$  in  $X$ .*

For the third result we need the concept of a coil of a cycle in a quotient graph, introduced in [2]. Let  $X$  be a graph that admits an  $(m, n)$ -semiregular automorphism  $\alpha$  and let  $\mathcal{W} = \{W_i \mid i \in \mathbb{Z}_m\}$  be the set of orbits of  $\alpha$ . Let  $C = W_rW_sW_t \dots W_qW_r$  be a cycle of length  $k$  in  $X_{\mathcal{W}}$  and let  $v_r^0, v_r^1, \dots, v_r^{n-1}$  be a cyclic labelling of the vertices of  $W_r$  under the action of  $\alpha$ . Consider the path of  $X$  arising from a lifting of  $C$ , namely, start at  $v_r^0$  and choose an edge from  $v_r^0$  to a vertex  $v_s^a$  of  $W_s$ . Then take an edge from  $v_s^a$  to a vertex of the  $W_t$  following  $W_s$  in  $C$ . Continue this way until returning to a vertex  $v_r^b$  of  $W_r$ . If  $b \neq 0$ , a path of length  $k$  has been constructed and if  $b = 0$ , it is a cycle of length  $k$ . There will be more than one such path if the degree between two consecutive orbits of  $\alpha$  is larger than one. The set of all paths in  $X$  arising from a lifting of  $C$  is denoted by  $coil(C)$ . The following result is proved in [2].

**Proposition 4.3** ([2]). *Let  $X$  be a graph admitting an  $(m, n)$ -semiregular automorphism  $\alpha$ , with  $m \geq 4$  even and  $n \geq 3$ , and let  $\mathcal{W} = \{W_i \mid i \in \mathbb{Z}_m\}$  be the set of orbits of  $\alpha$  such that each  $\langle W_i \rangle$  has valency 2 and is connected. If  $X_{\mathcal{W}}$  contains a Hamilton cycle  $C$  such that  $coil(C)$  contains a cycle, then  $X$  has a Hamilton cycle.*

We are now ready to prove Theorem 1.1.

**Proof of Theorem 1.1:** Let  $X$  be a connected vertex-transitive graph of order  $4p$  and valency  $d = d(X)$ , different from the Coxeter graph. By Proposition 2.2, we may assume that  $p \geq 7$ . Moreover, we may also assume that  $d \geq 3$ . Let  $\mathcal{W} = \{W_i \mid i \in \mathbb{Z}_4\}$  be the set of orbits of a  $(4, p)$ -semiregular automorphism  $\gamma$  of  $X$ . For  $i \in \mathbb{Z}_4$ , let  $d_i$  denote the valency of the induced

graph  $\langle W_i \rangle$ , and for  $i, j \in \mathbb{Z}_4$ , let  $d_{i,j}$  denote the valency of the induced bipartite graph  $[W_i, W_j]$ . By Proposition 3.8, we may assume that  $A = \text{Aut}X$  has an imprimitivity block system  $\mathcal{B}$  with blocks of size  $p$  or  $2p$ .

CASE 1.  $X_\gamma$  has a 4-cycle  $W_0W_1W_2W_3W_0$  (see Figure 6(a),(b),(c)).

By Proposition 4.2, we may assume that  $d_{i,i+1} = 1$  for  $i \in \mathbb{Z}_4$  and that the subgraph of  $X$  spanned by all the edges of the graphs  $[W_i, W_{i+1}]$ ,  $i \in \mathbb{Z}_4$ , is a disjoint union of  $p$  cycles of length 4.

SUBCASE 1.1.  $X_\gamma$  is the 4-cycle  $C_4$ .

The connectedness and regularity of  $X$  imply that  $d_i = d - 2 \geq 2$  for  $i \in \mathbb{Z}_4$ . If  $d_i = 2$  for  $i \in \mathbb{Z}_4$ , then by Proposition 4.3,  $X$  has a Hamilton cycle. If on the other hand,  $d_i \geq 4$  for  $i \in \mathbb{Z}_4$ , Proposition 4.1 implies that each subgraph  $\langle W_i \rangle$  is Hamilton-connected, and consequently  $X$  is hamiltonian.

SUBCASE 1.2.  $X_\gamma$  is the complete graph  $K_4$ .

By Proposition 4.2, we may assume that  $d_{i,j} = 1$  for distinct  $i, j \in \mathbb{Z}_4$ . By regularity of  $X$  we have that  $d_i = d_j$  for  $i, j \in \mathbb{Z}_4$ . If  $d_i = 2$  for  $i \in \mathbb{Z}_4$ , Proposition 4.3 implies that  $X$  contains a Hamilton cycle. On the other hand, if  $d_i \geq 4$  for  $i \in \mathbb{Z}_4$ , then Proposition 4.1 implies that  $X$  is hamiltonian.

SUBCASE 1.3.  $X_\gamma$  is neither  $C_4$  nor  $K_4$  (see Figure 6(c)).

We may assume that  $d_{1,3} > 0$  and  $d_{0,2} = 0$ . Therefore the valency of vertices in  $\langle W_0 \cup W_2 \rangle$  is even, and so  $d \geq 4$  is even. Hence  $d_0 = d_2 \geq 2$ . Consequently,  $d_{1,3}$  is even too, and so  $d_{1,3} \geq 2$ . Using (1), it is easily seen that  $\mathcal{B}$  cannot consist of four blocks of size  $p$  and so it consists of two blocks of size  $2p$ , each being a union of two orbits of  $\gamma$ . Without loss of generality we may assume that either  $W_0 \cup W_1$  or  $W_0 \cup W_2$  is a block  $B$  in  $\mathcal{B}$ . But the former cannot occur as then  $\langle B \rangle$  is not a regular graph. If however the latter is the case, then  $B' = W_1 \cup W_3$  is the other block in  $\mathcal{B}$  inducing a connected graph, whereas  $\langle B \rangle$  is disconnected, a contradiction.

CASE 2.  $X_\gamma$  is a tree.

SUBCASE 2.1.  $X_\gamma$  is the 3-path (see Figure 6(d)).

By regularity,  $d_0, d_3, d_{1,2} \geq 2$ . Assume first that  $\mathcal{B}$  is an imprimitivity block system consisting of four blocks of size  $p$ . By (1),  $\mathcal{B}$  coincides with the set of orbits  $\mathcal{W}$  of  $\gamma$ . Since any two blocks give rise to isomorphic vertex-transitive graphs, it follows that  $d_i = d_j$  for  $i, j \in \mathbb{Z}_4$ . But then, as  $d_{1,2} \geq 2$ , the vertices in  $W_1 \cup W_2$  would be of greater valency than those in  $W_0 \cup W_3$ , a contradiction.

Assume now that  $\mathcal{B}$  is an imprimitivity block system with two blocks of size  $2p$ . By (1) each block in  $\mathcal{B}$  is a union of two orbits of  $\gamma$ . In particular one of the sets  $W_0 \cup W_1$  or  $W_0 \cup W_2$  or  $W_0 \cup W_3$  must be a block in  $\mathcal{B}$ . The first possibility cannot occur for obvious arithmetic reasons since  $d_0 \neq d_1$ . The second possibility implies that  $d_0 = d_2$  and  $d_1 = d_3$ . But then, on the one hand, comparing the valencies of vertices in  $W_0$  and  $W_1$ , it follows that  $d_0 - d_1 = d_{1,2} \geq 2$ , and on the other hand, comparing the valencies of vertices in  $W_2$  and  $W_3$ , it follows that  $d_1 - d_0 = d_{1,2} \geq 2$ , a contradiction. Finally, the third possibility is also impossible as  $W_0 \cup W_3$  induces a disconnected graph, but  $W_1 \cup W_2$  induces a connected graph.

SUBCASE 2.2.  $X_\gamma$  is the star  $K_{1,3}$  (see Figure 6(e)).

By regularity,  $d_3$  is clearly different (smaller) from each of  $d_i$ ,  $i \in \mathbb{Z}_4 \setminus \{3\}$ . In particular, in view of (1), this implies that  $\mathcal{B}$  does not consist of four blocks of size  $p$ . Hence,  $\mathcal{B}$  consists of two blocks of size  $2p$ . By (1) each block in  $\mathcal{B}$  is a union of two orbits of  $\gamma$ . Without loss of generality these

two blocks are  $W_0 \cup W_1$  and  $W_2 \cup W_3$ . But the latter induces a graph which is not regular, a contradiction.

CASE 3.  $X_\gamma$  is the graph shown in Figure 6(f).

By regularity,  $d_0 \geq 2$  and  $d_1 \neq d_0$ . This implies that  $A$  cannot have blocks of size  $p$ , and so, using (1) again,  $\mathcal{B}$  consists of two blocks of size  $2p$ , each a union of two orbits of  $\gamma$ . For regularity reasons  $W_0 \cup W_1$  cannot be a block, and so with no loss of generality the blocks must be  $W_0 \cup W_2$  and  $W_1 \cup W_3$ . In particular  $d_0 = d_2$  and  $d_1 = d_3$ . But then, on the one hand, comparing the valencies of vertices in  $W_0$  and  $W_2$ , it follows that  $d_{0,1} = d_{1,2} + d_{2,3}$ , and on the other hand, comparing the valencies of vertices in  $W_1$  and  $W_3$ , it follows that  $d_{2,3} = d_{1,2} + d_{0,1}$ , a clear contradiction. This completes the proof of Theorem 1.1. ■

## 5 Appendix – Vertex-transitive graphs from Class I

We discuss here hamiltonicity properties of vertex-transitive graphs of order  $4p$  and valency less than  $4p/3$  having a primitive automorphism group, and thus arising from the actions in Proposition 3.1. The graphs are given in Table 2 using a certain collection of subsets of  $\mathbb{Z}_p$  associated with a  $(4, p)$ -semiregular automorphism.

Given a graph  $X$  with a  $(4, p)$ -semiregular automorphism  $\gamma$  with orbits  $W_i$ ,  $i \in \mathbb{Z}_4$ , choose  $w_i \in W_i$  and define the following subsets of  $\mathbb{Z}_p$ , the collection of which determines  $X$  uniquely. For  $i, j \in \mathbb{Z}_4$ , we let  $S_{i,j} = \{s \in \mathbb{Z}_p : [w_i, \gamma^s w_j] \in E(X)\}$ . Clearly  $S_{j,i} = -S_{i,j}$ . The  $4 \times 4$ -matrix  $\mathbf{S} = (S_{i,j})$  whose  $(i, j)$ -th entry is the set  $S_{i,j}$  is usually referred to as the *symbol* of  $X$  relative to  $\gamma$ . The connection between the symbol of a graph that admits a  $(4, p)$ -semiregular automorphism and the Frucht's notation [17] of a graph is given in Figure 7.

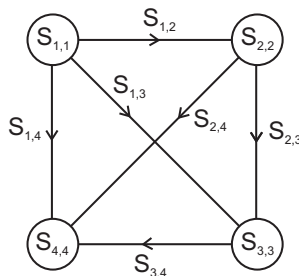

Figure 7: The Frucht's notation of a graph with symbol  $\mathbf{S} = (S_{i,j})$ .

As remarked in Section 1 each vertex-transitive graph of order  $4p$  has a  $(4, p)$ -semiregular automorphism. Using the program package MAGMA [7] a total of ten graphs of order  $4p$  with a primitive automorphism group and having valency less than  $4p/3$ , were found. For each of these graphs Table 2 gives corresponding symbols by listing their entries  $S_{i,j}$ ,  $i, j \in \mathbb{Z}_4$ . Among these graphs only the Coxeter graph is without a Hamilton cycle (the graph  $X_2$  in Table 2). This fact can be easily seen from the structure of the corresponding quotient graphs relative to a  $(4, p)$ -semiregular automorphism. Namely for each of these graphs, the quotient has a Hamilton cycle containing multiedges, and so this cycle lifts to a Hamilton cycle in the original graph (see also Proposition 4.2).

	$X_1$	$X_2$	$X_3$	$X_4$	$X_5$	$X_6$	$X_7$	$X_8$	$X_9$	$X_{10}$
$ V(X_i) $	28	28	28	28	28	28	68	68	68	52
<i>valency</i>	9	3	6	6	9	9	12	15	20	6
$S_{1,1}$	$\pm 3$	$\pm 1$	$\emptyset$	$\emptyset$	$\pm 2, \pm 3$	$\pm 1$	$\pm 2, \pm 5$	$\pm 6, \pm 8$	$\pm 2, \pm 3, \pm 6$	$\emptyset$
$S_{2,2}$	$\emptyset$	$\pm 2$	$\pm 3$	$\emptyset$	$\pm 1, \pm 3$	$\pm 3$	$\pm 1, \pm 6$	$\pm 1, \pm 5$	$\pm 5, \pm 7, \pm 8$	$\emptyset$
$S_{3,3}$	$\pm 1, \pm 3$	$\pm 4$	$\pm 1$	$\emptyset$	$\emptyset$	$\emptyset$	$\pm 4, \pm 7$	$\pm 2, \pm 7$	$\pm 4$	$\emptyset$
$S_{4,4}$	$\pm 1$	$\emptyset$	$\pm 2$	$\emptyset$	$\pm 1, \pm 2$	$\pm 2$	$\pm 3, \pm 8$	$\pm 3, \pm 4$	$\pm 1$	$\emptyset$
$S_{1,2}$	$0, \pm 2$	$\emptyset$	$0, 3$	$0, 3$	$0$	$0, 4$	$0, 1$	$0, 5, 7, 9, 14$	$0, 12, 13, 16$	$0, 4$
$S_{1,3}$	$0, 6$	$\emptyset$	$0, 6$	$0, 6$	$0, \pm 2$	$0, 1, 4$	$0, 15$	$0$	$0, \pm 1, 9, 10, 11$	$0, 10$
$S_{1,4}$	$0, 4$	$0$	$0, 5$	$0, 5$	$0$	$0, 1$	$0, 12, 13, 16$	$0, 1, 2, 6, 13$	$0, \pm 5, 10$	$0, 12$
$S_{2,3}$	$2, 4$	$\emptyset$	$5$	$0, 3$	$0, \pm 3$	$0, 2, 4$	$2, 4, 10, 12$	$6, \pm 7, 13, 14$	$3, 6, 9, 12$	$0, 6$
$S_{2,4}$	$0, 1, \pm 3$	$0$	$1$	$0, 2$	$0$	$1, 3$	$1, 10$	$11$	$\pm 2, 4, 6, 8, 12$	$0, 8$
$S_{3,4}$	$1$	$0$	$4$	$0, 1$	$0, \pm 1$	$0, \pm 1$	$8, 12$	$5, \pm 7, 8, 16$	$\pm 2, 3, \pm 7, 9, 12, 13$	$0, 11$

Table 2: Symbols of connected vertex-transitive graphs of valency less than one third of the number of vertices arising from the actions in Proposition 3.1.

For the action of  $A_8$  on cosets of  $S_6$  and the action of  $S_8$  on cosets of  $S_6 \times \mathbb{Z}_2$  (part (i) of Proposition 3.1) the corresponding orbital graphs have valencies 12 and 15, and thus more than  $28/3$ . So these graphs are hamiltonian by Proposition 2.1.

For the action of  $PSL(2, 8)$  on the cosets of  $D_{18}$  (part (ii) of Proposition 3.1) we get that  $D_{18}$  has three nontrivial suborbits, all of which are self-paired of length 9. Graphs arising from these suborbits are all isomorphic to the graph  $X_1$  given in Table 2 (see also Figure 8).

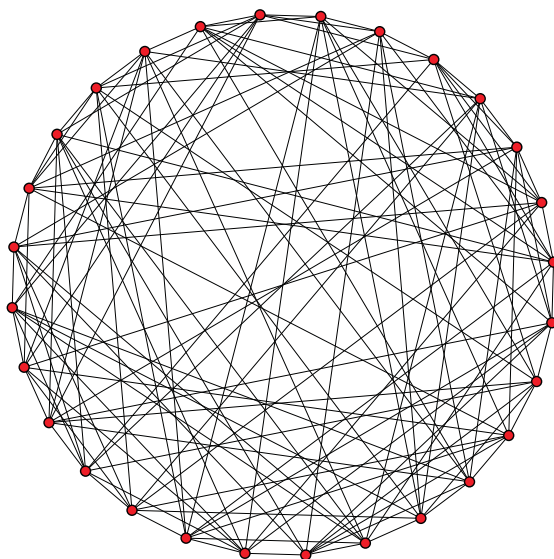

Figure 8: The vertex-transitive graph on 28 vertices with primitive automorphism group of valency 9, arising from the action of the group  $PSL(2, 8)$  on the cosets of a subgroup  $D_{18}$ .

For the action of  $PGL(2, 7)$  on the cosets of  $D_{12}$  (part (iii) of Proposition 3.1) we deduce that  $D_{12}$  has four nontrivial suborbits (all self-paired) one of which is of length 3, two of length 6 and one of length 12. The graph arising from the suborbit of length 3 is isomorphic to the Coxeter

graph ( $X_2$  in Table 2). Next,  $X_3$  and  $X_4$  arise from the two suborbits of length 6. One of the graphs arising from the union of the suborbit of length 3 and a suborbit of length 6 is isomorphic to the graph  $X_5$  and the other one to the graph  $X_6$  in Table 2. As for the graph associated with the suborbit of length 12, it is clearly hamiltonian by Proposition 2.1.

The action of  $PSL(2, 16) \leq G \leq P\Gamma L(2, 16)$  on cosets of  $N_G(PGL(2, 4))$  (part (iv) of Proposition 3.1), we deduce that  $N_G(PGL(2, 4))$  has four nontrivial suborbits, all of which are self-paired, one of length 12, one of length 15 and two of length 20. The corresponding graphs are, respectively,  $X_7$ ,  $X_8$  and  $X_9$  in Table 2.

As for the action of  $PSL(3, 3) \leq G \leq PGL(3, 3)$  on the 52 incident point-line pairs of  $PG(2, 3)$  (part (v) of Proposition 3.1), we deduce that there are five nontrivial suborbits, two of which are non-self-paired of length 9, and three are self-paired of lengths 3, 3 and 27. The graph arising from the union of the two non-self-paired suborbits has valency 18 and is hamiltonian by Proposition 2.1, as is for the same reason the graph associated with the suborbit of length 27. The graphs arising from the suborbits of length 3 are both disconnected. Their union is isomorphic to the graph  $X_{10}$  in Table 2 (see also Figure 9).

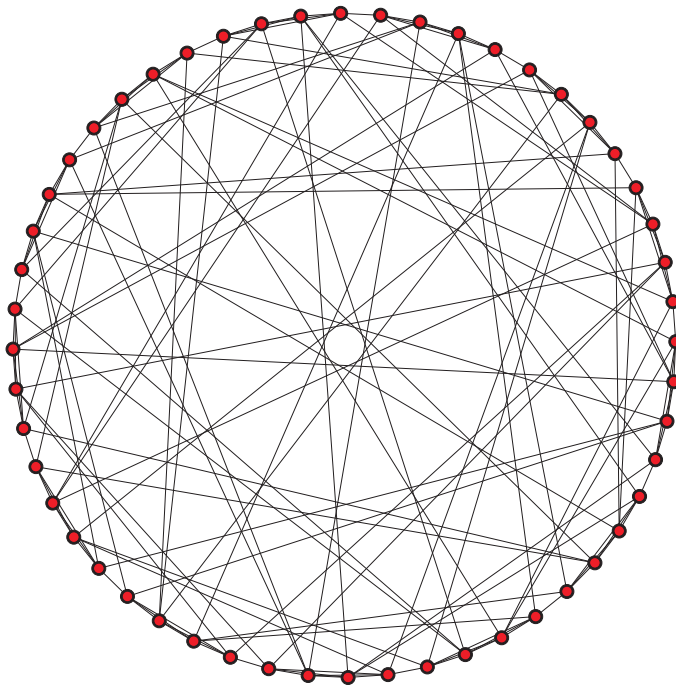

Figure 9: The vertex-transitive graph on 52 vertices with primitive automorphism group of valency 6, arising from the action of the group  $PSL(3, 3) \leq G \leq PGL(3, 3)$  acting on the  $52 = 4p$  incident point-line pairs of  $PG(2, 3)$ .

## References

- [1] B. Alspach, Hamiltonian cycles in vertex-transitive graphs of order  $2p$ , Proceedings of the Tenth Southeastern Conference on Combinatorics, Graph Theory and Computing (Florida Atlantic Univ., Boca Raton, Fla., 1979), pp. 131–139, *Congress. Numer.*, XXIII–XX, Utilitas Math., Winnipeg, Man., 1979.
- [2] B. Alspach, Lifting Hamilton cycles of quotient graphs, *Discrete Math.* **78** (1989), 25–36.

- [3] B. Alspach and C. Q. Zhang, Hamilton cycles in cubic Cayley graphs on dihedral groups, *Ars Combin.* **28** (1989), 101–108.
- [4] B. Alspach, S. Locke and D. Witte, The Hamilton spaces of Cayley graphs on abelian groups, *Discrete Math.* **82** (1990), 113–126.
- [5] B. Alspach and Y. S. Qin, Hamilton-Connected Cayley graphs on Hamiltonian groups, *Europ. J. Combin.* **22** (2001), 777–787.
- [6] N. Biggs, Three remarkable graphs, *Can. J. Math.* **25** (1973), 397–411.
- [7] W. Bosma, J. Cannon, and C. Playoust, The MAGMA Algebra System I: The User Language, *J. Symbolic Comput.* **24** (1997), 235–265.
- [8] P. J. Cameron, Finite permutation groups and finite simple groups, *Bull. London Math. Soc.* **13** (1981), 1–22.
- [9] M. Cherkassof and D. Sjerve, On groups generated by three involutions, two of which commute, The Hilton Symposium (Montreal, 1993) pp. 169–185. *CRM Proc. Lecture Notes* **6**, Amer. Math. Soc., Providence, 1994.
- [10] Y. Q. Chen, On Hamiltonicity of vertex-transitive graphs and digraphs of order  $p^4$ , *J. Combin. Theory Ser. B* **72** (1998), 110–121.
- [11] C. C. Chen and N. F. Quimpo, “On strongly hamiltonian abelian group graphs”, in Combinatorial Mathematics VIII, ed. K. L. McAvaney, Lecture Notes in Mathematics, Vol. 884, Springer-Verlag, Berlin (1981), 23–34.
- [12] S. Curran and J. A. Gallian, Hamiltonian cycles and paths in Cayley graphs and digraphs—a survey, *Discrete Math.* **156** (1996), 1–18.
- [13] J. D. Dixon and B. Mortimer, “Permutation Groups”, GTM 163, Springer-Verlag, New York, 1996.
- [14] E. Dobson, H. Gavlas, J. Morris and D. Witte, Automorphism groups with cyclic commutator subgroup and Hamilton cycles, *Discrete Math.* **189** (1998), 69–78.
- [15] E. Durnberger, Connected Cayley graphs of semi-direct products of cyclic groups of prime order by abelian groups are hamiltonian, *Discrete Math.* **46** (1983), 55–68.
- [16] H. H. Glover and T. Y. Yang, A Hamilton cycle in the Cayley graph of the  $(2, p, 3)$ -presentation of  $PSL_2(p)$ , *Discrete Math.* **160** (1996), 149–163.
- [17] R. Frucht, How to describe a graph, *Ann. N. Y. Acad. Sci.* **175** (1970), 159–167.
- [18] R. Frucht, A canonical representation of trivalent Hamiltonian graphs, *J. Graph Theory* **1** (1977), 45–60.
- [19] B. Jackson, Hamiltonian cycles in regular graphs, *J. Graph Theory* **2** (1978), 363–365.
- [20] H. L. Li, J. Wang, L. Y. Wang and M. Y. Xu, Vertex primitive graphs of order containing a large prime factor, *Comm. Algebra*, **22** (1994), 3449–3477.
- [21] M.W.Liebeck and J.Saxl, Primitive permutation groups containing an element of large prime order, *J. London Math. Soc.* (2) **31** (1985), 237–249.
- [22] L. Lovász, “Combinatorial structures and their applications”, (Proc. Calgary Internat. Conf., Calgary, Alberta, 1969), pp. 243–246, Problem 11, Gordon and Breach, New York, 1970.
- [23] K. Keating and D. Witte, On Hamilton cycles in Cayley graphs in groups with cyclic commutator subgroup. Cycles in graphs (Burnaby, B.C., 1982), 89–102, *Ann. Discrete Math.* **27**, North-Holland, Amsterdam, 1985.
- [24] B. D.McKay, The transitive graphs with fewer than twenty vertices, *Math. Comp.*, **33** (1979), 1101–1121 & microfiche supplement.
- [25] B. D.McKay, G.F.Royle, The transitive graphs with at most 26 vertices, *Ars. Combin.*, **30** (1990), 161–176.



- [26] D. Marušič, On vertex symmetric digraphs. *Discrete Math.* **36** (1981), 69–81.
- [27] D. Marušič and T. D. Parsons, Hamiltonian paths in vertex-symmetric graphs of order  $5p$ , *Discrete Math.* **42** (1982), 227–242.
- [28] D. Marušič and T. D. Parsons, Hamiltonian paths in vertex-symmetric graphs of order  $4p$ , *Discrete Math.* **43** (1983), 91–96.
- [29] D. Marušič, Hamiltonian circuits in Cayley graphs, *Discrete Math.* **46** (1983), 49–54.
- [30] D. Marušič, Vertex transitive graphs and digraphs of order  $p^k$ . Cycles in graphs (Burnaby, B.C., 1982), 115–128, *Ann. Discrete Math.* **27**, North-Holland, Amsterdam, 1985.
- [31] D. Marušič, Hamiltonian cycles in vertex symmetric graphs of order  $2p^2$ , *Discrete Math.* **66** (1987), 169–174.
- [32] D. Marušič, On vertex-transitive graphs of order  $qp$ , *J. Combin. Math. Combin. Comput.* **4** (1988), 97–114.
- [33] D. Marušič, R. Scapellato and B. Zgrablić, On quasiprimitive  $pqr$ -graphs, *Algebra Colloq.* **4** (1995), 295–314.
- [34] D. Passman, “Permutation groups”, W. A. Benjamin Inc., New York, 1968.
- [35] J. Turner, Point-symmetric graphs with a prime number of points, *J. Combin. Theory* **3** (1967), 136–145.
- [36] H. Wielandt, *Finite Permutation Groups*, Academic Press, New York, 1964.
- [37] D. Witte, On Hamiltonian circuits in Cayley diagrams, *Discrete Math.* **38** (1982), 99–108.
- [38] D. Witte, On Hamilton cycles in Cayley graphs in groups with cyclic commutator subgroup, *Discrete Math.* **27** (1985), 89–102.
- [39] D. Witte, Cayley digraphs of prime-power order are Hamiltonian. *J. Combin. Theory Ser. B* **40** (1986), 107–112.