

MODULI SPACES OF LOCAL SYSTEMS AND HIGHER TEICHMÜLLER THEORY.

by VLADIMIR FOCK *and* ALEXANDER GONCHAROV

CONTENTS

1. Introduction	1
2. The moduli spaces $\mathcal{A}_{G,\hat{S}}$ and $\mathcal{X}_{G,\hat{S}}$	35
3. Surfaces, graphs, mapping class groups and groupoids	45
4. Elements of positive algebraic geometry	53
5. Positive configurations of flags	58
6. A positive structure on the moduli space $\mathcal{X}_{G,\hat{S}}$	75
7. Higher Teichmüller spaces and their basic properties	93
8. A positive structure on the moduli space $\mathcal{A}_{G,\hat{S}}$	114
9. Special coordinates on the \mathcal{A} and \mathcal{X} spaces when G is of type A_m	129
10. The pair $(\mathcal{X}_{PGL_m,\hat{S}}, \mathcal{A}_{SL_m,\hat{S}})$ corresponds to an orbi-cluster ensemble	153
11. The classical Teichmüller spaces	165
12. Laminations and canonical pairings	169
13. Completions of Teichmüller spaces and canonical bases	197
14. Positive coordinate systems for \mathcal{X} -laminations	203
15. A Weil–Petersson form on $\mathcal{A}_{G,\hat{S}}$ and its motivic avatar	207

ABSTRACT

Let G be a split semisimple algebraic group over \mathbf{Q} with trivial center. Let S be a compact oriented surface, with or without boundary. We define *positive* representations of the fundamental group of S to $G(\mathbf{R})$, construct explicitly all positive representations, and prove that they are faithful, discrete, and positive hyperbolic; the moduli space of positive representations is a topologically trivial open domain in the space of all representations. When S have holes, we defined two moduli spaces closely related to the moduli spaces of G -local systems on S . We show that they carry a lot of interesting structures. In particular we define a distinguished collection of coordinate systems, equivariant under the action of the mapping class group of S . We prove that their transition functions are subtraction free. Thus we have positive structures on these moduli spaces. Therefore we can take their points with values in any positive semifield. Their positive real points provide the two higher Teichmüller spaces related to G and S , while the points with values in the tropical semifields provide the lamination spaces. We define the motivic avatar of the Weil-Petersson form for one of these spaces. It is related to the motivic dilogarithm.

1. Introduction

Summary. Let S be a compact oriented surface with $\chi(S) < 0$, with or without boundary. We define *positive* representations of $\pi_1(S)$ to a split semi-simple real Lie group $G(\mathbf{R})$ with trivial center, construct explicitly all positive representations, and prove that they have the following properties: Every positive representation is faithful, its image in $G(\mathbf{R})$ is discrete, and

the image of any non-trivial non-boundary conjugacy class is positive hyperbolic; the moduli space $\mathcal{L}_{G,S}^+$ of positive representations is a topologically trivial domain of dimension $-\chi(S)\dim G$. When $G = PGL_2$ we recover the classical Teichmüller space for S . Using total positivity in semi-simple Lie groups [L1], we introduce and study *positive configurations of flags*, which play a key role in our story. The limit sets of positive representations are positive curves in the real flag variety related to G .

When S has holes, in addition to the Teichmüller space $\mathcal{L}_{G,S}^+$ we define a closely related pair of dual Teichmüller spaces $\mathcal{X}_{G,S}^+$ and $\mathcal{A}_{G,S}^+$. In order to do this, we introduce a *dual pair of moduli spaces* $\mathcal{X}_{G,S}$ and $\mathcal{A}_{G,S}$ closely related to the moduli space $\mathcal{L}_{G,S}$ of $G(\mathbf{C})$ -local systems on S . We show that, unlike the latter, each of them is rational. Moreover, each of them carries a positive atlas, equivariant with respect to the action of the mapping class group of S . Thus we can define the sets of their $\mathbf{R}_{>0}$ -points, which are nothing else but the above dual pair of Teichmüller spaces. We identify each of them with $\mathbf{R}^{-\chi(S)\dim G}$. The sets of their tropical points provide us with a dual pair of lamination spaces – for $G = PGL_2$ we recover Thurston’s laminations. The moduli space $\mathcal{X}_{G,S}$ is Poisson. The space $\mathcal{A}_{G,S}$ carries a degenerate 2-form Ω . It comes from a class in the K_2 -group of the function field of $\mathcal{A}_{G,S}$.

The Teichmüller spaces are related as follows. One has a canonical projection $\pi^+ : \mathcal{X}_{G,S}^+ \rightarrow \mathcal{L}_{G,S}^+$ as well as its canonical splitting $s : \mathcal{L}_{G,S}^+ \hookrightarrow \mathcal{X}_{G,S}^+$. The projection π^+ is a ramified covering with the structure group W^n , where W is the Weyl group of G . There is a map $\mathcal{A}_{G,S}^+ \rightarrow \mathcal{X}_{G,S}^+$, provided by taking the quotient along the null foliation of Ω . We show that higher Teichmüller spaces behave nicely with respect to cutting and gluing of S . We define a (partial) completion of the higher Teichmüller spaces, which for $G = PGL_2$ coincides with the Weil-Petersson completion of the classical Teichmüller space.

We conjecture that there is a duality between the \mathcal{X} - and \mathcal{A} -moduli spaces, which interchanges G with its Langlands dual. In particular, it predicts that there exists a canonical basis in the space of functions on one of the moduli space, parametrised by the integral tropical points of the other, with a number of remarkable properties. We construct such a basis for $G = PGL_2$. The pair $(\mathcal{X}_{G,S}, \mathcal{A}_{G,S})$, at least for $G = PGL_m$, forms an (orbi)-cluster ensemble in the sense of [FG2], and thus can be quantised, as explained in loc. cit..

1 An algebraic-geometric approach to higher Teichmüller theory. Let S be a compact oriented surface with $n \geq 0$ holes. The Teichmüller space \mathcal{T}_S is the moduli space of complex structures on S modulo diffeomorphisms isotopic to the identity. We will assume that S is hyperbolic. Then

the Poincaré uniformisation theorem identifies \mathcal{T}_S with the space of all faithful representations $\pi_1(S) \rightarrow PSL_2(\mathbf{R})$ with discrete image, modulo conjugations by $PSL_2(\mathbf{R})$. The canonical metric on the hyperbolic plane descends to a complete hyperbolic metrics of curvature -1 on S . The space \mathcal{T}_S is the moduli space of such metrics on S modulo isomorphism. .

If $n > 0$, the space \mathcal{T}_S has a boundary; in fact it is a manifold with corners. Let us explain why. Given a point $p \in \mathcal{T}_S$, a boundary component of S is *cuspidal* if its neighborhood is isometric to a cusp. The points of the boundary of \mathcal{T}_S parametrise the metrics on S with at least one cuspidal boundary component. There is a natural $2^n : 1$ cover $\pi^+ : \mathcal{T}_S^+ \rightarrow \mathcal{T}_S$, ramified at the boundary of \mathcal{T}_S . It is described as follows. For each non-cuspidal boundary component of S there is a unique geodesic homotopic to it. The space \mathcal{T}_S^+ parametrises pairs $(p \in \mathcal{T}_S, \text{ plus a choice of orientation of every non-cuspidal boundary component})$. The orientation of S provides orientations of all boundary components and hence orientations of the corresponding geodesics. Thus we get a canonical embedding $s : \mathcal{T}_S \hookrightarrow \mathcal{T}_S^+$. Let $\mathcal{T}_S^u \subset \mathcal{T}_S$ be the subspace parametrising the metrics all of whose boundary components are cuspidal. It is the deepest corner of \mathcal{T}_S . Its quotient $\mathcal{M}_S := \mathcal{T}_S^u / \Gamma_S$ by the mapping class group $\Gamma_S := \text{Diff}(S) / \text{Diff}_0(S)$ is the classical moduli space $\mathcal{M}_{g,n}$. In particular it has a complex structure.

The Teichmüller space is by no means the set of real points of an algebraic variety. Indeed, discreteness is not a condition of an algebraic nature. Traditionally the Teichmüller theory is considered as a part of analysis and geometry. In this paper we show that there is an algebraic-geometric approach to the Teichmüller theory. Moreover, we show that it admits a generalization where PSL_2 is replaced by a split semi-simple algebraic group G over \mathbf{Q} with trivial center. Our approach owes a lot to Thurston's ideas in geometry of surfaces. So perhaps the emerging theory could be called higher Teichmüller-Thurston theory. Here are the main features of our story.

Let G be a split reductive algebraic group over \mathbf{Q} . Let \widehat{S} be a pair consisting of a compact oriented surface S with n holes and a finite (possibly empty) collection of marked points on the boundary considered modulo isotopy. We define two new moduli spaces, denoted $\mathcal{X}_{G,\widehat{S}}$ and $\mathcal{A}_{G,\widehat{S}}$. *We always assume that G has trivial center (resp. is simply-connected) for the \mathcal{X} - (resp. \mathcal{A} -) moduli space.* In particular, when \widehat{S} is a disk with marked points on the boundary we get moduli spaces of cyclically ordered configurations of points in the flag variety $\mathcal{B} := G/B$ and twisted cyclic configurations of points of the principal affine variety $\mathcal{A} := G/U$.

We show that if S does have holes then these moduli spaces carry interesting additional structures. In particular, for each of them we define a distinguished collection of coordinate systems, equivariant under the action of the mapping class group of S . We prove that their transition functions are subtraction-free, providing a *positive atlas* on the corresponding moduli space.

We say that X is a *positive variety* if it admits a positive atlas, i.e. a distinguished collection of coordinate systems as above. If X is a positive variety, we can take points of X with values in any *semifield*, i.e. a set equipped with operations of addition, multiplication and division, e.g. $\mathbf{R}_{>0}$. We define *higher Teichmüller spaces* $\mathcal{X}_{G,\widehat{S}}^+$ and $\mathcal{A}_{G,\widehat{S}}^+$ as the sets of $\mathbf{R}_{>0}$ -points of the corresponding positive spaces $\mathcal{X}_{G,\widehat{S}}$ and $\mathcal{A}_{G,\widehat{S}}$. Precisely, they consist of the real points of the corresponding moduli spaces whose coordinates in one, and hence in any, of the constructed coordinate systems are positive. Our approach for general G uses George Lusztig's theory of positivity in semi-simple Lie groups [L1]-[L2]. For $G = SL_m$ we have an elementary and self-contained approach developed in Sections 9-10.

We prove that the representations $\pi_1(S) \rightarrow G(\mathbf{R})$ underlying the points of $\mathcal{X}_{G,\widehat{S}}^+$ are faithful, discrete and positive hyperbolic. Using positive configurations of flags, we define positive representations of $\pi_1(S)$ for closed surfaces S , and show that they have the same properties. For $G = PSL_2(\mathbf{R})$ we recover the Fuchsian representations. If S is closed, a component in the moduli space of completely reducible $G(\mathbf{R})$ -local system was defined and studied by Nigel Hitchin [H1] by a completely different method. A partial generalization to punctured S see in [BAG]. We explain the relationship between our work and the work of Hitchin in Section 1.11.

The classical Teichmüller spaces appear as follows. We show that in the absence of marked points, i.e. when $S = \widehat{S}$, the space $\mathcal{X}_{PGL_2,S}^+$ is identified with the Teichmüller space \mathcal{T}_S^+ , and $\mathcal{A}_{SL_2,S}^+$ is identified with the decorated Teichmüller space \mathcal{T}_S^d defined by Robert Penner [P1]. The restrictions of our canonical coordinates to the corresponding Teichmüller spaces are well known coordinates there. Our two moduli spaces, their positivity, and especially the discussed below motivic data seem to be new even in the classical setting.

It makes sense to consider points of our moduli spaces with values in an arbitrary semifield. An interesting situation appears when we consider exotic *tropical* semifields \mathbf{A}^t . Let us recall their definition. Let \mathbf{A} be one of the three sets \mathbf{Z} , \mathbf{Q} , \mathbf{R} . Replacing the operations of multiplication, division and addition in \mathbf{A} by the operations of addition, subtraction and taking the max-

imum we obtain the tropical semifield \mathbf{A}^t . We show that the set of points of the moduli space $\mathcal{A}_{SL_2, S}$ with values in the tropical semifield \mathbf{R}^t is identified with Thurston's transversal measured laminations on S [Th]. The \mathbf{Q}^t - and \mathbf{Z}^t -points of $\mathcal{A}_{SL_2, S}$ give us rational and integral laminations. Now taking the points of the other moduli spaces with values in tropical semifields, we get generalizations of the lamination spaces. We show that for any positive variety X the projectivisation of the space $X(\mathbf{R}^t)$ serves as the Thurston-type boundary for the space $X^+ := X(\mathbf{R}_{>0})$.

We suggest that there exists a remarkable duality between the \mathcal{A} -moduli space for the group G and the \mathcal{X} -moduli space for the Langlands dual group ${}^L G$. Here is one of the (conjectural) manifestations of this duality. Let X be a positive variety. A rational function F on X is called a *good positive Laurent polynomial* if it is a Laurent polynomial with positive integral coefficients in every coordinate system of the positive atlas on X . We conjecture that the set of \mathbf{Z}^t -points of the \mathcal{A}/\mathcal{X} -moduli space for G should parametrize a canonical basis in the space of all good positive Laurent polynomials on the \mathcal{X}/\mathcal{A} -moduli space for the Langlands dual group ${}^L G$, for the positive atlases we defined. For $G = SL_2$ or PGL_2 we elaborate this theme in Section 12.

If S has no holes, the moduli space $\mathcal{L}_{G, S}$ has a natural symplectic structure. If $n > 0$, the symplectic structure is no longer available, and the story splits into two different directions. First, the moduli space $\mathcal{L}_{G, S}$ has a natural Poisson structure, studied in [FR]. There is a natural Poisson structure on the moduli space $\mathcal{X}_{G, \hat{S}}$ such that the canonical projection $\pi : \mathcal{X}_{G, \hat{S}} \rightarrow \mathcal{L}_{G, \hat{S}}$ is Poisson. Second, we introduce a degenerate symplectic structure on the moduli space $\mathcal{A}_{G, \hat{S}}$, an analog of the Weil-Petersson form. To define the Weil-Petersson form we construct its K_2 -avatar, that is a class in K_2 whose image under the regulator map gives the 2-form. We show that it admits an even finer motivic avatar related to the motivic dilogarithm and the second motivic Chern class $c_2^{\mathcal{M}}$ of the universal G -bundle on BG .

Amazingly an explicit construction of a cocycle for the class $c_2^{\mathcal{M}}$ for $G = SL_m$ given in [G3] delivers the canonical coordinates on the $\mathcal{A}_{SL_m, \hat{S}}$ -space. Namely, in Section 15 we give a simple general construction which translates a class $c_2^{\mathcal{M}}$ to a class in K_2 of $\mathcal{A}_{G, \hat{S}}$. Applying it to the explicit cocycle defined in [G3], we get a class in K_2 of $\mathcal{A}_{SL_m, \hat{S}}$, which shows up written in the canonical coordinates! This construction was our starting point.

The Poisson structure and the Weil-Petersson form are compatible in a natural way: the quotient of the \mathcal{A} -space along the null foliation of the Weil-Petersson form is embedded into the \mathcal{X} -space as a symplectic leaf of the

Poisson structure. The representations of $\pi_1(S)$ corresponding to its points are the ones with unipotent monodromies around each hole.

Recall an embedding $SL_2 \hookrightarrow G$, as a principal SL_2 -subgroup, well-defined up to a conjugation. It leads to embeddings (G' denotes the adjoint group) $\mathcal{A}_{SL_2,S} \hookrightarrow \mathcal{A}_{G,S}$, $\mathcal{X}_{PGL_2,S} \hookrightarrow \mathcal{X}_{G',S}$ and their counterparts for the Teichmüller and lamination spaces.

Summarizing, we suggest that for a surface S with boundary

The pair of moduli spaces $(\mathcal{A}_{G,\hat{S}}, \mathcal{X}_{G',\hat{S}})$ is the algebraic-geometric avatar of higher Teichmüller theory.

After the key properties of the $(\mathcal{X}, \mathcal{A})$ -moduli spaces were discovered and worked out, we started to look for an adequate framework describing their structures. It seems that it is provided by the object which we call an *(orbi)-cluster ensemble* and develop in [FG2]. It generalizes the *cluster algebras*, discovered and studied in a remarkable series of papers by S. Fomin and A. Zelevinsky [FZI], [FZII], [FZ3]. A cluster ensemble is a pair of positive spaces $\mathcal{X}_{\mathcal{E}}$ and $\mathcal{A}_{\mathcal{E}}$ defined for any integral-valued skew-symmetrizable function \mathcal{E} on the square of a finite set. The cluster algebra closely related to the positive space $\mathcal{A}_{\mathcal{E}}$. The orbi-cluster ensemble is a bit more general structure.

For any G there exists an orbi-cluster ensemble $(\mathcal{A}_{\mathcal{E}(G,\hat{S})}, \mathcal{X}_{\mathcal{E}(G,\hat{S})})$ related to the pair of moduli spaces $(\mathcal{A}_{G,\hat{S}}, \mathcal{X}_{G,\hat{S}})$. For $G = SL_2$ the corresponding pairs of positive spaces coincide. For other G 's the precise relationship between them is more complicated. In Section 10 we explain this for $G = SL_m$. A more technical general case is treated in a sequel to this paper. The fact that Penner's decorated Teichmüller space is related to a cluster algebra was independently observed in [GSV2].

The relationship between the higher Teichmüller theory and cluster ensembles is very fruitful in both directions. We show in [FG2] that cluster ensembles have essentially all properties of the two moduli spaces described above, including the relation with the motivic dilogarithm. Our point is that

A big part of the higher Teichmüller theory can be generalized in the framework of cluster ensembles, providing a guide for investigation of the latter.

For example, we suggest in Section 4 loc. cit. that there exists a duality between the $\mathcal{X}_{\mathcal{E}}$ and $\mathcal{A}_{\mathcal{E}}$ spaces, which in the special case of our pair of moduli spaces includes the one discussed above. This duality should also include the canonical bases of Lusztig and the Laurent phenomenon of Fomin and Zelevinsky [FZ3] as special cases.

We show in [FG2] that any cluster ensemble can be quantized. In a sequel to this paper we apply this to quantize the moduli space $\mathcal{X}_{G,\widehat{S}}$. The quantization is given by means of the quantum dilogarithm. Remarkably the quantization is governed by the motivic avatar of the Weil-Petersson form on the $\mathcal{A}_{G,\widehat{S}}$ moduli space.

The rest of the Introduction contains a more detailed discussion of main definitions and results.

2. The two moduli spaces. Let $S = \overline{S} - D_1 \cup \dots \cup D_n$, where \overline{S} is a compact oriented two-dimensional manifold without boundary of genus g , and D_1, \dots, D_n are non intersecting open disks. The boundary ∂S of S is a disjoint union of circles.

1.1. Definition. — *A marked surface \widehat{S} is a pair $(S, \{x_1, \dots, x_k\})$, where S is a compact oriented surface and $\{x_1, \dots, x_k\}$ is a finite (perhaps empty) set of distinct boundary points, considered up to an isotopy.*

We have $\widehat{S} = S$ if there are no boundary points. Let us define the *punctured boundary* $\partial\widehat{S}$ of \widehat{S} by $\partial\widehat{S} := \partial S - \{x_1, \dots, x_k\}$. It is a union of circles and (open) intervals. Let N be the number of all connected components of $\partial\widehat{S}$. We say that a marked surface \widehat{S} is *hyperbolic* if $g > 1$, or $g = 1, N > 0$, or $g = 0, N \geq 3$. We will usually assume that \widehat{S} is hyperbolic, and $N > 0$.

Let H be a group. Recall that an H -local system is a principle H -bundle with a flat connection. There is a well known bijection between the homomorphisms of the fundamental group $\pi_1(X, x)$ to H modulo H -conjugation, and the isomorphism classes of H -local systems on a nice topological space X . It associates to a local system its monodromy representation.

Let G be a split reductive algebraic group over \mathbf{Q} . Then $\mathcal{L}_{G,S}$ is the moduli space of G -local systems on S . It is an algebraic stack over \mathbf{Q} , and its generic part is an algebraic variety over \mathbf{Q} . We introduce two other moduli spaces, denoted $\mathcal{A}_{G,\widehat{S}}$ and $\mathcal{X}_{G,\widehat{S}}$, closely related to $\mathcal{L}_{G,S}$. They are also algebraic stacks over \mathbf{Q} .

The flag variety \mathcal{B} parametrizes Borel subgroups in G . Let B be a Borel subgroup. Then $\mathcal{B} = G/B$. Further, $U := [B, B]$ is a maximal unipotent subgroup in G .

Let \mathcal{L} be a G -local system on S . We assume that G acts on \mathcal{L} from the right. We define the associated *flag bundle* \mathcal{L}_B and *principal affine bundle* \mathcal{L}_A by setting

$$\mathcal{L}_B := \mathcal{L} \times_G \mathcal{B} = \mathcal{L}/B; \quad \mathcal{L}_A := \mathcal{L}/U. \quad (1.1)$$

1.2. Definition. — Let G be a split reductive group. A framed G -local system on \widehat{S} is a pair (\mathcal{L}, β) , where \mathcal{L} is a G -local system on S , and β a flat section of the restriction of $\mathcal{L}_{\mathcal{B}}$ to the punctured boundary $\partial\widehat{S}$. The space $\mathcal{X}_{G, \widehat{S}}$ is the moduli space of framed G -local systems on \widehat{S} .

Assume now that G is simply-connected. The maximal length element w_0 of the Weyl group of G has a natural lift to G , denoted \overline{w}_0 . Set $s_G := \overline{w}_0^2$. Then one shows that s_G is in the center of G and $s_G^2 = e$. In particular $s_G = e$ if the order of the center of G is odd, i.e. G is of type $A_{2k}, E_6, E_8, F_4, G_2$. If $s_G \neq e$, e.g. $G = SL_{2k}$, the definition of the moduli space $\mathcal{A}_{G, \widehat{S}}$ is more subtle. So in the Introduction we do not consider this case.

1.3. Definition. — Let G be a simply-connected split semi-simple algebraic group, and $s_G = e$. A decorated G -local system on \widehat{S} is a pair (\mathcal{L}, α) , where \mathcal{L} is a G -local system on S , and α a flat section of the restriction of $\mathcal{L}_{\mathcal{A}}$ to $\partial\widehat{S}$. The space $\mathcal{A}_{G, \widehat{S}}$ is the moduli space of decorated G -local systems on \widehat{S} .

Let X be a G -set. The elements of $G \backslash X^n$ are called *configurations* of n elements in X . The coinvariants of the cyclic translation are called *cyclic configurations* of n elements in X .

Example. Let \widehat{S} be a disk with $k \geq 3$ boundary points, so \mathcal{L} is a trivial G -local system. Then $\mathcal{X}_{G, \widehat{S}}$ is identified with the cyclic configuration space of k flags in G , that is coinvariants of the cyclic shift on $G \backslash \mathcal{B}^k$. Indeed, choosing a trivialization of \mathcal{L} , we identify its fibers with G . Then the section β over the punctured boundary of the disk determines a cyclically ordered collection of flags. A change of the trivialization amounts to a left diagonal action of G . So a cyclic configuration of k flags is well defined. It determines the isomorphism class of the framed G -local system on the marked disk. Similarly, assuming $s_G = e$, the space $\mathcal{A}_{G, \widehat{S}}$ is identified with the cyclic configuration space of k points in the principal affine space $\mathcal{A} := G/U$.

Forgetting β we get a canonical projection

$$\pi : \mathcal{X}_{G, \widehat{S}} \longrightarrow \mathcal{L}_{G, S}.$$

If $\widehat{S} = S$, it is a finite map at the generic point of degree $|W|^n$, where W is the Weyl group of G .

We show that the moduli spaces $\mathcal{X}_{G, \widehat{S}}$ and $\mathcal{A}_{G, \widehat{S}}$ have some interesting additional structures.

3. The Farey set, configurations of flags, and framed local systems on \widehat{S} . A *cyclic structure* on a set C is defined so that every point of the set provides an order of C , and the orders corresponding to different points are related in the obvious way. A *cyclic set* is a set with a cyclic structure. An example is given by any subset of the oriented circle.

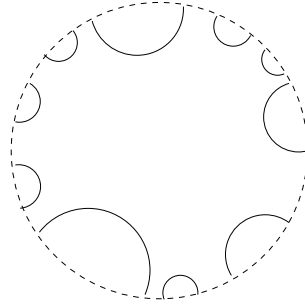

FIG. 1.1. — The Farey set: a cyclic $\pi_1(S)$ -set $\mathcal{F}_\infty(S)$.

The Farey set of S . It is a cyclic $\pi_1(S)$ -set assigned to a topological surface S . Let us give three slightly different versions of its definition.

(i) Shrinking holes on S to punctures, we get a homotopy equivalent surface S' . The universal cover of S' is an open disc. The punctures on S' give rise to a countable subset on the boundary of this disc. This subset inherits a cyclic structure from the boundary of the disc. The group $\pi_1(S)$ acts on it by the deck transformations. The obtained cyclic $\pi_1(S)$ -set is called the *Farey set* and denoted by $\mathcal{F}_\infty(S)$. Choosing a complete hyperbolic structure on S , we identify the Farey set with a subset of the boundary of the hyperbolic plane (the latter is called the absolute).

(ii) An *ideal triangulation* T of S' is a triangulation of S' with vertices at the punctures. Let us lift an ideal triangulation T on S' to the universal cover \mathcal{H} of S' . The obtained triangulation \widetilde{T} of the hyperbolic plane \mathcal{H} is identified with the Farey triangulation, see Figure 1.2. The set of vertices of \widetilde{T} inherits a cyclic structure from the absolute of \mathcal{H} . The obtained cyclic $\pi_1(S)$ -set does not depend on the choice of a triangulation T , and is canonically isomorphic to the Farey set $\mathcal{F}_\infty(S)$.

(iii) Here is a definition of the Farey set via the surface S . Choose a hyperbolic structure with geodesic boundary on S . Its universal cover is identified with the hyperbolic plane with an infinite number of geodesic half discs removed, see Figure 1.1. The set $\mathcal{F}_\infty(S)$ is identified with the set of these removed geodesic half discs. The latter has an obvious cyclic $\pi_1(S)$ -set

structure, see Figure 1.1, which does not depend on the choice of a hyperbolic structure on S .

The Farey set of a marked surface \widehat{S} with boundary. Choose a hyperbolic structure with geodesic boundary on S . Then the set $\mathcal{F}_\infty(\widehat{S})$ is the preimage of the punctured boundary $\partial\widehat{S}$ on the universal cover. It has an obvious cyclic $\pi_1(S)$ -set structure, which does not depend on the choice of a hyperbolic structure on S .

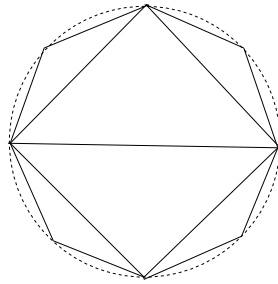

FIG. 1.2. — The Farey triangulation of the hyperbolic disc.

A framed local system on \widehat{S} gives rise to a map

$$\beta_\rho : \mathcal{F}_\infty(\widehat{S}) \longrightarrow \mathcal{B}(\mathbf{C}) \quad \text{modulo the action of } G(\mathbf{C}), \quad (1.2)$$

which is equivariant with respect to the action of the group $\pi_1(S)$: the latter acts on the flag variety via the monodromy representation ρ of the local system. The following Lemma is straitforward.

1.1. Lemma. — *There is a natural bijection between the framed $G(\mathbf{C})$ -local systems on \widehat{S} and ρ -equivariant maps (1.2), where where $\rho : \pi_1(S) \rightarrow G(\mathbf{C})$ is a representation, modulo $G(\mathbf{C})$ -conjugation.*

A similar interpretation of the moduli space $\mathcal{A}_{G, \widehat{S}}$ is given in Section 8.6.

Here is a reformulation of this Lemma, which will serve us below.

Configurations. Let C be a set, G a group, and X a set. Then we define the set

$$\text{Conf}_C(X) := \text{Map}(C, X)/G$$

of configurations of points in X parametrised by the set C , where the action of G on $\text{Map}(C, X)$ is induced by the one on X . In particular if $C = \{1, \dots, n\}$, we denote by $\text{Conf}_n(X)$ the corresponding configuration space of n points in X .

Let π be a group acting on C . Then it acts on $\text{Conf}_C(X)$. So there is a set of π -equivariant maps

$$\text{Conf}_{C,\pi}(X) = \text{Conf}_C(X)^\pi.$$

Let (ψ, ρ) be a pair consisting of a group homomorphism $\rho : \pi \rightarrow G$, and a (π, ρ) -equivariant map of sets $\psi : C \rightarrow X$, i.e. for any $\gamma \in \pi$ one has $\psi(\gamma c) = \rho(\gamma)\psi(c)$. The group G acts by conjugation on these pairs.

1.2. Lemma. — *Assume that G acts freely on $\text{Map}(C, X)$. Then $\text{Conf}_{C,\pi}(X)$ is identified with the set of pairs (ψ, ρ) , where $\psi : C \rightarrow X$ is a (π, ρ) -equivariant map of sets, modulo G -conjugations.*

Proof. Choose a map $\mu : C \rightarrow X$ representing a configuration m . Then $\mu \circ \gamma^{-1} : C \rightarrow X$ represents the configuration $\gamma(m)$. Since $\gamma(m) = m$, there is an element $g_\gamma \in G$ such that $\mu \circ \gamma^{-1} = g_\gamma \mu$. Since the group G acts on $\text{Map}(C, X)$ freely, g_γ is uniquely defined. So we get a group homomorphism $\rho : \pi \rightarrow G$ given by $\gamma \mapsto g_\gamma$. Changing the representative μ amounts to conjugation. The lemma is proved.

Using this, we can rephrase Lemma 1.1 as the following canonical isomorphism:

$$\mathcal{X}_{G,\widehat{S}}(\mathbf{C}) = \text{Conf}_{\mathcal{F}_\infty(\widehat{S}),\pi_1(S)}(\mathcal{B}(\mathbf{C})). \quad (1.3)$$

This way we define points of the space $\mathcal{X}_{G,\widehat{S}}(\mathbf{C})$ without even mentioning representations of $\pi_1(S)$: they appear thanks to Lemma 1.2.

4. Decomposition Theorem. Let us picture the boundary components of S without marked points as punctures. In the presence of marked points let us choose a single distinguished point on each connected component of the punctured boundary $\partial\widehat{S}$. We define an *ideal triangulation* T of \widehat{S} as a triangulation of S with all vertices at the punctures and distinguished points. Each triangle of this triangulation can be considered as a disc with three marked points. These points are located on the edges of the triangle, one per each edge. The restriction of an element of $\mathcal{X}_{G,\widehat{S}}$ to a triangle t of an ideal triangulation provides a framed G -local system on the marked triangle \widehat{t} . It is an element of $\mathcal{X}_{G,\widehat{t}}$. So we get a projection $p_t : \mathcal{X}_{G,\widehat{S}} \rightarrow \mathcal{X}_{G,\widehat{t}}$. An edge of the triangulation T is called *internal* if it is not on the boundary of S . Given an oriented internal edge e of T we define a rational projection $p_e : \mathcal{X}_{G,\widehat{S}} \rightarrow H$. Let us orient all internal edges of an ideal triangulation. Then the collection of projections p_t and p_e provide us a rational map

$$\pi_T : \mathcal{X}_{G,\widehat{S}} \longrightarrow \prod_{\text{triangles } t \text{ of } T} \mathcal{X}_{G,\widehat{t}} \times H_G^{\{\text{internal edges of } T\}}. \quad (1.4)$$

1.1. Theorem. — *Assume that G has trivial center. Then for any ideal triangulation T of \widehat{S} , the map (1.4) is a birational isomorphism.*

Several different proofs of this theorem are given in Section 6. A similar Decomposition Theorem for the space $\mathcal{A}_{G,\widehat{S}}$ is proved in Section 8, see (8.20).

Example. Let $G = PGL_2$. Then for a triangle \widehat{t} the moduli space $\mathcal{X}_{G,\widehat{t}}$ is a point, and $H = \mathbf{G}_m$. So the Decomposition Theorem in this case states that for any ideal triangulation T of \widehat{S} there is a birational isomorphism

$$\pi_{\mathbf{T}} : \mathcal{X}_{PGL_2,\widehat{S}} \longrightarrow \mathbf{G}_m^{\{\text{internal edges of } T\}}. \quad (1.5)$$

It is defined as follows. Take an internal edge E of the triangulation. Then there are two triangles of the triangulation sharing this edge, which form a rectangle R_E , see Figure 1.3. In this case $\mathcal{L}_{\mathcal{B}}$ is a local system of projective lines. A framing provides a section of this local system over each corner of the rectangle. Since the rectangle is contractible, they give rise to a cyclically ordered configuration of 4 points on \mathbf{P}^1 . The cross-ratio of these 4 points, counted from a point corresponding to a vertex of the edge E , and normalised so that $r(\infty, -1, 0, x) = x$, provides a rational projection $\mathcal{X}_{PGL_2,\widehat{S}} \rightarrow \mathbf{G}_m$ corresponding to the edge E .

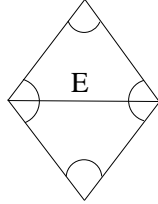

FIG. 1.3. — Defining the edge invariant.

Let us fix the following data in G . Let (B^+, B^-) be a pair of opposite Borel subgroups. Let (U^+, U^-) be the corresponding pair of maximal unipotent subgroups in G . Then $B^+ \cap B^-$ is identified with the Cartan group H . The Cartan group acts on U^\pm by conjugation.

Recall that given a G -set X , a configuration of k elements in X is a G -orbit in X^k . Denote by $\text{Conf}_k(\mathcal{B})$ the configuration space of k -tuples of flags in generic position in G , meaning that any two of them are opposite to each other.

If we choose an order of the vertices of the marked triangle \widehat{t} , then there is a canonical birational isomorphism $\mathcal{X}_{G',\widehat{t}} \xrightarrow{\sim} \text{Conf}_3(\mathcal{B})$. We set $u \cdot B :=$

uBu^{-1} . Then there is a birational isomorphism

$$U^+/H \xrightarrow{\sim} \text{Conf}_3(\mathcal{B}), \quad u_+ \mapsto (B^-, B^+, u_+ \cdot B^-).$$

Since the action of H preserves B^+ and B^- , the formula on the left provides a well defined map from U^+/H . This plus Decomposition Theorem 1.1 implies the following

1.1. Corollary. — *The moduli space $\mathcal{X}_{G', \hat{S}}$ is rational.*

Notice that in contrast with this, in general the classical moduli space $\mathcal{L}_{G, S}$ is by no means rational. In the simplest case when S is the sphere with three points removed, description of $\mathcal{L}_{GL_n, S}$ is equivalent to the classical unsolved problem of classification of pairs of invertible matrices.

To explain how the Decomposition Theorem leads to higher Teichmüller spaces we recall some background on total positivity, and then introduce a key notion of positive configurations of flags.

5. Total positivity, positive configurations of flags and higher Teichmüller spaces. A real matrix is called totally positive if all its minors are positive numbers. An upper triangular matrix is called totally positive if all its minors which are not identically zero are positive. For example

$$\begin{pmatrix} 1 & a & b \\ 0 & 1 & c \\ 0 & 0 & 1 \end{pmatrix} \text{ is totally positive if and only if } a > 0, b > 0, c > 0, ac - b > 0.$$

The theory of totally positive matrices was developed by F.R. Gantmacher and M.G. Krein [GKr], and by I. Schoenberg [Sch], in 1930's. Parametrizations of totally positive unipotent matrices were found by A. Whitney [W]. This theory was generalized to arbitrary semi-simple real Lie groups by Lusztig [L1]. Denote by $U^+(\mathbf{R}_{>0})$ (resp. $H(\mathbf{R}_{>0})$) the subset of all totally positive elements in U^+ (resp. H).

The following definition, followed by Theorem 1.2, is one of the crucial steps in our paper.

1.4. Definition. — *A configuration of flags (B_1, \dots, B_k) is positive if it can be written as*

$$\left(B^+, B^-, u_1 \cdot B^-, u_1 u_2 \cdot U^+, \dots, (u_1 \dots u_{k-2}) \cdot B^- \right). \quad \text{where } u_i \in U^+(\mathbf{R}_{>0}) \quad \mathbf{(1.6)}$$

One can show that two configurations (1.6) are equal if and only if one is obtained from the other by the action of the group $H(\mathbf{R}_{>0})$.

The definition of totally positive matrices is rather non-invariant: it uses matrix elements. Definition 1.4 seems to be even less invariant. However it turns out that the configuration space of positive flags has remarkable and rather non-trivial properties. Let us denote by $\text{Conf}_k^+(\mathcal{B})$ the space of positive configuration of k flags.

1.2. Theorem. — *The cyclic shift $(B_1, \dots, B_k) \mapsto (B_2, \dots, B_k, B_1)$ and reversion $(B_1, \dots, B_k) \mapsto (B_k, \dots, B_1)$ preserve the set of positive configurations of flags.*

We suggest that the configuration spaces $\text{Conf}_k^+(\mathcal{B})$ are the geometric objects reflecting the properties of totally positive elements in $G(\mathbf{R})$.

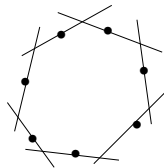

FIG. 1.4. — A positive configuration of six flags in $\mathbf{P}^2(\mathbf{R})$.

The positive configurations of flags in PGL_m have the following simple geometric description. Recall (cf. [Sch]) that a curve $C \subset \mathbf{RP}^m$ is *convex* if any hyperplane intersects it in no more than m points. Convex curves appeared first in classical problems of analysis ([GKr]).

1.3. Theorem. — *A configuration of k real flags (F_1, \dots, F_k) in \mathbf{RP}^m is positive if and only if there exists a (non-unique!) smooth convex curve C in \mathbf{RP}^m such that the flag F_i is an osculating flag at a point $x_i \in C$, and the order of the points x_1, \dots, x_k is compatible with an orientation of C .*

Examples. The real flag variety for PGL_2 is S^1 . A configuration of n points on S^1 is positive if and only if their order is compatible with an orientation of S^1 . Another example see on Fig. 1.4.

Generalising Definition 1.4, and using Theorem 1.2, we introduce the following key definition.

1.5. Definition. — *Let C be a cyclic set. A map $\beta : C \rightarrow \mathcal{B}(\mathbf{R})$ is called positive if for any finite cyclic subset x_1, \dots, x_n of S the configuration of flags $(\beta(x_1), \dots, \beta(x_n))$ is positive.*

The space of positive configurations of flags parametrised by a cyclic set C is denoted by $\text{Conf}_C^+(\mathcal{B})$.

By Theorem 1.2, changing a cyclic structure on C to the opposite does not affect positivity of a map.

Using positive configurations of real flags we define the higher Teichmüller \mathcal{X} -space.

1.6. Definition. — *Let \widehat{S} be a marked surface with boundary, and G a group with trivial center. Then the higher Teichmüller \mathcal{X} -space is given by*

$$\mathcal{X}_{G, \widehat{S}}^+ = \text{Conf}_{\mathcal{F}_\infty(\widehat{S}), \pi_1(S)}^+(\mathcal{B}). \tag{1.7}$$

Since G has trivial center, it acts freely on the configurations of $n > 2$ flags. So by Lemmas 1.1 and 1.2 a point of $\mathcal{X}_{G, \widehat{S}}^+$ is nothing else but a pair (ψ, ρ) , where ρ is a representation of $\pi_1(S)$ to $G(\mathbf{R})$, and $\psi : \mathcal{F}_\infty(\widehat{S}) \rightarrow \mathcal{B}(\mathbf{R})$ is a positive $(\pi_1(S), \rho)$ -equivariant map.

There is a similar definition of the higher Teichmüller \mathcal{A} -space.

Example. When \widehat{S} is a disc with k boundary points, the higher Teichmüller space $\mathcal{X}_{G, \widehat{S}}^+$ is the positive configuration space $\text{Conf}_k^+(\mathcal{B})$.

Before we proceed any further, let us introduce few simple definitions relevant to total positivity.

6. Positive atlases. Let H be a split algebraic torus over \mathbf{Q} , so $H \cong \mathbf{G}_m^N$. Following [BeK], a rational function f on H is called *positive* if it can be written as $f = f_1/f_2$ where f_1, f_2 are linear combinations of characters with positive integral coefficients. A *positive rational map* between two split algebraic tori H_1, H_2 is a rational map $f : H_1 \rightarrow H_2$ such that for any character χ of H_2 the composition $\chi \circ f$ is a positive rational function on H_1 . A composition of positive rational functions is positive .

Example. The map $x = a + b, y = b$ is positive, but its inverse $b = y, a = x - y$ is not.

We define a *positive divisor* in H as the divisor of a positive rational function on H . Here is our working definition of a positive atlas.

1.7. Definition. — A positive atlas on an irreducible scheme/stack X over \mathbf{Q} is a family of birational isomorphisms

$$\psi_\alpha : H_\alpha \longrightarrow X, \quad \alpha \in \mathcal{C}_X, \quad (1.8)$$

called positive coordinate systems on X , parametrised by a non-empty set \mathcal{C}_X , such that:

- i) each ψ_α is regular at the complement to a positive divisor in H_α ;
- ii) for any $\alpha, \beta \in \mathcal{C}_X$ the transition map $\psi_\beta^{-1} \circ \psi_\alpha : H_\alpha \longrightarrow H_\beta$ is a positive rational map.

A positive scheme is a scheme equipped with a positive atlas. In particular, a positive variety is rational. Given a positive scheme X , we associate to it an open domain $X(\mathbf{R}_{>0}) \hookrightarrow X(\mathbf{R})$ called the positive part of X . Namely, a point $p \in X(\mathbf{R})$ lies in $X(\mathbf{R}_{>0})$ if and only if its coordinates in one, and hence any, positive coordinate system on X are positive. Composing ψ_α^{-1} with an isomorphism $H_\alpha \xrightarrow{\sim} \mathbf{G}_m^N$ we get coordinates $\{X_i^\alpha\}$ on X , providing an isomorphism of manifolds

$$\varphi_\alpha : X(\mathbf{R}_{>0}) \xrightarrow{\sim} \mathbf{R}^{\dim X}, \quad p \in X(\mathbf{R}_{>0}) \longmapsto \{\log X_i^\alpha(p)\} \in \mathbf{R}^{\dim X}. \quad (1.9)$$

Let Γ be a group of automorphisms of X . We say that a positive atlas (1.8) on X is Γ -equivariant if Γ acts on the set \mathcal{C}_X , and for every $\gamma \in \Gamma$ there is an isomorphism of algebraic tori $i_\gamma : H_\alpha \xrightarrow{\sim} H_{\gamma(\alpha)}$ making the following diagram commutative:

$$\begin{array}{ccc} H_\alpha & \xrightarrow{\psi_\alpha} & X \\ \downarrow i_\gamma & & \downarrow \gamma_* \\ H_{\gamma(\alpha)} & \xrightarrow{\psi_{\gamma(\alpha)}} & X \end{array} \quad (1.10)$$

Here γ_* is the automorphism of X provided by γ . If a positive atlas on X is Γ -equivariant, then the group Γ acts on $X(\mathbf{R}_{>0})$.

7. Positive structure of the moduli spaces. Recall that the mapping class group Γ_S of S is isomorphic to the group of all outer automorphisms of $\pi_1(S)$ preserving the conjugacy classes provided by simple loops around each of the punctures. It acts naturally on the moduli spaces $\mathcal{X}_{G, \hat{S}}$, $\mathcal{A}_{G, \hat{S}}$, and $\mathcal{L}_{G, S}$.

1.4. Theorem. — Let G be a split semi-simple simply-connected algebraic group, and G' the corresponding adjoint group. Assume that $n > 0$. Then each of the moduli spaces $\mathcal{X}_{G', \hat{S}}$ and $\mathcal{A}_{G', \hat{S}}$ has a positive Γ_S -equivariant atlas.

Here is an outline of our construction of the positive atlas on $\mathcal{X}_{G',\widehat{S}}$.

The work [L1] provides a positive atlas on U^+ . The set of its $\mathbf{R}_{>0}$ -points is nothing else but the subset $U^+(\mathbf{R}_{>0})$ discussed in Section 1.5. It induces a positive atlas on the quotient U^+/H . Thus we get a positive atlas on the moduli space $\mathcal{X}_{G',\widehat{t}}$. The group S_3 permuting the vertices of the triangle t acts on it. We show in Theorem 5.2 that the group S_3 acts by positive birational maps on $\mathcal{X}_{G',\widehat{t}}$. Thus the S_3 -orbits of coordinate charts of the initial positive atlas give us a new, S_3 -equivariant atlas on the moduli space $\mathcal{X}_{G',\widehat{t}}$. Then the right hand side of (1.4) provides a positive atlas given by the product of the ones on $\mathcal{X}_{G',\widehat{t}}$ and H . We prove that the transition functions between the atlases provided by different triangulations are positive. Therefore the collection of positive atlases provided by the birational isomorphisms $\{\pi_T\}$ for all ideal triangulations of \widehat{S} gives rise to a (bigger) positive atlas on $\mathcal{X}_{G',\widehat{S}}$. It is Γ_S -equivariant by the construction.

For $G = SL_m$ we have a stronger result. A positive atlas is called *regular* if the maps ψ_α are regular open embeddings.

1.5. Theorem. — *The moduli spaces $\mathcal{X}_{PGL_m,\widehat{S}}$ and $\mathcal{A}_{SL_m,\widehat{S}}$ have regular positive Γ_S -equivariant atlases.*

Theorem 1.4 is proved in Sections 6 and 9 using the results of Section 5. Theorem 1.5 is proved in Sections 9-10 using simpler constructions of positive atlases on the SL_m -moduli spaces given in Section 9. These constructions can be obtained as special cases of the ones given in Sections 5, 6, and 8, but they have some extra nice properties special for SL_m , and do not rely on Sections 5, 6, and 8. In particular our X - (resp. A -) coordinates on the configuration space of triples of flags (resp. affine flags) in an m -dimensional vector space are manifestly invariant under the cyclic (resp. twisted cyclic) shift. One can not expect this property for a general group G , and this creates some technical issues, making formulations and proofs heavier. In addition to that, the construction of positive coordinate systems given in Section 9 is simpler and can be formulated using the classical language of projective geometry. We continue the discussion of the SL_m case in Section 1.15.

8. First applications of positivity: higher Teichmüller spaces and laminations. Below G stands for a split simply-connected semi-simple algebraic group over \mathbf{Q} , and G' is the corresponding adjoint group.

1.8. Definition. — *The higher Teichmüller spaces $\mathcal{X}_{G',\widehat{S}}^+$ and $\mathcal{A}_{G,\widehat{S}}^+$ are the real positive parts of the moduli spaces $\mathcal{X}_{G',\widehat{S}}$ and $\mathcal{A}_{G,\widehat{S}}$:*

$$\mathcal{X}_{G',\widehat{S}}^+ := \mathcal{X}_{G',\widehat{S}}(\mathbf{R}_{>0}) \hookrightarrow \mathcal{X}_{G',\widehat{S}}(\mathbf{R}), \quad \mathcal{A}_{G,\widehat{S}}^+ := \mathcal{A}_{G,\widehat{S}}(\mathbf{R}_{>0}) \hookrightarrow \mathcal{A}_{G,\widehat{S}}(\mathbf{R}).$$

The elements of the space $\mathcal{X}_{G',\widehat{S}}^+$ are called *positive framed $G(\mathbf{R})$ -local systems on \widehat{S}* .

1.6. Theorem. — *Definition 1.8 of the space $\mathcal{X}_{G',\widehat{S}}^+$ is equivalent to Definition 1.6.*

Thus there is a canonical bijection between the positive framed $G(\mathbf{R})$ -local systems (\mathcal{L}, β) on \widehat{S} and positive $\pi_1(S)$ -equivariant maps

$$\Phi_{\mathcal{L},\beta} : \mathcal{F}_\infty(\widehat{S}) \longrightarrow \mathcal{B}(\mathbf{R}) \quad \text{modulo the action of } G(\mathbf{R}). \quad (1.11)$$

where $\pi_1(S)$ acts on the flag variety via the monodromy representation of the local system \mathcal{L} .

Theorem 1.6 follows from Lemma 1.1 plus the definition (ii) of the Farey set $\mathcal{F}_\infty(S)$ or its version for \widehat{S} , which uses ideal triangulations of \widehat{S} . There is a similar interpretation of the space $\mathcal{A}_{G,\widehat{S}}^+$.

It follows that the spaces $\mathcal{X}_{G',\widehat{S}}^+$ and $\mathcal{A}_{G,\widehat{S}}^+$ are isomorphic to \mathbf{R}^N for some integer N . In particular, if $\widehat{S} = S$, i.e. there are no marked points on the boundary of S , we have isomorphisms

$$\mathcal{X}_{G',S}^+ \xrightarrow{\sim} \mathbf{R}^{-\chi(S)\dim G}, \quad \mathcal{A}_{G,S}^+ \xrightarrow{\sim} \mathbf{R}^{-\chi(S)\dim G} \quad (1.12)$$

The mapping class group Γ_S acts on $\mathcal{X}_{G',\widehat{S}}^+$ and $\mathcal{A}_{G,\widehat{S}}^+$. Let

$$\mathcal{L}_{G',S}^+ := \pi\left(\mathcal{X}_{G',S}^+\right) \subset \mathcal{L}_{G',S}(\mathbf{R}) \quad (1.13)$$

We call the points of $\mathcal{L}_{G',S}^+$ *positive local systems on S* , and their monodromy representations *positive representations of $\pi_1(S)$* . There is a natural embedding

$$\mathcal{L}_{G',S}^+ \hookrightarrow \mathcal{X}_{G',S}^+$$

splitting the canonical projection $\mathcal{X}_{G',S}^+ \rightarrow \mathcal{L}_{G',S}^+$.

In Section 11 we show that our construction, specialized to the case $G = SL_2$ for the \mathcal{A} -space and $G = PGL_2$ for the \mathcal{X} -space, gives the classical Teichmüller spaces $\mathcal{T}^d(S)$ and $\mathcal{T}^+(S)$:

1.7. Theorem. — *Let S be a hyperbolic surface with $n > 0$ holes. Then*

a) The Teichmüller space \mathcal{T}_S^+ is isomorphic to $\mathcal{X}_{PGL_2, S}^+$. Further, $\mathcal{L}_{PGL_2, S}^+$ is the classical Teichmüller space \mathcal{T}_S .

b) The decorated Teichmüller space \mathcal{T}_S^d is isomorphic to $\mathcal{A}_{SL_2, S}^+$.

Combining this theorem with the isomorphisms $\mathcal{X}_{PGL_2, S}^+ \cong \mathbf{R}^{6g-6+3n}$ and $\mathcal{A}_{SL_2, S}^+ \cong \mathbf{R}^{6g-6+3n}$ we arrive at the isomorphisms of manifolds

$$\mathcal{T}_S^+ \cong \mathbf{R}^{6g-6+3n} \quad \text{and} \quad \mathcal{T}_S^d \cong \mathbf{R}^{6g-6+3n}.$$

The first gives an elementary proof of the classical Teichmüller theorem for surfaces with holes.

We introduce *integral, rational and real G -lamination spaces* as the tropical limits of the positive moduli spaces $\mathcal{X}_{G, \hat{S}}$ and $\mathcal{A}_{G, \hat{S}}$, i.e. the sets of points of these spaces in the semifields $\mathbf{Z}^t, \mathbf{Q}^t, \mathbf{R}^t$. The projectivisations of the real lamination spaces are the Thurston-type boundaries of the corresponding Teichmüller spaces.

9. Positivity, hyperbolicity and discreteness of the monodromy representations. Consider the universal G -local system on the moduli space $S \times \mathcal{X}_{G, S}$. Its fiber over $S \times p$ is the local system corresponding to the point p of the moduli space $\mathcal{X}_{G, S}$. Let $\mathbf{F}_{G, S}$ be the field of rational functions on the moduli space $\mathcal{X}_{G, S}$. The monodromy of the universal local system around a loop on S is a conjugacy class in $G(\mathbf{F}_{G, S})$.

Observe that given a positive variety X , there is a subset $\mathbf{Q}_+(X)$ of the field of rational functions of X consisting of the functions which are positive in one, and hence in any of the positive coordinate systems on X . Clearly $\mathbf{Q}_+(X)$ is a semifield, the *positive semifield* of the positive variety X .

Theorem 1.4 delivers a positive atlas on the moduli space $\mathcal{X}_{G, S}$. Therefore we have the corresponding positive semifield $\mathbf{F}_{G, S}^+$ in the field $\mathbf{F}_{G, S}$. The group G has a positive atlas provided by the birational isomorphism $G \xrightarrow{\sim} U^- H U^+$ (the Gauss decomposition) and the positive atlases on the factors. So we have a well defined subset $G(\mathbf{F}_{G, S}^+)$.

1.8. Theorem. — *The monodromy of the universal G -local system on $S \times \mathcal{X}_{G, S}$ around any non-trivial non-boundary loop on S can be conjugated in $G(\mathbf{F}_{G, S})$ to an element of $G(\mathbf{F}_{G, S}^+)$.*

The monodromy around a boundary component can be conjugated to an element of $B^\pm(\mathbf{F}_{G, S}^+)$, where B^\pm means one of the Borel subgroups B^+ or B^- .

Observe that although this theorem is about monodromies of local systems on S , it can not be even stated without introducing the moduli space

$\mathcal{X}_{G,S}$ and a positive atlas on it. Here is a corollary formulated entirely in classical terms.

Let H^0 be the subvariety of the Cartan group H where the Weyl group W acts without fixed points. An element of $G(\mathbf{R})$ is called *positive hyperbolic* if it is conjugated to an element of $H^0(\mathbf{R}_{>0})$. For example, for $GL_n(\mathbf{R})$ these are the elements with distinct real positive eigenvalues.

1.9. Theorem. — *The monodromy of a positive local system on a surface S with boundary is faithful. Moreover its monodromy around any non-trivial non-boundary loop is positive hyperbolic.*

It follows from Theorem 1.8. Indeed, Definition 1.8 and Theorem 1.8 imply that the monodromy of a positive representation around a homotopy nontrivial non-boundary loop is conjugated to an element of $G(\mathbf{R}_{>0})$. By the Gantmacher-Krein theorem [GKr] for $G = GL_n$, and Theorem 5.6 in [L1] in general, any element of $G(\mathbf{R}_{>0})$ is positive hyperbolic. To prove faithfulness observe that the identity element belongs neither to $G(\mathbf{R}_{>0})$ nor to $B^\pm(\mathbf{R}_{>0})$.

1.10. Theorem. — *Let $G(\mathbf{R})$ be a split real semi-simple Lie group with trivial center. Then the image of a positive representation of $\pi_1(S)$ is a discrete subgroup in $G(\mathbf{R})$.*

Theorem 1.10 is proved in Section 7.1 using Theorem 1.6. Since the isomorphisms ψ_α describing the positive atlas on $\mathcal{X}_{G,\hat{S}}$ are defined explicitly, we obtain a parametrisation of a class of discrete subgroups in $G(\mathbf{R})$ which generalizes the Fuchsian subgroups of $PSL_2(\mathbf{R})$.

10. Universal higher Teichmüller spaces and positive $G(\mathbf{R})$ -opers. Theorem 1.6 suggests a definition of the *universal higher Teichmüller spaces* \mathcal{X}_G^+ .

Let us furnish $\mathbf{P}^1(\mathbf{Q})$ with a cyclic structure provided by the natural embedding $\mathbf{P}^1(\mathbf{Q}) \subset \mathbf{P}^1(\mathbf{R})$ and an orientation of $\mathbf{P}^1(\mathbf{R})$. The cyclic set of the vertices of the Farey triangulation is identified with $\mathbf{P}^1(\mathbf{Q})$. Thus we can identify the cyclic sets $\mathcal{F}_\infty(S)$ and $\mathbf{P}^1(\mathbf{Q})$.

1.9. Definition. — *The universal higher Teichmüller space \mathcal{X}_G^+ consists of all positive maps*

$$\beta : \mathbf{P}^1(\mathbf{Q}) \longrightarrow \mathcal{B}(\mathbf{R}) \quad \text{modulo the action of } G(\mathbf{R}). \quad (1.14)$$

For $G = PGL_2$ we get the universal Teichmüller space considered by Bers [Bers] and Penner [P3].

For a surface S with boundary, the higher Teichmüller spaces $\mathcal{X}_{G,S}^+$ can be embedded to the universal one as follows. Let Δ be a torsion free subgroup of $PSL_2(\mathbf{Z})$ and $S_\Delta := \mathcal{H}/\Delta$, where \mathcal{H} is the hyperbolic plane. Then S_Δ is equipped with a distinguished ideal triangulation, given by the image of the Farey triangulation of the hyperbolic plane (Figure (1.2)). Conversely, the subgroup $\Delta \subset PSL_2(\mathbf{Z})$ is determined uniquely up to conjugation by an ideal triangulation of S . The set of vertices of the Farey triangulation is identified with $\mathbf{P}^1(\mathbf{Q})$. Theorem 1.6 implies:

1.2. Corollary. — *The space $\mathcal{X}_{G,S_\Delta}^+$ parametrises pairs (a representation $\rho : \Delta \rightarrow G(\mathbf{R})$, a ρ -equivariant map (1.14)).*

The universal higher Teichmüller space \mathcal{X}_G^+ is equipped with a positive coordinate atlas. Observe that the set of vertices of the Farey triangulation is identified with $\mathbf{P}^1(\mathbf{Q})$. Using the Farey triangulation just the same way as ideal triangulations of S , we obtain the Decomposition Theorem for the universal higher Teichmüller space \mathcal{X}_G^+ , providing coordinate systems on \mathcal{X}_G^+ :

1.11. Theorem. — *There exists a canonical isomorphism*

$$\varphi_G : \mathcal{X}_G^+ \longrightarrow \prod_{t: \text{Farey triangles}} \mathcal{X}_{G,\hat{t}}^+ \times \prod_{\text{Farey diagonals}} H(\mathbf{R}_{>0}). \quad (1.15)$$

In Section 8.5 we define universal higher Teichmüller spaces \mathcal{A}_G^+ and prove similar results for them.

Positive continuous maps

$$S^1 \longrightarrow \mathcal{B}(\mathbf{R}) \quad (1.16)$$

are objects of independent interest. We prove in Section 7.8 that positive smooth maps (1.16) are integral curves of a canonical non-integrable distribution on the flag variety, provided by the simple positive roots, whose dimension equals the rank of G . So they can be viewed as the $G(\mathbf{R})$ -opers, in the sense of Beilinson and Drinfeld, on the circle. We call them *positive $G(\mathbf{R})$ -opers*.

It is well known that $PGL_m(\mathbf{R})$ -opers are nothing else but smooth curves in \mathbf{RP}^{m-1} : a smooth projective curve gives rise to its osculating curve in the flag variety. We show in Section 9.12 that positive $PGL_m(\mathbf{R})$ -opers correspond to smooth convex curves in \mathbf{RP}^{m-1} . More generally, positive continuous maps (1.16) give rise to C^1 -smooth convex curves. Thus positive continuous maps (1.16) generalize projective convex curves to the case of an arbitrary reductive group G .

11. Higher Teichmüller spaces for closed surfaces. ¹ Given a surface S , with or without boundary, there is a countable cyclic $\pi_1(S)$ -set $\mathcal{G}_\infty(S)$ defined as follows. Choose a hyperbolic structure with geodesic boundary on S , and lift all geodesics on S to the universal cover. The universal cover can be viewed as a part of the hyperbolic plane \mathcal{H} (Fig. 1.1). The endpoints of the preimages of non-boundary geodesics form a subset $\mathcal{G}'_\infty(S)$ of the absolute $\partial\mathcal{H}$. It inherits from the absolute a structure of the cyclic $\pi_1(S)$ -set, which does not depend on the choice of a hyperbolic structure on S . Set

$$\mathcal{G}_\infty(S) := \mathcal{F}_\infty(S) \cup \mathcal{G}'_\infty(S).$$

Using the definition (iii) of the Farey set (Section 1.3), one easily sees that $\mathcal{G}_\infty(S)$ is cyclic $\pi_1(S)$ -set extending $\mathcal{F}_\infty(S)$ and $\mathcal{G}'_\infty(S)$. When S is closed, the Farey set $\mathcal{F}_\infty(S)$ is empty. A hyperbolic structure on S provides $\mathcal{G}_\infty(S)$ with a topology induced from $\partial\mathcal{H}$. It does not depend on the choice of the hyperbolic structure.

According to Theorem 1.6, a framed positive local system (\mathcal{L}, β) on a surface S with boundary provides a $\pi_1(S)$ -equivariant positive map (1.11).

By Theorem 1.8, the monodromy M_γ of a positive local system along a non-boundary closed geodesic γ on S is conjugated to an element of $G(\mathbf{R}_{>0})$. Therefore there exists a distinguished flag preserved by the monodromy along γ : for $G = PGL_m(\mathbf{R})$ it is provided by the ordering of the eigenspaces of M_γ in which their eigenvalues increase; for the general case see Theorem 8.9 in [L1]. Thus, going to the universal cover of S , we get a $\pi_1(S)$ -equivariant map

$$\Psi_{\mathcal{L}, \beta} : \mathcal{G}_\infty(S) \longrightarrow \mathcal{B}(\mathbf{R}) \tag{1.17}$$

extending the map (1.11).

1.12. Theorem. — *Let S be a compact surface with boundary. Then the map (1.17) is a positive map. Moreover, it is a continuous map.*

The notion of positive configurations of flags and Theorems 1.6 and 1.12 suggest the following definition of higher Teichmüller spaces for compact surfaces S without boundary.

1.10. Definition. — *Let S be a compact surface with or without boundary. A representation $\rho : \pi_1(S) \rightarrow G(\mathbf{R})$ is positive, if there exists a positive ρ -equivariant map (1.17). The moduli space of positive representations is denoted by $\mathcal{L}_{G,S}^+$.*

¹ Most of the results of Sections 1.11-1.13 were obtained in 2005; Theorem 1.15 and the results of Section 1.18 were obtained in 2006.

1.3. Corollary. — *For surfaces with boundary Definition 1.10 is equivalent to the one we used before: the ρ -equivariant maps (1.17) modulo $G(\mathbf{R})$ -conjugation are in bijection with points of $\mathcal{X}_{G,S}^+$.*

Indeed, the restriction of the map (1.17) to $\mathcal{F}_\infty(S)$ provides a ρ -equivariant map (1.11). Since $\mathcal{F}_\infty(S)$ is dense in $\mathcal{G}_\infty(S)$, Theorem 1.12 tells us that it extends uniquely from $\mathcal{F}_\infty(S)$ to $\mathcal{G}_\infty(S)$.

Here is an interpretation of positive representations as $\pi_1(S)$ -equivariant configurations of real flags parametrised by the cyclic set $\mathcal{G}'_\infty(S)$ which follows from Lemma 1.2 and Definition 1.10:

$$\mathcal{L}_{G,S}^+ = \text{Conf}_{\mathcal{G}'_\infty(S), \pi_1(S)}^+(\mathcal{B}). \quad (1.18)$$

The following results show that the moduli space of positive representations have the basic features of the classical Teichmüller spaces. In particular, we extend Theorems 1.9, 1.10 and the isomorphisms (1.12) to the case of surfaces without boundary:

1.13. Theorem. — *Let G be a split real semi-simple Lie group with trivial center, and S a compact surface without boundary. Then*

(i) *A positive representation $\rho : \pi_1(S) \rightarrow G(\mathbf{R})$ is faithful, its image is a discrete subgroup in $G(\mathbf{R})$, and the image of any non-trivial element is positive hyperbolic.*

(ii) *The moduli space $\mathcal{L}_{G,S}^+$ of positive representations is diffeomorphic to $\mathbf{R}^{-\chi(S)\dim G}$.*

There is an embedding of the classical Teichmüller space into $\mathcal{L}_{G,S}^+$ provided by a Fuchsian subgroups in a principal $PGL_2(\mathbf{R})$ -subgroup of $G(\mathbf{R})$.

When S has no boundary, Nigel Hitchin [H1] studied topology of the space of representations $\pi_1(S) \rightarrow G(\mathbf{R})$ modulo conjugation such that the adjoint action of $\pi_1(S)$ on the Lie algebra of $G(\mathbf{R})$ is completely reducible. He proved that the component of this space containing (via the principal embedding $PGL_2(\mathbf{R}) \hookrightarrow G(\mathbf{R})$) the classical Teichmüller space is diffeomorphic to $\mathbf{R}^{-\chi(S)\dim G}$. It is called the Hitchin component. Furthermore, given a complex structure on S , let us denote by \mathbf{S} the corresponding Riemann surface. Hitchin proved that there is an isomorphism ($r = \text{rk}(G)$)

$$\text{the Hitchin component} = H^0(\mathbf{S}, \oplus_{i=1}^r \Omega_{\mathbf{S}}^{d_i}) \quad (1.19)$$

where d_1, \dots, d_r are the so-called exponents of G , e.g. $2, 3, \dots, m - 1$ when $G = PGL_m$, and $\Omega_{\mathbf{S}}$ is the sheaf of holomorphic differentials on \mathbf{S} . However the isomorphism (1.19) is not invariant under the mapping class group action.

Hitchin's approach is analytic. It is based on deep analytic results of Hitchin [H2], Corlette [C], Simpson [S] and Donaldson [D], and makes an essential use of a complex structure on S . It is very natural but rather non-explicit. Our approach is different: it is combinatorial, explicit, and does not use a complex structure on S . The two approaches are completely independent.

In the case when S has no boundary, and $G = PGL_m(\mathbf{R})$, a class of representations of $\pi_1(S)$, called Anosov representations, has been defined by Francois Labourie [Lab] using his Anosov structures, the boundary at infinity $\partial_\infty \pi_1(S)$ of $\pi_1(S)$ and (hyper)convex curves in \mathbf{RP}^{m-1} . Labourie (with a complement by O. Guichard [Gui]) proved that Anosov representations are exactly the ones from Hitchin's component for $PGL_m(\mathbf{R})$. Let us clarify the connection with his work.

Recall the following description of the boundary at infinity $\partial_\infty \pi_1(S)$ of $\pi_1(S)$. Choose a hyperbolic structure with geodesic boundary on S . Take the universal cover D of S . If S has no boundary, it is \mathcal{H} . Otherwise it is obtained by removing from \mathcal{H} half discs bounded by the preimages of the boundary geodesics on S , see Figure 1.1. Now $\partial_\infty \pi_1(S)$ is the intersection of the absolute of \mathcal{H} with the closure of D . Its cyclic structure is induced by the one of the absolute. The group $\pi_1(S)$ acts by deck transformations. For us it is important only that it is a cyclic $\pi_1(S)$ -set, which does not depend on the choice of hyperbolic structure on S . So there are canonical inclusions of cyclic $\pi_1(S)$ -sets, where the first two are countable sets:

$$\mathcal{F}_\infty(S) \subset \mathcal{G}_\infty(S) \subset \partial_\infty \pi_1(S).$$

1.14. Theorem. — *For a positive representation the map (1.17) extends uniquely to a continuous map*

$$\overline{\Psi}_\rho : \partial_\infty \pi_1(S) \longrightarrow \mathcal{B}(\mathbf{R}). \quad (1.20)$$

The image of this map is the *limit set* for the corresponding framed positive representation. Using a homeomorphism $\partial_\infty \pi_1(S, p) \rightarrow S^1$, we conclude that positive $G(\mathbf{R})$ -opers appear as the limit set maps for positive representations for closed surfaces S .

Using Theorems 1.3 and 1.14 one can show that, for a surface S without boundary and $G = PGL_m(\mathbf{R})$, Anosov representations [Lab] and our positive representations are the same.

1.15. Theorem. — *Assume that S has no boundary, and G has trivial center. Then the moduli space of positive representations $\mathcal{L}_{G,S}^+$ coincides with the Hitchin component in the representation space of $\pi_1(S)$ to $G(\mathbf{R})$.*

This gives another proof of the fact that for $G = PGL_m(\mathbf{R})$ the positive representations are the same as the Anosov representations.

Here is the scheme of the proof of Theorem 1.15. For a general group G the cutting and gluing results, reviewed below, imply that positive representations form an open connected subset of the Hitchin component. It contains the classical Teichmüller space. So to complete the proof we have to show that the space $\mathcal{L}_{G,S}^+$ is closed in the Hitchin component, which is done in Section 7.9.

12. Cutting and gluing. Let S be a surface, with or without boundary, with $\chi(S) < 0$. The moduli space $\mathcal{L}_{G,S}^+$ of positive $G(\mathbf{R})$ -local systems on S was defined for surfaces with boundary in (1.13), and for closed S in Definition 1.10.

Let γ be a non-trivial loop on S . We assume that γ is not homotopic to a boundary component of S . Denote by S' the surface obtained by cutting S along γ . It has two boundary components, γ_+ and γ_- , whose orientations are induced by the one of S' . The surface S' has one or two components, each of them of negative Euler characteristic. Denote by $\mathcal{L}_{G,S'}^+(\gamma_+, \gamma_-)$ the subspace of $\mathcal{L}_{G,S'}^+$ given by the following condition:

The monodromies along the loops γ_+ and γ_- are positive hyperbolic and mutually inverse. (1.21)

1.16. Theorem. — *Let S be a surface with $\chi(S) < 0$, and S' is obtained by cutting along a loop γ , as above. Then the restriction from S to S' provides us a principal $H(\mathbf{R}_{>0})$ -bundle*

$$\mathcal{L}_{G,S}^+ \longrightarrow \mathcal{L}_{G,S'}^+(\gamma_+, \gamma_-), \quad \mathcal{L} \longmapsto \mathcal{L}|_{S'}. \quad (1.22)$$

The space $\mathcal{L}_{G,S}^+$ is a connected topologically trivial domain of dimension $-\chi(S)\dim G$.

The first claim of the theorem just means that

1. The restriction of a positive local system on S to S' is positive.
2. The image of the restriction map consists of all positive local systems on S' satisfying the constraint (1.21) on the monodromies around the oriented loops γ_+ and γ_- .

3. Given a positive local system on S' satisfying the constraint (1.21), one can glue it to a positive local system on S , and the group $H(\mathbf{R}_{>0})$ acts simply transitively on the set of the gluings.

In particular, for every non-trivial non-boundary loop γ on S , there is an action t_γ of the group $H(\mathbf{R}_{>0})$ on $\mathcal{L}_{G,S}^+$ without fixed points. One can show that this action is Hamiltonian for the canonical Poisson structure on $\mathcal{L}_{G,S}^+$: the Hamiltonians for this action are provided by the monodromy along γ , understood as a map $\mathcal{L}_{G,S}^+ \rightarrow H(\mathbf{R}_{>0})/W$.

13. Configuration spaces and laminations. We define the lamination spaces for closed surfaces in Section 6.9. Here is how it is going.

For an arbitrary countable cyclic set C , there is a projective limit of positive spaces $\text{Conf}_C(\mathcal{B})$, obtained by taking the projective limit over finite subsets $C' \subset C$ (we underline \mathcal{B} to stress that it is an algebraic variety):

$$\text{Conf}_C(\underline{\mathcal{B}}) := \varprojlim \text{Conf}_{C'}(\underline{\mathcal{B}}).$$

If a group π acts on C , it acts on it, so taking the invariants under the action of the group π we get a subspace $\text{Conf}_{C,\pi}(\mathcal{B}) := \text{Conf}_C(\mathcal{B})^\pi$. So for any semifield K there is a well-defined set

$$\text{Conf}_{C,\pi}(\underline{\mathcal{B}})(K) = \text{Conf}_C(\underline{\mathcal{B}})(K)^\pi.$$

So for a closed surface S we define the lamination spaces by taking the tropical points:

$$\begin{aligned} & \textit{The space of } G\text{-laminations on } S \textit{ with coefficients in } \mathbf{A} := \text{Conf}_{\mathcal{G}_\infty(S), \pi_1(S)}(\underline{\mathcal{B}})(\mathbf{A}^t). \end{aligned} \tag{1.23}$$

The space $\mathcal{L}_{G,S}$ has a similar interpretation, see (1.10) for closed S and (1.7) for marked surfaces \widehat{S} with boundary. So, for any S , both the higher Teichmüller space and laminations spaces can be defined as the sets of $\mathbf{R}_{>0}$ and tropical points of certain configuration spaces.

14. The Weil-Petersson form on the moduli space $\mathcal{A}_{G,\widehat{S}}$ and its K_2 and motivic avatars. We define the Weil-Petersson form $\Omega_{G,\widehat{S}}$ on the moduli space $\mathcal{A}_{G,\widehat{S}}$ by constructing a K_2 -class on $\mathcal{A}_{G,\widehat{S}}$. We suggest that

many interesting symplectic structures can be upgraded to their K_2 -avatars.

Let us explain how a K_2 -class provides a symplectic form. Recall that thanks to the Matsumoto theorem [Mi] the group $K_2(F)$ of a field F is the quotient of the abelian group $A^2 F^*$ by the subgroup generated by the elements $(1 -$

$x) \wedge x$, $x \in F^* - \{1\}$, called the Steinberg relations. If $F = \mathbf{Q}(Y)$ is the field of rational functions on a variety Y there is a homomorphism

$$d \log : K_2(\mathbf{Q}(Y)) \longrightarrow \Omega_{\log}^2(\text{Spec}(\mathbf{Q}(Y))); \quad f_1 \wedge f_2 \longmapsto d \log f_1 \wedge d \log f_2.$$

Applying it to a class $w \in K_2(\mathbf{Q}(Y))$ we get a rational 2-form $d \log(w)$ with logarithmic singularities. Let us formulate a condition on w which guarantees that the 2-form $d \log(w)$ is non singular, and hence defines a degenerate symplectic structure of Y . Let Y_1 be the set of all irreducible divisors in a variety Y . There is a *tame symbol* homomorphism:

$$\text{Res} : K_2(\mathbf{Q}(Y)) \longrightarrow \bigoplus_{D \in Y_1} \mathbf{Q}(D)^*; \quad \{f, g\} \longmapsto \text{Res}_D \left(f^{v_D(g)} / g^{v_D(f)} \right) \quad (1.24)$$

where Res_D is restriction to the generic point of D , and $v_D(g)$ is the order of zero of g at the generic point of the divisor D . Set

$$\begin{aligned} H^2(Y, \mathbf{Z}_{\mathcal{M}}(2)) &:= \text{Ker}(\text{Res}) \hookrightarrow K_2(\mathbf{Q}(Y)), \\ H^2(Y, \mathbf{Q}_{\mathcal{M}}(2)) &:= H^2(Y, \mathbf{Z}_{\mathcal{M}}(2)) \otimes \mathbf{Q}. \end{aligned} \quad (1.25)$$

The map $d \log$ transforms the tame symbol to the residue map. So its restriction to (1.25) provides a homomorphism

$$d \log : H^2(Y, \mathbf{Z}_{\mathcal{M}}(2)) \longrightarrow \Omega^2(Y_0)$$

where Y_0 is the nonsingular part of Y . We define a class

$$W_{G, \hat{S}} \in H^2(\mathcal{A}_{G, \hat{S}}, \mathbf{Q}_{\mathcal{M}}(2))^{\Gamma_S} \quad (1.26)$$

and set

$$\Omega_{G, \hat{S}} := d \log(W_{G, \hat{S}}) \in \Omega^2(\mathcal{A}_{G, \hat{S}})^{\Gamma_S}.$$

We also define the class $W_{G, S}$ for a compact oriented surface S . One can show that for $G = SL_2$ the form $\Omega_{SL_2, S}$ coincides with W. Goldman's symplectic structure [Gol1] on the space $\mathcal{L}_{SL_2, S}$. Its restriction to the Teichmüller component is the Weil-Petersson symplectic structure. The K_2 -avatar of the Weil-Petersson form is a new object even in the classical case $G = SL_2$.

Motivic avatar of the Weil-Petersson form. We show that the K_2 -class $W_{G, \hat{S}}$ is a manifestation of a richer algebraic structure described by using the weight two motivic cohomology understood via the Bloch-Suslin complex, and the motivic dilogarithm. Namely, we construct a *motivic avatar*

$$\mathbf{W}_{G, \hat{S}} \in H_{\Gamma_S}^2(\mathcal{A}_{G, \hat{S}}, \mathbf{Q}_{\mathcal{M}}(2))$$

of the form $\Omega_{G, \hat{S}}$. It lives in the Γ_S -equivariant weight two motivic cohomology of $\mathcal{A}_{G, \hat{S}}$.

The 2-form $\Omega_{G,\widehat{S}}$ as well as its avatars are lifted from similar objects on the moduli space $\mathcal{U}_{G,\widehat{S}}$ of the unipotent framed G -local systems on \widehat{S} . The corresponding 2-form on the moduli space $\mathcal{U}_{G,\widehat{S}}$ is non degenerate, and thus provides a symplectic structure on this space.

Our construction uses as a building block the second motivic Chern class c_2^M of the universal G -bundle over the classifying space BG_\bullet . When $G = SL_m$, there is an explicit cocycle for the class c_2^M constructed in [G3]. Applying to it our general procedure we arrive at an explicit cocycle for the class $\mathbf{W}_{SL_m,\widehat{S}}$. Magically this construction delivers canonical coordinates on the space $\mathcal{A}_{SL_m,\widehat{S}}$. Their properties are outlined in the next subsection.

15. The (orbi)-cluster ensemble structure in the PGL_m/SL_m case.

Let T be an ideal triangulation of \widehat{S} . Take the triangle

$$x + y + z = m, \quad x, y, z \geq 0$$

and consider its triangulation given by the lines $x = p$, $y = p$, $z = p$ where $0 \leq p \leq m$ is an integer. The m -triangulation of a triangle is a triangulation isotopic to this one. Let us m -triangulate each triangle of the triangulation T , so each side gets $m + 1$ vertices. We get a subtriangulation, called the m -triangulation of T . An edge of the m -triangulation of T is called an *internal edge* if it does not lie on a side of the original triangulation T . The orientation of S provides orientations of the internal edges. Indeed, take a triangle t of the triangulation T . The orientation of S provides an orientation of its boundary. An internal edge e sitting inside of t is parallel to a certain side of t , so the orientation of this side induces an orientation of e . This is illustrated on Figure 1.5. Here on the right there are two adjacent triangles of the triangulation T . On the left we show the 4-triangulation of these triangles. Their internal edges are oriented accordantly to the cyclic structure coming from the clockwise orientation of the plain.

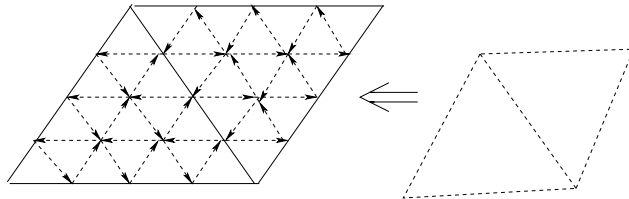

FIG. 1.5. — The 4-triangulation arising from a triangulation of a surface.

Given an ideal triangulation T of \widehat{S} , we define a canonical coordinate system $\{\Delta_i\}$ on the space $\mathcal{A}_{SL_m, \widehat{S}}$, parameterized by the set

$$I_m^T := \begin{cases} \text{vertices of the } m\text{-triangulation of } T \\ \text{vertices at the punctures of } S \end{cases}. \quad (1.27)$$

Further, we define a canonical coordinate system $\{X_j\}$ on $\mathcal{X}_{PGL_m, \widehat{S}}$ parameterised by the set

$$J_m^T := I_m^T - \{ \text{the vertices at the boundary of } S \}.$$

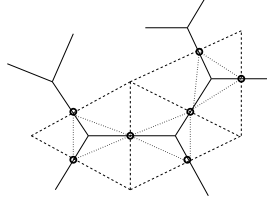

FIG. 1.6. — The set J_2^T is naturally identified with the set of all internal edges of T .

1.11. Definition. — A skew symmetric \mathbf{Z} -valued function ε_{pq} on the set of vertices of the m -triangulation of T is given by

$$\varepsilon_{pq} := \#\{\text{oriented edges from } p \text{ to } q\} - \#\{\text{oriented edges from } q \text{ to } p\}. \quad (1.28)$$

The Weil-Petersson form and the Poisson structure in these coordinates are given by

$$\Omega_{SL_m, \widehat{S}} = \sum_{i_1, i_2} \varepsilon_{i_1 i_2} d \log \Delta_{i_1} \wedge d \log \Delta_{i_2}, \quad \{X_{j_1}, X_{j_2}\}_{PGL_m, \widehat{S}} = \sum_{j_1, j_2} \varepsilon_{j_1, j_2} X_{j_1} X_{j_2}. \quad (1.29)$$

The K_2 -avatar of the Weil-Petersson form is given by

$$W_{SL_m, \widehat{S}} = \sum_{i_1, i_2} \varepsilon_{i_1 i_2} \{\Delta_{i_1}, \Delta_{i_2}\}.$$

We call an ideal triangulation T of \widehat{S} is *special* if its dual graph contains, as a part, one of the graphs shown on Figure 1.7. A marked surface \widehat{S} is *special* if it admits a special triangulation, and *regular* otherwise.



FIG. 1.7. — Special graphs, called a virus and an eye.

1.3. Lemma. — *A marked hyperbolic surfaces \widehat{S} is special if and only if it contains at least two holes, and in addition one of the holes has no marked points on the boundary.*

The sets I_m^T and J_m^T can be defined for any, not necessarily finite, triangulation T . An especially interesting example is provided by the Farey triangulation. It is obviously regular. It has no boundary, so the I and J sets coincide, and are denoted by I_m . Since the function ε_{pq} for the set I_m has finite support for every given p , all structures of the cluster ensemble but the W -class make sense.

1.17. Theorem. — *a) The universal pair of positive spaces $(\mathcal{X}_{PGL_m}, \mathcal{A}_{SL_m})$ is a part of the cluster ensemble for the function ε_{pq} on the set I_m .*

b) If \widehat{S} is regular, the pair of positive spaces $(\mathcal{X}_{PGL_m, \widehat{S}}, \mathcal{A}_{SL_m, \widehat{S}})$ is a part of the cluster ensemble for the function ε_{pq} from Definition 1.11.

We assign to every triangulation T of \widehat{S} a coordinate system on the \mathcal{X} - and \mathcal{A} -space. For every T the function ε_{pq} from Definition 1.11 describes the Poisson structure on $\mathcal{X}_{PGL_m, \widehat{S}}$ and the W -class on $\mathcal{A}_{SL_m, \widehat{S}}$ in the corresponding coordinate system via formulas (1.29). However the transition functions between the coordinate systems assigned to special triangulations are slightly different than the ones prescribed by the cluster ensemble data. We show that the pair of positive spaces $(\mathcal{X}_{PGL_m, \widehat{S}}, \mathcal{A}_{SL_m, \widehat{S}})$ is related to a more general orbi-cluster ensemble structure.

1.18. Theorem. — *If \widehat{S} is special, the pair of positive spaces $(\mathcal{X}_{PGL_m, \widehat{S}}, \mathcal{A}_{SL_m, \widehat{S}})$ is a part of the orbi-cluster ensemble for the function ε_{pq} from Definition 1.11.*

The precise meaning of this theorem is discussed in Section 10. In a sequel to this paper we will prove a similar result for an arbitrary G , quantize the higher Teichmüller spaces and as a result construct an infinite dimensional unitary projective representation of the group Γ_S .

16. The cluster mapping class group. As we show in [FG2], every cluster ensemble comes with a group of symmetries, called the *cluster mapping group*. Here is how it is defined (a bit more general definition see in loc.

cit.). Let \mathcal{X} be a rational Poisson variety equipped with a rational coordinate system $\{X_i\}$ parametrised by a set I , $i \in I$, so that the Poisson structure is given by

$$\{X_i, X_j\} = \varepsilon_{ij} X_i X_j \quad \text{where } \varepsilon_{ij} \in \mathbf{Z}.$$

Then for every $k \in I$ there is a rational automorphism μ_k of \mathcal{X} , called a *mutation in the direction k* , given by

$$\mu_k^* X_i = \begin{cases} X_k^{-1} & \text{if } i = k \\ X_i(1 + X_k^{-\text{sgn}\varepsilon_{ik}})^{-\varepsilon_{ik}} & \text{if } i \neq k. \end{cases} \quad (1.30)$$

The Poisson structure in the mutated coordinates $X'_i := \mu_k^*(X_i)$ is again quadratic, and given by $\{X'_i, X'_j\} = \varepsilon'_{ij} X'_i X'_j$, where $\varepsilon'_{ij} \in \mathbf{Z}$. The Poisson tensor ε'_{ij} is calculated from the one ε_{ij} by an explicit formula. The mutated coordinate system is parametrized by the same set I , so we can apply the above procedure again and again. Further, let a $\sigma: I \rightarrow I$ be a bijection. It gives rise to an automorphism $\sigma: \mathcal{X} \rightarrow \mathcal{X}$ called a *symmetry*, so that $X'_i := \sigma^* X_i := X_{\sigma(i)}$, with a new Poisson tensor $\varepsilon'_{ij} := \varepsilon_{\sigma(i)\sigma(j)}$. We define an *\mathcal{X} -cluster transformation* as a composition of mutations and symmetries. It is a birational Poisson automorphism α of \mathcal{X} such that $\{\alpha^* X_i, \alpha^* X_j\} = \varepsilon_{ij}^\alpha X_i X_j$. The cluster transformations α preserving the ε_{ij} -tensor, i.e. $\varepsilon_{ij}^\alpha = \varepsilon_{ij}$, form a group. The *cluster mapping class group* is the image of this group in the group of birational automorphisms of \mathcal{X} .

The moduli space $\mathcal{X}_{G,S}$ admits such a coordinate system (with slight modifications when G is not simply-laced). For $G = PGL_m$ the corresponding data was described in Section 1.15. We prove that in our situation the cluster mapping class group, denoted $\Gamma_{G,\widehat{S}}$, contains the classical mapping class group Γ_S of S . As a result we show that the classical mapping class group acts by cluster transformation of our moduli spaces, and this it is given in a very explicit form. If $G = PGL_2$, the two mapping class groups coincide. It would be extremely interesting to determine the group $\Gamma_{G,\widehat{S}}$ in general.

Examples. 1. Let G be a group of type G_2 , and let \widehat{S} be a disc with three marked points at the boundary. Then the classical mapping class group is $\mathbf{Z}/3\mathbf{Z}$. The cluster mapping class group is an infinite quotient of the braid group of type G_2 , which conjecturally coincides with the latter ([FG5]).

2. Let S be an annulus with $2k$ marked points on one component of the boundary, $k \geq 1$. The classical mapping class group is $\mathbf{Z}/2k\mathbf{Z}$. Let G be an arbitrary split semi-simple group over \mathbf{Q} . The braid group \mathbf{B}_G of type G acts by cluster transformations of the corresponding moduli space. The center acts trivially. It is likely that the cluster mapping class group in this case is the quotient of the braid group \mathbf{B}_G by its center. ([FG6]).

Here is a concrete problem. Recall (see Section 1.9) that, given a loop γ on S , there is an action of the group $H(\mathbf{R}_{>0})$ on the Teichmüller space $\mathcal{L}_{G,S}^+$. It always contains a subgroup \mathbf{Z} generated by the Dehn twist along γ . If $G = PGL_2$, then $H(\mathbf{R}_{>0})$ is isomorphic to \mathbf{R} , so the quotient by the subgroup generated by the Dehn twist is compact. It is no longer compact in all other cases. Is there an abelian subgroup of $\Gamma_{G,S}$, which is of rank $\dim H$, lies in $H(\mathbf{R}_{>0})$, and is cocompact there?

It follows from [FG2] that the cluster mapping class group $\Gamma_{G,\widehat{S}}$ acts by birational automorphisms of the non-commutative q -deformation of the moduli space $\mathcal{X}_{G,\widehat{S}}$. Moreover, this leads to a construction of an infinite-dimensional unitary representation of $\Gamma_{G,\widehat{S}}$, and we conjecture that it provides an example of infinite-dimensional modular functor. This and other indications strongly suggest that the “true” moduli space related to the pair (G, \widehat{S}) should be the quotient $\mathcal{X}_{G,\widehat{S}}^+/\Gamma_{G,\widehat{S}}$, or, better, just the pair $(\mathcal{X}_{G,\widehat{S}}^+, \Gamma_{G,\widehat{S}})$.

17. Duality conjectures. We suggest that there exists a remarkable duality interchanging the \mathcal{A} - and \mathcal{X} -moduli spaces on \widehat{S} , which changes the group G to its Langlands dual ${}^L G$. So the dual pairs are

$$\mathcal{A}_{G,\widehat{S}} \quad \text{and} \quad \mathcal{X}_{{}^L G,\widehat{S}}.$$

Observe that the Langlands dual to an adjoint simple group is simply-connected, and vice versa. Here is one of the manifestations of this duality.

Let \mathcal{X} be a positive space. Let $\mathbf{L}_+[\mathcal{X}]$ be the subset of all rational functions F on \mathcal{X} such that for every positive coordinate system ψ_α the function F written in the corresponding coordinates is a Laurent polynomial with positive integral coefficients. In other words $\psi_\alpha^* F$ is a regular positive function on the torus H_α . Then $\mathbf{L}_+[\mathcal{X}]$ is evidently a semiring. Let $\mathbf{E}(\mathcal{X})$ be its set of *extremal elements*, i.e. elements $F \in \mathbf{L}_+[\mathcal{X}]$ which can not be decomposed into a sum $F = F_1 + F_2$ of two non-zero elements $F_i \in \mathbf{L}_+[\mathcal{X}]$.

Observe that for any semifield K the set $\mathcal{X}(K)$ is determined by a single coordinate system of the positive atlas on \mathcal{X} , which provides an isomorphism $\mathcal{X}(K) \xrightarrow{\sim} K^{\dim \mathcal{X}}$. On the other hand the semiring $\mathbf{L}_+[\mathcal{X}]$ shrinks when we get more coordinate systems in our positive atlas. In particular it may be empty.

Let L be a set. Denote by $\mathbf{Z}_+\{L\}$ the abelian semigroup generated by L . Its elements are finite expressions $\sum_i n_i \{l_i\}$ where $l_i \geq 0$, where $\{l_i\}$ is the generator corresponding to $l_i \in L$.

The group W^n acts naturally on both moduli spaces: this is obvious for the \mathcal{X} -space, but rather surprising for the \mathcal{A} -space – see Section 12.6 where the latter action is discussed.

1.1. Conjecture. — *Let G be a connected, simply-connected, split semi-simple algebraic group. Let S be a surface with boundary. Then there exist canonical isomorphisms of sets, which are equivariant with respect to the action of the (cluster) mapping class group, and intertwine the two actions of the group W^n :*

$$\mathcal{A}_{G,S}(\mathbf{Z}^t) \xrightarrow{\sim} \mathbf{E}(\mathcal{X}_{L_{G,S}}), \quad \mathcal{X}_{L_{G,S}}(\mathbf{Z}^t) \xrightarrow{\sim} \mathbf{E}(\mathcal{A}_{G,S}), \quad (1.31)$$

Moreover they extend to isomorphisms of the semirings

$$\mathbf{Z}_+\{\mathcal{A}_{G,S}(\mathbf{Z}^t)\} \xrightarrow{\sim} \mathbf{L}_+(\mathcal{X}_{L_{G,S}}), \quad \mathbf{Z}_+\{\mathcal{X}_{L_{G,S}}(\mathbf{Z}^t)\} \xrightarrow{\sim} \mathbf{L}_+(\mathcal{A}_{G,S}). \quad (1.32)$$

A considerable part of Conjecture 1.1 for $G = SL_2$ is proved in Section 12: we define the above canonical maps, and prove most of their properties. However we can not show that the functions assigned to laminations are extremal elements.

As explained in Section 4 of [FG2], there are several other versions of the duality conjectures. In one of them \mathbf{Z}^t is replaced by the real tropical field \mathbf{R}^t , while \mathbf{L}_+ is replaced by functions on $\mathbf{R}_{>0}$ points of the dual space. So in this form we are looking for a pairing between the \mathbf{R}^t -points of one of the spaces with the $\mathbf{R}_{>0}$ -points of the other.

There are quantum versions of these conjectures where $\mathbf{L}_+(\mathcal{X}_{G,S})$ is replaced by the corresponding semiring on the non-commutative q -deformation $\mathcal{X}_{G,S}^q$, or by the non-commutative $*$ -algebra of functions on the Teichmüller space $\mathcal{X}_{G,S}(\mathbf{R}_{>0})$. In the first case it is paired with $\mathcal{A}_{G,S}(\mathbf{Z}^t)$, while in the second with $\mathcal{A}_{G,S}(\mathbf{R}^t)$.

The Duality Conjecture for surfaces without boundary is discussed in Section 13.4.

Summarizing, the spirit of these conjectures is this: we are looking for a description of one of the spaces, perhaps made non-commutative (in several different ways), via tropicalization of the dual space. The tropical points are points of the Thurston type boundary. It would be very interesting to have a duality between the two moduli spaces, which degenerates to our duality when one of the spaces is replaced by its tropicalization. This reminds us of the mirror duality.

18. Completions of Teichmüller spaces and canonical bases. In Section 13 we define a (partial for $G \neq PSL_2$) completion of the higher Teichmüller space. It is equipped with an action of the mapping class group of S . Its strata are parametrised by *simple laminations*, that is the isotopy classes of collections of simple disjoint non-isotopic loops on S , non-isotopic to any of the boundary components. The stratum corresponding to a simple

lamination l is given by an appropriate Teichmüller space for the surface $S-l$. In the classical case when $G = PGL_2(\mathbf{R})$ we get a new construction of the Weil-Petersson completion of the Teichmüller space which goes back to L. Bers [Bers2] - see [Wo] and references therein. Its quotient under the mapping class group is the Knudsen-Deligne-Mumford moduli space $\overline{\mathcal{M}}_{g,n}$. For example when S is a punctured torus, the Teichmüller space is identified with the hyperbolic disc, and the completion is obtained by adding a countable set of cusps to its boundary, identified with $\mathbf{P}^1(\mathbf{Q})$.

We conjecture the existence of the canonical map for surfaces without boundary. Its restriction to the boundary component corresponding to a simple lamination l on S should be given by the canonical map from Conjecture 1.1 for the surface $S-l$. This requirement should determine uniquely the canonical map for surfaces without boundary.

19. Coda. We suggest that investigation of the pair of moduli spaces $(\mathcal{A}_{G,\widehat{S}}, \mathcal{X}_{G',\widehat{S}})$ can be viewed as a marriage of representation theory and the theory of surfaces. Indeed, when the surface \widehat{S} is simple, i.e. is a disc with marked points on the boundary or an annulus, we recover many aspects of the representation theory for the group G , quite often from a new point of view: positivity in $G(\mathbf{R})$, Steinberg varieties, invariants in the tensor products of finite-dimensional representations, quantum groups, canonical bases, W -algebras, etc. On the other hand, when $G = SL_2$ but \widehat{S} is general we get the theory of Riemann surfaces.

Moreover, we expect that the theory of quasifuchsian and Kleinian groups also admits a generalization, where $PGL_2(\mathbf{C})$ is replaced by an arbitrary semi-simple complex Lie group - see Section 7.12. The higher Teichmüller spaces should describe the corresponding deformation spaces just the same way as in the Bers double uniformization theorem and its generalization to Kleinian groups.

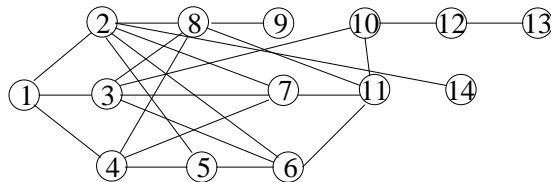

FIG. 1.8. — Leitfaden

Acknowledgments. N. Reshetikhin informed us about his work in progress with R. Kashaev, containing a result similar to our decomposition (8.20).

After the first version of this work was posted in the ArXiv, we learned about a very interesting preprint of F. Labourie [Lab] who, for surfaces S without holes, defined, using a dynamical systems approach, a class of representations $\pi_1(S) \rightarrow PSL_m(\mathbf{R})$, and proved that they are discrete, hyperbolic, and coincide with the ones defined by Hitchin.

This work was developed when V.F. visited Brown University. He would like to thank Brown University for hospitality and support. He wishes to thank grants RFBR 01-01-00549, 0302-17554 and NSh 1999.2003.2. A.G. was supported by the NSF grants DMS-0099390 and DMS-0400449. The paper was essentially written when A.G. enjoyed the hospitality of IHES (Bures sur Yvette) and MPI (Bonn) during the Summer and Fall of 2003. He is grateful to NSF, IHES and MPI for the support. We are grateful to J. Bernstein, M. Gromov, D. Kazhdan, M. Kontsevich for many stimulating discussions, to F. Labourie for the explanation of his approach in [Lab], and to M. King and D. Dumas for proofreading a part of the paper.

We are extremely grateful to the referee, who read very carefully the paper, corrected several errors, and made a lot of remarks and suggestions, incorporated into the text, to improve the exposition.

2. The moduli spaces $\mathcal{A}_{G,\hat{S}}$ and $\mathcal{X}_{G,\hat{S}}$

Let us replace the holes on S by punctures, getting a surface S' . The local systems on S and S' are the same. Let us equip the surface S' with a complex structure. Then we get a complex algebraic curve \mathbf{S} . The moduli space of local systems on \mathbf{S} has two different algebraic structures: the monodromic and the De Rham structures. Nevertheless the corresponding complex analytic spaces are isomorphic. The monodromic structure depends only on the fundamental group $\pi_1(\mathbf{S}(\mathbf{C}))$. Therefore it is determined by the topological surface S' underlying the curve \mathbf{S} . The corresponding moduli stack is denoted $\mathcal{L}_{G,S}$. To define the De Rham structure recall the Riemann-Hilbert correspondence ([Del]) between the isomorphism classes of G -local systems on $S' = \mathbf{S}(\mathbf{C})$ and algebraic G -connections with regular singularities on the algebraic curve \mathbf{S} . The moduli space $\mathcal{L}_{G,\mathbf{S}}$ of regular G -connections on \mathbf{S} is an algebraic stack over \mathbf{Q} . Its algebraic structure depends on the algebraic structure of the curve \mathbf{S} . It is the De Rham algebraic structure. The Riemann-Hilbert correspondence provides an isomorphism of the complex analytic spaces $\mathcal{L}_{G,S}(\mathbf{C})$ and $\mathcal{L}_{G,\mathbf{S}}(\mathbf{C})$.

1. The moduli spaces $\mathcal{X}_{G,\hat{S}}$. The flag variety \mathcal{B} parametrises all Borel subgroups in G . Choosing a Borel subgroup B we identify it with G/B . Let

\mathcal{L} be a G -local system on S . Recall the associated *flag bundle* $\mathcal{L}_{\mathcal{B}} := \mathcal{L} \times_G \mathcal{B}$. We call the elements of a fiber of $\mathcal{L}_{\mathcal{B}}$ over x *flags over x in \mathcal{L}* . A reduction of a G -local system \mathcal{L} on a circle to B is just the same as a choice of a flag in a fiber of \mathcal{L} invariant under the monodromy.

Examples. a) A flag in a vector space V is given by a filtration

$$0 = V_0 \subset V_1 \subset V_2 \subset \dots \subset V_m = V, \quad \dim V_i = i. \quad (2.1)$$

The flag variety for $G = GL_m$ parametrizes all flags in V .

b) Let $G = GL_m$. Recall the bijective correspondence between the GL_m -local systems and local systems of m -dimensional vector spaces. Namely, let V be a standard m -dimensional representation of GL_m . A GL_m -local system \mathcal{L} provides a local system of vector spaces $\mathcal{L}' := \mathcal{L} \times_{GL_m} V$. Conversely, given an m -dimensional local system \mathcal{L}' we recover the corresponding GL_m -local system by taking all bases in fibers of \mathcal{L}' . The flag bundle $\mathcal{L}_{\mathcal{B}}$ consists of all flags in the fibers of the local system \mathcal{L}' . If $G = SL_m$, \mathcal{L}' is a local system with an invariant volume form.

2.1. Definition. — *Let G be an arbitrary split reductive group. A framed G -local system on \widehat{S} is a pair (\mathcal{L}, β) where \mathcal{L} is a G -local system on S and β is a flat section of the restriction of $\mathcal{L}_{\mathcal{B}}$ to the punctured boundary $\partial \widehat{S}$. $\mathcal{X}_{G, \widehat{S}}$ is the moduli space of framed G -local systems on \widehat{S} .*

One can rephrase this definition as follows:

i) If C_i is a boundary component without marked points, we choose a flag F_x over a certain point $x \in C_i$ invariant under the monodromy around C_i . Equivalently, we choose a reduction to the subgroup B of the restriction of the G -local system \mathcal{L} to the boundary component C_i . The parallel transport of the flag F_x provides the restriction of the section β to C_i , and vice versa.

ii) If there is a non empty set $\{x_1, \dots, x_p\}$ of boundary points on the component C_i , the complement $C_i - \{x_1, \dots, x_p\}$ is a union of p arcs. Let us pick a point y_j inside of each of these arcs, and choose a flag F_j over y_j . These flags may not be invariant under the monodromy. The flags F_j determine the restriction of the flat section β to the corresponding arc, and vice versa.

The Cartan group of G . A split reductive algebraic group G determines the Cartan group H . Namely, let B be a Borel subgroup in G . Then $H := B/U$ where U is the unipotent radical of B . If B' is another Borel subgroup then B and B' are conjugate in G , and this conjugation induces a canonical

isomorphism $B/U \longrightarrow B'/U'$. So the quotient B/U is canonically isomorphic to the Cartan subgroup H in G . Let

$$i_B : H \rightarrow B/U \quad (2.2)$$

be the canonical isomorphism. The Cartan group H is not considered as a subgroup of G .

If $S = \widehat{S}$, i.e. there are no marked points, the canonical projection $B \rightarrow H = B/U$ provides a natural projection

$$\kappa : \mathcal{X}_{G,S} \longrightarrow H^{\{\text{punctures of } S'\}}. \quad (2.3)$$

The moduli space $\mathcal{X}_{G,\widehat{S}}$ as a quotient stack. Let F be an arbitrary field. Choose a point $x \in S$. Let g be the genus of the surface \overline{S} . Let us choose generators $\alpha_1, \dots, \alpha_g, \beta_1, \dots, \beta_g, \gamma_1, \dots, \gamma_n \in \pi_1(S, x)$ such that

$$\prod_{j=1}^g [\alpha_j, \beta_j] \prod_{i=1}^n \gamma_i = 1 \quad (2.4)$$

and where γ_i belongs to the conjugacy class in $\pi_1(S, x)$ determined by the i -th hole in S . It is well known that such a system of generators exists, and that (2.4) is the only relation between them in $\pi_1(S, x)$.

2.2. Definition. — *A framed representation $\pi_1(S, x) \rightarrow G(F)$ is the following data:*

$$\left(X_{\alpha_1}, \dots, X_{\alpha_g}, X_{\beta_1}, \dots, X_{\beta_g}, X_{\gamma_1}, \dots, X_{\gamma_n}, \{B_j\} \right), \quad (2.5)$$

$$X_{\gamma_j} \in G(F), \quad j \in \pi_0(\partial \widehat{S}), \quad B_j \in \mathcal{B}(F)$$

where X_{γ_j} satisfy (2.4), and if j corresponds to a connected component C_j of the boundary of S without marked points on it, then $X_{\gamma_j} \in B_j(F)$.

Obviously the elements of the set (2.5) are the F -points of an affine algebraic variety denoted by $\widetilde{\mathcal{X}}_{G,\widehat{S}}$. The algebraic group G acts on this variety, and, by definition, the stack $\mathcal{X}_{G,\widehat{S}}$ is the quotient stack $\widetilde{\mathcal{X}}_{G,\widehat{S}}/G$. A version of definition of the stack $\mathcal{X}_{G,S}$ see in Section 12.5.

Examples. 1. Let \widehat{D}_n be a disc with n marked points on the boundary. Then $\widetilde{\mathcal{X}}_{G,\widehat{D}_n} = \mathcal{B}^n$, and $\mathcal{X}_{G,\widehat{D}_n} = G \backslash \mathcal{B}^n$ is the space of configurations of n flags.

2. Let S be an annulus. Then $\widetilde{\mathcal{X}}_{G,S} = \{(g, B_1, B_2)\}$ where B_i are Borel subgroups in G and $g \in B_1, g \in B_2$. The quotient $\mathcal{X}_{G,S} := \widetilde{\mathcal{X}}_{G,S}/G$ is the Steinberg variety, see [CG].

2. Pinnings. Let us introduce some notations following [L1]. Let G be a split reductive simply-connected connected algebraic group over \mathbf{Q} . Let H be a split maximal torus of G and B^+, B^- a pair of opposed Borel subgroups containing H , with unipotent radicals U^+, U^- . Let U_i^+ ($i \in I$) be the simple root subgroups of U^+ and let U_i^- be the corresponding root subgroups of U^- . Here I is a finite set indexing the simple roots. Denote by $\chi'_i : H \rightarrow \mathbf{G}_m$ the simple root corresponding to U_i^+ . Let $\chi_i : \mathbf{G}_m \rightarrow H$ be the simple coroot corresponding to χ'_i . Let $\mathbf{G}_a := \text{Spec} \mathbf{Q}[t]$ be the additive one dimensional algebraic group. We assume that for each $i \in I$ we are given isomorphisms $x_i : \mathbf{G}_a \rightarrow U_i^+$ and $y_i : \mathbf{G}_a \rightarrow U_i^-$ such that the maps

$$\begin{pmatrix} 1 & a \\ 0 & 1 \end{pmatrix} \mapsto x_i(a), \quad \begin{pmatrix} 1 & 0 \\ b & 1 \end{pmatrix} \mapsto y_i(b), \quad \begin{pmatrix} t & 0 \\ 0 & t^{-1} \end{pmatrix} \mapsto \chi_i(t)$$

provide a homomorphism $\varphi_i : SL_2 \rightarrow G$. The datum $(H, B^+, B^-, x_i, y_i; i \in I)$ is called a *pinning* for G . The group G acts by conjugation on pinnings, making it into a principal homogeneous space for the group $G/\text{Center}(G)$. In particular any two pinnings for G are conjugate in G .

There is a unique involutive antiautomorphism $\Psi : G \rightarrow G$ such that for all $i \in I$ and $t \in H$ one has $\Psi(x_i(a)) = y_i(a)$, $\Psi(y_i(a)) = x_i(a)$ and $\Psi(t) = t$.

Example. If $G = SL_m$ then B^+, B^- are the subgroups of upper and lower triangular matrices, so H is the subgroup of diagonal matrices. Ψ is the transposition. If $G = PSL(V)$ where V is a vector space then a choice of pinning is the same thing as a choice of a projective basis in V .

Let $X^*(T)$ and $X_*(T)$ be the groups of characters $T \rightarrow \mathbf{G}_m$ and cocharacters $\mathbf{G}_m \rightarrow T$ for a split torus T . There is a pairing

$$\langle \cdot, \cdot \rangle : X^*(T) \times X_*(T) \rightarrow \mathbf{Z}, \quad \chi' \circ \chi : \mathbf{G}_m \rightarrow \mathbf{G}_m, t \mapsto t^{\langle \chi', \chi \rangle}.$$

Let $A = (a_{ij})$ be the Cartan matrix given by $a_{ij} := \langle \chi'_j, \chi_i \rangle$. Recall the weight lattice $P \subset X^*(H)$. It is the subgroup of all $\gamma \in X^*(H)$ such that $\langle \gamma, \chi_i \rangle \in \mathbf{Z}$ for all $i \in [1, \dots, r]$. Let $\{\omega_1, \dots, \omega_r\}$ be the \mathbf{Z} -basis of fundamental weights given by $\langle \omega_j, \chi_i \rangle = \delta_{ij}$.

3. The element s_G . A choice of pinning for G provides an inclusion of the Cartan group H into G . Abusing notation we will denote the obtained subgroup by H and call it the Cartan subgroup corresponding to the pair (B^-, B^+) of opposite Borel subgroups. Then the element

$$\bar{s}_i := y_i(1)x_i(-1)y_i(1) = \varphi_i \begin{pmatrix} 0 & -1 \\ 1 & 0 \end{pmatrix}$$

lifts to $\text{Norm}_G(H)$ the generator $s_i := s_{\chi_i} \in W$. It is well known that the elements \bar{s}_i , $i \in I$, satisfy the braid relations. Therefore we can associate to each $w \in W$ its standard representative $\bar{w} \in \text{Norm}_G(H)$ in such a way that for any reduced decomposition $w = s_{i_1} \dots s_{i_k}$ one has $\bar{w} = \bar{s}_{i_1} \dots \bar{s}_{i_k}$. Let w_0 be the maximal length element of W . We set $s_G := \bar{w}_0^2$. Then evidently $s_G^2 = e$.

Example. If $G = SL_m$ then $s_{SL_m} = (-1)^{m-1}e$.

Let R be the system of roots for the group G , and $R = R_+ \cup R_-$ its decomposition into a union of the sets of positive and negative roots. Then for any element $w \in W$ its length $l(w)$ equals to $|R_- \cap w(R_+)|$. For any root $\alpha = \sum n_i \alpha_i$, where $\{\alpha_i\}$ is the set of positive simple roots, we set $\chi_\alpha(t) := \prod \chi_i(t)^{n_i}$.

2.1. Lemma. — *Let $w \in W$. Then*

$$\overline{w w^{-1}} = \prod_{\alpha \in R_- \cap w(R_+)} \chi_\alpha(-1).$$

Proof. By induction on the length $l(w)$. If $l(w) = 1$ this is clear. Assume $w = w_i w'$ where $l(w') = l(w) - 1$. Then by the induction assumption

$$\begin{aligned} \overline{w w^{-1}} &= \overline{w_i w' w'^{-1} w_i^{-1}} = \left[w_i \left(\prod_{\alpha \in R_- \cap w'(R_+)} \chi_\alpha(-1) \right) w_i^{-1} \right] \overline{w_i w_i^{-1}} = \\ &= \prod_{\alpha \in R_- \cap w'(R_+)} \chi_{w_i(\alpha)}(-1) \chi_{\alpha_i}(-1). \end{aligned}$$

Since $w_i(R_- \cap w'(R_+)) \cup -\alpha_i = R_- \cap w(R_+)$, the lemma is proved.

2.1. Corollary. — *s_G is a central element of G of order 2.*

Proof. Let 2ρ be the sum of all positive roots. Then (see Proposition 29, Chapter VI, paragraph 1 in [Bo]) we have $\rho = \omega_1 + \dots + \omega_r$. Denote by $\chi'_{2\rho}$ the character of H corresponding to 2ρ . Then for any coroot χ one has $\langle \chi'_{2\rho}, \chi \rangle \in 2\mathbf{Z}$. Since $w_0^{-1} = w_0$, this combined with Lemma 2.1 implies that s_G commutes with the elements $x_i(t)$, and thus is a central element. The corollary is proved.

There is a well defined up to conjugation embedding $p : SL_2 \hookrightarrow G$, called the principal SL_2 subgroup of G . Its Lie algebra is described as follows. If we choose a pinning in G , the image of the element $\begin{pmatrix} 0 & 1 \\ 0 & 0 \end{pmatrix}$ (resp.

$\begin{pmatrix} 0 & 0 \\ 1 & 0 \end{pmatrix}$) of sl_2 under the differential of the map p is $\sum_{i \in I} e_i$ (resp. $\sum_{i \in I} f_i$), where e_i (resp. f_i) is the generator of $\text{Lie}(U)$ (resp. $\text{Lie}(U^-)$) corresponding to a simple root parametrised by $i \in I$.

2.2. Lemma. — $s_G = p(s_{SL_2})$ for the principal SL_2 subgroup of G .

Proof. An easy exercise.

4. The moduli spaces $\mathcal{A}_{G, \hat{S}}$. Let us choose a maximal unipotent subgroup U in G . The normalizer of U in G is a Borel subgroup B . Conversely, U is the commutant of B . The Cartan group H acts from the right on the principal affine variety $\mathcal{A} := G/U$: if $A = gU \in \mathcal{A}$ we set

$$A \cdot h = gU \cdot h := gi_B(h)U \quad (2.6)$$

Since H is commutative it, of course, can be considered as a left action. This action is free. The quotient \mathcal{A}/H is identified with the flag variety $\mathcal{B} = G/B$. The canonical projection $\mathcal{A} \rightarrow \mathcal{B}$ is a principal H -bundle. More generally, let X be a right principal homogeneous space for G . Then X/U is an $\text{Aut}X$ -homogeneous space. Recall the *principal affine bundle* $\mathcal{L}_{\mathcal{A}} := \mathcal{L}/U$ associated to a G -local system \mathcal{L} on S .

Let T'_S be the punctured tangent bundle to the surface S , i.e. the tangent bundle with the zero section removed. Its fundamental group $\pi_1(T'_S, x)$ is a central extension of $\pi_1(S, y)$ by \mathbf{Z} , where $x \in T'_y S$:

$$0 \longrightarrow \mathbf{Z} \longrightarrow \pi_1(T'_S, x) \longrightarrow \pi_1(S, y) \longrightarrow 0. \quad (2.7)$$

Let $T'_y S$ be the punctured tangent space at a point y . The inclusion $T'_y S \hookrightarrow T'_S$ induces an isomorphism of $\pi_1(T'_y S) \cong \mathbf{Z}$ with the central subgroup \mathbf{Z} in (2.7). We denote by σ_S a generator of this central subgroup. It is well defined up to sign.

2.3. Definition. — *A twisted G -local system on S is a local system on T'_S with the monodromy s_G around σ_S .*

Observe that since s_G is of order two, this does not depend on the choice of the generator σ_S .

Let $\bar{\pi}_1(S, y)$ be the quotient of $\pi_1(S, y)$ by the central subgroup $2\mathbf{Z} \subset \mathbf{Z}$, so it is a central extension

$$0 \longrightarrow \mathbf{Z}/2\mathbf{Z} \longrightarrow \bar{\pi}_1(T'_S, x) \longrightarrow \pi_1(S, y) \longrightarrow 0.$$

We denote by $\bar{\sigma}_S$ the order two central element in the subgroup $\mathbf{Z}/2\mathbf{Z}$. The twisted local systems on S are in bijective correspondence with the representations $\rho : \bar{\pi}_1(T'S, x) \rightarrow G$, considered modulo conjugation, such that $\rho(\bar{\sigma}_S) = s_G$.

Remark. Let us choose a complex structure on S . Then the uniformisation provides an embedding $i : \pi_1(S, y) \hookrightarrow PSL_2(\mathbf{R})$. It is easy to see that the group $\bar{\pi}_1(T'S, x)$ is isomorphic to the preimage of the subgroup $i(\pi_1(S, y))$ in $SL_2(\mathbf{R})$. In particular $\bar{\sigma}_S$ corresponds to the element $-e \in SL_2(\mathbf{R})$.

The group $\bar{\pi}_1(T'S, x)$ is isomorphic to the direct product $\mathbf{Z}/2\mathbf{Z} \times \pi_1(S, y)$, although this isomorphism is by no means canonical. The set of all isomorphisms

$$\bar{\pi}_1(T'S, x) \longrightarrow \mathbf{Z}/2\mathbf{Z} \times \pi_1(S, y)$$

which send the central subgroup $\mathbf{Z}/2\mathbf{Z}$ on the left to the left factor on the right, and reduce to the canonical isomorphism modulo the $\mathbf{Z}/2\mathbf{Z}$ -subgroups, is a principal homogeneous space over $\text{Hom}(\pi_1(S, y), \mathbf{Z}/2\mathbf{Z})$. Therefore choosing such an isomorphism we can identify the space of twisted G -local systems on S with the space of G -local systems on S . Observe that a choice of such an isomorphism is the same thing as a choice of a spin structure on S .

Let \mathbf{C}_i be a little annulus containing a boundary component C_i of S as a component of its boundary. Observe that $\pi_1(T'\mathbf{C}_i)$ is canonically identified with $\mathbf{Z} \times \mathbf{Z}$: the first factor is $\pi_1(T'_x\mathbf{C}_i)$, and the second is generated by the tangent vectors to C_i .

Let x_1, \dots, x_p be the marked points on the component C_i . Let us present the annulus \mathbf{C}_i as a product $C_i \times [0, 1]$, and let $\mathbf{C}'_i := (C_i - \{x_1, \dots, x_p\}) \times [0, 1]$. Then \mathbf{C}'_i has p connected components.

2.4. Definition. — *Let G be a split simply-connected reductive group. Let \mathcal{L} be a G -local system on $T'S$ representing a twisted local system on S . A decoration on \mathcal{L} is a choice of locally constant section α of the restriction of the principal affine bundle \mathcal{L}_A to $\cup_i \mathbf{C}'_i$.*

A decorated twisted G -local system on a marked surface \widehat{S} is a pair (\mathcal{L}, α) , where \mathcal{L} is a twisted G -local system on S , and α is a decoration on \mathcal{L} . The space $\mathcal{A}_{G, \widehat{S}}$ is the moduli space of decorated twisted G -local systems on \widehat{S} .

When $s_G = e$ this definition reduces to the one given in the Definition 1.3. Just like in the \mathcal{X} -case, the moduli space $\mathcal{A}_{G, \widehat{S}}$ can be understood as the quotient moduli stack. We leave the obvious details to the reader.

Let $\text{Conf}_n(\mathcal{A}) := G \backslash \mathcal{A}^n$ be the configuration space of n affine flags in G .

2.5. Definition. — *The twisted cyclic shift map $S : \text{Conf}_n(\mathcal{A}) \mapsto \text{Conf}_n(\mathcal{A})$ is given by*

$$S : (A_1, A_2, \dots, A_n) \mapsto (A_2, \dots, A_n, s_G A_1).$$

Since s_G is a central element one has $A \cdot s_G = s_G A$. Therefore $S^n = \text{Id}$ because

$$S^n(A_1, A_2, \dots, A_n) = (s_G A_1, s_G A_2, \dots, s_G A_n) \sim (A_1, A_2, \dots, A_n).$$

The coinvariants of the twisted cyclic map acting on the space $\text{Conf}_n(\mathcal{A})$ are called *twisted cyclic configurations* of n affine flags in G . Let $\widetilde{\text{Conf}}_n(\mathcal{A})$ be the moduli space of twisted cyclic configurations of n affine flags in G .

2.3. Lemma. — *Let \widehat{D}_k be a disc D with k marked points at the boundary. Then $\mathcal{A}_{G, \widehat{D}_k}$ is identified with the twisted cyclic configuration space $\widetilde{\text{Conf}}_k(\mathcal{A})$.*

Proof. The punctured tangent bundle to a disc is homotopy equivalent to a circle. So there is a unique up to isomorphism twisted G -local system on \widehat{D}_k . Consider a path in $T'D$ obtained by choosing a non zero tangent vector field on a simple loop near the boundary of D . The monodromy around this path is s_G . The marked points x_1, \dots, x_k on the boundary $C = \partial D$ divide C into a union of the arcs C_1^*, \dots, C_k^* . We assume they follow the boundary clockwise. Let us choose a vector v_i tangent to D at a certain point of the arc C_i^* . We assume that the vectors v_i look inside of the disc D . For each vector v_i there is a canonical homotopy class of paths from v_i to v_1 in $T'D$ obtained by counterclockwise transport of v_i along C towards v_1 . Restricting the decoration section α to v_1, \dots, v_k and then translating the obtained affine flags in the fibers over v_2, \dots, v_k to the fiber over v_1 we get a configuration of affine flags (A_1, \dots, A_k) over v_1 . If we choose v_2 instead of v_1 as the initial vector, this configuration will be replaced by its twisted cyclic shift $(A_2, \dots, A_k, s_G A_1)$. So we identified $\mathcal{A}_{G, \widehat{D}_k}$ with $\widetilde{\text{Conf}}_k^*(\mathcal{A})$. The lemma is proved.

Recall the adjoint group G' corresponding to the group G . Since the canonical map $G \rightarrow G'$ kills the center, and s_G is in the center, a twisted G -local system \mathcal{L} on $T'S$ provides a G' -local system \mathcal{L}' on S . The canonical projection $p : \mathcal{L}_A \rightarrow \mathcal{L}'_B$ provides a map

$$p : \mathcal{A}_{G, \widehat{S}} \rightarrow \mathcal{X}_{G', \widehat{S}}, \quad (\mathcal{L}, \alpha) \mapsto (\mathcal{L}', \beta), \quad \beta := p(\alpha). \quad (2.8)$$

2.4. Lemma. — *Let k be the number of boundary points. Then*
 $\dim \mathcal{X}_{G', \widehat{S}} + k \cdot \dim H = \dim \mathcal{A}_{G, \widehat{S}}.$

If $k = 0$, one has $\dim \mathcal{X}_{G', S} = \dim \mathcal{A}_{G, S} = \dim \mathcal{L}_{G, S} = (2g + n - 2) \dim G.$

Proof. The map (2.3) is surjective over the generic point. Consider a boundary component C_i without boundary points. The condition that a G -local system has unipotent monodromy around C_i decreases the dimension by $\text{rank}(G)$, while adding a decoration at the puncture s we increase the dimension by $\dim H = \text{rank}(G)$. On the other hand over an arc the space of α 's is G/U , while the space of β 's is G/B . The lemma is proved.

5. Remarks, complements and examples. 1. If $\widehat{S} = S$, i.e. there is no boundary points, it may be convenient to assume that $S = \overline{S} - \{s_1, \dots, s_n\}$ is a surface with n punctures. For each punctures there is a well defined isotopy class of a little oriented circle making a simple counterclockwise loop around s . Let \mathcal{L}_s be the isomorphism class of the restriction of a G -local system \mathcal{L} to it. A framed G -local system on S is then a G -local system \mathcal{L} equipped with the following additional structure: for every puncture s we choose a reduction of the local system \mathcal{L}_s to the Borel subgroup B .

One can always avoid talking about holes D_i in \overline{S} . Indeed, let S be a surface with n punctures. Denote by $\text{Sp}_{s_i} \mathcal{L}$ the specialization of the local system \mathcal{L} to the punctured tangent space $T_{s_i} \overline{S} - \{0\}$ at s_i . It is a local system on the punctured tangent space. The marked points are replaced by a collection of distinct rays in the punctured tangent bundle $T_{s_i} \overline{S} - \{0\}$. A framed structure on \mathcal{L} is given by the following data at the punctures s_i : restrict the local system $\text{Sp}_{s_i} \mathcal{L}$ to the complement of the chosen rays, and take its flat section β . This language is convenient when we work with an algebraic structure on S .

2. Let us look more closely at the projection (2.8) in the case when $\widehat{S} = S$. The monodromy of a G -local system on a circle is described by a conjugacy class in G . The monodromy provides a bijective correspondence between the conjugacy classes in G and the isomorphism classes of G -local systems on a circle. A G -local system \mathcal{L} on S is *unipotent* if for every boundary component C_i the monodromy of the restriction of \mathcal{L} to C_i is unipotent.

2.6. Definition. — $\mathcal{U}_{G, S}$ is the moduli space of the framed unipotent G -local systems on S .

Observe that a B -local system \mathcal{L}_s on a circle has a unipotent monodromy if and only if it can be reduced to a U -local system. A decoration

on \mathcal{L}_s is the same as a reduction of the structure group to the subgroup U . So a decoration on a B -local system \mathcal{L}_s on a circle exists if and only if \mathcal{L}_s is unipotent. Thus a decorated G -local system on S is unipotent. The right action of H on \mathcal{L}_s provides an action of H on the set of all decorations, making it into a principal homogeneous space over H .

Therefore forgetting the decoration we get a canonical projection

$$p' : \mathcal{A}_{G,S} \longrightarrow \mathcal{U}_{G,S}. \quad (2.9)$$

It provides $\mathcal{A}_{G,S}$ with a structure of a principal $H_G^{\{\text{punctures}\}}$ -bundle over $\mathcal{U}_{G,S}$, where H_G is the Cartan group of G . Observe that the map κ is the projection onto the group $H_{G'}^{\{\text{punctures}\}}$. There is a commutative diagram, where i is the natural closed embedding:

$$\begin{array}{ccc} \mathcal{A}_{G,S} & & \\ p' \downarrow \searrow p & & \\ \mathcal{U}_{G',S} & \xrightarrow{i} & \mathcal{X}_{G',S} \xrightarrow{\kappa} H_{G'}^{\{\text{punctures}\}}. \end{array} \quad (2.10)$$

One has $\mathcal{U}_{G',S} = p(\mathcal{A}_{G,S}) = \kappa^{-1}(e)$.

3. *Affine flags.* The points of \mathcal{L}_B parametrize the flags in the fibers of \mathcal{L} . In many cases, e.g. when the center of G is trivial, there is a similar interpretation of the principal affine bundle based on the notion of an affine flag.

Let A be a direct sum of one dimensional H -modules corresponding to all simple roots. Let \mathcal{U} be the Lie algebra of U . The H -module $\mathcal{U}/[\mathcal{U}, \mathcal{U}]$ is isomorphic to A .

2.7. Definition. — *Suppose that the center of G is trivial. An affine flag is a pair*

$$\{B, i : A \xrightarrow{\sim} \mathcal{U}/[\mathcal{U}, \mathcal{U}]\} \quad (2.11)$$

where B is the Borel subgroup containing U , and i is an isomorphism of H -modules.

The group G acts by conjugation on affine flags. This action is transitive. Since the center of G is trivial, the stabilizer of the affine flag (2.11) is U . So the principal affine bundle parametrises the affine flags in the fibers of \mathcal{L} . The same conclusion can be made for the classical groups with non trivial center. Here are some examples.

The classical affine flags. i). $G = GL_m$. Recall that an affine flag in a vector space V is given by a flag (2.1) in V plus a choice of non zero vectors v_i at each quotient V_i/V_{i-1} for all $i = 1, \dots, m$. Equivalently, an affine flag in V can be defined by a sequence of non zero volume elements $\eta_i \in \det V_i$:

$$\eta_1 := v_1, \quad \eta_2 := v_1 \wedge v_2, \quad \dots, \quad \eta_m := v_1 \wedge \dots \wedge v_m.$$

Alternatively, consider the dual volume forms $\omega_i \in \det V_i^*$, $\langle \eta_i, \omega_i \rangle = 1$. We may parametrise the affine flags by the sequence of volume forms $(\omega_1, \dots, \omega_m)$. The variety of all affine flags is identified with GL_m/U where U is the subgroup of upper triangular matrices in GL_m with units at the diagonal.

ii). *The SL_m case.* An affine flag in V determines a volume form in V . By an affine flag in a vector space with a given volume form ω we understand an affine flag whose volume form is the form ω . The variety all affine flags with a given volume form is identified with SL_m/U .

Example. An affine flag in a two dimensional vector space V is a pair {a non zero vector v_1 and a non zero 2-form ω in V }. The variety of all affine flags in a two dimensional symplectic vector space is identified with $\mathbf{A}^2 - \{0\}$.

3. Surfaces, graphs, mapping class groups and groupoids

This Section contains some background material, suitably adopted or generalized. We start from the ribbon graphs and their generalizations needed to describe two dimensional surfaces with marked points on the boundary. We use it throughout the paper. Then we introduce a convenient combinatorial model of the classifying orbi-space for mapping class groups which will be used in Section 15. In the end we recall some basic facts about the classical Teichmüller spaces which will be used in Section 12 and some other parts of the paper.

1. Ribbon graphs and hyperbolic surfaces. Recall that a *flag* of a graph Γ is a pair (v, E) where v is a vertex of Γ , E is an edge of Γ , and v is an endpoint of E . A *ribbon graph* is a finite graph such that for each vertex a cyclic order of the set of all flags sharing this vertex is chosen. An example of a ribbon graph is provided by a graph drawn on an oriented surface S . The cyclic order of the flags sharing the same vertex is given by the counterclockwise ordering of the flags.

We say that an oriented path on a ribbon graph *turns left* at a vertex if we come to the vertex along the edge which is next (with respect to the

cyclic order) to the edge used to get out of the vertex. A *face path* on a ribbon graph is a closed oriented path turning left at each vertex, which ends as soon as the path starts to repeat itself. To visualize a face path imagine a ribbon graph glued of actual thin ribbons. Then a face path is a boundary component of such a ribbon graph. For example the punctured torus has one face path. A flag determines a face path. This face path can be visualized by a strip bounded by the face path. Conversely a face path plus a vertex (resp. edge) on this path determine uniquely the flag containing this vertex (resp. edge) situated on the face path.

Given a ribbon graph Γ we can get an oriented compact surface $S_{\Gamma,c}$ with a ribbon graph isomorphic to Γ lying on the surface. Namely, we take a disc for each of the face paths and glue its boundary to the graph along the face path. If we use punctured discs in the above construction we get an oriented surface S_{Γ} which can be obviously retracted onto Γ . Clearly S_{Γ} is obtained by making n punctures on $S_{\Gamma,c}$, where $n = F(\Gamma)$. Any surface with negative Euler characteristic can be obtained as S_{Γ} for certain ribbon graph Γ . Indeed, consider a triangulation of the surface with the vertices at the punctures, and take the dual graph.

2. Ideal triangulations of marked hyperbolic surfaces and marked trivalent graph. Let \widehat{S} be a marked hyperbolic surface. If its boundary component C_i has no boundary points on it, let us picture the corresponding hole on S as a puncture.

A *marked trivalent graphs on S of type \widehat{S}* is a graph Γ on S with the following properties:

- i) The vertices of Γ are of valence three or one.
- ii) The set of univalent vertices coincides with the set of marked points on the boundary ∂S .
- iii) The surface S can be shrunk onto Γ .

We define an *ideal triangulation* of \widehat{S} as a triangulation of S with the vertices either at the punctures or at the boundary arcs, such that each arc carries exactly one vertex of the triangulation, and each puncture serves as a vertex. The edges of an ideal triangulation either lie inside of S , or belong to the boundary of S .

The duality between triangulations and trivalent graphs provides a bijection between the isotopy classes of ideal triangulations of \widehat{S} and isotopy classes of marked trivalent graphs on \widehat{S} . The ends of the dual graph are dual to the boundary edges of the ideal triangulation.

A *marked ribbon graph* is a graph with trivalent and univalent vertices equipped with a cyclic order of the edges sharing each trivalent vertex. Given a marked ribbon graph one can construct the corresponding marked surface.

Consider a marked graph $(\bar{\Gamma}, v)$ which has just one 4-valent vertex in addition to trivalent and univalent vertices. Then there are two marked trivalent graphs Γ and Γ' related to $(\bar{\Gamma})$, as shown on the picture. We say that Γ' is obtained from Γ by a flip at the edge E shrunk to v . A similar operation on triangulations consists of changing an edge in a 4-gon of the triangulation. It is well known that any two isotopy classes of marked trivalent graphs on a surface are related by a sequence of flips. Indeed, here is an argument, which assumes for simplicity that there are no marked points. Then, presenting the surface as a $4g$ -gon with glued sides, we reduce the claim to triangulations of the $4g$ -gon punctured in $n - 1$ points, where it is obvious.

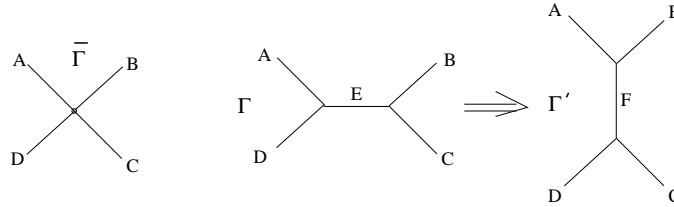

FIG. 3.1. — Flip at the edge E .

3. The mapping class group of S . The mapping class group Γ_S is the quotient of the group of all orientation preserving diffeomorphisms of S modulo its connected component consisting of the diffeomorphisms isotopic to the identity. It has the following well known group theoretic description. Every hole D_i on S provides a conjugacy class in the fundamental group $\pi_1(S, x)$. The mapping class group Γ_S consists of all outer automorphisms of $\pi_1(S, x)$ preserving each of these conjugacy classes. The group Γ_S acts by automorphisms of the \mathcal{A} and \mathcal{X} moduli spaces. We will use a combinatorial description of the mapping class group as the automorphism group of objects of the *modular groupoid* of S defined below.

4. The graph complex $G_\bullet(S)$ of a hyperbolic surface S . It is a version of the complex used by Boardman and Kontsevich [Ko]. To define it, recall the $\mathbf{Z}/2\mathbf{Z}$ -torsor Or_Γ of orientations of a graph Γ , given by invertible elements in the determinant of the free abelian group generated by the edges of Γ . Let $G_k(S)$ be the abelian group of \mathbf{Z} -valued functions $\varphi(\Gamma, \varepsilon_\Gamma)$ with finite support on the set of pairs $(\Gamma, \varepsilon_\Gamma)$, where Γ is an isotopy class of an

embedded graph on S such that S can be retracted to it, $\varepsilon_\Gamma \in \text{Or}_\Gamma$, one has $\varphi(\Gamma, -\varepsilon_\Gamma) = -\varphi(\Gamma, \varepsilon_\Gamma)$, and k is given by

$$k - 3 = \sum_{v \in V(\Gamma)} (\text{val}(v) - 3). \quad (3.1)$$

Here $\text{val}(v)$ is the valency of a vertex v of Γ . Observe that if all except one vertex of Γ are of valency three, then k is the valency of this one vertex. The differential $\partial : G_\bullet(S) \rightarrow G_{\bullet-1}(S)$ is provided by contraction of the edges of Γ :

$$\partial\varphi(\Gamma, \varepsilon_\Gamma) := \sum_{E', \Gamma'} \varphi(\Gamma', \varepsilon_{\Gamma'}). \quad (3.2)$$

Here the sum is over all pairs (E', Γ') , where E' is an edge of Γ' , such that the ribbon graph Γ'/E' obtained by shrinking of E' is isomorphic Γ , and $\varepsilon_{\Gamma'} = E' \wedge \varepsilon_\Gamma$. Then $\partial^2 = 0$. We place the trivalent graphs in the degree 3, and consider $G_\bullet(S)$ as a homological complex.

This normalisation will be useful in Section 14. In this Section we will use the shifted complex $G_\bullet(S)[3]$, where the trivalent graphs are in degree 0. The shifted graph complex $G_\bullet(S)[3]$ is the chain complex of a finite dimensional contractible polyhedral complex $\mathbf{G}(S)$, called the *modular complex* of S , constructed in the next subsection.

5. The modular complex of S . Recall the n -dimensional Stasheff polytope K_n . It is a convex polytope whose combinatorial structure is described as follows. Consider plane trees with internal vertices of valencies ≥ 3 , and with $n+3$ ends lying on an oriented circle. The ends are marked by the set $\{1, \dots, n+3\}$, so that its natural order is compatible with the circle orientation. The codimension p faces of K_n are parametrized by the isotopy classes of such plane trees with $p+1$ internal vertices. Let F_T be the face corresponding to a tree T . Then F_T belongs to the boundary of $F_{\bar{T}}$ if and only if \bar{T} is obtained from T by shrinking some internal edges. The Stasheff polytope K_n can be realized as a cell in the configuration space of $n+3$ cyclically ordered points on a circle, see [GM] for a survey.

Example. K_0 is a point, K_1 is a line segment, and K_2 is a pentagon.

Let us define a finite dimensional contractible polyhedral complex $\mathbf{G}(S)$, called the modular complex of S . The faces of the modular complex $\mathbf{G}(S)$ are parametrized by the isotopy classes of graphs Γ on S , homotopy equivalent to S . The polyhedron P_Γ corresponding to Γ is a product of the Stasheff polytopes:

$$P_\Gamma := \prod_{v \in V(\Gamma)} K_{\text{val}(v)-3}. \quad (3.3)$$

Here $V(\Gamma)$ is the set of vertices of Γ , and $\text{val}(v)$ is the valency of a vertex v . The face P_Γ is at the boundary of the face $P_{\overline{\Gamma}}$ if and only if $\overline{\Gamma}$ is obtained from Γ by shrinking of some edges. Precisely, the inclusion $P_\Gamma \hookrightarrow P_{\overline{\Gamma}}$ is provided by the same data for the Stasheff polytopes appearing in (3.3). The mapping class group Γ_S acts on $\mathbf{G}(S)$ preserving the polyhedral structure.

Examples. 1. The vertices of $\mathbf{G}(S)$ correspond to the isotopy classes of the trivalent graphs on S . The edges – to the graphs with one 4-valent vertex. The two dimensional faces are either pentagons corresponding to graphs with a unique 5-valent vertex, or squares corresponding to graphs with two 4-valent vertices.

2. Let S be a torus punctured at a single point. The mapping class group of S is isomorphic to $SL_2(\mathbf{Z})$. Then $\mathbf{G}(S)$ is the tree dual to the classical modular triangulation of the hyperbolic plane:

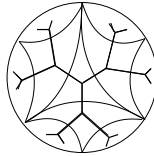

FIG. 3.2. — The tree dual to the modular triangulation.

3.1. Proposition. — *The shifted graph complex $G_\bullet(S)[3]$ is the chain complex of the modular complex $\mathbf{G}(S)$.*

Proof. The faces of the modular complex are glued according to the boundary map (3.2). An orientation ε_Γ of Γ provides an orientation of the face $P(\Gamma)$. The lemma now follows from the very definition.

3.2. Proposition. — *The polyhedral complex $\mathbf{G}(S)$ is contractible. The stabilisers of the mapping class group acting on $\mathbf{G}(S)$ are finite.*

The proof is deduced from Strebel’s theory of quadratic differentials on Riemann surfaces [Str], see also [Ha]. One can show that there exists a Γ_S -equivariant contraction of the Teichmüller space to the modular complex of S . So the modular complex is a ”combinatorial version” of the Teichmüller space.

6. Modular groupoid and combinatorial description of the mapping class group. The quotient $\mathbf{G}(S)/\Gamma_S$ is a polyhedral orbifold. By proposition 3.2 its orbifold fundamental group is isomorphic to Γ_S . The *modular*

groupoid of S is a combinatorial version of the Poincaré groupoid of this orbifold. Precisely, the objects of the modular groupoid of S are Γ_S -orbits of the vertices of the modular complex $\mathbf{G}(S)$, i.e. isomorphism classes of the trivalent ribbon graphs of type S . The morphisms are represented by paths on the 1-skeleton composed with the graph automorphisms, i.e. the elements of Γ_S stabilizing the vertices. The two paths represent the same morphism if and only if they are homotopic in the 2-skeleton $\mathbf{G}_{\leq 2}(S)/\Gamma_S$.

Here is a description of the modular groupoid by generators and relations. Recall the flip determined by an oriented edge of the modular complex, see Figure 3.1. Every morphism in the modular groupoid is a composition of the elementary ones, given by flips and graph symmetries. There are two types of relations between the elementary morphisms provided by the two types of the two dimensional faces of $\mathbf{G}(S)$:

- i) (*Square*). The flips performed at two disjoint edges commute.
- ii) (*Pentagon*). The composition of the five flips corresponding to the (oriented) boundary of a pentagonal face of $\mathbf{G}(S)$ is zero.

They together with the graph symmetries generate all the relations between the morphisms in the modular groupoid.

7. Background on the Teichmüller spaces. The classical Teichmüller space \mathcal{T}_S for a hyperbolic surface S can be defined as the moduli space of any of the following four different objects related to S :

- 1) Complex structures on S .
- 2) Faithful representations $\pi_1(S) \rightarrow PSL_2(\mathbf{R})$ with discrete image, modulo $PSL_2(\mathbf{R})$ -conjugation.
- 3) Complete Riemannian metrics on $\text{int}(S)$ of curvature -1 , called *complete hyperbolic metrics*.
- 4) Hyperbolic metrics on S with geodesic boundary ∂S or a cusp.

Indeed, the uniformisation theorem implies 1) \iff 2). Taking the quotient of the hyperbolic plane \mathcal{H} by the action of the image of $\pi_1(S)$ in $PSL_2(\mathbf{R})$ we go from 2) to 3). A Riemannian metric on S provides a complex structure on S , and hence the arrow 3) \implies 1). Taking the universal cover of S we see the equivalence 2) \iff 3). For each hole on a surface S with complete hyperbolic structure there is a unique geodesic, called the *boundary geodesic*, homotopic to the boundary of the hole, except the case when the hole degenerates to a puncture, i.e. the corresponding end of S is a cusp. Cutting out the ends of the surface S along the boundary geodesics we get a surface with geodesic boundary. This leads to the equivalence 3) \iff 4).

The universal cover of a surface S equipped with a hyperbolic metric with geodesic boundary can be realized as the hyperbolic plane minus an in-

finite collection of disjoint discs bounding geodesics. These geodesics project onto the boundary geodesics on S . Precisely, let S' be a surface with complete hyperbolic metric corresponding to S , i.e. $S = S' - T_1 \cup \dots \cup T_n$ where T_i is the tube cut out from S' by the boundary geodesic corresponding to the i -th hole. The preimage of each boundary geodesic is a disjoint collection of geodesics on \mathcal{H} , with the monodromy group Γ acting transitively on it. The tube T_i lifts to a union of discs bounding these geodesics. Cutting out these discs we get a universal cover \mathcal{H}_S of S sitting inside of \mathcal{H} . The boundary of \mathcal{H}_S is the limit set of Γ . If the lengths of the boundary geodesics are non zero, it is a Cantor set.

If the number n of holes is positive, the Teichmüller space \mathcal{T}_S is a manifold with corners. Choosing orientations of all boundary geodesics we get a version of the Teichmüller space denoted \mathcal{T}_S^+ . Forgetting orientations of the geodesics we get a $2^n : 1$ covering $\mathcal{T}_S^+ \rightarrow \mathcal{T}_S$. On the other hand the orientation of S provides canonical orientations of the geodesics, and hence an embedding $\mathcal{T}_S \hookrightarrow \mathcal{T}_S^+$.

8. Special graphs and flips. Recall that a trivalent graph on S is *special* if it contains, as a part, one of the two graphs shown on Figure 3.3 by dotted lines. We call them an eye and a virus. The triangulations dual to

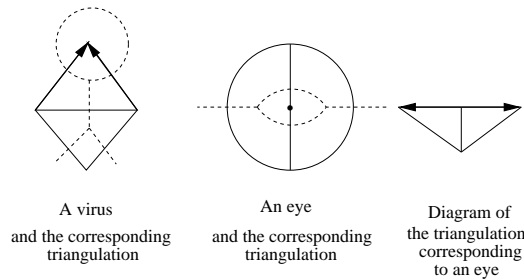

FIG. 3.3. — A virus and an eye, with the corresponding triangulations.

the eye and virus are shown on Figure 3.3 by solid lines. The sides shown by arrows are identified. The triangulations dual to the graphs containing a virus are characterised by the property that they contain a triangle with two sides identified. To obtain a diagram of the triangulation corresponding to an eye we cut one of the edges of the triangulation, the top one on the middle picture, getting the right diagram on Figure 3.3.

Figures 3.4 and 3.5 show that the special graphs can be obtained by flips from the usual graphs. Namely, on Figure 3.4 we obtain an eye by making a flip at the bottom horizontal edge of the graph on the left. The

bottom of Figure 3.5 shows that a flip at the leg of a virus produces an eye, and vice versa. A flip at the loop of a virus is not defined.

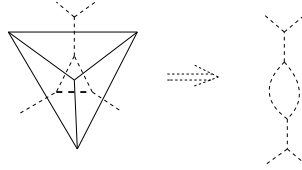

FIG. 3.4. — An eye is obtained by a flip at the bottom edge on the left.

Figure 3.5 shows that a flip from an eye to a virus, lifted to a 2 : 1 cover of the surface ramified at the puncture at the center of the eye, turns out to be a composition of flips at the edges E_1 and E_2 of a regular graph. The edges E_1 and E_2 are the preimage of the edge E . The non-trivial automorphism of the cover is given by the central symmetry. Below we always treat a special triangulation of S by going to a cover of S where the triangulation becomes regular.

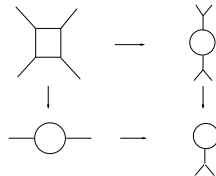

FIG. 3.5. — A flip from an eye to a virus is a folding of a composition of two flips on regular graphs.

Proof of Lemma 1.3. Let S be a surface with a trivalent graph Γ on S , which is homotopy equivalent to S . Let us make a puncture of S , getting a new surface S' . Then adding a virus to Γ as shown on Figure 3.6, we get a trivalent graph Γ' homotopy equivalent to S' . So S' is special. Hence any marked surface with at least two holes, such that the boundary of one of the holes is without marked points, is special. Let us prove the converse claim. A virus separates the surface into two domains, each of them containing a whole. Moreover the one of them surrounded by the head of the virus has no marked points on its boundary. It works the same for an eye. The lemma is proved.

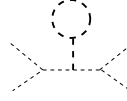

FIG. 3.6. — Adding a virus to a graph.

4. Elements of positive algebraic geometry

1. Semifields and positive varieties. Following [BFZ96], we define a *semifield* as a set P endowed with the operations of addition and multiplication, which have the following properties:

- i) Addition in P is commutative and associative.
- ii) Multiplication makes P an abelian group.
- iii) distributivity: $(a + b)c = ac + bc$ for $a, b, c \in P$.

Here are important examples of semifields:

- a) $P = \mathbf{Q}_{>0} = \{x \in \mathbf{Q} | x > 0\}$,
- b) $P = \mathbf{R}_{>0} = \{x \in \mathbf{R} | x > 0\}$,
- c) Let K be a field and $P \subset K$ a semifield inside of K , with the addition and multiplication in P induced from K , like in the examples a) and b). Then there is a new semifield

$$K((\varepsilon))_P := \{f = a_s \varepsilon^s + a_{s+1} \varepsilon^{s+1} + \dots | a_i \in P\} \subset K((\varepsilon))$$

consisting of all Laurent power series with the leading coefficient from P . For example starting from $\mathbf{Q}_{>0}$ we get a semifield denoted $\mathbf{Q}((\varepsilon))_{>0}$. Similarly one defines $\mathbf{R}((\varepsilon))_{>0}$ starting from $\mathbf{R}_{>0}$.

- d) The tropical semifields: $P = \mathbf{Z}$, $P = \mathbf{Q}$ or $P = \mathbf{R}$ with the multiplication \otimes and addition \oplus given by

$$a \otimes b := a + b, \quad a \oplus b := \max(a, b). \quad (4.1)$$

Observe that in the examples a), b) and c) the semifield P is naturally embedded to a field, while in the example d) this is impossible since $a \oplus a = a$.

4.1. Lemma. — *Assigning to $f \in K((\varepsilon))_P$ the minus degree of its leading coefficient we get a homomorphism of semifields*

$$-\text{deg} : K((\varepsilon))_P \longrightarrow \mathbf{Z}^t.$$

Proof. Clear.

There is a unique way to assign to a split torus H an abelian group $H(P)$ so that $\mathbf{G}_m(P) = P$ and $H \rightarrow H(P)$ is a functor from the category of split algebraic tori to the one of abelian groups. One has $H(\mathbf{Z}^t) = X_*(H)$ and $H(P) = X_*(H) \otimes_{\mathbf{Z}} P$, where P is considered here as an abelian group.

Let Pos be the category whose objects are split algebraic tori and morphisms are positive rational maps. A positive rational map $\varphi : H_1 \rightarrow H_2$ gives rise to a map of sets $\varphi_* : H_1(P) \rightarrow H_2(P)$, providing us a functor $\text{Pos} \rightarrow \text{Sets}$. In particular if φ is invertible in the category Pos then φ_* is an isomorphism. Therefore given a positive variety $(X, \{\psi_\alpha\})$ we get a collection of abelian groups $H_\alpha(P)$ and set isomorphisms $\psi_{\alpha,\beta} : H_\alpha(P) \rightarrow H_\beta(P)$ between them.

Recall the definition of a positive structure on a scheme/stack given in Section 1.3.

4.1. Definition. — *Let P be a semifield and $(X, \{\psi_\alpha\})$ a positive scheme. Then its P -part $X(P)$ is a set whose elements are collections $\{p_\alpha \in H_\alpha(P)\}$ such that $\psi_{\alpha,\beta}(p_\alpha) = p_\beta$ for any $\alpha, \beta \in \mathcal{C}_X$.*

Decomposing H_α into a product of \mathbf{G}_m 's we get an isomorphism

$$\tilde{\varphi}_\alpha : P^{\dim H_\alpha} \xrightarrow{\sim} X(P).$$

The P -part $X(P)$ of X depends only on the positive birational class of X , and compatible positive structures give rise to the same P -part.

If $P = K_{>0}$ is a semifield in a field K we can realize the $K_{>0}$ -part of X inside of the set of K -points of X . Indeed, thanks to the condition i) of definition 1.7 the map ψ_α is regular at $H_\alpha(K_{>0})$. Therefore there is a subset

$$X_{K_{>0}}^+ := \psi_\alpha(H_\alpha(K_{>0})) \hookrightarrow X(K). \quad (4.2)$$

Thanks to the condition ii) of definition 1.7 it does not depend on α .

We say that a positive atlas $(\{\psi'_\alpha\}, \mathcal{C}')$ on X *dominates* another one $(\{\psi_\alpha\}, \mathcal{C})$ if there is an inclusion $i : \mathcal{C} \hookrightarrow \mathcal{C}'$ such that for any $\alpha \in \mathcal{C}$ the coordinate systems $\psi_\alpha : H_\alpha \rightarrow X$ and $\psi'_{i(\alpha)} : H'_{i(\alpha)} \rightarrow X$ are identified. So the positive atlases on X are partially ordered. If two positive atlases \mathcal{C}' and \mathcal{C}'' dominate the same one \mathcal{C} , then there is a new positive atlas $\mathcal{C}' \cup \mathcal{C}''$ dominating all of them. Therefore for a given positive atlas on X there is the *maximal positive atlas* on X dominating it.

Let $(X, \{\psi_\alpha\}, \mathcal{C})$ be a positive scheme. Then $\psi_\alpha(H_\alpha)$ is a Zariski open subset of X . Their union over all $\alpha \in \mathcal{C}$ is a regular Zariski open subset of X . Applying this construction to the maximal positive atlas on X dominating the original one we get a regular Zariski open subset $X^{\text{reg}} = X_{\mathcal{C}}^{\text{reg}} \hookrightarrow X$ called the *regular part* of a positive variety X .

The P -part of X can be defined in a more general set up of positive spaces.

2. A category of positive spaces. Recall that a groupoid is a category where all morphisms are isomorphisms. Below we will assume that the set of isomorphisms between every two objects of a groupoid is non-empty, i.e. all groupoids are connected. Let \mathcal{G} be a connected groupoid and α its object. The *fundamental group* $\Gamma_{\mathcal{G},\alpha}$ of the groupoid \mathcal{G} based at α is the group of automorphisms of the object α . The fundamental groups based at different objects are isomorphic, but the isomorphism is well defined only up to an inner automorphism.

4.2. Definition. — A positive space \mathcal{X} is a pair consisting of a groupoid $\mathcal{G}_{\mathcal{X}}$ and a functor

$$\psi_{\mathcal{X}} : \mathcal{G}_{\mathcal{X}} \longrightarrow \text{Pos}. \quad (4.3)$$

The groupoid $\mathcal{G}_{\mathcal{X}}$ is called the *coordinate groupoid* of the positive space.

Thus for every object α of the coordinate groupoid $\mathcal{G}_{\mathcal{X}}$ there is an algebraic torus H_{α} , and for every morphism $f : \alpha \rightarrow \beta$ in the groupoid there is a positive birational isomorphism $\psi_f : H_{\alpha} \rightarrow H_{\beta}$.

Let \mathcal{X} and \mathcal{Y} be two positive spaces defined via the coordinate groupoids $\mathcal{G}_{\mathcal{X}}$ and $\mathcal{G}_{\mathcal{Y}}$ and functors $\psi_{\mathcal{X}}$ and $\psi_{\mathcal{Y}}$. A morphism $\mathcal{X} \rightarrow \mathcal{Y}$ is given by a functor $\mu_{\mathcal{X},\mathcal{Y}} : \mathcal{G}_{\mathcal{X}} \rightarrow \mathcal{G}_{\mathcal{Y}}$ and a natural transformation of functors $m : \psi_{\mathcal{X}} \rightarrow \psi_{\mathcal{Y}} \circ \mu_{\mathcal{X},\mathcal{Y}}$. A morphism is called a *strict morphism* if for every object $\alpha \in \mathcal{G}_{\mathcal{X}}$ the map $m_{\alpha} : \psi_{\mathcal{X}}(\alpha) \rightarrow \psi_{\mathcal{Y}} \circ \mu_{\mathcal{X},\mathcal{Y}}(\alpha)$ is a homomorphism of algebraic tori.

Given a semifield P and a positive space \mathcal{X} defined via (4.3) we get a functor

$$\psi_{\mathcal{X}}^P : \mathcal{G}_{\mathcal{X}} \longrightarrow \text{Sets}, \quad \alpha \longmapsto H_{\alpha}(P), \quad H_{\alpha} := \psi_{\mathcal{X}}(\alpha).$$

It describes the set $\mathcal{X}(P)$ of P -points of \mathcal{X} . The fundamental group of the groupoid $\mathcal{G}_{\mathcal{X}}$ acts on $\mathcal{X}(P)$.

Example 1. A positive variety X provides a functor (4.3) as follows. The fundamental group of the coordinate groupoid $\mathcal{G}_{\mathcal{X}}$ is trivial, so it is just a set. Namely, it is the set parametrising positive coordinate charts of the atlas defining the positive structure of X . The functor $\psi_{\mathcal{X}}$ is given by $\psi_{\mathcal{X}}(\alpha) := H_{\alpha}$ and $\psi_{\mathcal{X}}(\alpha \rightarrow \beta) := \psi_{\alpha,\beta}$.

Example 2. Let X be a Γ -equivariant positive scheme. It provides a positive space \mathcal{X} given by a functor (4.3) such that the fundamental group of the groupoid of $\mathcal{G}_{\mathcal{X}}$ is isomorphic to Γ .

3. The semiring of good positive Laurent polynomials for a positive space \mathcal{X} . Let $T_{i,\alpha}$ be the coordinates on the tori H_{α} . Then $\mathbf{Z}[H_{\alpha}]$ is the ring of Laurent polynomials in $T_{i,\alpha}$. Let us say that a Laurent polynomial F in the variables $T_{i,\alpha}$ is *good* if for every morphism $f : \beta \rightarrow \alpha$ in $\mathcal{G}_{\mathcal{X}}$

the rational function f^*F is a Laurent polynomial in the coordinates $T_{i,\beta}$. Denote by $\mathbf{L}(\mathcal{X})$ the ring of all good Laurent polynomials for \mathcal{X} . We say that F is a *good positive Laurent polynomial* if for every morphism $f : \beta \rightarrow \alpha$ in \mathcal{G}_X the function f^*F is a Laurent polynomial in the coordinates $T_{i,\beta}$ with positive integer coefficients. Denote by $\mathbf{L}_+(\mathcal{X})$ the semiring of good positive Laurent polynomials for \mathcal{X} .

Let $\mathbf{Q}_+(\mathcal{X})$ be the semifield of all positive rational functions for \mathcal{X} . Set $\tilde{\mathbf{L}}_+(\mathcal{X}) = \mathbf{Q}_+(\mathcal{X}) \cap \mathbf{L}(\mathcal{X})$. It contains $\mathbf{L}_+(\mathcal{X})$, but may be bigger, as the following example shows: $x^2 - x + 1 = (x^3 + 1)/(x + 1)$.

The semiring $\mathbf{L}_+(\mathcal{X})$ determines the set of *extremal elements* $\mathbf{E}(\mathcal{X})$, that is the elements which can not be decomposed into a sum of two non zero good positive Laurent polynomials. Any element of $\mathbf{L}_+(\mathcal{X})$ is a linear combination of the extremal elements with non negative integer coefficients.

Remark. If we replace a positive atlas on a scheme X by one dominating it, the set of points of X with values in a semifield P does not change, while the (semi)ring of good (positive) Laurent polynomials can get smaller.

4. The schemes \mathcal{X}^* and \mathcal{X}^{} .** Let $\mathcal{X} = (\psi_{\mathcal{X}}, \mathcal{G}_{\mathcal{X}})$ be a positive space. Let $\Gamma := \Gamma_{\mathcal{X},\alpha}$ be the fundamental group of the groupoid $\mathcal{G}_{\mathcal{X}}$. Below we define two Γ -equivariant positive schemes, $\mathcal{X}^{**} \hookrightarrow \mathcal{X}^*$, corresponding to \mathcal{X} in the sense that \mathcal{X} is the positive space assigned to the positive schemes \mathcal{X}^* and \mathcal{X}^{**} . We start with the scheme \mathcal{X}^* .

4.2. Lemma. — *Let \mathcal{X} be a positive space. Then there exists a unique positive regular Γ -equivariant scheme \mathcal{X}^* corresponding to \mathcal{X} which is "minimal" in the following sense. For any positive regular Γ -equivariant scheme \mathcal{Y} corresponding to \mathcal{X} there exists a unique morphism $\mathcal{X}^* \hookrightarrow \mathcal{Y}$.*

Proof. Let us assume first that the fundamental group of the coordinate groupoid of \mathcal{X} is trivial. Then the scheme \mathcal{X}^* is obtained by gluing the coordinate tori H_{α} according to the birational isomorphisms $\psi_{\alpha,\beta}$. For any field K the set of its K -points is given by collections of elements $p_{\alpha} \in H_{\alpha}(K)$ such that $\psi_{\alpha,\beta}p_{\alpha} = p_{\beta}$. The general case is obtained by considering the universal covering groupoid for $\mathcal{G}_{\mathcal{X}}$. The lemma is proved.

The ring $\mathbf{L}[\mathcal{X}]$ is identified with the ring of global regular functions on \mathcal{X}^* .

Let $\{\psi_{\alpha}^*\}$ be the positive atlas of the scheme \mathcal{X}^* . The scheme \mathcal{X}^{**} is defined as the subscheme of \mathcal{X}^* given by the intersection of all coordinate charts of this atlas:

$$\mathcal{X}^{**} := \bigcap_{\alpha \in \mathcal{C}_{\mathcal{X}}} \text{Im} \psi_{\alpha}^*(H_{\alpha}) \subset \mathcal{X}^*$$

It is a Γ -equivariant positive scheme: the positive atlas for \mathcal{X}^* induces the one for \mathcal{X}^{**} . For any $\alpha \in \mathcal{C}_{\mathcal{X}}$ the scheme \mathcal{X}^{**} is the complement to a possibly infinite collection of positive divisors in the torus H_{α} .

If the fundamental group of the groupoid $\mathcal{G}_{\mathcal{X}}$ is trivial, \mathcal{X}^{**} is characterised by the following universality property. It is the maximal scheme such that for every α there exists a regular open embedding $i_{\alpha} : \mathcal{X}^{**} \hookrightarrow H_{\alpha}$ and $\psi_{\alpha,\beta} i_{\alpha} = i_{\beta}$. Reversing the arrows we arrive at the universality property for the scheme \mathcal{X}^* .

Let $(X, \{\psi_{\alpha}\}, \mathcal{C})$ be a positive regular scheme/stack. Then $X^* = \cup_{\alpha \in \mathcal{C}} \text{Im} \psi_{\alpha}(H_{\alpha})$ and one has $X^{**} \subset X^* \subset X$.

4.3. Lemma. — *Let $(X, \{\psi_{\alpha}\}, \mathcal{C})$ be a positive regular scheme/stack, such that X is noetherian. Then X^* can be covered by a finite collection of the open subsets $\psi_{\alpha}(H_{\alpha})$.*

Proof. Since X is noetherian, any open subset of X is quasi-compact, i.e. any cover by open subsets admits a finite subcover. The subset X^* is open, and covered by the open subsets $\psi_{\alpha}(H_{\alpha})$. Therefore there exists a finite subcover. The lemma is proved.

Therefore for a positive regular noetherian scheme X the ring $\mathbf{L}(X)$ as well as the semiring $\mathbf{L}_+(X)$ are determined by a finite number of conditions.

5. \mathbf{Z} -, \mathbf{Q} - and \mathbf{R} -tropicalizations and the Thurston boundary of a positive space. Let \mathbf{A} be either \mathbf{Z} , or \mathbf{Q} , or \mathbf{R} . Denote by \mathbf{A}^t the corresponding tropical semifield. Then a positive rational map $\varphi : H_1 \rightarrow H_2$ gives rise to a *piecewise-linear* map $\varphi_* : H_1(\mathbf{A}^t) \rightarrow H_2(\mathbf{A}^t)$.

Let \mathcal{X} be a positive space. Then we have the manifold $\mathcal{X}(\mathbf{R}_{>0})$, and the \mathbf{A} -tropicalization $\mathcal{X}(\mathbf{A}^t)$ of \mathcal{X} . They are related as follows. First of all, one has $\mathcal{X}(\mathbf{Z}^t) \hookrightarrow \mathcal{X}(\mathbf{Q}^t) \hookrightarrow \mathcal{X}(\mathbf{R}^t)$. The multiplicative group $\mathbf{A}_{>0}^*$ of positive elements in \mathbf{A} acts by automorphisms of the tropical semifield \mathbf{A}^t . Let us denote by $\{0\}$ the zero element in the abelian group $H(\mathbf{A}^t)$. Let \mathbf{A} be either \mathbf{Q} or \mathbf{R} . Set

$$\mathbf{P}H(\mathbf{A}^t) := \left(H(\mathbf{A}^t) - \{\{0\}\} \right) / \mathbf{A}_{>0}^*.$$

Let $\varphi : H \rightarrow H'$ be a positive rational map. Then the piecewise-linear map $\varphi_* : H(\mathbf{A}^t) \rightarrow H'(\mathbf{A}^t)$ commutes with the multiplication by $\mathbf{A}_{>0}^*$, and $\varphi_*\{0\} = \{0\}$. Thus we get a morphism

$$\bar{\varphi}_* : \mathbf{P}H(\mathbf{A}^t) \longrightarrow \mathbf{P}H'(\mathbf{A}^t).$$

4.3. Definition. — Let \mathcal{X} be a positive space. Let \mathbf{A} be either \mathbf{Q} or \mathbf{R} . The projectivisation $\mathbf{P}\mathcal{X}(\mathbf{A}^t)$ of the \mathbf{A} -tropicalisation of \mathcal{X} is

$$\mathbf{P}\mathcal{X}(\mathbf{A}^t) := \{ \{p_\alpha \in \mathbf{P}H_\alpha(\mathbf{A}^t)\} \mid \overline{\psi}_{\alpha,\beta}(p_\alpha) = p_\beta \text{ for any } \alpha, \beta \in \mathcal{G}_X \}.$$

Observe that $\mathbf{P}H_\alpha(\mathbf{R}^t)$ is a sphere, and the maps $\psi_{\alpha,\beta}$ are piecewise-linear maps of spheres. The set $\mathbf{P}\mathcal{X}(\mathbf{Q}^t)$ is an everywhere dense subset of $\mathbf{P}\mathcal{X}(\mathbf{R}^t)$.

The degree map from Lemma 4.1 provides a map

$$-\text{deg} : \mathcal{X}(\mathbf{R}((\varepsilon))_{>0}) \longrightarrow \mathcal{X}(\mathbf{Z}^t).$$

An $\mathbf{R}((\varepsilon))_{>0}$ -point $x(\varepsilon)$ of \mathcal{X} , considered modulo action of the group of positive reparametrizations of the formal ε -line, i.e. modulo substitutions $\varepsilon = \phi(\varepsilon)$, where $\phi(\varepsilon) \in \mathbf{R}((\varepsilon))_{>0}$, gives rise to a well defined element of $\mathbf{P}\mathcal{X}(\mathbf{Q}^t)$, provided that $\text{deg } x(\varepsilon) \neq \{0\}$. Thus $\mathbf{P}\mathcal{X}(\mathbf{R}^t)$ serves as the Thurston type boundary of $\mathcal{X}(\mathbf{R}_{>0})$.

5. Positive configurations of flags

The first two subsections contain background material about positivity in algebraic semi-simple groups, due to Lusztig, and Fomin and Zelevinsky. The rest of the Section is devoted to a definition and investigation of positive structures on configurations of three and four generic flags in G .

We use throughout the paper the following conventions. The *moduli spaces*, that is stacks, of configurations of flags are denoted by $\text{Conf}(\mathcal{B})$. The corresponding *varieties* of flags in generic position are denoted by $\text{Conf}^*(\mathcal{B})$. If we care only birational structure of the configuration space, we use the simpler notation Conf . We use $\text{Conf}^*(\mathcal{B})$ only when we need it as a variety. Finally, $\text{Conf}^+(\mathcal{B})$ denotes the set of K -positive configurations, which is a subset of the K -points of $\text{Conf}^*(\mathcal{B})$. Similar conventions are used for the configurations of affine flags.

1. A positive regular structure on U and G . We recall some basic results of G. Lusztig [L1], [L2]. The only difference is that we present them as results about existence and properties of regular positive structures on U and G . The proofs in loc.cit. give exactly what we need. However, as explained in Section 5.8, one needs to be careful when relating this point of view with the one used by Lusztig.

Let W be the Weyl group of G . Let $s_i \in W$ be the simple reflection corresponding to x_i, y_i . Let w_0 be the maximal length element in the Weyl

group W , and $w_0 = s_{i_1} \dots s_{i_n}$ its reduced expression into a product of simple reflections. It is encoded by the sequence $\mathbf{i} := \{i_1, \dots, i_n\}$ of simple reflections in the decomposition of w_0 .

5.1. Proposition. — *a) Each reduced expression of w_0 , encoded by \mathbf{i} , provides an open regular embedding*

$$\psi_{\mathbf{i}} : \mathbf{G}_m^n \hookrightarrow U, \quad (a_1, \dots, a_n) \longmapsto x_{i_1}(a_1) \dots x_{i_n}(a_n). \quad (5.1)$$

b) The collection of embeddings $\psi_{\mathbf{i}}$, when \mathbf{i} run through the set of all reduced expression of w_0 , provides a positive structure on U .

c) Replacing x_{i_p} by y_{i_p} in (5.1) we get an open regular embedding $\psi_{\bar{\mathbf{i}}} : \mathbf{G}_m^n \hookrightarrow U^-$, providing a positive regular structure on U^- . The map $\Psi : U^- \rightarrow U$ is a positive regular isomorphism.

Proof. Proposition 2.7 in [L1] and the proof of its part a) prove the proposition.

2. Positive regular structures on double Bruhat cells [FZ99]. The double Bruhat cell corresponding to an element $(u, v) \in W \times W$ is defined by

$$G^{u,v} := BuB \cap B^-vB^-. \quad (5.2)$$

A *double reduced word* for the element $(u, v) \in W \times W$ is a reduced word for an element (u, v) of the Coxeter group $W \times W$. We will use the indices $\bar{1}, \bar{2}, \dots, \bar{r}$ for the simple reflections in the first copy of W , and $1, 2, \dots, r$ for the second copy. Then a double reduced word \mathbf{j} for (u, v) is simply a shuffle of a reduced word for u written in the alphabet $[\bar{1}, \bar{2}, \dots, \bar{r}]$, and a reduced word for v written in the alphabet $[1, 2, \dots, r]$. Recall that $l(u)$ is the length of an element $u \in W$. We set $x_{\bar{i}}(t) := y_i(t)$. The following result is Theorem 1.2 in [FZ99].

5.2. Proposition. — *a) Given a double reduced word $\mathbf{j} = (j_1, \dots, j_{l(u)+l(v)})$ for (u, v) and $0 \leq k \leq l(u) + l(v)$ there is a regular open embedding*

$$x_{\mathbf{j},k} : H \times \mathbf{G}_m^{l(u)+l(v)} \hookrightarrow G^{u,v}$$

$$(h; t_1, \dots, t_{l(u)+l(v)}) \longmapsto x_{i_1}(t_1) \dots x_{i_k}(t_{i_k}) h x_{i_{k+1}}(t_{i_{k+1}}) \dots x_{i_{l(u)+l(v)}}(t_{l(u)+l(v)}).$$

b) The collection of all regular open embeddings $x_{\mathbf{j},k}$ provide a regular positive structure on the double Bruhat cell $G^{u,v}$.

Indeed, if $k = 0$ this is exactly what stated in loc. cit. Moving h we do not change the positive structure since the characters of H are positive by definition. It follows from Proposition 5.2 that $\dim G^{u,v} = r + l(u) + l(v)$.

The generalized minors and double Bruhat cells [FZ99]. Let $\mathbf{i} = (i_1, \dots, i_n)$ be a reduced decomposition of w_0 . Set

$$\bar{s}_i := \varphi_i \begin{pmatrix} 0 & 1 \\ -1 & 0 \end{pmatrix}, \quad \bar{w}_0 := \bar{s}_{i_1} \dots \bar{s}_{i_n}.$$

Then \bar{w}_0 does not depend on choice of a reduced decomposition. Using both reduced decompositions (i_1, \dots, i_n) and (i_n, \dots, i_1) one immediately sees that

$$\bar{w}_0 \bar{w}_0 = e, \quad \bar{w}_0 = s_G \bar{w}_0, \quad \Psi(\bar{w}_0) = \bar{w}_0, \quad \Psi(\bar{w}_0) = \bar{w}_0.$$

Let $G_0 := U^- H U$. Any element $x \in G_0$ admits unique decomposition $x = [x]_- [x]_0 [x]_+$ with $[x]_- \in U_-$, $[x]_0 \in H$, $[x]_+ \in U_+$. Let $i \in [1, \dots, r]$. Then according to [FZ99], the generalized minor $\Delta_{u\omega_i, v\omega_i}$ is the regular function on G whose restriction to the open subset $\bar{u}G_0\bar{v}^{-1}$ is given by

$$\Delta_{u\omega_i, v\omega_i}(x) = \omega_i([\bar{u}^{-1}x\bar{v}]_0). \quad (5.3)$$

It was shown in loc. cit. that it depends only on the weights $u\omega_i, v\omega_j$. For example if $G = SL_{r+1}$ then for permutations $u, v \in S_{r+1}$ the function $\Delta_{u\omega_i, v\omega_i}$ is given by the $i \times i$ minor whose rows (columns) are labeled by the elements of the set $u([1, \dots, i])$ (resp., $v([1, \dots, i])$). Let \mathbf{i} be a reduced decomposition of w_0 and $k \in [1, l(u) + l(v)]$. We set $\varepsilon(i_l) = -1$ if l is from the alphabet $\bar{1}, \dots, \bar{r}$, and $+1$ otherwise. Following ([BFZ03], Section 2.3), we set

$$u_{\leq k} = u_{\leq k}(\mathbf{i}) = \prod_{l=1, \dots, k, \varepsilon(i_l)=-1} s_{|i_l|} \quad (5.4)$$

$$v_{> k} = v_{> k}(\mathbf{i}) = \prod_{l=l(u)+l(v), \dots, k+1, \varepsilon(i_l)=+1} s_{|i_l|} \quad (5.5)$$

where the index l is increasing (decreasing) in (5.4) (resp., (5.5)). For $k \in -[1, \dots, r]$ we set $u_{\leq k} = e$ and $v_{> k} = v^{-1}$. Finally, for $k \in -[1, r] \cup [1, l(u) + l(v)]$, set

$$\Delta(k; \mathbf{i}) := \Delta_{u_{\leq k} \omega_{|i_k|}, v_{> k} \omega_{|i_k|}}. \quad (5.6)$$

Let us set

$$F(\mathbf{i}) = \{\Delta(k; \mathbf{i}) : k \in -[1, r] \cup [1, l(u) + l(v)]\}.$$

Let

$$G^{u,v}(\mathbf{i}) := \{g \in G^{u,v} : \Delta(g) \neq 0 \text{ for all } \Delta \in F(\mathbf{i})\}.$$

The lemma below is a part of Lemma 2.12 in [BFZ03], and follows directly from [FZ99].

5.1. Lemma. — *The map $G^{u,v} \rightarrow \mathbf{A}^{r+l(u)+l(v)}$ given by $g \mapsto (\Delta(g))_{\Delta \in F(\mathbf{i})}$ restricts to an isomorphism*

$$G^{u,v}(\mathbf{i}) \xrightarrow{\sim} \mathbf{G}_m^{r+l(u)+l(v)}. \quad (5.7)$$

Let

$$\Delta_{\mathbf{i}} : \mathbf{G}_m^{r+l(u)+l(v)} \hookrightarrow G^{u,v} \quad (5.8)$$

be the regular open embedding provided by Lemma 5.1. The theorem below is a reformulation of the results in [FZ99].

5.1. Theorem. — *The collection of embeddings $\{\Delta_{\mathbf{i}}\}$, when \mathbf{i} runs through the set of all reduced decompositions of (u,v) , provides a positive regular structure on the double Bruhat cell $G^{u,v}$. It is compatible with the positive regular structure defined in Proposition 5.2.*

3. A positive regular structure on the intersection of two opposite open Schubert cells in \mathcal{B} . Recall the two opposite Borel subgroups B^-, B^+ . They determine the two open Schubert cells \mathcal{B}_- and \mathcal{B}_+ in the flag variety \mathcal{B} , parametrising the Borel subgroups of G in generic position to B^- and B^+ . One has

$$\mathcal{B}_- := \{u_- B^+ u_-^{-1}\}, \quad u_- \in U^-; \quad \mathcal{B}_+ := \{u_+ B^- u_+^{-1}\}, \quad u_+ \in U^+. \quad (5.9)$$

The formula (5.9) provides isomorphisms $\alpha^- : U^- \xrightarrow{\sim} \mathcal{B}_-$, $\alpha^+ : U^+ \xrightarrow{\sim} \mathcal{B}_+$. Let us set

$$\mathcal{B}_* := \mathcal{B}_- \cap \mathcal{B}_+, \quad U_*^+ := U^+ \cap B^- w_0 B^-, \quad U_*^- := U^- \cap B w_0 B.$$

5.2. Lemma. — *a) There are canonical isomorphisms*

$$\alpha_*^+ : U_*^+ \xrightarrow{\sim} \mathcal{B}_*, \quad u_+ \mapsto u_+ B^- u_+^{-1}, \quad \alpha_*^- : U_*^- \xrightarrow{\sim} \mathcal{B}_*, \quad u_- \mapsto u_- B^+ u_-^{-1}.$$

b) $\Psi : U_^- \rightarrow U_*^+$ is an isomorphism.*

Proof. a) The map α_*^+ is evidently injective. Let us check the surjectivity. Given a pair (u_+, u_-) as in (5.9), such that $u_+ B^- u_+^{-1} = u_- B^+ u_-^{-1}$, let us show that $u_- w_0 B^- \cap U^+$ is non empty, and hence is a point. Indeed, conjugating B^- by $u_- w_0 B^-$ we get $u_- B^+ u_-^{-1}$. By the assumption conjugation of B^- by u_+ gives the same result. Thus $u_+ \in u_- w_0 B^-$. The part b) is obvious. The lemma is proved.

Lemma 5.2 implies that there is an isomorphism

$$\phi : U_*^- \xrightarrow{\sim} U_*^+, \quad \phi := (\alpha_*^+)^{-1} \alpha_*^-.$$

5.3. Proposition. — a) For every reduced decomposition \mathbf{i} of w_0 there are regular open embeddings

$$\alpha_*^+ \circ \psi_{\mathbf{i}} : (\mathbf{G}_m)^n \hookrightarrow \mathcal{B}_+; \quad \alpha_*^- \circ \psi_{\bar{\mathbf{i}}} : (\mathbf{G}_m)^n \hookrightarrow \mathcal{B}_-. \quad (5.10)$$

b) The maps $\{\alpha_*^+ \circ \psi_{\mathbf{i}}\}$ provide a positive regular structure on \mathcal{B}_* . Similarly the maps $\{\alpha_*^- \circ \psi_{\bar{\mathbf{i}}}\}$ provide another positive regular structure on \mathcal{B}_* .

c) The map ϕ is positive. Therefore the two positive structures from the part b) are compatible, and thus provide a positive regular structure on \mathcal{B}_* dominating them.

Proof. a) According to Theorem 1.2 in [FZ99] there is a regular open embedding

$$x_{\mathbf{i}} : H \times \mathbf{G}_m^n \rightarrow G^{e, w_0} := B^+ \cap B^- w_0 B^-, \quad x_{\mathbf{i}}(h; t_1, \dots, t_n) := hx_{i_1}(t_1) \cdots x_{i_n}(t_n).$$

Putting $h = e$ we land in $U^+ \cap B^- w_0 B^-$.

b) Follows from Proposition 5.1.

c) In s. 3.2 of [L2] there is an algorithm for computation of a map $\phi' : U^- \rightarrow U^+$, such that

$$uB^+u^{-1} = \phi'(u)B^-\phi'(u)^{-1}, \quad u \in U^-. \quad (5.11)$$

Such a map is unique. It follows from loc. cit. that it is a positive rational map for the positive structures on U^+ and U^- given by Proposition 5.1. Its restriction to U_*^- is our ϕ . The Proposition is proved.

4. A positive regular variety \mathcal{V} . Let \mathcal{V} be the quotient of the affine variety U_* by the action of H :

$$\mathcal{V} := U_*/H := \text{Spec} \mathbf{Q}[U_*]^H. \quad (5.12)$$

Let us define a coordinate system on \mathcal{V} corresponding to a reduced decomposition \mathbf{i} of w_0 . Let $\alpha_1, \dots, \alpha_r$ be the set of all simple roots. Each $i_k \in \mathbf{i}$ is labeled by a simple root, providing a decomposition

$$\mathbf{i} = \mathbf{i}(\alpha_1) \cup \dots \cup \mathbf{i}(\alpha_r).$$

Precisely, $i_j \in \mathbf{i}(\alpha_p)$ if and only if $i_j = p \in I$. Let $l_k := |\mathbf{i}(\alpha_k)|$. So there is a positive regular open embedding

$$\psi_{\mathbf{i}} : \mathbf{G}_m^{\mathbf{i}(\alpha_1)} \times \dots \times \mathbf{G}_m^{\mathbf{i}(\alpha_r)} \hookrightarrow U_*.$$

The group H acts on the factor $\mathbf{G}_m^{\mathbf{i}(\alpha_k)}$ through its character χ'_k . Since the center of G is trivial, there is an isomorphism $(\chi'_1, \dots, \chi'_r) : H \xrightarrow{\sim} \mathbf{G}_m \times \dots \times$

\mathbf{G}_m . So H acts freely on the product. The map $\psi_{\mathbf{i}}$ transforms this action to the action of H on U_* by conjugation. Thus we get a regular open embedding

$$\overline{\psi}_{\mathbf{i}} : \mathbf{G}_m^{\mathbf{i}(\alpha_1)} / \mathbf{G}_m \times \dots \times \mathbf{G}_m^{\mathbf{i}(\alpha_r)} / \mathbf{G}_m \hookrightarrow U_* / H$$

where the group \mathbf{G}_m acts on $\mathbf{G}_m^{\mathbf{i}(\alpha_k)}$ diagonally. Let $a_{\alpha_k,1}, \dots, a_{\alpha_k,l_k}$ be the natural coordinates on $\mathbf{G}_m^{\mathbf{i}(\alpha_k)}$. Then the natural coordinates on its quotient by the diagonal action of \mathbf{G}_m are

$$t_{\alpha_k,j} := \frac{a_{\alpha_k,j+1}}{a_{\alpha_k,j}}, \quad 1 \leq j \leq l_k - 1. \quad (5.13)$$

5.3. Lemma. — *The collection of regular open embeddings $\{\overline{\psi}_{\mathbf{i}}\}$, where \mathbf{i} run through the set of all reduced expressions of w_0 , provides a regular positive structure on \mathcal{V} .*

Proof. Follows immediately from the very definition and Proposition 5.1.

Similarly, replacing U by U^- we get a positive variety \mathcal{V}^- . It is handy to denote \mathcal{V} by \mathcal{V}^+ . The map Ψ evidently commutes with the action of H . It follows from the construction of the map ϕ given in s. 3.2 of [L2] that ϕ also commutes with the action of H . Thus they provide isomorphisms

$$\phi : \mathcal{V}^- \longrightarrow \mathcal{V}^+, \quad \Psi : \mathcal{V}^- \longrightarrow \mathcal{V}^+. \quad (5.14)$$

Abusing the notation we denote them the same way as the original maps.

5.4. Lemma. — *The maps ϕ and Ψ in (5.14) are isomorphisms of positive regular varieties.*

Proof. For Ψ this is clear. For ϕ this follows from Proposition 5.3. The lemma is proved.

5. A positive structure on configurations of triples of flags. We say that a pair of flags is in *generic position* if they are conjugated to the pair (B^+, B^-) , or, equivalently, project to the open G -orbit in $\mathcal{B} \times \mathcal{B}$. Recall that configurations of n -tuples of flags are by definition the G -orbits on \mathcal{B}^n . Denote by \sim the equivalence relation provided by G -orbits. We say that a configuration of flags is *generic* if every two flags of the configuration are in generic position. The moduli space $\text{Conf}_n^*(\mathcal{B})$ of generic configurations of $n > 2$ flags is a variety over \mathbf{Q} . Indeed, a generic configuration can be presented as

$$(B^-, B^+, u_1 B^+ u_1^{-1}, \dots, u_k B^+ u_k^{-1}), \quad u_k \in U_*^-.$$

Thus they are parametrised by a Zariski open part of $(U_*^- \times \dots \times U_*^-)/H$, where there are k factors in the product. The variety $\text{Conf}_n^*(\mathcal{B})$ is a Zariski open part of the stack $\text{Conf}_n(\mathcal{B})$. So the two objects are birationally isomorphic.

Let us define a positive structure on the configuration space $\text{Conf}_3(\mathcal{B})$. Let $\text{pr} : U_*^\pm \rightarrow \mathcal{V}^\pm$ be the canonical projection. Consider a regular open embedding

$$\mathcal{V}^- \hookrightarrow \text{Conf}_3(\mathcal{B}), \quad v \longmapsto (B^-, B^+, vB^+v^{-1}) := (B^-, B^+, uB^+u^{-1}), \quad \text{pr}(u) = v. \quad (5.15)$$

Since H stabilizes the pair (B^-, B^+) , this map does not depend on a choice of $u \in U_*^-$ lifting $v \in \mathcal{V}^-$.

5.1. Definition. — *A positive structure on $\text{Conf}_3(\mathcal{B})$ is defined by the map (5.15) and Lemma 5.3.*

According to Lemma 5.4 the positive structure is compatible with the one given by

$$\mathcal{V}^+ \hookrightarrow \text{Conf}_3(\mathcal{B}), \quad v \longmapsto (B^-, B^+, vB^-v^{-1}) := (B^-, B^+, uB^-u^{-1}), \quad \text{pr}(u) = v. \quad (5.16)$$

Yet another natural positive regular structure on $\text{Conf}_3(\mathcal{B})$ is given by a regular open embedding

$$\mathcal{V}^+ \hookrightarrow \text{Conf}_3(\mathcal{B}), \quad v \longmapsto (B^-, v^{-1}B^-v, B^+). \quad (5.17)$$

Recall that the map Ψ acts on the flag variety \mathcal{B} as well as on the configurations of flags.

5.2. Theorem. — *Let G be a split reductive group with trivial center. Consider a positive atlas on $\text{Conf}_3(\mathcal{B})$ provided by (5.15). Then one has:*

a) The cyclic shift $(B_1, B_2, B_3) \longmapsto (B_2, B_3, B_1)$ is a positive isomorphism on $\text{Conf}_3(\mathcal{B})$. Precisely:

$$(B^-, B^+, uB^-u^{-1}) \sim (B^+, cB^-c^{-1}, B^-), \quad u \in U_*^+, \quad c := (\phi\Psi)^2(u). \quad (5.18)$$

b) $\Psi : (B_1, B_2, B_3) \longmapsto (\Psi B_1, \Psi B_2, \Psi B_3)$ provides a positive isomorphism on $\text{Conf}_3(\mathcal{B})$.

c) The two positive regular structures on $\text{Conf}_3(\mathcal{B})$ given by (5.15) and (5.17) are compatible.

d) The reversing map $(B_1, B_2, B_3) \longmapsto (B_3, B_2, B_1)$ is a positive isomorphism on $\text{Conf}_3(\mathcal{B})$.

So the positive structure on $\text{Conf}_3(\mathcal{B})$ is invariant under the action of the symmetric group S_3 .

Proof. a) Consider a configuration

$$(B^-, B^+, u_+ B^- u_+^{-1}), \quad \text{pr}(u_+) \in \mathcal{V}_+. \quad (5.19)$$

Let us compute the composition $\Psi \circ \Psi$ applied to this configuration. Conjugating (5.19) by u_+^{-1} we get $(u_+^{-1} B^- u_+, B^+, B^-)$. It is, of course, equivalent to the initial configuration (5.19). Then applying Ψ we get

$$(u_- B^+ u_-^{-1}, B^-, B^+), \quad u_- = \Psi(u_+) \in U_*^-, \quad u_+ \in U_*^+. \quad (5.20)$$

According to (5.11) it can be written as

$$(v_+ B^- v_+^{-1}, B^-, B^+) \quad \text{for some } v_+ \in U_*^+, \quad v_+ = \phi\Psi(u_+).$$

Conjugating by v_+^{-1} we get $(B^-, v_+^{-1} B^- v_+, B^+)$. Applying Ψ again we obtain

$$(B^+, v_- B^+ v_-^{-1}, B^-), \quad v_- := \Psi(v_+) \in U_*^-.$$

We can write it as

$$(B^+, c_+ B^- c_+^{-1}, B^-), \quad c_+ := (\phi\Psi)^2(u_+) \in U_*^+.$$

This configuration is the cyclic shift of a configuration (5.19). On the other hand, since $\Psi^2 = \text{Id}$, it coincides with (5.19). It remains to use positivity of the maps ϕ (Proposition 5.3c)) and Ψ . The statement a) is proved.

b) By (5.11) and as ϕ is positive (or by using (5.16)), the configuration (5.20) is a cyclic shift of the configuration (5.19). On the other hand, as the proof of a) shows, it is equivalent to $\Psi(B^-, B^+, u_+ B^- u_+^{-1})$. The cyclic shift is positive by a). The statement b) is proved.

c) Conjugating (5.19) by u_+^{-1} we get $(u_+^{-1} B^- u_+, B^+, B^-)$. Applying the cyclic shift twice and using a) we get c).

d) By the parts c) and a) the following equivalences provide positive maps:

$$(B^-, B^+, u_+ B^- u_+^{-1}) \sim (B^-, v_+^{-1} B^- v_+, B^+) \sim (v_+^{-1} B^- v_+, B^+, B^-).$$

Thus it remains to check that map $(B^+, B^-, v_+^{-1} B^- v_+) \mapsto (B^+, B^-, v_+ B^- v_+^{-1})$ induced by the inversion $v \mapsto v^{-1}$ is a positive map on $\text{Conf}_3(\mathcal{B})$. Although the inversion map is not positive on U , it induces a positive map on the quotient U_*/H . Indeed, inversion changes the order of factors in a reduced decomposition, which amounts to changing the reduced decomposition, and replaces each factor $x_i(t)$ by $x_i(-t)$. However this does not affect the ratios t_i/t_j used to define the positive atlas on U_*/H , and changing a reduced decomposition we get a positive map. The part d) is proved.

The last assertion of the theorem is a corollary of a) and d). The theorem is proved.

6. A positive structure on $\text{Conf}_4(\mathcal{B})$. Consider a triangulation of a convex 4-gon with the flags B_i assigned to its vertices, as on the picture. Choose in addition an orientation of the internal edge, from B_1 to B_3 . Such a data, denoted by \overline{T} , is determined by an ordered configuration of 4 flags (B_1, B_2, B_3, B_4) .

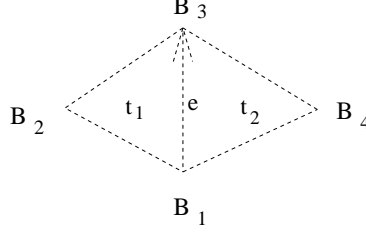

FIG. 5.1. — A triangulated quadrilateral with flags assigned to vertices.

We will employ the following notation for the group action by conjugation on the flag variety:

$$u \cdot B := uBu^{-1}.$$

5.5. Lemma. — *The map*

$$(u_+, u_-) \mapsto (B^-, u_+^{-1} \cdot B^-, B^+, u_- \cdot B^+). \quad (5.21)$$

provides a regular open embedding

$$i_{\overline{T}} : \text{Conf}_4^*(\mathcal{B}) \hookrightarrow (U_*^+ \times U_*^-)/H. \quad (5.22)$$

Proof. Let us identify (B_1, B_3) with the standard pair (B^-, B^+) and choose one of the pinnings related to (B^-, B^+) . Then the element

$$(B_1, B_2, B_3, B_4) \in \text{Conf}_4(\mathcal{B}) \quad (5.23)$$

can be written as the right hand side of (5.21). The action of the group H by conjugation on the pinnings with the given pair (B_1, B_3) is a simple transitive action. So the element (5.23) is described uniquely by an element of $(U_*^- \times U_*^+)/H$. The lemma is proved.

Just like in Section 5.4, there is a positive regular structure on $(U_*^+ \times U_*^-)/H$. Precisely, take a pair of reduced words $(\mathbf{i}_1, \mathbf{i}_2)$ for w_0 . Using \mathbf{i}_1 to define a positive coordinate system on U_*^+ and \mathbf{i}_2 for U_*^- , we get a regular open embedding

$$\overline{\psi}_{(\mathbf{i}_1, \mathbf{i}_2)} : \mathbf{G}_m^{\mathbf{i}_1(\alpha_1) + \mathbf{i}_2(\alpha_1)} / \mathbf{G}_m \times \dots \times \mathbf{G}_m^{\mathbf{i}_1(\alpha_r) + \mathbf{i}_2(\alpha_r)} / \mathbf{G}_m \hookrightarrow (U_*^- \times U_*^+)/H.$$

Similar to (5.13), we can introduce homogeneous coordinates on each of the factors $\mathbf{G}_m^{\mathbf{i}_1(\alpha_k)+\mathbf{i}_2(\alpha_k)}/\mathbf{G}_m$. Introducing the homogeneous coordinates one must take into account the fact that \mathbf{G}_m acts on the factor $\mathbf{G}_m^{\mathbf{i}_1(\alpha_k)}$ through the character χ'_k , while on the factor $\mathbf{G}_m^{\mathbf{i}_2(\alpha_k)}$ via its inverse.

5.3. Theorem. — *a) The rational map*

$$i_{\overline{T}}^{-1} : (U_*^+ \times U_*^-)/H \longrightarrow \text{Conf}_4(\mathcal{B})$$

transforms the positive structure on $(U_^+ \times U_*^-)/H$ to a positive structure on the moduli space $\text{Conf}_4(\mathcal{B})$.*

b) The cyclic shift on $\text{Conf}_4(\mathcal{B})$ is a positive rational map.

c) The reversion $(B_1, B_2, B_3, B_4) \mapsto (B_4, B_3, B_2, B_1)$ is a positive rational map on $\text{Conf}_4(\mathcal{B})$.

So the positive structure on $\text{Conf}_4(\mathcal{B})$ has a natural dihedral symmetry.

Proof. a) The map i_T is not an isomorphism. Its image consists of the elements (u_+, u_-) such that the corresponding pair of flags

$$(u_+^{-1}B^-u_+, u_-B^+u_-^{-1})$$

is in generic position. So to prove a) it remains to show that the complement to the image of i_T is contained in a positive divisor.

Let \overline{T}' be another triangulation of the 4-gon on Figure 5.1, obtained from \overline{T} by changing the oriented edge $B_1 \rightarrow B_3$ to the one $B_2 \rightarrow B_4$. It provides another regular open embedding

$$i_{\overline{T}'} : \text{Conf}_4^*(\mathcal{B}) \hookrightarrow (U_*^+ \times U_*^-)/H. \quad (5.24)$$

It is induced by $(u_+, u_-) \mapsto (u_- \cdot B^+, B^-, u_+^{-1} \cdot B^-, B^+)$. We need the following proposition.

5.4. Proposition. — *The rational map*

$$i_{\overline{T}} \circ i_{\overline{T}'}^{-1} : (U_*^+ \times U_*^-)/H \hookrightarrow (U_*^+ \times U_*^-)/H$$

as well as its inverse are positive rational maps.

Proof. Applying Proposition 5.2 to $\mathbf{j}_1 := (\mathbf{i}, \bar{\mathbf{i}})$, $k = n$ and $\mathbf{j}_2 := (\bar{\mathbf{i}}, \mathbf{i})$, $k = n$ we get

5.6. Lemma. — *The map*

$$\eta : U_*^+ \times H \times U_*^- \longrightarrow U_*^- \times H \times U_*^+, \quad \eta : (u_+, h, u_-) \mapsto (a_-, t, a_+),$$

where $u_-hu_+ = a_+ta_-$ is a positive rational map.

Let (u_+, u_-) be as in (5.21). Then thanks to Lemma 5.6 there exists a positive rational map

$$(u_+, u_-) \longrightarrow (a_-, t, a_+), \quad a_{\pm} \in U_*^{\pm}, t \in H \quad \text{such that } u_+ u_- = a_- a_+ t.$$

Set $g := a_-^{-1} u_+ = a_+ t u_-^{-1}$. Conjugating (5.21) by g we get

$$(a_+ \cdot B^-, B^-, a_-^{-1} \cdot B^+, B^+) = (\phi(a_+) \cdot B^+, B^-, \phi(a_-)^{-1} \cdot B^-, B^+).$$

Since ϕ is a positive isomorphism, this proves that the rational map $i_{\overline{T}} \circ i_{\overline{T}'}^{-1} : (u_+, u_-) \mapsto (\phi(a_-), \phi(a_+))$ is positive. Applying this argument three times we show that the rational map induced by the cube of the cyclic shift is positive. This is equivalent to positivity of the inverse of $i_{\overline{T}} \circ i_{\overline{T}'}^{-1}$. Proposition 5.4 is proved.

We will finish the proof of Theorem 5.3 in the end of the next subsection.

7. Another description of $\text{Conf}_4(\mathcal{B})$. Recall the triangulation T of a convex 4-gon with the flags B_i assigned to its vertices as on the picture and the internal edge oriented from B_1 to B_3 .

5.5. Proposition. — *There exists a canonical birational isomorphism*

$$\varphi_T : \text{Conf}_4(\mathcal{B}) \xrightarrow{\sim} \text{Conf}_3(\mathcal{B}) \times H \times \text{Conf}_3(\mathcal{B}) \xrightarrow{\sim} \mathcal{V}^+ \times H \times \mathcal{V}^-. \quad (5.25)$$

Proof. Let $(B_1, B_2, B_3, B_4) \in \text{Conf}_4(\mathcal{B})$. Then there are projections

$$\begin{aligned} p_1 : \text{Conf}_4(\mathcal{B}) &\longrightarrow \text{Conf}_3(\mathcal{B}), & (B_1, B_2, B_3, B_4) &\longmapsto (B_1, B_2, B_3); \\ p_2 : \text{Conf}_4(\mathcal{B}) &\longrightarrow \text{Conf}_3(\mathcal{B}), & (B_1, B_2, B_3, B_4) &\longmapsto (B_1, B_3, B_4) \end{aligned}$$

corresponding to the two triangles of the triangulation T .

We are going to define a rational projection

$$p_{\mathbf{e}} : \text{Conf}_4(\mathcal{B}) \longrightarrow H \quad (5.26)$$

corresponding to the internal oriented edge \mathbf{e} of the triangulation. Unlike the constructions in Section 5.4, it will not depend on the choice of a reduced decomposition \mathbf{i} of w_0 .

Recall the map (5.22). Recall that we assume that G has trivial center. Let \mathcal{R}_U be the maximal abelian quotient of the unipotent radical U of a Borel subgroup B . The torus $H_U := B/U$ acts on \mathcal{R}_U . Let \mathcal{R}_U^* be the unique dense H_U -orbit in \mathcal{R}_U . It is a principal homogeneous H_U -space. Let $\pi : U \rightarrow \mathcal{R}_U$ be the canonical projection. It provides a rational map

$$p_{\mathbf{e}} : (U_*^+ \times U_*^-)/H \longrightarrow (\mathcal{R}_{U^+}^* \times \mathcal{R}_{U^-}^*)/H = H, \quad (v_+, u_-) \longmapsto \pi(\Psi(v_+))/\pi(u_-).$$

Here the right hand side has the following meaning. For generic (v_+, u_-) both $\Psi(v_+)$ and u_- lie in the H -torsor $\mathcal{R}_{U^-}^*$, so their ratio is a well defined element of H . The Proposition is proved

5.6. Proposition. — *The birational isomorphism (5.25) provides a positive atlas on the moduli space $\text{Conf}_4(\mathcal{B})$. It is equivalent to the one defined in Section 5.6.*

Proof. It is an immediate corollary of the following lemma.

5.7. Lemma. — *Let $(s_1, \dots, s_m, t_1, \dots, t_n)$ be the natural coordinates on \mathbf{G}_m^{n+m} . Set*

$$p_i = \frac{s_{i+1}}{s_i}, \quad i = 1, \dots, m-1, \quad q_j = \frac{t_{j+1}}{t_j}, \quad j = 1, \dots, n-1,$$

$$X = \frac{t_1}{s_m}, \quad Y = \frac{s_1 + \dots + s_m}{t_1 + \dots + t_n}.$$

Then the two coordinate systems $(\{p_i\}, \{q_j\}, X)$ and $(\{p_i\}, \{q_j\}, Y)$ on the quotient of \mathbf{G}_m^{n+m} by the diagonal action of \mathbf{G}_m are related by positive transformations.

Proof. Follows immediately from the formula

$$\frac{1 + p_1 + p_1 p_2 + \dots + p_1 \dots p_{m-1}}{1 + q_1 + q_1 q_2 + \dots + q_1 \dots q_{n-1}} = p_1 \dots p_{m-1} X Y.$$

Proposition 5.6 is proved.

Let us return to the proof of Theorem 5.3. The map $i_{\overline{T}'} \circ i_{\overline{T}}^{-1}$ is certainly non regular at the subvariety of configurations of flags (B_1, B_2, B_3, B_4) determined by the condition that all pairs except (B_2, B_4) are in generic position. But according to Proposition 5.4 this subvariety is contained in a positive divisor. The part a) of the theorem is proved. The part b) follows immediately from Proposition 5.4. To prove the part d), we apply the part b) of Theorem 5.3, then the results of the previous subsection, and then Theorem 5.2. Theorem 5.3 is proved.

8. A remark. According to Theorem 5.3, positive configurations of four flags have a dihedral symmetry. The following lemma shows that they do not have S_4 -symmetry. Recall the H -invariant $p_e(B_1, B_2, B_3, B_4)$ of a configuration of four flags defined by (5.26).

5.8. Lemma. — *If $p_e(B_1, B_2, B_3, B_4) \in H(\mathbf{R}_{>0})$, then $p_e(B_1, B_3, B_2, B_4) \in H(\mathbf{R}_{<0})$.*

Proof. One has

$$\begin{aligned} (B_1, B_2, B_3, B_4) &\sim (B^-, v_-^{-1} B^+ v_-, B^+, u_+ B^- u_+^{-1}) \sim \\ &\sim \left(B^-, B^+, v_- B^+ v_-^{-1}, v_- u_+ B^- (v_- u_+)^{-1} \right) \end{aligned}$$

where $v_- \in U^-(\mathbf{R}_{>0})$ and $u_+ \in U^+(\mathbf{R}_{>0})$. Writing $v_- u_+ = u'_+ h v'_-$, where u'_+, h, v'_- are also positive, we get

$$(B_1, B_3, B_2, B_4) \sim \left(B^-, v_- B^+ v_-^{-1}, B^+, u'_+ B^- (u'_+)^{-1} \right).$$

Recall the canonical projection $\pi : U^- \rightarrow \mathcal{R}_{U^-} := U^-/[U^-, U^-]$. Elements of the abelian group \mathcal{R}_{U^-} are represented uniquely as $\prod y_\alpha(t_\alpha)$, where α runs through all simple positive roots. If $v_- \in U^-(\mathbf{R}_{>0})$ then these t_α -coordinates of the element $\pi(v_-)$ are in $\mathbf{R}_{>0}$, while for $\pi(v_-^{-1})$ they are in $\mathbf{R}_{<0}$. Now the lemma follows immediately from the definition of the H -invariant. The lemma is proved.

9. A positive atlas on $\text{Conf}_5(\mathcal{B})$ and its dihedral symmetry. Consider a convex pentagon with vertices labeled by a configuration (B_1, \dots, B_5) . Let T be its triangulation. The two diagonals of the triangulation share a vertex. We will assume the diagonals are oriented out of the vertex. Then there is a birational isomorphism

$$\varphi_T : \text{Conf}_5(\mathcal{B}) \xrightarrow{\sim} \text{Conf}_3(\mathcal{B})^3 \times H^2 \quad (5.27)$$

where the factors $\text{Conf}_3(\mathcal{B})$ correspond to triangles with ordered vertices of the triangulation T , and the factors H are assigned to the oriented diagonals of the triangulation. Precisely, assuming that the diagonals share the vertex B_1 , the map is given by

$$\begin{aligned} (B_1, \dots, B_5) &\longmapsto (B_1, B_2, B_3) \times (B_1, B_3, B_4) \times (B_1, B_4, B_5) \times \\ &\quad \times p_{\mathbf{e}_{13}}(B_1, B_2, B_3, B_4) \times p_{\mathbf{e}_{14}}(B_1, B_3, B_4, B_5). \end{aligned}$$

The decomposition (5.27) provides a positive atlas of the space $\text{Conf}_5(\mathcal{B})$. We are going to show that it is invariant under the natural action of the dihedral group D_5 . So we have to show that it is invariant under the flips and reversing the order of the flags. The claim that a dihedral symmetry map followed by projection to a factor $\text{Conf}_3(\mathcal{B})$ is positive immediately reduced to dihedral symmetry of positive atlases on the spaces $\text{Conf}_n(\mathcal{B})$ for $n = 3, 4$. So it remains only to check similar claims for projections onto the H -factors.

More specifically, the only statement not covered by the dihedral symmetry of positive atlases on the spaces $\text{Conf}_n(\mathcal{B})$ for $n = 3, 4$ is this: a flip on the quadrilateral (B_1, B_2, B_3, B_4) of the triangulation on Figure 5.2, followed by projection to the H -invariant assigned to the diagonal B_1B_4 , is a positive map.

It is convenient to use the following parametrisation of the space $\text{Conf}_5(\mathcal{B})$. Consider the map

$$\frac{U_*^- \times U_*^+ \times U_*^+}{H} \longrightarrow \text{Conf}_5(\mathcal{B}); \tag{5.28}$$

$$(u_-, v_+, w_+) \longmapsto (B^-, v_+^{-1} \cdot B^-, v_+^{-1} w_+^{-1} \cdot B^-, B^+, u_- \cdot B^+).$$

This map is evidently a birational isomorphism. The positive atlases on U_*^\pm provide in the standard way a positive atlas on the quotient on the left, and hence on $\text{Conf}_5(\mathcal{B})$. Observe that for the triangulation on Figure 5.2, the

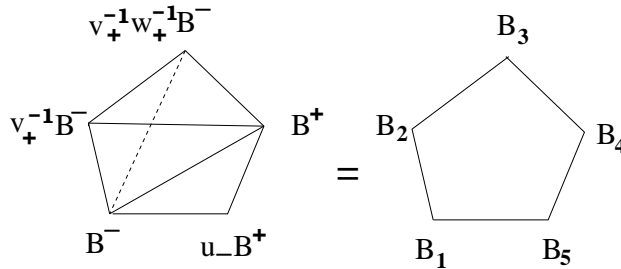

FIG. 5.2. — A triangulated pentagon with flags assigned to vertices.

vertex shared by the two diagonals is B_4 , while for the one used in (5.27) it is B_1 .

5.9. Lemma. — *a) The positive atlas on $\text{Conf}_5(\mathcal{B})$ given by the birational isomorphism (5.28) is equivalent to the standard one corresponding to the triangulation shown on Figure 5.2.*

b) The flip at the punctured diagonal on Figure 5.2 is a positive automorphism of $\text{Conf}_5(\mathcal{B})$. Thus the cyclic shift is a positive automorphism of $\text{Conf}_5(\mathcal{B})$.

c) The reversion $(B_1, \dots, B_5) \longmapsto (B_5, \dots, B_1)$ is a positive automorphism of $\text{Conf}_5(\mathcal{B})$.

Proof. a) It is obvious that, taking into account the S_3 -symmetry of the positive atlas on $\text{Conf}_3(\mathcal{B})$, the configurations of triples of flags assigned

to the three triangles of the triangulation shown on Figure 5.2 are parametrised by u_-, v_+, w_+ , considered modulo the H -conjugation. So it remains to investigate the H -invariants assigned to the edges.

The two quadrilaterals of the triangulation provide two configurations of 4 flags. The first is

$$(B_1, B_2, B_3, B_4) \sim (v_+ \cdot B^-, B^-, w_+^{-1} \cdot B^-, B^+) = (\phi(v_+) \cdot B^+, B^-, w_+^{-1} \cdot B^-, B^+).$$

Applying the cyclic shift we recover the standard positive atlas on the configurations (B_1, B_2, B_3, B_4) . Further, the configuration corresponding to the second quadrilateral is

$$(B_1, B_2, B_4, B_5) = (B^-, v_+^{-1} \cdot B^-, B^+, u_- \cdot B^+)$$

is already in the standard form.

b) After the flip at the diagonal $B_1 B_3$ we get

$$(B_1, B_3, B_4, B_5) \sim (B^-, (w_+ v_+)^{-1} \cdot B^-, B^+, u_- \cdot B^+).$$

c) Follows immediately from the properties of $\text{Conf}_n(\mathcal{B})$ for $n = 3, 4$. The lemma is proved.

Remark. The configuration (B_1, B_3, B_4, B_5) is parametrised by the pair $(w_+ v_+, u_-)$ considered modulo the H -conjugation. So the group product in U^+ appears naturally here.

10. Positivity for the principal PGL_2 -embedding. Recall the principal PGL_2 -embedding $i : PGL_2 \hookrightarrow G$, well-defined up to a conjugation. It can be normalized so that the generator of $U_{>0}(PGL_2)$ goes to the element $\sum_{\alpha} X_{\alpha}$, where $\exp(X_{\alpha}) = x_{\alpha}(1)$ and the sum is over all positive simple roots.

5.7. Proposition. — *The principal embedding respects the total positivity: one has $i(PGL_2(\mathbf{R}_{>0})) \subset G(\mathbf{R}_{>0})$ and a similar statement for the totally positive parts of the maximal unipotent subgroups U^+ .*

Proof. Let λ be a highest weight which is positive on every simple coroot. Denote by V_{λ} the corresponding irreducible representation of G . Let \mathbf{B}_{λ} be the canonical basis in V_{λ} . Let η_{λ} be a lowest weight vector in V_{λ} . According to Proposition 5.4 of [L2], for a simply-laced G , $u \in U_{>0}^+$ if and only if $u(\eta_{\lambda})$ is a linear combination with > 0 coefficients of the elements in the canonical basis \mathbf{B}_{λ} . According to Lusztig, the generators X_{α} of \mathcal{G} act in the canonical basis by matrices with ≥ 0 coefficients. Thus the same is true for $\exp(\sum_{\alpha} X_{\alpha})$. In fact these coefficients are > 0 : indeed, take a monomial $c \cdot X_{\alpha_1} \dots X_{\alpha_k}$, $c > 0$, in the expansion of the above exponential corresponding

to a weight $\eta_\lambda - (\alpha_1 + \dots + \alpha_k)$ in V_λ such that $\eta_\lambda - (\alpha_1 + \dots + \alpha_p)$ is a weight for every $p < k$. The non simply-laced case is treated by folding. The proposition is proved.

5.1. Corollary. — *There is a canonical map $\text{Conf}_k^+(\mathbf{P}^1) \hookrightarrow \text{Conf}_k^+(\mathcal{B})$ provided by a principal PGL_2 -embedding.*

11. Positive configurations of K -flags: two points of view. Given a semifield P there are the P -parts U_P^\pm, H_P, G_P of the corresponding positive varieties. They are monoids. One has $G_P = U_P^+ H_P U_P^- = U_P^- H_P U_P^+$.

Let $K_{>0} \subset K$ be a semifield in a field K . Then there are two ways to define $K_{>0}$ -positive configurations of flags. The first, preferable one, is this: we furnish the space $\text{Conf}_n(\mathcal{B})$ with a positive atlas and take its $K_{>0}$ -points. For $n = 3, 4, 5$ the positive atlas has been defined above, and the general case is deduced from this in Section 6. This method works for an arbitrary semifield. Below we elaborate another, more naive approach, where the fact that $K_{>0}$ is a semifield in a field K is important. We show that the two approaches lead to two *a priori* different notions, which nevertheless coincide if $K_{>0} = \mathbf{R}_{>0}$.

Recall the configuration space $\text{Conf}_n(\mathcal{B}(K))$ of n tuples of flags over K .

5.2. Definition. — *a) A configuration $(B_1, B_2, B_3) \in \text{Conf}_3(\mathcal{B}(K))$ is $K_{>0}$ -positive if*

$$(B_1, B_2, B_3) \sim (B^-, B^+, u \cdot B^+) \quad \text{for some } u \in U_{K_{>0}}^-.$$

b) A configuration $(B_1, B_2, B_3, B_4) \in \text{Conf}_4(\mathcal{B}(K))$ is $K_{>0}$ -positive if

$$(B_1, B_2, B_3, B_4) \sim (B^-, v^{-1} \cdot B^-, B^+, u \cdot B^+) \quad \text{for some } v \in U_{K_{>0}}^+ \text{ and } u \in U_{K_{>0}}^-.$$

The set of $K_{>0}$ -positive configurations of flags for $n = 3, 4$ is denoted by $\text{Conf}_n^+(\mathcal{B}(K))$. Repeating the proofs of Theorems 5.2 and 5.3 we get the following:

5.2. Corollary. — *Let $K_{>0}$ be a semifield in a field K . Let G be as in Theorem 5.2. Then the sets $\text{Conf}_n^+(\mathcal{B}(K))$ for $n = 3, 4$ have a natural dihedral symmetry.*

5.3. Definition. — *Choose a triangulation T of a convex n -gon whose vertices are labeled by flags (B_1, \dots, B_n) . A configuration $(B_1, \dots, B_n) \in \text{Conf}_n(\mathcal{B}(K))$ is $K_{>0}$ -positive if the four flags at the vertices of each quadrilateral of the triangulation T form a $K_{>0}$ -positive configuration of flags.*

Corollary 5.2 shows that only dihedral order of vertices of each quadrilateral matters. Any two triangulations of a convex n -gon are related by a sequence of flips. Using Corollary 5.2 and the proof of Lemma 5.9 we see that the notion of $K_{>0}$ -positivity does not change under a flip. So we get the following proposition, telling us that Definition 5.3 does not depend on choice of a triangulation:

5.8. Proposition. — *If a configuration $(B_1, \dots, B_n) \in \text{Conf}_n(\mathcal{B}(K))$ is $K_{>0}$ -positive with respect to one triangulation, it is positive with respect to any triangulation of the n -gon.*

Let us denote by $\text{Conf}_n^+(\mathcal{B}(K))$ the set of all $K_{>0}$ -positive configurations of K -flags.

5.3. Corollary. — *The set $\text{Conf}_n^+(\mathcal{B}(K))$ is invariant under the natural dihedral group action.*

Proof. Although the dihedral group action changes the triangulation used to define $K_{>0}$ -positive configurations, by Proposition 5.8 it does not affect $K_{>0}$ -positivity. The corollary is proved.

For an arbitrary semifield $K_{>0}$ one may have

$$\text{Conf}_n^+(\mathcal{B}(K)) \neq \text{Conf}_n(\mathcal{B})(K_{>0}). \quad (5.29)$$

Example. The configuration space of three distinct points on P^1 is defined as follows:

$$\text{Conf}_3^*(P^1) := (P^1 \times P^1 \times P^1 - \text{diagonals})/SL_2.$$

It is a single point. However for a field F the set of $SL_2(F)$ -orbits on $P^1(F)^3 - \text{diagonals}$ is $F^*/(F^*)^2$. Indeed, under the action of $SL_2(F)$ the first two points can be made 0 and ∞ , and then the subgroup $\text{diag}(t, t^{-1})$ of diagonal matrices in $SL_2(F)$ stabilizing these two points acts on $z \in F^*$ by $z \mapsto t^2 z$. For example when $F = \mathbf{R}$ there are 2 orbits. Indeed, three ordered distinct points on $P^1(\mathbf{R})$ provide an orientation of $P^1(\mathbf{R})$. Moreover $\text{Conf}_n^+(P^1(K)) = \text{Conf}_n(P^1)(K_{>0})$ if and only if $(K_{>0})^2 = K_{>0}$, which may not be the case.

Here is a general set up. Assume that we have a map of F -varieties $f : X \rightarrow Z$, and an F -group G acts on X from the right. Assume that G acts on fibers of f , and this action is transitive on the fibers (over \overline{F}). Let $z \in Z(F)$. Set $Y := f^{-1}(z)$. It is a right homogeneous space for G . Let us assume that there exists a point $y \in Y(F)$. Then, setting $H := \text{Stab}_G(y)$, we

have $Y = H \backslash G$. So by ([Se], Cor 1 of Prop. 36 in I-5.4) there is canonical isomorphism

$$Y(F)/G(F) = \text{Ker}\left(H^1(F, H) \longrightarrow H^1(F, G)\right).$$

The question whether there exists an F -point in Y is non trivial if Y is not a principal homogeneous space for G , and, as was pointed out to us M. Borovoi, is treated for p -adic and number fields in the Subsection 7.7 of [Bor]. We will not need this in our story.

So if $Z := X/G$ is the quotient algebraic variety, there are two different sets: $Z(F)$ and $X(F)/G(F)$. The canonical map $X(F)/G(F) \longrightarrow Z(F)$ can be neither surjective nor injective.

However for positive configurations of real flags the situation is as nice as it could be:

5.10. Lemma. — *For $n = 3, 4, 5$, one has*

$$\text{Conf}_n^+(\mathcal{B}(\mathbf{R})) = \text{Conf}_n(\mathcal{B})(\mathbf{R}_{>0}),$$

and there is a canonical inclusion

$$\text{Conf}_n(\mathcal{B})(\mathbf{R}_{>0}) \hookrightarrow \text{Conf}_n(\mathcal{B}(\mathbf{R})).$$

Proof. It boils down to the following two facts:

$\mathcal{V}_*(\mathbf{R}_{>0}) = U_*(\mathbf{R}_{>0})/H(\mathbf{R}_{>0})$ and similarly $((U_*^- \times U_*^+)/H)(\mathbf{R}_{>0}) = U_*^-(\mathbf{R}_{>0}) \times U_*^+(\mathbf{R}_{>0})/H(\mathbf{R}_{>0})$. They follow from $(\mathbf{R}_+^*)^m = \mathbf{R}_+^*$. The lemma is proved.

A positive atlas on the space $\text{Conf}_n(\mathcal{B})$ is defined in Section 6. Then it is straightforward to check that Lemma 5.10 remains valid for all $n > 2$. So the real positive configurations of flags in the sense of Definition 5.3 always coincide with the $\mathbf{R}_{>0}$ -points of the positive space $\text{Conf}_n(\mathcal{B})$, and are embedded into the configuration space of n real flags in generic position modulo the $G(\mathbf{R})$ -action.

6. A positive structure on the moduli space $\mathcal{X}_{G, \hat{S}}$

In this Section we give three different proofs, in Sections 6.1, 6.3 and 6.5, of the decomposition of the moduli space $\mathcal{X}_{G, \hat{S}}$ according to a triangulation. This provides a positive atlas on $\mathcal{X}_{G, \hat{S}}$.

0. Basic properties of the positive atlas on $\text{Conf}_n(\mathcal{B})$ for $n = 3, 4, 5$. Let us summarize the properties of the positive atlases on the spaces $\text{Conf}_n(\mathcal{B})$, where $n = 3, 4, 5$, which are used below. The proofs are given in Theorem 5.2, Theorem 5.3, and Lemma 5.9.

1) The space $\text{Conf}_3(\mathcal{B})$ has a positive atlas invariant under the action of the group S_3 .

2) There is a birational isomorphism

$$\varphi : \text{Conf}_4(\mathcal{B}) \xrightarrow{\sim} \text{Conf}_3(\mathcal{B}) \times H \times \text{Conf}_3(\mathcal{B}), \quad (6.1)$$

where projections to the left and right factors $\text{Conf}_3(\mathcal{B})$ are given by the maps

$$(B_1, B_2, B_3, B_4) \mapsto (B_1, B_2, B_3) \quad \text{and} \quad (B_1, B_2, B_3, B_4) \mapsto (B_1, B_3, B_4).$$

3) The birational isomorphism (6.1) provides a positive atlas on the space $\text{Conf}_4(\mathcal{B})$. This positive atlas is invariant under the cyclic shift and reversion maps given by

$$(B_1, B_2, B_3, B_4) \longrightarrow (B_4, B_1, B_2, B_3), \quad (B_1, B_2, B_3, B_4) \longrightarrow (B_4, B_3, B_2, B_1).$$

If we picture a configuration (B_1, B_2, B_3, B_4) at the vertices of a 4-gon as on Figure 5.1, then the cyclic invariance boils down to the invariance of the positive atlas on $\text{Conf}_4(\mathcal{B})$ under a flip, and hence the invariance under the change of an orientation of the diagonal e . The invariance under the reversion map shows the invariance of the positive atlas under the change of an orientation of the plane where the 4-gon is located.

4) Consider the convex pentagon whose vertices are labeled by a configuration (B_1, \dots, B_5) . Let T_1 be its triangulation by the diagonals B_1B_3 and B_1B_4 . Then there is a birational isomorphism

$$\varphi_{T_1} : \text{Conf}_5(\mathcal{B}) \xrightarrow{\sim} \left(\text{Conf}_3(\mathcal{B}) \right)^3 \times H^2 \quad (6.2)$$

where the factors $\text{Conf}_3(\mathcal{B})$ correspond to the triangles of the triangulation T_1 , and the factors H are assigned to the diagonals B_1B_3 and B_1B_4 of the triangulation.

The positive atlas of the space $\text{Conf}_5(\mathcal{B})$ provided by (6.2) is invariant under the natural action of the dihedral group D_5 .

1. A positive atlas on $\mathcal{X}_{G, \widehat{S}}$. Let us spell in detail the definition of the map $\pi_{\mathbf{T}}$ outlined in Section 1.3. Let \widehat{S} be a marked hyperbolic surface. Let us choose a pair \mathbf{T} given by

$$\mathbf{T} = \left\{ \begin{array}{l} \text{an ideal triangulation } T \text{ of } \widehat{S}, \\ \text{a choice of orientation of all internal edges of } T \end{array} \right\}. \quad (6.3)$$

Let us assume first that the triangulation is regular in the sense of Section 3.8. Denote by $\text{tr}(T)$ the set of the triangles of T , and by $ed_i(\mathbf{T})$ be the set

of the internal edges of \mathbf{T} . Denote by $\mathcal{X}_{G,\hat{t}}$ the moduli space of the framed G -local systems on a triangle t , considered as a disc with three marked points on the boundary given by certain three points inside of the edges, one point per each edge. Let $(\mathcal{L}, \beta) \in \mathcal{X}_{G,\hat{S}}$. We can view a triangle t of the ideal triangulation as a disc with three marked points at the boundary, as we just explained. Restricting the framed local system $(\mathcal{L}, \beta) \in \mathcal{X}_{G,\hat{S}}$ to such a triangle t we get an element of $\mathcal{X}_{G,\hat{t}}$. Indeed, if a vertex s of the triangle t belongs to a boundary arc on \hat{S} then there is a flag at this point. If s is a puncture then we take the monodromy invariant flag at the intersection of the triangle with a little disc around the puncture. So we get a projection $p_t : \mathcal{X}_{G,\hat{S}} \rightarrow \mathcal{X}_{G,\hat{t}}$. Further, each internal edge e of the triangulation T determines a pair of triangles t_1, t_2 sharing e . Their union $t_1 \cup t_2$ is a 4-gon with four marked points on the boundary, one per each side. Thus restricting (\mathcal{L}, β) to $t_1 \cup t_2$ we get an element of $\mathcal{X}_{G,4}$. Its H -invariant corresponding to the oriented edge \mathbf{e} is given by (5.26). It provides a rational projection $p_{\mathbf{e}} : \mathcal{X}_{G,\hat{S}} \rightarrow H$. The collection of projections $\{p_t\}, \{p_{\mathbf{e}}\}$ provides a rational map

$$\pi_{\mathbf{T}} : \mathcal{X}_{G,\hat{S}} \rightarrow \prod_{t \in \text{tr}(T)} \mathcal{X}_{G,\hat{t}} \times \prod_{\mathbf{e} \in \text{ed}_i(\mathbf{T})} H. \quad (6.4)$$

If the triangulation T is special, the above construction works unless we consider the edge given by the loop of the virus. The construction of the H -invariant for this edge is obtained by going to the $2:1$ cover of S described in Section 3.8, and then using the above construction of the H -invariant. The same trick, described in detail in the Section 10.7, is used in the proof of the theorems in this Section in the part related to this edge.

6.1. Theorem. — *Let G be a split semi-simple algebraic group with trivial center and \hat{S} a marked hyperbolic surface. Then the map $\pi_{\mathbf{T}}$ is a birational isomorphism. The collection of rational maps $\{\pi_{\mathbf{T}}^{-1}\}$, where \mathbf{T} run through all datas (6.3), provides a Γ_S -equivariant positive atlas on $\mathcal{X}_{G,\hat{S}}$.*

Proof. Let us prove first the theorem in the special case when $\hat{S} = \hat{D}_n$ is a disc with n marked points on the boundary. We proceed by the induction on n . For $n = 3$ this is given by the property 1) above. To make the inductive step from n to $n + 1$ consider a convex $(n + 1)$ -gon P_{n+1} with the vertices b_1, \dots, b_{n+1} taken in the order compatible with the orientation of the disc. We assign a configuration of flags (B_1, \dots, B_{n+1}) to the vertices of P_{n+1} , so that B_i is assigned to the vertex b_i . Let us triangulate this $(n + 1)$ -gon so that (b_1, b_2, b_3) is one of the triangles of the triangulations. Let P_n

be the n -gon obtained by cutting out the triangle (b_1, b_2, b_3) . By the induction assumption a generic data on the right hand side of (6.4) determines a configuration $(B_1, B_3, B_4, \dots, B_{n+1}) \in \text{Conf}_n(\mathcal{B})$ assigned to the vertices of the n -gon P_n . Adding the triangle (b_1, b_2, b_3) we add to this data the element $\beta_{123} \in \text{Conf}_3(\mathcal{B})$ corresponding to this triangle, and an H -invariant $h_{13} \in H$ corresponding to the edge (b_1, b_3) . Let (b_1, b_3, b_k) be the triangle of the triangulation adjacent to the edge (b_1, b_3) , and $\beta_{13k} \in \text{Conf}_3(\mathcal{B})$ the invariant assigned to this triangle. (Since we work rationally, we may ignore the difference between $\text{Conf}_3(\mathcal{B})$ and $\mathcal{X}_{G,3}$). According to the property 2) there is a unique configuration (B'_1, B'_2, B'_3, B'_k) of four flags with the invariant $(\beta_{123}, h_{13}, \beta_{13k})$. Observe that the configurations (B'_1, B'_3, B'_k) and (B_1, B_3, B_k) are the same.

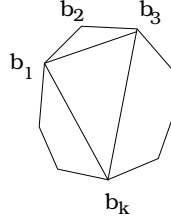

FIG. 6.1. — The quadrilateral corresponding to the triangle $b_1 b_2 b_3$.

Since G has trivial center, it acts without stable points on the space of generic triples of flags in G . Therefore there exists a unique configuration $(B_1, B_2, \dots, B_{n+1})$ such that $(B'_1, B'_2, B'_3, B'_k) = (B_1, B_2, B_3, B_k)$ corresponding to the data provided by the triangulation of the $(n+1)$ -gon. So, given a triangulation T of the $(n+1)$ -gon, the map (6.4) is a birational isomorphism for the disc \widehat{D}_{n+1} . Thus it provides a positive atlas on $\text{Conf}_{n+1}(\mathcal{B})$. It follows from 3) that the positive atlas corresponding to the triangulation T' obtained from T by a flip is compatible with this positive atlas. The role of the mapping class group in this case is played by the dihedral group generated by the cyclic shift and reversion maps. This proves the theorem for the disc.

Now let us consider the general case. It is sufficient to show that, given an arbitrary field F , a generic point x of the right hand side of (6.4) provides an F -point y of the right hand side such that $\pi(x) = y$. Let us define a representation $\rho_x : \pi_1(S) \rightarrow G(F)$ corresponding to x . Let T be an ideal triangulation of S . Lifting it to a universal cover \widetilde{S} of S we obtain a triangulation \widetilde{T} . The triangulated surface $(\widetilde{S}, \widetilde{T})$ is isomorphic to the hyperbolic disc \mathcal{H} equipped with the Farey triangulation. Let (a, b, c) be a triangle of \widetilde{T} . Let $\gamma \in \pi_1(S)$. Take a finite polygon P_γ of the triangulation \widetilde{T} containing the triangles (a, b, c) and $(a', b', c') := \gamma(a, b, c)$. The polygon P_γ inherits a

triangulation. So by the first part of the proof, the data y , restricted to the triangulated polygon, gives rise to a unique element $y(P_\gamma) \in \text{Conf}_n(\mathcal{B}(F))$ corresponding to it. Let (B_a, B_b, B_c) be the corresponding configuration of flags attached to the vertices (a, b, c) of the polygon. Then there exists an element $g_\gamma \in G(F)$ such that

$$(B_{a'}, B_{b'}, B_{c'}) = g_\gamma(B_a, B_b, B_c).$$

Such an element is unique since G has trivial center. It is easy to see that $\gamma \rightarrow g_\gamma$ is a representation of $\pi_1(S, p)$, and it does not depend on the choice of the polygon. Here p is a point inside of the triangle on S obtained by projection of the triangle (a, b, c) . We leave construction of the framing as an easy exercise. The theorem is proved.

In the next subsection we work out an explicit construction of the framed local system corresponding to the generic data in (6.4).

2. The six canonical pinnings determined by a generic triple of flags in G . Let us choose two reduced words \mathbf{i}^+ and \mathbf{i}^- of the element w_0 . Set

$$U_*^-(\mathbf{i}^-) := \psi_{\mathbf{i}^-}(\mathbf{G}_m^n) \subset U_*^-, \quad U_*^+(\mathbf{i}^+) := \psi_{\mathbf{i}^+}(\mathbf{G}_m^n) \subset U_*^+.$$

The group H acts freely on each of these spaces. So the H -orbit of any element $u \in U_*^-(\mathbf{i}^-)$ intersects the subvariety

$$\bar{U}_*(\mathbf{i}^-) := \psi_{\mathbf{i}^-} \left(e \times \mathbf{G}_m^{i_1^- - 1} \times e \times \mathbf{G}_m^{i_2^- - 1} \times \dots \times e \times \mathbf{G}_m^{i_r^- - 1} \right) \subset U_*^-(\mathbf{i}^-) \quad (6.5)$$

in a single point, called the normalized representative \bar{u} . Similarly we define the normalized representative \bar{v} of the H -orbit of an element $v \in U_*^+(\mathbf{i}^+) := \psi_{\mathbf{i}^+}(\mathbf{G}_m^n)$ as the intersection point of the orbit with the subvariety

$$\bar{U}_*(\mathbf{i}^+) := \psi_{\mathbf{i}^+} \left(\mathbf{G}_m^{i_1^+ - 1} \times e \times \mathbf{G}_m^{i_2^+ - 1} \times e \times \dots \times \mathbf{G}_m^{i_r^+ - 1} \times e \right) \subset U_*^+(\mathbf{i}^+). \quad (6.6)$$

Let us say that a triple (B_1, B_2, B_3) of flags in G is a sufficiently generic, if one has

$$(B_1, B_2, B_3) = g_- \cdot (B^-, B^+, \bar{u}_- B^+ \bar{u}_-^{-1}), \quad u_- \in U_*^-(\mathbf{i}^-)$$

$$(B_1, B_2, B_3) = g_+ \cdot (B^-, \bar{v}_+^{-1} B^- \bar{v}_+, B^+), \quad v_+ \in U_*^+(\mathbf{i}^+)$$

for the uniquely defined elements $g_-, g_+ \in G$. The sufficiently generic triples form a non empty Zariski open subset in the configuration space of triples of flags in G . Therefore such a triple (B_1, B_2, B_3) of flags in G determines the following two pinnings for G :

$$p_{(B_1, B_2, B_3)}^+(B_1, B_2) := g_- \cdot (B^-, B^+), \quad p_{(B_1, B_2, B_3)}^-(B_1, B_3) := g_+ \cdot (B^-, B^+).$$

Using the cyclic shifts we define the rest of the pinnings. So we get the six pinnings for G , where the indices i are modulo 3:

$$p_{(B_1, B_2, B_3)}^+(B_i, B_{i+1}), \quad p_{(B_1, B_2, B_3)}^-(B_i, B_{i-1}). \quad (6.7)$$

These pinnings are determined by the cyclic configuration of the three flags (B_1, B_2, B_3) and the choice of two reduced words $\mathbf{i}^-, \mathbf{i}^+$ for w_0 . Observe that p^\pm corresponds to g^\mp . The $+$ and $-$ in (6.7) indicate whether the corresponding edge is oriented accordantly to the cyclic order of (B_1, B_2, B_3) or not. It is handy to picture the six pinning related to a triple $(B_1, B_2, B_3) \in \text{Conf}_3(\mathcal{B})$ by arrows as on Figure 6.2. Say that U is a positive Zariski open subset of

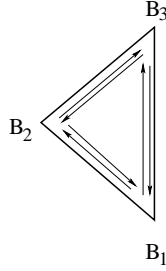

FIG. 6.2. — Arrows encode the six pinnings assigned to a configuration of three flags.

a positive variety X if $X - U$ is contained in a positive divisor of X . The discussion above proves the following lemma.

6.1. Lemma. — *There exists a positive Zariski open subset $\text{Conf}_3^o(\mathcal{B}) \subset \text{Conf}_3(\mathcal{B})$ such that for any configuration $(B_1, B_2, B_3) \in \text{Conf}_3^o(\mathcal{B})$ the above construction determines the six pinnings (6.7) for G . Changing a standard pinning for G amounts to a shift of each of our the six pinnings by a common element in G .*

We leave a precise description of $\text{Conf}_3^o(\mathcal{B})$ as the intersection of several explicitly given positive subvarieties of $\text{Conf}_3(\mathcal{B})$ as a straightforward exercise.

The edge invariant. Given a generic configuration (B_1, B_2, B_3, B_4) of flags in G , such that both (B_1, B_2, B_3) and (B_1, B_3, B_4) are in $\text{Conf}_3^o(\mathcal{B})$, there exists a unique element

$$h_{(\mathbf{i}^-, \mathbf{i}^+)}(B_1, B_2, B_3, B_4) \in H$$

such that

$$p_{(B_1, B_3, B_4)}^+(B_1, B_3) = h_{(\mathbf{i}^-, \mathbf{i}^+)}(B_1, B_2, B_3, B_4) \cdot p_{(B_1, B_2, B_3)}^-(B_1, B_3). \quad (6.8)$$

The element $h_{(\mathbf{i}^-, \mathbf{i}^+)}(B_1, B_2, B_3, B_4) \in H$ in (6.8) is called the *edge invariant* of the configuration of flags (B_1, B_2, B_3, B_4) corresponding to the oriented edge (B_1, B_3) .

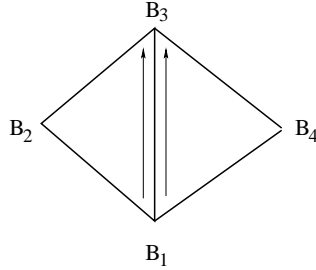

FIG. 6.3. — The edge invariant is obtained by comparison of the two pinning shown by arrows.

3. The positive structure of $\mathcal{X}_{G, \widehat{S}}$. To describe the rational inverse to the map $\pi_{\mathbf{T}}$, see (1.4), we need a finer data assigned to a triangulation T of \widehat{S} .

6.1. Definition. — Denote by \mathbf{T} the following data on \widehat{S} :

- i) An ideal triangulation T of a marked hyperbolic surface \widehat{S} .
- ii) For each internal edge of the triangulation T a choice of orientation of this edge.
- iii) For each triangle t of the triangulation T a choice of a vertex of this triangle.
- iv) A pair of reduced decompositions $(\mathbf{i}^-, \mathbf{i}^+)$ of the maximal length element $w_0 \in W$.

We can visualize a choice described in iii) as a choice of an angle for each of the triangles t .

6.2. Theorem. — Let G be a split semi-simple algebraic group with trivial center. Let \widehat{S} be a marked hyperbolic surface and \mathbf{T} a data assigned to an ideal triangulation T of \widehat{S} , as in Definition 6.1. Then

- a) There exists a regular open embedding

$$\psi_{\mathbf{T}} : \text{Conf}_3^o(\mathcal{B})^{\{\text{triangles of } T\}} \times H^{\{\text{edges of } T\}} \hookrightarrow \mathcal{X}_{G, \widehat{S}}. \quad (6.9)$$

- b) The collection of regular open embeddings $\{\psi_{\mathbf{T}}\}$, when \mathbf{T} runs through all possible datas from Definition 6.1 assigned to \widehat{S} , provides a Γ_S -equivariant positive structure on $\mathcal{X}_{G, \widehat{S}}$.

c) The positive structure defined in Theorem 6.1 is compatible with the one defined in b).

Proof. a) Recall the six pinnings assigned according to Lemma 6.1 to an element of $C \in \text{Conf}_3^o(\mathcal{B})$. Their dependence on the choice of a standard pinning (B^-, B^+) boils down to a shift by a common element in G . Further, let us suppose that we have two elements $C_1, C_2 \in \text{Conf}_3^o(\mathcal{B})$ and an element $h \in H$. Then there exists a unique configuration $(B_1, B_2, B_3, B_4) \in \text{Conf}_4(\mathcal{B})$ such that

$$C_1 = (B_1, B_2, B_3), \quad C_2 = (B_1, B_3, B_4), \quad h_{(i^-, i^+)}(B_1, B_2, B_3, B_4) = h. \quad (6.10)$$

Moreover if we choose one of the six pinnings corresponding to the configuration (B_1, B_2, B_3) , then there is a unique way to normalize the six pinnings corresponding to the configuration (B_1, B_3, B_4) so that formula (6.8) holds with $h_{(i^-, i^+)}(B_1, B_2, B_3, B_4) = h$. Therefore given (6.10) and one of the 12 pinnings shown by arrows on the picture we determine uniquely the rest of the pinnings. Let Γ be a graph on a marked hyperbolic surface \widehat{S} dual to

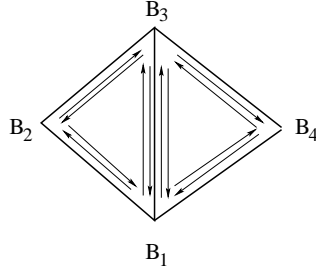

FIG. 6.4. — The twelve pinnings assigned to a quadrilateral.

an ideal triangulation T of \widehat{S} . Consider a closed path \mathbf{p} on the graph. We are going to attach an element $g_{\mathbf{p}} \in G$ to this path which will give rise to a homomorphism $\pi_1(S) \rightarrow G$. Let us consider the triangles of the triangulation corresponding to the vertices of the path \mathbf{p} , as on the picture. Let us choose one of these triangles and denote it t_1 . The data \mathbf{T} allows to assign to each triangle t a configuration of flags (B_1, B_2, B_3) sitting at the vertices of t , so that B_1 is assigned to the distinguished vertex (provided by the condition iii) in the definition of \mathbf{T}), and the orientation of the triangle t given by the order of B_i 's is the same as the one induced by the orientation of the surface S (clockwise on our pictures). It follows from the remarks made about pinnings above that given one of the six canonical pinnings associated to the flags sitting at the vertices of the triangle t_1 , we determine uniquely the 6-tuples of pinnings corresponding to the triangles following t_1 along the path

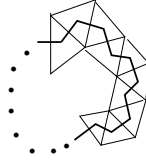

FIG. 6.5. — Constructing the local system.

\mathbf{p} , till we return to the triangle t_1 . Thus for a closed path \mathbf{p} there are two 6-tuples of canonical pinnings assigned to the triangle t_1 : the original one, and the one obtained after traveling along the loop \mathbf{p} . These two 6-tuples of pinnings differ by a shift in G . So we pick up an element $g_{\mathbf{p}} \in G$ transforming the original 6-tuple of pinnings to the final one. Clearly the map $\mathbf{p} \mapsto g_{\mathbf{p}}$ is multiplicative: $\mathbf{p}_2\mathbf{p}_1 \mapsto g_{\mathbf{p}_2}g_{\mathbf{p}_1}$. Moreover $\mathbf{p}^{-1} \mapsto g_{\mathbf{p}}^{-1}$. Since \mathbf{p} is a path on the graph, its homotopy class is determined uniquely by the path itself. So we get a group homomorphism $\pi_1(S, x) \rightarrow G$ where x is a base point on Γ inside of the triangle t_1 .

Let us define a framed structure on this representation. Let s be a puncture on S . Consider all triangles of the triangulation sharing the vertex s . Let us choose a path \mathbf{p}_s from the base point x to a point inside of a

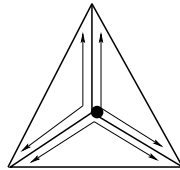

FIG. 6.6. — The link of a puncture s .

certain triangle t_s sharing the vertex s . Then given a pinning P_x in the triangle t_x containing x we get the six pinning assigned to the triangle T_s . Let P_s be one of them corresponding to an arrow going from the vertex s . Let (B, B') be the pair of Borel subgroups underlying this pinning, so that B is assigned to the vertex s . Going around s we define pinnings corresponding to the other triangles sharing s . Observe that all pinnings corresponding to the arrows starting at s have the same "initial" Borel subgroup, B . Therefore the monodromy of the local system corresponding to our representation around a small loop \mathbf{l}_s going around s belongs to B . So if $P_s = gP_x$, then the element $\mathbf{p}_s^{-1}\mathbf{l}_s\mathbf{p}_s$ leaves the Borel subgroup $g^{-1}Bg$ invariant. This provides a framed structure of our representation at the puncture s .

We have defined the map $\psi_{\mathbf{T}}$. Let us show that it is injective. Let us define a left inverse map

$$\pi_{\mathbf{T}} : \mathcal{X}_{G, \widehat{S}} \longrightarrow \prod_{t \in \text{tr}(T)} \mathcal{X}_{G, \widehat{t}} \times \prod_{\mathbf{e} \in \text{ed}_i(\mathbf{T})} H.$$

Here $\text{ed}_i(\mathbf{T})$ is the set of internal edges of the triangulation T oriented as prescribed by the data \mathbf{T} . So the second product is over the set of all internal edges of T . The $\prod_{t \in \text{tr}(T)} \mathcal{X}_{G, \widehat{t}}$ -component of the map $\pi_{\mathbf{T}}$ is the same as for the map π_T . The H -component corresponding to an oriented internal edge \mathbf{e} is the edge invariant from (6.8) assigned to \mathbf{e} . Notice that it is different from the one used in π_T . Then by the very construction we have $\pi_{\mathbf{T}} \circ \psi_{\mathbf{T}} = \text{Id}$. Thus the map $\psi_{\mathbf{T}}$ is injective.

6.2. Lemma. — *Let $f : X \rightarrow Y$ and $g : Y \rightarrow X$ be maps of irreducible algebraic varieties of the same dimension. Then $g \circ f = \text{Id}_X$ implies that both f and g are birational isomorphisms.*

Proof. The conditions of the lemma imply that the maps f, g are dominant, so there are maps of fields $f^* : \mathbf{Q}(Y) \rightarrow \mathbf{Q}(X)$, $g^* : \mathbf{Q}(X) \rightarrow \mathbf{Q}(Y)$. Since $f^*g^* = \text{Id}$, the lemma follows.

6.3. Lemma. — *Let \widehat{S} be a marked hyperbolic surface. Denote by $t(T)$ and $e_i(T)$ the number of triangles and internal edges of an ideal triangulation T of \widehat{S} . Then one has*

$$\dim \mathcal{X}_{G, \widehat{S}} = e_i(T) \dim H + t(T) (\dim U - \dim H). \quad (6.11)$$

This Lemma, of course, follows from the proof given in Section 6.1. However we will give an independent proof for completeness of the arguments.

Proof. Assume for a moment that the number k of marked boundary points on \widehat{S} is equal to zero, i.e. $\widehat{S} = S$ and $e(T) = e_i(T)$ is the number of all edges. Then $\chi(S) = -e(T) + t(T)$, $2e(T) = 3t(T)$. Therefore

$$e(T) = -3\chi(S), \quad t(T) = -2\chi(S).$$

It is well known that $\dim \mathcal{L}_{G, S} = -\chi(S) \dim G$. The canonical map $\mathcal{X}_{G, S} \rightarrow \mathcal{L}_{G, S}$ is a finite map at the generic point. This follows from the well known fact that the monodromies of a generic G -local system on S around the punctures are regular conjugacy classes in G . This gives $\dim \mathcal{X}_{G, S} = -\chi(S) \dim G$. The equality (6.11) in the case $\widehat{S} = S$ follows immediately from these remarks. To check (6.11) in general observe that adding a marked point we increase the dimension by $\dim(G/B) = \dim U$. On the other hand adding a

marked point we add by one the number of internal edges and triangles of a triangulation. So it remains to check the statement in the case when S is a disc or cylinder to have the base for the induction. The lemma is proved.

It follows from Lemma 6.3 both spaces in (6.9) are of the same dimension. Thus (Lemma 6.2) $\psi_{\mathbf{T}}$ is a birational isomorphism. The part a) of the theorem is proved.

b) It is sufficient to show that if T and T' are two triangulations of \widehat{S} related by a flip, and \mathbf{T} and \mathbf{T}' are two datas refining these triangulations, then the positive structures defined by $\psi_{\mathbf{T}}$ and $\psi_{\mathbf{T}'}$ are compatible. This follows from Theorem 5.3 and Lemma 5.9. Observe that we need to consider configurations of 5-tuples of flags in order to make sure that the positive structures related by a flip in an edge E are compatible: indeed, consider the 4-gon containing E as a diagonal. Then the H -coordinates assigned to an external edge F of this 4-gon depend on the flags in the vertices of the 4-gon containing F as a diagonal. One of them is assigned to a vertex outside of the original 4-gon. The part b) of the theorem is proved.

c) It follows from Proposition 5.6. The theorem is proved.

4. The higher Teichmüller \mathcal{X} -space and the \mathcal{X} -lamination space related to G .

6.2. Definition. — *Let \widehat{S} be a marked hyperbolic surface and G a split reductive algebraic group with trivial center.*

a) *The Teichmüller space $\mathcal{X}_{G,\widehat{S}}^+$ is the $\mathbf{R}_{>0}$ -positive part $\mathcal{X}_{G,\widehat{S}}(\mathbf{R}_{>0})$ of the positive space $\mathcal{X}_{G,\widehat{S}}$.*

b) *Let \mathbf{A}^t be one of the tropical semifields $\mathbf{Z}^t, \mathbf{Q}^t, \mathbf{R}^t$. The set of $\mathcal{X}^{\mathbf{A}}$ -laminations on \widehat{S} corresponding to G is the set $\mathcal{X}_{G,\widehat{S}}(\mathbf{A}^t)$ of points of the positive space $\mathcal{X}_{G,\widehat{S}}$ with values in the tropical semifield \mathbf{A}^t .*

According to Section 4.5 projectivisation of the set of real \mathcal{X} -laminations can be considered as the Thurston type boundary of the space $\mathcal{X}_{G,\widehat{S}}^+$.

Applying the definition of the regular part of a positive variety (Section 4.1) in our case we get the regular part $\mathcal{X}_{G,\widehat{S}}^{\text{reg}} \hookrightarrow \mathcal{X}_{G,\widehat{S}}$. The higher Teichmüller space is a connected component in $\mathcal{X}_{G,\widehat{S}}^{\text{reg}}(\mathbf{R})$.

Recall from Section 2.1 the set $\widetilde{\mathcal{X}}_{G,\widehat{S}}(\mathbf{R})/G(\mathbf{R})$ parametrising framed representations $\pi_1(S, x) \rightarrow G(\mathbf{R})$ modulo $G(\mathbf{R})$ -conjugation. If \widehat{D}_3 is a disc with three marked points, then ordering these points we get an isomorphism $\widetilde{\mathcal{X}}_{G,\widehat{D}_3}(\mathbf{R}) = \mathcal{B}(\mathbf{R})^3$. Let T be an ideal triangulation of \widehat{S} . Then each triangle t of the triangulation provides a restriction map $\widetilde{\mathcal{X}}_{G,\widehat{S}}(\mathbf{R})/G(\mathbf{R}) \rightarrow$

$\tilde{\mathcal{X}}_{G,\hat{t}}(\mathbf{R})/G(\mathbf{R})$. We employ quadrilaterals of the triangulation in a similar way.

An element of $\tilde{\mathcal{X}}_{G,\hat{s}}(\mathbf{R})/G(\mathbf{R})$ is called *positive* if its restriction to every quadrilateral of a given triangulation T belongs to $\text{Conf}_4^+(\mathcal{B}(\mathbf{R}))$.

6.1. Corollary. — *The set of positive elements in $\tilde{\mathcal{X}}_{G,\hat{s}}(\mathbf{R})/G(\mathbf{R})$ does not depend on the choice of triangulation T . It is isomorphic to $\mathcal{X}_{G,\hat{s}}^+$. So there is an embedding $\mathcal{X}_{G,\hat{s}}^+ \hookrightarrow \tilde{\mathcal{X}}_{G,\hat{s}}(\mathbf{R})/G(\mathbf{R})$.*

Proof. Any two ideal triangulations of a hyperbolic marked surface are related by a sequence of flips. Corollary 5.2 plus Lemma 5.9 imply that a flip does not change the set of positive configurations. The second claim follows from Lemma 5.10 and the proof of Theorem 6.2.

5. A constructive proof of Theorem 6.1. Here is a convenient way to spell the definition of a framed local system given by the map $\psi_{\mathbf{T}}$, which we will use to study its monodromy. To simplify the exposition let us assume that $\hat{S} = S$. To describe the answer we use the following picture. Starting from an ideal triangulation T of S , we construct a graph Γ'_T embedded into the surface by drawing small edges transversal to each side of the triangles and inside each triangle connect the ends of edges pairwise by three more edges, as shown on the picture. The edges of the little oriented triangles are called *t*-edges. The edges dual to the edges of the triangulation T are called *e*-edges.

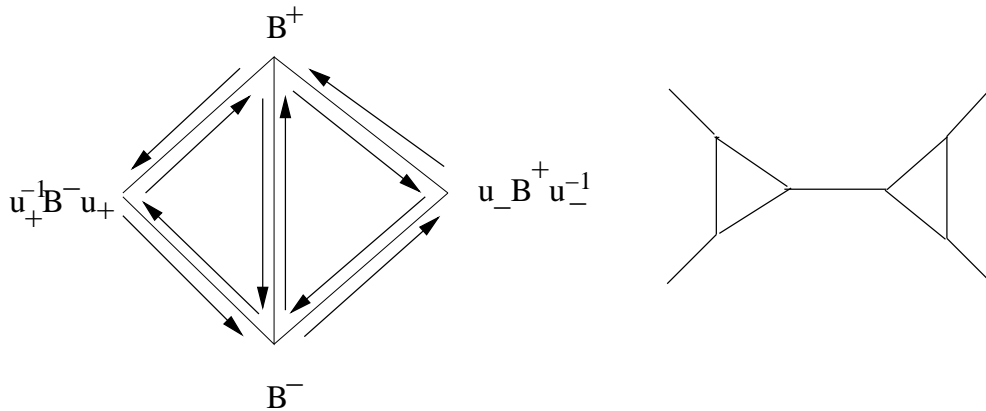

FIG. 6.7. — The graph Γ'_T .

Given a left principal homogeneous G -space P , a point $p_0 \in P$, and a configuration (p_1, p_2) of two points in P (that is, a pair of points in P consid-

ered up to the left diagonal action of G), there is an element $g_{p_0}(p_1, p_2) \in G$ defined as follows:

$$g_{p_0}(p_1, p_2) := g_1^{-1}g_2 \in G, \quad \text{where } p_1 = g_1p_0, g_2 = g_2p_0. \quad (6.12)$$

We will apply this construction to the principal homogeneous space of pinnings for G . Recall that we choose a standard pinning $P_0 = (B^-, B^+)$ for G . Every edge of the graph Γ'_T provides a configuration of two pinnings in G , assigned naturally to the vertices of this edge. Indeed, the vertices of the graph on the right of Figure 6.7 match the pinnings assigned to the triangulation on the left. We use only the pinnings compatible with the orientation of S . Therefore we can assign to every oriented edge \mathbf{a} of the graph Γ'_T an element $M(\mathbf{a}) \in G$. Namely, it is the element assigned by (6.12) to the configuration of two pinnings attached to the oriented edge \mathbf{a} , and the standard pinning P_0 . It follows from the very definitions that these elements enjoy the following properties:

- 1) $M(\mathbf{a})M(\bar{\mathbf{a}}) = \text{Id}$, where $\bar{\mathbf{a}}$ denotes the edge as \mathbf{a} taken with the opposite orientation.
- 2) $M(\mathbf{t}_1)M(\mathbf{t}_2)M(\mathbf{t}_3) = \text{Id}$, where the oriented edges $\mathbf{t}_1, \mathbf{t}_2, \mathbf{t}_3$ make a small oriented triangle on the graph Γ'_T .

Thanks to 1) the elements $\{M(\mathbf{a})\}$ define a G -local system on the graph Γ'_T . Thanks to 2) it is descended to a G -local system on the graph Γ . Since Γ is homotopy equivalent to S , we got a G -local system on S .

6. Proof of Theorem 1.8. Given a loop on S , let us shrink it to a loop on Γ'_T . We may assume that this loop contains no consecutive t -edges: indeed, a composition of two t -edges is a t -edge. Thus we may choose an initial vertex on the loop so that the edges have the pattern $et\dots etet$. Let t and e be consecutive t - and e -edges of the graph Γ'_T . Then there is a unique way to orient them so that e goes after t , i.e. the oriented edge \mathbf{e} starts at the end of the one \mathbf{t} . We say that a t -edge is oriented clockwise if it is compatible with the clockwise orientation of the corresponding triangle. Therefore the monodromy is computed as a product of elements of type $M(\mathbf{e})M(\mathbf{t})$, where \mathbf{e} follows after \mathbf{t} .

This construction defines the universal framed G -local system on \widehat{S} . Recall the semifield $\mathbf{F}_{G,S}^+$ of positive rational functions on the moduli space $\mathcal{X}_{G,S}$ for the positive atlas defined above.

6.1. Proposition. — *Let t and e be two consecutive t - and e -edges of the graph Γ'_T . Let us orient them so that \mathbf{e} goes after \mathbf{t} . Then*

$$M(\mathbf{e})M(\mathbf{t}) \in \begin{cases} B^+(\mathbf{F}_{G,S}^+) & \text{if } \mathbf{t} \text{ is oriented clockwise} \\ B^-(\mathbf{F}_{G,S}^+) & \text{if } \mathbf{t} \text{ is oriented counterclockwise.} \end{cases}$$

Proof. We have to consider separately the cases when \mathbf{t} is oriented clockwise, or counterclockwise, i.e. $\mathbf{t} = \mathbf{t}_1$ or $\mathbf{t} = \mathbf{t}_2$ where \mathbf{t}_1 and \mathbf{t}_2 are as on Figure 6.8.

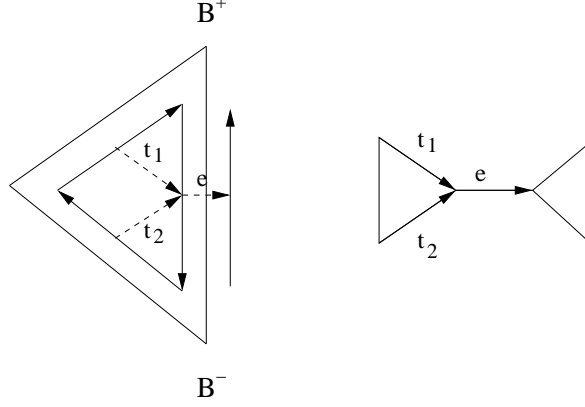

FIG. 6.8. — The oriented edges \mathbf{t}_1 and \mathbf{t}_2 on the graph Γ'_T .

We denote by $[B_1, B_2, B_3]$ triples of flags, to distinguish from configurations of flags, and by $g \cdot [B_1, B_2, B_3]$ the result of the action of $g \in G$ on the triple $[B_1, B_2, B_3]$.

Case 1: $\mathbf{t} = \mathbf{t}_1$. Let $u_+ = h_+(\bar{u}_+)$ and $u_- = h_-(\bar{u}_-)$, where $h_{\pm} \in H$ acts on U^{\pm} by conjugation. We refer to Figure 6.7 for the definition of u_+ and u_- . Then we have

$$\begin{aligned} [u_+^{-1}B^-u_+, B^+, B^-] &= u_+^{-1} \cdot [B^-, B^+, u_+B^-u_+^{-1}] = u_+^{-1}h_+ \cdot [B^-, B^+, \bar{u}_+B^-\bar{u}_+^{-1}] \\ &= u_+^{-1}h_+ \cdot [B^-, B^+, \phi(\bar{u}_+)B^+\phi(\bar{u}_+)^{-1}]. \end{aligned}$$

On the other hand

$$[B^-, B^+, u_-B^+u_-^{-1}] = h_- \cdot [B^-, B^+, \bar{u}_-B^+\bar{u}_-^{-1}]. \quad (6.13)$$

Let $h(\phi(\bar{u}_+))\overline{(\phi(\bar{u}_+))} = \phi(\bar{u}_+)$. Observe that $h(\phi(\bar{u}_+)) \in H$. Then

$$M(\mathbf{e})M(\mathbf{t}_1) = h(\phi(\bar{u}_+))^{-1}h_+^{-1}u_+h_- = h(\phi(\bar{u}_+))^{-1}\bar{u}_+h_+^{-1}h_- \in B^+(\mathbf{F}_{G,S}^+).$$

Indeed, $h_+^{-1}h_-$ is the H -invariant, and $h(\phi(\bar{u}_+))^{-1}$ is a positive rational function by positivity of ϕ .

Case 2: $\mathbf{t} = \mathbf{t}_2$. We have

$$\begin{aligned} [B^-, u_+^{-1}B^-u_+, B^+] &= [B^-, \phi(u_+)^{-1}B^+\phi(u_+), B^+] = \\ &= \phi(u_+)^{-1} [B^-, B^+, \phi(u_+)B^+\phi(u_+)^{-1}] = \end{aligned}$$

$$\begin{aligned}
 &= \phi(u_+)^{-1} h_+ [B^-, B^+, \phi(\bar{u}_+) B^+ \phi(\bar{u}_+)^{-1}] = \\
 &= \phi(u_+)^{-1} h_+ h(\phi(\bar{u}_+)) [B^-, B^+, \overline{\phi(\bar{u}_+)} B^+ \overline{\phi(\bar{u}_+)}^{-1}].
 \end{aligned}$$

Comparing with (6.13), and using the fact that $u_+ = h_+ \bar{u}_+ h_+^{-1}$ implies $\phi(u_+) = h_+ \phi(\bar{u}_+) h_+^{-1}$, we get

$$\begin{aligned}
 M(\mathbf{e})M(\mathbf{t}_2) &= h(\phi(\bar{u}_+))^{-1} h_+^{-1} \phi(u_+) h_+ h_+^{-1} h_- = \\
 &= h(\phi(\bar{u}_+))^{-1} \phi(\bar{u}_+) h_+^{-1} h_- \in B^-(\mathbf{F}_{G,S}^+).
 \end{aligned}$$

Indeed, $h_+^{-1} h_-$ is the H -invariant, and $\phi(\bar{u}_+)$ is positive. The Proposition is proved.

Let us return to the proof of the theorem. A loop on S contains elements of just one kind, B^+ or B^- , if and only if it is homotopic to the loop around a boundary component. Therefore the monodromy around any non-boundary loop is obtained as a product of elements both from $B^-(\mathbf{F}_{G,S}^+)$ and $B^+(\mathbf{F}_{G,S}^+)$. Thus it lies in $G(\mathbf{F}_{G,S}^+)$. The theorem is proved.

Example. Let $G = PGL_2$, $u_+ = \begin{pmatrix} 1 & y \\ 0 & 1 \end{pmatrix}$, $u_- = \begin{pmatrix} 1 & 0 \\ x & 1 \end{pmatrix}$. Then

$$(B^-, u_+^{-1} B^- u_+, B^+, u_- B^- u_-^{-1}) = (\infty, -y^{-1}, 0, x) = (\infty, -1, 0, xy).$$

The edge invariant equals xy , and coincides with the cross-ratio of the corresponding 4 points on \mathbf{P}^1 .

7. The universal higher Teichmüller \mathcal{X} -space related to G .

6.3. Definition. — *A set C is cyclically ordered if any of its finite subset is cyclically ordered, and any inclusion of finite subsets preserves the cyclic order.*

To define a cyclic order on a set C it is sufficient to specify cyclic orders for all triples and quadruples of elements of C so that the following compatibility condition holds: forgetting any element of any cyclically ordered quadruple we get a triple whose induced cyclic order is the same as the prescribed one. Reversing a cyclic order on C we get a new one.

According to Theorems 5.2 and 5.3 the set of positive n -tuples of flags in $\mathcal{B}(\mathbf{R})$ is invariant under the operation of reversion of the cyclic order.

6.4. Definition. — *i) A dihedral structure on C is a cyclic order considered up to reversion.*

ii) A map β from a set C with given dihedral structure to the flag variety $\mathcal{B}(\mathbf{R})$ is positive if it maps every cyclically ordered quadruple (a, b, c, d) to a positive quadruple of flags $(\beta(a), \beta(b), \beta(c), \beta(d))$.

Remarks. 1. Positive maps are injective. We say that C is a *positive subset* of the flag variety $\mathcal{B}(\mathbf{R})$, if there exists a cyclically ordered set C' and a positive map $\beta : C' \rightarrow \mathcal{B}(\mathbf{R})$ whose image is C .

2. There exist quadruples of flags in \mathbf{RP}^2 such that forgetting any of them we get a positive triple, while the quadruple itself is not positive. For example take four points (x_1, x_2, x_3, x_4) going clockwise on a circle, and consider the tangent flags to the points (x_1, x_3, x_2, x_4) (see [FG3], Lemma 2.3 and 2.4).

Consider the dihedral structure on $\mathbf{P}^1(\mathbf{Q})$ provided by the embedding $\mathbf{P}^1(\mathbf{Q}) \hookrightarrow \mathbf{P}^1(\mathbf{R})$.

6.5. Definition. — *The universal Teichmüller space \mathcal{X}_G^+ is the quotient of the space of positive maps*

$$\beta : \mathbf{P}^1(\mathbf{Q}) \longrightarrow \mathcal{B}(\mathbf{R}) \quad (6.14)$$

by the natural action of the group $G(\mathbf{R})$ on it.

Let $\varphi : C \rightarrow \mathcal{B}(\mathbf{R})$ be a positive map from a cyclically ordered set C . The group $G(\mathbf{R})$ acts on the set of maps from C to $\mathcal{B}(\mathbf{R})$. If a map $\varphi : C \rightarrow \mathcal{B}(\mathbf{R})$ is positive then for any $g \in G(\mathbf{R})$ the map $g\varphi$ is also positive. The $G(\mathbf{R})$ -orbits on the set of positive maps are called *positive configurations of flags in $\mathcal{B}(\mathbf{R})$* .

So \mathcal{X}_G^+ is the space of positive configurations of real flags in $G(\mathbf{R})$ parametrised by $\mathbf{P}^1(\mathbf{Q})$.

Canonical decomposition of \mathcal{X}_G^+ . To parametrise \mathcal{X}_G^+ , let us choose three distinct points on $\mathbf{P}^1(\mathbf{Q})$, called $0, 1, \infty$. Recall the Farey triangulation, understood as a triangulation of the hyperbolic disc with a distinguished oriented edge (= flag). Then we have canonical identifications

$$\mathbf{P}^1(\mathbf{Q}) = \mathbf{Q} \cup \infty = \{\text{vertices of the Farey triangulation}\}. \quad (6.15)$$

The distinguished oriented edge connects 0 and ∞ . So a point of \mathcal{X}_G^+ gives rise to a positive map

$$\{\text{vertices of the Farey triangulation}\} \longrightarrow \mathcal{B}(\mathbf{R})$$

considered up to the action of $G(\mathbf{R})$. Assigning to every Farey triangle the corresponding configuration of the three flags at the vertices, and to every Farey geodesic, oriented in a certain way, the H -invariant of the associated quadruple of flags, we get a canonical map

$$\varphi_G : \mathcal{X}_G^+ \longrightarrow \mathcal{X}_{G,3}^+ \{\text{Farey triangles}\} \times H(\mathbf{R}_{>0}) \{\text{Farey diagonals}\}. \quad (6.16)$$

6.3. Theorem. — *The map (6.16) is an isomorphism.*

Proof. It is completely similar to the one of Theorem 6.1, and thus is omitted.

Example. When $G = PSL_2$ our universal Teichmüller space is essentially the one considered by L. Bers [Bers] and R. Penner [P3].

Recall the *Thompson group* \mathbf{T} of all piece-wise linear automorphisms of $\mathbf{P}^1(\mathbf{Q})$. By definition, for every element $g \in \mathbf{T}$ there is a decomposition of $\mathbf{P}^1(\mathbf{Q})$ into a union of a finite number of segments, which may overlap only at the ends, so that restriction of g to each segment is given by an element of $PGL_2(\mathbf{Q})$ (depending on the segment). It acts on \mathcal{X}_G^+ in an obvious way. Each element of the Thompson group can be presented as a composition of flips.

Let $\Delta \subset PSL_2(\mathbf{Z})$ be a torsion-free finite index subgroup. Denote by \mathcal{H} the hyperbolic disc equipped with the Farey triangulation. Set $S_\Delta := \mathcal{H}/\Delta$. The surface S_Δ inherits an ideal triangulation T_Δ . The higher Teichmüller space $\mathcal{X}_{G,S_\Delta}^+$ is embedded into the universal one \mathcal{X}_G^+ as the subspace of Δ -invariants. Moreover, let

$$\varphi_{G,S_\Delta} : \mathcal{X}_{G,S_\Delta}^+ \xrightarrow{\sim} \mathcal{X}_{G,3}^+ \{\text{triangles of } T_\Delta\} \times H(\mathbf{R}_{>0}) \{\text{diagonals of } T_\Delta\} \quad (6.17)$$

be the decomposition of the higher Teichmüller space according to a triangulation T_Δ of S , where we assume an orientation of the edges of T_Δ is chosen. This isomorphism is obtained by taking the $\mathbf{R}_{>0}$ -points of the spaces in (6.4). Then the isomorphism (6.17) can be obtained by taking the Δ -invariants of the isomorphism (6.16).

8. K -positive equivariant configurations of flags. Let C be a finite cyclic set and $|C| > 2$. Let G be a split semi-simple group over \mathbf{Q} . Recall the positive structure on the configuration space $\text{Conf}_C(\mathcal{B})$ of maps $C \rightarrow \mathcal{B}$ modulo G -conjugation. An inclusion of finite cyclic sets $C_1 \subset C_2$ gives rise to a map of positive spaces, the restriction map:

$$\text{Res}_{C_2/C_1} : \text{Conf}_{C_2}(\underline{\mathcal{B}}) \longrightarrow \text{Conf}_{C_1}(\underline{\mathcal{B}}), \quad (6.18)$$

Therefore there is a functor Conf from the category of finite cyclic sets, with morphisms given by inclusions of sets preserving the cyclic structure to the category of positive spaces. It takes a cyclic set C to the positive space $\text{Conf}_C(\mathcal{B})$.

One can extend the functor Conf to a functor from the category Cyc of possibly infinite (countable) cyclic sets to the category whose objects are

projective limits of positive spaces. We will use only the fact that, for any semifield K , there is a functor from the category Cyc to the category of sets, covariant with respect to K . It takes a cyclic set C to a set $\text{Conf}_C(\mathcal{B})(K)$; if $C_1 \subset C_2$ is an inclusion of cyclic sets, there is the restriction map of sets

$$\text{Res}_{C_2/C_1} : \text{Conf}_{C_2}(\mathcal{B})(K) \longrightarrow \text{Conf}_{C_1}(\mathcal{B})(K).$$

6.6. Definition. — *Let π be a group acting by automorphisms of a cyclic set C . It acts therefore on the set $\text{Conf}_C(\mathcal{B})(K)$. The set of invariants of this action is denoted by $\text{Conf}_{C,\pi}(\mathcal{B})(K)$. It is called the set of π -equivariant K -positive configurations of flags parametrised by C .*

So an element $\mathcal{C} \in \text{Conf}_C(\mathcal{B})(K)$ is π -equivariant if and only if for any subset $C' \subset C$ the elements $\text{Res}_{C'}\mathcal{C}$ and $\text{Res}_{\pi(C')}\mathcal{C}$ coincide in $\text{Conf}_{C'}(\mathcal{B})(K)$.

Remark 1. The set $\text{Conf}_C(\mathcal{B})(K)$ is not necessarily the set of K -points of a positive space in the sense of the definition from Section 4. It is the set of K -points of a *generalised positive space*, but we will not pursue its definition here, working with its K -points only.

Remark 2. Let Γ be a group acting by automorphisms on a cyclic set C and on a group π . Then, for any semifield K , the group Γ acts on the set $\text{Conf}_{C,\pi}(\mathcal{B})(K)$.

The following Lemma is an immediate consequence of Lemma 1.2.

6.4. Lemma. — *Suppose that G has trivial center. Let us assume that K is a semifield in a field F , e.g. $K = \mathbf{R}_{>0}, F = \mathbf{R}$. Then an element $\mathcal{C} \in \text{Conf}_{C,\pi}(\mathcal{B})(K)$ gives rise to a homomorphism*

$$\rho_{\mathcal{C}} : \pi \longrightarrow G(F) \quad \text{well defined modulo } G(F)\text{-conjugation.}$$

9. An application: higher Teichmüller spaces and laminations for closed surfaces. Recall (Sections 1.3, 1.10) the three different cyclic $\pi_1(S)$ -sets assigned to a surface S :

$$\mathcal{F}_{\infty}(S) \subset \mathcal{G}_{\infty}(S) \subset \partial_{\infty}\pi_1(S) \tag{6.19}$$

For a surface without boundary the first one is empty. So for any surface S , open or closed, and any semifield K , there is a set $\text{Conf}_{\mathcal{G}_{\infty}(S),\pi_1(S)}(\mathcal{B})(K)$ with a natural action of the mapping class group on it.

The higher Teichmüller space $\mathcal{X}_{G,S}^+$ was defined for open surfaces in Definition 1.8, and for closed surfaces in Definition 1.10. Here is an “algebraic-geometric” definition, which treats simultaneously higher Teichmüller spaces and lamination spaces for open and closed surfaces.

6.7. Definition. — *Let S be a surface, open or closed. Let G be a split semi-simple algebraic group over \mathbf{Q} with trivial center.*

(i) *The higher Teichmüller space is the space $\text{Conf}_{\mathcal{G}_\infty(S), \pi_1(S)}(\mathcal{B})(\mathbf{R}_{>0})$.*

(ii) *Let \mathbf{A}^t be one of the three tropical semifields \mathbf{Z}^t , \mathbf{Q}^t , \mathbf{R}^t . The set $L_{G,S}(\mathbf{A})$ of G -laminations on S with coefficients in the ring \mathbf{A} is the set $\text{Conf}_{\mathcal{G}_\infty(S), \pi_1(S)}(\mathcal{B})(\mathbf{A}^t)$.*

We will show in Section 7 that the higher Teichmüller space in this definition is the same as the one defined in Definitions 1.8 and 1.10. Further, the set $L_{PGL_2,S}(\mathbf{A})$ coincides with the space of Thurston's integral ($\mathbf{A} = \mathbf{Z}$), rational ($\mathbf{A} = \mathbf{Q}$) or measured ($\mathbf{A} = \mathbf{R}$) laminations on S

Remark. For a closed surface S , $\text{Conf}_{\mathcal{G}_\infty(S), \pi_1(S)}(\mathcal{B})$ is a generalised positive space which is not a positive space in the sense of the definition from Section 4.

7. Higher Teichmüller spaces and their basic properties

In this Section we extend the definition of higher Teichmüller spaces to closed surfaces, and establish basic properties of higher Teichmüller spaces for arbitrary surfaces, with or without boundary. In the very end we propose a conjectural generalisation of the theory of quasifuchsian and Kleinian groups where $PSL_2(\mathbf{C})$ is replaced by an arbitrary semi-simple complex Lie group.

1. Discreteness of positive representations: Proof of Theorem 1.10. Take a positive framed $G(\mathbf{R})$ -local system on a hyperbolic surface S with boundary. Let T be an ideal triangulation of S . Consider a universal cover \tilde{S} and the corresponding triangulation \tilde{T} . The triangulated surface (\tilde{S}, \tilde{T}) is isomorphic to the hyperbolic disc \mathcal{H} with the Farey triangulation. Choose a point \tilde{p} on \tilde{S} and a trivialization of the local system at \tilde{p} . Let $V(\tilde{T})$ be the set of vertices of \tilde{T} . Let us construct a map

$$\beta : V(\tilde{T}) = \mathcal{F}_\infty(S) \rightarrow \mathcal{B}(\mathbf{R}). \quad (7.1)$$

Let \tilde{v} be a vertex of \tilde{T} and $\tilde{\alpha}$ be a path from \tilde{p} to \tilde{v} . Let p, v and α be the corresponding data on S . Let β be a small counterclockwise loop on S surrounding the point v and intersecting with α at one point r . Consider the flag at the fiber of the local system over r provided by the framing. The part of the path α between p and r maps it to the fiber over p , thus giving the desired map β .

The map β has the following properties.

1. Changing the basepoint \tilde{p} or trivialization at \tilde{p} results in a change $\beta \rightarrow g \cdot \beta$ for a certain $g \in G(\mathbf{R})$.
2. The map β is $\pi_1(S)$ -equivariant.
3. β is a positive map.

The first two properties follow directly from the construction. The third one follows from the definition of a positive framed local system if the triple / quadruple of vertices of \tilde{T} constitute vertices of a triangle or quadrilateral. If they do not, there exists a finite polygon of the triangulation \tilde{T} containing all these vertices. One can change the triangulation of this polygon by a finite number of flips so that the original triple/quadruple of points become vertices of one triangle/quadrilateral of the new triangulation. According to Theorem 5.2 if a local system is positive with respect to one triangulation, it is positive with respect to any other one, hence the property.

Let us fix a pair (B^-, B^+) of opposite Borel subgroups in $G(\mathbf{R})$. Consider the following two subsets in the real flag variety:

$$\mathcal{B}^+ := \{u_- \cdot B^+\}, \quad \mathcal{B}^- := \{v_-^{-1} \cdot B^+\}, \quad u_-, v_- \in U^-(\mathbf{R}_{>0}).$$

They are open in $\mathcal{B}(\mathbf{R})$. Let $\overline{\mathcal{B}}^+$ be the closure of \mathcal{B}^+ in $\mathcal{B}(\mathbf{R})$.

7.1. Lemma. — *The sets $\overline{\mathcal{B}}^+$ and \mathcal{B}^- are disjoint.*

Proof. One has $u_- B^+ u_-^{-1} = v_-^{-1} B^+ v_-$ if and only if $u_- = v_-^{-1}$, i.e. $u_- v_- = 1$. Let us show that this is impossible. Recall the projection $\pi : U^- \rightarrow U^-/[U^-, U^-]$. Then $\pi(u_-) = \prod_i x_i(t_i)$ and $\pi(v_-) = \prod_i x_i(s_i)$, where $t_i > 0, s_i \geq 0$, and the product is over all simple positive roots. Thus $0 = \pi(u_- v_-) = \prod_i x_i(t_i + s_i)$. But $t_i + s_i > 0$. This contradiction proves the lemma.

Now fix a triangle of \tilde{T} and let a, b, c be its vertices. The deck transformation along a loop γ sends the triangle (abc) to a triangle $(a'b'c')$ without common interior points with (abc) . Without loss of generality we can assume that the vertices of the triangle $(a'b'c')$ are at the arc between a and c which does not contain b . However the point b' may coincide with a or c . Let us assume first this does not happen. Then, since β is positive, we have a positive quadruple of flags $(\beta(a), \beta(b), \beta(c), \beta(b'))$, and $\beta(b') = \rho(\gamma)\beta(b)$. We may assume that $\beta(a) = B^-, \beta(c) = B^+$. Then $\beta(b) \in \mathcal{B}^-$ and $\beta(b') \in \mathcal{B}^+$. Since \mathcal{B}^- is open, there exists an open neighborhood O of the unit in $G(\mathbf{R})$ such that $g\beta(b) \in \mathcal{B}^-$ for any $g \in O$. Since \mathcal{B}^+ is disjoint with \mathcal{B}^- , $\rho(\gamma) \notin O$. In the case when b' coincides with a or c , we may assume without loss of generality that it coincides with c . Then the argument is the same except

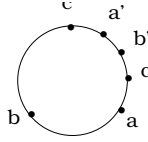

FIG. 7.1. — A deck transformation moves the triangle abc to the one $a'b'c'$.

that in the very end we use the fact that \mathcal{B}^- does not contain B^+ , which is a special case of the lemma. The theorem is proved.

Proofs of Theorems 1.2 and 1.6. Follow from the above constructions.

2. Two results on Higher Teichmüller spaces. According to Theorem 1.6, a framed positive local system (\mathcal{L}, β) on a surface S with boundary is described uniquely by a $\pi_1(S)$ -equivariant positive map

$$\Phi_{\mathcal{L}, \beta} : \mathcal{F}_\infty(S) \longrightarrow \mathcal{B}(\mathbf{R}) \quad \text{modulo } G(\mathbf{R})\text{-conjugation,} \quad (7.2)$$

where $\pi_1(S)$ acts on the flag variety via the monodromy representation of the local system \mathcal{L} .

7.1. Theorem. — *The map (7.2) has a unique extension to a positive $\pi_1(S)$ -equivariant map*

$$\Psi_{\mathcal{L}, \beta} : \mathcal{G}_\infty(S) \longrightarrow \mathcal{B}(\mathbf{R}). \quad (7.3)$$

We will prove this theorem in Sections 7.3-7.5.

7.1. Corollary. — *Let S be a surface, with or without boundary. Then there is a canonical isomorphism, equivariant with respect to the action of the mapping class group of S : $\mathcal{X}_{G,S}^+ \xrightarrow{\sim} \text{Conf}_{\mathcal{G}_\infty(S), \pi_1(S)}(\mathcal{B})(\mathbf{R}_{>0})$.*

Proof. Let us present an element of $\text{Conf}_{\mathcal{G}_\infty(S), \pi_1(S)}(\mathcal{B})(\mathbf{R}_{>0})$ by a positive map $\Psi : \mathcal{G}_\infty(S) \rightarrow \mathcal{B}(\mathbf{R})$. Since $\mathbf{R}_{>0} \subset \mathbf{R}$, by Lemma 6.4 it gives rise to a representation $\rho : \mathcal{G}_\infty(S) \rightarrow G(\mathbf{R})$, and Ψ is ρ -equivariant. This proves the claim for closed S . For open S , one needs in addition Theorem 7.1. The corollary is proved.

7.2. Corollary. — *Let S be a surface, with or without boundary. Then the principal PGL_2 -embedding provides an embedding $\mathcal{X}_{PGL_2, S}^+ \hookrightarrow \mathcal{X}_{G, S}^+$.*

Proof. By Corollary 5.1 there is a canonical embedding of the configuration spaces $\text{Conf}_k^+(\mathbf{P}^1) \hookrightarrow \text{Conf}_k^+(\mathcal{B})$. It remains to use Corollary 7.1. The corollary is proved.

Recall Definition 1.10 of positive local systems for surfaces S with or without boundary. It is clear from Theorems 1.6 and 7.1 that, in the case when S has holes, $\mathcal{L}_{G,S}^+$ is the image of $\mathcal{X}_{G,S}^+$ under the canonical projection $\mathcal{X}_{G,S}(\mathbf{R}) \longrightarrow \mathcal{L}_{G,S}(\mathbf{R})$. For closed S one has $\mathcal{L}_{G,S}^+ = \mathcal{X}_{G,S}^+$.

7.2. Theorem. — *The map (7.3) extends uniquely to a continuous positive map*

$$\bar{\Psi}_{\mathcal{L},\beta} : \partial_\infty \pi_1(S) \longrightarrow \mathcal{B}(\mathbf{R}). \quad (7.4)$$

This map is continuous by Theorem 7.4 below. We will not use it.

Let us prepare the ground for the proof of Theorem 7.1.

3. Positive configurations of flags revisited.

7.3. Theorem. — *For any $m + n \geq 1$, the map*

$$\underbrace{U^+ \times \dots \times U^+}_{m+n \text{ copies}} / H \longrightarrow \text{Conf}_{m+n+2}(\mathcal{B}), \quad (v_1, \dots, v_m, u_1, \dots, u_n) \longmapsto \quad (7.5)$$

$$\left(B^+, (v_1 \dots v_m)^{-1} \cdot B^-, \dots, (v_{m-1} v_m)^{-1} \cdot B^-, v_m^{-1} \cdot B^-, \right.$$

$$\left. B^-, u_1 \cdot B^-, u_1 u_2 \cdot B^-, \dots, u_1 \dots u_n \cdot B^- \right),$$

where the quotient is by the diagonal action of H , provides a positive atlas on $\text{Conf}_{m+n+2}(\mathcal{B})$.

Proof. Let us first prove the claim of the theorem in the special case $m = 0$. When $n = 1$, it follows from the very definition of the positive atlas on $\text{Conf}_3(\mathcal{B})$. In the case $n = 2$ we define a positive atlas on $\text{Conf}_4(\mathcal{B})$ by using a map

$$(U^+ \times U^+) / H \longrightarrow \text{Conf}_4(\mathcal{B}), \quad (v, u) \longrightarrow (B^+, v^{-1} \cdot B^-, B^-, u \cdot B^-).$$

Acting by v , we transform the last configuration to the one $(B^+, B^-, v \cdot B^-, v u \cdot B^-)$, proving the claim. Now let $n > 2$. Let (B_1, \dots, B_{n+2}) be a configuration of flags, and $B_1 = B^+, B_2 = B^-$. Let us consider an $(n+2)$ -gon whose vertices are decorated by the flags B_i , so that the cyclic order of the vertices coincides with the one induced by the order of the flags. Consider the triangulation of the $(n+2)$ -gon by the diagonals from the vertex decorated by B^+ , see Figure 6.7. Then the claim of the theorem for $n = 1$ and $n = 2$ implies that the map

$$\underbrace{U^+ \times \dots \times U^+}_{n \text{ copies}} / H \longrightarrow \text{Conf}_{n+2}(\mathcal{B});$$

$$(u_1, \dots, u_n) \longmapsto (B^+, B^-, u_1 \cdot B^-, u_1 u_2 \cdot B^-, \dots, u_1 \dots u_n \cdot B^-)$$

is positive. In the general case we observe that multiplying the configuration (7.5) by the element $v_1 \dots v_m \in U^+$ we transform it to an equivalent configuration

$$\left(B^+, B^-, v_1 \cdot B^-, \dots, v_1 \dots v_m \cdot B^-, v_1 \dots v_m u_1 \cdot B^-, \dots, v_1 \dots v_m u_1 \dots u_n \cdot B^- \right).$$

The theorem follows.

7.3. Corollary. — *A configuration of flags, finite or infinite, is positive if and only if it can be written as*

$$\left(B^+, B^-, u_1 \cdot B^-, u_1 u_2 \cdot B^-, \dots, u_1 \dots u_n \cdot B^-, \dots \right), \quad u_i \in U^+(\mathbf{R}_+). \quad (7.6)$$

This shows that Definition 1.4 is equivalent to the one we used in Section 5.

7.2. Lemma. — *The $(n+2)$ -tuple of flags (7.6) representing a positive configuration is well defined up to the action of the positive tori $H(\mathbf{R}_{>0})$.*

Proof. Suppose we have an $(n+2)$ -tuple of flags corresponding to (u'_1, \dots, u'_n) , where $u'_i \in U(\mathbf{R}_{>0})$, representing the same configuration (7.6). Then there exists an element of $H(\mathbf{R})$ conjugating one to the other. The projection of u to the maximal abelian quotient $U^+/[U^+, U^+]$ has natural positive coordinates u_α parametrised by the simple roots α . The element $t \in H(\mathbf{R})$ acts on u_α by multiplication on $\chi_\alpha(t)$. Thus $\chi_\alpha(t) > 0$ for every simple root α . Since G has trivial center, this implies that $t \in H(\mathbf{R}_{>0})$. The lemma is proved.

4. Semi-continuity of positive subsets of real flag varieties.

7.1. Definition. — *Let C be a cyclically ordered set. A map $\varphi : C \rightarrow \mathcal{B}(\mathbf{R})$ is semi-continuous from the left if for any sequence of distinct points c_0, \dots, c_n, \dots in C , whose order is compatible with the cyclic order of C , the limit $\lim_{n \rightarrow \infty} \varphi(c_n)$ exists.*

A positive configuration in $\mathcal{B}(\mathbf{R})$ is semi-continuous from the left if a map $\varphi : C \rightarrow \mathcal{B}(\mathbf{R})$ representing it is semi-continuous from the left.

Changing the cyclic order to the opposite one we define maps *semi-continuous from the right*.

7.4. Theorem. — *A positive map $\varphi : C \rightarrow \mathcal{B}(\mathbf{R})$ is semi-continuous from the left and from the right.*

If $\lim_{n \rightarrow \infty} \varphi(c_n) \neq \varphi(c_i)$ for $i \geq 0$, then adding the limit flag we get a positive configuration.

Precisely, in the second statement we define a new cyclic set $C' := (c_\infty, c_0, c_1, \dots)$, and extend the map φ to a map φ' on C' by setting $\varphi'(c_\infty) := \lim_{n \rightarrow \infty} \varphi(c_n)$.

Proof. Set $B_i := \varphi(c_i)$. By Corollary 7.3 the configuration of flags $(B_2, B_3, B_4, \dots, B_0, B_1)$ can be written as

$$(B^-, v_3 \cdot B^-, v_4 \cdot B^-, \dots, v_n \cdot B^-, \dots, v_0 \cdot B^-, B^+); \quad v_k = u_3 u_4 \dots u_k, \quad u_i, v_0 \in U^+(\mathbf{R}_{>0}). \quad (7.7)$$

Moreover we may assume that for every $n \geq 3$ one has $v_0 = v_n v'_n$ with $v'_n \in U^+(\mathbf{R}_{>0})$.

By Proposition 3.2 in [L1], for any finite dimensional representation ρ of G in a vector space V , any element u of $U(\mathbf{R}_{>0})$ acts in the canonical basis in V by a matrix with non-negative elements. The values of each of the matrix elements in the sequence $\rho(v_i)$, $i = 3, 4, \dots$, provide a non-decreasing sequence of real numbers bounded by the value of the corresponding matrix element of $\rho(v_0)$. Thus there exists the limit $\lim_{i \rightarrow \infty} \rho(v_i)$. Further, if $u \in U(\mathbf{R}_{>0})$ and $v \in U(\mathbf{R}_{\geq 0})$, then $uv \in U(\mathbf{R}_{>0})$. The Theorem is proved.

5. Proof of Theorems 7.1 and 7.2. Recall the following result of Lusztig ([L1], Theorem 5.6), generalizing the Gantmacher-Krein theorem in the case $G = GL_n(\mathbf{R})$.

7.5. Theorem. — *Let $g \in G(\mathbf{R}_{>0})$. Then there exists a unique \mathbf{R} -split maximal torus of G containing g . In particular, g is regular and semi-simple.*

7.4. Corollary. — *Let $g \in G(\mathbf{R}_{>0})$. Then there is a unique real flag B^{at} (the attracting flag) such that for any flag B in a Zariski open subset of $\mathcal{B}(\mathbf{C})$ containing B^{at} the sequence $\{g^n B\}$, $n \rightarrow \infty$, converges to the flag B^{at} .*

Proof. It follows from Theorem 7.5 that g is conjugate to the unique element $h \in H(\mathbf{R}_{>0})$ such that $\chi_\alpha(h) > 1$ for every (simple) positive root α , where χ_α is the root character corresponding to α . The flags containing h are wB^+w^{-1} , $w \in W$. The flag B^+ is the unique flag with the desired property. The Lemma is proved.

Proof of Theorem 7.1. Let us choose an orientation of a closed geodesic γ . Let M_γ be the monodromy of the local system along the oriented loop γ . Take a lift $\tilde{\gamma}$ of γ to the universal cover. Let μ_γ be the deck transformation along the oriented path $\tilde{\gamma}$. Let p_+ be the attracting point for μ_γ . It is an end of $\tilde{\gamma}$. Then take two points x_+ and x_- in $\mathcal{F}_\infty(S)$, located on the different sides of $\tilde{\gamma}$. Applying transformations μ_γ^n we get two sequences of points, $\{x_+^n\}$ and $\{x_-^n\}$, converging to p_+ from two different sides. The

configuration of flags $\Phi_{\mathcal{L},\beta}(x_+^m, x_-^1, \dots, x_-^n, \dots)$ is positive. Thus by Theorem 7.4 there exists $\lim_{n \rightarrow \infty} \Phi_{\mathcal{L},\beta}(x_-^n)$. It must coincide with the unique attracting flag $B^{\text{at}}(M_\gamma)$ for the monodromy operator M_γ . Similarly for the sequence $\{x_+^n\}$. Thus

$$\lim_{n \rightarrow \infty} \Phi_{\mathcal{L},\beta}(x_-^n) = \lim_{n \rightarrow \infty} \Phi_{\mathcal{L},\beta}(x_+^n) = B^{\text{at}}(M_\gamma).$$

We set $\Psi_{\mathcal{L},\beta}(p_+)$ to be equal to this flag. Observe that $B^{\text{at}}(M_\gamma)$ does not coincide with $\Phi_{\mathcal{L},\beta}(x_\pm^n)$. Indeed, the latter ones are not stable by M_γ , since x_\pm^n is not stable by μ_γ . The positivity of $\Psi_{\mathcal{L},\beta}(x_+^m, x_-^1, \dots, x_-^n, \dots, p_+)$ follows now from Theorem 7.4. The Theorem is proved.

Proof of Theorem 7.2. Let us choose a hyperbolic metric on S , and a geodesic α on \mathcal{H} ending at a point $p_+ \in \partial_\infty \pi_1(S) \subset \partial \mathcal{H}$. We assume that $p_+ \notin \mathcal{G}_\infty \pi_1(S)$. Choose a fundamental domain \mathcal{D} for $\pi_1(S)$ acting by the deck transformations on \mathcal{H} . Choose elements $g_i \in \pi_1(S)$ such that $g_i \mathcal{D}$ intersects α , and, as $i \rightarrow \infty$, approaches p_+ . Denote by λ_i the distance between the domains \mathcal{D} and $g_i \mathcal{D}$. According to Section 5, the images of non-boundary elements of $\pi_1(S)$ under a positive representation ρ are conjugate to elements of $G(\mathbf{R}_{>0})$. In particular, this is so for g_i , so for any real λ there exists $\rho(g_i)^\lambda$.

7.3. Lemma. — *Let ρ be a positive representation of $\pi_1(S)$ to $G(\mathbf{R})$. Then the set $\{\rho(g_i)^{1/\lambda_i}\}$ is bounded. Thus there exists a subsequence $\{g_j\}$ for which there exists the limit $g_\alpha := \lim_{j \rightarrow \infty} \rho(g_j)^{1/\lambda_j}$.*

Proof. The group $\pi_1(S)$ equipped with the word metric is quasiisometric to \mathcal{H} (cf. [Bon]). Since it is finitely generated, the Lemma follows.

The element $\rho(g_\alpha)$ is conjugate to an element of $H^0(\mathbf{R}_{>0})/W$. Thus there is a unique attracting flag $B^{\text{at}}(\rho(g_\alpha))$ for it. Further, let x^+ and x^- be the endpoints of two geodesics lifting closed geodesics on S . We assume that x^+ and x^- are located on different sides of α . Then $x_j^\pm := g_j x^\pm$ are also endpoints of liftings of closed geodesics, one has $\lim_{j \rightarrow \infty} g_j x^\pm = p_+$, and

$$\lim_{j \rightarrow \infty} \Phi_{\mathcal{L},\beta}(x_j^+) = B^{\text{at}}(\rho(g_\alpha)); \quad \lim_{j \rightarrow \infty} \Phi_{\mathcal{L},\beta}(x_j^-) = B^{\text{at}}(\rho(g_\alpha)) \quad (7.8)$$

We define $\bar{\Phi}_{\mathcal{L},\beta}(p_+)$ to be the attracting flag of $\rho(g_\alpha)$. Thanks to (7.8), it is the limit of flags assigned by $\Psi_{\mathcal{L},\beta}$ to the points of $\mathcal{G}_\infty \pi_1(S)$ converging to p_+ . In particular it is independent of the choice of α . The theorem is proved.

6. The cutting and gluing maps on the level of Teichmüller spaces. Let (S, μ) be a surface with a hyperbolic metric μ and a geodesic boundary. Cutting S along a non-boundary geodesic γ we obtain a surface S' with the induced metric. It has a geodesic boundary. Thus we have a

map of Teichmüller spaces $\mathcal{T}_S \rightarrow \mathcal{T}_{S'}$, which we call the *cutting along γ* map. On the other hand, if S' is a surface consisting of one or two components, with geodesic (and non-cuspidal) boundary, and the lengths of two boundary components γ_1 and γ_2 coincide and are different from zero, (i.e. the corresponding ends are not cusps), then we can glue S' by gluing these curves, getting a surface S . There is a one-parameter family of hyperbolic structures on S which, being restricted to S' , give the original hyperbolic structure there. It is a principal homogeneous space over the additive group \mathbf{R} . Thus, if $\mathcal{T}_{S'}(\gamma_1, \gamma_2)$ is the subset of the space of hyperbolic structures on S such that the lengths of the boundary geodesics γ_1 and γ_2 are different from zero and coincide, then there is a principal \mathbf{R} -fibration

$$\mathcal{T}_S \longrightarrow \mathcal{T}_{S'}(\gamma_1, \gamma_2).$$

In particular this allows us to describe \mathcal{T}_S if we know $\mathcal{T}_{S'}$.

Below we generalize this to higher Teichmüller spaces.

Let γ be the homotopy class of a simple loop on a surface S , which is neither trivial nor homotopic to a boundary component. Cutting S along γ we get a new surface S' . It is either connected or has two connected components. The surface S' has two new boundary components, denoted γ_+ and γ_- . Their orientations are induced by the orientation of S' .

The induced framing. Let (\mathcal{L}, β) be a positive framed $G(\mathbf{R})$ -local system on S . Let \mathcal{L}' be the restriction of \mathcal{L} to S' . There is a canonical framing β' on \mathcal{L}' extending β . Namely, the framing at the boundary components of S' inherited from S is given by β . According to Theorem 1.8, the monodromy M_γ along the loop γ is conjugate to an element of $G(\mathbf{R}_{>0})$. Thus we can apply Corollary 7.4, and take the attracting flag for the monodromy μ_γ as the framing. Changing the orientation of γ we arrive at a different flag. Thus, using the canonical orientations of the boundary loops γ_+ and γ_- , we get canonical framings assigned to the boundary components γ_+ and γ_- . We call (\mathcal{L}', β') the *induced framed local system on S'* .

Similarly, let S be an oriented surface with boundary. Let \mathcal{L} be positive $G(\mathbf{R})$ -local system on S . Then there is a *canonical framing* on \mathcal{L} defined as follows. For each boundary component γ , whose orientation is induced by the one on S , take the unique attracting flag invariant by the monodromy along γ . The existence of such a flag is clear when the monodromy is positive hyperbolic, and in general follows from the fact that the monodromy around a boundary component is conjugate to an element of $B(\mathbf{R}_{>0})$. This way we get a canonical embedding

$$\mathcal{L}_{G,S}^+ \hookrightarrow \mathcal{X}_{G,S}^+ \tag{7.9}$$

Recall the complement H^0 to the hyperplanes $\text{Ker}\chi_\alpha$ in H , where χ_α runs through all root characters of H . It is the part of H where the Weyl group W acts freely.

7.2. Definition. — *The submanifold $\mathcal{X}_{G,S'}^+(\gamma_+, \gamma_-) \subset \mathcal{X}_{G,S'}(\mathbf{R}_{>0})$ is given by the following conditions:*

- (i) *The monodromies along the oriented loops γ_+ and γ_- are mutually inverse, and lie in $H^0(\mathbf{R}_{>0})/W$.*
- (ii) *The framing along the boundary component γ_+ (resp. γ_-) is given by the attracting flag for the monodromy μ_{γ_+} (resp. μ_{γ_-}).*

7.6. Theorem. — *Let S be a surface with or without boundary, $\chi(S) < 0$. Let γ be a non-trivial loop on S , non-homotopic to a boundary component, cutting S into one or two surfaces. Denote by S' their union. Then*

- (i) *The induced framed $G(\mathbf{R})$ -local system (\mathcal{L}', β') on S' is positive, i.e. lies in $\mathcal{X}_{G,S'}(\mathbf{R}_{>0})$. There is a well-defined map, called the cutting map:*

$$C_\gamma : \mathcal{X}_{G,S}(\mathbf{R}_{>0}) \longrightarrow \mathcal{X}_{G,S'}^+(\gamma_+, \gamma_-); \quad (\mathcal{L}, \beta) \longmapsto (\mathcal{L}', \beta'). \quad (7.10)$$

- (ii) *The cutting map (7.10) is a principal $H(\mathbf{R}_{>0})$ -bundle.*
- (iii) *The space $\mathcal{X}_{G,S'}^+(\gamma_+, \gamma_-)$ is diffeomorphic to a ball of dimension $-\chi(S)\dim G - \dim H$.*

The part (i) of Theorem 7.6 means that, given a positive framed local system on S' , cutting along γ provides a positive framed local system on S .

The part (ii) of Theorem 7.6 means that, given a positive framed local system on S , we can glue it to a positive framed local system on S' if and only if the gluing conditions of Definition 7.2 are satisfied. Further, the family of positive local systems on S with given restrictions to S' is a principal homogeneous space for the group $H(\mathbf{R}_{>0})$.

The proof of Theorem 7.6 will be given in Sections 7.7 - 7.8.

7. The cutting and gluing on the level of boundary at infinity of π_1 . Let S_1 and S_2 be oriented surfaces with boundary, and with negative Euler characteristic. Gluing them along boundary circles γ_1 and γ_2 , where $\gamma_i \in \partial S_i$, we get an oriented surface S with $\chi(S) = \chi(S_1) + \chi(S_2) < 0$. Let γ be the loop on S obtained by gluing γ_1 and γ_2 . Cutting S along γ we recover S_1 and S_2 .

Let us choose a hyperbolic metric on S such that the boundary of S is geodesic. We may assume that γ is a geodesic for this structure. Then S_1 and S_2 inherit hyperbolic metrics with geodesic boundaries. Denote by D_i (resp. D) the universal cover of S_i (resp. S). Then D_i is an infinite ‘‘polygon’’

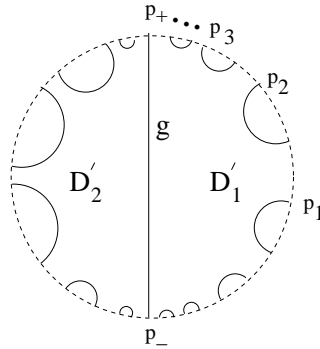
FIG. 7.2. — Gluing D out of D_1 and D_2 .

whose boundary consists of geodesics and segments of the absolute. It is obtained by cutting out of the hyperbolic plane \mathcal{H} discs bounded by geodesics. We say that two boundary geodesics on D_i are equivalent if they project to the same boundary component of S_i . Both D_1 and D_2 have distinguished equivalence classes of boundary geodesics: the ones which project to γ . We call them marked boundary geodesics.

One can glue D from infinitely many copies of D_1 and D_2 as follows, see Figure 7.2. Observe that given a geodesic g on \mathcal{H} we can move by an element of $PGL_2(\mathbf{R})$ the “polygons” D_1 and D_2 so that $D_1 \cap D_2 = g$. Now let us take the domain D_1 , and glue to each marked boundary geodesic on it a copy of the domain D_2 along a marked geodesic on the latter. Then for each of the obtained domains we glue a copy of D_1 along every marked boundary geodesic on it, and so on infinitely many times.

7.4. Lemma. — *The domain glued in this way is identified with the fundamental domain D . So the group $\pi_1(S)$ acts by automorphisms of D .*

Proof. Let $p_1 : D_1 \rightarrow S_1$ and $p_2 : D_2 \rightarrow S_2$ be the universal covering maps. Then there is a unique map $p : D \rightarrow S$ such that its restriction to a copy of the domain D_i in D is provided by the map p_i . Since by the very construction the domain D is connected and simply connected, and the map p is a covering, D must be the universal cover. The lemma is proved.

Recall the cyclic $\pi_1(S)$ -sets $\mathcal{G}_\infty(S)$ and $\partial_\infty \pi_1(S)$. Let us address the following

Problem. (i) How to construct the cyclic $\pi_1(S)$ -set $\partial_\infty \pi_1(S)$ out of the ones $\partial_\infty \pi_1(S_1)$ and $\partial_\infty \pi_1(S_2)$?

(ii) The same question about the cyclic $\pi_1(S)$ -set $\mathcal{G}_\infty(S)$.

Construction. (i) Since S_i has a boundary, $\partial_\infty\pi_1(S_i)$ is a Cantor set given by the union of the segments of the absolute belonging to the fundamental domain D_i . The description of D as the domain obtained by gluing infinitely many copies of domains D_i , see Lemma 7.4, provides us with an answer: gluing the absolute parts of the boundaries of the domains D_i , we get a $\pi_1(S)$ -set with a cyclic structure, which is isomorphic to $\partial_\infty\pi_1(S)$.

(ii) Clearly an answer to (i) implies an answer to (ii).

Now suppose that we get S by gluing two boundary circles γ_- and γ_+ on a surface S' . The boundary circles are glued to a loop γ on S . Choose a hyperbolic metric on S' with geodesic boundary. Then S inherits a hyperbolic metric, and γ is a geodesic. We construct the universal cover D of S by gluing copies of the universal cover D' for S' as follows. Choose two copies, D^- and D^+ of D' . Each of them has a family of marked boundary geodesics: the ones on D^\pm which project to γ_\pm . Then repeat the described above gluing process: glue copies of D^- to a single copy of D^+ along marked boundary geodesics, and so on. In the end we get the fundamental domain D . This way we also get the boundary at infinity $\partial_\infty\pi_1(S)$, understood as a cyclic $\pi_1(S)$ -set, glued from infinitely many copies of $\partial_\infty\pi_1(S')$.

Proof of the part (i) of Theorem 7.6. It follows immediately from the discussion above and Theorem 7.1.

To prove the part (ii) of Theorem 7.6 we need to glue positive configurations of flags.

8. Gluing positive configurations of flags. Let

$$P = (p_+, p_-, p_1, \dots, p_n), \quad Q = (p_-, p_+, q_1, \dots, q_m); \quad P \cap Q = \{p_-, p_+\}$$

be two cyclic sets, which may be infinite, i.e. $n = \infty$ or $m = \infty$. We can glue P and Q along the subset $\{p_+, p_-\}$, see Figure 7.3, getting a cyclic set

$$P * Q = (p_+, q_1, \dots, q_m, p_-, p_1, \dots, p_n).$$

Let

$$\beta_P : P \longrightarrow \mathcal{B}(\mathbf{R}), \quad \beta_Q : Q \longrightarrow \mathcal{B}(\mathbf{R})$$

be two positive configurations of flags. Recall that “configurations” means that we consider each of them modulo $G(\mathbf{R})$ -action. We would like to glue them to get a positive configuration of flags

$$\beta_{P*Q} : P * Q \longrightarrow \mathcal{B}(\mathbf{R}) \tag{7.11}$$

such that its restriction to the subset P (resp. Q) is the configuration β_P (resp. β_Q). We can always assume that $\beta_{P*Q}(p_+, p_-) = (B^+, B^-)$. The stabilizer of this pair of flags is the Cartan subgroup $B^+ \cap B^- = H$.

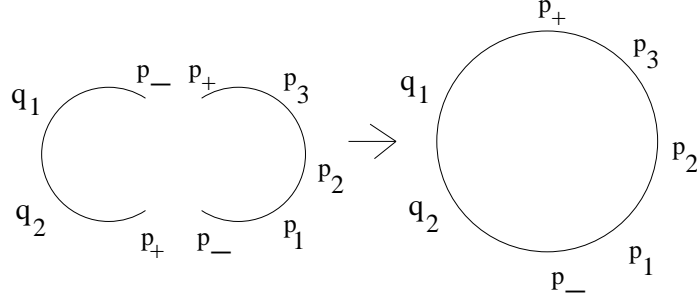

FIG. 7.3. — Gluing two cyclic sets along their common two-element subset.

7.7. Theorem. — *There is a family of positive configurations of flags (7.11) obtained by gluing two given positive configurations β_P and β_Q . This family is a principal homogeneous $H(\mathbf{R}_{>0})$ -space.*

Proof. According to Theorem 7.3, we can present the configurations β_P and β_Q as follows:

$$\beta_P = (B^+, B^-, u_1 \cdot B^-, u_1 u_2 \cdot B^-, \dots, u_1 \dots u_n \cdot B^-), \quad u_i \in U^+(\mathbf{R}_{>0});$$

$$\beta_Q = (B^-, B^+, (v_1 \dots v_m)^{-1} \cdot B^-, (v_2 \dots v_m)^{-1} \cdot B^-, \dots, (v_m)^{-1} \cdot B^-), \quad v_i \in U^+(\mathbf{R}_{>0})$$

Further, we can modify the second configuration by acting by an element $h \in H(\mathbf{R}_{>0})$ on it: this changes neither the flags (B^+, B^-) , nor the positivity of the elements v_i . Observe however that the action of any element of $H(\mathbf{R}) - H(\mathbf{R}_{>0})$ would destroy positivity of the v_i 's. Then we can glue the two configurations to a single one:

$$\beta_{P*Q} := (B^+, (v_1 \dots v_m)^{-1} \cdot B^-, \dots, v_m^{-1} \cdot B^-, B^-, u_1 \cdot B^-, u_1 u_2 \cdot B^-, \dots, u_1 \dots u_n \cdot B^-).$$

It is positive thanks to Theorem 7.3. The theorem is proved.

Proof of the parts (ii) and (iii) of Theorem 7.6. Let us assume first that $S' = S_1 \cup S_2$. By Theorems 1.2 and 7.1 when S has boundary, and by Definition 1.10 when S has no boundary, a positive framed local $G(\mathbf{R})$ -system on S_i is the same thing as a $\pi_1(S_i)$ -equivariant positive map

$$\Psi_i : \mathcal{G}_\infty(S_i) \longrightarrow \mathcal{B}(\mathbf{R}) \quad \text{modulo } G(\mathbf{R})\text{-conjugation.}$$

According to Lemma 7.4, $\mathcal{G}_\infty(S)$ is glued from infinitely many copies of $\mathcal{G}_\infty(S_i)$ for $i = 1, 2$. Each time when we glue the next domain we glue two cyclic sets along the 2-element subset given by the endpoints of the unique marked boundary geodesic shared by the glued domains. Therefore thanks to Theorem 7.7 we can glue the positive configurations of flags provided by the maps Ψ_i to a positive map Ψ . The ambiguity of gluing two of these domains,

say D'_1 and D'_2 , is given by the action of $H(\mathbf{R}_{>0})$. As soon as it is fixed, the rest of the gluings are uniquely determined by a requirement which we will formulate below.

Gluing requirement. Let (D''_1, D''_2) be another pair of domains glued along a marked geodesic. Then there exists an element $g \in \pi_1(S)$ transforming (D'_1, D'_2) to (D''_1, D''_2) . It is defined uniquely up to elements of the subgroup of $\pi_1(S)$ generated by the monodromy around the marked geodesic. Denote by $D'_1 * D'_2$ the domain obtained by gluing of D'_1 and D'_2 . We require that *the configuration of flags assigned to (the \mathcal{G}_∞ -set on the boundary of) $D'_1 * D'_2$ equals to the one assigned assigned to $D''_1 * D''_2$.*

It follows from Lemma 6.4 that this requirement, plus the fact that the monodromies along the two boundary components γ_+ and γ_- coincide, guarantee that there exists a unique representation $\rho : \pi_1(S) \rightarrow G(\mathbf{R})$, such that the map Ψ , defined by gluing (infinitely many times) of the maps Ψ_1 and Ψ_2 , as above, is ρ -equivariant. Let us spell out the argument in detail. Let $g \in \pi_1(S, x)$, $x \in \gamma$. Let us assume first that g is the homotopy class of the loop γ . Let D'_1 and D'_2 be two initial fundamental domains glued along a geodesic projecting to γ . Then g provides an automorphism of $D'_1 * D'_2$, and thanks to the condition that the monodromies along γ_+ and γ_- coincide, there exists an element $\rho(g) \in G(\mathbf{R})$ such that the map $D'_1 * D'_2 \rightarrow \mathcal{B}(\mathbf{R})$ intertwines the action of g on $D'_1 * D'_2$ and the action of $\rho(g)$ on $\mathcal{B}(\mathbf{R})$. Such an element is unique since the $\text{Center}(G)$ is trivial.

Further, for any $g \in \pi_1(S, x)$, the configurations of flags assigned to $D'_1 * D'_2$ and $g(D'_1 * D'_2)$ are isomorphic. Moreover, each of these configurations is realised as a part of a bigger configuration of flags, the one assigned to $\mathcal{G}_\infty(S)$ after the infinite gluing procedure is done. Thus there exists a unique element $\rho(g) \in G(\mathbf{R})$ transforming the first collection of flags to the second – the uniqueness follows from the assumption that the $\text{Center}(G)$ is trivial. Clearly ρ is a homomorphism.

Remark. Gluing the positive maps Ψ_1 and Ψ_2 , we must assume that the monodromy around loops γ_\pm preserves the flags B^+ and B^- , and positive configurations, and thus is in $H(\mathbf{R}_{>0})$. On the other hand, the monodromy of a positive local system on S_1 around γ_+ is conjugate to $B(\mathbf{R}_{>0})$. One can show that the semisimple elements in $B(\mathbf{R}_{>0})$ are conjugate to $H^0(\mathbf{R}_{>0})$. Therefore gluing positive local systems on S_1 and S_2 we have to assume that their monodromies around γ_\pm are conjugate to an element of $H^0(\mathbf{R}_{>0})$.

To conclude the proof of surjectivity of the cutting map it remains to show that the monodromy of a positive local system on S_1 can be any

element of $H^0(\mathbf{R}_{>0})/W$. Recall the canonical map

$$\pi_p : \mathcal{X}_{G,S} \longrightarrow H, \quad (7.12)$$

provided by the framing and the semi-simple part of the monodromy around a boundary component p of S : the semi-simple part of the monodromy itself gives a map to H/W .

7.5. Lemma. — (i) *There exists a coordinate system from the positive atlas on $\mathcal{X}_{G,S}$ for which the map (7.12) is a monomial map, i.e. is given by a homomorphism of tori $\mathbf{G}_m^{\chi(S)\dim G} \longrightarrow H$.*

(ii) *The fibers of the induced map $\mathcal{X}_{G,S}(\mathbf{R}_{>0}) \rightarrow H(\mathbf{R}_{>0})$ are isomorphic to $\mathbf{R}^{\chi(S)\dim G - \dim H}$.*

Proof. (i) We may assume that S is a surface with punctures. Take an ideal triangulation of S . It follows from the construction of the framed local system given in Section 5 that the monodromy around a puncture p is given by the product of the H -invariants attached to the edges of the triangulation sharing the vertex p .

(ii) The map $z \rightarrow z^k$ is an isomorphism on $\mathbf{R}_{>0}$. Thus according to (i) our map is identified with a real vector space projection $\mathbf{R}^{\chi(S)\dim G} \rightarrow \mathbf{R}^{\dim H}$. The Lemma is proved.

The part i) of the Lemma implies that the monodromy of a positive local system on S_1 around a given boundary component can be any element of $H^0(\mathbf{R}_{>0})/W$.

The part (iii) of the theorem follows from Lemma 7.5. Indeed, since the monodromy around γ_{\pm} lies in $H^0(\mathbf{R}_{>0})/W$, it is semi-simple. Thus, for the surface S' , and the boundary component p corresponding to γ_+ , the fiber of the map π_p restricted to $\mathcal{X}_{G,S}^+$ over an element $m \in H^0(\mathbf{R}_{>0})$ gives the space of positive framed local systems on S' with given semi-simple monodromy m along γ_+ . The case when S' is connected is completely similar. Theorem 7.6 is proved.

Proof of Theorem 1.13. (i). Discreteness is proved by just the same argument as in Theorem 1.2. Faithfulness follows from Theorem 7.6 and the similar fact for surfaces with boundary, proved in Theorem 1.9. To prove that the monodromy around a non-trivial loop γ is positive hyperbolic, we cut S along another curve, so that γ becomes a non-trivial non-boundary loop on the cutted surface, and apply Theorem 7.6 and Theorem 1.9.

(ii). It is sufficient to prove that $\mathcal{L}_{G,S}^+$ is topologically trivial. Since $H(\mathbf{R}_{>0})$ is contractible, this reduces to the similar claim about the moduli space $\mathcal{L}_{G,S'}^+(\gamma_+, \gamma_-)$.

(iii). When S is closed the \mathcal{X}^+ - and \mathcal{L}^+ -Teichmüller spaces are the same. Hence the parts (ii) and (iii) of Theorem 7.6 show that $\mathcal{L}_{G,S}^+$ is a manifold of dimension $-\chi(S')\dim G$, and that it is topologically trivial. The theorem is proved.

7.6. Lemma. — *The canonical map π_p intertwines the natural action of the Weyl group W on $\mathcal{X}_{G,S}$ with the one on H .*

Proof. Clear from the definition.

The canonical map (7.12) provides a map $\pi_p^+ : \mathcal{X}_{G,S}^+ \longrightarrow H(\mathbf{R}_{>0})$.

7.1. Proposition. — *The rational action of the Weyl group W on $\mathcal{X}_{G,S}$ corresponding to a boundary component p of S preserves $(\pi_p^+)^{-1}H^0(\mathbf{R}_{>0})$.*

Proof. Let D be the universal cover of a hyperbolic surface S . Let g be a geodesic lifting the oriented boundary geodesic γ_+ corresponding to the chosen component of S , and let p_-, p_+ be its ends. Changing the orientation of γ_+ we get an oriented geodesic γ_- . The framing provides a positive map $\Psi' : \mathcal{G}_\infty(S) \rightarrow \mathcal{B}(\mathbf{R})$. Let us alter this map by changing $\Psi'(p_\pm)$ as follows. We set $\Psi(p_\pm)$ to be the attracting flag of the monodromy around the oriented loop γ_\pm . The attracting flag is well defined since the monodromy is in $H^0(\mathbf{R}_{>0})$. The same argument as in the proof of Theorem 7.1 shows that the obtained map Ψ is positive.

We may assume that $\Psi(p_-, p_+) = (B^-, B^+)$, and the cyclic order on $\mathcal{G}_\infty\pi_1(S)$ is given by (p_+, \dots, p_-) . The action of the group W on the frame boils down to replacing B^- by wB^-w^{-1} . It follows from Proposition 8.13 in [L1] that the triple of flags (B_-, wB^-w^{-1}, B^+) is non-negative, i.e. in the closure of the triples of positive flags. The proposition is reduced to the following claim: Let (B'', B', B^-, B_t, B^+) , where $t > 0$, be a curve in the configuration space of positive 5-tuples of flags, and (B'', B', B^-, B_0, B^+) the limiting configuration. Then the configuration (B'', B', B_0) is positive. Conjugating the configuration (B'', B', B^-, B_t, B^+) we can write it as $(B^+, B^-, v_1 \cdot B^-, u(t) \cdot B^-, v_2 \cdot B^-)$, where $u(t), v_1, v_2 \in U^+(\mathbf{R}_{>0})$. Then, in the canonical basis of a representation of G , $u(t)$ has non-negative entries and is bounded from above (resp. below) by the image of v_2 (resp. v_1). Thus the limit $\lim_{t \rightarrow \infty} u(t)$ exists and is in $U^+(\mathbf{R}_{>0})$. The proposition is proved.

Remark. We needed to work with $(\pi_p^+)^{-1}H^0(\mathbf{R}_{>0})$ in the proof for the existence of the attracting flag for the monodromy around γ_\pm . Observe that the monodromy around γ_\pm is conjugate to an element of $B(\mathbf{R}_{>0})$. The unique attracting flag probably exists for every element of $B(\mathbf{R}_{>0})$, at least this is obvious for $G = PGL_m(\mathbf{R})$.

9. The space $\mathcal{L}_{G,S}^+$ for a closed S coincides with the Hitchin component: a proof of Theorem 1.15. By Theorem 7.6, the Teichmüller space $\mathcal{L}_{G,S}^+$ is an open connected domain in $\mathcal{L}_{G,S}(\mathbf{R})$. Furthermore, $\mathcal{L}_{G,S}^+$ lies inside of $\mathcal{L}_{G,S}^{\text{red}}(\mathbf{R})$. Indeed, by Theorem 1.13i), for any representation ρ from $\mathcal{L}_{G,S}^+$, and for any $\gamma \in \pi_1(S)$, the element $\rho(\gamma)$ is semi-simple. Thus the Zariski closure of ρ is reductive: otherwise it is a semi-direct product of a reductive group and a unipotent group N , and there exists a non-trivial element γ such that $\rho(\gamma) \in N$, which contradicts to the semi-simplicity of $\rho(\gamma)$.

So it remains to show that $\mathcal{L}_{G,S}^+$ is closed in $\mathcal{L}_{G,S}^{\text{red}}(\mathbf{R})$. Indeed, then it is a component of $\mathcal{L}_{G,S}^{\text{red}}(\mathbf{R})$, and since by Corollary 7.2 $\mathcal{L}_{G,S}^+$ contains the classical Teichmüller space, it is the Hitchin component.

Let $\{x_i\}$ be a family of points of $\mathcal{L}_{G,S}^+$ converging when $i \rightarrow \infty$ to a point of $\mathcal{L}_{G,S}^{\text{red}}(\mathbf{R})$. Then there is a family of positive representations $\rho_i : \pi_1(S) \rightarrow G(\mathbf{R})$, corresponding to x_i 's, which has the limit when $i \rightarrow \infty$, denoted by ρ . Since G has trivial center, each ρ_i determines uniquely a positive map $\psi_i : \mathcal{G}_\infty(S) \rightarrow \mathcal{B}(\mathbf{R})$. Moreover, since there exists the limit $\lim_{i \rightarrow \infty} \rho_i$, there exists the limit map $\psi := \lim_{i \rightarrow \infty} \psi_i : \mathcal{G}_\infty(S) \rightarrow \mathcal{B}(\mathbf{R})$ (here the convergence means the pointwise convergence).

For any $s \in \mathcal{G}_\infty(S)$ there exists a unique $s' \in \mathcal{G}_\infty(S)$ such that s, s' are the endpoints of a geodesic projecting to a geodesic loop on S . We say that s' is *opposite to s in $\mathcal{G}_\infty(S)$* .

7.7. Lemma. — *Assume that the map ψ is not positive. Then for any pair of points $s_1, s_2 \in \mathcal{G}_\infty(S)$ which are not opposite to each other the flags $\psi(s_1)$ and $\psi(s_2)$ are not in generic position.*

Proof. Assume the opposite. Then there exists a pair $s_1 \neq s_2 \in \mathcal{G}_\infty(S)$ such that the flags $\psi(s_1)$ and $\psi(s_2)$ are in generic position, and s_1, s_2 are not opposite to each other. Conjugating representations ρ_i we may assume that $\psi_i(s_1) = B^+$ for all i . Still $\{\psi_i\}$ is a family of positive maps, and has a limit when $i \rightarrow \infty$.

Choose a hyperbolic structure on S . Take the geodesic γ on the hyperbolic plane covering S , connecting s_1 to its opposite s . The stabilizer of γ in $\pi_1(S)$ is isomorphic to \mathbf{Z} . Let m_γ be its generator. Since $s \neq s_2$, the points $t_n := m_\gamma^n s_2$, $n \in \mathbf{Z}$, are different, and we may assume that they converge to s_1 when $n \rightarrow \infty$, and to s when $n \rightarrow -\infty$. We are going to show that this implies that ψ is a positive map.

Conjugating representations ρ_i by elements from B^+ , we may assume without loss of generality that $\psi(s_1) = B^+$ and $\psi(s_2) = B^-$. Then, since

$\psi(t_n)$ is in generic position to B^+ , there exist elements $u_i \in U^+(\mathbf{R})$ such that $\psi(t_n) = u_n \cdot B^-$. Let $U_{\geq 0}^+$ be the closure of $U^+(\mathbf{R}_{>0})$ in $U^+(\mathbf{R})$. The image of any $u \in U_{\geq 0}^+$ in any finite dimensional representation of G , written in the canonical basis there, is a matrix with non-negative coefficients. Since ψ is the limit of a family of positive maps, $u_n \in U_{\geq 0}^+$.

Let C be a cyclic set and $a, b, c \in C$. We say that $d \in C$ belongs to the arc between b and c and outside of a if the order of (a, b, c, d) agrees with the cyclic order induced from C .

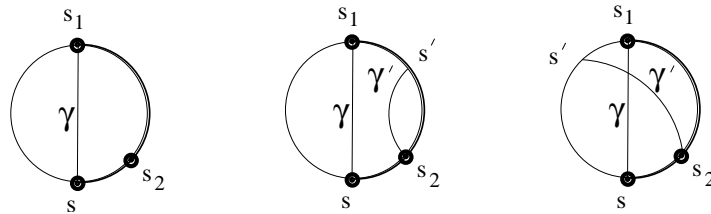

FIG. 7.4. —

7.8. Lemma. — *Let $r \in \mathcal{G}_\infty(S)$ be in the arc between t_{i-1} and t_i and outside of s . Then for any r from this arc $\psi(r) = u_r \cdot B^-$, where $u_r \in U_{\geq 0}^+$.*

Proof. Choose a section of the projection $U_{>0}^+ \rightarrow U_{>0}^+/H_{>0}$. Writing a flag as $u \cdot B^-$ where $u \in U_{>0}$, we will assume that u lies in this section. Therefore if $u^{(n)} \in U_{>0}^+$, the limit when $n \rightarrow \infty$ of the flags $u^{(n)} \cdot B^-$ exists, and the limiting flag is in the generic position to B^+ , then the limit $\lim_{n \rightarrow \infty} u^{(n)}$ exists, and lies in $U_{\geq 0}^+$.

Write $\psi_n(r) := u_r^{(n)} \cdot B^-$ and $\psi_n(t_i) := u_{t_i}^{(n)} \cdot B^-$, where $u_r^{(n)}, u_{t_i}^{(n)} \in U_{>0}^+$. Then $u_{t_i}^{(n)} = u_r^{(n)} \tilde{u}_r^{(n)}$ where $\tilde{u}_r^{(n)} \in U_{>0}^+$. We know that, as $n \rightarrow \infty$, the limit of $u_{t_i}^{(n)}$ exists. Since $u_r^{(n)}, \tilde{u}_r^{(n)} \in U_{>0}^+$, this implies that each of the limits $\lim_{n \rightarrow \infty} u_r^{(n)}$ and $\lim_{n \rightarrow \infty} \tilde{u}_r^{(n)}$ exists. Indeed, we know that the limit of flags $\psi_n(r)$ exists. Thus the first limit will not exist only if one of the matrix coefficients of $u_r^{(n)}$ goes to $+\infty$. However if this is the case, one of the matrix coefficients of the product $u_r^{(n)} \tilde{u}_r^{(n)}$ also goes to $+\infty$, which contradicts to the existence of $\lim_{n \rightarrow \infty} u_{t_i}^{(n)}$. If the limits exist, they apparently lie in $U_{\geq 0}^+$. The Lemma is proved.

Lemma 7.8 implies that $\psi(r)$ is in generic position to $B^+ = \psi(s_1)$. So for any r from the arc which is strictly between s_1 and s and contains s_2 , $\psi(r)$ is in generic position to $\psi(s_1)$, see Fig. 7.4. Take the geodesic γ' connecting s_2 with its opposite s' in $\mathcal{G}_\infty(S)$. Since $s' \neq s_1$, s' is either on

the right, or on the left of s_1 , see the two pictures on the right of Fig 7.4. Assume first that s' is on the same arc between s_1 and s_2 as s (the middle picture on Fig 7.4). Repeating the above argument we conclude that for any $r \in \mathcal{G}_\infty(S)$ in the arc A between s_1 and s' located outside of s the flag $\psi(r)$ is in generic position to $\psi(s_2) = B^-$. Thus for any such r , $\psi(r)$ is in generic position to B^+ and B_- . This plus $u_r \in U_{\geq 0}^+$ implies that $u_r \in U_{> 0}^+$. If s' lies to the left of s_1 , we apply a similar argument for the arc A' between s_1 and s_2 and outside of s' (the rightmost picture on Fig 7.4). So the restriction of the map ψ to the arc A (respectively A') is positive. Since any proper arc of $\mathcal{G}_\infty(S)$ can be moved by an element of $\pi_1(S)$ inside of the arcs A or A' , the map ψ is a positive map. Contradiction. The lemma is proved.

Let $\Gamma := \rho(\pi_1(S))$. It is a subgroup of $G(\mathbf{R})$. Let D_{B^+} be the divisor in the flag variety consisting of all flags which are not in generic position with the flag B^+ . Observe that if the points $s_1, s \in \mathcal{G}_\infty(S)$ are opposite to each other, then s is not on the Γ -orbit of s_1 . Thus according to Lemma 7.7 one has $\Gamma(B^+) \subset D_{B^+}$. (In fact it is easy to avoid using the previous claim).

A parabolic subgroup in G is a subgroup containing the Borel subgroup B^+ . Let P_α be the proper maximal parabolic subgroup corresponding to a simple positive root α .

7.9. Lemma. — *The subgroup Γ is contained in a proper maximal parabolic subgroup of G .*

Proof. Let Γ_{Zar} be the Zariski closure of Γ in G . Then $\Gamma_{\text{Zar}}(B^+) \subset D_{B^+}$. The irreducible components of the divisor D_{B^+} are parametrised by the proper maximal parabolic subgroups in G . Since $\Gamma_{\text{Zar}}(B^+) \subset D_{B^+}$, any non-zero vector in the Lie algebra $\text{Lie}\Gamma_{\text{Zar}}$ of the algebraic group Γ_{Zar} lies in a certain proper maximal parabolic Lie algebra of G .

Assume that no proper maximal parabolic subgroup of G contains Γ_{Zar} . Then for every positive simple root α there exists an element $Z_\alpha \in \text{Lie}\Gamma_{\text{Zar}}$ such that $Z_\alpha \notin \text{Lie}P_\alpha$. Thus for generic numbers x_α the linear combination $\sum_\alpha x_\alpha Z_\alpha$ does not lie in any maximal parabolic Lie algebra. On the other hand it belongs to the Lie algebra of Γ_{Zar} , and thus lies in one of the proper maximal parabolics. Contradiction. The Lemma is proved.

By the definition of the Hitchin component, the algebraic group Γ_{Zar} is reductive. By Lemma 7.9 it is contained in a proper maximal parabolic subgroup P_α , and hence in its Levi radical M_α . But then its action on the Lie algebra of G is not irreducible. On the other hand, Γ_{Zar} is irreducible by Lemma 10.1 from [Lab] (this lemma was formulated in loc. cit. for SL_n ,

but the proof, based on a Higgs bundle argument, works for any G). This contradiction proves Theorem 1.15.

10. Positive curves in $\mathcal{B}(\mathbf{R})$ are $G(\mathbf{R})$ -opers on S^1 . *A canonical distribution on \mathcal{B} .* The flag variety \mathcal{B} is equipped with a G -invariant non-integrable distribution \mathcal{D} whose dimension is equal to the rank of the group G . It is defined as follows. Let x be a point of \mathcal{B} . We may assume that the corresponding Borel subgroup is B^- . Then the tangent space $T_x\mathcal{B}$ is identified with the Lie algebra $\text{Lie}(U^+)$. Consider the subspace of $\text{Lie}(U^+)$ given by the direct sum of the one dimensional subspaces corresponding to the simple roots. Transferring it to the tangent space $T_x\mathcal{B}$, we get the fiber \mathcal{D}_x of the distribution at the point x . It is easy to see that this definition is independent of the choices involved.

7.2. Proposition. — *Let C be a positive differentiable curve of the flag variety $\mathcal{B}(\mathbf{R})$. Then C is an integral curve of the distribution \mathcal{D} on $\mathcal{B}(\mathbf{R})$.*

Proof. Let $c(s) \in \mathcal{B}(\mathbf{R})$ be a positive curve. We may assume that $c(0) = B^-, c(1) = B^+$. So $c(s) = x(s)B^-$ where $x(s) \in U^+(\mathbf{R}_{>0})$. Choose a reduced decomposition $w_0 = w_{i_1} \dots w_{i_n}$. Then the positivity of $x(s)$ implies that we can write it as $x(s) = \prod_{i_k} x_{i_k}(t_k(s))$, where $t_k(0) = 0, t_k(s) > 0$. Since $[x_i(s), x_j(t)] = O(st)$, linearizing $x(s)$ at $s = 0$ we get $\sum_k t'_{i_k}(0)E_{i_k} \in \text{Lie}(U^+)$, where $x_i(t) = \exp(tE_i)$. The proposition is proved.

A smooth map from the circle S^1 to $\mathcal{B}(\mathbf{R})$ tangent to the canonical distribution is nothing else than a $G(\mathbf{R})$ -oper on S^1 in the terminology of Beilinson and Drinfeld. So Proposition 7.2 asserts that positive differentiable loops in $\mathcal{B}(\mathbf{R})$ are $G(\mathbf{R})$ -opers on S^1 .

Describing $PGL_{n+1}(\mathbf{R})$ -opers on real curves. A C^{n-1} -smooth (meaning $n - 1$ times continuously differentiable) curve K in \mathbf{RP}^n gives rise to an *osculating curve* \tilde{K} in the real flag variety $\mathcal{B}_{n+1}(\mathbf{R})$ for PGL_{n+1} . Namely, \tilde{K} is formed by the osculating flags to the curve at variable points. It is an easy and well known fact that any differentiable $PGL_{n+1}(\mathbf{R})$ -oper is the osculating curve for a certain sufficiently differentiable curve K in \mathbf{RP}^n . The curve K is recovered by applying the canonical projection π . The G -opers for other classical groups have a similar description.

We will show in Section 9.12 that positive $PGL_{n+1}(\mathbf{R})$ -opers on S^1 come from convex curves in \mathbf{RP}^n . So positive $G(\mathbf{R})$ -opers on real curves can be considered as a generalization of convex curves \mathbf{RP}^n to the case of an arbitrary split semi-simple group G .

11. Remarks on quantum universal Teichmüller spaces and W -algebras. The space of $G(\mathbf{R})$ -opers on the parametrised circle S^1 has a natural Poisson structure, the Gelfand-Dikii bracket, defined by Drinfeld and Sokolov in [DS]. On the other hand, since $P^1(\mathbf{Q})$ is a subset of S^1 , a positive $G(\mathbf{R})$ -oper provides a point of the universal Teichmüller space \mathcal{X}_G^+ . The universal Teichmüller space \mathcal{X}_G^+ has a natural Poisson structure. For instance if $G = PGL_m$ it is defined in the canonical coordinates by the function ε_{pq} from Definition 1.11 applied to the m -triangulation of the Farey triangulation. One can show that the Gelfand-Dikii bracket is compatible with the Poisson bracket on \mathcal{X}_G^+ .

The Poisson structure \mathcal{X}_G^+ admits a natural quantization equivariant under the action of the Thompson group. In the case $G = PSL_m$ the quantization is especially explicit, and follows from the results of Chapter 9 and [FG2]. The case $G = SL_3$ is discussed in [FG3]. Therefore we suggest that *the quantum universal Teichmüller space can be considered as a combinatorial version of the W -algebra corresponding to G , divided by G .*

11. Kleinian $G(\mathbf{C})$ -local systems on hyperbolic threefolds: conjectures. Below S is an oriented surface, and G is a semi-simple split algebraic group over \mathbf{Q} with trivial center.

7.3. Definition. — *The moduli space $Q_{G(\mathbf{C}),S}$ of quasifuchsian $G(\mathbf{C})$ -local systems on S is the interior part of the connected component of the moduli space of $G(\mathbf{C})$ -local systems on S with discrete faithful monodromy representations $\pi_1(S) \rightarrow G(\mathbf{C})$, which contain the moduli space $\mathcal{L}_{G,S}^+$ of positive $G(\mathbf{R})$ -local systems on S .*

Further, let $Q_{G(\mathbf{C}),S}^{\text{un}}$ be the subspace of *quasifuchsian unipotent $G(\mathbf{C})$ -local systems on S* . It is the interior part of the connected subset of $\mathcal{U}_{G,S}(\mathbf{C})$ which consists of local systems with faithful discrete monodromies and contains $\mathcal{U}_{G,S}(\mathbf{R}_{>0})$.

Let \mathcal{D}_S be the double of the surface S , defined as follows. Let \bar{S} be the surface S equipped with the opposite orientation. If S has boundary, then \mathcal{D}_S is a connected surface obtained by gluing S and \bar{S} along the corresponding boundary components. If S is closed, then $\mathcal{D}_S := S \cup \bar{S}$.

7.1. Conjecture. — *There are canonical isomorphisms*

$$Q_{G(\mathbf{C}),S} \xrightarrow{\sim} \mathcal{L}_{G,\mathcal{D}_S}^+, \quad Q_{G(\mathbf{C}),S}^{\text{un}} \xrightarrow{\sim} \mathcal{L}_{G,S}^{\text{un},+} \times \mathcal{L}_{G,\bar{S}}^{\text{un},+}. \quad (7.13)$$

In particular, if S has no boundary, there should be an isomorphism

$$Q_{G(\mathbf{C}),S} \xrightarrow{\sim} \mathcal{L}_{G,S}^+ \times \mathcal{L}_{G,\bar{S}}^+. \quad (7.14)$$

If $G = PGL_2$, this is equivalent to the Bers double uniformization theorem.

The second isomorphism in (7.13) should provide $Q_{G(\mathbf{C}),S}^{\text{un}}$ with a hyperkähler structure: One of the complex structures is induced from the fact that $Q_{G(\mathbf{C}),S}^{\text{un}}$ is an open domain in $\mathcal{U}_{G,S}(\mathbf{C})$. On the other hand, $\mathcal{U}_{G,S}(\mathbf{R}_{>0})$ is supposed to be a complex manifold. Finally, the Weil-Petersson form on $\mathcal{U}_{G,S}(\mathbf{C})$ provides a holomorphic symplectic structure.

Now let Γ be a Kleinian group, that is a torsion-free discrete subgroup of $PGL_2(\mathbf{C})$. So the quotient $\mathcal{M}_\Gamma := \Gamma \backslash \mathcal{H}^3$, where \mathcal{H}^3 is the hyperbolic space, is a complete hyperbolic threefold. We will assume furthermore that Γ is not *elementary*, i.e. the limit set of its action on the absolute is infinite, and that \mathcal{M}_Γ is *geometrically finite*, i.e. the convex core of \mathcal{M}_Γ , defined as the geodesic convex hull of the limit set, is of finite volume. The open manifold \mathcal{M}_Γ can be compactified by adding a surface at each end. We denote the resulting manifold by $\overline{\mathcal{M}}_\Gamma$. We will also assume that \mathcal{M}_Γ is *incompressible*, that is the map $\pi_1(\partial\overline{\mathcal{M}}_\Gamma) \rightarrow \pi_1(\overline{\mathcal{M}}_\Gamma)$ is injective.

Let $\Omega_\Gamma \subset \partial\mathcal{H}^3 = \mathbf{CP}^1$ be the discontinuity set for Γ . It is a union of a finite number of connected, simply-connected components. The boundary of $\overline{\mathcal{M}}_\Gamma$ is identified with $S_\Gamma := \Omega_\Gamma/\Gamma$, which is a union of finite number of surfaces. It inherits a complex structure from the absolute, and thus provides a point of the Teichmüller space \mathcal{T}_{S_Γ} . Let $\mathcal{K}_{\mathcal{M}_\Gamma}$ be the interior part of the deformation space of the subgroup Γ inside of $PSL_2(\mathbf{C})$ modulo conjugations. Then the above construction gives rise to a map

$$\mathcal{K}_{\mathcal{M}_\Gamma} \longrightarrow \mathcal{T}_{S_\Gamma}. \tag{7.15}$$

By the well-known theorem, it is an isomorphism (see [Kr], [MM] and references therein). Below we suggest a conjectural generalization of this picture.

Pick a principal embedding $\rho : PGL_2 \hookrightarrow G$. Its restriction to Γ is a faithful discrete representation $\rho_\Gamma : \Gamma \rightarrow G(\mathbf{C})$. Let $\mathcal{K}_{G(\mathbf{C}),\mathcal{M}_\Gamma}$ be the interior part of the deformation space of ρ_Γ in the class of faithful discrete representations $\Gamma \rightarrow G(\mathbf{C})$ modulo conjugations. It is the space of $G(\mathbf{C})$ -local systems on \mathcal{M}_Γ with discrete faithful monodromies, deforming the one assigned to ρ_Γ . We call them *Kleinian local systems* on \mathcal{M}_Γ .

7.2. Conjecture. — *Assume that Γ is a non-elementary Kleinian group, and \mathcal{M}_Γ is geometrically finite and incompressible. Then there is an isomorphism*

$$\mathcal{K}_{G(\mathbf{C}),\mathcal{M}_\Gamma} \xrightarrow{\sim} \mathcal{L}_{G,S_\Gamma}^+. \tag{7.16}$$

Conjecture 7.1 is a special case of this conjecture. If $G = PGL_2$, the conjectural isomorphism (7.16) reduces to the isomorphism (7.15). In particular,

when \mathcal{M}_Γ is of finite volume, i.e. is closed or has cusps at the ends, this is the Mostow rigidity theorem. Our conjecture claims that, for an arbitrary G , ρ_Γ in this case has no non-trivial deformations.

The isomorphism (7.16) should be compatible with the one (7.15): the principal embedding ρ should provide commutative diagram, where the vertical arrows are the embeddings induced by ρ :

$$\begin{array}{ccc} \mathcal{K}_{\mathcal{M}_\Gamma} & \xrightarrow{\sim} & \mathcal{T}_{S_\Gamma} \\ \downarrow & & \downarrow \\ \mathcal{K}_{G(\mathbf{C}), \mathcal{M}_\Gamma} & \xrightarrow{\sim} & \mathcal{L}_{G, S_\Gamma}^+ \end{array}$$

Here is a version of Conjecture 7.2.

7.3. Conjecture. — *Assume that \mathcal{M}_Γ is as in Conjecture 7.2. Then the restriction of a local $G(\mathbf{C})$ -system on \mathcal{M}_Γ to the ends of \mathcal{M}_Γ provides an injective map*

$$\mathcal{K}_{G(\mathbf{C}), \mathcal{M}_\Gamma} \hookrightarrow Q_{G(\mathbf{C}), S_\Gamma}. \quad (7.17)$$

Its image is a Lagrangian submanifold in $Q_{G(\mathbf{C}), S_\Gamma}$. The map (7.16) is the composition of the map (7.17) followed by the projection $Q_{G(\mathbf{C}), S_\Gamma} \rightarrow \mathcal{L}_{G, S_\Gamma}^+$ from Conjecture 7.1, see (7.14).

It is easy to show that the image of the map (7.17) is isotropic. Thus the fact that it is Lagrangian should follow from Conjecture 7.2.

A hyperbolic field theory. Here is an interpretation of Conjecture 7.2. We assign to each closed surface S a symplectic manifold $Q_{G(\mathbf{C}), S}$. Further, let us assign to each topological threefold \mathcal{M} isomorphic to \mathcal{M}_Γ as in Conjecture 7.2 the manifold $\mathcal{K}_{G(\mathbf{C}), \mathcal{M}}$. By Conjecture 7.3 it is a Lagrangian submanifold in $Q_{G(\mathbf{C}), \partial\mathcal{M}}$. These Lagrangian submanifolds should satisfy the classical field theory axioms. In particular, if \mathcal{M} is glued from threefolds \mathcal{M}_1 and \mathcal{M}_2 along a boundary component, then $\mathcal{K}_{G(\mathbf{C}), \mathcal{M}}$ is identified with the subset of $\mathcal{K}_{G(\mathbf{C}), \mathcal{M}_1} \times \mathcal{K}_{G(\mathbf{C}), \mathcal{M}_2}$ consisting of the pairs whose restrictions to the boundary components coincide.

8. A positive structure on the moduli space $\mathcal{A}_{G, \widehat{S}}$

In this section G is simply connected and connected. We define a positive structure on the moduli space $\mathcal{A}_{G, \widehat{S}}$. In particular if \widehat{S} is a disc with n marked points at the boundary we get a positive structure on the moduli space $\text{Conf}_n(\mathcal{A})$ of configurations of n affine flags in G . We start with a definition of a positive structure on the moduli spaces $\text{Conf}_n(\mathcal{A})$ for $n = 2$ and

$n = 3$. The definition in general is given by using an ideal triangulation of \widehat{S} . We show that it does not depend on the choice of an ideal triangulation.

1. Generic configurations of pairs of affine flags. A pair of affine flags is in *generic position* if the underlying pair of flags is in generic position. An n -tuple of affine flags is in generic position if every two of them are in generic position. Let $\text{Conf}_n^*(\mathcal{A})$ be the variety of configurations of n affine flags in generic position in G . Similarly one defines a generic pair (A_1, B_2) where A_1 is an affine flag and B_2 is a flag. The generic pairs (A_1, B_2) form a principal homogeneous G -space.

If we care only about the birational type of the variety $\text{Conf}_n^*(\mathcal{A})$, we will usually work with the corresponding moduli space $\text{Conf}_n(\mathcal{A})$.

Recall the element $\bar{w}_0 \in N(H)$. Recall that $[g]_0 := h$ if $g = u_-hu_+$, where $u_\pm \in U^\pm, h \in H$. Let $(A_1, A_2) = (g_1U^-, g_2\bar{w}_0U^-) \in \text{Conf}_2^*(\mathcal{A})$. We set

$$\alpha_2(g_1U^-, g_2\bar{w}_0U^-) := [g_1^{-1}g_2]_0 \in H.$$

We get a map $\alpha_2 : \text{Conf}_2^*(\mathcal{A}) \rightarrow H, (A_1, A_2) \mapsto \alpha_2(A_1, A_2)$.

Recall that the Cartan group H acts naturally from the right on the affine flag variety: $A \mapsto A \cdot h$. Since H is commutative we can also consider it as a left action.

8.1. Proposition. — *The map α_2 provides an isomorphism*

$$\alpha_2 : \text{Conf}_2^*(\mathcal{A}) \xrightarrow{\sim} H, \quad (A_1, A_2) \mapsto \alpha_2(A_1, A_2). \tag{8.1}$$

It has the following properties:

$$\alpha_2(A_1 \cdot h_1, A_2 \cdot h_2) = h_1^{-1}w_0(h_2) \cdot \alpha_2(A_1, A_2), \quad \alpha_2(A_2, A_1) = s_G \cdot w_0(\alpha_2(A_1, A_2)^{-1}). \tag{8.2}$$

Proof. Bruhat decomposition shows that an arbitrary generic pair of affine flags (A_1, A_2) can be written uniquely as $(h \cdot U^-, \bar{w}_0U^-)$. This provides the first claim of the proposition. To check the first of the properties (8.2) notice that $\alpha_2(h_1U^-, \bar{w}_0h_2U^-) = h_1^{-1}w_0(h_2)$. The second of the properties (8.2) follows immediately from this one. The Proposition is proved.

Observe that $(A_1 \cdot h, A_2 \cdot w_0(h)) = h(A_1, A_2)$.

Recall the twisted cyclic shift map from Definition 2.5.

8.1. Lemma. — *The twisted cyclic shift map is a positive automorphism of $\text{Conf}_2(\mathcal{A})$.*

Proof. Follows immediately from (8.2).

If $s_G \neq e$ then the cyclic shift is not a positive automorphism of $\text{Conf}_2(\mathcal{A})$. ■

2. A positive structure on $\text{Conf}_3(\mathcal{A})$. Let us define a map

$$\gamma : U_*^+ \longrightarrow H, \quad u^+ \longmapsto [u^+ \bar{w}_0]_0 \in H. \quad (8.3)$$

8.2. Lemma. — *The map γ is a positive map.*

Proof. Using the isomorphism $\mathbf{G}_m^I = H$ provided by $\omega_1, \dots, \omega_r$ we have $\gamma(u_+) := \{\Delta_{\omega_i, w_0(\omega_i)(u_+)}\}_{i \in I} \in \mathbf{G}_m^I$. It follows from Theorem 5.1 that it is a positive map. The lemma is proved.

Consider the regular open embeddings

$$\begin{aligned} \beta_1^- : B^- &\hookrightarrow G/U^-, & b_- &\longmapsto b_- \bar{w}_0 U^-, \\ \beta_2^- : B^+ &\hookrightarrow G/U^-, & b_+ &\longmapsto b_+ U^-. \end{aligned}$$

The Borel subgroups B^- and B^+ have the standard positive structures. They provide G/U^- with two positive structures. Similarly the regular open embeddings

$$\begin{aligned} \beta_1^+ : B^+ &\hookrightarrow G/U^+, & b_+ &\longmapsto b_+ \bar{w}_0 U^+, \\ \beta_2^+ : B^- &\hookrightarrow G/U^+, & b_- &\longmapsto b_- U^+. \end{aligned}$$

provide G/U^+ with two positive structures. Let $\Phi : B^- \rightarrow B^+$ be a rational map such that $\beta_2^+ = \beta_1^+ \Phi$ on their common domain of definition.

8.3. Lemma. —

- a) *The two positive structures on G/U^- provided by the maps β_1^-, β_2^- are compatible.*
- b) *The two positive structures on G/U^+ provided by the maps β_1^+ and β_2^+ are compatible.*
- c) *The maps Φ and Φ^{-1} are positive rational maps.*

Proof. a) \Leftrightarrow b). Indeed, consider the involutive automorphism $\theta : G \rightarrow G$ which is uniquely determined by

$$\theta(h) := h^{-1}, \quad \theta(x_i(t)) := y_i(t), \quad \theta(y_i(t)) := x_i(t).$$

Observe that $\theta(\bar{w}_0) = \bar{w}_0$ and $\theta(\bar{w}_0) = \bar{w}_0$. Applying θ we deduce b) from a) since $\theta(B^+) = B^-, \theta(B^-) = B^+, \theta(\bar{w}_0) = \bar{w}_0$. Similarly b) implies a).

Let us prove b). Recall that $b_+ \bar{w}_0 U^+ = b_- U^+$. So $b_+ = \Phi(b_-)$. We have to show that the maps $b_+ \rightarrow b_-$ and $b_- \rightarrow b_+$ are positive. Consider the first map. Write $b_+ = h_+ u_+, b_- = h_- u_-$. We may assume that $h_+ = 1$. Then

$h_- = \gamma(u_+)$, so it is a positive map by Lemma 8.2. The map $u_+ \mapsto u_-$ is the map ϕ^{-1} , and hence it is positive. The claim is proved.

c) Follows from b). The lemma is proved.

3. Positive configurations of affine flags. Let (A_1, A_2, A_3) be a generic triple of affine flags in G . Denote by B_i the flag corresponding to A_i . So every two of the flags B_1, B_2, B_3 are in generic position. Let $\text{Conf}^*(A_1, B_2, B_3)$ be the configuration space of generic triples (A_1, B_2, B_3) . Then there is an isomorphism

$$\text{Conf}^*(A_1, B_2, B_3) \xrightarrow{\sim} U_*^+. \quad (8.4)$$

Indeed, let $(U^-, w_0 B^-)$ be a standard pair. Then there exists unique $u \in U_*^+$ such that

$$(A_1, B_2, B_3) \sim (U^-, w_0 B^-, u_+ B^-); \quad u_+ \in U_*^+. \quad (8.5)$$

8.4. Lemma. — *There is a canonical isomorphism*

$$\alpha_3 : \text{Conf}_3^*(\mathcal{A}) \xrightarrow{\sim} \text{Conf}_2^*(\mathcal{A}) \times \text{Conf}_2^*(\mathcal{A}) \times \text{Conf}^*(A_1, B_2, B_3) \quad (8.6)$$

$$(A_1, A_2, A_3) \mapsto (A_1, A_2) \times (A_2, A_3) \times (A_1, B_2, B_3).$$

Proof. The affine flags A_2 and A_3 are determined by the elements $\alpha_2(A_1, A_2)$ and $\alpha_2(A_1, A_3)$ in H . The lemma is proved.

The isomorphism α_3 combined with the isomorphisms (8.1) and (8.4) leads to an isomorphism

$$\alpha_3 : \text{Conf}_3^*(\mathcal{A}) \xrightarrow{\sim} H \times H \times U_*^+, \quad (8.7)$$

8.5. Lemma. — *The inverse to the isomorphism α_3 is defined as follows:*

$$\begin{aligned} \alpha_3' : H \times H \times U_*^+ &\longrightarrow \text{Conf}_3^*(\mathcal{A}), \\ (h_2, h_3, u_+) &\longmapsto (U^-, h_2 \bar{w}_0 U^-, h_2 w_0 (h_3) s_G u_+ U^-). \end{aligned}$$

Proof. Consider the natural projection

$$\mathbf{e}_{ij} : \text{Conf}_3^*(\mathcal{A}) \longrightarrow H; \quad (A_1, A_2, A_3) \longmapsto (A_i, A_j), \quad 1 \leq i < j \leq 3.$$

It follows from the definition of the map α_2 that $\mathbf{e}_{12} \alpha_3'$ is the projection on the first H -factor. Let us check that $\mathbf{e}_{23} \alpha_3'$ is the projection on the second H -factor. One has

$$\begin{aligned} (h_2 \bar{w}_0 U^-, h_2 w_0 (h_3) s_G u_+ U^-) &\sim (U^-, h_3 s_G \bar{w}_0^{-1} u_+ \bar{w}_0 \bar{w}_0^{-1} U^-) = \\ &= (U^-, h_3 \bar{w}_0^{-1} (u_+) \bar{w}_0 U^-). \end{aligned}$$

Since $\bar{w}_0^{-1}(u_+) := \bar{w}_0^{-1} u_+ \bar{w}_0 \in U^-$, the statement follows. The similar claim about the U_*^+ -factor is obvious. The lemma is proved.

8.1. Definition. — *A positive regular structure on the variety $\text{Conf}_3^*(\mathcal{A})$ is given by the isomorphism (8.7) and the standard positive regular structures on U_*^+ and H .*

8.6. Lemma. — *The map $\mathbf{e}_{13} : \text{Conf}_3(\mathcal{A}) \longrightarrow H$ is a positive rational map.*

Proof. Recall the map γ , see (8.3). Using the isomorphism (8.7) we have

$$\mathbf{e}_{13}\alpha'_3(h_2, h_3, u_+) = (U^-, h_2 w_0(h_3) s_G u_+ U^-) = (U^-, h_2 w_0(h_3) u_+ \bar{w}_0 \bar{w}_0 U^-).$$

Comparing this with the Bruhat decomposition, we observe that this is equal to $h_2 w_0(h_3) \gamma(u_+)$. The lemma is proved.

8.2. Proposition. — *The twisted cyclic shift is a positive rational map on the moduli space $\text{Conf}_3(\mathcal{A})$.*

Proof. To simplify the calculation we may assume without loss of generality that $h_2 = h_3 = e$. So we start from the configuration

$$(U^-, \bar{w}_0 U^-, u_+ s_G U^-).$$

Multiplying from the left by u_+^{-1} and then using $\bar{w}_0^{-1} u_+^{-1} \bar{w}_0 \in U^-$ we get

$$(U^-, \bar{w}_0 U^-, u_+ s_G U^-) \sim (u_+^{-1} U^-, \bar{w}_0 U^-, s_G U^-).$$

Applying the inversion map $g \longmapsto g^{-1}$ we get

$$(U^- u_+, U^- \bar{w}_0^{-1}, U^- s_G).$$

Applying the antiautomorphism Ψ we get

$$(u_- U^+, \Psi(\bar{w}_0^{-1}) U^+, s_G U^+), \quad u_- := \Psi(u_+).$$

According to Lemma 8.3b) one has $u_- U^+ = v_+ h \bar{w}_0 U^+$. Here $v_+ h = \Phi(u_-)$ and $v_+ = \phi(u_-)$. The map Φ is a positive map. Thus, since $v_+^{-1} U^+ = U^+$, we can write our configuration as

$$(v_+ h \bar{w}_0 U^+, \Psi(\bar{w}_0^{-1}) U^+, s_G U^+) \sim (h \bar{w}_0 U^+, v_+^{-1} \Psi(\bar{w}_0^{-1}) U^+, s_G U^+).$$

Applying the inversion map we write it as

$$(U^+ \bar{w}_0^{-1} h^{-1}, U^+ \Psi(\bar{w}_0) v_+, U^+ s_G).$$

Then applying Ψ we get

$$(h^{-1} \Psi(\bar{w}_0^{-1}) U^-, \Psi(v_+) \bar{w}_0 U^-, s_G U^-).$$

Applying Lemma 8.3a) we can write $\Psi(v_+)\overline{w}_0U^- = h'\phi\Psi(v_+)U^-$, where the map $\Psi(v_+) \mapsto h'$ is positive. So we get

$$(h^{-1}\overline{w}_0U^-, s_G h'(\phi\Psi)^2(u_+)U^-, s_G U^-).$$

We conclude that

$$(U^-, \overline{w}_0U^-, u_+s_GU^-) \sim (h^{-1}\overline{w}_0U^-, s_G h'(\phi\Psi)^2(u_+)U^-, s_G U^-). \quad (8.8)$$

Since the maps $\phi\Psi$, $u_+ \mapsto h^{-1}$ and $u_+ \mapsto h'$ are positive, formula (8.8) implies that the twisted cyclic shift is a positive map on $\text{Conf}_3(\mathcal{A})$. The Proposition is proved.

Let us consider the following regular open embedding

$$H^3 \times U_*^+ \times U_*^- \hookrightarrow \text{Conf}'_4(\mathcal{A})$$

$$(h_2, h_3, h_4, u_+, v_-) \mapsto (U^-, u_+^{-1}h_2U^-, h_3\overline{w}_0U^-, v_-h_4\overline{w}_0U^-). \quad (8.9)$$

Here $\text{Conf}'_4(\mathcal{A})$ is the moduli space of configurations of four flags (B_1, \dots, B_4) such that all flags except the pair (B_2, B_4) are in generic position.

We are going to define a positive structure on the moduli space $\text{Conf}_4(\mathcal{A})$ by using the birational map

$$H^3 \times U_*^+ \times U_*^- \longrightarrow \text{Conf}_4(\mathcal{A}). \quad (8.10)$$

and the standard positive structures on H , U_*^+ and U_*^- . We have to check however that this map is defined on a complement to a positive rational divisor.

8.3. Proposition. — *a) The map (8.10) is defined on a complement to a positive rational divisor.*

b) The twisted cyclic shift provides a positive automorphism of the moduli space $\text{Conf}_4(\mathcal{A})$.

Proof. Let us define a rational map

$$U^+ \times U^- \times H \times H \longrightarrow U^- \times U^+ \times H, \quad (u_+, v_-, h_2, h_4) \mapsto (a_-, a_+, t) \quad (8.11)$$

by solving the equation $h_2^{-1}u_+v_-h_4 = a_-a_+t$. It is a positive rational map, since the two Gauss decompositions in G are related by a positive map, see Proposition 5.2. Let us set

$$g := a_-^{-1}h_2^{-1}u_+ = a_+th_4^{-1}v_-^{-1}.$$

Then multiplying the configuration (8.9) by g from the left we get

$$(a_+th_4^{-1}U^-, U^-, a_-^{-1}h_2^{-1}h_3\bar{w}_0U^-, t\bar{w}_0U^-).$$

Applying to it the twisted cyclic shift we get

$$(U^-, a_-^{-1}h_2^{-1}h_3\bar{w}_0U^-, t\bar{w}_0U^-, a_+th_4^{-1}s_GU^-). \quad (8.12)$$

We can write the configuration (8.12) in the form of (8.9):

$$(8.12) = (U^-, \tilde{u}_+^{-1}\tilde{h}_2U^-, \tilde{h}_3\bar{w}_0U^-, \tilde{v}_-\tilde{h}_4\bar{w}_0U^-).$$

In other words, one must have

$$i) \quad a_-^{-1}h_2^{-1}h_3\bar{w}_0U^- = \tilde{u}_+^{-1}\tilde{h}_2U^-, \quad ii) \quad t = \tilde{h}_3, \quad iii) \quad a_+th_4^{-1}s_GU^- = \tilde{v}_-\tilde{h}_4\bar{w}_0U^-. \quad (8.13)$$

8.7. Lemma. — *The rational map*

$$(h_2, h_3, h_4, u_+, v_-) \longmapsto (\tilde{h}_2, \tilde{h}_3, \tilde{h}_4, \tilde{u}_+, \tilde{v}_-)$$

provided by equations (8.13) is a positive rational map.

Proof. For \tilde{h}_3 and the equation ii) this follows from the positivity of the map (8.11). For the equation iii) and \tilde{v}_-, \tilde{h}_4 this follows immediately from Lemma 8.3a) since $s_G\bar{w}_0 = \bar{w}_0$. To handle i) means to show that the rational map $B^- \rightarrow B^+$, $x_- \mapsto x_+$ determined from the equation $x_-^{-1}\bar{w}_0U^- = x_+^{-1}U^-$ is a positive rational map. This equation is equivalent to $x_+ = \Psi\Phi\Psi(x_-)$. Indeed, applying the inversion antiautomorphism to this equation we get $U^-\bar{w}_0x_- = U^-x_+$. Then applying Ψ we get $\Psi(x_-)\bar{w}_0U^+ = \Psi(x_+)U^+$. So $\Psi(x_+) = \Phi^{-1}\Psi(x_-)$, and hence $x_+ = \Psi\Phi^{-1}\Psi(x_-)$. By Lemma 8.3 the rational map $\Psi\Phi^{-1}\Psi : B^+ \rightarrow B^-$ is positive. So the lemma follows. Both statements of the proposition follow immediately from this lemma. The proposition is proved.

Let us consider the canonical projection (the edge projection)

$$\mathbf{e} = (\mathbf{e}_{12}, \mathbf{e}_{23}, \mathbf{e}_{13}) : \text{Conf}_3^*(\mathcal{A}) \longrightarrow H \times H \times H. \quad (8.14)$$

It follows from Lemma 8.5 and proof of Lemma 8.6 that one has

$$\mathbf{e}\alpha'_3(h_2, h_3, u_+) = (h_2, h_3, h_2w_0(h_3)\gamma(u_+)). \quad (8.15)$$

Therefore the map \mathbf{e} is surjective. Let us define the variety \mathcal{V}_G as its fiber over (e, e, e) :

$$\mathcal{V}_G := \mathbf{e}^{-1}(e, e, e) \subset \text{Conf}_3^*(\mathcal{A}). \quad (8.16)$$

8.4. Proposition. — *a) The variety \mathcal{V}_G has a natural positive structure.*
b) The positive structure on the variety \mathcal{V}_G is invariant under the cyclic shift map.

Proof. a) We deduce this from Theorem 5.1 applied to the double Bruhat cell G^{e,w_0} .

Let us identify G^{e,w_0} with the configuration space $\text{Conf}(A_1, B_2, A_3)$. The configuration space of triples (A_1, B_2, A_3) where (A_1, B_2) are in generic position is identified with the principal affine space G/U^- by setting $(A_1, B_2, A_3) \rightarrow (U^-, B^+, g \cdot U^-)$. The inclusion $B^+ \hookrightarrow G/U^-$ gives rise to a subspace of the configuration space consisting of triples (A_1, B_2, A_3) where in addition (A_1, A_3) are in generic position. Then the condition that (B_2, A_3) are in generic position singles out the subvariety $B^+ \cap B^- w_0 B^- \subset B^+$, that is the double Bruhat cell G^{e,w_0} .

Given a reduced decomposition \mathbf{i} of w_0 , the collection of the generalized minors $F(\mathbf{i}) = \{\Delta(k; \mathbf{i}), k \in -[1, r] \cup [1, l(w_0)]\}$ provides a positive coordinate system on G^{e,w_0} . The minors $\Delta(k; \mathbf{i}), k \in -[1, r]$ are the ones $\Delta_{\omega_i, w_0(\omega_i)}$, so they give the map γ . On the other hand among these minors there are $\Delta_{\omega_i, \omega_i}$ for every $i \in I = \{1, \dots, r\}$. To see this write the sequence $\mathbf{i} = (i_1, \dots, i_{l(w_0)})$. Then for each $p \in \{1, \dots, r\}$ take the rightmost among all i_a 's such that $i_a = p$. Denote it by $i_{a(p)}$. Then $\Delta(i_{a(p)}; \mathbf{i}) = \Delta_{\omega_p, \omega_p}$. Indeed, look at the formulas (5.4) and (5.5). For $i_{a(p)}$, the elements of the Weyl group defined by these formulas are both equal to e . Indeed, in the formula (5.4) the product is over the empty set since $\varepsilon(i_l) = +1$ for all l involved since this is always so for the element (e, w) . In the second formula the set of possible l 's is empty. Thus according to the definition (5.6), we get $\Delta_{\omega_p, \omega_p}$. The rest of the generalized minors, that is the minors

$$F'(\mathbf{i}) = \{\Delta(k; \mathbf{i}), k \in [1, l(w_0)] - \{a(1), \dots, a(r)\}\}$$

give a positive coordinate system on \mathcal{V}_G . The part a) is proved.

b) Follows easily from a) and Proposition 8.2. The Proposition is proved.

4. A positive structure on the moduli space $\mathcal{A}_{G, \widehat{S}}$. Let \widehat{S} be a marked hyperbolic surface. Choose an ideal triangulation T of \widehat{S} . Denote by $\mathcal{A}_{G, \widehat{t}}$ the moduli space of the twisted decorated G -local systems on the triangle t , considered as a disc with three marked points on the boundary. These marked points are located on the sides of the triangle, one point per each side. The punctured tangent space to a triangle t of the triangulation T sits in the punctured tangent space $T'S$. So restricting the local system \mathcal{L} on $T'S$ representing an element of $\mathcal{A}_{G, \widehat{S}}$ to $T't$ we get an element of $\mathcal{A}_{G, \widehat{t}}$. So we get a projection $q'_t : \mathcal{A}_{G, \widehat{S}} \rightarrow \mathcal{A}_{G, \widehat{t}}$. Similarly, each edge e of the triangulation

T can be thickened a bit to become a disc with two distinguished points on its boundary provided by the vertices of e . They cut the boundary of the disc into two arcs. Let \widehat{e} be this disc with two marked points on the boundary, one on each of these arcs.

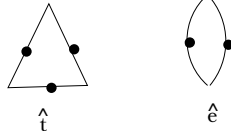

FIG. 8.1. —

The restriction provides a map $q_e : \mathcal{A}_{G,\widehat{S}} \longrightarrow \mathcal{A}_{G,\widehat{e}}$. All together, they provide a map

$$\varphi_T : \mathcal{A}_{G,\widehat{S}} \longrightarrow \prod_{t \in \text{tr}(T)} \mathcal{A}_{G,\widehat{t}} \times \prod_{e \in \text{ed}(T)} \mathcal{A}_{G,\widehat{e}}. \quad (8.17)$$

However the target space of this map is too big. Indeed, let e be an edge of a triangle t . Then there is a natural projection $q_{t,\widehat{e}} : \mathcal{A}_{G,\widehat{t}} \rightarrow \mathcal{A}_{G,\widehat{e}}$, and $q'_t q_{t,\widehat{e}} = q_{\widehat{e}}$. The subvariety in the right hand side of (8.17) defined by these conditions is the right target space. It contains the following open subset. Let us denote by $\widetilde{\text{Conf}}_n^* \mathcal{A}$ the variety of twisted cyclic configurations of n affine flags in generic position. It is isomorphic to $\text{Conf}_n^* \mathcal{A}$, but not canonically.

8.2. Definition. — *Let T be an ideal triangulation of \widehat{S} . The subvariety*

$$\mathcal{A}_{G,T} \subset \prod_{t \in \text{tr}(T)} \widetilde{\text{Conf}}_3^* \mathcal{A} \times \prod_{e \in \text{ed}(T)} \widetilde{\text{Conf}}_2^* \mathcal{A}$$

is defined by the conditions $q'_t q_{t,\widehat{e}} = q_{\widehat{e}}$ for every pair (e,t) where e is an edge of the triangle t of T .

8.1. Theorem. — *Let G be a split simply-connected semi-simple algebraic group. Let \widehat{S} be a marked hyperbolic surface and T an ideal triangulation of \widehat{S} . Then there exists a regular open embedding*

$$\nu_T : \mathcal{A}_{G,T} \hookrightarrow \mathcal{A}_{G,\widehat{S}} \quad (8.18)$$

such that $\varphi_T \nu_T$ is the identity.

Proof. Let us introduce a convenient way to think of local systems on the punctured tangent bundle $T'S$ having the monodromy s_G around the

circle $T'_x S$. Let Γ be a graph on S dual to an ideal triangulation T . Let us define a collection of points in $T'S$ as follows. For every edge e of the graph Γ let us choose an internal point $x(e)$ on this edge, and a pair of non zero tangent vectors $v_1(e)$ and $v_2(e)$ at this point looking in the opposite directions from e , as on the right in Figure 8.2.



FIG. 8.2. —

We are going to define a groupoid \mathcal{G}_Γ with the objects given by the points $\{v_i(e)\}$, where e runs through all the edges of Γ and $i \in \{1, 2\}$, which is equivalent to the fundamental groupoid of $T'S$. Therefore local $G(F)$ -systems on $T'S$ can be understood as functors $\mathcal{G}_\Gamma \rightarrow G(F)$. Here is a system of generators of the groupoid \mathcal{G}_Γ .

1). In the torsor of paths in $T'_{x(e)} S$ connecting the vectors $v_1(e)$ and $v_2(e)$ there are two distinguished elements, p_+ and p_- , where p_+ moves the vector $v_1(e)$ clockwise, and p_- counterclockwise towards the vector $v_2(e)$. By definition $p_\pm \in \text{Mor}_{\mathcal{G}_\Gamma}(v_1(e), v_2(e))$.

2). Let v be a vertex of Γ . Choose a sufficiently small neighborhood \mathcal{D}_v of v containing the three edges sharing v . Then the space of nonzero tangent vectors at the points of $\Gamma \cap \mathcal{D}_v$ which are not tangent to Γ is a union of three connected simply connected components. Therefore if we denote by e_1, e_2, e_3 the three edges sharing v , each connected component has exactly two of the six vectors $v_i(e_j)$. By definition the unique path connecting each pair belongs to the morphisms in \mathcal{G}_Γ .

The arcs on the left in Figure 8.2 illustrate the six generators of the groupoid near a vertex of Γ . They form a hexagon H_v . The arcs illustrate how the tangent vectors move. So for instance the left arc on Figure 8.2 intersecting Γ moves the tangent vector looking up clockwise to the one looking down. Putting the hexagons corresponding to all vertices of Γ together we get the set of the generators of the groupoid \mathcal{G}_Γ . On Figure 8.3 the objects of the groupoid \mathcal{G}_Γ are pictured by fat points, and the generators by arcs.

Here are two simple but crucial observations about this picture.

8.8. Lemma. — *a) The composition of the six path forming the hexagon H_v on the left picture in (8.2) amounts to rotation of a tangent vector by 4π .*

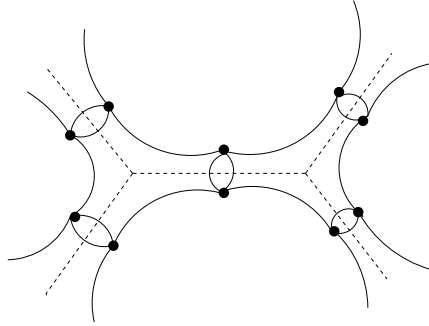

FIG. 8.3. —

b) The composition p_+p_+ as well as p_-p_- amounts to rotation of a tangent vector by 2π .

Proof. A simple exercise.

Let us consider a triangle t of the triangulation T dual to a vertex v of Γ . We may assume it intersects the edges e_j of Γ sharing the vertex v at the chosen points $x(e_j)$. Then there is a canonical homotopy class of path in $T'S$ going from the tangent vectors $v_i(e_j)$ along the corresponding side of the triangle t to proximity of the corresponding vertex of the triangle t , as in Figure 8.4.

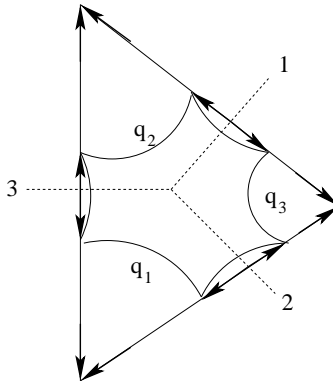

FIG. 8.4. —

Using this path and the decoration at this vertex of t we pick up an affine flag over the tangent vector $v_i(e_j)$. Let q be a side of the hexagon H_v which does not intersect Γ on Figure 8.3 (i.e. sits in one of the connected components discussed in 2)). Then the affine flags sitting at the endpoints of q are obtained one from the other by parallel transport along q .

Lemma 8.8a) implies that the monodromy around the hexagon H_v near a vertex v is the identity. So the restriction of the local system \mathcal{L} to the hexagon H_v is trivial. Therefore we can transform all the affine flags into a fiber over one point, getting a configuration of three affine flags (A_1, A_2, A_3) in G corresponding to the vertex v , as on Figure 8.5. The affine flags are parametrised by the vertices of the triangle t . Denote by B_1, B_2, B_3 the corresponding flags. Then we can attach the pairs (A_i, B_j) to the vertices of the hexagon H_v as in Figure 8.5.

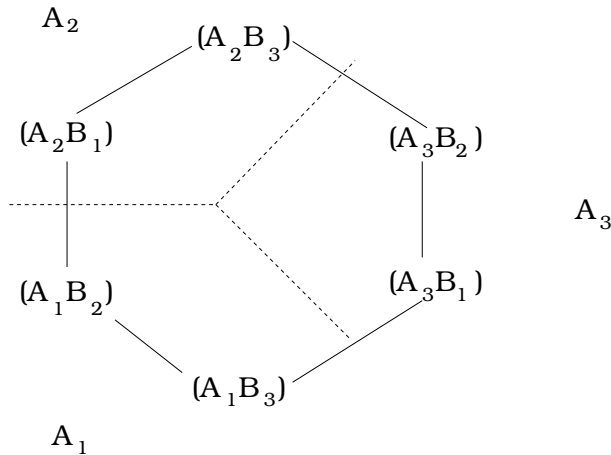

FIG. 8.5. —

Corresponding to each oriented edge \mathbf{a} of the hexagon H_v there is an element $g_{\mathbf{a}}$ of G defined as follows. Consider a triple of flags (A_1, A_2, A_3) representing our configuration. Let (A_i, B_j) and $(A_{i'}, B_{j'})$ be the pairs assigned to the first and second vertices of the oriented edge \mathbf{a} . There exists a unique element $g \in G$ transforming (A_i, B_j) to the standard pair (U^-, B^+) . Set $(A'_1, A'_2, A'_3) := (gA_1, gA_2, gA_3)$. We define $g_{\mathbf{a}}$ as the unique element of G such that $(A'_{i'}, B'_{j'}) = g_{\mathbf{a}}(U^-, B^+)$.

There are two types of edges of the graph on Figure 8.3: the ones intersecting the graph Γ on Figure 8.3, and the ones which do not intersect it. Each edge of the first type determines an edge of the triangulation T , and each edge of the second type determines a vertex of T . If \mathbf{p} (resp. \mathbf{q}) is an edge of the first (resp. second) type, then

$$g_{\mathbf{p}} \in \bar{w}_0 H, \quad g_{\mathbf{q}} \in U^-. \tag{8.19}$$

Each edge of the graph on Figure 8.3 is assigned to a unique hexagon H_v . Applying the above construction to the oriented edges \mathbf{a} of these hexagons we get a collection of elements $\{g_{\mathbf{a}}\}$ of G . It has the following properties:

i) Reversing orientation of an edge amounts to replacing the corresponding element by its inverse.

ii) The product of the elements corresponding to a path around the hexagon is the identity.

iii) The product of the elements corresponding to a simple path around a two-gon is s_G .

iv) Let \mathbf{q} (resp. \mathbf{p}) be an oriented edge corresponding to a vertex (resp. edge) of the triangulation T . Then one has (8.19).

By Lemma 8.8b) the monodromy around each of the two-gons on Figure 8.3 must be s_G . This agrees with iii).

We can invert this construction.

8.9. Lemma. — *Let $\{g_{\mathbf{a}}\}$ be an arbitrary collection of elements of $G(F)$ assigned to oriented edges of the graph on Figure (8.3), which satisfy the conditions i) - iv). Then there exists a twisted decorated $G(F)$ -local system on \widehat{S} such that the collection of elements $g_{\mathbf{a}}$ constructed for it coincide with the original collection.*

Proof. Thanks to the properties i) - iii) there exists a unique functor $\mathcal{G}_T \rightarrow G(F)$ determined by the condition $\mathbf{a} \mapsto g_{\mathbf{a}}$. Here $\mathbf{a}_1\mathbf{a}_2$ means that the path \mathbf{a}_1 follows \mathbf{a}_2 . It provides a twisted $G(F)$ -local system on \widehat{S} . The condition iv) is used to define a decoration. The lemma is proved.

Recall that a point of the variety $\mathcal{A}_{G,T}$ is given by a collection of twisted cyclic configurations (A_1^t, A_2^t, A_3^t) of affine flags in generic position, one for each triangle t of T , compatible over the internal edges of T . Given such a configuration (A_1^t, A_2^t, A_3^t) attached to a vertex v of T we assign to the oriented edges of the hexagon H_v the elements $g_{\mathbf{a}}$ as above. They satisfy the conditions i), ii), iv). Finally, the compatibility over the edges implies the condition iii). It remains to apply the construction from Lemma 8.9. The theorem is proved.

It remains to define a positive structure on the variety $\mathcal{A}_{G,T}$ and prove that the positive structures corresponding to different ideal triangulations T are compatible.

Consider $\widetilde{\text{Conf}}_3\mathcal{A}$ as a subspace of $\mathcal{A}_{G,\widehat{t}}$. Then choosing a vertex of the triangle t , we have

$$\widetilde{\text{Conf}}_3^*\mathcal{A} = \mathcal{V}_G \times (\widetilde{\text{Conf}}_2^*\mathcal{A})^3.$$

Recall that a positive structure on \mathcal{V}_G is given by Proposition 8.4. The positive coordinate systems are parametrized by reduced decompositions \mathbf{i} of the element w_0 . A positive structure on $\widetilde{\text{Conf}}_2^*\mathcal{A}$ is given by Proposition 8.1 and Lemma 8.1. This suggests the following definition.

8.3. Definition. — Denote by \mathbf{T} the following data on \widehat{S} :

- i) An ideal triangulation T of a marked hyperbolic surface \widehat{S} .
- ii) For each triangle t of the triangulation T a choice of a vertex of this triangle.
- iii) A reduced decomposition \mathbf{i} of the maximal length element $w_0 \in W$.

So given such a data \mathbf{T} and using Theorem 8.1 we have an open embedding

$$\nu_{\mathbf{T}} : \mathcal{V}_G^{\{\text{triangles of } T\}} \times H^{\{\text{edges of } T\}} \hookrightarrow \mathcal{A}_{G, \widehat{S}}. \tag{8.20}$$

8.2. Theorem. — Let G be a split simply-connected semi-simple algebraic group. Let \widehat{S} be a marked hyperbolic surface. Then the collection of regular open embeddings $\{\nu_{\mathbf{T}}\}$, when \mathbf{T} runs through all the data from Definition 8.3 assigned to \widehat{S} , provides a Γ_S -equivariant positive structure on $\mathcal{A}_{G, \widehat{S}}$.

Proof. We have to check that we get a compatible positive structure by changing any of the three components in the data \mathbf{T} from the definition 8.3. For iii) this follows from Lusztig’s theory [L1]. For ii) this follows from Proposition 8.2. To prove the statement for i) we need to check that a flip as on Figure 8.6 provides a positive transformation. This follows from Proposition 8.3. The theorem is proved.

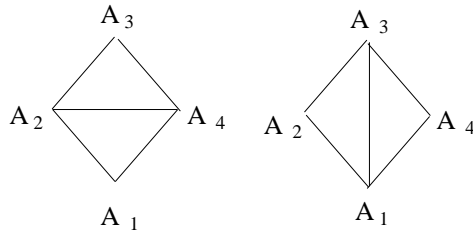

FIG. 8.6. — Flip.

8.4. Definition. — Let \widehat{S} be a hyperbolic marked surface and G a split simply-connected semi-simple algebraic group.

a) The decorated Teichmüller space $\mathcal{A}_{G, \widehat{S}}^+$ is the set of all $\mathbf{R}_{>0}$ -points of the positive space $\mathcal{A}_{G, \widehat{S}}$.

b) Let \mathbf{A}^t be one of the tropical semifields $\mathbf{Z}^t, \mathbf{Q}^t, \mathbf{R}^t$. The set $\mathcal{A}_{G, \widehat{S}}(\mathbf{A}^t)$ of points of the positive variety $\mathcal{A}_{G, \widehat{S}}$ with values in the tropical semifield \mathbf{A}^t is called the set of $\mathcal{A}^{\mathbf{A}}$ -laminations on \widehat{S} corresponding to G .

The space of real \mathcal{A} -laminations serves as the Thurston boundary of the Teichmüller space $\mathcal{A}_{G,\widehat{S}}^+$.

The decorated Teichmüller space $\mathcal{A}_{G,\widehat{D}_n}^+$ is identified with the space of positive twisted cyclic configurations of n affine flags in $G(\mathbf{R})$ on a disc \widehat{D}_n with n marked points on the boundary.

8.1. Corollary. — *The space $\mathcal{A}_{G,\widehat{D}_n}^+$ is invariant under the twisted cyclic shift.*

5. The universal Teichmüller \mathcal{A} -space for G . Let $\mathbf{S}^1(\mathbf{R})$ be the set of all rays in $\mathbf{R}^2 - \{0,0\}$. It is a $2 : 1$ covering of $\mathbf{P}^1(\mathbf{R})$. Let $\mathbf{S}^1(\mathbf{Q})$ be the subset of its rational points, i.e. arrows with rational slopes. Let s be the antipodal involution on $\mathbf{S}^1(\mathbf{R})$. It is the nontrivial automorphism of the covering.

Let $\{p_1, \dots, p_n\}$ be a cyclically ordered subset of $\mathbf{P}^1(\mathbf{Q})$, i.e. its order is compatible with one of the orientations of $\mathbf{P}^1(\mathbf{R})$. Then a choice of an initial point p_1 plus its lift \tilde{p}_1 determines a lift $\{\tilde{p}_1, \dots, \tilde{p}_n\}$ of the set $\{p_1, \dots, p_n\}$ to $\mathbf{S}^1(\mathbf{Q})$: we lift an oriented loop started at p_1 , whose orientation agrees with the cyclic order of the points p_i , to a path starting at \tilde{p}_1 , and lift the points p_1, \dots, p_n using this path. We say $\{\tilde{p}_1, \dots, \tilde{p}_n\}$ is a *coherent lift* of the cyclically ordered set $\{p_1, \dots, p_n\}$.

8.5. Definition. — *Let G be a split semi-simple simply-connected algebraic group. A map*

$$\alpha : \mathbf{S}^1(\mathbf{Q}) \longrightarrow \mathcal{A}(\mathbf{R}) \quad \text{such that } \alpha(sp) = s_G \alpha(p) \quad (8.21)$$

is positive if for any cyclically ordered n -tuple of points $\{p_1, \dots, p_n\}$ on $\mathbf{P}^1(\mathbf{Q})$, and a coherent lift $\{\tilde{p}_1, \dots, \tilde{p}_n\}$ of these points, the configuration of affine flags $(\alpha(\tilde{p}_1), \dots, \alpha(\tilde{p}_n))$ is positive.

The universal decorated Teichmüller space \mathcal{A}_G^+ is the quotient of the space of positive maps (8.21) by the action of the group $G(\mathbf{R})$.

Observe that if the configuration of affine flags $(\alpha(\tilde{p}_1), \dots, \alpha(\tilde{p}_n))$ is positive for a certain coherent lift of the cyclically ordered set $\{p_1, \dots, p_n\}$, it is positive for any such coherent lift. So the positivity is a property of $\{p_1, \dots, p_n\}$. Further, it follows from the main results of this Section that it is sufficient to check the positivity for $n = 2, 3$ only.

Recall the positive space \mathcal{V}_G , see (8.16). Let \mathcal{V}_G^+ be its positive part. Identifying $\mathbf{P}^1(\mathbf{Q})$ with vertices of the Farey triangulation, we have a decomposition theorem for the universal Teichmüller space \mathcal{A}_G^+ :

8.3. Theorem. — *There exists a canonical isomorphism*

$$\mathcal{A}_G^+ = \mathcal{V}_G^+ \{\text{Farey triangles}\} \times H(\mathbf{R}_{>0}) \{\text{Farey diagonals}\}.$$

To fix an isomorphism in this theorem, we have to choose a vertex for each of the Farey triangles.

The higher Teichmüller spaces $\mathcal{A}_{G,S}^+$ are embedded into the universal one just in the same fashion as for the \mathcal{X} -space. Here is a more invariant way to think about this.

6. The space $\mathcal{A}_{G,\widehat{S}}$ as a configuration space. Let $\widetilde{\mathcal{F}}_\infty(\widehat{S})$ be the cyclic set obtained as the 2 : 1 cover of the cyclic set $\mathcal{F}_\infty(\widehat{S})$. Given a hyperbolic metric on S , it is induced by the 2 : 1 cover of the absolute $\partial\mathcal{H}$. Let σ be the non-trivial automorphism of this cover. Recall the central extension $\overline{\pi}_1(S)$ of $\pi_1(S)$ by the group $\mathbf{Z}/2\mathbf{Z}$ defined in Section 2.4. The generator of the subgroup $\mathbf{Z}/2\mathbf{Z}$ is denoted by $\overline{\sigma}_S$. The group $\overline{\pi}_1(S)$ acts by automorphisms of the cyclic set $\widetilde{\mathcal{F}}_\infty(\widehat{S})$; in particular the element $\overline{\sigma}_S$ acts by the automorphism σ .

The moduli space $\mathcal{A}_{G,\widehat{S}}(\mathbf{C})$ parametrises the pairs (ψ, ρ) modulo $G(\mathbf{C})$ -conjugation, where $\rho : \overline{\pi}_1(S) \rightarrow G(\mathbf{C})$ is a representation, $\rho(\overline{\sigma}_S) = s_G$, and

$$\psi : \widetilde{\mathcal{F}}_\infty(\widehat{S}) \longrightarrow \mathcal{A}(\mathbf{C}), \quad \psi(\sigma) = s_G.$$

is a ρ -equivariant map. The Teichmüller space $\mathcal{A}_{G,\widehat{S}}^+$ parametrises the pairs (ψ, ρ) where ψ is a positive map (and hence both ψ and ρ are real).

9. Special coordinates on the \mathcal{A} and \mathcal{X} spaces when G is of type A_m

Let Γ be a marked trivalent ribbon graph. We assume it is not a special graph in the sense of Section 3.8: the special graphs are treated as in Section 10.7. Then there are varieties $\mathcal{X}_{G,\Gamma}$ and $\mathcal{A}_{G,\Gamma}$ parametrising framed and decorated unipotent G -local systems on Γ . If Γ is of type \widehat{S} , they are isomorphic to $\mathcal{X}_{G,\widehat{S}}$ and $\mathcal{A}_{G,\widehat{S}}$. The corresponding isomorphisms depend on a choice of an isotopy class of embedding of Γ to \widehat{S} . They form a principal homogeneous space over the mapping class group.

In this chapter we introduce some natural functions $\{\Delta_i\}$ and $\{X_j\}$ on the varieties $\mathcal{A}_{\text{SL}_m,\Gamma}$ and $\mathcal{X}_{\text{PGL}_m,\Gamma}$. The combinatorial data parametrising these functions has been described already in the Section 1.13, and will be briefly recalled below.

1. The sets I_m^{Γ} and J_m^{Γ} parametrising the canonical coordinates.

Let Γ be a marked trivalent graph on S of type \widehat{S} . Then there is an ideal triangulation T_{Γ} of \widehat{S} dual to Γ . It is determined up to an isomorphism by the ribbon structure of Γ . Precisely, let Γ_1, Γ_2 be two graphs as above such that the corresponding marked ribbon graphs $\overline{\Gamma}_1$ and $\overline{\Gamma}_2$ are isomorphic. Then an isomorphism $\overline{\Gamma}_1 \rightarrow \overline{\Gamma}_2$ determines uniquely an element g of the mapping class group of S such that $g\Gamma_1$ is isotopic to Γ_2 , and hence gT_{Γ_1} is isotopic to T_{Γ_2} .

Summarizing, a marked ribbon trivalent graph Γ of type \widehat{S} determines an ideal triangulation $T = T_{\Gamma}$ of a marked surface \widehat{S}_{Γ} isomorphic to \widehat{S} . The isotopy class of an isomorphism $\widehat{S}_{\Gamma} \rightarrow \widehat{S}$ is determined by an isotopy class of an embedded graph Γ . In this chapter we work with the marked ribbon trivalent graph Γ , the corresponding triangulation $T = T_{\Gamma}$, and surface $\widehat{S} = \widehat{S}_{\Gamma}$. Recall the m -triangulation of an ideal triangulation T_{Γ} of the surface \widehat{S}_{Γ} defined in the Section 1.13. It provides the oriented graph described there and denoted T_m . Recall the two sets, I_m^T and J_m^T , attached to the triangulation. Since the triangulation T and the corresponding graph Γ determine each other, we can use the upper script Γ in the notations. So

$$I_m^{\Gamma} := \{\text{vertices of the } m\text{-triangulation of } T_{\Gamma}\} - \{\text{vertices at the punctures of } S\}, \quad (9.1)$$

$$J_m^{\Gamma} := I_m^{\Gamma} - \{\text{the vertices at the boundary of } S\}.$$

Remark. If $\Gamma \mapsto \Gamma'$ is a flip then there is canonical bijection $I_m^{\Gamma} \longrightarrow I_m^{\Gamma'}$. However the oriented graphs T_m and T'_m are different.

Examples. 1. The set J_2^{Γ} is identified with the set of all internal (= not ends) edges of Γ .

2. $\widehat{S} = S$ if and only if $I_m^{\Gamma} = J_m^{\Gamma}$ is the same set.

3. Figure 9.1 illustrates the 3-triangulation of a disk with 5 marked points on the boundary. The disk is given by a pentagon. The ideal triangulation of the disk is given by triangulation of the pentagon. The boldface points illustrate the elements of the set J_3^{Γ} . Adding to them the points visualized by little circles we get the set I_3^{Γ} . So $|J_3^{\Gamma}| = 7$ and $|I_3^{\Gamma}| = 17$.

A parametrisation of the sets I_m^{Γ} and J_m^{Γ} . Choose a vertex v of Γ . It is dual to a triangle of the triangulation T . The inner vertices of the m -triangulation of this triangle are described by triples of nonnegative integers with sum m

$$(a, b, c), \quad a + b + c = m, \quad a, b, c \in \mathbf{Z}_{\geq 0} \quad (9.2)$$

such that at least two of the numbers a, b, c are different from zero.

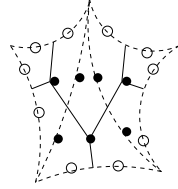

FIG. 9.1. — A 3-triangulation of the disc with 5 marked points on the boundary.

We say that a triple (a, b, c) is of *vertex type* if $a, b, c > 0$, and picture the integers a, b, c at the pieces of faces of Γ sharing the vertex v :

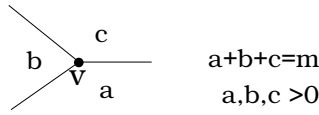

FIG. 9.2. — A triple (a, b, c) of vertex type.

If one (and hence the only one) of the integers a, b, c is zero, the other two determine an edge e containing v . In this case we say that the triple (a, b, c) is of *edge type*:

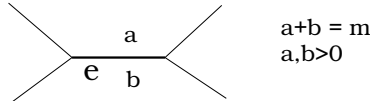

FIG. 9.3. — A pair (a, b) of the edge type.

The vertex/edge type elements correspond to the vertices of the m -triangulation located inside of the triangles/edges of the dual triangulation $\widehat{\Gamma}$.

2. The regular functions Δ_i on the space $\mathcal{A}_{\text{SL}_m, \Gamma}$. They are parameterised by $i \in I_m^\Gamma$.

We use the following notation. Let V be a vector space of dimension n and $\omega \in \det V^*$ a volume form in V . Let v_1, \dots, v_n be vectors of V . Set

$$\Delta(v_1, \dots, v_n) := \Delta_\omega(v_1, \dots, v_n) := \langle v_1 \wedge \dots \wedge v_n, \omega \rangle .$$

Let $i \in I_m^\Gamma$. Then there is a triangle of the triangulation T containing i , dual to a vertex v of Γ . This triangle is unique if i is of vertex type. Otherwise there are two such triangles.

The vertex functions. Let \mathcal{L}_v be the fiber of the local system \mathcal{L} at a vertex v . Then, by definition, it carries a monodromy invariant volume form

ω . There are three monodromy operators $M_{v,\alpha}$, $M_{v,\beta}$ and $M_{v,\gamma}$ acting on \mathcal{L}_v . They correspond to the three face paths α, β, γ starting at v . Given a decorated SL_m -local system \mathcal{L} on Γ we get three affine flags

$$X = (x_1, \dots, x_m); \quad Y = (y_1, \dots, y_m); \quad Z = (z_1, \dots, z_m)$$

at \mathcal{L}_v . Each of the flags X , Y and Z is invariant under the corresponding monodromy operator:

$$M_{v,\alpha}(X) = X, \quad M_{v,\beta}(Y) = Y, \quad M_{v,\gamma}(Z) = Z.$$

Recall that i is parametrised by a solution (a, b, c) of (9.2), and that the numbers (a, b, c) match the flags X, Y, Z . Put $x_{(a)} := x_1 \wedge \dots \wedge x_a$. The vertex function $\Delta_i = \Delta_{a,b,c}^v$ is defined by

$$\begin{aligned} \Delta_i(\mathcal{L}) &:= \Delta_{a,b,c}^v(X, Y, Z) := \Delta_\omega(x_{(a)} \wedge y_{(b)} \wedge z_{(c)}) = \\ &= \Delta_\omega(x_1 \wedge \dots \wedge x_a \wedge y_1 \wedge \dots \wedge y_b \wedge z_1 \wedge \dots \wedge z_c). \end{aligned}$$

Recall that the element s_G , which we use to define the twisted cyclic shift, equals $(-1)^{m-1}$ for $G = SL_m$. The vertex function is invariant under the twisted cyclic shift of affine flags:

$$\Delta_{a,b,c}^v(X, Y, Z) = \Delta_{c,a,b}^v((-1)^{m-1}Z, X, Y) \quad (9.3)$$

Indeed, the cyclic shift multiplies $\Delta_{a,b,c}^v$ by $(-1)^{c(a+b)}$. If $m = a + b + c$ is odd, then $c(a+b)$ is even. If $a + b + c$ is even, we get $(-1)^{c^2} = (-1)^c$. So $\Delta_{a,b,c}^v(X, Y, Z) = (-1)^c \Delta_{c,a,b}^v(Z, X, Y)$ for even m . On the other hand $\Delta_{c,a,b}^v(-Z, X, Y) = (-1)^c \Delta_{c,a,b}^v(Z, X, Y)$. Thus we get (9.3).

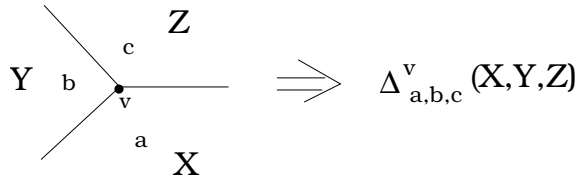

FIG. 9.4. — The data giving rise to a vertex function.

The edge functions. Let \mathcal{L}_e be the fiber of the local system \mathcal{L} at an edge e . The SL_m -structure provides a volume form ω in \mathcal{L}_e . There are two affine flags

$$X = (x_1, \dots, x_m); \quad Y = (y_1, \dots, y_m)$$

at \mathcal{L}_e invariant under the monodromies around the two face paths α and β sharing the edge e : $M_{v,\alpha}(X) = X, M_{v,\beta}(Y) = Y$. We picture each of the flags located at the corresponding face. We define the edge functions by

$$\Delta_i(\mathcal{L}) = \Delta_{a,b}^e(X, Y) := \Delta_\omega(x_{(a)} \wedge y_{(b)}) = \Delta_\omega(x_1 \wedge \dots \wedge x_a \wedge y_1 \wedge \dots \wedge y_b).$$

The same argument as for the vertex function shows that the edge function is invariant under the twisted cyclic shift of affine flags $(X, Y) \mapsto ((-1)^{m-1}Y, X)$.

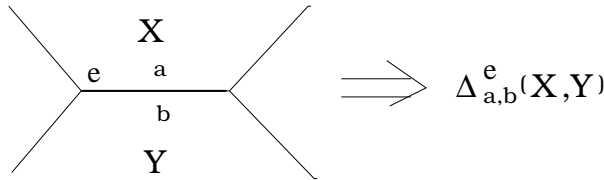

FIG. 9.5. — The data giving rise to an edge function.

3. The rational functions X_j on the space $\mathcal{X}_{PGL_m, \Gamma}$. Let $i \in J_m^\Gamma$. Take all the vertices $j \in I_m^\Gamma$ connected with i by an edge in the graph T_m . Then there is one (if i is of vertex type) or two (if i is of edge type) triangles of T containing all these j 's. Consider the invariant flags attached to the vertices of these triangles. There are three such flags if i is vertex type, and four if it is of the edge type, see the Figures 9.4 and 9.5. We can arrange these flags to sit in the same vector space \mathcal{L}_v (respectively \mathcal{L}_e). For each of these flags choose an affine flag dominating it. We denote by \tilde{F} the affine flag dominating a flag F . Then for each j as above we have the Δ_j -coordinate calculated for these affine flags. We denote it $\tilde{\Delta}_j$. We set

$$X_i = \prod_{j \in I_m^\Gamma} (\tilde{\Delta}_j)^{\varepsilon_{ij}}. \quad (9.4)$$

The right hand side evidently does not depend on the choice of dominating affine flags. Below we work out this definition for the vertex and edge type i 's.

The vertex functions $X_{a,b,c}^v$. They are given by

$$X_{a,b,c}^v(X, Y, Z) := \frac{\Delta_{a-1,b+1,c}(\tilde{X}, \tilde{Y}, \tilde{Z}) \Delta_{a,b-1,c+1}(\tilde{X}, \tilde{Y}, \tilde{Z}) \Delta_{a+1,b,c-1}(\tilde{X}, \tilde{Y}, \tilde{Z})}{\Delta_{a+1,b-1,c}(\tilde{X}, \tilde{Y}, \tilde{Z}) \Delta_{a,b+1,c-1}(\tilde{X}, \tilde{Y}, \tilde{Z}) \Delta_{a-1,b,c+1}(\tilde{X}, \tilde{Y}, \tilde{Z})}.$$

The structure of this formula is illustrated on Figure 9.6:

$$\mathbf{X}\left(\begin{array}{c} \text{c} \\ \text{b} \text{---} \text{a} \end{array}\right) = \frac{\begin{array}{c} \text{c} \\ \text{b+1} \text{---} \text{a-1} \end{array} \cdot \begin{array}{c} \text{c+1} \\ \text{b-1} \text{---} \text{a} \end{array} \cdot \begin{array}{c} \text{c-1} \\ \text{b} \text{---} \text{a+1} \end{array}}{\begin{array}{c} \text{c} \\ \text{b-1} \text{---} \text{a+1} \end{array} \cdot \begin{array}{c} \text{c-1} \\ \text{b+1} \text{---} \text{a} \end{array} \cdot \begin{array}{c} \text{c+1} \\ \text{b} \text{---} \text{a-1} \end{array}}$$

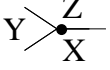

— The flags at the vertex v

FIG. 9.6. — The vertex function.

The edge functions $X_{a,b}^e$. They are given by

$$X_{a,b}^e(\tilde{X}, \tilde{Y}, \tilde{Z}, \tilde{T}) := \frac{\Delta_{a,b-1,1}(\tilde{X}, \tilde{Z}, \tilde{T}) \Delta_{a-1,1,b}(\tilde{X}, \tilde{Y}, \tilde{Z})}{\Delta_{a-1,b,1}(\tilde{X}, \tilde{Z}, \tilde{T}) \Delta_{a,1,b-1}(\tilde{X}, \tilde{Y}, \tilde{Z})}$$

The structure of this formula is illustrated on Figure 9.7:

$$\mathbf{X}\left(\begin{array}{c} \text{a} \\ \text{---} \\ \text{b} \end{array}\right) := \frac{\begin{array}{c} \text{a} \\ \text{1} \text{---} \text{b-1} \end{array} \cdot \begin{array}{c} \text{a-1} \\ \text{0} \text{---} \text{b} \end{array}}{\begin{array}{c} \text{a-1} \\ \text{1} \text{---} \text{b} \end{array} \cdot \begin{array}{c} \text{a} \\ \text{0} \text{---} \text{b-1} \end{array}}$$

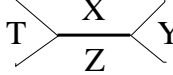

— The flags near an edge e

FIG. 9.7. — The edge function.

Recall the canonical projection

$$p : \mathcal{A}_{SL_n, \hat{S}} \longrightarrow \mathcal{X}_{PGL_n, \hat{S}}. \tag{9.5}$$

9.1. Proposition. — *One has*

$$p^* X_i = \prod_{j \in I_m^r} (\Delta_j)^{\varepsilon_{ij}}. \tag{9.6}$$

Proof. This is a reformulation of the formula (9.4). The proposition is proved.

It is easy to see using Lemma 6.3 that the total number of the X -functions equals to the dimension of the space of all PGL_m -local systems on S .

4. The cross-ratio and the triple ratio. The space of orbits of the group PGL_2 acting on the 4-tuples of distinct points on P^1 is one dimensional. There is a classical coordinate on the orbit space, called the *cross-ratio* of four points x_1, \dots, x_4 . To define it we present P^1 as the projectivisation of a two dimensional vector space V , and choose four vectors v_1, \dots, v_4 in V projecting to the given points x_1, \dots, x_4 in $P(V)$. Then

$$r^+(x_1, \dots, x_4) := \frac{\Delta(v_1, v_2)\Delta(v_3, v_4)}{\Delta(v_1, v_4)\Delta(v_2, v_3)}. \tag{9.7}$$

One has $r^+(\infty, -1, 0, t) = t$, and

$$r^+(x_1, x_2, x_3, x_4) = r^+(x_2, x_3, x_4, x_1)^{-1}; \quad r^+(x_1, x_2, x_3, x_4) = -1 - r^+(x_1, x_3, x_2, x_4).$$

To check the second equality we use the Plücker relation

$$\Delta(v_1, v_2)\Delta(v_3, v_4) - \Delta(v_1, v_3)\Delta(v_2, v_4) + \Delta(v_1, v_4)\Delta(v_2, v_3) = 0.$$

We also need a *triple ratio* of three flags in P^2 as defined in s. 3.5 of [G2]. The space of the orbits of the group PGL_3 acting on the triples of flags F_1, F_2, F_3 in P^2 is one dimensional. The triple ratio $r_3^+(F_1, F_2, F_3)$ is a natural coordinate on this space. To define it, let us present P^2 as a projectivisation of a three dimensional vector space V . Choose three affine flags A_1, A_2, A_3 dominating the flags F_1, F_2, F_3 in $P(V)$. We represent the flags A_i as the pairs (v_i, f_i) where $v_i \in V, f_i \in V^*$ and $\langle f_i, v_i \rangle = 0$. Then set

$$r_3^+(F_1, F_2, F_3) := \frac{\langle f_1, v_2 \rangle \langle f_2, v_3 \rangle \langle f_3, v_1 \rangle}{\langle f_1, v_3 \rangle \langle f_2, v_1 \rangle \langle f_3, v_2 \rangle}.$$

This definition obviously does not depend on the choice of the pair (v, f) representing a flag F . It is useful to rewrite this definition using the presentation of the affine flags given by

$$A_1 = (x_1, x_1 \wedge x_2), \quad A_2 = (y_1, y_1 \wedge y_2), \quad A_3 = (z_1, z_1 \wedge z_2).$$

Then

$$r_3^+(F_1, F_2, F_3) := \frac{\Delta(x_1, x_2, y_1)\Delta(y_1, y_2, z_1)\Delta(z_1, z_2, x_1)}{\Delta(x_1, x_2, z_1)\Delta(y_1, y_2, x_1)\Delta(z_1, z_2, y_1)}. \tag{9.8}$$

9.1. Lemma. — *A triple (F_1, F_2, F_3) of real flags in $\mathbf{R}P^2$ is positive if and only if the points x_i are at the boundary of a convex domain bounded by the lines of the flags, as on Figure 9.8.*

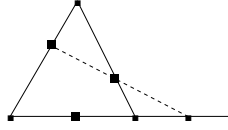

FIG. 9.8. — A positive triple of flags.

Proof. A generic triple of flags can be presented as follows: $v_1 = (0, 1, 1)$; $v_2 = (1, 0, 1)$; $v_3 = (1, t, 0)$; $f_1 = x_1$, $f_2 = x_2$, $f_3 = x_3$. Its triple ratio is t . Such a triple of flags satisfies the condition of the lemma if and only if $t > 0$. The lemma is proved.

Let $F_i = (x_i, L_i)$ be a flag in P^2 , so x_i is a point on a line L_i , and $i = 1, 2, 3$. Consider the triangle formed by the lines L_1, L_2, L_3 . Denote by y_1, y_2, y_3 its vertices, so y_i is opposite to the line L_i . Let \hat{x} be the point of intersection of the line L_3 and the line through the points x_1 and x_2 . Then the proof of Lemma 9.1 shows that

$$r_3^+(F_1, F_2, F_3) = r^+(y_1, \hat{x}, y_2, x_3).$$

Remark. One can find a yet different definition of the triple ratio in Section 4.2 of [G5].

It follows that the cross- and triple ratios provide isomorphisms

$$r^+ : \{4\text{-tuples of distinct points of } \mathbf{P}^1\} / PGL_2 \xrightarrow{\sim} \mathbf{P}^1 - \{0, -1, \infty\},$$

$$r_3^+ : \{\text{generic triples of flags of } \mathbf{P}^2\} / PGL_3 \xrightarrow{\sim} \mathbf{P}^1 - \{0, -1, \infty\}.$$

Remark. It is often useful to change the sign in the definition of the cross- and triple ratios: $r := -r^+$ and $r_3 := -r_3^+$.

5. Expressing the X -functions via the cross- and triple ratios.

The vertex functions. Recall that F_k is the k -dimensional subspace of a flag F . For generic configuration of flags (X, Y, Z) the quotient

$$\frac{L_v}{X_{a-1} \oplus Y_{b-1} \oplus Z_{c-1}} \tag{9.9}$$

is a three dimensional vector space. It inherits a configuration of three flags $(\overline{X}, \overline{Y}, \overline{Z})$. Namely, the flag \overline{X} is given by the projection of the flag $(X_a/X_{a-1} \subset X_{a+1}/X_{a-1} \subset \dots)$ onto (9.9), and so on. The vertex X -function $X_{a,b,c}$ equals to their triple ratio:

$$X_{a,b,c}(X, Y, Z) = r_3^+(\overline{X}, \overline{Y}, \overline{Z}).$$

The edge X-functions. For a generic configuration of flags (X, Y, Z, T) in L_e then the quotient

$$\frac{L_e}{X_{a-1} \oplus Y_{b-1}}$$

is a two dimensional vector space. It inherits a configuration $(\overline{X}_a, \overline{Y}_1, \overline{Z}_b, \overline{T}_1)$ of four distinct one dimensional subspaces: $\overline{X}_a := X_a/X_{a-1}$ and so on. Their cross-ratio is the edge X -function $X_{a,b}$:

$$X_{a,b}(X, Y, Z, T) = r^+(\overline{T}_1, \overline{X}_a, \overline{Y}_1, \overline{Z}_b).$$

6. The main result. Let us choose an isotopy class Γ of a marked trivalent graph on \widehat{S} isomorphic to a marked ribbon graph Γ . It provides an isomorphism of the moduli spaces $f_\Gamma : \mathcal{X}_{PGL_m, \Gamma} \longrightarrow \mathcal{X}_{PGL_m, \widehat{S}}$. Thus the rational function X_j gives rise to a rational function X_j^Γ on the moduli spaces $\mathcal{X}_{PGL_m, \widehat{S}}$. Similarly there are regular functions Δ_i^Γ .

9.1. Theorem. — *a) The collections of rational functions $\{X_j^\Gamma\}$, $j \in J_m^\Gamma$, where Γ runs through the set of all isotopy classes of marked trivalent graphs on \widehat{S} of type \widehat{S} , provide a positive regular atlas on $\mathcal{X}_{PGL_m, \widehat{S}}$.*

b) The collections of regular functions $\{\Delta_i^\Gamma\}$, $i \in I_m^\Gamma$, provide a positive regular atlas on $\mathcal{A}_{SL_m, \widehat{S}}$.

Plan of the proof. In Sections 9.7 and 9.8 we give a yet another definition of the X -coordinates on the configuration space of triples and quadruples of flags in V_m . We show in Lemmas 9.2, 9.3, and 9.5 that it gives the same X -coordinates as in Section 9.2. The results of Section 9.8 make obvious that they are related to the general definition for a standard reduced decomposition of w_0 , see Lemma 9.5. Similarly our Δ -coordinates on the space $\mathcal{A}_{SL_m, \Gamma}$ are evidently related to the A -coordinates from Section 8 for a standard reduced decomposition of w_0 . However our special coordinates have some remarkable features which are absent in the general case even for SL_m and nonstandard reduced decompositions of w_0 . For example the coordinates defined in Section 9.2-9.3 on the configuration space of triples of (affine) flags in V_m are manifestly invariant under the cyclic (twisted cyclic) shift.

So the positivity statements in Theorem 9.1 are special cases of the ones in Theorem 1.4. On the other hand these statements follow immediately from the results of Section 10. This way we get simpler proofs of the positivity results, which are independent from the proof of the Theorem 1.4.

We show that our X -functions provide a regular atlas in Section 9.9. A similar statement about the Δ -coordinates is reduced to the one about the X -coordinates using the fact that the projection $\mathcal{A}_{SL_m, \hat{S}} \rightarrow \mathcal{X}_{PGL_m, \hat{S}}$ is obtained by factorization along the action of a power of the Cartan group.

Let us start the implementation of this plan.

7. Projective bases determined by three flags. A *projective basis* in a vector space V is a basis in V up to a multiplication by a common scalar. Projective bases in V form a principal homogeneous space for $PGL(V)$. Let A, B, C be three flags at generic position in an m -dimensional vector space V . Below we introduce several different projective bases in V related to these flags, and compute the elements of PGL_m transforming one of these bases to the other.

Consider the $(m-1)$ -triangulation of a triangle shown on the Figure 9.9. Each side of the triangle carries m vertices of the $(m-1)$ -triangulation. There are two types of the triangles, the triangles looking down, and the triangles looking up. We picture them as the white and grey triangles. Let us assign the flags A, B, C to the vertices of the big triangle. The side across the A -vertex is called the A -side, etc.. The vertices of the $(m-1)$ -triangulation are parametrized by non negative integer solutions of the equation $a + b + c = m - 1$. The (a, b, c) -coordinates of a vertex show the distance from the vertex to the A, B and C sides of the triangle. A vertex A of the big triangle provides two arrows which start at A and look along one of the two sides sharing A . A *snake* is a path in the one-skeleton of the $(m-1)$ -triangulation from one of the vertices of the big triangle to the opposite side, which each time goes in the direction of one of the two arrows assigned to the vertex.

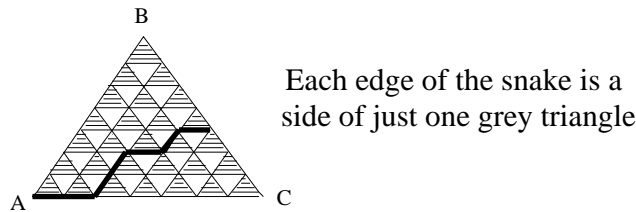

FIG. 9.9. — A snake.

A snake provides a projective basis in V . Indeed, let $F^a := F_{m-a}$ be the codimension a subspace of a flag F . We attach to each vertex (a, b, c) a one-dimensional subspace $V^{a,b,c} := A^a \cap B^b \cap C^c$. The one-dimensional subspaces V_1, V_2, V_3 attached to the vertices of any grey triangle t span a two-dimensional subspace $V(t)$. The subspaces V_1, V_2, V_3 provide six projective bases in $V(t)$, assigned to the oriented sides of the triangle t . Namely, we

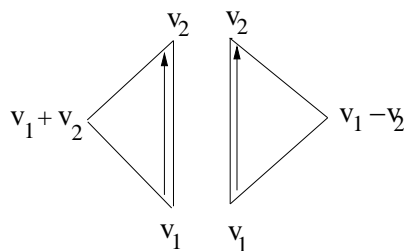

FIG. 9.10. — Defining two projective bases in a two dimensional space.

assume that the triangle t is counterclockwise oriented. Then if the side V_1V_2 is oriented according to the orientation of t , we choose vectors $v_1 \in V_1$ and $v_2 \in V_2$ so that $v_1 - v_2 \in V_3$. If not, we choose vectors $v_1 \in V_1$ and $v_2 \in V_2$ so that $v_1 + v_2 \in V_3$, as shown on the picture.

Remark. This definition of the six projective bases agrees with the one given in Section 6.2.

Each edge of the triangulation is a boundary of just one grey triangle. Using this observation, let us construct a projective basis corresponding to a snake. Let e_1, \dots, e_{m-1} be the edges of the snake in their natural order, so the A -vertex belongs to e_1 . Denote by t_1, \dots, t_{m-1} the grey triangles containing these edges. Each edge e_i determines a projective basis in the subspace $V(t_i)$. A nonzero vector $v_1 \in V^{m-1,0,0}$ determines a natural basis v_1, \dots, v_m parametrized by vertices of the snake. Indeed, v_1 plus a projective basis in $V(t_1)$ corresponding to e_1 determines a vector v_2 in $V(t_1)$. The vector v_2 plus a projective basis in $V(t_2)$ corresponding to e_2 provides v_3 , and so on. All together they provide a projective basis.

8. Transformations between different projective bases related to three flags. Let us compute the element of PGL_m transforming the projective basis corresponding to a snake to the one corresponding to another snake. We assume that the group PGL_m acts on projective bases from the left. First, let us do it for the snakes sharing the same vertex of the big triangle, say the vertex A . An elementary move of a snake is one of the following two local transformations on Figure 9.11:

We can transform one snake to another using a sequence of elementary moves. An example for $m = 3$ see on Figure 9.12. In general such a sequence of elementary moves is not unique.

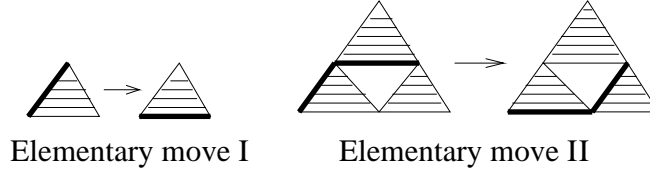
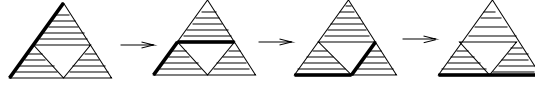

FIG. 9.11. — Elementary moves of the snake.

FIG. 9.12. — Moving the snake in the case $m = 3$.

Let us calculate the elements of PGL_2 and PGL_3 corresponding to the elementary moves I and II. For the elementary move I we get

$$\begin{pmatrix} v_1 \\ v_2 \end{pmatrix} \mapsto \begin{pmatrix} 1 & 0 \\ 1 & 1 \end{pmatrix}, \quad \begin{pmatrix} v_1 \\ v_2 \end{pmatrix} = \begin{pmatrix} v_1 \\ v_1 + v_2 \end{pmatrix}.$$

Here the vectors $v_1, v_2, v_1 + v_2$ in $V(t)$ correspond to the vertices of a grey triangle t , so (v_1, v_2) is the projective basis related to the left edge of t , and $(v_1, v_1 + v_2)$ is the one related to the bottom edge of t .

Observe that the white triangles, which has been defined using the $(m-1)$ -triangulation, are in one to one correspondance to the inner vertices of the m -triangulation, which have coordinates $a + b + c = m$ with $a, b, c > 0$. The vertex X -coordinates are assigned to the white triangles. Namely, let α, β, γ be the distances from a white triangle to the sides of the triangle, $\alpha + \beta + \gamma = m - 3$. Then the flags A, B, C induce the flags $\overline{A}, \overline{B}, \overline{C}$ in the three dimensional quotient

$$\frac{V}{A_\alpha \oplus B_\beta \oplus C_\gamma}. \quad (9.10)$$

The triple ratio of these three flags is the X -coordinate corresponding to the white triangle. Thus $X_{\alpha, \beta, \gamma} = X_{a, b, c}$ with $a = \alpha + 1, b = \beta + 1, c = \gamma + 1$.

Now consider an elementary move of type II corresponding to a white triangle. Let us calculate the corresponding element of PGL_m , and show that it depends only on the X -coordinate assigned to this white triangle. Denote by a a vector spanning the one dimensional subspace \overline{A}_1 of the flag \overline{A} . There are two choices for the vectors spanning $\overline{B}_2 \cap \overline{C}_2$: the vector r_1 is defined via the first snake, and the vector r_2 defined via the second one on the picture describing the elementary move II. Then

$$r_1 = Xr_2. \quad (9.11)$$

9.2. Lemma. — *The number X in (9.11) is the X -coordinate of the flags $\overline{A}, \overline{B}, \overline{C}$.*

Proof. A choice of vector a provides the vectors b, c, p, q spanning the subspaces $\overline{B}_1, \overline{C}_1, \overline{A}_2 \cap \overline{B}_2, \overline{A}_2 \cap \overline{C}_2$ respectively, and defined using the left (for b and p) and the right (for c and q) snakes. The three grey triangles provide the relations

$$r_1 = p + b, \quad q = a + p, \quad c = q + r_2. \quad (9.12)$$

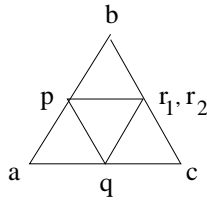

FIG. 9.13. — The vectors p, q, r_1, r_2 .

Therefore, as easily follows from (9.11) and (9.12), one has

$$X(\overline{A}, \overline{B}, \overline{C}) = \frac{\Delta(b, p, c)}{\Delta(c, q, b)} = \frac{\Delta(r_1, p, c)}{\Delta(r_2, p, c)}.$$

The first equality follows from the definition of triple ratio, applied to the three affine flags $(a, p), (b, r_1), (c, q)$ dominating the flags $\overline{A}, \overline{B}, \overline{C}$, using (9.12). The second is obtained using (9.12). Indeed, $\Delta(b, p, c) = -\Delta(r_1, p, c)$, and $\Delta(c, q, b) = \Delta(r_2, q, b) = \Delta(r_2, q, p) = \Delta(r_2, c, p) = -\Delta(r_2, p, c)$. and The lemma is proved.

Example. Let us compute the transformation between the projective bases corresponding to the two snakes on Figure 9.12. We present it as a composition: $(a, p, b) \mapsto (a, p, r_1) \mapsto (a, q, r_1) \mapsto (a, q, r_2) \mapsto (a, q, c)$. So thanks to (9.12) and Lemma 9.2 the corresponding matrix is

$$\begin{pmatrix} 1 & 0 & 0 \\ 0 & 1 & 0 \\ 0 & 1 & 1 \end{pmatrix} \begin{pmatrix} 1 & 0 & 0 \\ 0 & 1 & 0 \\ 0 & 0 & X^{-1} \end{pmatrix} \begin{pmatrix} 1 & 0 & 0 \\ 1 & 1 & 0 \\ 0 & 0 & 1 \end{pmatrix} \begin{pmatrix} 1 & 0 & 0 \\ 0 & 1 & 0 \\ 0 & 1 & 1 \end{pmatrix} = \begin{pmatrix} 1 & 0 & 0 \\ 1 & 1 & 0 \\ 1 & 1 + X^{-1} & X^{-1} \end{pmatrix} \in PGL_3. \quad (9.13)$$

Let us generalize this computation. Let $\varphi_i : SL_2 \hookrightarrow GL_m$ be the canonical embedding corresponding to the i -th root $\lambda_i - \lambda_{i+1}$. Set

$$F_i = \varphi_i \begin{pmatrix} 1 & 0 \\ 0 & 1 \end{pmatrix}, \quad H_i(x) := \text{diag}(\underbrace{x, \dots, x}_i, 1, \dots, 1).$$

So $H_i : \mathbf{G}_m \rightarrow H$ is the coroot corresponding to the root $\lambda_i - \lambda_{i+1}$. So $H_i(x)$ commutes with F_j and E_j if $i \neq j$. So the left hand side of (9.13) can be written as $F_2 H_2(X) F_1 F_2 = F_2 F_1 H_2(X) F_2$.

Let $X_{\alpha,\beta,\gamma}$, where $\alpha + \beta + \gamma = m - 3$, $\alpha, \beta, \gamma \geq 0$, be the vertex coordinates of the configuration of flags (A, B, C) . (They are the former coordinates X_{abc} , where $a = \alpha + 1$, $b = \beta + 1$, $c = \gamma + 1$.) Let $M_{AB \rightarrow AC}$ be the element transforming the projective basis corresponding to the snake AB to the one for the snake AC .

9.2. Proposition. — a) One has

$$M_{AB \rightarrow AC} = \prod_{j=m-1}^1 \left(\left(\prod_{i=j-1}^{m-2} H_{i+1}(X_{m-i-2, i-j, j-1}) F_i \right) F_{m-1} \right). \tag{9.14}$$

b) The element $M_{AB \rightarrow BA}$ is the transformation $S : e_i \mapsto (-1)^{i-1} e_{m+1-i}$.
 c) One has

$$M_{CA \rightarrow BA} = S M_{AB \rightarrow AC}^{-1} S^{-1}. \tag{9.15}$$

For example for $m = 2$ we get $M_{AB \rightarrow AC} = F_1$, for $m = 3$ we get

$$M_{AB \rightarrow AC} = F_2 H_2(X_{000}) F_1 F_2$$

and for $m = 4$

$$M_{AB \rightarrow AC} = F_3 H_3(X_{001}) F_2 F_3 H_2(X_{100}) F_1 H_3(X_{010}) F_2 F_3.$$

Remark. In the formula (9.14) between every two elements F_i , $i > 1$, which have no F_i 's in between, there is unique element $H_i(X)$ between them. Its precise location between the two F_i 's is not essential since $H_i(X)$ commutes with all the F 's located between the two F_i 's.

Proof. a) Let us define a sequence of elementary moves transforming the snake AB to the snake AC . The crucial intermediate steps of this sequence are shown on the picture below. We show the snakes which go j steps towards C , and then $m - j - 1$ steps in the direction AB , for $i = 0, \dots, m - 1$. In between we use the obvious elementary moves transforming the $(j - 1)$ -st snake to the the j -th.

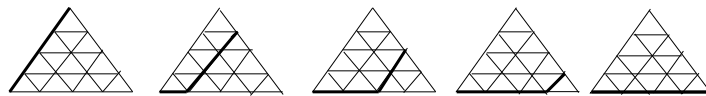

FIG. 9.14. — Moving the snake.

Now, just like in the above example, our formulas and Lemma 9.2 give the formula (9.14).

b) Let (A, B, C) be a cyclically ordered triple of distinct one dimensional subspaces in a two dimensional vector space. Let $[v_1, v_2]$ (respectively $[u_1, u_2]$) be the projective basis determined by the snake AB (respectively BA). This means that $v_1 + v_2 \in C$ (respectively $u_1 - u_2 \in C$). It follows that $u_1 = v_2, u_2 = -v_1$. This proves the claim in the two dimensional case. The general case immediately reduces to this.

c) This is obvious. The proposition is proved.

Remark. Since $SF_i^{-1}S^{-1} = E_{m-i}$, there is a formula for $M_{CA \rightarrow BA}$ similar to (9.14). In this formula we use the other standard reduced decomposition of w_0 encoding the sequence of E_i 's then the one encoding the sequence of F_i 's in (9.14).

Consider a configuration of four flags (A, B, C, D) . We assign them to vertices of a quadrilateral triangulated by the diagonal AC . There are two projective bases related to the snake AC : the one, $P_-(AC)$, comes from the triangle ABC , and the other, $P_+(AC)$, comes from the triangle ACD .

9.3. Lemma. — *Let $x_a = X_{a,m-2-a}$ be the coordinates attached to the edge AC . Then*

$$M_{P_-(AC) \rightarrow P_+(AC)} = \text{diag}(x_0 x_1 \dots x_{m-2}, \dots, x_{m-3} x_{m-2}, x_{m-2}, 1). \tag{9.16}$$

Proof. Follows from the SL_2 case, which was considered in the Example in the end of Section 6.6.

9. Comparison with the definitions of Sections 5 and 6. Recall the subsets $\bar{U}_*^-(\mathbf{i}) \subset U^-$ and $\bar{U}_*^+(\mathbf{j}) \subset U^+$ defined by reduced decompositions \mathbf{i} and \mathbf{j} of w_0 , see (6.5) and (6.6). Elements $\bar{u}_+ \in \bar{U}_*^+(\mathbf{i})$ and $\bar{u}_- \in \bar{U}_*^-(\mathbf{j})$ have canonical decompositions:

$$\bar{u}_+ = \prod_{j \in \mathbf{j}} x_j(s_j), \quad \bar{u}_- = \prod_{i \in \mathbf{i}} y_i(t_i), \quad s_j, t_i \in F^*. \tag{9.17}$$

The elements of the sets \mathbf{i} and \mathbf{j} are labeled by the simple roots $\alpha_1, \dots, \alpha_{m-1}$, providing the decompositions

$$\mathbf{i} = \mathbf{i}(\alpha_1) \cup \dots \cup \mathbf{i}(\alpha_{m-1}) \quad \mathbf{j} = \mathbf{j}(\alpha_1) \cup \dots \cup \mathbf{j}(\alpha_{m-1}).$$

Our convention was the following: let α be a simple root, j_α^+ is the right element of $\mathbf{j}(\alpha)$, i_α^- is the left element of $\mathbf{i}(\alpha)$. Then for each simple root α one has

$$x_{j_\alpha^+}(s_{j_\alpha^+}) = 1, \quad y_{i_\alpha^-}(t_{i_\alpha^-}) = 1. \tag{9.18}$$

Let $r = m - 1$, $\alpha_k = \lambda_k - \lambda_{k+1}$, $k = 1, \dots, m - 1$. Consider the following two reduced decomposition of the maximal length element in S_m :

$$\mathbf{i} = (\alpha_{m-1}, \alpha_{m-2}, \alpha_{m-1}, \dots, \alpha_2, \dots, \alpha_{m-1}, \alpha_1, \alpha_2, \dots, \alpha_{m-1}),$$

$$\mathbf{j} = (\alpha_{m-1}, \dots, \alpha_1, \alpha_{m-1}, \dots, \alpha_2, \dots, \alpha_{m-1}, \alpha_{m-2}, \alpha_{m-1}).$$

Consider the $(m - 1)$ -triangulation of the triangle ABC , as on Figure 9.9. Its grey triangles are presented as a union of $m - 1$ strips going parallel to the side BC . We enumerate the strips so that the k -th strip contains k the grey triangles. These numbers match the simple roots: k corresponds to $\lambda_k - \lambda_{k+1}$. Then the string \mathbf{i} provides an enumeration of the grey triangles from C to AB going in each layer parallel AB from A to B . Let t be a white triangle and t' the grey triangle sharing a side with t , obtained from t by going towards B . Recall that our special X -coordinates are naturally attached to the white triangles. We assign the product of the X -coordinates attached to all the white triangles belonging to the layer parallel to BC from t to AC , to the corresponding grey triangle t' . Finally, we assign 1 to the grey triangles neighboring the side AC .

9.4. Lemma. — *One has*

$$M_{AB \rightarrow AC} = \bar{u}_{AB \rightarrow AC}^- h_{AB \rightarrow AC}^-, \quad \bar{u}_{AB \rightarrow AC}^- \in U_*^-(\mathbf{i}), \quad h_{AB \rightarrow AC}^- \in H.$$

The canonical coordinates (9.17) of the element $\bar{u}_{AB \rightarrow AC}^-$ are given by the X -coordinates assigned as above to the grey triangles, provided the grey triangles are enumerated by the elements of the set \mathbf{i} as was explained above.

The element $h_{AB \rightarrow AC}^-$ is the product of the elements $H_{i_t}(X_{t'})$ assigned to the grey triangles t' .

Proof. Follows from the very definition and formulas (9.17), (9.14) and (9.18).

A projective basis in V_m is the same thing as a pinning for PGL_m .

9.5. Lemma. — *The six projective bases corresponding to the six oriented edges of the triangle ABC coincide with the six canonical pinning attached to the triple of flags (A, B, C) in V_m in Section 5.2.*

Proof. Lemma 9.4 implies that the projective basis assigned to the snake AB coincides with the one assigned to the side AB of the triangle whose vertices are labeled by the configuration of flags

$$(A, B, C) = (B^-, B^+, u_- B^+ u_-^{-1}).$$

The case of the snakes BC and CA is similar. To treat the case of the snake BA we use the last remark in Section 9.8. The lemma is proved.

10. Constructing a framed local system with arbitrary given non-zero coordinates. Let Γ be a trivalent graph on \widehat{S} , of the type of \widehat{S} . In Section 9.3 we defined the X -functions on the moduli space $\mathcal{X}_{PGL_m, \widehat{S}}$ corresponding to Γ . Recall that they are parametrized by the set J_m^Γ . Below we are going to show how to invert this construction. Precisely, let F be a field. Then given $X_i \in F^*$, $i \in J_m^\Gamma$ we will construct a framed PGL_m -local system on \widehat{S} with the given X -coordinates $\{X_i\}$.

Consider a decomposition of \widehat{S} into hexagons and rectangles obtained as follows. Replace the edges of Γ by rectangles and the vertices by hexagons, as on the left picture (Figure 9.15). Let Δ be the 1-skeleton of this decomposition.

Let G a split reductive algebraic group. Then, given a framed G -local system on \widehat{S} , every vertex v of Γ provides a configuration of three flags in the vicinity of v . Therefore there are six canonical pinning assigned to v . These pinning match the vertices of the hexagon of Δ corresponding to v .

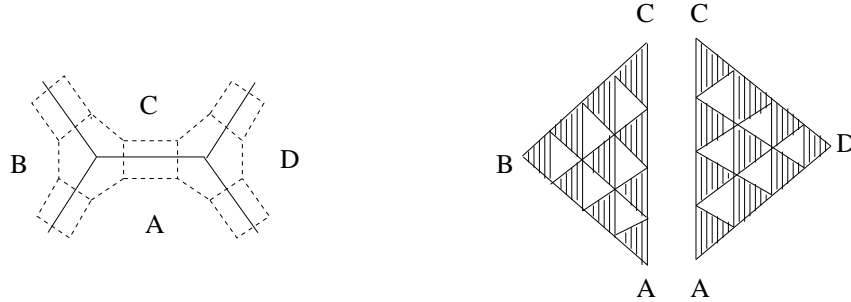

FIG. 9.15. — The graph Δ .

To construct a framed $G(F)$ -local system on \widehat{S} we assign to every oriented edge \mathbf{e} of Δ an element $M(\mathbf{e}) \in G(F)$. Let $\mathbf{p} := \mathbf{e}_1\mathbf{e}_2\mathbf{e}_3\dots$ be a path on Δ , where \mathbf{ef} means \mathbf{e} follows \mathbf{f} . Then \mathbf{p} gives rise to $M(\mathbf{p}) := M(\mathbf{e}_1)M(\mathbf{e}_2)M(\mathbf{e}_3)\dots$

9.6. Lemma. — *Suppose that elements $M(\mathbf{e}) \in G(F)$ satisfy the following conditions:*

- i) If \mathbf{e} does not intersect the graph Γ then $M(\mathbf{e}) \in B(F)$.*
- ii) Let $\bar{\mathbf{e}}$ be the edge \mathbf{e} equipped with the opposite orientation. Then $M(\mathbf{e})M(\bar{\mathbf{e}}) = \text{Id}$.*

iii) The element assigned to a path around a rectangle or hexagon is the identity.

Then the elements $M(\mathbf{p})$ depend only on the homotopy class of the path \mathbf{p} , providing a $G(F)$ -local system on S . Moreover it has a natural framing on \widehat{S} .

Proof. The properties ii) and iii) guaranty that we get a $G(F)$ -local system on S , and i) provides a natural framing. The lemma is proved.

Let us construct such elements $M(\mathbf{e})$. The graph Δ has three types of edges: the edges intersecting Γ , the edges of the rectangles which do not intersect Γ , and the edges of the hexagons which do not intersect Γ . We denote them, respectively, by \mathbf{a} , \mathbf{b} and \mathbf{c} . We will assume that the \mathbf{c} -edges of the hexagons are oriented counterclockwise, i.e. in the opposite way to the cyclic order of the edges and hence the flags in the vicinity of v . The following definition is suggested by Proposition 9.2 and Lemma 9.3.

a) Set $M(\mathbf{a}) := S$.

b) Let \mathbf{b} be an edge of a rectangle which goes along an oriented edge \mathbf{e} of Γ . Let $x_a = X_{a,m-2-a}^{\mathbf{e}}$ be the coordinates attached to the edge \mathbf{e} . Then $M(\mathbf{b})$ is given by the right hand side of (9.16).

c) Let $\{X_{a,b,c}\}$, where $a+b+c = m-3$ and $a, b, c \geq 0$, be the coordinates assigned to a vertex v of Γ . Then integers a, b, c match the edges of the hexagon surrounding v which do not intersect Γ . Let \mathbf{c} be such an edge assigned to a , counterclockwise oriented. Then $M(\mathbf{c})$ is given by the right hand side of (9.14).

9.2. Theorem. — *Let F be a field, and we are given $X_i \in F^*$, where $i \in J_m^{\Gamma}$. Then*

a) *The elements $M(\mathbf{a}), M(\mathbf{b}), M(\mathbf{c}) \in PGL_m(F)$ satisfy the conditions of Lemma 9.6.*

So they give rise to a framed local system on \widehat{S} .

b) *Let \mathcal{L} be a framed $PGL_m(F)$ -local system on \widehat{S} . Then the framed $PGL_m(F)$ -local system $\mathcal{L}(X)$ provided by the X -coordinates of \mathcal{L} is isomorphic to \mathcal{L} .*

Proof. Follows immediately from Proposition 9.2 and Lemma 9.3. The theorem is proved.

Let H_m (respectively \mathcal{V}_m) be the algebraic torus parametrising the internal edge (respectively vertex) X -coordinates. Then H_m is isomorphic to the Cartan group of PGL_m , and $\mathcal{V}_m = \mathbf{G}_m^{(m-2)(m-1)/2}$. The part a) of Theorem 9.2 provides a regular map

$$\psi_{\Gamma} : H_m^{\{\text{internal edges of } \Gamma\}} \times \mathcal{V}_m^{\{\text{vertices of } \Gamma\}} = \mathbf{G}_m^{J_m^{\Gamma}} \longrightarrow \mathcal{X}_{PGL_m, \widehat{S}}.$$

9.1. Corollary. — *The map ψ_Γ is a birational isomorphism, and is an injective regular map.*

Proof. The part b) of Theorem 9.2 plus a dimension count imply that all conditions of Lemma 6.2 are valid for the map ψ_Γ . So it is a birational isomorphism. Since ψ_Γ is regular, it is injective. The corollary is proved.

9.1. Definition. — *The atlas given by the collection of embeddings $\{\psi_\Gamma\}$, when Γ run through all isotopy classes of marked trivalent graphs on \widehat{S} of type \widehat{S} , is called **special atlas** on $\mathcal{X}_{PGL_m, \widehat{S}}$.*

By Lemma 9.4 the special atlas is a subatlas of the atlas defined in Section 6. This implies that the special atlas is a positive atlas. An elementary proof of this claim is contained in Section 10. This positivity claim plus Theorem 9.2 gives a complete proof of Theorem 9.1.

In the next subsection we investigate the monodromy properties of the universal PGL_m -local system on S with respect to the special positive atlas on $\mathcal{X}_{PGL_m, \widehat{S}}$.

11. Positive Laurent property of the monodromy of universal PGL_m -local system. A *special good positive Laurent polynomial* on $\mathcal{X}_{PGL_m, S}$ is a rational function which in every coordinate system $\{T_i\}$ from the special positive atlas on $\mathcal{X}_{PGL_m, S}$ is a Laurent polynomial with positive integral coefficients. We say that a matrix with entries in the field $\mathbf{F}_{PGL_m, S}$ is a *special good totally positive (integral) Laurent matrix* if in every special positive coordinate system, every minor of this matrix is a good positive integral Laurent polynomial. There is a similar definition for the upper/lower triangular matrices.

9.3. Theorem. — *The monodromy of the universal PGL_m -local system \mathcal{L}_m around a non-boundary loop on S is conjugated to a special good totally positive Laurent matrix. The monodromy around a boundary loop is conjugated to an upper/lower triangular special good totally positive Laurent matrix.*

Proof. It is similar to the proof of Theorem 1.8. Starting from the connection on the graph Δ given by the elements $M(\mathbf{a}), M(\mathbf{b}), M(\mathbf{c})$ we define a connection on the corresponding graph Γ'_T , shown on Figure 6.8, as follows. Observe that the oriented \mathbf{t} -edges of Γ'_T match the oriented \mathbf{c} -edges of Δ . Further, the \mathbf{b} -edges of Δ have canonical orientations: the ones compatible with the clockwise orientation of the holes. So oriented \mathbf{e} -edges of Γ'_T match the \mathbf{b} -edges of Δ . So, having in mind $M_{AB \rightarrow CA} = M_{AC \rightarrow CA} M_{AB \rightarrow AC}$, we set

$$M(\mathbf{t}) := SM(\mathbf{c}) = M(\mathbf{a})M(\mathbf{c}); \quad M(\mathbf{e}) := M(\mathbf{b})S = M(\mathbf{b})M(\mathbf{a})$$

assuming that the \mathbf{t} and \mathbf{e} -edges of Γ'_T match the corresponding edges of Δ . Then $M(\mathbf{e})M(\mathbf{t})$ is a lower triangular special totally positive integral Laurent matrix. Indeed, it is obtained by a product of the matrices F_j , $H_i(x)$ and $M(\mathbf{b})$. Similarly, if \mathbf{e} follows $\bar{\mathbf{t}}$, then $M(\mathbf{e})M(\bar{\mathbf{t}}) = M(\mathbf{e})M(\mathbf{t})^{-1} = M(\mathbf{b})SM(\mathbf{c})S^{-1}$ is an upper triangular special totally positive integral Laurent matrix: see Remark after Proposition 9.2. The rest is as in the proof of Theorem 1.8. The theorem is proved.

Let $\rho : PGL_m \rightarrow \text{Aut}(V)$ be a finite dimensional representation. Consider the associated local system $\mathcal{L}_\rho := \mathcal{L}_m \times_{PGL_m} V$ on $S \times \mathcal{X}_{PGL_m}$.

9.2. Corollary. — *a) Let M_α be the monodromy of the universal local system around a loop α . Then, for any integer $n > 0$, $\text{tr}(M_\alpha^n)$ is a special good positive Laurent polynomial on $\mathcal{X}_{PGL_m, S}$.*

b) For any finite dimensional representation ρ of PGL_m the monodromy of the universal local system \mathcal{L}_ρ around any loop on S is conjugated to a matrix whose entries are special good positive rational Laurent polynomials on $\mathcal{X}_{PGL_m, \hat{S}}$.

c) The trace of the monodromy of \mathcal{L}_ρ around any loop is a special good positive rational Laurent polynomial on $\mathcal{X}_{PGL_m, \hat{S}}$.

Proof. a) Follows immediately from Theorem 9.3.

b) Take the canonical basis in V . Then the elements E_i and F_i of PGL_m act by matrices with non-negative rational coefficients, and the elements $H_i(X)$ act by diagonal matrices whose coefficients are monomials in $X^{\pm 1}$. c) follows from b). The corollary is proved.

9.1. Conjecture. — $\text{tr}(M_\alpha^n)$ can not be presented as a sum of two non-zero elements of $\mathbf{L}_+(\mathcal{X}_{PGL_m, S})$:

$$\text{tr}(M_\alpha^n) \in \mathbf{E}(\mathcal{X}_{PGL_m, S}).$$

12. Convex curves in \mathbf{RP}^n and positive curves in the flag variety for $PGL_{n+1}(\mathbf{R})$. A curve K in \mathbf{RP}^n is *convex* if any hyperplane contains no more than n points of K . This definition goes back to Schoenberg [Sch]. It is interesting that every convex algebraic curve is projectively equivalent to the Veronese curve given by $(x_0 : x_1) \mapsto (x_0^n : x_0^{n-1}x_1 : \dots : x_1^n)$.

We start from a useful inductive criteria of positivity of configurations of flags in \mathbf{RP}^n .

9.7. Lemma. — *A configurations of m flags in \mathbf{RP}^2 is positive if and only if the lines of the flags bound a convex m -gon, and the points of the*

flags are at the boundary of this m -gon, but not at the vertices, see Figure 1.4.

Proof. For $m = 3$ this is Lemma 9.1. The general case is deduced from it, see Section 2 of [FG3].

Denote by $\mathcal{B}_{n+1}(\mathbf{R})$ the flag variety for $PGL_{n+1}(\mathbf{R})$. There are two natural projections

$$\pi : \mathcal{B}_{n+1}(\mathbf{R}) \longrightarrow \mathbf{RP}^n, \quad \widehat{\pi} : \mathcal{B}_{n+1}(\mathbf{R}) \longrightarrow \widehat{\mathbf{RP}}^n.$$

Let (F_1, \dots, F_m) be a generic configuration of flags in \mathbf{RP}^n . Set $x_k := \pi(F_k)$. We define a configuration of flags $(x_k|F_1, \dots, F_m)$ in \mathbf{RP}^{n-1} by projection with the center at the point x_k . Namely, let F be a flag in \mathbf{RP}^n whose $(n-1)$ -dimensional subspace does not contain x_k . Then F provides a flag in the projective space of all lines passing through x_k : its p -dimensional subspace consists of the lines through x_k passing through the similar subspace of F . This way the flags F_i , $i \neq k$, give rise to the flags \overline{F}_i . Finally, the p -dimensional subspace of the the flag F_k provides the $(p-1)$ -dimensional subspace of the flag \overline{F}_k . Now we set $(x_k|F_1, \dots, F_m) := (\overline{F}_1, \dots, \overline{F}_m)$.

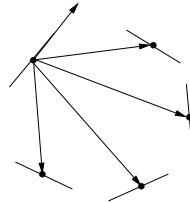

FIG. 9.16. — Projecting a configuration of five flags.

9.8. Lemma. — *Let $n \geq 3$. A configuration of flags (F_1, \dots, F_m) in \mathbf{RP}^n is positive if and only if all configurations $(x_1|F_1, \dots, F_m), \dots, (x_m|F_1, \dots, F_m)$ are positive.*

Proof. Let us prove the implication \leq . Take a convex m -gon P_m with vertices labeled by the flags F_1, \dots, F_m . Observe that, assuming $n \geq 3$, given a triangulation of the polygon P_m , the corresponding canonical coordinates of the configuration (F_1, \dots, F_m) are defined as follows: we take a triple or quadruple of flags assigned to a triangle or quadrilateral of the triangulation, project them to the flags in \mathbf{RP}^2 , and then take the canonical coordinates of the obtained configuration. It follows from this that positivity of the configurations $(x_1|F_1, \dots, F_m), \dots, (x_m|F_1, \dots, F_m)$ implies positivity of all the coordinates of the original configuration (F_1, \dots, F_m) with respect to the given triangulation.

Let us prove that if the configuration (F_1, \dots, F_m) is positive, then the one $(x_m | F_1, \dots, F_m)$ is also positive. Since the property of positivity of configurations of flags is cyclically invariant, this would imply the implication \Rightarrow . Consider the triangulation of the polygon P_m by the diagonals from the vertex F_m . Consider the triple (F_k, F_{k+1}, F_m) assigned to the vertices of one of the triangles. Then, assuming $n \geq 3$, the set of the coordinates corresponding to the triple $(x_m | F_k, F_{k+1}, F_m)$ is a subset of the set of coordinates of the triple (F_k, F_{k+1}, F_m) . A similar statement is true for the coordinates assigned to a diagonal (F_k, F_m) of the polygon. The claim follows immediately from this. The lemma is proved.

Remark. The implication \Leftarrow of Lemma 9.8 is false for $n = 2$.

Let K be an oriented continuous convex curve in \mathbf{RP}^n . Let x_1, x_2 be two points of K . We say that $x_1 < x_2$ if x_2 follows x_1 according to the orientation of the curve K . Given a collection of points $X = x_1 < x_2 < \dots < x_n$ on K , we associate to it a flag

$$F_X := (x_1, [x_1x_2], \dots, [x_1\dots x_n])$$

where $[x_1\dots x_k]$ denotes the subspace spanned by the points x_1, \dots, x_k . Convexity of K implies that $\dim[x_1\dots x_k] = k - 1$, so F_X is indeed a flag. More generally, given n -tuples of points

$$X(1) := \{x_1(1) < \dots < x_n(1)\}, \quad \dots, \quad X(m) := \{x_1(m) < \dots < x_n(m)\} \quad (9.19)$$

we get the flags $F_{X(1)}, \dots, F_{X(m)}$. We say that $X(a) < X(b)$ if $x_i(a) < x_j(b)$ for all $1 \leq i, j \leq n$.

9.3. Proposition. — *Let K be an oriented continuous convex curve in \mathbf{RP}^n . Assume that $X(1) < X(2) < \dots < X(m)$ in (9.19). Then the configuration of flags $(F_{X(1)}, \dots, F_{X(m)})$ is positive.*

Proof. Lemma 9.7 implies Proposition 9.3 for $n = 2$. So we may assume that $n > 2$. The projection of a convex curve from a point on this curve is a convex curve. So Lemma 9.8 implies Proposition 9.3 by descending induction on n . The proposition is proved.

The osculating curves. Let K be an oriented continuous convex curve in \mathbf{RP}^n . Choose a point $x \in K$, and consider an n -tuple of points $x < x_2 < \dots < x_n$ on K . It provides a flag. We claim that when the points x_i approach the point x keeping their order, the corresponding family of flags has a limit. We prove this claim below. The limit is denoted $F_r(x)$ and called the *right osculating flag* at x . The map $x \mapsto F_r(x)$ provides a map $\beta_r : K \rightarrow \mathcal{B}_{n+1}(\mathbf{R})$,

which, as one easily sees using the proof of Proposition 9.3, is positive. The curve $\tilde{K}_r := \beta_r(K)$ is called the *right osculating curve* to K . Similarly starting from the points $x > x_2 > \dots > x_n$ we define the *left osculating curve* \tilde{K}_l to K .

To prove the claim, consider a sequence of $(n - 1)$ -tuples of points $X(k) := x_2(k) < \dots < x_n(k)$, $k = 1, 2, \dots$, such that $x < x_i(k)$ and $x_i(k)$ converges to x as $k \rightarrow \infty$. Let us assume that $X(a) < X(b)$. Projecting K from x we get a convex curve in \mathbf{RP}^{n-1} , and a sequence of flags $F_{X(a)}$ on it. This sequence is positive by Proposition 9.3. Thus by Theorem 7.4 it has a limit $\overline{F}_r(x)$. The limit evidently does not depend on the choice of sequence $X(k)$. Then $F_r(x)$ is the unique flag containing x and projecting to the flag $\overline{F}_r(x)$.

9.4. Theorem. — a) Let C be a positive curve in the flag variety $\mathcal{B}_{n+1}(\mathbf{R})$. Then $\pi(C)$ and $\widehat{\pi}(C)$ are convex curves in \mathbf{RP}^n and $\widehat{\mathbf{RP}}^n$.

b) Let K be a continuous convex curve in \mathbf{RP}^n . Then the osculating curves \tilde{K}_l and \tilde{K}_r are positive curves in $\mathcal{B}_{n+1}(\mathbf{R})$. So if K is a C^{n-1} -smooth, then $\tilde{K}_l = \tilde{K}_r = \tilde{K}$ is a positive curve in $\mathcal{B}_{n+1}(\mathbf{R})$.

c) The rule $K \mapsto \tilde{K}$ gives rise to a bijective correspondence

$$C^n\text{-smooth convex curves in } \mathbf{RP}^n \leftrightarrow C^1\text{-smooth positive curves in } \mathcal{B}_{n+1}(\mathbf{R}). \tag{9.20}$$

Proof. a) It follows immediately from the following crucial proposition:

9.4. Proposition. — Let (F_1, \dots, F_{n+1}) be a positive configuration of flags in \mathbf{RP}^n . Let (x_1, \dots, x_{n+1}) be the corresponding configuration of points in \mathbf{RP}^n , i.e. $\pi(F_i) = x_i$. Then these points are not contained in a hyperplane.

Proof. Observe that a the flags of a positive configuration of flags are in generic position. Lemma 9.8 implies that $(x_{n+1}|F_1, \dots, F_n)$ is a positive configuration of flags. Further, the claim of Proposition 9.4 for the configuration of flags $(x_{n+1}|F_1, \dots, F_n)$ in \mathbf{RP}^{n-1} evidently implies the one for the initial flags F_1, \dots, F_{n+1} . So arguing by the induction on $n \geq 2$ we reduce the Proposition to the case $n = 2$. Let us prove the Proposition when $n = 2$.

Let V_3 be a three dimensional vector space. Choose a volume form ω in V_3 . For any two vectors a, b we define a cross-product $a \times b \in V_3^*$ by $\langle a \times b, c \rangle := \Delta(a, b, c)$. The volume form ω defines the dual volume form in V_3^* , so we can define $\Delta(x, y, z)$ for any three vectors in V_3^* . The following fact is Lemma 5.1 from [G4].

9.9. Lemma. — *For any 6 vectors in generic position $a_1, a_2, a_3, b_1, b_2, b_3$ in V_3 one has*

$$\begin{aligned} & \Delta(a_1, a_2, b_2) \cdot \Delta(a_2, a_3, b_3) \cdot \Delta(a_3, a_1, b_1) - \Delta(a_1, a_2, b_1) \cdot \Delta(a_2, a_3, b_2) \cdot \Delta(a_3, a_1, b_3) = \\ & \Delta(a_1, a_2, a_3) \cdot \Delta(a_1 \times b_1, a_2 \times b_2, a_3 \times b_3). \end{aligned}$$

Proof. Any configuration of six generic vectors in V_3 is equivalent to the following one:

$$\begin{array}{cccccc} a_1 & a_2 & a_3 & b_1 & b_2 & b_3 \\ - & - & - & - & - & - \\ 1 & 0 & 0 & x_1 & y_1 & z_1 \\ 0 & 1 & 0 & x_2 & y_2 & z_2 \\ 0 & 0 & 1 & x_3 & y_3 & z_3 \end{array}$$

Then both the left and the right hand sides are equal to $y_3 z_1 x_2 - x_3 y_1 z_2$. The lemma is proved.

Let (A, B, C) be a positive configuration of three flags in \mathbf{RP}^2 . The flags A, B, C can be defined by pairs of vectors $(a_1, a_2), (b_1, b_2), (c_1, c_2)$ in V_3 , so that the flag A is determined by the affine flag $(a_1, a_1 \wedge a_2)$, and so on. Recall the triple ratio (9.8). Using Lemma 9.9 we have

$$1 + r_3^+(A, B, C) = 1 + \frac{\Delta(a_1, a_2, b_1) \Delta(b_1, b_2, c_1) \Delta(c_1, c_2, a_1)}{\Delta(a_1, a_2, c_1) \Delta(b_1, b_2, a_1) \Delta(c_1, c_2, b_1)} =$$

$$\frac{\Delta(a_1, b_1, c_1) \Delta(a_1 \times a_2, b_1 \times b_2, c_1 \times c_2)}{\Delta(a_1, a_2, c_1) \Delta(b_1, b_2, a_1) \Delta(c_1, c_2, b_1)}.$$

Therefore $\Delta(a_1, b_1, c_1) \neq 0$ if $r_3^+(A, B, C) > 0$. Proposition 9.4, and hence the part a) of Theorem 9.4 are proved.

b) Observe that projection with the center at a point $x \in K$ maps the osculating flags on K to the ones on the projected curve. So the part b) follows immediately from Lemma 9.8.

c) By Proposition 7.2 a differentiable positive curve C in $\mathcal{B}_{n+1}(\mathbf{R})$ is tangent to the canonical distribution, and hence is the osculating curve for the n times differentiable curve $\pi(C)$ in \mathbf{RP}^n . This curve is convex by the part a). The converse statement is the part b) of the theorem. The theorem is proved.

10. The pair $(\mathcal{X}_{PGL_m, \hat{S}}, \mathcal{A}_{SL_m, \hat{S}})$ corresponds to an orbi-cluster ensemble

In this Section we formulate precisely and prove Theorems 1.17 and 1.18.

1. Cluster ensembles. We briefly recall some details of the cluster ensembles as defined in [FG2]. A cluster ensemble is determined by essentially the same combinatorial data, called a *seed*, as the cluster algebras [FZI]. A seed $\mathbf{i} = (I, J, \varepsilon_{ij}, d_i)$ consists of a finite set I , an integral valued function (ε_{ij}) on $I \times I$, called a *cluster function*, a $\mathbf{Q}_{>0}$ -valued *symmetrizer function* d_i on I , such that $\tilde{\varepsilon}_{ij} := d_i \varepsilon_{ij}$ is skew-symmetric, and a subset $J \subset I$. The complement $I - J$ is called the *frozen subset* of I . If ε_{ij} is skew symmetric, like in the case considered below, we set $d_i = 1$.

Mutations. Given a seed $\mathbf{i} = (I, J, \varepsilon, d)$, every non-frozen element $k \in J$ provides a mutated in the direction k seed $\mu_k(\mathbf{i}) = \mathbf{i}' = (I', J', \varepsilon', d')$ as follows: one has $I' := I, J' := J, d' := d$ and

$$\varepsilon'_{ij} = \begin{cases} -\varepsilon_{ij} & \text{if } k \in \{i, j\} \\ \varepsilon_{ij} + \frac{|\varepsilon_{ik}| |\varepsilon_{kj} + \varepsilon_{ik}| |\varepsilon_{kj}|}{2} & \text{if } k \notin \{i, j\} \end{cases} \quad (10.1)$$

This procedure is involutive: the mutation of ε'_{ij} in the direction k is the original function ε_{ij} .

Let us mutate a given seed in all possible directions, and repeat this infinitely many times. Let Tr_I be a tree defined as follows. Its vertices parameterize all seeds obtained from the original one by mutations. Two vertices are connected by an edge if the corresponding seeds are related by a mutation. This edge inherits a decoration k if the corresponding mutation is in the direction k .

A seed \mathbf{i} gives rise to two split algebraic tori:

$$\mathcal{X}_{\mathbf{i}} := (\mathbf{G}_m)^J, \quad \mathcal{A}_{\mathbf{i}} := (\mathbf{G}_m)^I$$

Let $\{X_j\}$ be the natural coordinates on the first torus, and $\{A_i\}$ on the second. The torus $\mathcal{X}_{\mathbf{i}}$ is called the *seed \mathcal{X} -torus*, and the torus $\mathcal{A}_{\mathbf{i}}$ is called the *seed \mathcal{A} -torus*. The \mathcal{A} -coordinates parametrized by the complement $I - J$ are called the frozen \mathcal{A} -coordinates. This definition differs slightly from the one in [FG2], where $\mathcal{X}_{\mathbf{i}} := (\mathbf{G}_m)^I$, since in this paper we do not need the frozen \mathcal{X} -coordinates.

Mutations induce positive rational maps between the corresponding seed \mathcal{X} - and \mathcal{A} -tori, which are denoted by the same symbols μ_k and defined by

the formulas

$$\mu_k^* X_i = \begin{cases} X_k^{-1} & \text{if } i = k \\ X_i(1 + X_k)^{-\varepsilon_{ik}} & \text{if } \varepsilon_{ik} \leq 0 \text{ and } i \neq k \\ X_i(1 + X_k^{-1})^{-\varepsilon_{ik}} & \text{if } \varepsilon_{ik} \geq 0 \text{ and } i \neq k \end{cases} \quad (10.2)$$

$$\mu_k^* A_k = A_k, \quad \mu_k^* A_i = \prod_{j|\varepsilon_{kj}>0} A_j^{\varepsilon_{kj}} + \prod_{j|\varepsilon_{kj}<0} A_j^{-\varepsilon_{kj}}; \quad i \neq k \quad (10.3)$$

2. A seed for the cluster ensemble describing the pair

$(\mathcal{A}_{SL_m, \widehat{S}}, \mathcal{X}_{PGL_m, \widehat{S}})$. Choose a marked trivalent graph Γ on S , of type \widehat{S} , and take the corresponding m -triangulation $T_m = T_m(\Gamma)$ of S . Then T_m is an oriented graph. It determines a seed \mathbf{i} as follows. Recall that an oriented graph T determines a skew-symmetric function $\varepsilon_{pq}(T)$ on the set of pairs of its vertices, see (1.28).

- i) Let $I := I_m^\Gamma$ be the set of vertices of the graph $T_m(\Gamma)$ minus the punctures of S , and let $J := J_m^\Gamma$.
- ii) The cluster function is given by $\varepsilon_{pq} = \varepsilon_{pq}(T_m)$.
- iii) The coordinates Δ_i^Γ are the cluster ensemble coordinates $A_i^{\mathbf{i}}$.
- iv) The coordinates X_j^Γ are the cluster ensemble coordinates $X_j^{\mathbf{i}}$.
- v) Formula (9.6) shows that the function X_j^Γ and Δ_i^Γ are related under the projection p the same way as the cluster ensemble coordinates $X_j^{\mathbf{i}}$ and $A_i^{\mathbf{i}}$, see [FG2].

An interpretation of a flip in the cluster language is a non trivial problem: we are going to prove that a flip can be presented as a composition of mutations.

Describing a flip and its action on the cluster function. Let Γ' be a graph obtained from Γ by a flip at an edge E . Denote by F the new edge of Γ' . Let $\{A, B, C, D\}$ (resp. $\{A', B', C', D'\}$) be the set of edges of Γ (resp. Γ') adjacent to E (resp. F). Then there is a canonical bijection $\{A, B, C, D\} \longrightarrow \{A', B', C', D'\}$ such that $X \longmapsto X'$. Let us number by 1, 2, 3, 4 the pieces of faces in the vicinity of the edge E . They match the ones in the vicinity of F . We assume that their order is compatible with the cyclic order provided by the ribbon structure of Γ , see Figure (10.1). Denote by T'_m the m -triangulation corresponding to Γ' .

The claim that a flip can be obtained as a composition of mutations means the following:

- i) The composition of mutations transforms the function $\varepsilon_{pq}(T_m)$ to $\varepsilon_{pq}(T'_m)$

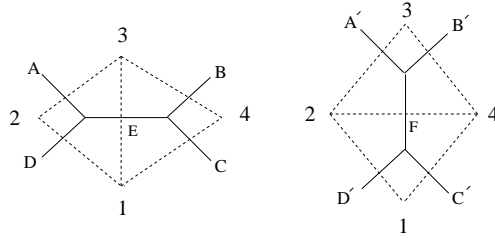

FIG. 10.1. — Describing a flip.

ii) The transformation rules for the \mathcal{A} - and \mathcal{X} -coordinates under a flip coincide with the ones provided by the sequence of mutations.

3. A sequence of mutations representing a flip at an edge E . We present it as a composition of $m - 1$ steps. Consider the diamond with the vertices 1, 2, 3, 4 on Figure 10.1. One can inscribe into the m -triangulation of this diamond rectangles of the size $i \times (m - i)$, where $i = 1, \dots, m - 1$, centered at the center of the diamond. Here i (resp. $(m - i)$) is the length in direction of the edge F (resp. E). We subdivide this rectangle into $i(m - i)$ equal squares.

Step i . Do mutations in the direction of the elements of the set $I = I_m^I$ corresponding to the centers of little squares of the $i \times (m - i)$ rectangle.

For example at the step 1 (resp. $m - 1$) we do mutations corresponding to the $m - 1$ vertices located inside of the vertical (resp. horizontal) diagonal of the diamond.

10.1. Proposition. — *The described sequence of mutations transforms the cluster function $\varepsilon_{pq}(T_m)$ to the one $\varepsilon_{pq}(T'_m)$.*

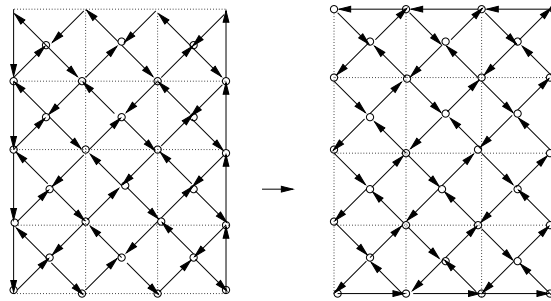

FIG. 10.2. —

Proof. Consider an $m \times n$ rectangle where $m, n \geq 1$ are integers. Subdivide it into mn equal squares, mark the vertices and centers of the squares.

Connect the marked points by arrows as on Figure 10.2. Denote by $R_{m,n}$ the obtained oriented graph. Observe that the right picture on Figure 10.2 is obtained from the left one by inverting directions of the arrows at each square center, and replacing the arrows at the sides of the rectangle by the ones at the top and the bottom, keeping the counterclockwise orientation.

10.1. Lemma. — *Consider the cluster function ε_{pq} corresponding to the oriented graph on the left of Figure 10.2. Let us perform a sequence of mutations at all centers of the mn squares, in any order. Then the obtained cluster function ε'_{pq} is described by the picture on the right of Figure 10.2.*

Proof. Follows immediately from the definitions.

Example. The two pictures on Figure 10.3 illustrate the case $m = 6$. We show a part of the mutated graph after the steps 1 and 2. On each picture we show the distinguished rectangles corresponding to this and previous steps.

Contemplation will convince the reader that after $m - 1$ steps we get the graph of the function $\varepsilon_{pq}(T'_m)$. The proposition is proved.

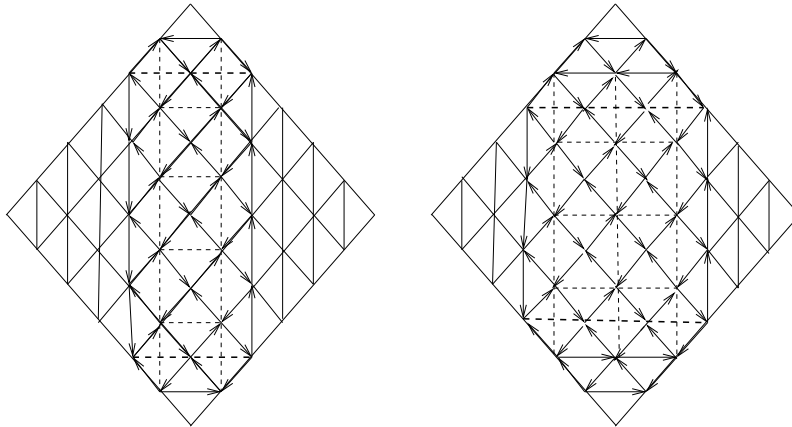

FIG. 10.3. —

4. Hypersimplices and a decomposition of a simplex. Recall [GGL] that a hypersimplex $\Delta^{k,l}$, where $k + l = n - 1$, is a section of the $n + 1$ -dimensional cube $0 \leq x_i \leq 1$ by the hyperplane $\sum x_i = l + 1$. The hypersimplex $\Delta^{k,l}$ can be obtained as the convex hull of the centers of k -dimensional faces of an $(k + l + 1)$ -dimensional simplex.

Example. $\Delta^{1,1}$ is an octahedron. It is the convex hull of the centers of the edges of a tetrahedron.

Let m be a positive integer. Consider the simplex

$$\Delta_{(m)}^n := \{(x_0, \dots, x_n) \in \mathbf{R}^n \mid \sum_{i=0}^n x_i = m, \quad x_i \geq 0\} \quad (10.4)$$

10.2. Lemma. — *The hyperplanes $x_i = k$ where k is an integer cut the simplex (10.4) into a union of hypersimplices.*

Proof. Consider a decomposition of \mathbf{R}^n into the unit cubes with the faces $x_i = k$ where k is an integer. The hyperplane $\sum x_i = m$ intersect each of these cubes either by an empty set, or by a hypersimplex. The lemma is proved.

We call it the hypersimplicial decomposition of the simplex $\Delta_{(m)}^n$.

Example. When $n = 2$ we get an m -triangulation of a triangle defined in Section 1.13.

Consider the three dimensional simplex $\Delta_{(m)}^3(E)$ given by

$$x_1 + x_2 + x_3 + x_4 = m, \quad x_i \geq 0, \quad (10.5)$$

whose vertices are labeled by 1, 2, 3, 4, as on Figure 10.4. Its edges are dual to the A, B, C, D, E, F edges, see Figure 10.1, and get the same labels. The faces match the vertices of the edges E and F . The two faces matching the vertices of E are called the e -faces, and the other two are called the f -faces.

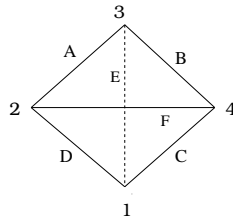

FIG. 10.4. —

The hypersimplicial decomposition of $\Delta_{(m)}^3(E)$ induces the m -triangulation of its faces. The faces of $\Delta_{(m)}^3(E)$ are identified with the corresponding triangles of T or T' , so that the m -triangulations of the faces match the ones of the triangles. Thus to make a flip we glue the simplex $\Delta_{(m)}^3(E)$ so that

its e -faces match the corresponding two triangles of T . Then the f -faces of $\Delta_{(m)}^3(E)$ provide the two triangles of T' .

5. The action of a flip on the A -coordinates. Let us attach to the integral points inside of the simplex (10.5) functions on the configurations space of four affine flags in an m -dimensional vector space V_m with a volume form ω . Given an integral solution (a, b, c, d) of (10.5) and a 4-tuple of affine flags (X, Y, Z, T) we set

$$\Delta_{a,b,c,d}(X, Y, Z, T) := \Delta_\omega(x_{(a)} \wedge y_{(b)} \wedge z_{(c)} \wedge t_{(d)})$$

where $x_{(a)} = x_1 \wedge \dots \wedge x_a$ and so on. If one of the numbers a, b, c, d is zero we get the functions defined in Section 9.2. The Plücker relations allow to derive some identities between these functions which we are going to describe now.

The hypersimplicial decomposition of the three dimensional simplex (10.5) is a decomposition into tetrahedrons of type $\Delta^{2,0}$, octahedrons $\Delta^{1,1}$, and tetrahedrons of type $\Delta^{0,2}$. The octahedrons play an important role in our story. They are parametrized by the solutions (a_1, a_2, a_3, a_4) of the equation

$$a_1 + a_2 + a_3 + a_4 = m - 2, \quad a_i \in \mathbf{Z}, a_i \geq 0. \quad (10.6)$$

The collection of vertices of these octahedrons coincides with the set of the non negative integral solutions of the equation (10.5). The vertices of the (a_1, a_2, a_3, a_4) -octahedron have the coordinates

$$(a_1, a_2, a_3, a_4) + (\varepsilon_1, \varepsilon_2, \varepsilon_3, \varepsilon_4), \quad \varepsilon_i \in \{0, 1\}, \quad \sum_{i=1}^4 \varepsilon_i = 2. \quad (10.7)$$

We will use a shorthand $\Delta_{b_1, b_2, b_3, b_4} := \Delta_{b_1, b_2, b_3, b_4}(X, Y, Z, T)$.

10.3. Lemma. — *For any solution $\bar{a} = (a_1, a_2, a_3, a_4)$ of (10.6) one has*

$$\Delta_{\bar{a}+(1,1,0,0)} \Delta_{\bar{a}+(0,0,1,1)} + \Delta_{\bar{a}+(1,0,0,1)} \Delta_{\bar{a}+(0,1,1,0)} = \Delta_{\bar{a}+(1,0,1,0)} \Delta_{\bar{a}+(0,1,0,1)}. \quad (10.8)$$

Proof. Let $X = (x_1, x_1 \wedge x_2, x_1 \wedge x_2 \wedge x_3, \dots)$ be an affine flag in V_m . Let $X_1 \subset X_2 \subset \dots \subset X_m = V_m$ be the corresponding flag. The affine flag X induces an affine flag in each of the quotients V_m/X_i . The four affine flags (X, Y, Z, T) in generic position in V_m induce four affine flags in the quotient

$$\frac{V_m}{X_{a_1} \oplus Y_{a_2} \oplus Z_{a_3} \oplus T_{a_4}}. \quad (10.9)$$

Since $a_1 + a_2 + a_3 + a_4 = m - 2$, this quotient is two dimensional, and the induced affine flags provide a configuration of vectors $(\bar{x}_{a_1+1}, \dots, \bar{t}_{a_4+1})$. We define a volume form ω' in the space (10.9) by

$$\omega'(v_1 \wedge v_2) := \Delta(x_{(a_1)} \wedge y_{(a_2)} \wedge z_{(a_3)} \wedge t_{(a_4)} \wedge v_1 \wedge v_2). \tag{10.10}$$

Set $(v_1, v_2, v_3, v_4) := (\bar{x}_{a_1+1}, \dots, \bar{t}_{a_4+1})$ in the two dimensional space (10.9). One easily checks that multiplying (10.8) by $(-1)^{a_2+a_4}$ we get the Plücker relation

$$\omega'(v_1 \wedge v_2)\omega'(v_3 \wedge v_4) + \omega'(v_1 \wedge v_4)\omega'(v_2 \wedge v_3) = \omega'(v_1 \wedge v_3)\omega'(v_2 \wedge v_4).$$

The lemma is proved.

One can interpret it as follows. The six vectors $(\varepsilon_1, \varepsilon_2, \varepsilon_3, \varepsilon_4)$ from (10.7) match the edges of the graphs Γ and Γ' as shown on Figure 10.5. For

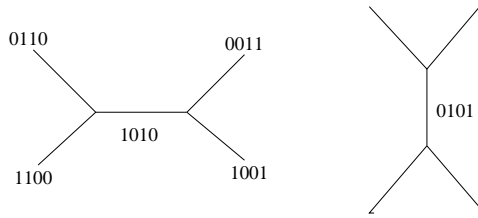

FIG. 10.5. —

instance (1100) matches the edge D on the Figure (10.1) and so on. Set $\Delta_{\bar{a},A} := \Delta_{\bar{a}+(1,1,0,0)}$ and so on. Then we have

$$\Delta_{\bar{a},A}\Delta_{\bar{a},C} + \Delta_{\bar{a},B}\Delta_{\bar{a},D} = \Delta_{\bar{a},E}\Delta_{\bar{a},F}. \tag{10.11}$$

The sequence of mutations defined in Section 10.2 can be described geometrically as follows. The octahedrons of the hypersimplicial decomposition of $\Delta_{(m)}^3(E)$ form $m - 1$ horizontal layers, if we assume that the edges E and F parallel to a horizontal plane, and on the i -th step we add the octahedrons on the i -th level.

Recall that a mutation in the direction k changes just one A -coordinate, the one parametrised by k , via the exchange relation given by (10.3). In our situation the mutation corresponding to an octahedron replaces $\Delta_{\bar{a},E}$ by $\Delta_{\bar{a},F}$, so the exchange relation is given by (10.11). Presenting a flip as a composition of mutations, we describe how the \mathcal{A} -coordinates change under a flip.

6. The action of a flip on the X -coordinates. Recall the canonical projection $p : \mathcal{A}_{SL_n, \hat{S}} \longrightarrow \mathcal{X}_{PGL_n, \hat{S}}$. Observe that in the special case when

\widehat{S} is a disc with n marked points the canonical projection $p : \text{Conf}_n(\mathcal{A}) \rightarrow \text{Conf}_n(\mathcal{B})$ is a map onto. Thus to prove any identity between the functions X_i^F on $\text{Conf}_n(\mathcal{B})$ it is sufficient to prove them for the pull backs $p^*X_i^F$. We already proved that the A -coordinates and the cluster functions transform the same way by a flip. We have the cluster type formula (9.6) for $p^*X_i^F$. So the X -coordinates also transform by a flip the same way as by the corresponding composition of mutations.

The functions corresponding to the octahedrons of hypersimplicial decomposition. The cross-ratio of the vectors $\bar{x}_{a_1+1}, \dots, \bar{t}_{a_4+1}$ provides a function on configurations of 4-tuples of flags in V_m :

$$R_{a_1, a_2, a_3, a_4}(X, Y, Z, T) := r^+(\bar{x}_{a_1+1}, \bar{y}_{a_2+1}, \bar{z}_{a_3+1}, \bar{t}_{a_4+1}). \quad (10.12)$$

These functions correspond to the octahedrons of the hypersimplicial decomposition of the simplex $\Delta_{(m)}^3(E)$. They are determined by the part of the graph Γ in the vicinity of E . A flip $\Gamma \rightarrow \Gamma'$ at the edge E changes these functions to their inverses.

Proof of Theorem 1.17. Since the Farey triangulation is not special in the sense of Section 3.8, the results obtained above imply the proof of Theorem 1.17a). To get Theorem 1.17b) we use in addition Lemma 1.3.

To formulate precisely and prove Theorem 1.18 it remains to consider the special triangulations. We do it below.

7. Treatment of the special graphs. Recall the special trivalent ribbon graphs defined in Section 3.8. By definition, they contain a part given by either an eye or a virus. There are well defined \mathcal{X} - and \mathcal{A} -coordinates assigned to edges and triangles of an eye. For the \mathcal{X} -coordinates assigned to an edge E of an eye this deserves a comment. Namely, let Q_E be the rectangle having E as an edge, see the middle graph on Figure 3.3. The two vertices opposing the edge E are glued. However the four flags assigned to the vertices of Q_E are generic: the flags assigned to the two glued vertices differ by a monodromy transformation. Thus the corresponding \mathcal{X} -coordinates on the edge E are well defined. Contrary to this, to define the \mathcal{X} -coordinates corresponding to the loop of a virus we have to go to a $2 : 1$ covering of S pictured on Figure 3.5 and described below. So it is no surprise that we face problems comparing the effects at this loop of cluster and geometric transformations, and that these problems are resolved by going to a cover.

Let us consider first the case $G = PGL_2$. Figure 10.6 shows how we obtain a virus by making a flip on an eye at the edge E , and tells us how the coordinates on the moduli space $\mathcal{X}_{PGL_2, \widehat{S}}$ are transformed by this flip.

Figure 10.7 tells us the effect of the cluster transformation, mutation, for the cluster ensemble corresponding to the same moduli space, under the same flip. Observe that the only difference is for the \mathcal{X} -coordinate A assigned to the edge obtained by gluing the two edges shown by arrows on the Figure. In the geometric case the transformation is $A \mapsto AX$, while in the cluster case the coordinate A does not change. Since $\mathcal{X}_{PGL_2, \hat{S}}$ is embedded into $\mathcal{X}_{PGL_m, \hat{S}}$, the cluster rule for the transformation of the \mathcal{X} -coordinates for $G = PGL_2$ also does not agree with the geometric one. There is a similar problem for the \mathcal{A} -coordinates. Below we are going to show how to resolve this problem.



FIG. 10.6. — A virus is obtained from an eye by the flip at the edge E .



FIG. 10.7. — Cluster transformation of coordinates for the flip at E making a virus from an eye.

Let v be the vertex of triangulation shown by the fat point on Figure 10.6. Let us construct a $2 : 1$ cover $\tilde{S} \rightarrow S$ ramified at the single point v of the compactification of S . Then there is an embedding $i : \mathcal{X}_{G,S} \hookrightarrow \mathcal{X}_{G,\tilde{S}}$. Its image is identified with the set of the stable points of the involution σ of the covering.

The coordinate system on either \mathcal{A} - or \mathcal{X} -space corresponding to a trivalent graph Γ on S is described by a torus $T_{S,\Gamma}^*$, where $*$ stays either for \mathcal{A} or for \mathcal{X} . A flip $\Gamma \rightarrow \Gamma'$ at an edge E provides a birational automorphism $\varphi_E^* : T_{S,\Gamma}^* \rightarrow T_{S,\Gamma'}^*$. The coordinate system on \tilde{S} corresponding to the lifted graph $\tilde{\Gamma}$ on \tilde{S} is described by the torus $T_{\tilde{S},\tilde{\Gamma}}^*$. One has

$$T_{S,\Gamma}^* = (T_{\tilde{S},\tilde{\Gamma}}^*)^{\sigma = \text{Id}}. \tag{10.13}$$

Lifting the trivalent graph on S to the cover \tilde{S} , we get the graph on the left of Figure 10.8. The involution σ interchanges the edges marked by the same

letter, and acts as the central symmetry with respect to the 4-valent vertex. We will make the flip at the edge E_1 , followed by the flip at the edge E_2 . These two flips are illustrated on Figure 10.8.

We claim that, using the identification (10.13), the geometric coordinate transformation corresponding to the flip at the edge E on Figure 10.6 equals to the composition of two flips on the cover \tilde{S} . Each of these flips is a product of mutations for the cluster ensemble $(\mathcal{X}_{PSL_m, \tilde{S}}, \mathcal{A}_{PSL_m, \tilde{S}})$.

10.2. Proposition. — *i) The composition of the flips at the edges E_1 and E_2 , restricted to the subtorus (10.13), is equivalent to the flip at the edge E on S , i.e. the following diagram is commutative:*

$$\begin{array}{ccc} T_{S, \Gamma}^* & \xrightarrow{\varphi_E^*} & T_{S, \Gamma'}^* \\ \downarrow = & & \downarrow = \\ (T_{\tilde{S}, \tilde{\Gamma}}^*)^{\sigma = \text{Id}} & \xrightarrow{\varphi_{E_2}^* \circ \varphi_{E_1}^*} & (T_{\tilde{S}, \tilde{\Gamma}'}^*)^{\sigma = \text{Id}} \end{array}$$

The flips at E_1 and E_2 commute.

ii) Each of the flips at the edges E_1 and E_2 is a product of mutations in the cluster ensemble defined using the trivalent graph on \tilde{S} (partly shown on Figure 10.8) and the function ε_{ij} related to it.

This proposition allows to deduce many properties of the coordinate transformations of the flips from an eye to a virus and back from the similar properties of mutations on the cover \tilde{S} .

Proof. i) This boils down to the very definitions.

ii) It is instructive to consider first the PGL_2 case. The transformation rule of \mathcal{X} -coordinates under a flip in this case is given in (12.11) below. So the coordinate transformations for the \mathcal{X} -coordinates are as follows:

$$\begin{aligned} B_1 &= B(1 + X), & C_1 &= C(1 + X^{-1})^{-1}, & \bar{A}_1 &= A(1 + X^{-1})^{-1}, & A_1 &= A(1 + X) \\ \bar{A}_2 &= A(1 + X)(1 + X^{-1})^{-1} = AX, & A_2 &= A(1 + X^{-1})^{-1}(1 + X) = AX. \end{aligned}$$

Thus the composition of two mutations on Figure 10.8 commutes with the automorphism σ of the covering, and thus corresponds to a transformation on S . The obtained transformation is the geometric transformation of coordinates corresponding to the flip at the edge E , see Figure 10.6.

Now let us address the general case, when $G = PGL_m/SL_m$. We say that an edge E is *generic* if for the quadrilateral Q_E of the triangulation having E as the diagonal both maps $\mathcal{A}_{G, \tilde{S}} \rightarrow \mathcal{A}_{G, Q_E}$ and $\mathcal{X}_{G, \tilde{S}} \rightarrow \mathcal{X}_{G, Q_E}$ provided by the restriction to Q_E are surjective at the generic point. For the \mathcal{A} -space a flip at a generic edge is a composition of mutations. Indeed,

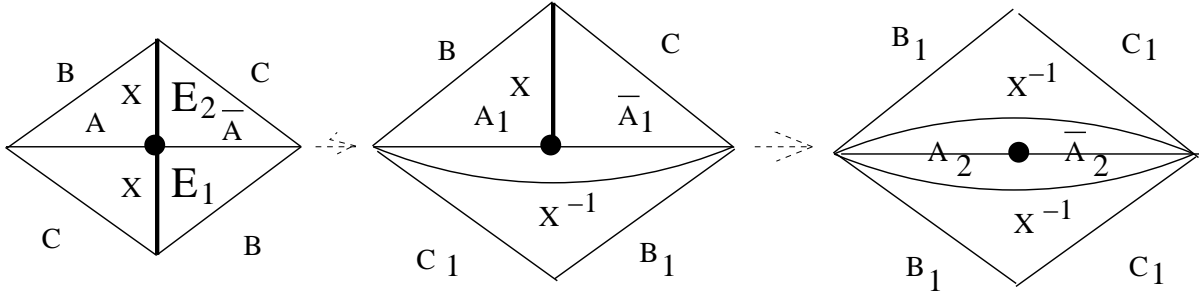

FIG. 10.8. — A flip on an eye is a composition of two mutations on a 2 : 1 cover.

the \mathcal{A} -coordinates on a quadrilateral are defined using the four affine flags assigned to the vertices of the quadrilateral. The quadrilaterals corresponding to the edges E_1 on the left picture and E_2 on the middle picture of Figure 10.8 are generic. This gives the claim ii) for the \mathcal{A} -coordinates.

The \mathcal{X} -coordinates in the internal part of the quadrilateral Q_E also depend only on the four flags assigned to the vertices of Q_E . However the \mathcal{X} -coordinates at an external edge F depend also on the fifth flag, and so we have to take into account the pentagon $P_{E,F}$ containing as the internal diagonals the edge E and the external edge F . The natural projection $\mathcal{X}_{G,\hat{S}} \rightarrow \mathcal{X}_{G,P_{E,F}}$ provided by the restriction to the pentagon $P_{E,F}$ is surjective at the generic point. This is clear for the edge E_1 . To check this for the edge E_2 observe that although the pentagon $P_{E,F}$ has two vertices identified (at the vertex w on Figure 10.9), the flags at these vertices differ by the monodromy around the puncture v , and thus they are generic. The claim ii) for the \mathcal{X} -coordinates follows from this. The proposition, and hence Theorem 1.18 are proved.

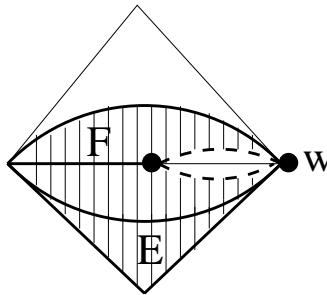

FIG. 10.9. — The two vertices of the shaded pentagon $P_{E,F}$ are identified at the vertex w .

8. Integral points of higher Teichmüller spaces. The following proposition is due to Grothendieck. We will prove it in a slightly different way.

10.3. Proposition. — *There is canonical bijection between the ribbon graphs and finite index torsion free subgroups of $SL_2(\mathbf{Z})$ modulo conjugation.*

Construction. Recall that ribbon graphs encode pairs (S, T) , where S is a surface with punctures, and T an ideal triangulation of S , considered modulo diffeomorphisms of surfaces. A torsion free finite index subgroup $\Delta \subset SL_2(\mathbf{Z})$ provides a surface $S_\Delta := \mathcal{H}/\Delta$ with triangulation given by the image of the Farey triangulation of \mathcal{H} . Vice versa, given a pair (S, T) we consider the point of the Teichmüller space $\mathcal{X}_{PGL_2, S}^+$ whose coordinates with respect to the triangulation T are equal to 1 at every edge of T . According to, say, Section 9.11, the monodromy representation of such a local system provides a subgroup $\Delta_{(S, T)}$ of $PSL_2(\mathbf{Z})$, well defined up to a conjugation. One checks that the triangulated surface corresponding to $\Delta_{(S, T)}$ is isomorphic to the pair (S, T) . Indeed, to compute the coordinate assigned to an edge E of the triangulation T , we take the two triangles sharing E to the universal cover, which is the hyperbolic plane with the Farey triangulation. There we get the two triangles $(\infty, -1, 0)$ and $(\infty, 0, 1)$. So the coordinate of E is $r^+(\infty, -1, 0, 1) = 1$. The proposition is proved.

10.1. Definition. — *A point of the Teichmüller space $\mathcal{X}_{G, S}^+$ is integral if the corresponding monodromy representation can be represented by a homomorphism $\pi_1(S) \hookrightarrow G(\mathbf{Z})$.*

So the pairs (S, T) considered modulo $\text{Diff}_0(S)$ describe the integral points of the Teichmüller space $\mathcal{X}_{PGL_2, S}^+$. Here is a hypothetical generalization.

Consider a cluster coordinate system on $\mathcal{X}_{PGL_m, S}$, and take a faithful representation $\pi_1(S) \hookrightarrow PGL_m(\mathbf{Q})$ corresponding to the point with all cluster \mathcal{X} -coordinates equal to 1.

10.1. Question. — Is it true that the above construction provides an inclusion $\pi_1(S) \hookrightarrow PGL_m(\mathbf{Z})$, and every integral point of the Teichmüller space $\mathcal{X}_{PGL_m, S}^+$ appears this way?

Example. The cluster coordinate system assigned to an ideal triangulation of S provides a map given as a composition $\pi_1(S) \hookrightarrow PSL_2(\mathbf{Z}) \hookrightarrow PSL_m(\mathbf{Z})$, where the first map comes from Proposition 10.3, and the second is given by the irreducible m -dimensional representation of SL_2 .

11. The classical Teichmüller spaces

1. Proof of Theorem 1.7a). Let p be a point of $\mathcal{X}_{PGL_2,S}^+$. Let us assign to p the corresponding representation $\rho_p : \pi_1(S) \rightarrow PSL_2(\mathbf{R})$. By Theorem 1.10 we get a discrete faithful representation of $\pi_1(S)$, and hence a point of the classical Teichmüller space. A framed structure for ρ_p is equivalent to a choice of orientations of those holes in S where the monodromy M_{hole} around the hole is not unipotent. Indeed, a framed structure near such a hole is given by a choice of a point on $\mathbf{R}P^1$ invariant under M_{hole} . To see this, we identify $\mathbf{R}P^1$ with the absolute of \mathcal{H} . Then the M_{hole} -invariant points are the ends of the unique M_{hole} -invariant geodesic covering the boundary geodesic on the surface $\mathcal{H}/\rho_p(\pi_1(S))$. (An element $M_{\text{hole}} \in PSL_2(\mathbf{R})$ is defined up to a conjugation by the image of $\pi_1(S)$). So choosing one of them we orient the geodesic towards the chosen point. So we get an inclusion

$$A : \mathcal{X}_{PGL_2,S}^+ \hookrightarrow \mathcal{T}_S^+.$$

Similarly there is a tautological inclusion B left inverse to A :

$$B : \mathcal{T}_S^+ \hookrightarrow \mathcal{X}_{PGL_2,S}(\mathbf{R}), \quad B \circ A = \text{Id}.$$

It remains to show that A is surjective or, equivalently, the image of the map B lies in $\mathcal{X}_{PGL_2,S}(\mathbf{R}_{>0})$. So we have to show that our coordinates on $\mathcal{X}_{PGL_2,S}(\mathbf{R})$ take positive values on the image of B .

Let S be a surface equipped with a hyperbolic metric with geodesic boundary. Choose a trivalent graph Γ on S and cut S along the sides of the dual graph Γ^\vee into hexagons, as on Figure 11.1. The two hexagons sharing an edge form an octagon. It has four geodesic sides surrounding holes. Let us lift the octagon to the hyperbolic plane and continue the geodesic sides till the absolute $\mathbf{R}P^1$.

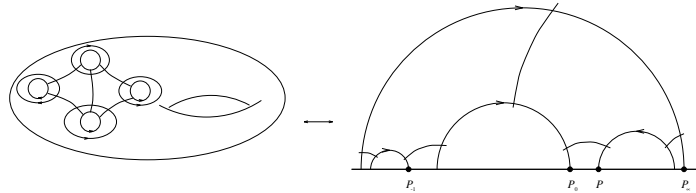

FIG. 11.1. — A geodesic octagon corresponding to a rectangle of the triangulation.

The orientations of the holes induce the orientations of the geodesics on \mathcal{H} , and hence the endpoints of these four geodesics. Therefore we get four points p_1, \dots, p_4 on the absolute $\mathbf{R}P^1$. The orientation of S induces a cyclic

order of geodesic sides of the octagon on S , and hence a cyclic order of the points p_1, \dots, p_4 . The key fact is that this cyclic order is compatible with the orientation of the absolute. Therefore the cross-ratio $r^+(p_1, \dots, p_4)$ is positive. Finally, if we assume that p_1 is the point incident to the diagonal E of the octagon, then $r^+(p_1, \dots, p_4)$ is the restriction of our coordinate function X_E^r to \mathcal{X}_S^+ . The part a) of the theorem is proved.

Before we start the proof of the part b) of Theorem 1.7, it is instructive to consider the following toy example.

2. Describing the decorated Teichmüller space for a disc with n marked points. Let V_2 be a real two dimensional vector space with a symplectic form ω . There is a canonical map $s : V_2 \longrightarrow S^2V_2$, $v \longmapsto v \cdot v$. A symplectic structure in V_2 determines a quadratic form (\cdot, \cdot) in S^2V_2 :

$$(v_1 \cdot v_2, v_3 \cdot v_4) := \frac{1}{2} \left(\omega(v_1, v_3)\omega(v_2, v_4) + \omega(v_1, v_4)\omega(v_2, v_3) \right).$$

In particular

$$(s(v_1), s(v_2)) = \omega(v_1, v_2)^2. \quad (11.1)$$

It is of signature $(2, 1)$. The vectors $s(v)$ are isotropic and lie on one half of the isotropic cone in S^2V_2 , denoted Q_+ . We identify Q_+ with the quotient of $V_2 - 0$ by the reflection $v \longmapsto -v$.

Observe that the projectivisation PQ_+ of the cone Q_+ is identified with the projective line $PV_2 = \mathbf{R}P^1$. So an orientation of the vector space V_2 induces an orientation of PQ_+ . A point q on the cone Q_+ projects to the point $\bar{q} \in PQ_+$. A configuration (q_1, \dots, q_n) of n points on the cone Q_+ is *positive* if the corresponding projective configuration of points $(\bar{q}_1, \dots, \bar{q}_n)$ in $PQ_+ = PV_2$ is positive, i.e. its cyclic order coincides with the one induced by the orientation of the projective line PV_2 .

Denote by $\text{Conf}_n^+(Q_+)$ the space of positive configurations of n points (q_1, \dots, q_n) on the cone Q_+ , and by $\text{CConf}_n^+(Q_+)$ the corresponding space of cyclic positive configurations.

Recall the space $\widetilde{\text{Conf}}_n(V_2)$ of twisted cyclic configurations of n vectors in the vector space V_2 . Let $\widetilde{\text{Conf}}_n^+(V_2)$ be the set of $\mathbf{R}_{>0}$ -points for the positive atlas defined in Section 8.

11.1. Proposition. — *There is a canonical isomorphism*

$$\text{CConf}_n^+(Q_+) \xrightarrow{\sim} \widetilde{\text{Conf}}_n^+(V_2). \quad (11.2)$$

Proof. Let us interpret the space $\text{CConf}_n^+(Q_+)$ in terms of the real vector space V_2 . Since $Q_+ = (V_2 - \{0\}) / \pm 1$, a configuration of n points in

Q_+ is the same thing as a $PSL_2(\mathbf{R})$ -configuration $(\pm v_1, \dots, \pm v_n)$ of n non-zero vectors in V_2 , each considered up to a sign. Now starting from such a cyclic $PSL_2(\mathbf{R})$ -configuration $(\pm v_1, \dots, \pm v_n)$ we make a twisted cyclic $SL_2(\mathbf{R})$ -configuration of n vectors in V_2 as follows. Consider a one dimensional subspace L in V_2 which does not contain any of the vectors $\pm v_i$. Let L' be one of the two connected components of $V_2 - L$. Let v'_i be the one of the two vectors $\pm v_i$ located in L' . We may assume that (v'_1, \dots, v'_n) is the order of the vectors v'_i in L' : otherwise we change cyclically the numerations of the vectors v_i . Then the correspondence

$$(\pm v_1, \dots, \pm v_n) \longrightarrow (v'_1, \dots, v'_n)$$

provides map (11.2). To check that it is well defined notice that if we move the line L so that it crosses the line spanned by the vector v_1 , but not v_2 , then we will get a configuration $(v'_2, \dots, v'_n, -v'_1)$ which is twisted cyclic equivalent to (v'_1, \dots, v'_n) . The proposition is proved.

The isomorphism (11.2) transforms the real coordinates $|\Delta(\pm v_i, \pm v_j)|$, $i < j$, on the left to the positive coordinates $\Delta(v'_i, v'_j)$, $i < j$, on the right.

3. Proof of Theorem 1.7b). Let us realize the hyperbolic plane as the sheet of the hyperboloid

$$-x_1^2 - x_2^2 + x_3^2 = 1, \quad x_3 > 0.$$

Denote by $\langle x, x' \rangle$ the symmetric bilinear form corresponding to the quadratic form $-x_1^2 - x_2^2 + x_3^2$. The horocycles on the hyperbolic plane are described by vectors x on the cone Q_+ , defined by the equation $\langle x, x \rangle = 0$ in the upper half space $x_3 > 0$. Namely, such a vector x provides a horocycle

$$h_x := \{ \xi \mid \langle \xi, x \rangle = 1, \quad \langle \xi, \xi \rangle = 1, \quad \xi_3 > 0 \}.$$

The distance $\rho(h_x, h_{x'})$ between the two horocycles h_x and $h_{x'}$ is defined as follows. Take the unique geodesic perpendicular to both horocycles. The horocycles cut out on it a geodesic segment of finite length. Then $\rho(h_x, h_{x'})$ is the length of this segment taken with the sign plus if the segment is outside of the discs inscribed into the horocycles, and with the sign minus otherwise, see Figure 11.2.

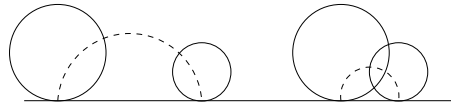

FIG. 11.2. — The distance between the horocycles can be any real number.

Observe that $\langle x, x' \rangle$ is positive unless x is proportional to x' . The distance between the two horocycles can be computed by the formula

$$\rho(h_x, h_{x'}) = \frac{1}{2} \log \langle x, x' \rangle. \quad (11.3)$$

Now take a hyperbolic topological surface S with n punctures equipped with a complete hyperbolic metric g . Its universal cover is the hyperbolic plane. The punctures are described by $\pi_1(S)$ -orbits of some arrows on the cone $\langle x, x \rangle = 0, x_3 > 0$.

According to Penner [P1], a decoration of (S, g) is given by a choice of a horocycle h_i for each of the punctures s_i . Let \mathcal{A}_S^+ be the moduli space of decorated complete hyperbolic surfaces of given topological type S . Penner's coordinates a_E^Γ on it are defined using a trivalent graph Γ on S and parametrised by the set $\{E\}$ of edges of Γ . Namely, consider the ideal triangulation of S dual to the graph Γ . For each side of the triangulation there is a unique geodesic between the punctures isotopic to the side. The coordinate a_E^Γ is the length of the segment of the geodesic γ_E contained between the two horocycles, for the triangulation dual to E .

We can interpret this definition as follows. Choose a lift $\tilde{\gamma}_E$ of the geodesic γ_E on the hyperbolic plane. It is defined up to the action of $\pi_1(S)$. Let l_1 and l_2 be the arrows on the cone $\langle x, x \rangle = 0$ corresponding to the boundary of $\tilde{\gamma}_E$. So the plane spanned by l_1 and l_2 intersects the hyperboloid by a geodesic $\tilde{\gamma}_E$. The arrows l_1, l_2 project to the punctures s_1, s_2 bounding γ_E . A choice of horocycle(s) at the puncture $s_i, i = 1, 2$, is equivalent to a choice of vector(s) x_i on the arrow l_i .

We need to show that the coordinates a_E^Γ coincide with our Δ -coordinates. We can spell the definition of the coordinates a_E^Γ as follows. Choose an edge E of the ribbon graph Γ . Let F_1 and F_2 be the two face paths sharing the edge E . Then a decoration on a twisted local $SL_2(\mathbf{R})$ -system \mathcal{L} on S provides vectors $\pm v_1$ and $\pm v_2$, each defined only up to a sign, in the fiber \mathcal{L}_E of the local system \mathcal{L} over the edge E . The vectors $\pm v_i$ are invariant up to a sign under the monodromy along the face path F_i . Then we assign to the edge E the coordinate

$$\Delta_E^\Gamma := |\Delta(v_1, v_2)|.$$

Observe that (11.1) implies $\Delta(v_1, v_2)^2 = (s(v_1), s(v_2))$. So thanks to (11.3)

$$a_E^\Gamma = \log |\Delta(v_1, v_2)| = \log |\Delta_E^\Gamma|.$$

It is well known that the monodromies along the conjugacy classes determined by punctures are unipotent. The theorem is proved.

12. Laminations and canonical pairings

In this Section we give geometric definitions of two types of laminations, \mathcal{A} - and \mathcal{X} -laminations, with integral, rational and real coefficients, on a punctured surface S . Our rational \mathcal{A} -laminations are essentially the same as Thurston's laminations [Th], which are usually considered for a surface S without boundary. Our definition of \mathcal{A} -laminations differs in the treatment of holes, and is more convenient for our purposes.

Our main results about laminations are the following:

i) The rational and real lamination spaces are canonically isomorphic to the points of the positive moduli spaces $\mathcal{A}_{SL_2,S}$ and $\mathcal{X}_{PSL_2,S}$ with values in the tropical semifields $\mathbf{Q}^t, \mathbf{R}^t$. The same is true for the integral \mathcal{X} -laminations, while the set of integral \mathcal{A} -laminations contains $\mathcal{A}_{SL_2,S}(\mathbf{Z}^t)$ as an explicitly described subset.

ii) The real \mathcal{A} -lamination space is canonically isomorphic to the space of Thurston's transversely measured laminations [Th], [PH].

iii) We define a canonical pairing between the real \mathcal{A} - (resp. \mathcal{X} -) laminations and the \mathcal{X} - (resp. \mathcal{A} -) Teichmüller spaces.

iv) We define a canonical map from the integral \mathcal{A} - (resp. \mathcal{X} -) laminations to functions on the \mathcal{X} - (resp. \mathcal{A} -) moduli spaces. Its image consists of functions on the moduli space which are Laurent polynomials with positive integral coefficients in each of our coordinate systems. We conjecture that the image of this map provides a canonical basis for the space of such functions, and that the canonical map admits a natural q -deformation.

In [FG4] we generalized results of this Section to the case of surfaces with marked points on the boundary.

The definitions of laminations are similar in spirit to the definitions of the singular homology groups. There are two different ways to define the notion of laminations for surfaces with boundary, which are similar to the definition of homology group with compact and closed support respectively.

Throughout this section S is a surface with $n > 0$ holes, Γ is a trivalent graph embedded into S in such a way that S is retractable onto it, and ε_{ij} , where i and j run through the set of edges of Γ , is a skew-symmetric matrix given by

$$\varepsilon_{ij} = (\text{number of vertices where the edge } i \text{ is to the left of the edge } j) - (\text{number of vertices where the edge } i \text{ is to the right of the edge } j) .$$

The entries of ε_{ij} take five possible values: $\pm 1, \pm 2$ or 0 .

1. \mathcal{A} - and \mathcal{X} -laminations and tropicalisations of the \mathcal{A} - and \mathcal{X} -moduli spaces.

12.1. Definition. — A rational \mathcal{A} -lamination on a surface S is the homotopy class of a finite collection of disjoint simple unoriented closed curves with rational weights, subject to the following conditions and equivalence relations.

1. Weights of all curves are positive, unless a curve surrounds a hole.
2. A lamination containing a curve of zero weight is equivalent to that with this curve removed.
3. A lamination containing two homotopy equivalent curves of weights a and b is equivalent to a lamination with one of these curves removed and with the weight $a + b$ on the other.

The set of all rational \mathcal{A} -laminations on a surface S is denoted by $\mathcal{A}_L(S, \mathbf{Q})$. It contains a subset $\mathcal{A}_L(S, \mathbf{Z})$ of *integral \mathcal{A} -laminations*, defined as rational \mathcal{A} -lamination with integral weights.

Any rational \mathcal{A} -lamination can be represented by a collection of $3g - 3 + n$ curves. Any integral \mathcal{A} -lamination can be represented by a finite collection of curves with unit weights.

12.2. Definition. — A Rational \mathcal{X} -lamination on a surface S is a pair consisting of

a) A homotopy class of a finite collection of nonselfintersecting and pairwise non-intersecting curves either closed or connecting two boundary components (possibly coinciding) with positive rational weights assigned to each curve and subject to the following equivalence relations:

1. A lamination containing a curve retractable to a boundary component is equivalent to the one with this curve removed.
2. A lamination containing a curve of zero weight is equivalent to the one with this curve removed.
3. A lamination containing two homotopy equivalent curves of weights a and b is equivalent to the lamination with one of these curves removed and with the weight $a + b$ on the other.

b) A choice of orientations of all boundary components but those that do not intersect curves of the lamination.

Denote the space of rational \mathcal{X} -laminations on S by $\mathcal{X}_L(S, \mathbf{Q})$. It contains a subset $\mathcal{X}_L(S, \mathbf{Z})$ of *integral \mathcal{X} -laminations*, defined as rational \mathcal{X} -laminations representable by collections of curves with integral weights.

Any rational \mathcal{X} -lamination can be represented by a collection of no more than $6g - 6 + 2n$ curves (for Euler characteristic reasons). Any integral \mathcal{X} -lamination can be represented by a finite collection of curves with unit weights.

12.1. Theorem. — *There are canonical isomorphisms*

$$\mathcal{A}_{SL_2,S}(\mathbf{Q}^t) \cong \mathcal{A}_L(S, \mathbf{Q}), \quad \mathcal{X}_{PSL_2,S}(\mathbf{Q}^t) \cong \mathcal{X}_L(S, \mathbf{Q}).$$

The proof of this theorem will occupy the rest of this subsection. The idea is this. We are going to introduce natural coordinates on the space of \mathcal{A} - and \mathcal{X} -laminations corresponding to a given isotopy class of a trivalent graph Γ on S , which is homotopy equivalent to S . Our construction is a modification of Thurston’s “train track” ([Th], section 9 and [PH]), and borrows from [F] with some modifications. Then we observe that the transformation rules for this coordinates under the flips are precisely the tropicalisations of the corresponding transformation rules for the canonical coordinates on the \mathcal{A} - and \mathcal{X} -moduli spaces. This proves the theorem. Let us start the implementation of this plan.

Construction of coordinates for \mathcal{A} -laminations. — We are going to assign to a given rational \mathcal{A} -lamination rational numbers on the edges of the graph Γ and show that these numbers are coordinates on the space of laminations.

Retract the lamination to the graph in such a way that each curve retracts to a path without folds on edges of the graph, and no curve goes along an edge and then, without visiting another edge, back. Assign to each edge i the sum of weights of curves going through it (Picture (12.1)), divided by two. The collection of these numbers, one for each edge of Γ , is the desired set of coordinates.

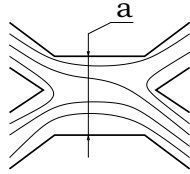

(12.1)

Remark. We divided the natural coordinates of \mathcal{A} -laminations by two to simplify some formulas for the multiplicative canonical pairing, see below.

Reconstruction of \mathcal{A} -laminations. — We need to prove that these numbers are coordinates. For this purpose we describe an inverse construction which gives a lamination starting from the numbers on edges.

First of all note that if we are able to reconstruct a lamination corresponding to a set of numbers $\{a_i\}$, we can do this as well for the set $\{ra_i\}$ and $\{a_i + t\}$ for any rational $r \geq 0$ and t . Indeed, multiplication of all numbers by r can be achieved by multiplication of all weights by r and adding t

is obtained by adding loops with weight $t/2$ around each hole. Therefore we can reduce our problem to the case when $\{a_i\}$ are positive integers and any three numbers a_1, a_2, a_3 on the edges incident to each given vertex satisfy the following triangle and parity conditions

$$|a_1 - a_2| \leq a_3 \leq a_1 + a_2 \tag{12.2}$$

$$a_1 + a_2 + a_3 \text{ is an integer} \tag{12.3}$$

Now the reconstruction of the lamination is almost obvious. Draw a_i lines on the i -th edge and connect these lines at vertices in a non-intersecting way (Picture (12.4)), which can be done unambiguously.

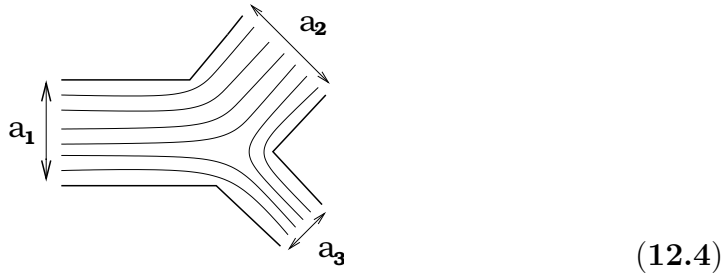

Graph change for \mathcal{A} -laminations. — The flip of the edge k changes the coordinates according to the formula:

$$a_i \rightarrow \begin{cases} a_i & \text{if } k \neq i, \\ -a_k + \max\left(\sum_{j|\varepsilon_{kj}>0} \varepsilon_{kj}a_j, -\sum_{j|\varepsilon_{kj}<0} \varepsilon_{kj}a_j\right) & \text{if } k = i. \end{cases}$$

Or in a graphical form:

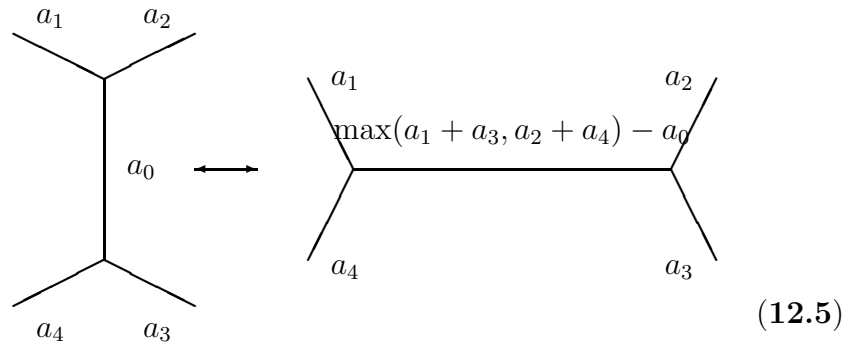

(Only part of the graph is shown here, the numbers on the other edges remain unchanged.)

Construction of coordinates for \mathcal{X} -laminations. — We are going to assign for a given point of the space $\mathcal{X}_L(S, \mathbf{Q})$ a set of rational numbers on edges of the graph Γ , and show that these numbers are global coordinates on this space.

Straightforward retraction of an \mathcal{X} -lamination onto Γ is not good because some curves may shrink to points or finite segments. To avoid this problem, let us first rotate each oriented boundary component infinitely many times in the direction prescribed by the orientation as shown on Picture (12.6).

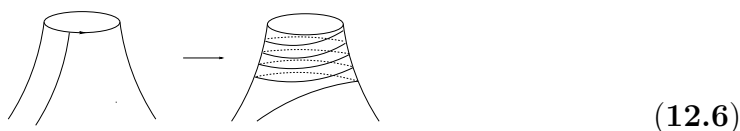

The resulting lamination can be retracted on Γ without folds. However we can get infinitely many curves going through an edge. Now assign to the edge the sum with signs of weights of curves that go diagonally, i.e., such that being oriented turn to the left at one end of the edge and to the right at another one (in this case we choose the plus sign), or first to the right and then to the left (in this case we choose the minus sign), as shown on Picture (12.7).

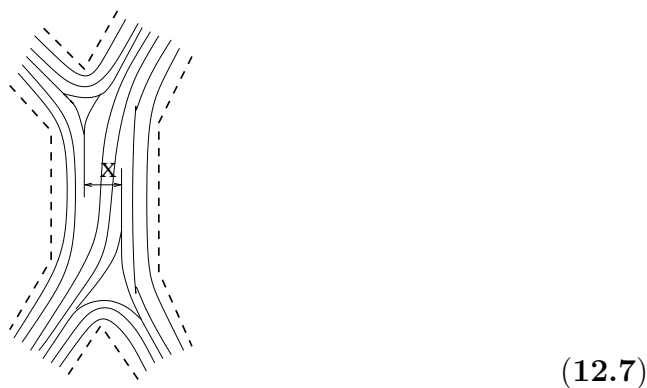

The collection of such rational numbers, one for each edge, is the desired coordinate system on $\mathcal{X}_L(S, \mathbf{Q})$. Note that the number of curves going diagonally is always finite and therefore the numbers assigned to an edge are well defined. Indeed, consider the curves retracted on the graph. We can mark a finite segment of each non-closed curve in such a way that each of two unmarked semi-infinite rays goes only around a single face and therefore never goes diagonally along the edges. Therefore only the finite marked parts of curves contribute to the numbers on the edges.

Reconstruction of \mathcal{X} -laminations. — We need to prove that these numbers are coordinates indeed. We will do it by describing an inverse construction. Note that if we are able to construct a lamination corresponding to a set of numbers $\{x_i\}$, we can equally do it for the set $\{rx_i\}$ for any rational $r > 0$. Therefore we can reduce our task to the case when all numbers on edges are integral. Now draw \mathbf{Z} -infinitely many lines along each edge. In order to connect these lines at vertices we need to split them at each of the two ends into two \mathbf{N} -infinite bunches to connect them with the corresponding bunches of the other edges. Let us do so at the i -th edge, such that $x_i \leq 0$ (resp. $x_i \geq 0$), in such a way that the intersection of the right (resp. left) bunches at the both ends of the edge consist of x_i lines (resp. $-x_i$ lines). Here the left and the right side are considered from the center of the edge toward the corresponding end. The whole procedure is illustrated on Picture (12.8). The resulting collection of curves may contain infinite number of curves surrounding holes, which should be removed in accordance with the definition of an unbounded lamination.

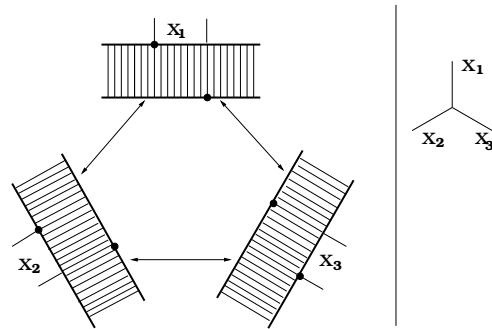

(12.8)

Note that although we have started with infinite bunches of curves the resulting lamination is finite. All these curves glue together into a finite number of connected components and possibly infinite number of closed curves surrounding punctures. Indeed, any curve of the lamination is either closed or goes diagonally along at least one edge. Since the total number of pieces of curves going diagonally $I = \sum_i |x_i|$ is finite, the resulting lamination contains no more than this number of connected components. (In fact the number of connected components equals I provided the numbers x_i are all non-positive or all nonnegative.)

Graph change for \mathcal{X} -laminations. — The flip of the edge k changes the coordinates according to the formula

$$x(i) \rightarrow \begin{cases} -x_i & \text{if } i = k, \\ x_i & \text{if } \varepsilon_{ki} = 0 \text{ and } k \neq i, \\ x_i + \max(0, x_k) & \text{if } \varepsilon_{ki} > 0, \\ x_i - \max(0, -x_k) & \text{if } \varepsilon_{ki} < 0, \end{cases}$$

or, in the graphical form:

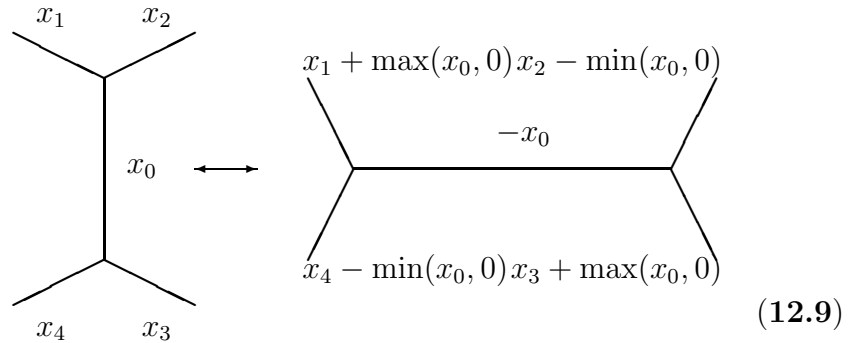

(Only part of the graph is shown here, the numbers on the other edges remain unchanged.)

End of the proof of Theorem 12.1. Recall that positive structures on the moduli spaces $\mathcal{A}_{SL_2,S}$ and $\mathcal{X}_{PSL_2,S}$ have been defined using the coordinate systems corresponding to trivalent ribbon graphs Γ embedded to S . The coordinate systems on the lamination spaces are defined using the same graphs. The transformation rules (12.5) and (12.9) are tropical limits of the ones for the respective moduli spaces $\mathcal{A}_{SL_2,S}$ and $\mathcal{X}_{PSL_2,S}$, as one sees comparing the pictures (12.5) and (12.9) with the pictures (12.10) and (12.11) where these rules are exhibited. The theorem is proved.

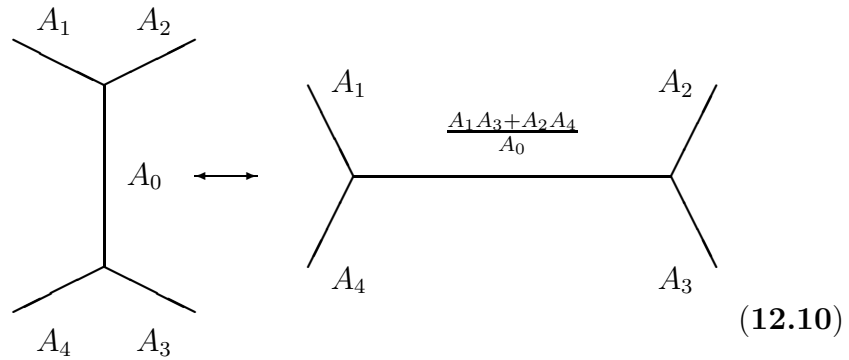

$$(12.11)$$

Relations and common properties of $\mathcal{X}_L(S, \mathbf{Q})$ and $\mathcal{A}_L(S, \mathbf{Q})$. —

1. Since the transformation rules for coordinates (12.5) and (12.9) are continuous with respect to the standard topology of \mathbf{Q}^n , the coordinates define a natural topology on the lamination spaces. One can now define the spaces of *real laminations* as completions of the corresponding spaces of rational laminations. These spaces are denoted as $\mathcal{A}_L(S, \mathbf{R})$ and $\mathcal{X}_L(S, \mathbf{R})$, respectively. Of course, we have the coordinate systems on these spaces automatically. Evidently there are canonical isomorphisms

$$\mathcal{A}_{SL_2, S}(\mathbf{R}^t) \cong \mathcal{A}_L(S, \mathbf{R}), \quad \mathcal{X}_{PSL_2, S}(\mathbf{R}^t) \cong \mathcal{X}_L(S, \mathbf{R}).$$

The constructed spaces of real laminations coincide with the spaces of transversely measured laminations introduced by W.Thurston [Th]. We'll prove this statement below.

2. An \mathcal{X} -lamination is integral if and only if it has integral coordinates. However an \mathcal{A} -lamination is integral if and only if it has half-integral coordinates and their sum at every vertex is an integer. So we have

$$\mathcal{X}_{PSL_2, S}(\mathbf{Z}^t) \cong \mathcal{X}_L(S, \mathbf{Z}), \quad \mathcal{A}_{SL_2, S}(\mathbf{Z}^t) \subset \mathcal{A}_L(S, \mathbf{Z}) \subset \mathcal{A}_{SL_2, S}(\frac{1}{2}\mathbf{Z}^t).$$

4. There is a canonical map

$$p : \mathcal{A}_L(S, \mathbf{Q}) \rightarrow \mathcal{X}_L(S, \mathbf{Q})$$

which removes all curves retractable to boundary components. In coordinates it is given by

$$x_i = \sum_j \varepsilon_{ij} a_j. \tag{12.12}$$

5. For any given \mathcal{X} -lamination and any given puncture one can calculate the sum

$$\sum_{i \in \gamma} x_i, \tag{12.13}$$

where γ is the set of edges surrounding the puncture. The absolute value of this sum gives the total weight of the curves entering the puncture, and its sign tells the difference between the orientation of the puncture and the one induced by the orientation of the surface.

6. For any given \mathcal{A} -lamination and any given puncture consider the expression

$$\max_{i \in \gamma} (a_{i''} - a_i - a_{i'}), \tag{12.14}$$

where i' is the edge next to i in counterclockwise direction and i'' is the edge between i and i' . This expression gives the weight of the loop surrounding the puncture.

2. Additive canonical pairings and the intersection pairing. An additive canonical pairing is a function of two arguments. One argument is a rational (or, later on, real) lamination, which can be either \mathcal{A} - or \mathcal{X} -lamination, and the other is a point of the opposite type Teichmüller space, $\mathcal{X}^+ := \mathcal{X}_{PSL_2, S}^+$ or $\mathcal{A}^+ := \mathcal{A}_{SL_2, S}^+$:

$$I : \mathcal{A}_L(\mathbf{Q}) \times \mathcal{X}^+ \rightarrow \mathbf{R}, \quad I : \mathcal{X}_L(\mathbf{Q}) \times \mathcal{A}^+ \rightarrow \mathbf{R}.$$

We will also define the *intersection pairing*

$$\mathcal{I} : \mathcal{A}_L(\mathbf{Q}) \times \mathcal{X}_L(\mathbf{Q}) \rightarrow \mathbf{R}$$

which should be thought of as a degeneration of an additive pairing. Abusing notation, we shall denote the first two of them by a single letter I . We shall also denote the canonical maps $p : \mathcal{A}^+ \rightarrow \mathcal{X}^+$ and $p : \mathcal{A}_L \rightarrow \mathcal{X}_L$ by the same letter p .

Let us define these pairings. Below by the length of a curve on a surface with metric of curvature -1 we always mean the length of the unique geodesic isotopic to this curve.

12.3. Definition. —

1. Let $l \in \mathcal{X}_L$ be a single closed curve. Then $I(l, m)$ is its length w.r.t the hyperbolic metric on S defined by m .
2. Let $l \in \mathcal{A}_L$ be a single closed curve. Then $I(l, m)$ is equal to \pm its length w.r.t the hyperbolic metric on S defined by m . The sign is $+$ unless l surrounds a negatively oriented hole.
3. Let l be a curve connecting two boundary components and $m \in \mathcal{A}^+$. Let us assume that orientations of these boundary components are induced by the ones of the surface. Then $I(l, m)$ is the signed length of the curve l between the horocycles.

4. Let l_1 and l_2 be non-intersecting collections of curves. Then $I(\alpha l_1 + \beta l_2, m) = \alpha I(l_1, m) + \beta I(l_2, m)$, and similarly for \mathcal{I} .

5. Let l_1 and l_2 be two curves. Then $\mathcal{I}(l_1, l_2)$ is the minimal number of intersection points of l_1 and l_2 .

In the proposition below by coordinates we always mean the coordinates corresponding to a certain given trivalent graph Γ such that S is retractable on Γ . All the statements are assumed to be valid for every such graph Γ . Recall the logarithms $x_i := \log X_i$ and $a_i := \log A_i$ of the canonical positive coordinates on the \mathcal{X} - and \mathcal{A} -Teichmüller spaces. The coordinates on the lamination spaces are also denoted by x_i and a_i .

12.1. Proposition. —

1. The pairings I and \mathcal{I} are continuous.

2. $I(l, p(m)) = I(p(l), m)$, where $l \in \mathcal{A}_L$ and $m \in \mathcal{A}^+$.

3. If a point l of the space \mathcal{X}_L has positive coordinates x_1, \dots, x_n and a point m of the Teichmüller \mathcal{A} -space has coordinates a_1, \dots, a_n , then $I(l, m) = \sum_{\alpha} a_{\alpha} x_{\alpha}$.

4. Let m be a point of a Teichmüller space with coordinates u_1, \dots, u_n with respect to a graph Γ . Let C be a positive real number. Denote by $C \cdot m$ a point with coordinates Cu_1, \dots, Cu_n . Let m_L be a lamination with the coordinates u_1, \dots, u_n . Then $\lim_{C \rightarrow \infty} I(l, C \cdot m)/C = \mathcal{I}(l, m_L)$.

Observe that the last property implies the properties 2 and 3 for \mathcal{I} .

Proof. The property 2 follows from the definition and the property 1. The property 3 follows from the observation that if all coordinates of an \mathcal{X} -lamination are positive w.r.t. a given graph Γ , all its leaves can be deformed to paths across the edges of Γ . Indeed, if all coordinates are ≥ 0 , a path in Γ is of the form $\dots l \dots l r \dots r \dots$ where lr corresponds to a positive coordinate, then such a path is homotopic to a curve from one puncture to another. The proof of property 4 will be postponed to our consideration of the multiplicative pairing.

Let us first prove the continuity of the pairing between \mathcal{A} -laminations and the \mathcal{X} -Teichmüller space. To do this it suffices to prove it for laminations without curves with negative weights. Indeed, if we add such curve to a lamination, the length obviously changes continuously. We are going to show that the length of an integral lamination is a convex function of its coordinates, i.e. that

$$I(l_1, m) + I(l_2, m) \geq I(l_1 +_{\Gamma} l_2, m) \quad (12.15)$$

were by $l_1 +_r l_2$ we mean a lamination with coordinates being sums of the respective coordinates of l_1 and l_2 . Taking into account the homogeneity of I , one sees that the inequality (12.15) holds for all rational laminations and therefore can be extended by continuity to all real laminations.

Let us prove the inequality (12.15). Draw both laminations l_1 and l_2 on the surface and deform them to be geodesic. These laminations in general intersect each other in finite number of points. Then retract the whole picture to the ribbon graph in such a way that no more intersection points appear and the existing ones are moved to the edges. Now it becomes obvious that at each intersection point we can rearrange our lamination cutting both intersecting curves at the intersection point and gluing them back in another order in a way to make the resulting set of curves homotopically equivalent to a non-intersecting collection. We can do it at each intersection point in two different ways, and we use the retraction to the ribbon graph to choose one of them.

Indeed, connect them as shown on Picture (12.16).

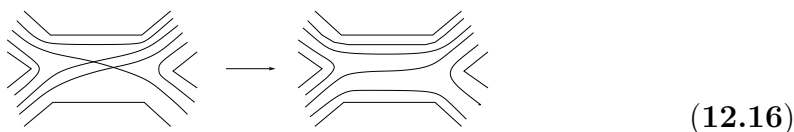

One can easily see that the numbers on edges, corresponding to the new lamination l are exactly the sums of the numbers corresponding to l_1 and l_2 . On the other hand, the lamination on the original surface is no longer geodesic, because its curves may have breaks. But its length is exactly $I(l_1, m) + I(l_2, m)$. When we deform l to a geodesic lamination, its length can only decrease, which proves the inequality (12.15).

The proof of the continuity when the first argument is an \mathcal{X} -lamination and the second is a point of the \mathcal{A} -Teichmüller space is similar. Call a pair of laminations l_1 and l_2 *similar* if at each hole both laminations l_1 and l_2 have the same orientation or at least one of them does not touch the hole. Once the inequality (12.15) is proved for similar laminations l_1 and l_2 , the continuity follows since the set of laminations similar to a given one is a closed subset in the space \mathcal{X}_L . Conjecturally the inequality (12.15) holds for any pair l_1 and l_2 . But for a pair of similar laminations the arguments used above works: one can first forget about orientations and move the leaves in order to minimize the number of intersection points. Then one can first spiralize the leaves according to the orientations, retract the resulting collection of curves to the graph and then resolve the intersection points just as above (Picture (12.16)). The inequality (12.15) follows.

Using 4 we deduce from this the convexity of the pairing \mathcal{I} .

The continuity implies the following

12.1. Corollary. — *Our real \mathcal{A} -laminations are canonically identified with Thurston's transversally measured laminations.*

Proof. Thurston proved that rational laminations are dense in the space of all transversally measured laminations w.r.t. the topology given by the length function. Our rational \mathcal{A} -laminations coincide with Thurston's. Our canonical pairing of \mathcal{A} -laminations with the Teichmüller space is nothing but Thurston's length function. Therefore the continuity shows that our topology coincides with Thurston's. The corollary is proved.

12.2. Corollary. — *The additive canonical pairings and the intersection pairing provide continuous pairings between the real lamination and Teichmüller/lamination spaces:*

$$I : \mathcal{A}_L(\mathbf{R}) \times \mathcal{X} \rightarrow \mathbf{R}, \quad I : \mathcal{X}_L(\mathbf{R}) \times \mathcal{A} \rightarrow \mathbf{R}, \quad \mathcal{I} : \mathcal{A}_L(\mathbf{R}) \times \mathcal{X}_L(\mathbf{R}) \rightarrow \mathbf{R}.$$

We say that an element of $\mathcal{X}_{PSL_2,S}(\mathbf{C})$ is quasifuchsian if the corresponding representation of $\pi_1(S)$ is quasi-Fuchsian. The set of all quasifuchsian elements forms an open domain of $\mathcal{X}_{PSL_2,S}(\mathbf{C})$ which we call the quasifuchsian domain.

12.1. Conjecture. — *Let l be a real \mathcal{A} -lamination. The function $I(l, *)$ is analytically continuable exactly to the quasifuchsian domain of $\mathcal{X}_{PSL_2,S}(\mathbf{C})$.*

3. Multiplicative canonical pairings. A multiplicative canonical pairing \mathbf{I} is a pairing between integral $\mathcal{A}_{SL_2,S}$ -laminations and $\mathcal{X}_{PSL_2,S}$ -moduli space or between integral $\mathcal{X}_{PSL_2,S}$ -laminations and $\mathcal{A}_{SL_2,S}$ -moduli space. These pairings are better understood as maps

$$\mathbf{I}_A : \mathcal{A}_{SL_2,S}(\mathbf{Z}^t) \longrightarrow \mathbf{Q}(\mathcal{X}_{PSL_2,S}), \quad \mathbf{I}_X : \mathcal{X}_{PSL_2,S}(\mathbf{Z}^t) \longrightarrow \mathbf{Q}(\mathcal{A}_{SL_2,S})$$

equivariant with respect to the action of the mapping class group of S . The group $(\mathbf{Z}/2\mathbf{Z})^n$ acts naturally on the space $\mathcal{X}_{PSL_2,S}$. We will define in Section 12.6 an action of this group on the space $\mathcal{A}_{PSL_2,S}$, so that the above maps intertwine these actions.

Before defining the map \mathbf{I}_A we will define an auxiliary map

$$\tilde{\mathbf{I}}_A : \mathcal{A}_{SL_2,S}((\mathbf{Z}^t)/2) \longrightarrow \mathbf{Q}(\widehat{\mathcal{X}_{PSL_2,S}}),$$

where the hat denotes certain covering of the space $\mathcal{X}_{PSL_2,S}$. Afterwards we shall check that the restriction of this pairing to $\mathcal{A}_{SL_2,S}(\mathbf{Z}^t)$ comes from $\mathcal{X}_{PSL_2,S}$, thus defining the desired pairing.

Here is our strategy. Say that a Laurent polynomial is *sign definite* if all its non zero coefficients are of the same sign. Given a sign definite Laurent polynomial we can multiply it by ± 1 to make a positive Laurent polynomial out of it. We are going to define first the related maps $\mathbf{I}'_{\mathcal{A}}$ and $\mathbf{I}'_{\mathcal{X}}$. Then we will show that $\mathbf{I}'_{\mathcal{A}}(l)$ and $\mathbf{I}'_{\mathcal{X}}(l)$ are sign definite Laurent polynomials. By definition the elements $\mathbf{I}_{\mathcal{A}}$ and $\mathbf{I}_{\mathcal{X}}$ are the corresponding positive Laurent polynomials. We will produce our sign definite Laurent polynomials as products of sign definite Laurent polynomials, so we allow them to be well defined only up to a sign. For example the trace of a matrix from $PSL_2(F)$ is defined up to a sign function.

Recall that a curve l connecting two punctures on S provides a well defined regular function $\Delta(l)$ on the space $\mathcal{A}_{SL_2, S}$. Further, let l be a closed curve surrounding a puncture on S . Then the monodromy operator for a framed local system \mathcal{L} on S around l has a distinguished eigenvalue λ_l determined by the framed structure: the eigenvector with this eigenvalue λ_l generates the invariant flag assigned to this puncture.

Let l be a loop on S . Let \tilde{l} be a section of the punctured tangent bundle $T'S$ of S restricted to l . The homotopy class of \tilde{l} is well defined. By monodromy of a twisted SL_2 -local system \mathcal{L} on S we understand the monodromy of \mathcal{L} around \tilde{l} .

12.4. Definition. —

1. Let l be a loop with the weight k which does not surround a puncture. Then

i) the value of the function $\pm \tilde{\mathbf{I}}'_{\mathcal{A}}(l)$ on the framed PSL_2 -local system \mathcal{L} is the trace of the k -th power of the monodromy of \mathcal{L} along l .

ii) the value of the function $\mathbf{I}'_{\mathcal{X}}(l)$ on the twisted decorated SL_2 -local system \mathcal{L} is the trace of the k -th power of the monodromy of \mathcal{L} along the lifted loop \tilde{l} in $T'S$.

2. Let l be a closed curve surrounding a puncture on S , and $k \cdot l$ the \mathcal{A} -lamination determined by this curve and a weight k . Then $\tilde{\mathbf{I}}'_{\mathcal{A}}(k \cdot l) = \lambda_l^k$.

3. Let l be a curve with weight k connecting two punctures. Let us assume that orientations of these punctures are induced by the orientation of the surface. Then $\mathbf{I}'_{\mathcal{X}}(l) = \Delta(l)^k$.

4. Let l_1 and l_2 be non-intersecting collections of curves, such that no isotopy class of a curve enters both l_1 and l_2 . Then $\mathbf{I}'_*(l_1 + l_2) = \mathbf{I}'_*(l_1)\mathbf{I}'_*(l_2)$, where $*$ stands for \mathcal{A} or \mathcal{X} , and $\tilde{\mathbf{I}}'$ is needed in the \mathcal{A} -case.

Here we assume that we have reduced the lamination to the form without equivalent curves.

In this definition the map $\tilde{\mathbf{I}}_{\mathcal{A}}(l)$ is defined for all integral laminations. In the definition of the map $\mathbf{I}'_{\mathcal{X}}(l)$ we assume so far that if a curve of the lamination connects two punctures, then orientations of both punctures are induced by the orientation of the surface S . We will extend the definition to all \mathcal{X} -laminations in the end of the Section 12.6. Namely, recall that the group $(\mathbf{Z}/2\mathbf{Z})^n$ acts on the \mathcal{X} -space by changing the orientations of the boundary components. We will define an action of the group $(\mathbf{Z}/2\mathbf{Z})^n$ on the \mathcal{A} -space, and extend the map $\mathbf{I}_{\mathcal{X}}$ to a map equivariant with respect to the action of the group $(\mathbf{Z}/2\mathbf{Z})^n$.

In the theorem below by coordinates we always mean the coordinates corresponding to a certain fixed trivalent graph Γ such that S is retractable on Γ . All statements are assumed to be valid for every such graph Γ . The function $\mathbf{I}'_{\mathcal{X}}(l)$ is restricted to those laminations l where it has been defined.

12.2. Theorem. —

1. Let $a_1, \dots, a_n \in \mathbf{Z}$ be coordinates of an integral \mathcal{A} -lamination l . Then the function $\tilde{\mathbf{I}}'_{\mathcal{A}}(l)$ is a sign definite Laurent polynomial with integral coefficients in the coordinates X_1, \dots, X_n on \mathcal{X} . Its highest term is equal to $\prod_i X_i^{a_i}$ and the lowest one is $\prod_i X_i^{-a_i}$.
2. The function $\mathbf{I}'_{\mathcal{X}}(l)$ is a sign definite Laurent polynomial with integral coefficients in the coordinates A_1, \dots, A_n on \mathcal{A} .
3. Let $C \in \mathbf{Z}$. Then $\lim_{C \rightarrow \infty} \log \mathbf{I}_*(l, C \cdot m)/C = \mathcal{I}(l, m_L)$, where the definitions of $C \cdot m$ and m_L are the same as for the property 4 in the additive case.
4. $\mathbf{I}_{\mathcal{A}}(l, p(m)) = \mathbf{I}_{\mathcal{X}}(p(l), m)$ where $l \in \mathcal{A}_{SL_2, S}(\mathbf{Z}^t)$ and $m \in \mathcal{A}_{SL_2, S}$.
5. $\mathbf{I}_*(l_1)\mathbf{I}_*(l_2) = \sum_l c_*(l_1, l_2; l)\mathbf{I}_*(l)$, where $*$ stands for either \mathcal{X} or \mathcal{A} , and $c_*(l_1, l_2; l)$ are non-negative integers, and the sum is finite.

Observe that the property 1 implies that if an \mathcal{A} -lamination is integral, the corresponding function is lifted from $\mathcal{X}_{PSL_2, S}$, and the map $\mathbf{I}_{\mathcal{A}}(l)$ is defined.

Proof. Statement 3 immediately follows from the analogous additive statement and the fact that for a curve l connecting punctures $\exp(I(l, m)) = \mathbf{I}_{\mathcal{X}}(l, m)$, and for a closed curve l we have $\cosh(I(l, m)) = \mathbf{I}_*(l, m)$.

As a corollary one deduces property 4 of Proposition 12.1. Property 1 of Theorem 12.2 implies property 3 for integral laminations. This implies that the identity $\lim_{C \rightarrow \infty} I(l, C \cdot m)/C = \mathcal{I}(l, m)$ holds for an integral lamination l . By continuity it can be extended to any laminations.

Statement 4 is obvious if l is a loop: if this loop does not surround a puncture, both sides of the equality are equal to the trace of the monodromy of the corresponding local system; if l surrounds a puncture, it is 1 for both sides. The general case follows by multiplicativity.

The properties 1 and 2 for the \mathcal{X} -moduli space follow essentially from Theorem 9.3 and Corollary 9.2, valid for PGL_m . However for the sake of completeness of this Section, we prove them below.

Before presenting the proof of the properties 1 and 2 recall the construction of monodromy matrices starting from coordinates of our moduli spaces given in Sections 8 and 9, specified to the case of $G = PGL_2$ and $G = SL_2$.

Let us do it first for the \mathcal{X} -moduli space. Replace the graph Γ by another one Γ' by gluing small triangles into each vertex and define a graph connection on it as shown on Figure 12.17. (The graph Γ is shown by thin lines.)

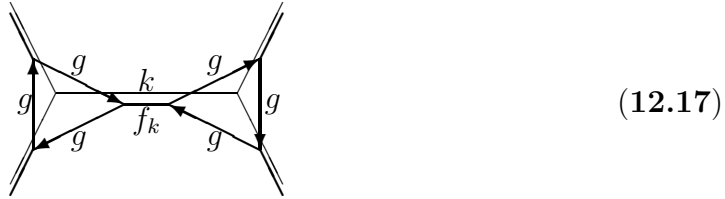

Here f_k and g are given by

$$f_k = \begin{pmatrix} 0 & -X_k^{1/2} \\ X_k^{-1/2} & 0 \end{pmatrix}, \quad g = \begin{pmatrix} 1 & 1 \\ -1 & 0 \end{pmatrix}.$$

Here, since we work with PGL_2 , we employ a bit more symmetric notation for the matrix $f_k = \begin{pmatrix} 0 & -X_k \\ 1 & 0 \end{pmatrix}$, using coordinates $X_k^{\pm 1/2}$ on a covering. The monodromy around small triangles is the identity since $g^3 = -1$ in SL_2 , i.e. $g^3 = 1$ in PSL_2 . The orientations of the edges with the matrices f_i do not play any role since $f_i = f_i^{-1}$ in PSL_2 .

Here is a similar construction for the \mathcal{A} -moduli space. Replace the graph Γ by another one by replacing each vertex by a hexagon and define a graph connection on it as shown on Picture (12.18). (The graph Γ is shown by the

thin lines).

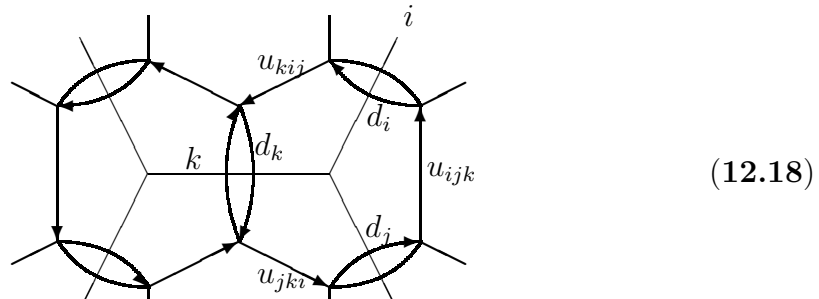

Here the matrices d_k and u_{ijk} are given by:

$$d_k = \begin{pmatrix} 0 & -A_k \\ \frac{1}{A_k} & 0 \end{pmatrix}, \quad u_{ijk} = \begin{pmatrix} 1 & 0 \\ \frac{A_k}{A_i A_j} & 1 \end{pmatrix}.$$

The monodromy around the hexagons is the unity since $d_j u_{jki} d_k u_{kij} d_i u_{ijk} = 1$ in SL_2 . The monodromy around the 2-gons is -1 . The monodromy along a face path fixes the vector $\begin{pmatrix} 0 \\ 1 \end{pmatrix}$.

Now proceed with the proof. Due to multiplicativity it suffices to prove statements 1 and 2 for a connected curve l . Consider first statement 1. In this case l must be a loop. Let α be a loop on the graph Γ' homotopic, on S , to the loop l . We may assume that the loop α contains no consecutive edges of little triangles on Γ' . Observe that

$$f_k g = \begin{pmatrix} X_k^{1/2} & 0 \\ X_k^{-1/2} & X_k^{-1/2} \end{pmatrix}, \quad f_k g^{-1} = \begin{pmatrix} X_k^{1/2} & X_k^{1/2} \\ 0 & X_k^{-1/2} \end{pmatrix}. \tag{12.19}$$

(The second equality is in PGL_2 .) So calculation of the monodromy around such a loop reduces to taking products of matrices of type (12.19), just one of them per each edge of the original graph Γ which appears in the loop α . These matrices are positive and Laurent. Evidently the trace of such a monodromy operator is a positive Laurent polynomial, and the coefficients of the highest and lowest monomials are equal to 1.

Remark. In general the coordinates of an \mathcal{A} -lamination l are half-integers $a_1, \dots, a_n \in \mathbf{Z}/2$, and the function $\tilde{\mathbf{I}}_{\mathcal{A}}(l)$ is defined only on a covering of the space \mathcal{X} . However if $a_i \in \mathbf{Z}$, the proof shows that it is defined on the space \mathcal{X} itself. So we get the function $\mathbf{I}'_{\mathcal{A}}(l)$.

Consider now property 2. Call a matrix with Laurent-polynomial coefficients *sign definite* if each its entry is a Laurent polynomials with all positive or all negative coefficients. Let the *type* of a *sign definite* matrix M be a matrix $|M|$ of the same size as M with entries equal to $+$, $-$ or 0 indicating

the sign of the monomials of the corresponding entries of M . Define a partial product on the set of types by the requirement, that $ab = c$ if for any two matrices M_1 and M_2 , such that $|M_1| = a$ and $|M_2| = b$, we have $|M_1M_2| = c$.

Consider a path l connecting two holes, retracted to the graph I' . The desired intersection index is given by the top right element of the monodromy matrix. The sequence of matrices along the path is composed of the matrices u, u^{-1} and d . Since it connects two holes, we may assume that it starts and ends with a d . The path can be deformed to make the sequence avoid the subsequences $uu^{-1}, u^{-1}u, udu, d^2$ and $u^{-1}du^{-1}$. To investigate the sign properties of the product, let us replace every matrix in the sequence by its type and investigate the type of the product. Let

$$D := |d_i| = \begin{pmatrix} 0 & - \\ + & 0 \end{pmatrix}, \quad U^+ = |u_{ijk}| = \begin{pmatrix} + & 0 \\ + & + \end{pmatrix}, \quad U^- = |(u_{ijk})^{-1}| = \begin{pmatrix} + & 0 \\ - & + \end{pmatrix}.$$

Now observe that $(U^+)^n = U^+$ and $(U^-)^n = U^-$ for any $n \in \mathbf{N}$, and replace the sequences of U^+ and U^- by single letters. The resulting sequence has one of the following four forms:

$$DU^-D(U^+DU^-D)^kU^+D, \quad D(U^+DU^-D)^kU^+D, \quad DU^-D(U^+DU^-D)^k, \\ D(U^+DU^-D)^k.$$

The crucial observation is this:

the products U^+DU^-D and DU^-DU^+ are of the type $-P = \begin{pmatrix} - & - \\ - & - \end{pmatrix}$. (12.20)

In particular the type of $(U^+DU^-D)^k$ is $(-1)^kP$. Our problem now is reduced to the verification that in each of the four cases the top right entry is sign definite. Since DP and PD are sign definite, this takes care of cases one and four. Observe that $DU^-D = \begin{pmatrix} - & - \\ 0 & - \end{pmatrix}$, so DU^-DP is sign definite, and so the claim in case three follows. Finally, DPU^+D is sign definite, so the claim in case two follows.

Let us prove the statement for a closed loop l . In this case $\mathbf{I}'_{\mathcal{X}}(l)$ is the trace of a cyclic word of type $\dots DU^{\pm}DU^{\mp}DU^{\pm}DU^{\mp}DU^{\pm}$. We will assume that its length is minimal possible for a given loop l . So the following cases may occur:

- i) The word is U^+, U^- or D . These are trivial cases.
- ii) The cyclic word is DU^+ or DU^- . One easily checks that in this case the trace is sign-definite.
- iii) The cyclic word has length greater than two. Then the length is even: otherwise the length of the cyclic word can be reduced. If the length is

bigger than 2 and not divisible by 4, there must be a segment $\dots DU^\pm DU^\pm \dots$. Therefore the sequence can be made shorter. If the length is two, the claim follows from ii). Finally, if the length is $4k$, we can write it as a product of k segments of type DU^+DU^- , each of which is sign definite by (12.20).

Let us prove the property 5. Let us spell out the proof in the more complicated case of \mathcal{X} -laminations. For this we introduce the notion of a *quasi-lamination*. A quasi-lamination is a collection of curves, connecting punctures or closed. Unlike the laminations, they may intersect or have self-intersections. One can define the canonical multiplicative pairings for single curve quasi-laminations by the same rules as for laminations, and extend it to the collections of curves by multiplicativity, i.e., by definition $\mathbf{I}_*(l_1)\mathbf{I}_*(l_2) = \mathbf{I}_*(l)$, where l is a quasi-lamination given by the union of l_1 and l_2 . The functions on the moduli spaces corresponding to quasi-laminations satisfy certain linear *skein relations*, described below. We will show that using these relations one can represent any function corresponding to a quasi-lamination as a positive integral linear combination of similar functions corresponding to laminations, thus proving the property. Let us describe the relations. A lamination in the vicinity of an intersection or self-intersection point looks like a cross $\mathbf{+}$. Let l_1 and l_2 be the quasi-laminations obtained by replacing this cross by \curvearrowright and \curvearrowleft respectively. The relation is

$$\mathbf{I}_*(l, m) \pm \mathbf{I}_*(l_1, m) \pm \mathbf{I}_*(l_2, m) = 0,$$

for some choice of signs depending on l, l_1, l_2 . To prove this, and determine the signs, we consider the following three cases: (i) an intersection of two loops; (ii) an intersection of a path connecting two punctures, each puncture equipped with a decoration as a vector v_i , and a loop; (iii) an intersection of two paths connecting decorated punctures. The proof in the cases (i) and (ii) follows from the two pictures on Figure 12.1, and the following two identities for 2×2 matrices with determinant 1 and a pair of vectors v_1, v_2 in a two dimensional vector space:

$$\text{tr}A\text{tr}B = \text{tr}AB + \text{tr}AB^{-1}, \quad (v_1 \wedge v_2) \cdot \text{tr}A = v_1 \wedge Av_2 + v_1 \wedge A^{-1}v_2. \quad (12.21)$$

The second identity follows from $\text{tr}A \cdot \text{Id} = A + A^{-1}$. The proof in the case

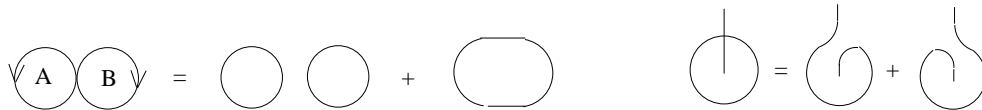

FIG. 12.1. — Skin relations.

(iii) reduces to the Plücker identity $\Delta(v_1, v_3)\Delta(v_2, v_4) = \Delta(v_1, v_2)\Delta(v_3, v_4) +$

$\Delta(v_1, v_4)\Delta(v_2, v_3)$. Since l_1 as well as l_2 have one intersection point less than

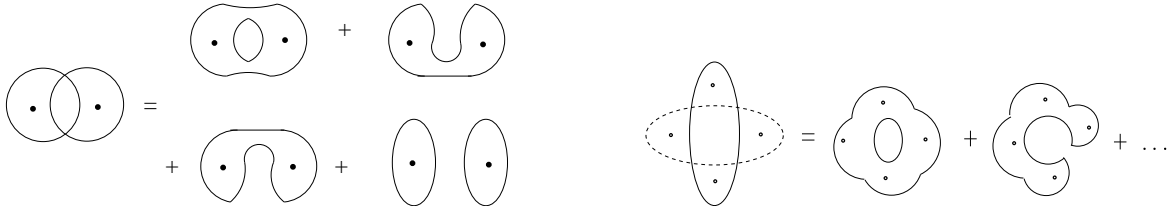

FIG. 12.2. — Skin relations producing contractible loops.

l , repeating this procedure one can express the pairing with any quasi-lamination by a linear combination of pairings with quasi-laminations without intersection points. Now to reduce the pairing to the pairing with a lamination we need to replace equivalent curves by a single curve with a multiplicity. Observe that $\text{tr}A^k = P_k(\text{tr}A)$, where P_k is the k -th Tchebychev polynomial. Furthermore, in the case of \mathcal{X} -laminations each simple contractible curve which might appear in the process contributes a factor -2 to the pairing. Indeed, lifting such a curve to the punctured tangent bundle of S we get a generator of the center of π_1 , so the trace of the monodromy of a twisted SL_2 -local system along it is -2 . Thus the sum obtained obviously has integral coefficients. The contractible curves are the only source of negative coefficients, so we have to show that, nevertheless, all coefficients are positive. For example, consider the skin relation shown on the left of Figure 12.2. Contracting the loop inside of the the first lamination on the right of the equality sign, we get the outer curve with the coefficient -2 , which cancels with the next two curves, which are isotopic to that curve. To prove the claim in general we may assume, without loss of generality, that our quasi-lamination has two components, and thus a simple contractible loop appears as a $2n$ -gon, $n \geq 1$, obtained by their intersection. Arguing as above (see the right picture on Figure 12.2) we see that contracting the loop we get a curve with coefficient $2n-2$. The property 5 of Theorem 12.2 for the \mathcal{X} -laminations is proved. The case of \mathcal{A} -laminations is similar but simpler: we do not have to worry about contractible loops. Theorem 12.2 is proved.

4. Conjectures. Let L be a set. Denote by $\mathbf{Z}_+\{L\}$ the abelian semi-group generated by L . Its elements are expressions $\sum_i n_i \{l_i\}$, where $l_i \geq 0$, the sum is finite, and $\{l_i\}$ is the generator corresponding to an element $l_i \in L$. Similarly denote by $\mathbf{Z}\{L\}$ the abelian group generated by L .

Let \mathcal{X} be a positive space. Recall from Section 4.3 the ring $\mathbf{L}[\mathcal{X}]$ of all good Laurent polynomials, the semiring $\mathbf{L}_+[\mathcal{X}]$ of positive good Laurent polynomials and the set of extremal elements $\mathbf{E}(\mathcal{X})$.

It follows from Definition 12.4 and Theorem 12.2 that the canonical multiplicative pairings provide canonical maps

$$\mathbf{I}_{\mathcal{A}}^+ : \mathbf{Z}_+ \{ \mathcal{A}_{SL_2, S}(\mathbf{Z}^t) \} \longrightarrow \mathbf{L}_+ [\mathcal{X}_{PSL_2, S}], \quad \mathbf{I}_{\mathcal{X}}^+ : \mathbf{Z}_+ \{ \mathcal{X}_{PSL_2, S}(\mathbf{Z}^t) \} \longrightarrow \mathbf{L}_+ [\mathcal{A}_{SL_2, S}], \quad (12.22)$$

and hence

$$\mathbf{I}_{\mathcal{A}} : \mathbf{Z} \{ \mathcal{A}_{SL_2, S}(\mathbf{Z}^t) \} \longrightarrow \mathbf{L} [\mathcal{X}_{PSL_2, S}], \quad \mathbf{I}_{\mathcal{X}} : \mathbf{Z} \{ \mathcal{X}_{PSL_2, S}(\mathbf{Z}^t) \} \longrightarrow \mathbf{L} [\mathcal{A}_{SL_2, S}], \quad (12.23)$$

which are multiplicative in the sense that property 4. of Definition 12.4 holds. Conjecturally the polynomials provided by laminations in both cases are *minimal*, i.e., any difference of such polynomials have at least one negative coefficient. Moreover, we conjecture the following.

12.2. Conjecture. — *The maps (12.22) and (12.23) are isomorphisms. They provide the isomorphisms*

$$\mathcal{A}_{SL_2, S}(\mathbf{Z}^t) = \mathbf{E}(\mathcal{X}_{PSL_2, S}), \quad \mathcal{X}_{PSL_2, S}(\mathbf{Z}^t) = \mathbf{E}(\mathcal{A}_{SL_2, S}).$$

In particular this means that, in both \mathcal{A} and \mathcal{X} cases, any good Laurent polynomial is a linear combination with integer coefficients of the images of the corresponding type laminations under the canonical map. For positive good Laurent polynomials all the coefficients are positive.

Observe that if G is simply-connected then the Langlands dual ${}^L G$ always has trivial center, so the corresponding moduli space $\mathcal{X}_{L_G, S}$ has the positive structure defined in Section 6.

12.3. Conjecture. — *Let G be a connected, simply-connected, split semi-simple algebraic group. Let S be an open surface. Then*

a) *There exist canonical additive pairings between the real lamination and Teichmüller spaces*

$$I : \mathcal{A}_{G, S}(\mathbf{R}^t) \times \mathcal{X}_{L_G, S}^+ \rightarrow \mathbf{R}, \quad I : \mathcal{X}_{L_G, S}(\mathbf{R}^t) \times \mathcal{A}_{G, S}^+ \rightarrow \mathbf{R},$$

as well as the intersection pairing between the real lamination spaces

$$\mathcal{I} : \mathcal{A}_{G, S}(\mathbf{R}^t) \times \mathcal{X}_{L_G, S}(\mathbf{R}^t) \rightarrow \mathbf{R}.$$

All of them are continuous.

b) *There exist canonical isomorphisms*

$$\mathbf{I}_{\mathcal{A}}^+ : \mathbf{Z}_+ \{ \mathcal{A}_{G, S}(\mathbf{Z}^t) \} \longrightarrow \mathbf{L}_+ [\mathcal{X}_{L_G, S}], \quad \mathbf{I}_{\mathcal{X}}^+ : \mathbf{Z}_+ \{ \mathcal{X}_{L_G, S}(\mathbf{Z}^t) \} \longrightarrow \mathbf{L}_+ [\mathcal{A}_{G, S}], \quad (12.24)$$

$$\mathbf{I}_A : \mathbf{Z}\{\mathcal{A}_{G,S}(\mathbf{Z}^t)\} \longrightarrow \mathbf{L}[\mathcal{X}_{L_{G,S}}], \quad \mathbf{I}_X : \mathbf{Z}\{\mathcal{X}_{L_{G,S}}(\mathbf{Z}^t)\} \longrightarrow \mathbf{L}[\mathcal{A}_{SL_2,S}]. \quad (12.25)$$

They provide the isomorphisms

$$\mathcal{A}_{G,S}(\mathbf{Z}^t) = \mathbf{E}(\mathcal{X}_{L_{G,S}}), \quad \mathcal{X}_{L_{G,S}}(\mathbf{Z}^t) = \mathbf{E}(\mathcal{A}_{G,S}).$$

Since ${}^L SL_2 = PSL_2$, Conjecture 12.3 reduces to Conjecture 12.2.

Quantum canonical map. We use notations from [FG2]. So $\mathcal{X}_{PSL_2,S}^q$ denotes the q -deformation of the moduli space $\mathcal{X}_{PSL_2,S}$, defined by gluing the quantum tori given by the generators X_i and relations

$$q^{-\varepsilon_{ij}} X_i X_j = q^{-\varepsilon_{ji}} X_j X_i.$$

12.4. Conjecture. — *There exists quantum canonical map*

$$\widehat{\mathbf{I}}^q : \mathcal{A}_{SL_2,S}(\mathbf{Z}^t) \longrightarrow \mathcal{X}_{PSL_2,S}^q.$$

So for any positive integral A -lamination l one can associate a Laurent polynomial $\widehat{\mathbf{I}}^q(l)$ of the variables X_1, \dots, X_n , satisfying the following properties:

1. $\widehat{\mathbf{I}}^1(l) = \mathbf{I}_A(l)$
2. The highest term of $\widehat{\mathbf{I}}^q(l)$ is $q^{-\sum_{i < j} \varepsilon_{ij} a_i a_j} \prod_i X_i^{a_i}$.
3. All coefficients of $\widehat{\mathbf{I}}^q(l)$ are positive Laurent polynomials of q .
4. Let $*$ be the canonical involutive antiautomorphism on the fraction field $\mathbf{Q}(\mathcal{X}_{PSL_2,S}^q)$. Then $*\widehat{\mathbf{I}}^q(l) = \widehat{\mathbf{I}}^q(l)$.
5. $\widehat{\mathbf{I}}^q(l_1)\widehat{\mathbf{I}}^q(l_2) = \sum_l c^q(l_1, l_2; l)\widehat{\mathbf{I}}^q(l)$, where the $c^q(l_1, l_2; l)$ are Laurent polynomials of q with positive integral coefficients and the sum is finite.

Of course, we expect a similar conjecture to be valid for an arbitrary G . The most general and precise conjectures are formulated in the setup of cluster ensembles, see Section 4 of [FG2]. We expect that the positive atlases defined in this paper provide the same rings of good positive Laurent polynomials as the ones provided by the cluster structure. Therefore the corresponding conjectures describe the same objects.

There exists a generalization of these conjectures where S is replaced by \widehat{S} . In the case of $G = SL_2$ the canonical pairings in this set up were defined in [FG4].

Finally, there is a (partial) generalisation of these conjectures when S is a closed surface. In this case the space of integral laminations for a group G with trivial center was defined in Section 6.9. We conjecture that

it parametrises a canonical basis on the quantum space $\mathcal{A}_{L_G,S}$: for a closed S the space $\mathcal{A}_{L_G,S}$ has a symplectic structure, and can be quantised. For $G = PGL_2$ we get Turaev's algebra.

5. Bases in the space of functions on moduli spaces which are parametrised by laminations. Recall that there are two versions of the spaces of \mathcal{A} -laminations:

$$\mathcal{A}_{SL_2,S}(\mathbf{Z}^t) \subset \mathcal{A}_L(S, \mathbf{Z}).$$

Let $\mathcal{O}(X)$ be the algebra of regular functions on a stack X . Below we prove the following result

12.3. Theorem. — (i) *The functions $\mathbf{I}_A(l)$, when $l \in \mathcal{A}_{SL_2,S}(\mathbf{Z}^t)$, provide a basis in $\mathcal{O}(\mathcal{X}_{PGL_2,S})$.*

(ii) *The functions $\mathbf{I}_A(l)$, when $l \in \mathcal{A}_L(S, \mathbf{Z})$, provide a basis in $\mathcal{O}(\mathcal{X}_{SL_2,S})$.*

Remark. The set $\mathcal{A}_L(S, \mathbf{Z})$ should be thought of as the space of integral PGL_2 \mathcal{A} -laminations: Indeed, it provides a basis on the space $\mathcal{X}_{SL_2,S}$.

Let us describe the stack of G -local systems on a graph for a reductive algebraic group G .

Let us start from an arbitrary group G . Let Γ be any graph. Recall the set $\mathcal{L}(G, \Gamma)$ of G -local systems on Γ , understood as local systems of right principal G -bundles. Let $E(\Gamma)$ be the set of all edges, and $V(\Gamma)$ the set of all vertices of Γ .

12.1. Lemma. — *Given an orientation Or of the graph Γ , there exists a natural bijection*

$$\kappa_{\text{Or}} : \mathcal{L}(G, \Gamma) \xrightarrow{\sim} G^{E(\Gamma)} / G^{V(\Gamma)}. \quad (12.26)$$

Proof. Let us define the right action of the group $G^{V(\Gamma)}$ on the set $G^{E(\Gamma)}$, which we use in (12.26). It is the only thing in (12.26) depending on an orientation of Γ . Let $(v_1(E), v_2(E))$ be vertices of the edge E , ordered according to the orientation of E . Then an element $\{g_v\} \in G^{V(\Gamma)}$, where $v \in V(\Gamma)$, acts on an element $\{g_E\} \in G^{E(\Gamma)}$, where $E \in E(\Gamma)$, by the formula

$$\{g_v\} * \{g_E\} = \{g'_E\}, \quad \text{where } g'_E = g_{v_2(E)}^{-1} g_E g_{v_1(E)} \quad (12.27)$$

Let \mathcal{L} be a G -local system on Γ . Let us trivialize its fibers at every vertex of Γ . Then the parallel transport along an oriented edge E of Γ is uniquely described by an element $g_E \in G$. The collection $\{g_E\}$ of these elements provides a point of $G^{E(\Gamma)}$. Changing trivializations at vertices amounts to the action (12.27) of the group $G^{V(\Gamma)}$. The lemma follows.

12.4.1. Corollary-Definition. — *Let G be an affine algebraic group. Then the space of regular functions on the stack $\mathcal{L}(G, \Gamma)$ is given by the space of $G^{V(\Gamma)}$ -invariants*

$$\mathcal{O}(\mathcal{L}(G, \Gamma)) = \left(\mathcal{O}(G)^{E(\Gamma)} \right)^{G^{V(\Gamma)}}. \tag{12.28}$$

Now let G be a reductive group. Let us work out a convenient description of the space (12.28). The Peter-Weyl theorem implies an isomorphism

$$\mathcal{O}(G) \xrightarrow{\sim} \bigoplus_{\lambda \in \widehat{G}} V_\lambda \otimes V_\lambda^*,$$

where the summation is over the set \widehat{G} of isomorphism classes of finite dimensional irreducible algebraic G -modules, and V_λ is a representation space corresponding to λ . Combining with (12.28), we get an isomorphism

$$\mathcal{O}(\mathcal{L}(G, \Gamma)) \xrightarrow{\sim} \left(\bigoplus_{\{\lambda: E(\Gamma) \rightarrow \widehat{G}\}} \bigotimes_{E \in E(\Gamma)} V_{\lambda(E)} \otimes V_{\lambda(E)}^* \right)^{G^{V(\Gamma)}},$$

where the summation is over the set of all functions $\lambda : E(\Gamma) \rightarrow \widehat{G}$.

Let us rewrite this formula using invariants of a tensor product over the set $F(\Gamma)$ of flags of Γ . Say that a \widehat{G} -coloring of Γ is a map $\lambda : F(\Gamma) \rightarrow \widehat{G}$ which has the following property: for every edge E of the graph it assigns contragradient representations to the two flags assigned to E .

We assign the factors of the product $V_{\lambda(E)} \otimes V_{\lambda(E)}^*$ to the two flags of the edge E , so that $V_{\lambda(E)}$ is assigned to the flag $(v_1(E), E)$, and $V_{\lambda(E)}^*$ to the flag $(v_2(E), E)$. Then we get an isomorphism

$$\mathcal{O}(\mathcal{L}(G, \Gamma)) \xrightarrow{\sim} \left(\bigoplus_{\lambda \in \{\widehat{G}\text{-colorings of } \Gamma\}} \bigotimes_{F \in F(\Gamma)} V_{\lambda(F)} \right)^{G^{V(\Gamma)}}. \tag{12.29}$$

Collecting the flags corresponding to a given vertex v of the graph, we get the desired formula

$$\mathcal{O}(\mathcal{L}(G, \Gamma)) \cong \bigoplus_{\lambda \in \{\widehat{G}\text{-colorings of } \Gamma\}} \bigotimes_{v \in V(\Gamma)} \left(\bigotimes_{\{E \rightarrow v\}} V_{\lambda(v, E)} \right)^G. \tag{12.30}$$

Here the set $\{E \rightarrow v\}$ consists of all edges of E incident to the given vertex v , and (v, E) means the flag at the vertex v corresponding to such edge E .

Our next step is to describe the space $\mathcal{O}(\mathcal{X}_{G,S})$ of regular functions on $\mathcal{X}_{G,S}$ as an $\mathcal{O}(\mathcal{L}_{G,S})$ -module. Let \tilde{G} be Grothendieck's simultaneous resolution of G . Then there are isomorphism of stacks $\tilde{G}/\text{Ad}G = H$ and $G/\text{Ad}G = H/W$.

Given a puncture p and an edge E surrounding this puncture, there is a map $G^{E(\Gamma)} \rightarrow G$ provided by the monodromy around the puncture, starting at E . Thus choosing edges for each of the n punctures we get a map $G^{E(\Gamma)} \rightarrow G^n$. Let $\mathcal{X}'_{G,S}$ be the fibered product in the following Cartesian diagram of varieties:

$$\begin{array}{ccc} \mathcal{X}'_{G,S} & \longrightarrow & \tilde{G}^n \\ \pi' \downarrow & & \downarrow \\ G^{E(\Gamma)} & \longrightarrow & G^n \end{array}$$

The group $G^{V(\Gamma)}$ acts on it, as explained in the proof of Lemma 12.1. Taking the quotient by the action of $G^{V(\Gamma)}$ we arrive at a Cartesian square of stacks, which is independent of the above choices:

$$\begin{array}{ccc} \mathcal{X}_{G,S} & \longrightarrow & H^n \\ \pi \downarrow & & \downarrow \\ \mathcal{L}_{G,S} & \longrightarrow & (H/W)^n \end{array}$$

It follows that

$$\mathcal{O}(\mathcal{X}_{G,S}) = \mathcal{O}(\mathcal{L}_{G,S}) \otimes_{\mathcal{O}((H/W)^n)} \mathcal{O}(H^n)$$

By Chevalley's theorem $\mathbf{Q}[H]$ is a free $\mathbf{Q}[H]^W$ -module with $|W|$ generators. Thus the space $\mathcal{O}(\mathcal{X}_{G,S})$ of regular functions on $\mathcal{X}_{G,S}$ is a free $\mathcal{O}(\mathcal{L}_{G,S})$ -module of rank $|W|^n$. A set of generators is obtained by pull backs of generators of the $\mathbf{Q}[(H/W)^n]$ -module $\mathbf{Q}[H]^n$.

Now let us assume that $G = SL_2$ and Γ is a trivalent graph homotopy equivalent to S .

Let $\mathcal{A}_L^0(S, \mathbf{Z}) \subset \mathcal{A}_L(S, \mathbf{Z})$ be the subset consisting of all integral \mathcal{A} -laminations such that the weights of all curves of the lamination, including the boundary curves, are positive integers. Given a loop α of a lamination l , we assign to it the weight n_α , which equals to the number of loops in l homotopic to α . So we write a lamination l as $l = \sum_\alpha n_\alpha \alpha$. Then $l \in \mathcal{A}_L^0(S, \mathbf{Z})$ if and only if $n_\alpha > 0$ for all α . Given such a lamination l , set

$$\mathbf{I}_A^0(l) := \prod_{\alpha} \text{Tr}(M_\alpha^{n_\alpha}) \in \mathcal{O}(\mathcal{L}_{SL_2,S}). \quad (12.31)$$

Here the product is over all isotopy classes of loops in l . Further, set

$$\mathcal{A}_{SL_2,S}^0(\mathbf{Z}^t) := \mathcal{A}_{SL_2,S}(\mathbf{Z}^t) \cap \mathcal{A}_L^0(S, \mathbf{Z}).$$

So we have $\mathcal{A}_{SL_2,S}^0(\mathbf{Z}^t) \subset \mathcal{A}_L^0(S, \mathbf{Z})$.

12.2. Proposition. — *The map \mathbf{I}_A^0 provides isomorphisms*

$$\mathbf{I}_A^0 : \mathbf{Q}\{\mathcal{A}_L^0(S, \mathbf{Z})\} \xrightarrow{\sim} \mathcal{O}(\mathcal{L}_{SL_2,S}); \quad \mathbf{I}_A^0 : \mathbf{Q}\{\mathcal{A}_{SL_2,S}^0(\mathbf{Z}^t)\} \xrightarrow{\sim} \mathcal{O}(\mathcal{L}_{PGL_2,S}).$$

In other words, the functions $\{\mathbf{I}_A^0(l)\}$, where $l \in \mathcal{A}_L^0(S, \mathbf{Z})$ (respectively $l \in \mathcal{A}_{SL_2,S}^0(\mathbf{Z}^t)$), form a basis of $\mathcal{O}(\mathcal{L}_{SL_2,S})$ (respectively $\mathcal{O}(\mathcal{L}_{PGL_2,S})$).

Proof. The list of all irreducible representations of SL_2 is given by the representations $V_{n/2}$ in the space of degree n polynomials in two variables, $n \geq 0$. One has $V_{n/2} = S^n V_{1/2}$. Recall that

$$\dim(V_a \otimes V_b \otimes V_c)^{SL_2} = \begin{cases} 1 & \text{if } a + b + c \in \mathbf{Z} \\ & \text{and } a, b, c \text{ satisfy the triangle inequalities,} \\ 0 & \text{otherwise.} \end{cases} \tag{12.32}$$

Recall that laminations $l \in \mathcal{A}_L^0(S, \mathbf{Z})$ are described by collections of non-negative half-integers $\{a_E\}$ on the edges of Γ , such that for every vertex the sum of the three numbers at the edges incident to the vertex is an integer, and these numbers satisfy the triangle inequalities. Such data gives rise to the following two different functions on the moduli space $\mathcal{L}_{G,S}$:

i) We assign to each edge E of Γ the irreducible representation V_{a_E} . Then thanks to the conditions on $\{a_E\}$ and (12.32), there is a unique (up to a scalar) invariant $S_{a,b,c}$ at every vertex. Taking the tensor product of these invariants, we get a function $S_{\{a_E\}}$. (Here S stands for ‘‘symmetric’’: $V_{n/2} = S^n V_{1/2}$).

ii) We assign to each edge E of Γ the reducible representation $\otimes^{2a_E} V_{1/2}$. Then given a triple of non-negative half-integers (a, b, c) satisfying the triangle inequalities, and with an integral sum, we define an invariant in the triple tensor product

$$\otimes^{2a} V_{1/2} \otimes \otimes^{2b} V_{1/2} \otimes \otimes^{2c} V_{1/2} \tag{12.33}$$

as follows. Let us draw an \mathcal{A} -lamination near the vertex v whose coordinates at the edges are $2a, 2b, 2c$. Let us assign a standard representation $V_{1/2}$ to both ends of each arc of the lamination. Then we assign to each arc of the lamination the invariant in the tensor product $V_{1/2} \otimes V_{1/2}$ of the two representations assigned to the ends of this arc. Then taking the tensor product we get an SL_2 -invariant $G_{a,b,c}$ in (12.33). Taking the tensor product of these invariants over all vertices of Γ , we get a function $T_{\{a_E\}}$ on the moduli space. (Here T stands for ‘‘tensor’’).

The functions $T_{\{a_E\}}$ are linear combinations of the $S_{\{a_E\}}$, and vice versa. Indeed, this follows from the fact that the invariants $\{T_{a,b,c}\}$ are linear combinations of the ones $\{S_{a,b,c}\}$, and vice versa. (In fact they are related by upper triangular transformations.) Since the functions $S_{\{a_E\}}$ form a basis in the space of functions on $\mathcal{L}_{G,S}$, the functions $T_{\{a_E\}}$ also form a basis.

The basis $T_{\{a_E\}}$ has a more geometric description, which does not rely on the graph Γ . Namely, given a set of half-integral coordinates $\{a_E\}$ on the edges of Γ , with an integral sum and satisfying the triangle inequalities, let us construct the corresponding \mathcal{A} -lamination l on S . Then we assign to each loop α of the resulting lamination the trace $\text{Tr}M_\alpha$ of the monodromy M_α of the local system around this loop, and take the product of obtained functions over all loops of the lamination. This way we get a yet another collection of functions $T'_{\{a_E\}}$.

The following lemma follows immediately from the definitions.

12.2. Lemma. — *The functions $T_{\{a_E\}}$ and $T'_{\{a_E\}}$ coincide, up to a non-zero scalar.*

Let us compare the previous construction with (12.31). It gives instead of the product of $\text{Tr}(M_\alpha^{n_\alpha})$ the product of $(\text{Tr}M_\alpha)^{n_\alpha}$. However since both the Laurent polynomials

$$(\lambda + \lambda^{-1})^n \quad \text{and} \quad \lambda^n + \lambda^{-n}, \quad n \in \mathbf{Z}_{\geq 0}$$

form a basis in the space of all Laurent polynomials in λ invariant under the involution $\lambda \mapsto \lambda^{-1}$, the functions $\mathbf{I}_{\mathcal{A}}^0(l)$ are linear combinations of the $T_{\{a_E\}}$ (and vice versa), and hence also form a basis.

In the case when $G = PGL_2$ the proof is similar. The only difference is that the list of irreducible representations of PGL_2 is given by the representations V_a , where $a \in \mathbf{Z}_{\geq 0}$, and thus in (12.32) we can drop the condition that $a + b + c \in \mathbf{Z}_{\geq 0}$. The proposition is proved.

Now we can complete the proof of Theorem 12.3. We start from claim i). We claim that the products of $\mathbf{I}_{\mathcal{A}}(\alpha_i)$ over some of the boundary components provide all generators of the $\mathcal{O}(\mathcal{L}_{PGL_2,S})$ -module $\mathcal{O}(\mathcal{X}_{PGL_2,S})$. Observe that $\mathbf{I}_{\mathcal{A}}^0(l)$ differs from $\mathbf{I}_{\mathcal{A}}(l)$ only in the treatment of boundary curves. Precisely, let α_i be the boundary loop for the i -th boundary component. Let λ_i be the monodromy around α_i restricted to the invariant one-dimensional subspace provided by the framing. Then $\mathbf{I}_{\mathcal{A}}(n\alpha_i) = \lambda_i^n + \lambda_i^{-n}$, while $\mathbf{I}_{\mathcal{A}}^0(n\alpha) = \lambda_i^n$. So the theorem is reduced to the following obvious claim: The space $\mathbf{Q}[\lambda, \lambda^{-1}]$ is a free $\mathbf{Q}[\lambda, \lambda^{-1}]^{\mathbf{Z}/2\mathbf{Z}}$ -module of rank two, with generators 1 and λ . Here the generator of $\mathbf{Z}/2\mathbf{Z}$ acts by $\lambda \mapsto \lambda^{-1}$.

The second claim of the theorem is proved in a completely similar way. The theorem is proved.

6. The action of the group $(\mathbf{Z}/2\mathbf{Z})^n$. This group acts by birational transformations on the moduli space $\mathcal{X}_{PGL_2,S}$. Its generator assigned to a boundary component p exchanges the two monodromy-invariant flags at p .

12.3. Lemma. — *The group $(\mathbf{Z}/2\mathbf{Z})^n$ acts on $\mathcal{X}_{PGL_2,S}$ by positive birational transformations.*

Proof. Let x_1, \dots, x_n be the coordinates at the edges entering a puncture p . The monodromy around p is given by $\prod_{i=1}^n \begin{pmatrix} x_i & 0 \\ 1 & 1 \end{pmatrix} = \begin{pmatrix} x_1 \dots x_n & 0 \\ c & 1 \end{pmatrix}$, where $c = 1 + x_n + x_n x_{n-1} + \dots + x_n \dots x_2$. The two eigenvectors of this matrix are $[0, 1]$ and $[\alpha, 1]$, where $\alpha = (x_1 \dots x_n - 1)/c$. We need to calculate how the \mathcal{X} -coordinates change when we alter the framing at p by switching the first eigenvector with the second.

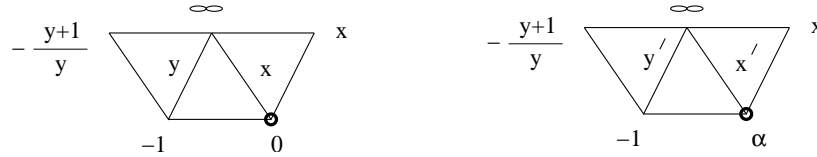

FIG. 12.3. — The action of $\mathbf{Z}/2\mathbf{Z}$ at a puncture (located at the fat vertex).

Observe that only the coordinates assigned to the edges of the triangles with a vertex at p may change. On Figure 12.3 $x := x_1$ and $y := y_1$, and at vertices shown the points on \mathbf{P}^1 corresponding to the flags at the punctures. An easy computation shows that

$$\begin{aligned}
 y'_1 &= (1 + \alpha)y_1 = \frac{(x_n + x_n x_{n-1} + \dots + x_n \dots x_1)y_1}{1 + x_n + x_n x_{n-1} + \dots + x_n \dots x_2} = \frac{[x_n, \dots, x_1]}{[1, x_n, x_{n-1}, \dots, x_2]}y_1, \\
 x'_1 &= \frac{\alpha - x_1}{-1 - \alpha} = \frac{cx_1 + 1 - x_1 \dots x_n}{c - 1 + x_1 \dots x_n} = \\
 &= \frac{1 + x_1 + x_1 x_n + \dots + x_1 x_n \dots x_3}{x_n + x_n x_{n-1} + \dots + x_n \dots x_1} = \frac{[1, x_1, x_n, \dots, x_3]}{[x_n, x_{n-1}, \dots, x_1]}
 \end{aligned}$$

where $[a_1, \dots, a_m] := a_1 + a_1 a_2 + \dots + a_1 \dots a_m$. The lemma is proved.

The rational action of the group $(\mathbf{Z}/2\mathbf{Z})^n$ on the moduli space $\mathcal{A}_{SL_2,S}$. Denote by $A_{a,b}$ the A -coordinate assigned to an edge connecting punctures a

and b . Let p be a puncture. The monodromy M_p around p is given by

$$M_p = \prod_{j=1}^q \begin{pmatrix} 1 & 0 \\ \frac{A_{j,j+1}}{A_{p,j}A_{p,j+1}} & 1 \end{pmatrix} = \begin{pmatrix} 1 & 0 \\ \alpha(p) & 1 \end{pmatrix}. \quad \alpha(p) := \sum_{j=1}^q \frac{A_{j,j+1}}{A_{p,j}A_{p,j+1}},$$

where the product is over the ordered set $\{1, \dots, j\}$ of all edges entering the puncture p , so that $\{(p, j, j + 1)\}$ is the set of triangles of the triangulation sharing p . It follows that $\alpha(p)$ does not depend on the choice of triangulation. Observe that $\alpha(p) = \langle M_p v'_p, v_p \rangle$, where v_p is the M_p -invariant vector defining a decoration at p , v'_p is a complementary vector, $\langle *, * \rangle$ the invariant area.

Let us define an involution σ_p of the \mathcal{A} -space. It acts by changing the decoration v_p at the puncture p by $v_p \mapsto \alpha(p)v_p$, leaving untouched the other decorations and the twisted local system. The map σ_p changes the invariant $\alpha(p)$ to its inverse: $\sigma_p^*(\alpha(p)) = \alpha(p)^{-1}$. It follows that $\sigma_p^2 = \text{Id}$. The involutions σ_p for different punctures commute, and thus give rise to an action of the group $(\mathbf{Z}/2\mathbf{Z})^n$ on the moduli space $\mathcal{A}_{SL_2,S}$. The projection of this action to the \mathcal{U} -space is trivial.

Here is a slightly different way to see this action. Given a puncture p , the canonical projection $p : \mathcal{A}_{SL_2,S} \rightarrow \mathcal{U}_{SL_2,S}$ has a 1 : 2 “section”. It is given by choosing a multiple \tilde{v}_p of v_p such that the corresponding invariant $\alpha(p)$ is 1. Such a vector \tilde{v}_p is well defined up to a sign. The group \mathbf{G}_m acts on $\mathcal{A}_{SL_2,S}$ by altering the decoration at p by $\lambda \tilde{v}_p \mapsto \lambda^{-1} \tilde{v}_p$.

Remarks. 1. For a point of $\mathcal{A}_{SL_2,S}(\mathbf{R}_{>0})$, the number $\alpha(p)$ is the area enclosed by the decorating horocycle at p .

2. If S has $n > 1$ holes, the group $(\mathbf{Z}/2\mathbf{Z})^n$ acts by cluster transformations. Indeed, given a hole p , we can find a trivalent graph Γ which has a virus subgraph whose circle encloses the hole. Then flip at the cricle is the cluster transformation providing the generator of $\mathbf{Z}/2\mathbf{Z}$ corresponding to p . If S has just one hole, changing the frame vector at this hole is not a cluster transformation.

A definition of the map $\mathbf{I}_{\mathcal{X}}$ for all \mathcal{X} -laminations. The group $(\mathbf{Z}/2\mathbf{Z})^n$ acts by positive birational transformations of both moduli spaces $\mathcal{A}_{SL_2,S}$ and $\mathcal{X}_{PGL_2,S}$. The tropicalization of this action provides an action of the group $(\mathbf{Z}/2\mathbf{Z})^n$ on the lamination spaces. In the \mathcal{X} -case (resp. \mathcal{A} -case) it coincides with the one given by changing orientations of the holes (changing the signs of the weights of the loops surrounding the holes - see (12.14)). The map $\mathbf{I}_{\mathcal{X}}$ was defined only for \mathcal{X} -laminations with the standard orientations of the boundary components. We extend it to all \mathcal{X} -laminations by imposing the equivariance with respect to the action of the group $(\mathbf{Z}/2\mathbf{Z})^n$. Since $\alpha(p)$ is a positive Laurent polynomial, its image consists of good positive Laurent

polynomials. It is straightforward that the other claims of Theorem 12.2 also remain valid for the extended map $\mathbf{I}_{\mathcal{X}}$.

Conclusion. Combining this with Theorems 12.2 and 12.3, we have defined the canonical maps $\mathbf{I}_{\mathcal{A}}$ and $\mathbf{I}_{\mathcal{X}}$ and proved that they satisfy all the desired properties but one: we do not know that laminations give rise to indecomposable elements.

13. Completions of Teichmüller spaces and canonical bases

1. Cyclic sets, laminations and cacti-sets. Let C be a cyclic set, perhaps infinite. A *simple lamination* l in C is a disjoint collection, perhaps infinite, of pairs of elements (c_i, c'_i) of C so that for any $i \neq j$ the order of the quadruple (c_i, c_j, c'_i, c'_j) is not compatible with the cyclic order of C . (If $C = S^1$, this just means that the chords (c_i, c'_i) and (c_j, c'_j) do not intersect).

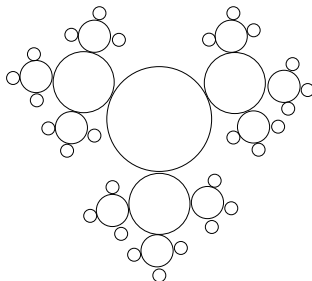

FIG. 13.1. — A cacti-set C/l .

Gluing every pair of points c_i, c'_i we get a set C/l . It no longer has a cyclic structure compatible with the projection $\pi : C \rightarrow C/l$. A subset M of C/l is *cyclic* if it has a cyclic structure such that the projection $\pi^{-1}M \rightarrow M$ is a map of cyclic sets. So a cyclic subset has a canonical cyclic structure inherited from C . Cyclic subsets are ordered by inclusion. The maximal elements are called the *maximal cyclic* subsets of C/l . The set C/l is a union of its maximal cyclic subsets; any two of them are either disjoint, or have a single element intersection. We call such sets *cacti-sets*.

Example. Let C be a circle. A simple lamination l in C is given by the endpoints of a collection of disjoint chords inside the circle. Shrinking all

chords to points we get a cacti-set C/l – see Figure 13.1. Its circles are the maximal cyclic subsets.

Let S be a surface, with or without boundary. A *simple lamination* on S is a finite collection of simple, non-contractible, mutually non-isotopic, and non-isotopic to boundary components, disjoint loops on S , considered modulo isotopy.

A simple lamination l on S gives rise to a simple lamination in the cyclic set $\mathcal{G}_\infty(S)$. Indeed, let \tilde{l} be the preimage of l in the universal cover \tilde{S} of S . The endpoints of \tilde{l} provide a lamination in the cyclic set $\mathcal{G}_\infty(S)$. Denote by $\mathcal{G}_\infty(S, l)$ the corresponding cacti-set. The connected components of $\tilde{S} - \tilde{l}$ are in bijection with maximal cyclic subsets of $\mathcal{G}_\infty(S, l)$.

2. The classical case. Let $\overline{\mathcal{M}}_{0, X}$ be the Knudsen-Deligne-Mumford moduli space of configurations of points on \mathbf{CP}^1 parametrised by a finite set X . An embedding of sets $X \subset X'$ gives rise to a canonical projection $\overline{\mathcal{M}}_{0, X'} \rightarrow \overline{\mathcal{M}}_{0, X}$ – forgetting the points parametrized by $X' - X$.

Let C be an infinite countable set. Set

$$\overline{\mathcal{M}}_{0, C} := \varprojlim \overline{\mathcal{M}}_{0, X}$$

where the projective limit is over finite subsets X of C , and the maps correspond to inclusions of finite sets. (If C is a finite set, we recover $\overline{\mathcal{M}}_{0, C}$).

Now let C be a cyclic set. Then $\mathcal{M}_{0, C}$ is equipped with a positive atlas, so there is its real positive part $\mathcal{M}_{0, C}^+$. Its closure in $\overline{\mathcal{M}}_{0, C}(\mathbf{R})$ is denoted $\overline{\mathcal{M}}_{0, C}^+$. The set $\overline{\mathcal{M}}_{0, C}^+$ has a decomposition (into “cells” of *a priori* infinite dimensions) parametrized by laminations in C .

Example. When C is a finite cyclic set, $\overline{\mathcal{M}}_{0, C}^+$ is (the closure of) the Stasheff polytope, with its natural cell decomposition parametrised by the laminations in C ([GM]).

The points of the Teichmüller space $\mathcal{X}_{PGL_2, S}^+$ are given by positive $\pi_1(S)$ -equivariant maps $\mathcal{G}_\infty(S) \rightarrow \mathbf{P}^1(\mathbf{R})$. Thus they are points of the moduli space $\mathcal{M}_{0, C}^+$ for $C = \mathcal{G}_\infty(S)$.

13.1. Definition. — *The set $\overline{\mathcal{X}}_{PGL_2, S}^+$ is the closure of $\mathcal{X}_{PGL_2, S}^+$ in $\overline{\mathcal{M}}_{0, C}$ for $C = \mathcal{G}_\infty(S)$.*

We need the following general definition. Given a simple lamination l on S , the boundary components of the curve $S - l$ correspond either to the loops of the lamination l , or to the boundary components of S . The former are called l -boundary components of $S - l$.

13.2. Definition. — *Let l be a simple lamination on S . The moduli space $\mathcal{X}_{G,S-l}^{\text{un}}$ parametrizes framed G -local systems on $S-l$ with unipotent monodromies around the l -boundary components of $S-l$. The moduli space $\mathcal{A}_{G,S-l}^{\text{un}}$ parametrizes twisted unipotent G -local systems on $S-l$ with decorations at those boundary components which are inherited from S .*

So $\mathcal{X}_{G,S-l}^{\text{un}}$ is the preimage of the identity element under the projection $\mathcal{X}_{G,S-l} \rightarrow H^k$, given by the semi-simple parts of the monodromies around the l -boundary components on $S-l$. The moduli space $\mathcal{A}_{G,S-l}^{\text{un}}$ is the quotient of $\mathcal{A}_{G,S-l}$ by the action of the group H^k provided by the l -boundary components on $S-l$. Therefore each of them carries an induced positive atlas, and thus there are the real positive parts $\mathcal{X}_{G,S-l}^{+, \text{un}}$ and $\mathcal{A}_{G,S-l}^{+, \text{un}}$.

13.1. Proposition. — *$\overline{\mathcal{X}}_{PGL_2,S}^+$ is a disjoint union of cells parametrised by simple laminations in S :*

$$\overline{\mathcal{X}}_{PGL_2,S}^+ = \coprod_l \mathcal{X}_{PGL_2,S-l}^{+, \text{un}}; \quad \text{where } l \text{ are simple laminations on } S.$$

An embedding of the right hand side to the left for any G is defined in Section 13.3.

Apparently the action of the mapping class group Γ_S extends to the closure $\overline{\mathcal{X}}_{PGL_2,S}^+$. The quotient $\overline{\mathcal{U}}_{PGL_2,S}^+/\Gamma_S$ is identified with the Knudsen-Deligne-Mumford moduli space $\overline{\mathcal{M}}_S$, usually denoted $\overline{\mathcal{M}}_{g,n}$, where g is the genus of \overline{S} and n is the number of punctures on S .

3. Completions of higher Teichmüller spaces. Recall that a positive configuration of flags parametrised by a cyclic set C is the same thing as a positive map $C \rightarrow \mathcal{B}(\mathbf{R})$ modulo $G(\mathbf{R})$ -conjugation. Recall the canonical projection $\pi : \mathcal{G}_\infty(S) \rightarrow \mathcal{G}_\infty(S, l)$.

13.3. Definition. — *Let C and C' be cyclic sets related by a surjective map of cyclic sets $\pi : C \rightarrow C'$.*

A sequence $\{\psi_n\}$ of positive configurations of flags parametrised by C is convergent to a positive configuration ψ parametrised by C' if there are maps $\tilde{\psi}_n : C \rightarrow \mathcal{B}(\mathbf{R})$ representing configurations ψ_n such that the limit $\tilde{\psi} := \lim_{n \rightarrow \infty} \tilde{\psi}_n$ exists, factors through C' , i.e. $\tilde{\psi}(c_i) = \tilde{\psi}(c'_i)$ if $\pi(c_i) = \pi(c'_i)$, and the induced map $\tilde{\psi} : C' \rightarrow \mathcal{B}(\mathbf{R})$ represents the configuration ψ .

13.4. Definition. — *A sequence of points $\psi_n \in \mathcal{X}_{G,S}^+$ is convergent if there exists a simple lamination l on S such that for every maximal cyclic*

subset μ of $\mathcal{G}_\infty(S, l)$ the sequence of positive configurations

$$\psi_n^\mu : \pi^{-1}(\mu) \longrightarrow \mathcal{B}(\mathbf{R}), \quad (13.1)$$

obtained by restrictions of ψ_n 's to $\pi^{-1}(\mu)$, is convergent to a positive configuration $\psi^\mu : \mu \longrightarrow \mathcal{B}(\mathbf{R})$.

Since the maps (13.1) correspond to points of $\mathcal{X}_{G,S}^+$, they are $\pi_1(S)$ -equivariant. Therefore the limiting map ψ^μ is $\pi_1(S_\mu)$ -equivariant, where S_μ is the component of $S - l$ corresponding to μ .

Recall that there exists a unique regular unipotent conjugacy class in $G(\mathbf{R})$: it is given by the maximal Jordan block for $G = PGL_n$.

13.1. Lemma. — *The monodromy of the local system on S_μ corresponding to ψ^μ around an l -boundary component is regular unipotent.*

Proof. The monodromy M around a boundary component is conjugate to an element of $B(\mathbf{R}_{>0})$. Since the canonical flags corresponding to M and M^{-1} coincide, M is unipotent. Any element of $U(\mathbf{R}_{>0})$ is regular. The Lemma is proved.

Lemma 13.1 implies that a convergent sequence of points $\psi_n \in \mathcal{X}_{G,S}^+$ corresponds to a point of the space $\mathcal{X}_{G,S-l}^{+,un}$, for a certain simple lamination l on S , which we view as its limit. The gluing from Section 7 shows that we can get any point of $\mathcal{X}_{G,S-l}^{+,un}$. Similar questions for the \mathcal{A} -spaces are reduced to the ones for the \mathcal{X} -spaces. So we arrive at the following definition.

13.5. Definition. — *Each of the sets $\mathcal{B}(\mathcal{X}_{G,S}^+)$ and $\mathcal{B}(\mathcal{A}_{G,S}^+)$ is a disjoint unions of cells, which are parametrised by simple laminations l in S :*

$$\mathcal{B}(\mathcal{X}_{G,S}^+) = \coprod_l \mathcal{X}_{G,S-l}^{+,un}; \quad \mathcal{B}(\mathcal{A}_{G,S}^+) = \coprod_l \mathcal{A}_{G,S-l}^{+,un}$$

where l are simple laminations on S .

The topology on these sets is provided by Definition 13.4. The obtained topological space are called completions of the higher Teichmüller spaces $\mathcal{X}_{G,S}^+$ and $\mathcal{A}_{G,S}^+$.

We use here a different notation, comparing to Definition 13.1, to emphasize that for $G \neq PGL_2$ we do not know whether the space $\mathcal{B}(\mathcal{X}_{G,S}^+)$ is the closure of the space $\mathcal{X}_{G,S}^+$ in any sense.

Here is how one should define a full completion of the higher Teichmüller space for a group G different from PSL_2 . One should be able to

define a natural compactification $\overline{\text{Conf}}_n(\mathcal{B})$ of the space of configurations of n flags in generic position, so that for $G = PSL_2$ we recover the moduli space $\overline{\mathcal{M}}_{0,n}$. Then we would define a completion of the space $\mathcal{L}_{G,S}^+$ as the closure $\overline{\text{Conf}}_{\mathcal{G}_\infty(S),\pi_1(S)}^+(\mathcal{B})$ of the positive $\pi_1(S)$ -equivariant configuration space $\text{Conf}_{\mathcal{G}_\infty(S),\pi_1(S)}^+(\mathcal{B})$ in the above compactification.

4. The canonical map for closed surfaces, and its behavior at the boundary. For a closed surface S the moduli space $\mathcal{A}_{G,S}$ is isomorphic to the moduli space of G -local systems on S , although this isomorphism is non-canonical if $s_G \neq e$. So it has a canonical symplectic structure. When G has trivial center, the set $\mathcal{X}_{G,S}(\mathbf{Z}^t)$ was defined in Section 6.9.

13.1. Conjecture. — *Let S be a surface without boundary. Assume that G has trivial center. Then there exists a canonical map*

$$\mathbf{I} : \mathcal{X}_{G,S}(\mathbf{Z}^t) \longrightarrow \mathcal{O}(\mathcal{A}_{L_{G,S}}). \tag{13.2}$$

Its image is a basis of $\mathcal{O}(\mathcal{A}_{L_{G,S}})$. The map (13.2) has a quantum deformation.

We conjecture that the canonical map (13.2) behaves nicely at the boundary of the moduli space $\mathcal{A}_{L_{G,S}}$, and this requirement determines it uniquely. Let us formulate this precisely.

Recall the embedding

$$\beta_l : \mathcal{A}_{G,S-l}^{+,un} \hookrightarrow \mathcal{B}(\mathcal{A}_{G,S}^+) \tag{13.3}$$

Let $\mathcal{O}_l(\mathcal{A}_{G,S})$ be the subspace of functions which have limit at the component (13.3). So by the very definition there is a restriction map

$$R_l : \mathcal{O}_l(\mathcal{A}_{L_{G,S}}) \longrightarrow \mathcal{O}(\mathcal{A}_{L_{G,S-l}}^{un}) \tag{13.4}$$

The space on the right should carry a canonical basis: the Duality Conjecture for the surface $S - l$ implies that there should be a canonical map

$$\mathcal{X}_{G,S-l}^{un}(\mathbf{Z}^t) \longrightarrow \mathcal{O}(\mathcal{A}_{L_{G,S-l}}^{un}). \tag{13.5}$$

Indeed, the canonical map $\mathbf{I}_\mathcal{X} : \mathcal{X}_{G,S-l}(\mathbf{Z}^t) \longrightarrow \mathcal{O}(\mathcal{A}_{L_{G,S-l}})$ should have the following property: if $x \in \mathcal{X}_{G,S-l}(\mathbf{Z}^t)$, and $y \in H^k(\mathbf{Z}^t)$ is its image under the map provided by the projection $\mathcal{X}_{G,S-l} \rightarrow H^k$, then the function $\mathbf{I}_\mathcal{X}(x)$ transforms under the action of the dual torus ${}^L H^k$ by the character χ_y corresponding to y . Thus the functions corresponding to points of the subset $\mathcal{X}_{G,S-l}^{un}(\mathbf{Z}^t)$

should be invariant under the action of ${}^L H^k$. So the map $\mathbf{I}_\mathcal{X}$ should restrict to the map (13.5).

Let V be a vector space with a given basis \mathbf{B} , V_0 a subspace of V , and $r : V_0 \rightarrow W$ a surjective linear map. We say that the basis \mathbf{B} restricts under the map r to a basis in W if:

- (i) The basis elements which lie inside of V_0 generate V_0 , i.e. provide a basis \mathbf{B}_0 in V_0 .
- (ii) Let \mathbf{B}'_0 be the subset of the basis \mathbf{B}_0 consisting of the elements which are not killed by r . Then $r(\mathbf{B}'_0)$ is a basis in W .

13.2. Conjecture. — *Let S be a surface without boundary. Then, for any simple lamination l on S , the restriction map R_l is surjective, and the canonical basis (13.2) in $\mathcal{O}(\mathcal{A}_{L_G,S})$ restricts under the map R_l to the canonical basis in $\mathcal{O}(\mathcal{A}_{L_G,S-l}^{\text{un}})$.*

In other words, for any simple lamination l on S , we should have a commutative diagram

$$\begin{array}{ccc} \mathcal{X}_{G,S}^{\perp l}(\mathbf{Z}^t) & \longrightarrow & \mathcal{O}_l(\mathcal{A}_{L_G,S}) \\ \downarrow & & \downarrow R_l \\ \mathcal{X}_{G,S-l}^{\text{un}}(\mathbf{Z}^t) & \longrightarrow & \mathcal{O}(\mathcal{A}_{L_G,S-l}^{\text{un}}) \end{array} \quad (13.6)$$

Here the bottom arrow is the map (13.5). The top arrow is given by the restriction of the map \mathbf{I} .

The canonical maps for closed surfaces should be uniquely determined by Conjecture 13.2 and the canonical maps for surfaces with boundary.

Example. Conjectures 13.1 and 13.2 are valid for $G = PGL_2$. Indeed, in this case the set $\mathcal{X}_{G,S}(\mathbf{Z}^t)$ coincides with the set of integral laminations on S , i.e. collections of simple disjoint curves with positive integral weights on S , considered modulo isotopy. The canonical map assigns to a lamination $\sum_i n_i \{\alpha_i\}$ the function $\prod_i \text{Tr} M_{\tilde{\alpha}_i}^{n_i}$ on the moduli space $\mathcal{A}_{SL_2,S}$ of twisted SL_2 -local systems on S . Here $\tilde{\alpha}_i$ is the lift of the loop α_i to the punctured tangent bundle of S . The quantum version of this map is nothing else but the Turaev algebra of S . The subset $\mathcal{X}_{G,S}^{\perp l}(\mathbf{Z}^t)$ consist of the laminations with the zero intersection index with l . The left vertical map in (13.6) kills the lamination l . So in this case the diagram (13.6) is well-defined and commutative.

14. Positive coordinate systems for \mathcal{X} -laminations

By Lemma 12.3, the group $(\mathbf{Z}/2\mathbf{Z})^n$ acts by positive birational transformations on the moduli space $\mathcal{X}_{PGL_2, S}$. We extend the positive atlas on $\mathcal{X}_{PGL_2, S}$ by adding coordinate systems obtained from the standard ones by the action of $(\mathbf{Z}/2\mathbf{Z})^n$.

1. Positive coordinate systems: definitions and the main result.

Let \mathcal{C}_S be the set of pairs (an ideal triangulation of S considered modulo isotopy, a choice of orientations of boundaries of all holes of S). The direct product of the mapping class group of S and the group $(\mathbf{Z}/2\mathbf{Z})^n$ acts naturally on the set \mathcal{C}_S . The coordinate systems on the space of \mathcal{X} -laminations on S are parametrized by the set \mathcal{C}_S . So there are 2^n coordinate systems corresponding to an ideal triangulation of S .

14.1. Definition. — *Let l be an \mathcal{X} -lamination on S . A coordinate system corresponding to an ideal triangulation of S is positive (non-negative) for the lamination l , if all coordinates of l in this coordinate system are > 0 (respectively ≥ 0).*

14.1. Theorem. — *a) There exists a dense (resp. dense open) subset in the set of all real \mathcal{X} -laminations on S such that every lamination from it admits a non-negative (resp. positive) coordinate system.*

b) Let T be an ideal triangulation of S corresponding to a non-negative coordinate system for a finite real \mathcal{X} -lamination l . Then the isotopy class of the collection of edges of T with > 0 coordinates is isotopic to l , and hence uniquely determined by l .

c) A positive coordinate system for an \mathcal{X} -lamination is unique if exists.

To get the part a) of Theorem 14.1 we need the following result: for a generic real \mathcal{X} -lamination all curves of the lamination go between the punctures. For this we use some results from the theory of Morse-Smale foliations.

2. Morse-Smale foliations and real laminations. Let us recall the notion of a Morse-Smale foliation on S and some results about them.

Given a foliation on a punctured disc, the *winding number* of the foliation at the puncture is an integer given by the rotation number of the fibers of the foliation restricted to a small circle near the puncture. For example the radial foliation has the winding number $+1$, and the foliation tangent to the family of concentric circles also has the winding number $+1$.

Let S be a surface with holes. A *Morse-Smale foliation* on S is a foliation \mathcal{F} on S minus a finite number of points, called singular points of the foliation, with the following structures/properties:

- i) \mathcal{F} is equipped with a real transversal measure.
- ii) The fibers of \mathcal{F} are transversal to the boundary of S .
- iii) The winding number of the foliation at each singular point is < 0 .

A fiber of a Morse-Smale foliation on S is *singular* if it ends at a singular point of the foliation. The condition iii) implies that the number of singular fibers of a Morse-Smale foliation ending in a singular point is finite. The condition ii) easily implies that a Morse-Smale foliation does not have fibers contractible onto the boundary.

14.1. Lemma. — *The number of homotopy types of the leaves of a Morse-Smale foliation going between the boundary components is finite.*

Proof. The above remarks show that we may assume that the fibers can not be contracted to the boundary. Cutting the surface along a non-singular leaf going between the boundary components we decrease either the number of holes, or the genus. The lemma follows.

We need the following result.

14.2. Theorem. — *There exists an open dense domain $U_{MS}(S)$ in the space of all Morse-Smale foliations on S such that every non-singular curve of a foliation from this domain joins two boundary components.*

Now let us replace the homotopic non-singular fibers of a Morse-Smale foliation \mathcal{F} by a single curve with the weight provided by the transversal measure. According to a well known theorem of Thurston, this way we get a bijection between the Morse-Smale foliations on S modulo isotopy and Thurston's \mathbf{R} -laminations: every \mathbf{R} -lamination is representable as a Morse-Smale foliation on S , and this representation is unique up to an isotopy. It follows from Lemma 14.1 that if \mathcal{F} was from the set $U_{MS}(S)$, we will get a Thurston \mathbf{R} -lamination $l_{\mathcal{F}}$ with a finite number of curves.

3. Proof of Theorem 14.1. Obviously c) is a particular case of b). Moreover, clearly in b) not only the set of the edges of T carrying positive coordinates, but also the set of the orientations of the holes serving as the endpoints of these edges is determined by l .

a) We will assume without loss of generality that an \mathcal{X} -lamination l is defined using the orientations of the holes induced by the orientation of the

surface S . The general case is reduced to this using the action of the group $(\mathbf{Z}/2\mathbf{Z})^n$ changing orientations of the holes.

A real \mathcal{X} -lamination is called *finite* if it can be presented by a finite collection l of mutually and self non-intersecting curves with real weights on them. Recall that to get an \mathcal{X} -lamination out of such a collection of curves with real weights l we have to choose in addition orientations of all holes. As we already said, we do it by taking the orientations induced by the orientation of the surface S , getting an \mathcal{X} -lamination l^+ . To define the \mathcal{X} -coordinates of the finite \mathcal{X} -lamination l^+ we have to perform the following procedure at every hole of S : we replace a segment of the lamination going to the hole by a ray winding infinitely many times around the puncture in the direction prescribed by the orientation of S , and then retract the winded lamination to a trivalent graph on S .

Let us call finite real \mathcal{X} -laminations such that every leaf of the lamination joins two boundary component *special real \mathcal{X} -laminations*. Theorem 14.2 and Lemma 14.1 imply that the space of special finite real \mathcal{X} -laminations is an open dense subset in the space of real \mathcal{X} -laminations on S .

Now, given a special \mathcal{X} -lamination l^+ , let us exhibit a non-negative triangulation of S for it. The curves of the finite lamination l provide a decomposition D_l of S . Adding a finite number of curves to this decomposition we obtain a triangulation T of S containing the decomposition D_l . Let Γ be the dual graph for this triangulation. We claim that it provides a non-negative coordinate system for the \mathcal{X} -lamination l^+ : all coordinates assigned to the edges of D_l are > 0 , while the rest of the coordinates are equal to zero. Indeed, a curve of the lamination, being retracted onto the graph Γ , will cross only one edge of Γ , the one dual to the edge of the triangulation T given by this curve. Figure 14.1 illustrates this claim, by showing the winding procedure for a curve of the lamination on S traveling between the holes. The part a) of the theorem is proved.



FIG. 14.1. — Calculating a coordinate of an \mathcal{X} -lamination assigned to an edge of the dual graph.

b) Given a special real \mathcal{X} -lamination l , there is the following correspondence

$$\mathcal{I}_l \subset \{\text{edges of } \Gamma\} \times \{\text{connected components of the lamination } l\}. \quad (14.1)$$

Namely, a pair (an edge e of Γ , a connected component α of l) belongs to \mathcal{I}_l if and only if there exists a part of α which goes diagonally along the

edge e . Let us denote by π_2 the natural projection of the correspondence \mathcal{I}_l to the second factor in (14.1):

$$\pi_2 : \mathcal{I}_l \longrightarrow \{\text{connected components of the lamination } l\}.$$

14.2. Lemma. — *Let l be a special real \mathcal{X} -lamination on S . Then:*

- a) *The map π_2 is surjective.*
- b) *If $\pi_2^{-1}(\alpha)$ is a single edge e , then this edge is isotopic to an edge of the dual triangulation T .*
- c) *If all coordinates of l are ≥ 0 , then the map π_2 is injective.*

Proof. a) Take a connected component β of l which is not in the image of π_2 . This means that there is no edge of Γ such that β goes diagonally along this edge. Thus β can be shrunk into the boundary of a hole. Indeed, β either turns to the right at every edge of Γ , or it turns to the left at every edge of Γ , and thus it is isotopic to a curve which does not intersect Γ .

b) If $\pi_2^{-1}(\alpha) = e$, then α is homotopic to a curve which intersects Γ just once. Indeed, it either goes to the left before e and to the right after e , or to the right before and to the left after e . The claim follows from this.

c) Assume the opposite. Then there is a connected component α of l such that $|\pi_2^{-1}(\alpha)| > 1$. But this is impossible: after the curve α crossed diagonally the first edge on its way, it can not cross the other edge since all its coordinates are ≥ 0 . The lemma is proved.

14.1. Corollary. — *Let l be a special real \mathcal{X} -lamination on S . Suppose that all coordinates of l in the coordinate system corresponding to an ideal triangulation T are ≥ 0 . Then the set of the edges of T which carry > 0 coordinates of l is isotopic to the lamination l .*

Proof. Follows immediately from the parts b) and c) of Lemma 14.2.

The part b) of the theorem is an immediate consequence of Corollary 14.1. The theorem is proved.

14.2. Corollary. — *a) Any rational \mathcal{X} -lamination without loops admits a non-negative coordinate system.*

b) The set of rational \mathcal{X} -laminations without loops is dense in the space $\mathcal{X}_L(S; \mathbf{Q})$ of all rational \mathcal{X} -laminations.

Proof. a) It has been proved during the proof of Theorem 14.1.

b) The intersection of the domain described in Theorem 14.1 with the space of all rational \mathcal{X} -laminations is described as the set of the ones without closed loops. The corollary is proved.

So a little perturbation destroys loops in a lamination.

It is tempting to avoid the use of the Morse-Smale theory in the proof, making the proof self-contained. Here is perhaps a first step in this direction.

14.3. Lemma. — *Let l be a real \mathcal{X} -lamination and α be a closed leaf of it. Take any 3-valent graph and let now x_i be the coordinates of l and a_i be the coordinates of α considered as an \mathcal{A} -lamination. Then $\sum_i x_i a_i = 0$.*

Proof. The intersection pairing of α with l equals zero. On the other hand it is computed by the formula $\sum_i x_i a_i$. The lemma is proved.

This lemma implies that, since all a_i 's are integers, if all x_i 's are linearly independent over \mathbf{Q} , there are no closed curves. However this does not prove yet that for a generic real \mathcal{X} -lamination all curves of the lamination go between the punctures: we have to take care of the non-closed curves winding inside of S .

4. An application to the canonical map $\mathbf{I}_{\mathcal{X}}$. It follows from the part a) of Corollary 14.2 that the restriction of the canonical map $\mathbf{I}_{\mathcal{X}}$ to the integral laminations without loops is especially simple. Namely, given such a lamination l , in every non-negative coordinate system for l the element $\mathbf{I}_{\mathcal{X}}(l)$ is given by a product of the coordinate functions in this coordinate system. So $\mathbf{I}_{\mathcal{X}}(l)$ is in the cluster algebra corresponding to the space $\mathcal{A}_{SL_2, S}$. The image of laminations containing loops does not belong to it.

15. A Weil–Petersson form on $\mathcal{A}_{G, \hat{S}}$ and its motivic avatar

1. The K_2 -invariant of a G -local system on a compact surface.

Let S be a compact smooth oriented surface of genus $g > 1$. A representation $\rho : \pi_1(S, x) \rightarrow G(F)$ of $\pi_1(S, x)$ to the group of F -points of a reductive group G induces a map of the classifying spaces $\rho_B : B\pi_1(S, x) \rightarrow BG(F)$. Since S is a $K(\pi_1(S, x))$ -space, applying the functor H_2 we get a map

$$\rho_* : H_2(S) = H_2(B\pi_1(S, x)) \longrightarrow H_2BG(F) = H_2G(F).$$

According to the stabilization theorem [Sus], the natural map $H_2GL_2(F) \rightarrow H_2GL_n(F)$ is an isomorphism for any infinite field F provided $n \geq 2$. There is a natural map $H_2GL_2(F) \rightarrow K_2(F)$ (see e.g. loc. cit.). Thus if $n \geq 2$ there is a map $\pi_n : H_2GL_n(F) \rightarrow K_2(F)$. A finite dimensional representation V of G provides a map $BG \rightarrow BGL(V)$. Composing it with $\pi_{\dim V}$ we get a homomorphism $\pi_{G, V} : H_2G(F) \rightarrow K_2(F)$. Let $\pi_G : H_2G(F) \rightarrow K_2(F)$ be the

homomorphism corresponding to the adjoint representation of G . Composing it with ρ_* we get a map $\pi_G \circ \rho_* : H_2(S) \longrightarrow K_2(F)$. Let $[S] \in H_2(S)$ be the fundamental class of S .

15.1. Definition. — *Let G be a split reductive group and F is a field. The K_2 -invariant $w_\rho \in K_2(F)$ of a representation $\rho : \pi_1(S) \rightarrow G(F)$ is the element $\pi_G \circ \rho_*([S]) \in K_2(F)$.*

Since the mapping class group Γ_S preserves the fundamental class of S , w_ρ is invariant under the action of Γ_S , i.e. $w_{g\rho} = w_\rho$ for $g \in \Gamma_S$.

Applying this to the field \mathbf{F} of rational functions on the moduli space $\mathcal{L}_{G,S}$ and the corresponding tautological representation $\pi_1(S, x) \rightarrow G(\mathbf{F})$ we get a Γ_S -invariant class $W_{G,S} \in K_2(\mathbf{F})$. The restriction of this class to any point $\rho \in \mathcal{L}_{G,S}$ is the class w_ρ . Therefore the class $W_{G,S}$ is regular on $\mathcal{L}_{G,S}$, i.e. provides an element

$$W_{G,S} \in H^2(\mathcal{L}_{G,S}, \mathbf{Q}_{\mathcal{M}}(2))^{\Gamma_S} \subset K_2(\mathbf{F})^{\Gamma_S}.$$

Applying to it the map $d \log$ we get a regular 2-form $\Omega_{G,S}$ on $\mathcal{L}_{G,S}$.

2. The weight two motivic complex. Let F be a field. Recall the Bloch complex: of F

$$\delta : B_2(F) \longrightarrow \Lambda^2 F^*; \quad B_2(F) := \frac{\mathbf{Z}[F^*]}{R_2(F)}.$$

The subgroup $R_2(F)$ is generated by the elements

$$\sum_{i=1}^5 (-1)^i \{r(x_1, \dots, \widehat{x}_i, \dots, x_5)\}, \quad x_i \in P^1(F), \quad x_i \neq x_j.$$

where $\{x\}$ is the generator of $\mathbf{Z}[F^*]$ corresponding to $x \in F^*$. Let $\{x\}_2$ be the projection of $\{x\}$ to $B_2(F)$. Then $\delta\{x\}_2 := (1-x) \wedge x$. One has $\delta(R_2(F)) = 0$ (see [G1]).

Let X_k be the set of all codimension k irreducible subvarieties of X . The weight two motivic complex $\Gamma(X; 2)$ of a regular irreducible variety X with the field of functions $\mathbf{Q}(X)$ is the following cohomological complex

$$\Gamma(X; 2) := B_2(\mathbf{Q}(X)) \xrightarrow{\delta} \Lambda^2 \mathbf{Q}(X)^* \xrightarrow{\text{Res}} \prod_{Y \in X_1} \mathbf{Q}(Y)^* \xrightarrow{\text{div}} \prod_{Y \in X_2} \mathbf{Z} \quad (15.1)$$

where the first group is in the degree 1 and Res is the tame symbol map (1.24). If $Y \in X_1$ is normal, the last map is given by the divisor $\text{div}(f)$ of

f . In Y is not normal, we take its normalization \tilde{Y} , compute $\text{div}(f)$ on \tilde{Y} , and then push it down to Y .

3. The second motivic Chern class. According to Milnor the universal G -bundle over the classifying space for an algebraic group G can be thought of as the following (semi)simplicial variety EG_\bullet :

$$\rightrightarrows G^4 \rightrightarrows G^3 \rightrightarrows G^2 \rightrightarrows G.$$

The group G acts diagonally from the left on EG_\bullet , and the quotient BG_\bullet is a simplicial model for the classifying space of G . The simplicial structure includes the maps

$$s_i^n : G^n \longrightarrow G^{n-1}; \quad (g_1, \dots, g_n) \longmapsto (g_1, \dots, \widehat{g}_i, \dots, g_n).$$

Let $\mathcal{F}^\bullet(X)$ be a complex of sheaves on X which depends functorially on X for smooth projections. The hypercohomology $H^*(BG_\bullet, \mathcal{F}^\bullet)$ are the cohomology of the total complex associated with the bicomplex:

$$\begin{array}{cccccccc} & \dots & & \dots & & \dots & & \dots \\ & \uparrow & & \uparrow & & \uparrow & & \uparrow \\ \xleftarrow{d} & \mathcal{F}^3(G^3) & \xleftarrow{d} & \mathcal{F}^3(G^2) & \xleftarrow{d} & \mathcal{F}^3(G) & \xleftarrow{d} & \mathcal{F}^3(*) \\ & \uparrow & & \uparrow & & \uparrow & & \uparrow \\ \xleftarrow{d} & \mathcal{F}^2(G^3) & \xleftarrow{d} & \mathcal{F}^2(G^2) & \xleftarrow{d} & \mathcal{F}^2(G) & \xleftarrow{d} & \mathcal{F}^2(*) \\ & \uparrow & & \uparrow & & \uparrow & & \uparrow \\ \xleftarrow{d} & \mathcal{F}^1(G^3) & \xleftarrow{d} & \mathcal{F}^1(G^2) & \xleftarrow{d} & \mathcal{F}^1(G) & \xleftarrow{d} & \mathcal{F}^1(*) \end{array}$$

The differential $d : \mathcal{F}^*(G \setminus G^{n-1}) \longrightarrow \mathcal{F}^*(G \setminus G^n)$ is defined by

$$d := \sum_{i=1}^n (-1)^{i-1} (s_i^n)^*.$$

So $H^n(BG_\bullet, \mathcal{F}^\bullet)$ is represented by cocycles in $\bigoplus_{p+q=n} \mathcal{F}^p(G^q)$.

It is well known that

$$H^*(BG_\bullet, \mathbf{Q}_{\mathcal{M}}(2)) = H^*(BG_\bullet, \Gamma(X; 2) \otimes \mathbf{Q})$$

where the right hand side is computed via the bicomplex above. Moreover, it is known that if $* = 4$, this \mathbf{Q} -vector space can be identified with the one of G -invariant quadratic forms on the Lie algebra of G . In particular the Killing form provides a distinguished cohomology class

$$c_{2,G}^{\mathcal{M}} = c_2^{\mathcal{M}} \in H^4(BG_\bullet, \mathbf{Q}_{\mathcal{M}}(2)). \tag{15.2}$$

A cocycle representing the class $c_2^{\mathcal{M}}$ is given by the following data:

$$C_4 \in B_2(\mathbf{Q}(G^4)^*)^G, \quad C_3 \in \left(\Lambda^2 \mathbf{Q}(G^3)^*\right)^G, \quad C_2 \in \left(\prod_{Y \in (G^2)_1} \mathbf{Q}(Y)^*\right)^G. \quad (15.3)$$

15.1. Lemma. — *There exists a cocycle $C_\bullet^U = (C_4^U, C_3^U, C_2^U)$ with $C_2^U = 0$ representing the class $c_2^{\mathcal{M}}$ such that its component on G^k is invariant under the right action of U^k , and skew symmetric under the permutations of the factors of G^k modulo 2-torsion.*

Proof. Let $Q(X_*(H))^W$ be the group of W -invariant quadratic forms on the group of cocharacters of the Cartan group H . Recall ([BrD], Section 4; [EKL], 3.2, 4.7, 4.8) that for a split semi-simple group G there exists canonical isomorphism, functorial in G ,

$$H^2(BG, \mathbf{Z}_{\mathcal{M}}(2)) \xrightarrow{\sim} H^2(BH, \mathbf{Z}_{\mathcal{M}}(2))^W = Q(X_*(H))^W \quad (15.4)$$

Remark. The work [BrD] employs $H^0(X, \mathbf{K}_2)$, where \mathbf{K}_2 is the sheaf of K_2 groups in the Zariski topology. The Gersten resolution shows that it is isomorphic to our group $H^2(X, \mathbf{Z}_{\mathcal{M}}(2))$. In ([BrD], 4.1) the isomorphism (15.4) is formulated for simply-connected G , but it is valid for all G .

If $G = GL_n$, a cocycle satisfying all the conditions of the lemma was constructed in [G3]. We will recall its construction below. It provides a class in $H^2(BGL_n, \mathbf{Z}_{\mathcal{M}}(2))$ denoted by w_{GL_n} .

We may assume that G is simple. Let $\rho : G \rightarrow GL_n$ be a nontrivial homomorphism. The Killing form on GL_n restricts to λ_ρ times the Killing form on G . Since $\lambda_\rho \neq 0$, the class $\rho^* w_{GL_n}$ is not zero. The class $\rho^* w_{GL_n}$ is represented by an element in $C_3^U \in K_2(\mathbf{Q}(G^3))$. Since $\rho(U)$ lies in a maximal unipotent subgroup U' of GL_n , it is invariant under the right action of U^3 . Therefore there exists an U^3 -invariant lift $C_3^U \in \Lambda^2(\mathbf{Q}(G^3))$ of the class $\rho^* w_{GL_n}$. Consider the element

$$\sum_{i=1}^4 (-1)^{i-1} (s_i^4)^* C_3^U. \quad (15.5)$$

It lies in $\Lambda^2 \mathbf{Q}((G/U)^4)^*$. We claim that its projection to K_2 is zero. This means that there exists an U^4 -invariant element $C_4^U \in B_2(\mathbf{Q}(G^4))$ such that $\delta(C_4^U) = \sum_{i=1}^4 (-1)^{i-1} (s_i^4)^* C_3^U$. It remains to skewsymmetrize it. To check the claim observe that the projection of the element (15.5) to K_2 lies in the subspace $H^2((G/U)^4, \mathbf{Z}_{\mathcal{M}}(2))$ of the elements of K_2 with zero tame symbols. On the other hand we know that its pull back to G^4 is zero. Since $H^2(X, \mathbf{Z}_{\mathcal{M}}(2))$

is homotopy invariant, and the variety U is isomorphic to an affine space, we are done. The lemma is proved.

Observe that $G \backslash G^3 / U^3$ is birationally isomorphic to $\text{Conf}_3(\mathcal{A})$. So it comes from a class in K_2 of the field of rational functions on $\text{Conf}_3(\mathcal{A})$. Set $\mathbf{F}_{G,k} := \mathbf{Q}(\text{Conf}_k(\mathcal{A}))$. Lemma 15.1 just means that there exist elements

$$C_4^U \in B_2(\mathbf{F}_{G,4}), \quad C_3^U \in \Lambda^2 \mathbf{F}_{G,3}^*$$

which satisfies the following three conditions:

$$\text{i) } \sum_{i=1}^5 (-1)^{i-1} (s_i^5)^* C_4^U = 0; \quad \text{ii) } \sum_{i=1}^4 (-1)^{i-1} (s_i^4)^* C_3^U = \delta C_4^U; \quad \text{iii) } \text{Res}(C_3^U) = 0.$$

4. The motivic avatar of the Weil–Petersson form. The mapping class group Γ_S acts on $\mathcal{A}_{G,\hat{S}}$. Thanks to Proposition 3.2 we can define the second rational Γ_S -equivariant weight two motivic cohomology of $\mathcal{A}_{G,\hat{S}}$ by

$$\begin{aligned} H_{\Gamma_S}^2(\mathcal{A}_{G,\hat{S}}, \mathbf{Q}_{\mathcal{M}}(2)) &:= H^2(\mathbf{G}_{\bullet}(S) \times_{\Gamma_S} \mathcal{A}_{G,\hat{S}}, \mathbf{Q}_{\mathcal{M}}(2)) := \\ &:= H^2(\mathbf{G}_{\bullet}(S) \times_{\Gamma_S} \mathcal{A}_{G,\hat{S}}, \Gamma_{\mathcal{M}}(2)). \end{aligned}$$

Remarks. 1. $\mathcal{A}_{G,\hat{S}}$ and $\mathbf{G}_{\bullet}(S)$ are objects of different nature: the first is a stack whose generic point is an algebraic variety, while the second is a polyhedral complex. Their product is a mixed object. To define its hypercohomology with coefficients in a complex of sheaves \mathcal{F}^{\bullet} one proceeds similarly to the definition of hypercohomology of a simplicial algebraic variety.

2. Our cocycles for the classes in $H_{\Gamma_S}^2$ will sit at the generic point of $\mathcal{A}_{G,\hat{S}}$. Therefore we can forget about the complications related to the stack nature of $\mathcal{A}_{G,\hat{S}}$.

15.1. Theorem. — *A choice of W -invariant quadratic form Q on $X_*(H)$ provides a class*

$$\mathbf{W}_G(S) \in H_{\Gamma_S}^2(\mathcal{A}_{G,\hat{S}}, \mathbf{Q}_{\mathcal{M}}(2)).$$

It depends linearly on the form Q .

Here is a refined version of Theorem 15.1. Let \mathbf{F} be the field of rational functions on $\mathcal{A}_{G,\hat{S}}$. So the generic \mathbf{F} -point of the variety $\mathcal{A}_{G,\hat{S}}$ describes generic decorated unipotent G -local system on Γ .

15.2. Theorem. — *A cocycle C_\bullet^U as in Lemma 15.1 representing the class c_2^M provides a homomorphism of complexes*

$$\begin{array}{ccccccc} G_5(S) & \longrightarrow & G_4(S) & \longrightarrow & G_3(S) & \longrightarrow & 0 \\ \downarrow & & \downarrow w_4 & & \downarrow w_3 & & \downarrow \\ 0 & \longrightarrow & B_2(\mathbf{F}) & \xrightarrow{\delta} & \Lambda^2 \mathbf{F}^* & \xrightarrow{\partial} & \prod_{Y \in \mathcal{A}_m(S)_1} \mathbf{Q}(Y)^* \end{array}$$

Different cocycles lead to homotopic homomorphisms.

Proof of Theorem 15.2. A local system on a graph Γ is the following:

- i) a collection $\{L_v\}$ of vector spaces attached to the vertices v of Γ .
- ii) For any edge e an orientation of e gives rise to an operator $M_{\vec{e}} : L_{v_1} \longrightarrow L_{v_2}$. Here v_1 and v_2 are the vertices of e , and the chosen orientation is from v_1 to v_2 . Reversing the orientation of e we get the inverse operator.

Let Γ be a graph embedded to S , so that S retracts to Γ . Then there is a natural bijection between the local systems on S and Γ .

We picture a valence k vertex v of a ribbon graph by a little oriented circle S_v^1 with k marked points on it corresponding to the edges shared by v . The orientation of the circle is compatible with the cyclic order at v . The marked points cut the circle into k arcs $\alpha_1, \dots, \alpha_k$. A decorated unipotent G -local system on a ribbon graph Γ is given by a collection of affine flags X_{v, α_i} over v . The affine flag X_{v, α_i} is invariant under the monodromy around the face path provided by α_i .

Take a generator $(\Gamma, \varepsilon_\Gamma)$ of $G_3(S)$. We assign to it an element of $\Lambda^2 \mathbf{F}^*$ as follows. For each vertex v of Γ there are three cyclically ordered affine flags X_v^1, X_v^2, X_v^3 over v . Evaluating the component C_3^U on them we get an element $C_3^U(X_v^1, X_v^2, X_v^3) \in \Lambda^2 \mathbf{F}^*$. A trivalent ribbon graph has a canonical orientation provided by the cyclic structure at the edges. The sign $\text{sgn}(\varepsilon_\Gamma)$ as the ratio of this orientation to the one ε_Γ . We define the map w_3 by

$$w_3(\Gamma, \varepsilon_\Gamma) := \sum_{v \in V(\Gamma)} \text{sgn}(\varepsilon_\Gamma) C_3^U(X_v^1, X_v^2, X_v^3) \in \Lambda^2 \mathbf{F}^*.$$

Let $(\Gamma, \varepsilon_\Gamma) \in G_4(S)$. Then Γ is represented by a ribbon graph with exactly one 4-valent vertex v_0 . Let us enumerate the edges at this vertex in a way compatible with the cyclic order. Then the graph inherits a canonical orientation, and we will assume that ε_Γ is this orientation. One has

$$\partial : (\Gamma, \varepsilon_\Gamma) \longmapsto (\Gamma_1, \varepsilon_{\Gamma_1}) - (\Gamma_2, \varepsilon_{\Gamma_2})$$

where Γ_1 and Γ_2 are the two trivalent ribbon graphs shown on Fig. 15.1, and ε_{Γ_i} is the canonical orientation of the trivalent ribbon graph Γ_i .

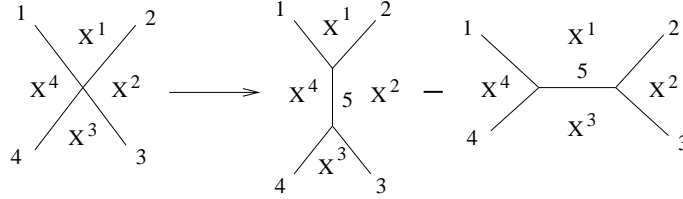

FIG. 15.1. —

A decorated unipotent G -local system on Γ provides us four affine flags X^1, \dots, X^4 in the domains near the vertex v_0 . We enumerate them using the chosen order of the edges at v_0 and set

$$w_4(\Gamma, \varepsilon_\Gamma) := C_4^U(X^1, X^2, X^3, X^4) \in B_2(\mathbf{F}).$$

The skew symmetry property of the component C_4^U guarantees that this definition does not depend on the ordering of the edges at v_0 . The condition $\delta \circ w_4(\Gamma, \varepsilon_\Gamma) = w_3 \circ \delta(\Gamma, \varepsilon_\Gamma)$ is equivalent to the cocycle condition ii) for C_\bullet^U .

Let $(\Gamma, \varepsilon_\Gamma) \in G_5(S)$. We assign to $(\Gamma, \varepsilon_\Gamma)$ zero. One needs to check that

$$w_4(\partial(\Gamma, \varepsilon_\Gamma)) = 0 \quad \text{in } B_2(\mathbf{F}).$$

Observe that Γ has either one 5-valent vertex v_0 , or two 4-valent vertices, and all the other vertices are of valence three. Suppose that Γ has a 5-valent vertex v_0 . Choose an order of the edges at v_0 compatible with the cyclic structure at the vertex. It provides an orientation of Γ , and we can assume that ε_Γ is this orientation. Then $\partial(\Gamma, \varepsilon_\Gamma)$ is given by the five generators shown on Fig. 15.2. Let X^1, \dots, X^5 be the five affine flags over the vertex v_0 , enumerated by using the numeration of the edges, see Fig. 15.2. Then

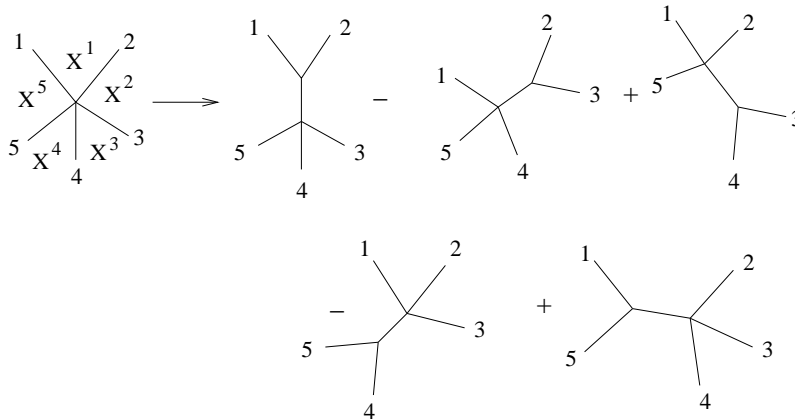

FIG. 15.2. — The pentagon relation.

$$w_4\left(\partial(\Gamma, \varepsilon_\Gamma)\right) = \sum_{i=1}^5 (-1)^{i-1} C_4^U(X^1, \dots, \widehat{X}^i, \dots, X^5) = 0.$$

The right hand side is zero thanks to the condition i) for the cocycle C_\bullet^U .

If Γ has two 4-valent vertices then it is easy to check, using only the skew symmetry of C_4^U , that $w_4\left(\partial(\Gamma, \varepsilon_\Gamma)\right) = 0$. We conclude that the properties i)–iii) for the cocycle C_\bullet^U imply that w_\bullet is a morphism of complexes. The theorem is proved.

Proof of Theorem 15.1. Similar to the proof of Theorem 15.2.

5. The K_2 -avatar of the degenerate symplectic form on $\mathcal{A}_{G, \widehat{S}}$.

15.1. Corollary. — *Let G be a split semi-simple algebraic group. Then a choice of a W -invariant quadratic form Q on $X_*(H)$ provides a class*

$$W_{G, \widehat{S}} \in H^2(\mathcal{A}_{G, \widehat{S}}, \mathbf{Q}_{\mathcal{M}}(2))^{G_S}.$$

The form $\Omega_{G, \widehat{S}} := d\log(W_{G, \widehat{S}})$ is a regular Γ_S -invariant 2-form on the non-singular part of $\mathcal{A}_{G, \widehat{S}}$.

Proof. For a field F one has $K_2(F) = \text{Coker}(\delta)$ by Matsumoto's theorem. Thus for a regular variety X we have $H^2(X, \mathbf{Q}_{\mathcal{M}}(2)) = H^2\Gamma(X, 2) \otimes \mathbf{Q}$ where the left hand side was defined in (1.25).

We define the class $W_{G, \widehat{S}}$ as the image of the class $\mathbf{W}_{G, \widehat{S}}$ under the canonical projection

$$H^2(\mathbf{G}_\bullet(S) \times_{\Gamma_S} \mathcal{A}_{G, \widehat{S}}, \mathbf{Q}_{\mathcal{M}}(2)) \longrightarrow H^2(\mathcal{A}_{G, \widehat{S}}, \mathbf{Q}_{\mathcal{M}}(2))^{G_S}.$$

The properties of the map $d\log$ provide the second statement. The corollary is proved.

A direct construction of the class $W_{G, \widehat{S}}$. Recall the canonical orientation of a trivalent ribbon graph Γ . Let $\Gamma \rightarrow \Gamma'$ be a flip defined by an edge e , and $\overline{\Gamma}$ the ribbon graph obtained by shrinking of the edge e . Then $\overline{\Gamma}$ has just one 4-valent vertex, the shrunked edge e . According to the proof of Theorem 15.2 we have

$$w_3(\Gamma) - w_3(\Gamma') = \delta w_4(\overline{\Gamma}). \quad (15.6)$$

So the projection of $w_3(\Gamma) \in \Lambda^2 \mathbf{F}^*$ to $K_2(\mathbf{F})$ does not depend on the choice of Γ . It is the class $W_{G, \widehat{S}}$.

In the next subsection we look at the proof of theorem 15.2 from a bit different perspective, getting a more general result.

6. The graph and the affine flags complexes. Let G be a group and X a G -set. Let $C_n(X)$ be the coinvariants of the diagonal action of G on $\mathbf{Z}[X^n]$. So the generators of $C_n(X)$ are elements (x_1, \dots, x_n) such that $(x_1, \dots, x_n) = (gx_1, \dots, gx_n)$ for any $g \in G$. The groups $C_n(X)$ form a complex $C_\bullet(X)$, called the *configurations complex*, with a differential ∂ given by

$$\partial : (x_1, \dots, x_n) \longmapsto \sum_{i=1}^n (-1)^{i-1} (x_1, \dots, \widehat{x}_i, \dots, x_n). \tag{15.7}$$

Applying this construction to the set of \mathbf{F} -points of the affine flag variety \mathcal{A}_G for G we get a configuration complex $C_\bullet(\mathcal{A}_G(\mathbf{F}))$. We define the related to \widehat{S} affine flags complex

$$A_\bullet^{\widehat{S}}(G) := \dots \xrightarrow{\partial} A_{n+2}^{\widehat{S}}(G) \xrightarrow{\partial} A_{n+1}^{\widehat{S}}(G) \xrightarrow{\partial} A_n^{\widehat{S}}(G) \xrightarrow{\partial} \dots$$

as its subcomplex generated by generic configurations of affine flags over \mathbf{F} .

Let us define a homomorphism $f_k : G_k(S) \longrightarrow A_k^{\widehat{S}}(G)$. If Γ has at least two vertices of valence ≥ 4 we set $f_k(\Gamma, \varepsilon_\Gamma) = 0$. Suppose that Γ has just one vertex v_0 of valence ≥ 4 . Then $\text{val}(v_0) = k$. Choose an order of the edges sharing v_0 compatible with the cyclic order at v_0 . This order provides an orientation $\widetilde{\varepsilon}_\Gamma$ of Γ . The order of the edges provides an order of the domains near v_0 , and hence the affine flags X^1, \dots, X^k attached to the domains. Set $f_k(\Gamma, \varepsilon_\Gamma) := \widetilde{\varepsilon}_\Gamma / \varepsilon_\Gamma \cdot (X^1, \dots, X^k)$. It does not depend on the chosen order of the edges.

15.1. Proposition. — *The map f_\bullet provides a map of complexes*

$$\begin{array}{ccccccc} \longrightarrow & G_5(S) & \longrightarrow & G_4(S) & \longrightarrow & G_3(S) & \longrightarrow & 0 \\ & \downarrow f_5 & & \downarrow f_4 & & \downarrow f_3 & & \downarrow \\ \longrightarrow & A_5^{\widehat{S}}(G) & \longrightarrow & A_4^{\widehat{S}}(G) & \longrightarrow & A_3^{\widehat{S}}(G) & \longrightarrow & A_2^{\widehat{S}}(G) \end{array}$$

Proof. Let us check that for a generator $(\Gamma, \varepsilon_\Gamma) \in G_k(S)$ one has

$$\partial \circ f_{k-1}(\Gamma, \varepsilon_\Gamma) = f_k \circ \partial(\Gamma, \varepsilon_\Gamma). \tag{15.8}$$

Suppose first that $k > 3$. Then both terms in (15.8) are zero if either there are three vertices in Γ of valence ≥ 4 , or there are two vertices of valence ≥ 5 . Suppose there are just two vertices, v_1 and v_2 , of valence ≥ 4 . We may assume that one of them, say for v_1 , is of valence 4. Then v_1 provides two terms to $\partial(\Gamma)$. They enter with the opposite signs, and hence f_{k-1} kills their sum. It remains to consider the case when there is just one vertex v of valence $k > 3$. Then the only component of $\partial(\Gamma)$ which is not immediately killed by f_{k-1} is the one shown on Fig. 15.3. It matches the i -th term in

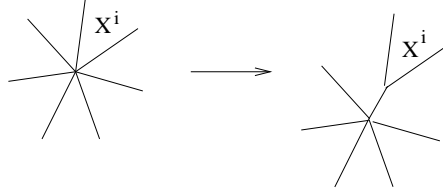

FIG. 15.3. —

the formula for $\partial \circ f_k(\Gamma)$. So (15.8) holds. If $k = 3$ then each edge of Γ contributes two terms to $f_k \circ \partial(\Gamma, \varepsilon_\Gamma)$, and they appear with the opposite signs, canceling each other. The proposition is proved.

7. Calculation of the \mathbf{W} -class for $G = SL_m$. Recall that Γ is a ribbon graph embedded to \widehat{S} , and I_m^Γ is the set parametrising the corresponding Δ - and X -coordinates, see Section 6. Recall the canonical map $p : \mathcal{A}_{SL_m, \widehat{S}} \rightarrow \mathcal{X}_{PSL_m, \widehat{S}}$.

15.3. Theorem. — *The \mathbf{W} -class on $\mathcal{A}_{PSL_m, \widehat{S}}$ is given by*

$$\begin{aligned} W_{SL_m, \widehat{S}} &= \sum_{i,j \in I_m^\Gamma} \varepsilon_{ij} \{ \Delta_i^\Gamma, d \log \Delta_j^\Gamma \} = \\ &= \sum_{i \in I_m^\Gamma} \{ \Delta_i^\Gamma, p^*(X_i^\Gamma) \} \in K_2(\mathbf{F}), \quad \mathbf{F} = \mathbf{Q}(\mathcal{A}_{SL_m, \widehat{S}}). \end{aligned} \quad (15.9)$$

It does not depend on the choice of the graph Γ .

15.2. Corollary. — *The Weil-Petersson form on $\mathcal{A}_{PSL_m, \widehat{S}}$ is given by*

$$\Omega_{SL_m, \widehat{S}} = \sum_{i,j \in I_m^\Gamma} \varepsilon_{ij} d \log \Delta_i^\Gamma \wedge d \log \Delta_j^\Gamma.$$

It does not depend on the choice of the graph Γ .

Proof. We are going to apply our construction to the cocycle C_\bullet^U for the second motivic Chern class c_2^M defined in [G3]. This cocycle satisfies the conditions of Lemma 15.1. We will get a cocycle representing the \mathbf{W} -class whose $\Lambda^2 \mathbf{F}^*$ -component is given by the following formula:

$$\sum_{i,j \in I_m^\Gamma} \varepsilon_{i,j} \Delta_i^\Gamma \wedge \Delta_j^\Gamma = \sum_{i \in I_m^\Gamma} \{ \Delta_i^\Gamma, p^*(X_i^\Gamma) \} \in \Lambda^2 \mathbf{F}^*. \quad (15.10)$$

It, of course, depends on the choice of the graph Γ . Theorem 15.3 follows immediately from this formula. Observe that the equality of the two terms in the formula is a straightforward consequence of the formula (9.6) for $p^*(X_i^\Gamma)$. To prove (15.10) we will give an explicit construction of the w_\bullet -map.

Denote by $A_\bullet(m)$ the affine flag complex for PSL_m . We will construct the following diagram of morphisms of complexes, where the $A_\bullet^{\widehat{S}}(m)$ and $BC_\bullet^{\widehat{S}}(2)$ are complexes defined using \mathbf{F} -vector spaces, as explained below:

$$\begin{array}{ccccccc}
 \longrightarrow & G_5(S) & \longrightarrow & G_4(S) & \longrightarrow & G_3(S) & \\
 & \downarrow f_5 & & \downarrow f_4 & & \downarrow f_3 & \\
 \longrightarrow & A_5^{\widehat{S}}(m) & \longrightarrow & A_4^{\widehat{S}}(m) & \longrightarrow & A_3^{\widehat{S}}(m) & \\
 & \downarrow g_5 & & \downarrow g_4 & & \downarrow g_3 & \\
 \longrightarrow & BC_5^{\widehat{S}}(2) & \longrightarrow & BC_4^{\widehat{S}}(2) & \longrightarrow & BC_3^{\widehat{S}}(2) & \\
 & \downarrow & & \downarrow h_4 & & \downarrow h_3 & \\
 & 0 & \longrightarrow & B_2(\mathbf{F}) & \xrightarrow{\delta} & \Lambda^2 \mathbf{F}^* & \xrightarrow{\text{Res}} \prod_{Y \in (\mathcal{A}_{SL_m, \widehat{S}})_1} \mathbf{Q}(Y)^*
 \end{array}$$

Then w_\bullet is the composition $w_\bullet := h_\bullet \circ g_\bullet \circ f_\bullet$.

The complexes in the diagram are given by horizontal lines, while morphisms are given by vertical arrows. The top complex is the graph complex on S . The next one is the complex of affine flags in the generic position in an m -dimensional vector space. Then follows the rank 2 bigrassmannian complex ([G1]) and the complex $\Gamma(\mathcal{A}_{SL_m, \widehat{S}}; 2)$. The homomorphisms g_\bullet and h_\bullet were defined in [G3] and [G1] - [G2]. We recall their definition below.

The grassmannian complex. Take $X = V_m$, where V_m is an F -vector space. The grassmannian complex

$$C_\bullet(m)_{/F} := \dots \xrightarrow{\partial} C_{m+2}(m) \xrightarrow{\partial} C_{m+1}(m) \xrightarrow{\partial} C_m(m)$$

is the subcomplex of the m -truncated complex $\sigma_{\geq m} C_\bullet(V_m)$ given by the configurations of vectors in the generic position in V_m .

The rank two bigrassmannian complex $BC_\bullet(2)$ ([G1]). It is the total complex associated with the bicomplex

$$\begin{array}{ccccccc}
 \dots & & \dots & & \dots & & \dots \\
 \dots & & \downarrow \partial' & & \downarrow \partial' & & \downarrow \partial' \\
 \dots & \xrightarrow{\partial} & C_6(3) & \xrightarrow{\partial} & C_5(3) & \xrightarrow{\partial} & C_4(3) \\
 \dots & & \downarrow \partial' & & \downarrow \partial' & & \downarrow \partial' \\
 \dots & \xrightarrow{\partial} & C_5(2) & \xrightarrow{\partial} & C_4(2) & \xrightarrow{\partial} & C_3(2)
 \end{array}$$

The horizontal differential are given by (15.7). The vertical ones are

$$\partial' : C_n(k) \longrightarrow C_{n-1}(k-1); \quad (x_1, \dots, x_n) \longmapsto \sum_{i=1}^n (-1)^{i-1} (x_i | x_1, \dots, \widehat{x}_i, \dots, x_n).$$

Here $(x_i | x_1, \dots, \widehat{x}_i, \dots, x_n)$ denotes the configuration of vectors obtained by projecting x_j , $j \neq i$, to the quotient $V_k / \langle x_i \rangle$.

The homomorphism g_\bullet ([G3]). Let us define its component

$$g_n^k : A_n(m) \longrightarrow C_n(k); \quad k \leq m.$$

Choose integers $p_1, \dots, p_n \geq 0$ such that $p_1 + \dots + p_n = m - k$. Let $X_\bullet^1, \dots, X_\bullet^n$ be the flags underlying affine flags $\tilde{X}^1, \dots, \tilde{X}^n$. The quotient

$$\frac{V_m}{X_{p_1} \oplus \dots \oplus X_{p_n}}. \quad (15.11)$$

is a vector space of dimension k . Our affine flags induce affine flags in this quotient. Taking the first vector of each of them, we get a configuration of n vectors in (15.11). The corresponding element of the group $C_n(k)$ is, by definition, $g_n^k(\tilde{X}^1, \dots, \tilde{X}^n)$. According to the Key Lemma from [G3] this way we get a morphism of complexes.

The homomorphism h_\bullet . Consider the following diagram:

$$\begin{array}{ccccc} C_5(2) & \xrightarrow{\partial} & C_4(2) & \xrightarrow{\partial} & C_3(2) \\ \downarrow l_5 & & \downarrow l_4 & & \downarrow l_3 \\ 0 & \longrightarrow & B_2(\mathbf{F}) & \xrightarrow{\delta} & \Lambda^2 \mathbf{F}^* \end{array}$$

$$l_3 : (l_1, l_2, l_3) \longmapsto \Delta(l_1, l_2) \wedge \Delta(l_2, l_3) + \Delta(l_2, l_3) \wedge \Delta(l_3, l_1) + \Delta(l_3, l_1) \wedge \Delta(l_1, l_2)$$

$$l_4 : (l_1, l_2, l_3, l_4) \longmapsto -\{r(l_1, l_2, l_3, l_4)\}_2.$$

Using the Plücker relation we see that, modulo 2-torsion, it provides a morphism of complexes, (see s. 2.3 in [G1]). The rank two grassmannian complex is a subcomplex of the rank two grassmannian bicomplex. Extending it by zero to the rest of the rank two grassmannian bicomplex we get the map h_\bullet . By s. 2.4 of [G1] it is a morphism of complexes.

Formula 15.10 follows from the construction of the map w_3 . Theorem 15.3 and hence Corollary 15.2 are proved.

The class $\mathbf{W}_{PSL_m, \hat{S}}$ is lifted from a similar class on the space $\mathcal{U}_{PSL_m, \hat{S}}$:

15.4. Theorem. — a) *There exists a unique class*

$$\mathbf{W}_{PSL_m, \hat{S}}^U \in H_{\Gamma_S}^2(\mathcal{U}_{PSL_m, \hat{S}}, \mathbf{Q}_{\mathcal{M}}(2)) \quad \text{such that } \mathbf{W}_{SL_m, \hat{S}} = p^* \mathbf{W}_{PSL_m, \hat{S}}^U$$

b) *The form $\Omega_{SL_m, \hat{S}}^U := d \log(W_{PSL_m, \hat{S}}^U)$ is a symplectic form on $\mathcal{U}_{PSL_m, \hat{S}}$.*

Proof. a) The class $\mathbf{W}_{SL_m, \hat{S}}$ has two nontrivial components, with values in B_2 and Λ^2 . The B_2 component comes from the $\mathcal{U}_{PSL_m, \hat{S}}$ -space by the very definition. For the Λ^2 -component this is deduced from the formula (15.10).

b) The class $W_{SL_m, \hat{S}}^U$ coincides with the one defined in the set-up of cluster ensembles, using the results of Section 9. Then the claim is a general property of the W -class in K_2 of a cluster ensemble, see [FG2], Chapter 5.

REFERENCES

- BAG. I. BISWAS, P. ARES-GASTESI, S. GOVINDARAJAN, Parabolic Higgs bundles and Teichmüller spaces for punctured surfaces., *Trans. Amer. Math. Soc.*, **349**, (1997), no. 4, 1551–1560, [alg-geom/9510011](#).
- BD. A.A. BEILINSON, V.G. DRINFELD, *Opers*, [math.AG/0501398](#).
- BeK. A. BERENSTEIN, D. KAZHDAN, Geometric and unipotent crystals., GAFA, Special Volume GAFA2000, 188–236.
- BeZ. A. BERENSTEIN, A. ZELEVINSKY, Tensor product multiplicities, canonical bases and totally positive algebras., *Invent. Math.*, **143**, (2001), no. 1, 77–128, [math.RT/9912012](#).
- BFZ96. A. BERENSTEIN, S. FOMIN, A. ZELEVINSKY, Parametrizations of canonical bases and totally positive matrices., *Adv. Math.*, **122**, (1996), no. 1, 49–149,
- BFZ03. A. BERENSTEIN, S. FOMIN, A. ZELEVINSKY, Cluster algebras. III: Upper bounds and double Bruhat cells., *Duke Math. J.*, **126**, (2005), no. 1, 1–52, [math.RT/0305434](#).
- Bers. L. BERS, Universal Teichmüller space. Analytic methods in mathematical physics (Sympos., Indiana Univ., Bloomington, Ind., 1968), pp. 65–83. Gordon and Breach, 1970.
- Bers2. L. BERS, On the boundaries of Teichmüller spaces and on Kleinian groups., *Ann. of Math.*, **91**, (1970), 670–600.
- Bon. F. BONAHO, The Geometry of Teichmüller space via geodesic currents., *Inv. Math.*, **92**, (1988), no. 1, 139–162.
- Bo. N. BOURBAKI, *Lie groups and Lie algebras. Chapters 4–6.*, Springer, (2002).
- Bor. M. BOROVoi, Abelianization of the second nonabelian Galois cohomology, *Duke Math. J.*, **72**, (1993), 217–239.
- BrD. J.-J. BRYLINSKY, DELIGNE, Central extensions of reductive groups by K_2 , *Publ. Math. IHES*, (2001).
- CG. N. CHRISS, V. GINZBURG, *Representation theory and complex geometry.*, Birkhauser Boston, Inc., Boston, MA, (1997).
- FCh. L.O. CHEKHOV, V.V. FOCK, Quantum Teichmüller spaces., *Teoret. Mat. Fiz.*, **120**, (1999), no. 3, 511–528, [math.QA/9908165](#).
- C. K. CORLETTE, Flat G -bundles with canonical metrics, *J. Diff. Geom.*, **28**, (1988), 361–382.
- Del. P. DELIGNE, Équations différentielles à points singuliers réguliers. Springer LNM, Vol. 163. 1970.
- DS. V.G. DRINFELD, V.V. SOKOLOV, Lie algebras and equations of Korteweg-de Vries type., *Current problems in mathematics*, **24**, (1984), 81–180, In Russian.
- D. S. DONALDSON, Twisted Harmonic Maps and the Self-Duality Equations., *Proc. London Math. Soc.*, **55**, (1987), 127–131.
- EKLV. H. ESNAULT, B. KAHN, M. LEVINE, E. VIEHWEG, The Arason invariant and mod 2 algebraic cycles, *JAMS*, **11**, (1998) no 1, 73–118. *Lett. Math. Phys.* 34 (1995), no. 3, 249–254.
- F. V.V. FOCK, Dual Teichmüller spaces., [dg-ga/9702018](#).
- FR. V.V. FOCK, A.A. ROSLY, Poisson structure on moduli of flat connections on Riemann surfaces and r -matrix. *AMS Transl. Ser. 2*, **191**, (1999), 67–86, [math.QA/9802054](#).
- FG2. V.V. FOCK, A.B. GONCHAROV, Cluster ensembles, quantization and the dilogarithm, [math.AG/0311245](#).
- FG3. V.V. FOCK, A.B. GONCHAROV, Moduli spaces of convex projective structures on surfaces, To appear in *Adv. in Math.*, (2006), [math.AG/0405348](#).
- FG4. V.V. FOCK, A.B. GONCHAROV, Dual Teichmüller and lamination spaces, To appear in the *Handbook on Teichmüller theory*, [math.AG/0510312](#).
- FG5. V.V. FOCK, A.B. GONCHAROV, Cluster \mathcal{X} -varieties, amalganations, and Poisson-Lie groups. *Progress in Mathematics*, Birkhauser. The volume dedicated to V.G. Drinfeld, [math.RT/0508408](#).
- FG6. V.V. FOCK, A.B. GONCHAROV, To appear.
- FZ99. S. FOMIN, A. ZELEVINSKY, Double Bruhat cells and total positivity., *JAMS*, **12**, (1999), no. 2, 335–380, [math.RA/9912128](#).
- FZI. S. FOMIN, A. ZELEVINSKY, Cluster algebras. I., *JAMS*, **15**, (2002), no. 2, 497–529, [math.RT/0104151](#).
- FZII. S. FOMIN, A. ZELEVINSKY, Cluster algebras. II: Finite type classification., *Invent. Math.*, **154**, (2003), no. 1, 63–121, [math.RA/0208229](#).

- FZ3. S. FOMIN, A. ZELEVINSKY, The Laurent phenomenon. *Adv. in Appl. Math.*, **28**, (2002), no. 2, 119–144, [math.CO/0104241](#).
- GGL. A.M. GABRIELOV, I.M. GELFAND, M.V. LOSIK, Combinatorial computation of characteristic classes. I, II. (Russian), *Funk. Anal. i Pril.*, **9**, (1975), no. 2, 12–28; no. 3, 5–26.
- GKr. F.R. GANTMACHER, M.G. KREIN, *Oscillation matrices and kernels and small vibrations of mechanical systems*. Revised edition of the 1941 Russian original.
- GKr2. F.R. GANTMACHER, M.G. KREIN, Sur les matrices oscillatoires., *CR Acad. Sci. Paris*, **201**, (1935). AMS Chelsea Publ., Providence, RI, (2002).
- GSV1. M. GEKHTMAN, M. SHAPIRO, A. VAINSHTEIN, Cluster algebras and Poisson geometry., *Mosc. Math. J.*, **3**, (2003), no. 3, 899–934; [math.QA/0208033](#).
- GSV2. M. GEKHTMAN, M. SHAPIRO, A. VAINSHTEIN, Cluster algebras and Weil-Petersson forms., *Duke Math. J.* **127**, (2005), no. 2, 291–311, [math.QA/0309138](#).
- Gui. O.GUICHARD, Sur les représentations de groupes de surface., Preprint.
- Gol1. W. GOLDMAN, The symplectic nature of fundamental groups of surfaces., *Adv. in Math.*, **54**, (1984), no. 2, 200–225.
- Gol2. W. GOLDMAN, Convex real projective structures on compact surfaces., *J. Diff. Geom.*, **31**, (1990) 126–159.
- G1. A.B. GONCHAROV, Geometry of configurations, polylogarithms, and motivic cohomology., *Adv. Math.*, **114**, (1995), no. 2, 197–318.
- G2. A.B. GONCHAROV, Polylogarithms and motivic Galois groups., *Motives* (Seattle, WA, 1991), *Proc. Sympos. Pure. Math.*, **55**, Part 2, Amer. Math. Soc., Providence, RI, (1994), 43–96.
- G3. A.B. GONCHAROV, Explicit construction of characteristic classes. *I. M. Gelfand Seminar*, *Adv. Soviet Math.*, **16**, Part 1, Amer. Math. Soc., Providence, RI, (1993), 169–210.
- G4. A.B. GONCHAROV, Deninger’s conjecture of L -functions of elliptic curves at $s = 3$. Algebraic geometry, 4. *J. Math. Sci.*, **81**, (1996), no. 3, 2631–2656; [alg-geom/9512016](#).
- G5. A.B. GONCHAROV, Polylogarithms, regulators and Arakelov motivic complexes., *J. Amer. Math. Soc.*, **18**, (2005), no. 1, 1–6; [math.AG/0207036](#)
- GM. A.B. GONCHAROV, Yu.I. MANIN, Multiple ζ -motives and moduli spaces $\mathcal{M}_{0,n}$., *Compos. Math.*, **140**, (2004), no. 1, 1–14, [math.AG/0204102](#).
- Ha. J. HARER, The virtual cohomological dimension of the mapping class group of an orientable surface., *Invent. Math.*, **84**, (1986) no. 1, 157–176.
- H1. N.J. HITCHIN, Lie groups and Teichmüller space., *Topology* **31**, (1992), no. 3, 449–473.
- H2. N.J. HITCHIN, The self-duality equation on a Riemann surface., *Proc. London Math. Soc.* **55**, (1987), 59–126.
- K. R.M. KASHAEV, Quantization of Teichmüller spaces and the quantum dilogarithm., *Lett. Math. Phys.*, **43**, (1998), no. 2, 105–115.
- Kr. I. KRA, Deformation spaces. A crash course on Kleinian groups (Lectures at a Special Session, Annual Winter Meeting, Amer. Math. Soc., San Francisco, Calif., 1974), *Lecture Notes in Math.*, **400**, Springer, Berlin, (1974), 48–70.
- Ko. M. KONTSEVICH, Formal (non)commutative symplectic geometry., *The Gelfand Mathematical Seminars 1990–1992*, Birkhäuser Boston, Boston, MA, (1993), 173–187.
- Lab. F. LABOURIE, *Anosov flows, surface groups and curves in projective spaces*. Preprint, Dec. 8, (2003).
- L1. G. LUSZTIG, Total positivity in reductive groups, *Lie theory and geometry*, *Progr. Math.*, **123**, Birkhäuser Boston, Boston, MA, (1994), 531–568.
- L2. G. LUSZTIG, Total positivity and canonical bases., *Algebraic groups and Lie groups*, *Austral. Math. Soc. Lect. Ser.*, **9**, Cambridge Univ. Press, Cambridge, (1997), 281–295.
- MM. C. MCMULLEN, Iteration on Teichmüller space., *Invent. Math.*, **99**, (1990), no. 2, 425–454.
- Mi. J. MILNOR, *Introduction to algebraic K-theory.*, Annals of Mathematics Studies, No. 72. Princeton University Press, Princeton, N.J., University of Tokyo Press, Tokyo, (1971).
- NZ. I. NIKOLAEV, E. ZHUKHOMA, Flows on 2-dimensional manifolds. LNM1705 1999.
- P1. R.C. PENNER, The decorated Teichmüller space of punctured surfaces., *Comm. Math. Phys.*, **113**, (1987), no. 2, 299–339.
- P2. R.C. PENNER, Weil-Petersson volumes., *J. Differential Geom.*, **35**, (1992), no. 3, 559–608.

- P3. R.C. PENNER, Universal constructions in Teichmüller theory., *Adv. Math.* **98**, (1993), no. 2, 143–215.
- P4. R.C. PENNER, The universal Ptolemy group and its completions. Geometric Galois actions, **2**, 293–312, London Math. Soc. Lect. Note Ser., 243, Cambridge Univ. Press, 1997.
- PH. R.C. PENNER, J.L. HARER, Combinatorics of train tracks. *Annals of Mathematics Studies*, **125**, Princeton University Press, Princeton, NJ, 1992.
- Sch. I.J. SCHOENBERG, Convex domains and linear combinations of continuous functions. *BAMS*, **39**, (1933), 273–280.
- Sch1. I.J. SCHOENBERG, Über variationsvermindernde lineare Transformationen. *Math. Z.* **32**, (1930) 321–322.
- S. C. SIMPSON, Constructing Variations of Hodge Structures Using Yang-Mills Theory and Applications to Uniformization, *JAMS* **1**, (1988) 867–918.
- Se. J.-P. SERRE, Cohomologie Galoisienne, Lect. Notes Math., **5**.
- Str. K. STRİBEL, *Quadratic Differentials*, Springer, Berlin–Heidelberg–New York (1984).
- SZ. P. SHERMAN, A. ZELEVINSKY, Positivity and canonical bases in rank 2 cluster algebras of finite and affine types, *Mosc. Math. J.* **4**, (2004), no. 4, 947–974, [math.RT/0307082](https://arxiv.org/abs/math/0307082).
- Sus. A.A. SUSLIN, Homology of GL_n , characteristic classes and Milnor K -theory. *Algebraic geometry and its applications. Trudy Mat. Inst. Steklov.* **165**, (1984), 188–204.
- Th. W. THURSTON, The geometry and topology of three-manifolds, *Princeton University notes*, <http://www.msri.org/publications/books/gt3m>.
- W. A.M. WHITNEY, A reduction theorem for totally positive matrices, *J. d'Analyse Math.* **2**, (1952), 88–92.
- Wo. S. WOLPERT, Geometry of the Weil-Petersson completion of the Teichmüller space. *Surveys in Differential Geometry.J.* **VIII**, (2002), 357–393.

V.V.
 ITEP,
 B. Cheremushkinskaya 25,
 117259 Moscow, Russia,
 fock@math.brown.edu

A.G.
 Department of Mathematics,
 Brown University, Providence RI 02906, USA,
 sasha@math.brown.edu

Manuscript reçu le date.