

# NEW PERSPECTIVES ON SELF-LINKING

RYAN BUDNEY, JAMES CONANT, KEVIN P. SCANNELL, AND DEV SINHA

ABSTRACT. We initiate the study of classical knots through the homotopy class of the  $n$ th evaluation map of the knot, which is the induced map on the compactified  $n$ -point configuration space. Sending a knot to its  $n$ th evaluation map realizes the space of knots as a subspace of what we call the  $n$ th mapping space model for knots. We compute the homotopy types of the first three mapping space models, showing that the third model gives rise to an integer-valued invariant. We realize this invariant in two ways, in terms of collinearities of three or four points on the knot, and give some explicit computations. We show this invariant coincides with the second coefficient of the Conway polynomial, thus giving a new geometric definition of the simplest finite-type invariant. Finally, using this geometric definition, we give some new applications of this invariant relating to quadriseccants in the knot and to complexity of polygonal and polynomial realizations of a knot.

## CONTENTS

1. Introduction	1
2. Spaces of knots and evaluation maps	4
2.1. Compactifications of configuration spaces	4
2.2. The mapping space model	7
3. The homotopy types of the first three mapping space models	7
4. Linking of collinearity manifolds	11
4.1. Definition of $\nu_2$	11
4.2. $\mu_2$ is an isomorphism	14
5. Examples	15
6. Quadriseccants, finite-type, and geometric consequences	18
6.1. Quadriseccants on long knots	18
6.2. $\nu_2$ is of type two.	19
6.3. Quadriseccants and closed knots.	20
6.4. Geometric applications	21
References	25

## 1. INTRODUCTION

Finite-type invariants, introduced by Goussarov and Vassiliev [17, 36], enjoyed an explosion of interest (e.g. [4, 5, 3]) when Kontsevich, building on work of Drinfeld, showed that they are rationally classified by an algebra of trivalent graphs [22]. The topological meaning of the classifying map (defined by the Kontsevich integral) is poorly understood however, and various attempts have been made to understand finite-type invariants in terms of classical topology. Bott and Taubes, for example, began the study of

---

1991 *Mathematics Subject Classification.* 57M27, 55R80, 57R40, 57M25, 55P99.

*Key words and phrases.* finite-type invariants, Goodwillie calculus, quadriseccants.

The second author is supported by NSF VIGRE grant DMS-9983660. The third author is supported by NSF grant DMS-0072515.

finite-type invariants via the de Rham theory of configuration spaces [6, 1, 26]. In this paper we begin to construct universal finite-type invariants *over the integers*, through homotopy theory and differential topology of configuration spaces. As an outcome we find novel topological interpretations of the first nontrivial finite-type invariant.

Finite-type invariants in general, and in particular the simplest such invariant  $c_2$  which is the second coefficient of the Conway polynomial, have been known as self-linking invariants for various reasons. One explanation is that if  $K_+$  and  $K_-$  differ by a single crossing change, then  $c_2(K_+) - c_2(K_-) = lk(L_0)$ , where  $L_0$  is a link formed by “resolving” the crossing. Bott and Taubes also call  $c_2$  a self-linking invariant because their de Rham formula generalizes the Gauss integral formula for the linking number, as does the Kontsevich integral.

We provide a new perspective on self-linking in the following sense. For technical simplicity, our knots are proper embeddings  $f$  of the interval  $\mathbb{I}$  in  $\mathbb{I}^3$  with fixed endpoints and tangent vectors at those endpoints, the space of all such we call  $\text{Emb}(\mathbb{I}, \mathbb{I}^3)$ . Consider the submanifold  $\mathbf{Co}_i(f)$  of  $\text{Int}(\Delta^3)$  consisting of all  $t_1 < t_2 < t_3$  such that  $f(t_1)$ ,  $f(t_2)$  and  $f(t_3)$  are collinear and such that  $f(t_i)$  is between the other two points along the line. See for example Figure 1.

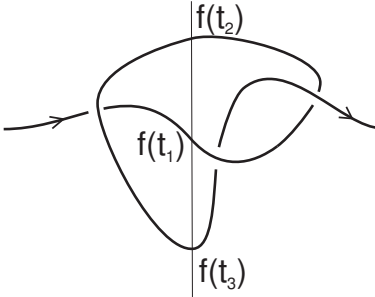

FIGURE 1. Collinear points on a knot, giving rise to a point in  $\mathbf{Co}_1(\mathcal{K})$ .

By putting  $\mathcal{K}$  in general position,  $\mathbf{Co}_1(f)$  and  $\mathbf{Co}_3(f)$  are codimension two submanifolds of  $\text{Int}(\Delta^3)$ . By using the appropriate compactification technology (as developed in Subsection 2.1 and [32]) they are interiors of 1-manifolds with boundary, which we denote  $\mathbf{Co}_i[\mathcal{K}]$ ,  $i = 1, 3$ , inside the compactification  $C_3[\mathbb{I}, \partial]$  of  $\text{Int}(\Delta^3)$ . Moreover,  $\mathbf{Co}_1[\mathcal{K}]$  and  $\mathbf{Co}_3[\mathcal{K}]$  have boundaries on disjoint faces of  $C_3[\mathbb{I}, \partial]$ , so they have a well-defined linking number. In Section 4, we define  $\nu_2: \pi_0(\text{Emb}(\mathbb{I}, \mathbb{I}^3)) \rightarrow \mathbb{Z}$  as this linking number of collinearity submanifolds. In sections 5 and 6, we show  $\nu_2 = c_2$  thus giving a new geometric interpretation of this simplest quantum invariant.

We were led to this self-linking construction as part of a more general study. In Section 2, we construct an approximating model for the space of embeddings of an interval in a manifold,  $\text{Emb}(\mathbb{I}, M)$ ,

$$C_n: \text{Emb}(\mathbb{I}, M) \rightarrow AM_n(M),$$

introduced by the fourth author [33] building on the calculus of embeddings of Goodwillie, Klein, and Weiss [16, 15, 14, 38, 39]. When the dimension of  $M$  is greater than three, the map  $C_n$  induces isomorphisms on homology and homotopy groups up to degree  $n(\dim(M) - 3)$ . For three-manifolds we conjecture a strong relation to finite-type invariants. In particular, for  $M = \mathbb{I}^3$  we conjecture the following.

**Conjecture 1.1.** *The map  $\pi_0(C_n): \pi_0(\text{Emb}(\mathbb{I}, \mathbb{I}^3)) \rightarrow \pi_0(AM_n(\mathbb{I}^3))$  is a universal additive type  $n - 1$  invariant over  $\mathbb{Z}$ .*

This conjecture requires explanation. The connected components of  $\text{Emb}(\mathbb{I}, \mathbb{I}^3)$  are knot types, so  $\pi_0(C_n)$  is indeed a knot invariant. We conjecture that  $AM_n(\mathbb{I}^3)$  is always a 2-fold loop space, implying

that  $\pi_0(AM_n(\mathbb{I}^3))$  is an abelian group. Moreover we conjecture that  $\pi_0(C_n)$  is a homomorphism from the monoid of knots, under connected sum, to the abelian group  $\pi_0(AM_n(\mathbb{I}^3))$ . Finally, by a *universal type  $n - 1$  invariant* we mean a knot invariant taking values surjectively in an abelian group such that every type  $n - 1$  invariant factors through this map.

We establish Conjecture 1.1 for  $n \leq 3$ . In section 3 we show that  $AM_1(\mathbb{I}^3)$  is homotopy equivalent to  $\Omega S^2$ , which is connected, and that  $AM_2(\mathbb{I}^3)$  is contractible. We then cite the well-known fact that there are no non-trivial degree zero or one knot invariants. We focus on  $n = 3$ , where our work is grounded in computations similar to those of [31], in which the last two authors compute rational homotopy groups of spaces of knots in even-dimensional Euclidean spaces. For classical knots, they found that  $\pi_0(AM_3(\mathbb{I}^3))$  is isomorphic to  $\pi_3$  of the homotopy fiber  $F$  of the inclusion  $S^2 \vee S^2 \rightarrow S^2 \times S^2$ . In fact, in section 3 we establish that  $AM_3(\mathbb{I}^3) \simeq \Omega^3 F$ . Classically,  $\pi_3(F)$  is well known to be isomorphic to the integers, with the isomorphism given by a linking number or Hopf invariant  $\mu_2$ . We show that  $\mu_2 \circ \pi_0(C_n) = \nu_2 = c_2$ , the first non-trivial Vassiliev invariant. Higher  $n$  will be considered in [7], in which we plan to define the knot invariants given by  $\pi_0(C_n)$  through linking invariants of what we call ‘‘coincidence submanifolds’’ in the parameter space  $C_n[I, \partial]$ . Constructing knot invariants through Hopf invariants of natural submanifolds of this parameter space is our new perspective on self-linking.

Further evidence for Conjecture 1.1 is the thesis of I. Volic, which shows that the Bott-Taubes invariants factor through  $\pi_0(C_{2n})$  [37]. Since Bott-Taubes invariants generate the rational vector space of finite type invariants, this shows that  $\pi_0(C_{2n})$  rationally classifies finite type invariants. Our approach is complementary in that it is over the integers, and moreover leads to novel geometric consequences, even at the lowest non-trivial degree. Another approach to finite-type knot theory which may be closely related to ours is that of arrow diagrams [?], which following ideas of [?] might be understood through composing the evaluation map of this paper with projections to products of spheres. We hope to explore this connection in future work.

For general three-manifolds  $M$  the theory of finite-type invariants is not well understood, and accordingly neither is  $AM_n(M)$ , whose components do not seem to have an additive structure. Nonetheless, we suspect that Conjecture 1.1 will have an analogue in this setting. It may be helpful to restate the conjecture dually. Define two knots to be  $n - 1$ -equivalent if they share all type  $n - 1$  invariants. As proven by Goussarov [17], knots modulo  $n - 1$  equivalence form an abelian group under connected sum. One can formulate  $n - 1$  equivalence in other ways, as equivalence up to:

- Tying a pure braid in the  $n$ th term of the lower central series of the pure braid group into some strands of a knot. [34]
- Simple clasper surgeries of degree  $n$ . [19]
- Capped grope cobordism of class  $n$ . [9]

Conjecture 1.1 can be restated as saying  $\pi_0(C_n)$  induces an isomorphism

$$(\pi_0(\text{Emb}(\mathbb{I}, \mathbb{I}^3)) / (n - 1) - \text{equivalence}) \cong \pi_0(AM_n(\mathbb{I}^3)),$$

and we suspect that different points of view on  $n - 1$  equivalence will be helpful in studying analogues of Conjecture 1.1 for arbitrary three-manifolds.

One of the surprises we encountered during this investigation was that our invariant has a natural interpretation in terms of counting quadriseccants, which by definition are collinearities of four points along the knot. Quadriseccants have appeared previously in knot theory [29, 28, 25]. In Section 6, we explain this connection in detail. This quadriseccant interpretation leads to lower bounds on stick number for polygonal knots and the degree of polynomial needed to represent a knot in terms of  $c_2$ , also explained in section 6.

**Acknowledgments** We wish to thank Tom Goodwillie, Louis Kauffman, John Sullivan, and Arkady Vaintrob and the referee for their interest and suggestions.

## 2. SPACES OF KNOTS AND EVALUATION MAPS

The appropriate construction of an evaluation map for knots is our connection between algebraic and geometric topology. Evaluation maps have long been a tool in the study of links. The linking number of a two component link can be understood as the homotopy class of the evaluation map from the space of two points on the link, one on each component, to  $C_2(\mathbb{R}^3)$ , the space of ordered pairs in  $\mathbb{R}^3$ . Up to homotopy, this is a map from  $S^1 \times S^1$  to  $S^2$ , which is thus characterized by degree. This degree is computed by the Gauss integral. In fact, Koschorke has shown [24] that all Milnor linking numbers may be understood through evaluation maps from  $(S^1)^k$  to  $C_k(\mathbb{R}^3)$ . For knots, the situation is more subtle because one is led to consider maps from the space of configurations on the knot, which is an open simplex, to  $C_k(\mathbb{R}^3)$ . The technical heart of the matter is what to do “on the boundary” of the configuration space, including what boundary to use in the first place. In [33] the fourth author showed that the appropriate boundary conditions are prescribed when one relates the calculus of embeddings to the evaluation map.

**2.1. Compactifications of configuration spaces.** Key technical tools are the Fulton-MacPherson compactifications of configuration spaces. Readers familiar with these constructions may skip most of this section, but should familiarize themselves with our labeling scheme for strata. For manifolds, there are two versions of these compactifications, a projective version which can be defined by an immediate translation of the Fulton-MacPherson construction, and a closely related spherical version which was first constructed by Axelrod and Singer [2]. We use the spherical version, in many ways most natural for manifolds, which up to homeomorphism is just the space  $M^n \setminus N$ , where  $N$  is a “tubular” neighborhood of the fat diagonal. These compactifications have many properties which are not immediate from the  $M^n \setminus N$  model. See [32] for a full development of these compactifications using the following simple construction similar to one given for Euclidean spaces by Kontsevich [23] and Gaiffi [?].

**Definition 2.1.** Let  $\pi_{ij}: C_n(\mathbb{R}^k) \rightarrow S^{k-1}$  be the map which sends  $\mathbf{x} = (x_1, \dots, x_n)$  to the unit vector in the direction of  $x_i - x_j$ . Let  $s_{ijk}: C_n(\mathbb{R}^k) \rightarrow (0, \infty) \subset \mathbb{I}$ , where the latter inclusion is defined through the arctangent function, be the map which sends  $\mathbf{x}$  to  $(|x_i - x_j|/|x_i - x_k|)$ . Let  $B_{n,k}$  be the product  $(\mathbb{R}^k)^n \times (S^{k-1})^{\binom{n}{2}} \times \mathbb{I}^{\binom{n}{3}}$ .

**Definition 2.2.** Define  $C_n[\mathbb{R}^k]$  to be the closure of the image of  $C_n(\mathbb{R}^k)$  under the map  $\iota \times \prod \pi_{ij} \times \prod s_{ijk}$  to  $B_{n,k}$ , where  $\iota$  is the standard inclusion of  $C_n(\mathbb{R}^k)$  in  $(\mathbb{R}^k)^n$ . Define  $C_n[M]$  for a general manifold  $M$  by embedding  $M$  in some  $\mathbb{R}^k$  in order to define the restrictions of the maps  $\pi_{ij}$  and  $s_{ijk}$ , and then taking the closure of  $C_n(M)$  in  $M^n \times \prod (S^{k-1}) \times \prod \mathbb{I}$ . For  $M = \mathbb{I}^k$  we use the standard embedding of  $\mathbb{I}^k$  in  $\mathbb{R}^k$ .

These closures have the following important properties.

**Theorem 2.3.** (see [32])

- $C_n[M]$  is a manifold with corners whose interior is  $C_n(M)$ , and which thus has the same homotopy type as  $C_n(M)$ . It is independent of the embedding of  $M$  in  $\mathbb{R}^k$ , and it is compact when  $M$  is.
- The inclusion of  $C_n(M)$  in  $M^n$  extends to a surjective map  $p$  from  $C_n[M]$  to  $M^n$  which is a homeomorphism over points in  $C_n(M)$ .
- If, in the projection of  $x \in C_n[M]$  onto  $M^n$ , some  $x_i = x_j$ , then there is a well-defined  $v_{ij} \in STM$  sitting over  $x_i$ , which we call the relative vector and which gives the “infinitesimal relative position” of  $x_i$  and  $x_j$ . For  $M = \mathbb{R}^k$ , this vector is given by the extension of the map  $\pi_{ij}$ , which is in turn the restriction of the projection of  $B_{n,k}$  onto the  $ij$  factor of  $S^{k-1}$ .
- If  $f: M \rightarrow N$  is an embedding the induced map on open configuration spaces extends uniquely to a map, which we call the evaluation map,  $C_n[f]: C_n[M] \rightarrow C_n[N]$  which preserves the stratification of these spaces as manifolds with corners. This map is defined by choosing the ambient embedding of  $M$  in  $\mathbb{R}^k$  to be the composite of  $f$  with the ambient embedding of  $N$ .

The best understanding of these compactifications comes from their stratification. When  $M$  is Euclidean space, these strata are simple to describe once we develop the appropriate combinatorics to enumerate them. Here, we choose to develop this combinatorics in terms of parenthesizations.

**Definition 2.4.** A (partial) parenthesization  $\mathcal{P}$  of a set  $T$  is an unordered collection  $\{A_i\}$  of subsets of  $T$ , each having cardinality at least two, such that for any  $i, j$  either  $A_i \subset A_j$  or  $A_i$  and  $A_j$  are disjoint. We denote a parenthesization by a nested listing of elements of the  $A_i$  using parentheses and equal signs.

For example,  $(3 = 4), ((1 = 2) = 6)$  represents a parenthesization of  $\{1, \dots, 6\}$  whose subsets are  $\{3, 4\}$ ,  $\{1, 2\}$  and  $\{1, 2, 6\}$ .

**Definition 2.5.** Let  $\mathbf{Pa}(T)$  be the set of parenthesizations of  $T$ . Define an ordering on  $\mathbf{Pa}(T)$  by  $\mathcal{P} \leq \mathcal{P}'$  if  $\mathcal{P} \subseteq \mathcal{P}'$ . A total parenthesization is a maximal element under this ordering.

For example,  $\mathbf{Pa}(\{1, 2, 3\})$  is given as follows.

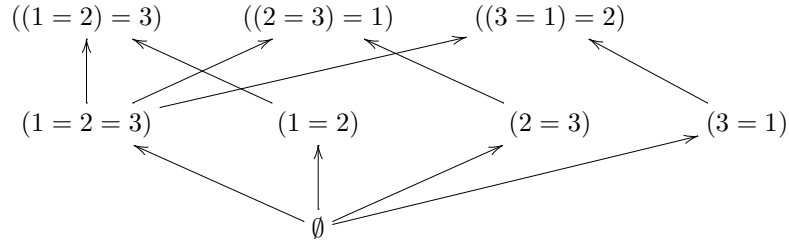

In our applications we need the combinatorics of maximal subsets within a parenthesization.

**Definition 2.6.** From a parenthesization  $\mathcal{P}$  of  $T$  we form a sequence  $\lambda_i(\mathcal{P})$  which for  $i > 0$  are subsets of  $\mathcal{P}$  by setting  $\lambda_0(\mathcal{P}) = \{T\}$  and inductively the elements of  $\lambda_{i+1}(\mathcal{P})$  are maximal elements in the ordering given by inclusion of subsets of  $T$  (that is, largest subsets), of  $\mathcal{P} \setminus \bigcup_{k=0}^i \lambda_k(\mathcal{P})$ .

Define an equivalence relation  $\sim_i$  on each  $Q \in \lambda_i(\mathcal{P})$  by  $x \sim_i y$  if  $x, y \in Q'$  for some  $Q' \in \lambda_{i+1}(\mathcal{P})$ . For such a  $Q$ , let  $|Q|$  be the number of equivalence classes of  $Q$  under  $\sim_i$ .

Recall that the strata of a manifold with corners form a poset by the relation  $S < T$  if  $S$  is in the closure of  $T$ . We are now ready to describe the strata of  $C_n[\mathbb{R}^k]$ .

**Definition 2.7.** Let  $\tilde{C}_n(\mathbb{R}^k)$  be the quotient of  $C_n(\mathbb{R}^k)$  by the action of scaling all points by positive real numbers and by translation of all points.

So for example  $\tilde{C}_2(\mathbb{R}^k)$  is diffeomorphic to  $S^{k-1}$ .

**Theorem 2.8** (See [32]). *If  $M$  has no boundary, the poset of strata of  $C_n[M]$  is isomorphic to  $\mathbf{Pa}([n])$ , where  $[n] = \{1, \dots, n\}$ . Given a parenthesization  $\mathcal{P}$  of  $[n]$ , the codimension of the corresponding stratum  $S_{\mathcal{P}}$  is the cardinality of  $\mathcal{P}$ . When  $M = \mathbb{R}^k$ , the stratum  $S_{\mathcal{P}}$  is diffeomorphic to*

$$C_{|T|}(\mathbb{R}^k) \times \prod_{i>0} \prod_{Q \in \lambda_i(\mathcal{P})} \tilde{C}_{|Q|}(\mathbb{R}^k).$$

For  $M = \mathbb{R}^k$ , we give an informal indication of how the codimension zero stratum  $C_n(\mathbb{R}^k)$  and the codimension one strata  $C_{n-\ell+1}(\mathbb{R}^k) \times \tilde{C}_{\ell}(\mathbb{R}^k)$  are topologized together as follows. Let  $\{\mathbf{x}_i = (\mathbf{x}_{i1}, \dots, \mathbf{x}_{in})\}$  be a sequence of points in  $C_n(\mathbb{R}^k)$ , and consider its image in  $(\mathbb{R}^k)^n$ . For  $\{\mathbf{x}_i\}$  to converge to a point in  $C_{n-\ell+1}(\mathbb{R}^k) \times \tilde{C}_{\ell}(\mathbb{R}^k)$ , its image in  $(\mathbb{R}^k)^n$  must converge to a point  $\mathbf{x}_{\infty} = (x_{\infty 1}, \dots, x_{\infty n})$  which has  $\ell$  coordinates which coincide, say  $x_{\infty j_1} = \dots = x_{\infty j_{\ell}}$ . The other coordinates,  $x_{\infty i}$  for  $i \notin \{j_k\}$ , along with say  $x_{\infty j_1}$  define a point in  $C_{n-\ell+1}$ . Moreover, to obtain a point in  $\tilde{C}_{\ell}(\mathbb{R}^k)$  in the limit from  $\{\mathbf{x}_i\}$  we must be able to take the limit of  $\{(x_{ij_1}, \dots, x_{ij_{\ell}}) / \sim\}$  in  $\tilde{C}_{\ell}(\mathbb{R}^k)$ .

In our variant of knot theory, the ambient manifold  $\mathbb{I}^3$  comes equipped with two points on its boundary to which the endpoints of the interval must map.

**Definition 2.9.** If  $M$  is a manifold with boundary with two distinguished points  $y_0$  and  $y_1$  in its boundary, define  $C_n[M, \partial]$  to be the subspace of  $C_{n+2}[M]$  of points whose images under  $p$  in  $M^{n+2}$  are of the form  $(y_0, x_1, \dots, x_n, y_1)$ .

One case of interest is of course when  $M$  is an interval and the two distinguished points are its endpoints. The configuration space of points in the open interval is a union of open simplices. At times, we will compactify the open simplex by embedding it in the standard way in the closed simplex. We call  $\Delta^n = \{\mathbf{t} = (t_1, \dots, t_n) : 0 = t_0 \leq t_1 \leq \dots \leq t_n \leq t_{n+1} = 1\}$  the *naive compactification* of configurations in the interval and note that our projection map  $p$  sends  $C_n[\mathbb{I}, \partial]$  to  $\Delta^n$ . The compactification  $C_n[\mathbb{I}, \partial]$ , which has arisen elsewhere in topology [35], is a polyhedron with a beautiful combinatorial description.

**Definition 2.10.** A subset  $A$  of a totally ordered set  $S$  is *consecutive* if  $x, z \in A$  and  $x < y < z$  implies  $y \in A$ , and  $A$  has two or more elements. An *ordered parenthesization* of  $S$  is one in which all of the subsets in the parenthesization are consecutive and proper.

**Definition 2.11.** The  $n$ th *associahedron* (or *Stasheff polytope*),  $A_n$ , is the polytope whose faces  $A_n^P$  are labeled by the ordered parenthesizations of  $\{0, \dots, n+1\}$  and where  $A_n^P$  is a face of  $A_n^{P'}$  if  $P \subset P'$ .

Alternatively, the barycentric subdivision of  $A_n$  is isomorphic to the nerve (also known as the realization or the order complex) of the poset of ordered parenthesizations of  $\{0, \dots, n+1\}$ . The name associahedron comes from the fact that the vertices are labeled by total ordered parenthesizations of  $\{0, \dots, n+1\}$ , which may be viewed as ways to associate a word with  $n$  letters.

**Proposition 2.12** (See [32]). *Each component of  $C_n[\mathbb{I}, \partial]$  is isomorphic as a manifold with corners to the  $n$ th associahedron  $A_n$ .*

**Figure 2.13.**

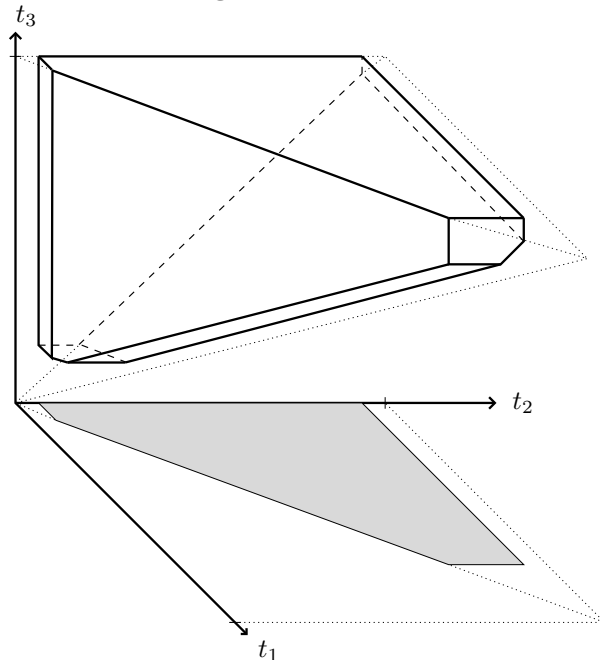

The 3rd Stasheff polytope  $A_3 = C_3[\mathbb{I}, \partial]$

Finally, we include tangent vectors in the picture as follows.

**Definition 2.14.** Let  $C'_n[M]$  be defined by the pull-back square

$$\begin{array}{ccc} C'_n[M] & \longrightarrow & (STM)^n \\ \downarrow & & \downarrow \\ C_n[M] & \xrightarrow{p} & M^n. \end{array}$$

If  $M$  has two distinguished points on its boundary with one inward-pointing and one outward-pointing tangent vector at those points, let  $C'_n[M, \partial]$  be the subspace of  $C'_{n+2}[M]$  of points whose first and last projection onto  $STM$  are given by those distinguished tangent vectors.

**2.2. The mapping space model.** We are ready to define our mapping space model for knot spaces. As we have mentioned (Theorem 2.3), the evaluation map of a knot  $f$ , namely  $C_n[f]: A_n = C_n[\mathbb{I}, \partial] \rightarrow C'_n[\mathbb{I}^3, \partial]$ , is stratum preserving. But note as well that for a point  $\mathbf{t}$  on the boundary of  $A_n$  such that  $p(\mathbf{t})$  has  $t_i = t_{i+1} = t_{i+2}$ ,  $C_n[f](\mathbf{t})$  will, in the decomposition of Theorem 2.8, project onto a point in  $\tilde{C}_3(\mathbb{R}^k)$  which is degenerate in the sense that all points are aligned along a single vector, namely the tangent vector to the knot at  $f(t_i)$ .

**Definition 2.15.** A point  $x \in C_n[M]$  is *aligned* if (naming its image in  $M^n$  by  $(x_1, \dots, x_n)$ ) for each collection  $x_i = x_j = x_k = \dots$ , the relative vectors  $v_{ij}$  with  $i < j$  are all equal. A point in  $C'_n[M]$  is *aligned* if its projection onto  $C_n[M]$  is aligned and, if we say  $x_i = x_j$  as above, the relative vector  $v_{ij}$  serves as the tangent vector at both  $x_i$  and  $x_j$ .

The subspace of a stratum consisting of points which are aligned is called the *aligned sub-stratum* of that stratum.

**Definition 2.16.** A stratum-preserving map from  $A_n$  to  $C'_n[M, \partial]$  is *aligned* if points in its image are aligned. Let  $AM_n(M)$  denote the space of aligned stratum-preserving maps from  $A_n$  to  $C'_n[M, \partial]$ . Let  $C_n: \text{Emb}(\mathbb{I}, M) \rightarrow AM_n(M)$  be the map which sends a knot  $f$  to its evaluation map  $C_n[f]$ .

In [33] the fourth author establishes the following.

**Theorem 2.17.** *The map  $C_n: \text{Emb}(\mathbb{I}, M) \rightarrow AM_n(M)$  is a model for the  $n$ th degree approximation to  $\text{Emb}(\mathbb{I}, M)$  in the calculus of embeddings.*

As mentioned in the introduction, this result implies that the evaluation map captures all the topology of families of knots in ambient spaces of dimension greater than three. Thus, we are motivated to understand the ramifications of this map in knot theory, and in particular are interested in the effect of  $C_n$  on components of  $\text{Emb}(\mathbb{I}, \mathbb{I}^3)$ .

### 3. THE HOMOTOPY TYPES OF THE FIRST THREE MAPPING SPACE MODELS

In this section, we examine the homotopy types of the first three mapping space models  $AM_i(\mathbb{I}^3)$  for  $i = 1, 2, 3$ . The computations of these homotopy types can be determined quickly if one cites Theorem 2.17 and builds on the analysis of the embedding tower for knots of Goodwillie and Weiss in section five of [16], or alternately if one uses the cosimplicial model for this embedding tower as first envisioned by Goodwillie and developed in [33]. Indeed, the main computations of this section were previously known to Goodwillie and Weiss. We choose a more self-contained approach so that the method of analysis fits with our geometric development of the self-linking invariant in section 4.

One may view  $AM_n(\mathbb{I}^3)$  as a multi-relative mapping space. Standard fibration sequences in algebraic topology allow one to build such a mapping space with building blocks which are loop spaces. In this section we employ some standard facts about categories of diagrams of spaces in order to organize and simplify such an analysis of  $AM_n(\mathbb{I}^3)$ .

First note that  $A_1 = \mathbb{I}$ ,  $C'_1[\mathbb{I}^3] \simeq S^2$  and an aligned map from  $A_1$  has fixed boundary points, so that  $AM_1[\mathbb{I}^3] \simeq \Omega S^2$ , the space of based maps from a circle to  $S^2$ . Moreover, the map from the space of knots sends  $f$  to  $u(f)$  where  $u(f)(t) = \frac{f'(t)}{\|f'(t)\|}$ . This identification is consistent with the fact that in the calculus of embeddings the first approximation to a space of embeddings is the corresponding space of immersions, which in turn can be identified through the Hirsch-Smale theorem [38]. Because  $AM_1[\mathbb{I}^3]$  is connected,  $C_1$  does not give rise to any knot invariants.

We proceed to show that the second mapping space model  $AM_2(\mathbb{I}^3)$  is contractible, from which we conclude that  $C_2$  does not give rise to any knot invariants either. This is an analogue of the fact that there are no non-trivial degree zero or one finite-type invariants. Finally, we show that  $AM_3(\mathbb{I}^3)$  is homotopy equivalent to the third loop space of the homotopy fiber of the inclusion  $S^2 \vee S^2 \hookrightarrow S^2 \times S^2$ . By enumerating components, we show that the evaluation map  $C_3$  can give rise to an integer-valued knot invariant, which is the invariant of study in this paper, defined in Section 4.

For the purposes of the differential topology, it is essential to use the Fulton- MacPherson compactifications of configuration spaces. For the purposes of the algebraic topology in this section, however, it is helpful to use a variant of these compactifications called the *simplicial variant*, essentially first defined by Kontsevich [23] and fully developed in [32]. One main advantage is that, when dealing with the configuration space of  $n$  ordered points in the interval, this compactification coincides with the naive compactification  $\Delta^n$ .

**Definition 3.1.** For a manifold  $M$  with embedding in  $\mathbb{R}^k$  let  $C_n\langle[M]\rangle$  be the closure of the image of  $C_n(M)$  in  $A_{k,n}(M) = (M)^n \times (S^{k-1})^{\binom{n}{2}}$  under the map  $\iota \times \prod \pi_{ij}|_M$ . Let  $\pi_{ij}$  denote the extension of the maps of the same name on the interior of  $C_n\langle[M]\rangle$  which are defined simply by projecting  $A_{k,n}(M)$  onto the  $ij$  factor of  $S^{k-1}$ . For a manifold with two distinguished points on its boundary, define  $C_n\langle[M, \partial]\rangle$  and  $C'_n\langle[M, \partial]\rangle$  as subspaces of  $C_{n+2}\langle[M]\rangle$  as before.

For these compactifications, the combinatorics of the strata which arise in the image of evaluation maps are simplicial. We formalize this stratification as follows.

**Definition 3.2.** Define a  $\Delta_n$ -space to be a collection of spaces  $X_S$ , one for each  $S \subsetneq \{0, \dots, n\}$ , with a map  $f_{S' \subseteq S} : X_S \rightarrow X_{S'}$  for each pair  $S' \subseteq S$  such that  $f_{S' \subseteq S'} \circ f_{S' \subseteq S} = f_{S'' \subseteq S}$ .

In other words, a  $\Delta_n$  space is a contravariant functor from the category of proper subsets of  $\{0, \dots, n\}$  to the category of spaces. In our examples, all  $f_{S \subseteq S'}$  will be inclusions (cofibrations in fact - see below), so that the  $\Delta_n$ -structure describes a stratification. We often use the notation  $X_\bullet$  for  $\Delta_n$ -spaces. As one might expect, there is a natural way of making  $\Delta^n$  into a  $\Delta_n$ -space. Namely, take  $\Delta_\emptyset = \Delta^n$  and  $\Delta_S$  to be the face for which  $t_i = t_{i+1}$  if  $i \in S$  (recall that  $t_0 = 0$  and  $t_{n+1} = 1$  by convention). We write  $\Delta_\bullet^n$  for this  $\Delta_n$ -space.

**Definition 3.3.** Define a  $\Delta_n$ -space  $C_\bullet^n$  as follows.

- $C_\emptyset^n = C'_n\langle[\mathbb{I}^3, \partial]\rangle = C_n\langle[\mathbb{I}^3, \partial]\rangle \times (S^2)^n$ .
- $C_S^n$  is the subspace of all  $(x_j) \times (v_k) \in C'_n\langle[\mathbb{I}^3, \partial]\rangle$  such that for each  $i \in S$ ,  $x_i = x_{i+1}$  and  $\pi_{i,i+1}((x_j)) = v_i = v_{i+1}$ .

It is straightforward to check that  $C_\bullet^n$  is a  $\Delta_n$ -space with  $C_S^n$  homeomorphic to  $C'_{n-\#S}\langle[\mathbb{I}^3, \partial]\rangle$ . Moreover if we replace  $\mathbb{I}^3$  by  $\mathbb{I}$  in the definition of  $C_\bullet^n$ , we recover  $\Delta_\bullet^n$ .

Many constructions for spaces have immediate analogues for  $\Delta_n$ -spaces. A map between  $\Delta_n$ -spaces  $X_\bullet$  and  $Y_\bullet$  is simply a collection of compatible maps from each  $X_S$  to  $Y_S$ . Thus, the set of all maps between two  $\Delta_n$ -spaces is naturally a subspace of  $\prod_S \text{Maps}(X_S, Y_S)$ . The case in which  $X_\bullet = \Delta_\bullet^n$  is of particular use. We call the space of maps from  $\Delta_\bullet^n$  to  $Y_\bullet$  the *corealization* of  $Y_\bullet$  and denote it  $|Y_\bullet|$ .

*Remark.* The corealization of  $Y_\bullet$  is homeomorphic to the homotopy limit of  $Y_\bullet$ . The language of homotopy limits is used in [33].



The following theorem shows that, for the purposes of this section, the corealization  $|C_\bullet^n|$  will replace the mapping space model  $AM_n(\mathbb{I}^3)$ . We will use the notation  $CM_n$  for  $|C_\bullet^n|$  and call it the  $n$ th  $\Delta$ -space model.

Consider the evaluation map for a knot using the cosimplicial compactification  $C_n : C_n\langle[\mathbb{I}, \partial]\rangle = \Delta^n \rightarrow C'_n\langle[\mathbb{I}^3, \partial]\rangle$ . Because this evaluation map is aligned and stratum preserving, it defines a point in  $CM_n$ . The following can be deduced from Theorem 6.2 in [33].

**Theorem 3.4.** *The mapping space model  $AM_n(\mathbb{I}^3)$  is homotopy equivalent to  $CM_n$ . The maps from  $\text{Emb}(\mathbb{I}, \mathbb{I}^3)$  to these mapping spaces given by evaluation maps agree in the homotopy category.*

In light of this theorem, we will now analyze the homotopy types of  $CM_2$  and  $CM_3$ . The notion of a fibration of  $\Delta_n$ -spaces is helpful; this is simply a map of  $\Delta_n$ -spaces with the property that each  $X_S \rightarrow Y_S$  is a (Serre) fibration in the usual sense. For any  $S \subset \{0, \dots, n\}$  let  $\bar{S}$  be its complement. We say that a  $\Delta_n$ -space is cofibrant if each  $X_S$  is a CW complex, the structure maps are inclusions of subcomplexes, and  $X_{\bar{S}} \cap X_{\bar{S}'} = X_{\bar{S} \cap \bar{S}'}$ , where by convention  $X_{\{0, \dots, n\}}$  is empty. Finally, if  $A$  is a space and  $X_\bullet$  is a  $\Delta_n$ -space let  $A \times X_\bullet$  be the  $\Delta_n$  space whose  $S$  entry is  $A \times X_S$  and whose structure maps are the product of the identity on  $A$  with those for  $X_\bullet$ .

The following lemma is a standard part of developing an enriched model structure for  $\Delta_n$ -spaces (as can be developed for any diagram category) [11, 21].

**Lemma 3.5.** *Let  $X_\bullet$  be a cofibrant  $\Delta_n$ -space such that each  $X_S$  is a finite CW complex. Then a fibration of  $\Delta_n$ -spaces  $Y_\bullet \rightarrow Z_\bullet$  induces a fibration on the mapping spaces  $\text{Maps}(X_\bullet, Y_\bullet) \rightarrow \text{Maps}(X_\bullet, Z_\bullet)$ . In particular, a fibration of  $\Delta_n$ -spaces gives rise to a fibration of their corealizations.*

*Proof.* To establish the lifting property we must show that if  $A \hookrightarrow B$  is a cofibration and a weak equivalence and we are given a square

$$\begin{array}{ccc} A & \longrightarrow & \text{Maps}(X_\bullet, Y_\bullet) \\ \downarrow & & \downarrow \\ B & \longrightarrow & \text{Maps}(X_\bullet, Z_\bullet), \end{array}$$

then there is a map  $B \rightarrow \text{Maps}(X_\bullet, Y_\bullet)$  which commutes with the maps in this square. By adjointness it suffices to construct a lift of a map  $B \times X_\bullet \rightarrow Z_\bullet$  to  $Y_\bullet$  extending a lift given on  $A \times X_\bullet$ . We construct this lift inductively over the  $B \times X_S$  starting with  $S$  with  $\#S = n$ , for which we simply cite that  $A \times X_S \hookrightarrow B \times X_S$  is a cofibration and weak equivalence and use the fact that  $Y_S \rightarrow Z_S$  is a fibration. Suppose we have constructed a lift on all  $B \times X_{S'}$  for  $S \subset S'$ . From the definition of cofibrant  $\Delta_n$ -space it follows that the map from the colimit of the  $X_{S'}$  over  $S \subset S'$  to  $X_S$  is a cofibration. Therefore, the union of  $A \times X_S$  with  $\bigcup_{S \subset S'} (B \times X_{S'})$  sits in  $B \times X_S$  as a cofibration and a weak equivalence, so we may again extend by the fact that  $Y_S \rightarrow Z_S$  is a fibration.  $\square$

Our basic strategy in analyzing  $CM_2$  and  $CM_3$  is to fiber  $C_\bullet^n$  as  $F_\bullet^n \rightarrow C_\bullet^n \xrightarrow{\pi} K_\bullet^n$  where  $K_\bullet^n$  is of a form in which its corealization can be shown to be contractible explicitly. For  $n = 2$ ,  $\pi$  will be an equivalence, and for  $n = 3$  we identify  $|F_\bullet^3|$ .

**Theorem 3.6.** *The space  $CM_2$  is contractible.*

*Proof.* Our knots begin at the “north” side of  $\mathbb{I}^3$  and end at the “south” side, iso that  $v_0(x) = v_3(x) = *$ , where  $*$  denotes the south pole of  $S^2$ . We make use of the degree one map  $\sigma : S^2 \rightarrow S^2$  which collapses the southern hemisphere to the south pole, which gives  $\sigma \circ \pi_{0,i} = \sigma \circ \pi_{i,3} = *$  for  $i = 1, 2$ . Define  $K_\bullet^2$ , which is obtained from  $C_\bullet^2$  basically by projecting  $C_2\langle[\mathbb{I}^3, \partial]\rangle$  onto  $S^2$  through  $\sigma \circ \pi_{12}$ . Explicitly, we have the following:

$$\begin{array}{ccccccc} K_\emptyset^2 = (S^2)^3 & & K_{\{a\}}^2 = S^2 & & K_{\{a,b\}}^2 = pt. & & \\ i_{\{a\} \subset \{a,b\}}(pt.) = * & & i_{\emptyset \subset \{2\}}(x) = (*, *, *) & & i_{\emptyset \subset \{0\}}(x) = (*, *, x) & & i_{\emptyset \subset \{1\}}(x) = (\sigma(x), x, x) \end{array}$$

We view a  $\Delta^n$ -space as a diagram of spaces, one sitting at each barycenter in the  $n$ -simplex, with a morphism for each face relation. As a diagram,  $K_{\bullet}^2$  is the following:

$$\begin{array}{ccccc}
 & & K_{\{0,2\}}^2 = * & & \\
 & & \swarrow & & \searrow \\
 & K_{\{0\}}^2 = S^2 & & & K_{\{2\}}^2 = S^2 \\
 & \swarrow & & \swarrow & \searrow \\
 & & K_{\emptyset}^2 = (S^2)^3 & & \\
 & \swarrow & \uparrow & \searrow & \\
 K_{\{0,1\}}^2 = * & \longrightarrow & K_{\{1\}}^2 = S^2 & \longleftarrow & K_{\{1,2\}}^2 = *
 \end{array}$$

The fibration  $\pi$  from  $C_{\bullet}^2$  to  $K_{\bullet}^2$  is defined as  $(\sigma \circ \pi_{12}) \times v_1 \times v_2$ , a map of  $\Delta_2$ -spaces. Furthermore, the fiber of this map restricted to each  $C_S^2$  is contractible, so the induced map from  $|C_{\bullet}^2|$  to  $|K_{\bullet}^2|$  is an equivalence. We now show that  $|K_{\bullet}^2|$  is contractible.

Define a  $\Delta_2$ -space  $Y_{\bullet}$  by projecting  $K_{\emptyset}^2$  onto its first factor of  $S^2$ , and taking  $Y_S$  to be the image of  $K_S^2$  under this projection. In particular  $Y_{\{2\}} = Y_{\{0\}} = *$ . The projection from  $K_{\bullet}^2$  to  $Y_{\bullet}$  is readily seen to be a fibration of  $\Delta_2$ -spaces. It is also easy to see that  $|Y_{\bullet}|$  is contractible; unraveling definitions, it is the space of maps from  $\Delta^2$  to  $S^2$  sending the  $\{0\}$  and  $\{2\}$  sides of  $\Delta^2$  to the south pole of  $S^2$ . Since  $\Delta^2$  deformation retracts onto the union of these two sides, the mapping space can be retracted to the constant map  $\Delta^2 \mapsto *$ .

We finish the argument by bootstrapping: the contractibility of  $|Y_{\bullet}|$  means that we may replace  $K_{\bullet}^2$  by its fiber over  $Y_{\bullet}$ . The next step is to project this fiber to one of the other factors of  $S^2$ , say with  $v_1$ . The corealization of this projection is also contractible, since, unraveling definitions, it is the space of maps from  $\Delta^2$  to  $S^2$  sending the  $\{2\}$  edge (by definition) and the  $\{1\}$  edge (since we are in the fiber over  $Y_{\bullet}$ ) to the south pole, which is contractible. Repeating this with the  $v_2$  projection onto  $S^2$  we see that  $|K_{\bullet}^2|$  is indeed contractible.  $\square$

In our bootstrapping argument, it *does* matter onto which factor of  $S^2$  we project  $K_{\bullet}^2$  first. The image under the  $v_1$  or  $v_2$  projection does not have a corealization which is readily seen to be contractible without first looking in the fiber of the  $\pi_{12}$  projection.

Before proceeding to the next case, we must treat one last technical detail about  $\Delta^n$ -spaces, namely that of replacing a map by a fibration, as is standard for spaces.

**Definition 3.7.** Let  $f: X_{\bullet} \rightarrow Y_{\bullet}$  be a map of  $\Delta_n$ -spaces and define the spaces and maps  $X_{\bullet} \xrightarrow{i} \tilde{X}_{\bullet} \xrightarrow{\tilde{f}} Y_{\bullet}$  as follows. Let  $\tilde{X}_S$  be the space of pairs  $(x, \gamma)$  where  $x \in X_S$  and  $\gamma$  is a path in  $Y_S$  with  $\gamma(0) = f_S(x)$ . Inclusions between the  $\tilde{X}_S$  needed for the  $\Delta_n$ -structure are defined by using those for  $X_S$  and  $Y_S$ . The map  $i$  is defined by sending  $x$  to  $(x, c)$ , where  $c$  is the constant path at  $f_S(x)$ . The map  $\tilde{f}$  is defined by sending  $(x, \gamma)$  to  $\gamma(1)$ .

One may check that sending  $(x, \gamma) \in \tilde{X}_S$  to  $x \in X_S$  defines a homotopy inverse to  $i$  as  $\Delta^n$ -spaces so that  $i$  induces an equivalence on corealizations. Moreover, it is easy to check that  $\tilde{f}$  is a fibration.

**Theorem 3.8.** *The space  $AM_3(\mathbb{I}^3)$  is homotopy equivalent to  $\Omega^3 F$ , the space of based maps from  $S^3$  to  $F$ , the homotopy fiber of the inclusion  $S^2 \vee S^2 \hookrightarrow S^2 \times S^2$ .*

Moreover,  $F$  is known to be  $\Sigma(\Omega S^2 \wedge \Omega S^2)$ , which splits as a countable wedge of spheres by the James splitting (compare with Corollary 5.6 of [16]).

**Corollary 3.9.** *The components of  $AM_3(\mathbb{I}^3)$  are in bijective correspondence with the integers.*

*Proof.* By the theorem, the components of  $AM_3(\mathbb{I}^3)$  correspond to elements of  $\pi_3(F)$ . Since  $\pi_3(S^2) = \mathbb{Z}$ , we have  $\pi_3(S^2 \times S^2) = \mathbb{Z}^2$  and by the Hilton-Milnor theorem [20],  $\pi_3(S^2 \vee S^2) = \mathbb{Z}^3$ . Because the composites  $S^2 \vee S^2 \hookrightarrow S^2 \times S^2 \rightarrow S^2$  are split, we see that  $\pi_3(F) = \mathbb{Z}$ .  $\square$

*Proof of Theorem 3.8.* We will be a bit more terse than in the previous proof since the outline of the argument is precisely the same.

Once again we begin by defining a relatively simple  $K_\bullet^3$  to which  $C_\bullet^3$  maps. Set  $K_\emptyset^3 = (S^2)^6$  and define a map from  $C_\bullet^3$  over  $K_\bullet^3$  by composing  $\pi_{12} \times \pi_{23} \times \pi_{13} \times v_1 \times v_2 \times v_3$  with the collapsing map  $\sigma$  (from the previous proof) on the first three factors. We can give  $K_\bullet^3$  the structure of a  $\Delta_3$ -space simply by defining the subspaces  $K_S^3$  to be the images of the corresponding spaces in  $C_\bullet^3$ .

The first step is to show that  $|K_\bullet^3|$  is contractible. Define a  $\Delta_3$ -space  $Y_\bullet$  exactly as in the previous proof, by projecting  $K_\bullet^3$  onto the first factor of  $S^2$  (once again, the image of  $\pi_{12}$ ). The corealization is manifestly contractible; since  $Y_{\{2,3\}} = Y_{\{0\}} = *$ , we may define the contraction by deforming  $\Delta_3$  onto the union of this edge and face. Thus we may consider the fiber of  $K_\bullet^3$  over  $Y_\bullet$ . Next consider the projections to  $S^2$  defined by  $v_1$  and  $v_2$  in turn. We claim the corealization of each is contractible; for instance, under the projection  $v_1$ , the  $\{0\}$  face (by definition) and  $\{1\}$  face (by the bootstrap) map to  $*$ . The claim follows since  $\Delta_3$  can be contracted to the union of these faces. Proceeding in a symmetric way for the other factors of  $S^2$  shows that  $|K_\bullet^3|$  is contractible, as desired.

By construction, there is a projection map  $\pi: C_\bullet^3 \rightarrow K_\bullet^3$  so in principal we should be able to identify  $C_\bullet^3$  with the fiber of this projection. But, this projection is not a fibration of  $\Delta_3$ -spaces, since in particular it is not a fibration on  $C_\emptyset^3$ . Using Definition 3.7 we may replace  $C_\bullet^3$  by a  $\tilde{C}_\bullet^3$  which has an equivalent corealization and which does fiber over  $K_\bullet^3$  through a map  $\tilde{\pi}$ . Investigating the fiber  $F_\bullet$  of  $\tilde{\pi}$  we see that  $F_S$  is contractible if  $S$  is non-empty, since in these cases  $\pi_S$  is a homotopy equivalence which implies that  $\tilde{\pi}_S$  is as well. A  $\Delta_n$ -space  $X_\bullet$  with  $X_S$  contractible for all non-empty  $S$  has a corealization which is homotopy equivalent to  $\Omega^n X_\emptyset$ . Thus, the corealization of  $F_\bullet$  is  $\Omega^3 F_\emptyset$ . But by definition  $F_\emptyset$  is the homotopy fiber of the projection  $\pi_{12} \times \pi_{23} \times \pi_{13}$  from  $C_3(\mathbb{R}^3)$  to  $(S^2)^3$ . By looking at the fiber of  $\pi_{12}$  (which is by itself a fibration) this is the same as the fiber of  $\pi_{13} \times \pi_{23}$  from  $\mathbb{R}^3 \setminus \{a_1, a_2\}$  to  $S^2 \times S^2$  where in this case  $\pi_{13}$  sends  $z \in \mathbb{R}^3 \setminus \{a_1, a_2\}$  to the unit vector from  $a_1$  to  $z$  (and similarly for  $\pi_{23}$ ). Retracting  $\mathbb{R}^3 \setminus \{a_1, a_2\}$  onto  $S^2 \vee S^2$  we see that  $\pi_{13} \times \pi_{23}$  coincides with the inclusion  $S^2 \vee S^2 \hookrightarrow S^2 \times S^2$ .  $\square$

#### 4. LINKING OF COLLINEARITY MANIFOLDS

**4.1. Definition of  $\nu_2$ .** In this section we formalize the definition of our self-linking invariant  $\nu_2$ . In order to proceed we need to address technicalities about collinearity submanifolds of compactified configuration spaces.

**Definition 4.1.** Define  $\mathbf{Co}_i(\mathbb{I}^k)$  to be the subspace of  $C_3(\mathbb{I}^k)$  consisting of configurations of points  $x = (x_1, x_2, x_3)$  such that  $\{x_1, x_2, x_3\} \subseteq L$  where  $L$  is a straight line in  $\mathbb{R}^k$ , and in that line  $x_i$  is between the other two points. Alternatively,  $\mathbf{Co}_i(\mathbb{I}^k)$  is the preimage of the submanifold of  $S^{k-1} \times S^{k-1}$  defined by pairs  $u \times -u$  under the map  $\pi_{ij} \times \pi_{i\ell}$ .

As mentioned in Theorem 2.3, the maps  $\pi_{ij}$  extend to smooth maps from  $C_n[\mathbb{I}^k, \partial]$  to  $S^{k-1}$  simply by restricting the projection of  $B_{n,k}$  onto the  $ij$  factor of  $S^{k-1}$ . Let  $\tilde{\pi}_{ij}: \tilde{C}_n(\mathbb{R}^k) \rightarrow S^{k-1}$  be the unique map which factors  $\pi_{ij}$  through  $\tilde{C}_n(\mathbb{R}^k)$ . Using the decomposition of Theorem 2.8 and the coordinates around these strata given in [32], we deduce that  $\pi_{ij} \times \pi_{ik}$  restricted to a stratum  $S_{\mathcal{P}}$  on the boundary of  $C_3[\mathbb{I}^k]$  is either projection onto a factor of  $\tilde{C}_2(\mathbb{R}^k) \times \tilde{C}_2(\mathbb{R}^k)$  or factors as projection onto  $\tilde{C}_3(\mathbb{R}^k)$  followed

by  $\tilde{\pi}_{12} \times \tilde{\pi}_{13}$ . We deduce that the maps  $\pi_{ij}$  are open maps. We obtain the following proposition as a consequence of transversality.

**Proposition 4.2.** *The submanifolds  $\mathbf{Co}_i(\mathbb{I}^k)$  extend to be submanifolds with corners of  $C_n[\mathbb{I}^k, \partial]$ , which we denote  $\mathbf{Co}_i[\mathbb{I}^k]$ .*

It will be helpful at times to be more explicit about some of the boundary of  $\mathbf{Co}_i[\mathbb{I}^k]$ .

**Proposition 4.3.** *The submanifold  $\mathbf{Co}_i[\mathbb{I}^k]$  has the following intersections with boundary strata.*

- In  $S_{(i=j)}$ , consisting of pairs  $(x_1, x_2) \times ((y_1, y_2) / \sim) \in C_2(\mathbb{I}^k) \times \tilde{C}_2(\mathbb{R}^k)$  such that  $x_2 - x_1 = -k(y_2 - y_1)$  where  $k > 0$ .
- In  $S_{(1=2=3)}$ , consisting of equivalence classes in  $\tilde{C}_3(\mathbb{R}^k)$  which are represented by collinear triples.
- In  $S_{((i=j)=k)}$ , consisting of points represented by  $x, v, -v$  in  $\mathbb{I}^3 \times \tilde{C}_2(\mathbb{R}^k) \times \tilde{C}_2(\mathbb{R}^k)$ .

For the sake of transversality arguments we choose the boundary points on  $\mathbb{I}^3$ , as needed for the definitions for  $\text{Emb}(\mathbb{I}, \mathbb{I}^3)$  and  $AM_n(\mathbb{I}^3)$ , to be  $(\frac{1}{2}, \frac{1}{2}, 0)$  and  $(\frac{1}{2} + \epsilon, \frac{1}{2}, 1)$  for some  $\epsilon > 0$ . We choose the tangent vectors at those points to be perpendicular to the boundary.

**Theorem 4.4.** *Any  $g \in AM_3(\mathbb{I}^3)$  is arbitrarily close to some  $g' \in AM_3(\mathbb{I}^3)$  which is transverse to  $\mathbf{Co}_i[\mathbb{I}^3]$  for  $i = 1, 3$ .*

*Proof.* We may establish this inductively over the strata of  $A_3$  using the Extension Theorem from [18]. The images under  $g$  of the vertices of  $A_3$ , which are fixed by choosing boundary points and vectors in  $\mathbb{I}^3$ , are disjoint from  $\mathbf{Co}_i[\mathbb{I}^3]$  by our choice above. Inductively, we may deform  $g$  slightly to be transverse to  $\mathbf{Co}_i[\mathbb{I}^3]$  on the dimension  $i$  strata, having fixed it on the dimension  $i - 1$  strata, by using Proposition 4.3 to check that the intersections of  $\mathbf{Co}_i[\mathbb{I}^3]$  with the aligned strata of  $C_3[\mathbb{I}^3, \partial]$  have codimension two, which is true in all cases except when  $i = 2$  and the stratum in question is labeled by  $(1 = 2 = 3)$  or any parenthesization which includes  $(1 = 2 = 3)$ .  $\square$

**Definition 4.5.** Given  $g \in AM_3(\mathbb{I}^3)$ , deform  $g$  to be transverse to  $\mathbf{Co}_i[\mathbb{I}^3]$  for  $i = 1, 3$  and define  $\mathbf{Co}_i[g]$ , the subspaces of collinear points, to be  $g^{-1}(\mathbf{Co}_i[\mathbb{I}^3]) \subset A_3$ .

In the interest of defining knot invariants directly, we also show that the evaluation map of a knot can be made transverse to collinearity submanifolds by a small isotopy of the knot.

**Theorem 4.6.** *For a generically positioned knot  $f$ ,  $C_3[f]$  is transverse to  $\mathbf{Co}_i[\mathbb{I}^3]$  for  $i \in \{1, 3\}$ .*

*Proof.* Let  $sk_i(A_n)$  be the  $i$ -skeleton of  $A_n$ . For any knot  $f : \mathbb{I} \rightarrow \mathbb{I}^3$ ,  $C_3[f]|_{sk_0(A_3)}$  is disjoint from  $\mathbf{Co}_i[\mathbb{I}^3]$  by our choice of endpoint data for  $f$ . Transversality of  $C_3[f]$  over  $sk_1(A_3)$  can be guaranteed by demanding that the tangent lines to  $f$  do not intersect  $f(0)$  or  $f(1)$ , a generic condition.

For the two-skeleton investigate the transversality face-by-face. Collinear points in  $A_3^{(0=1)}$  correspond to collinearities on the knot which include  $f(0)$ , so one is guaranteed transversality if the projection of the knot to the sphere based at  $f(0)$  is a regular knot diagram, which is well-known to be a generic condition. Transversality in  $A_3^{(3=4)}$  works similarly.

Collinearities in the  $A_3^{(1=2)}$  and  $A_3^{(2=3)}$  correspond, combining Proposition 4.3 with the definition of the evaluation map, to pairs of times  $s, t$  such that the tangent line of  $f$  at  $s$  intersects the knot at  $f(t)$ . Informally, transversality requires that small variations of  $s$  and  $t$  should give rise to a two-dimensional family of non-collinear triples. Formally, this means that the three vectors  $f(s) - f(t)$ ,  $f'(t)$  and  $f''(s)$  are linearly independent. This condition has a simple geometric interpretation. Provided the knot  $f$  has everywhere non-zero curvature, the map  $\exp : \mathbb{I} \times (\mathbb{R} - \{0\}) \rightarrow \mathbb{R}^3$  given by  $\exp(t, h) = f(t) + hf'(t)$  is an immersed submanifold of  $\mathbb{R}^3$ . The above transversality condition is equivalent to the condition that  $f$  intersects the image of  $\exp$  transversally, which is a generic condition. The fact that non-zero curvature is a generic condition for knots follows quickly from the Frenet-Serret Theorem [27].

Finally, for an interior point  $(t_1, t_2, t_3) \in A_3^\phi$  the transversality condition is that for a collinear triple, the four vectors  $f(t_1) - f(t_2)$ ,  $f'(t_1), f'(t_2), f'(t_3)$  must span  $\mathbb{I}^3$ . While difficult to see intuitively, this is straightforward to prove formally. Consider the map  $\Phi : SO_3 \times \mathbb{I}^3 \rightarrow (\mathbb{I}^2)^3$  which sends a rotation matrix  $A \in SO_3$  and three times  $t_1, t_2, t_3$  to the orthogonal projections of  $A(f(t_1)), A(f(t_2)), A(f(t_3))$  to  $(\mathbb{I}^2 \times \{0\})^3 \subseteq (\mathbb{I}^3)^3$ . Our transversality condition follows if  $\Phi$  transversally intersects the diagonal  $x_1 = x_2 = x_3$  in  $(\mathbb{I}^2 \times \{0\})^3$ . Apply a standard transversality argument, extending  $\Phi$  to a function  $\overline{\Phi} : SO_3 \times \mathbb{I}^3 \times \mathbb{I}^k \rightarrow (\mathbb{I}^2 \times \{0\})^3$ , such that  $\overline{\Phi}|_{SO_3 \times \mathbb{I}^3 \times \{0\}} = \Phi$ , which is transverse to the diagonal. The Transversality Theorem [18] tells us that an arbitrarily small isotopy of  $f$  satisfies our transversality condition.  $\square$

Finally, we analyze where the boundaries of these collinearity submanifolds may lie.

**Proposition 4.7.** *Any  $g \in AM_3(\mathbb{I}^3)$  may be deformed slightly so that the 1-manifold  $\mathbf{Co}_1[g]$  has boundary only on  $A_3^{(1=2)}$  and  $A_3^{(3=4)}$ . Similarly,  $\mathbf{Co}_3[g]$  may be assumed to have boundary only on  $A_3^{(0=1)}$  and  $A_3^{(2=3)}$ .*

*Proof.* We focus on  $\mathbf{Co}_1[g]$  since the arguments for  $\mathbf{Co}_3[g]$  are identical up to re-indexing and “turning  $\mathbb{I}^3$  upside-down.” We apply Proposition 4.3 and analyze only the codimension one faces of  $A_3$  since by Theorem 4.4 there are no boundary points on strata with higher codimension.

To set notation, let  $a \in A_3$  and let  $p(g(a)) = (x_1, x_2, x_3) \in (\mathbb{I}^3)^3$ . By definition of an aligned map, the images of the  $A_3^{(0=\dots=3)}$ ,  $A_3^{(1=\dots=4)}$  and  $A_3^{(1=2=3)}$  under  $g$  are all in  $\mathbf{Co}_2[\mathbb{I}^3]$ , so  $\mathbf{Co}_1[g]$  has no boundary on these strata. Next,  $g(a)$  for  $a \in A_3^{(0=1=2)}$  has  $x_1 = x_2 = (\frac{1}{2}, \frac{1}{2}, 0)$  and  $\pi_{12}$  pointing downwards. Thus, a  $\mathbf{Co}_1[g]$ -collinearity would force  $g(t_3)$  to be above  $\mathbb{I}^3$ , which of course is not allowed. On both  $A_3^{(2=3=4)}$  and  $A_3^{(2=3)}$ , we have  $\pi_{12}(g(a)) = \pi_{13}(g(a))$ , which means that these unit vectors cannot be opposites as required for  $\mathbf{Co}_1[g]$ . Finally, on  $A_3^{(0=1)}$  we have  $x_1(g(a)) = (\frac{1}{2}, \frac{1}{2}, 0)$  so that a  $\mathbf{Co}_1[g]$ -collinearity would require that both  $x_2$  and  $x_3$  have last coordinate zero and be on a line, which is a codimension three condition.  $\square$

Because  $\mathbf{Co}_1[f]$  and  $\mathbf{Co}_3[f]$  have no boundary on the hidden faces of  $C_3[\mathbb{I}, \partial]$ , they project to manifolds with boundary in  $\Delta^3$ . By abuse, we give this projection the same name, and for the rest of the paper we will work in the simplex  $\Delta^3$ . Moreover  $\mathbf{Co}_i(\mathbb{R}^k)$ , and thus  $\mathbf{Co}_i(\mathbb{I}^k)$ , is orientable since it is diffeomorphic to the product  $(\mathbb{R}^k) \times S^{k-1} \times (0, \infty)^2$ . Thus  $\mathbf{Co}_i[\mathbb{I}^k]$  is orientable, and we fix such an orientation for the remainder of this discussion. By pulling back the orientation of the normal bundle of  $\mathbf{Co}_i[\mathbb{I}^3]$  in  $C_3[\mathbb{I}^3, \partial]$ , we get an orientation of  $\mathbf{Co}_i[g]$  for any  $g \in AM_3(\mathbb{I}^3)$ .

Instead of labeling the faces of  $\Delta^3$  by subsets of  $\{0, \dots, 3\}$ , as in the definition of  $\Delta_\bullet^3$ , we now use parenthesizations, as inherited from the projection from  $A_3$ .

**Definition 4.8.** Define a closure of the manifold with boundary  $\mathbf{Co}_1[g]$  to be any closed piecewise smooth 1-manifold  $\overline{\mathbf{Co}_1[g]}$  whose intersection with  $\text{Int}(\Delta^3)$  is  $\mathbf{Co}_1(g)$ , and whose intersection with  $\partial(\Delta^3)$  lies only in  $\Delta_{(1=2)}^3$  and  $\Delta_{(3=4)}^3$ . Define  $\overline{\mathbf{Co}_3[g]}$  similarly.

A Seifert surface for  $\overline{\mathbf{Co}_1[g]}$  can only intersect  $\overline{\mathbf{Co}_3[g]}$  inside the simplex, and these completions have an orientation determined by the orientations on  $\mathbf{Co}_i[g]$ . Thus, the linking number of these two manifolds is defined and will be independent of choices of these completions. We may now define our invariant.

**Definition 4.9.** For  $g \in AM_3(\mathbb{I}^3)$ , let  $\mu_2(g) = lk(\overline{\mathbf{Co}_1[g]}, \overline{\mathbf{Co}_3[g]})$ . For a knot, define  $\nu_2(\mathcal{K})$  to be  $\mu_2(C_3[\mathcal{K}])$ .

A homotopy between  $f$  and  $g$  in  $AM_3$  may again be deformed to be transverse to the collinearity conditions, and thus give rise to an oriented cobordism between the manifolds  $\mathbf{Co}_i[f]$  and  $\mathbf{Co}_i[g]$ . Thus,  $\mu_2$  passes to a map  $\pi_0(AM_3(\mathbb{I}^3)) \rightarrow \mathbb{Z}$ . We next establish that this invariant encodes all of the information we may get about knotting in  $\mathbb{I}^3$  from the evaluation map  $C_3[f]$ .

**4.2.  $\mu_2$  is an isomorphism.** By Theorem 3.8,  $\pi_0(AM_3(\mathbb{I}^3)) \cong \pi_3(F)$ , where  $F$  is the homotopy fiber of the inclusion from  $S^2 \vee S^2$  to  $S^2 \times S^2$ . The composites  $S^2 \vee S^2 \rightarrow S^2 \times S^2 \rightarrow S^2$ , where the second map is projection onto a factor, are split so that  $\pi_3(F)$  is a subgroup of  $\pi_3(S^2 \vee S^2)$ . That subgroup is isomorphic to the integers, with the isomorphism realized by sending an  $f: S^3 \rightarrow S^2 \vee S^2$  to  $lk_{S^3}(f^{-1}(a), f^{-1}(b))$ , where  $a \in (S^2 \vee *) \setminus \{*\}$  and  $b \in (* \vee S^2) \setminus \{*\}$  are regular values of  $f$ . This observation led us to our definition of  $\mu_2$ , and one could trace through the equivalence given by Theorem 3.8 in order to equate  $\mu_2$  with this linking number and thus show that  $\mu_2$  is an isomorphism. To do this a good choice of embedding  $S^2 \vee S^2 \subset \mathbb{R}^3 \setminus \{a, b\}$  is with one sphere is centered at  $b$  of radius  $|a - b|/2$ , and the second sphere is centered at  $a$  of radius  $3|a - b|/2$ . We prefer an indirect but shorter approach, which takes advantage of our computations from Section 5.

**Definition 4.10.** Fix a generic embedding of the unknot  $U$  in  $\mathbb{I}^3$ , whose collinearity submanifolds are empty. Let  $\phi|C_\bullet^3|$  and  $\phi|F_\bullet^3|$  denote the subspaces of  $|C_\bullet^3|$  and  $|F_\bullet^3|$  respectively of maps whose restriction to  $\partial\Delta^3$  coincides with the restriction to  $\partial\Delta^3$  of  $C_3[U]$ , or respectively coincides on  $\partial\Delta^3$  with a chosen lift of  $C_3[U]$  to  $|F_\bullet^3|$ .

**Theorem 4.11.** *There is a commutative diagram*

$$\begin{array}{ccccc} \pi_0(|F_\bullet^3|) = \mathbb{Z} & \xrightarrow{(1)} & \pi_0(|C_\bullet^3|) & \xrightarrow{\mu_2} & \mathbb{Z} \\ (2) \uparrow & & \uparrow & & (5) \uparrow \\ \pi_0(\phi|F_\bullet^3|) & \xrightarrow{(4)} & \pi_0(\phi|C_\bullet^3|) & \xrightarrow{(3)} & \pi_3(C_3\langle[\mathbb{I}^3]\rangle) \end{array}$$

where the maps (1) and (2) are isomorphisms of sets and the maps (3), (4), and (5) are homomorphisms.

We first indicate how this theorem leads to the main result of this subsection.

**Corollary 4.12.** *The map  $\mu_2$  is an isomorphism.*

*Proof.* Chasing through the diagram in Theorem 4.11 we see that  $\mu_2$  is a homomorphism since it is the composite of two bijections, the inverses to (1) and (2), with the homomorphisms (3), (4), and (5).

In Theorem 5.12 below, we show that  $\mu_2$  takes on the value one (for the evaluation map of the trefoil knot) and thus must be an isomorphism.  $\square$

*Proof of Theorem 4.11.* We define the maps in the diagram.

- (1) The map (1) is the map on  $\pi_0$  of the induced map on corealizations of the composite map of  $\Delta_n$ -spaces  $F_\bullet \rightarrow \tilde{C}_\bullet^3 \rightarrow C_\bullet^3$ , which is shown to be an equivalence in Theorem 3.8.
- (2) Because all of the boundary terms of  $F_\bullet^3$  are contractible, we may induct over the skeleta of  $\partial\Delta^3$  to show that the inclusion of  $\phi|F_\bullet^3|$  in  $|F_\bullet^3|$  is an equivalence, and thus define (2) as the induced isomorphism.
- (3) The map (3) is a case of a general construction which we now recall.

If  $\mathcal{M}$  is a space of maps from  $\Delta^n$  to  $X$  whose restriction to  $\partial\Delta^n$  is prescribed,  $\mathcal{M}$  is homotopy equivalent to  $\Omega^n X$  as follows. Fix one particular  $f \in \mathcal{M}$ . Define the ‘‘gluing with  $f$ ’’ map  $\Gamma_f: \mathcal{M} \rightarrow \Omega^n X$  by having  $\Gamma_f(g): S^n = \Delta^n \cup_{\partial} \Delta^n \rightarrow X$  restrict to  $f$  on the first  $\Delta^n$  and  $g$  on the second.

The map (3) is  $\pi_0(\Gamma_{C_3[U]})$ . It is an isomorphism of sets since  $\Gamma_{C_3[U]}$  is a homotopy equivalence. In fact we use this isomorphism to define the group structure on  $\pi_0(\phi|C_\bullet^3|)$ .

- (4) The map underlying (4) is simply the restriction of the map underlying (1) to  $\phi|F_\bullet^3|$ , which maps to  $\phi|C_\bullet^3|$  by construction. It induces a homomorphism on  $\pi_0$  since it sits in a commutative square

$$\begin{array}{ccc} \phi|F_\bullet^3| & \xrightarrow{(4)} & \phi|C_\bullet^3| \\ \Gamma_{C_3[\overline{U}]} \downarrow & & \Gamma_{C_3[U]} \downarrow \\ \Omega^3 F_\phi & \longrightarrow & \Omega_3(C_3\langle[\mathbb{I}^3]\rangle), \end{array}$$

where the vertical arrows are used to define the group structures on  $\pi_0$  of  $\phi|F_\bullet^3|$  and  $\phi|C_\bullet^3|$  and the bottom arrow is a homomorphism on  $\pi_0$  since it is a map of three-fold loop spaces.

- (5) Finally, the map (5) is defined by taking an  $f : S^3 \rightarrow C_3\langle[\mathbb{I}^3, \partial]\rangle$ , homotoping it so that its image is in  $C_3(\mathbb{I}^3)$  (whose inclusion in  $C_3\langle[\mathbb{I}^3, \partial]\rangle$  is a homotopy equivalence) and transverse to  $Co_1$  and  $Co_3$ , and then taking  $lk_{S^3}(Co_1(f), Co_3(f))$ . In general, sending  $\pi_n(M)$  to  $\mathbb{Z}$  by taking the linking number of the preimages of two disjoint closed submanifolds of  $M$  (which itself need not be closed) whose codimensions add to  $n + 1$  is a homomorphism, so in particular (5) is a homomorphism.

It is straightforward to check that the maps as constructed commute since  $C_3[U]$  has empty collinearity submanifolds, and this completes the proof. □

### 5. EXAMPLES

Clearly if  $\mathcal{K}$  is the unknot,  $\nu_2(\mathcal{K}) = 0$ , since any reasonably simple generic embedding of the unknot has no collinear triples. In this section we will compute  $\nu_2(\mathcal{K})$  directly for the trefoil and figure eight knots. To do so, one could parametrize these knots and solve the systems of equations which arise from collinearity conditions. Indeed as explained further at the end of Section 6, one application of our work is to, for example, bound the value of the degree two Vassiliev invariant of a knot which is parametrized by polynomials of a given degree. We prefer to take a slightly less explicit but more geometric approach by choosing embeddings with certain monotonicity properties, which are depicted in figures 5.1 and 5.2. Throughout this section we give full arguments for the trefoil but leave the entirely analogous arguments for the figure eight to the reader. This analysis will proceed first by finding boundary points of the collinearity submanifolds, and will ultimately highlight the fact that quadriseccants of the knot may play an essential role in computation of the invariant, a theme which is fully developed in the next section.

**Figure 5.1.**

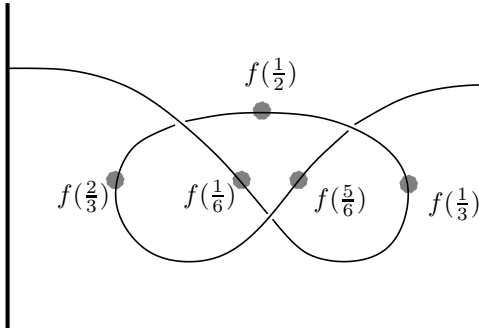

*x<sub>3</sub> = 0 points on the trefoil knot*

**Figure 5.2.**

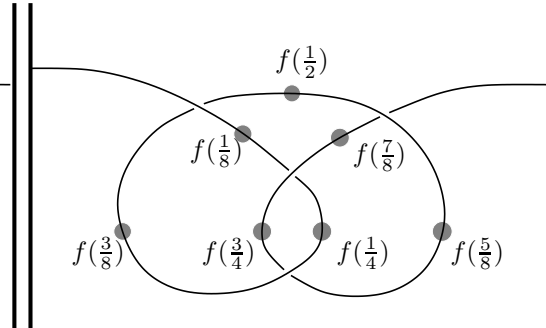

*x<sub>3</sub> = 0 points on the figure-8 knot.*

The plane into which the knot is projected will be given the coordinates  $x_1$  and  $x_2$ , and the coordinate that points out of the  $(x_1, x_2)$ -plane will be the  $x_3$  coordinate. In Figures 5.1 and 5.2 the  $x_3 = 0$  points of the embedding are specified by dots, five for the trefoil and seven for the figure eight. It will simplify the complexity of the collinearity submanifolds to assume that between each of the dots the coordinate function  $x_3(t)$  strictly increases and then strictly decreases or vice-versa.

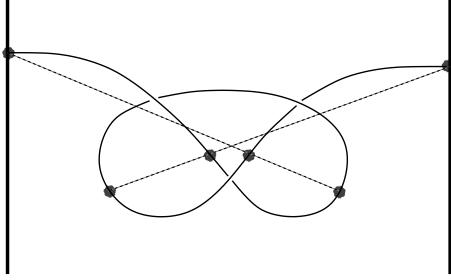
**Figure 5.3.**

*collinear triples on (0 = 1) and (3 = 4) strata.*

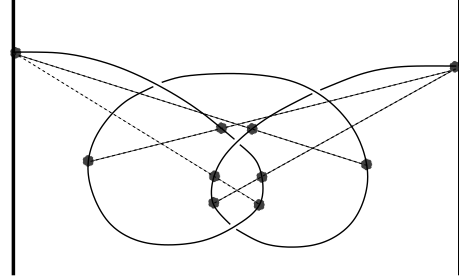
**Figure 5.4.**

*collinear triples on (0 = 1) and (3 = 4) strata.*

In Figures 5.3 and 5.4 all the collinear triples  $(f(t_1), f(t_2), f(t_3))$  where either  $t_1 = 0$  or  $t_3 = 1$  are indicated. On  $A_3^{(0=1)}$ , one can label any collinear triple by the number  $t \in \mathbb{I}$ , such that the line segment  $[f(0), f(t)]$  contains one point of the knot  $\mathcal{K}$  in its interior. In the case of the trefoil there are no collinear triples for  $t \in [0, \frac{1}{6}]$  since  $x_3(t)$  is decreasing on that interval. There is the one solution in  $[\frac{1}{6}, \frac{1}{3}]$  as sketched above, since the knot near  $t = \frac{5}{6}$  sits over the line from  $f(0)$  to  $f(\frac{1}{6})$  but under the line from  $f(0)$  to  $f(\frac{1}{3})$ . There are no solutions for  $t \geq \frac{1}{3}$  except possibly one in  $[\frac{5}{6}, 1]$ , which would give rise to a point of  $\mathbf{Co}_2[f]$ , and so is ignored.

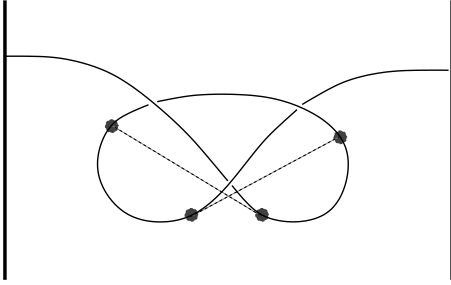
**Figure 5.5.**

*collinear triples on the (1 = 2) and (2 = 3) strata.*

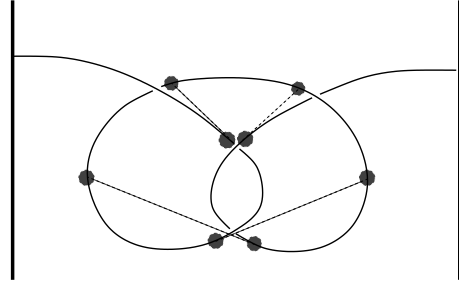
**Figure 5.6.**

*collinear triples on the (1 = 2) and (2 = 3) strata.*

In Figures 5.5 and 5.6 all the tangential collinear triples, elements of  $\mathbf{Co}_i[f]$  for  $i \in \{1, 3\}$  which lie in the  $A_3^{(1=2)}$  and  $A_3^{(2=3)}$  are indicated. In all these figures, points corresponding to  $\mathbf{Co}_2[f]$  are systematically ignored. On these strata collinear triples coincide with  $t$  such that the tangent line to  $\mathcal{K}$  at  $f(t)$  intersects the knot at a point other than  $f(t)$ . In the case of the trefoil, we can deduce from boundary value and monotonicity arguments that there are tangential collinear triples corresponding to  $t \in [\frac{1}{6}, \frac{1}{3}]$  and  $t \in [\frac{2}{3}, \frac{5}{6}]$  as sketched above. The tangential collinear triples for  $t \in [0, \frac{1}{6}]$  or  $[\frac{5}{6}, 1]$ , would belong to  $\mathbf{Co}_2[f]$  and can thus be disregarded.

Now that we have the boundary structure of the  $\mathbf{Co}_i[f]$  for the trefoil and figure-eight knots, we need to understand the interior structure. As usual, this can be understood from the crossing structure of a projection of these links. The following lemma is simple and extremely useful.

**Lemma 5.7.** *Let  $\rho: \Delta^3 \rightarrow \Delta^2$  be defined by forgetting the  $t_1$  coordinate, and let  $f$  parametrize a knot  $\mathcal{K}$ . A crossing of the projection of  $\mathbf{Co}_1[f]$  and  $\mathbf{Co}_3[f]$  under  $\rho$  corresponds to a collinearity of four points on  $\mathcal{K}$ .*



*Proof.* A crossing of  $\mathbf{Co}_3[f]$  and  $\mathbf{Co}_1[f]$ , corresponds to having  $f(t_1^*), f(t_2^*), f(t_3^*)$  on  $L^*$  and  $f(t_1'), f(t_2'), f(t_3')$  on  $L'$  with  $t_2^* = t_2'$  and  $t_3^* = t_3'$ , since their projections under  $\rho$  agree. Because  $t_2^* = t_2'$  and  $t_3^* = t_3'$ , we have  $L^* = L'$  so in fact the four points  $f(t_1'), f(t_1^*), f(t_2')$  and  $f(t_2^*)$  are all collinear.  $\square$

**Figure 5.8.**

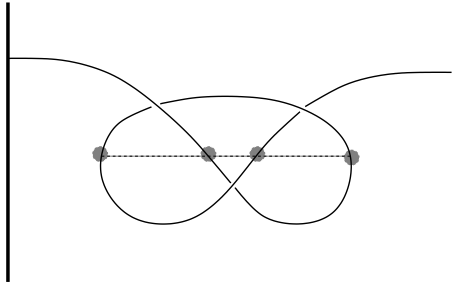

*quadriseccants.*

**Figure 5.9.**

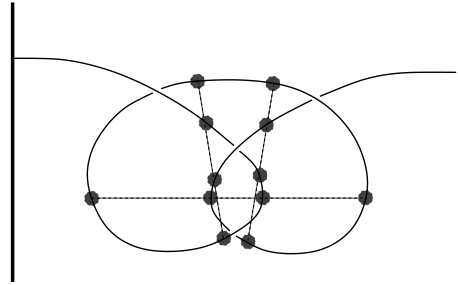

*quadriseccants.*

Figures 5.8 and 5.9 display all the quadriseccants on these knots. For the trefoil, parametrize the knot so that the points where  $x_3'(t) = 0$  are  $t \in \{\frac{3}{12}, \frac{5}{12}, \frac{7}{12}, \frac{9}{12}\}$ . These points partition  $\mathbb{I}$  into five intervals. Since  $x_3$  is increasing on  $(\frac{3}{12}, \frac{5}{12})$  and  $(\frac{7}{12}, \frac{9}{12})$ , and decreasing on  $(0, \frac{3}{12})$ ,  $(\frac{5}{12}, \frac{7}{12})$  and  $(\frac{9}{12}, 1)$ , any quadriseccant must have its points on four of these five intervals, and no quadriseccant can have a point on the  $(\frac{5}{12}, \frac{7}{12})$  interval for rather simple reasons – such a quadriseccant of the projection could not lift to a quadriseccant of the knot itself since the  $x_3$  coordinate of such a quadriseccant could not be monotone along the line. Again by monotonicity, there could be only one quadriseccant which passes through the four intervals  $[0, \frac{3}{12}]$ ,  $[\frac{3}{12}, \frac{5}{12}]$ ,  $[\frac{7}{12}, \frac{9}{12}]$  and  $[\frac{9}{12}, 1]$ , which is sketched in Figure 5.8.

**Figure 5.10.**

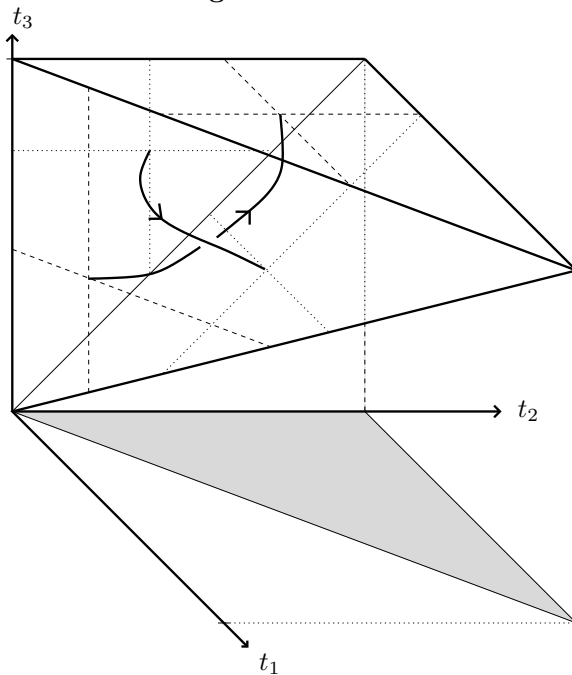

$\mathbf{Co}_1[f] \cup \mathbf{Co}_3[f] \subseteq \Delta^3$   
 $f = \text{trefoil}$

**Figure 5.11.**

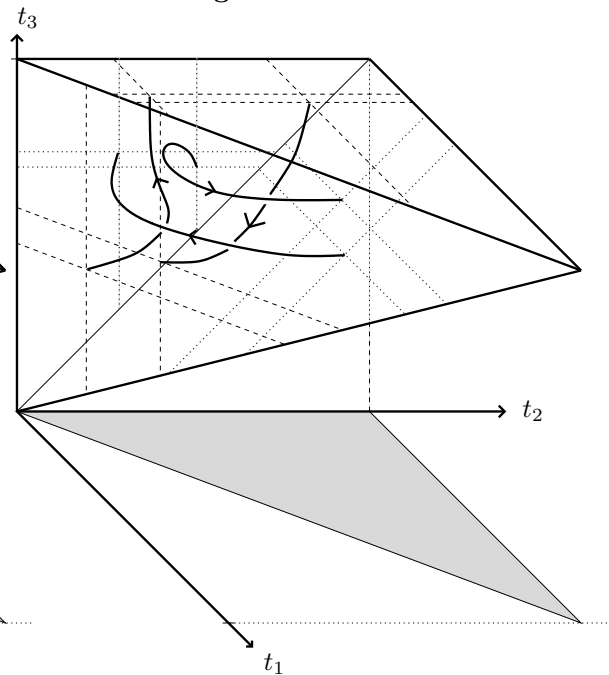

$\mathbf{Co}_1[f] \cup \mathbf{Co}_3[f] \subseteq \Delta^3$   
 $f = \text{figure-8 knot}$

In Figures 5.10 and 5.11 the data from the previous figures is assembled to represent  $\mathbf{Co}_i[f] \subseteq \Delta^3$  for  $i = 1, 3$ , together with orientation information which is explicitly computed below. This information suffices to compute our linking invariant. In the case of the trefoil, we know each of  $\mathbf{Co}_i[f]$  for  $i = 1, 3$  has only the one component, since we have determined the boundary of these components and there are no closed components. We will not argue the non-existence of boundaryless components, but by Lemma 5.7 even if there were boundaryless components, they would be irrelevant since they would not cross any other components. By following families of collinearities from the boundaries, one can see that none of the  $\mathbf{Co}_i[f]$  has both boundary points on the same face of the simplex. Moreover, in both the trefoil and figure eight examples, all the strand crossings in the diagrams Figures 5.10 and 5.11 are  $\mathbf{Co}_3[f]$  strands crossing over  $\mathbf{Co}_1[f]$  strands, an elementary observation from Figures 5.8 and 5.9.

To compute the orientations of the strands in Figures 5.10 and 5.11, it suffices to compute the orientations induced on the intersection of  $\mathbf{Co}_i[f]$  with  $\Delta_{(i=2)}^3$ , since every strand is incident to one of these faces. The orientation of these points is given (up to a choice of orientation of  $\mathbf{Co}_i\mathbb{I}^3$ ) by the sign of the determinant  $\det[f(t_i) - f(t_k), f''(t_i), f'(t_k)]$  where  $(t_1, t_2, t_3) \in \mathbf{Co}_i[f] \cap \Delta_j^3$  and  $\{1, 2, 3\} = \{i, k, 2\}$ . To see this, consider the identifications of the  $(i = 2)$  stratum of  $C_3[\mathbb{R}^3]$  with  $\mathbb{R}^3 \times (\mathbb{R}^3 - \{0\}) \times S^2$ . The orientation associated to  $\mathbf{Co}_i[f] \cap \Delta_i^3$  is the transverse intersection number of  $C_3[f]|_{\Delta_{(i=2)}^3}$  with  $\mathbf{Co}_i[\mathbb{I}^3] \subseteq C_3[\mathbb{I}^3]$ , which quickly reduces to the sign of the above determinant.

This analysis gives us the orientations in the figures, which allows us to establish the following.

**Theorem 5.12.** *For the trefoil knot  $\nu_2$  is  $+1$ , and for the figure-eight knot  $\nu_2 = -1 - 1 + 1 = -1$ .*

## 6. QUADRISECANTS, FINITE-TYPE, AND GEOMETRIC CONSEQUENCES

In the last section it was clear that the key to computing  $\nu_2(\mathcal{K})$  was identifying crossings of  $\mathbf{Co}_1(\mathcal{K})$  and  $\mathbf{Co}_3(\mathcal{K})$ , which by Lemma 5.7 correspond to quadriseccants on the knot. In this section we elaborate on this to compute  $\nu_2(\mathcal{K})$  by counting quadriseccants of  $\mathcal{K}$ , which leads to an easy proof that  $\nu_2$  coincides with the  $z^2$ -coefficient of the Conway polynomial. We end this section with a result on quadriseccants of a closed knot and applications to stick number of a knot.

**6.1. Quadriseccants on long knots.** The subspace of  $C_4(\mathbb{I}^3)$  consisting of configurations of four points which are collinear has precisely twelve components. If  $(x_1, x_2, x_3, x_4)$  is a quadriseccant, orient the line on which they sit by the convention that the vector  $x_2 - x_1$  be positively oriented. A choice of orientation determines a permutation of  $\{1, 2, 3, 4\}$  given by  $\sigma(i) = j$  if the  $i$ -th point on the line is  $x_j$ . Note the permutations achieved are precisely the permutations such that  $\sigma(2) > \sigma(1)$ , and there are twelve of these.

**Definition 6.1.** Let  $\mathcal{C}_4$  denote the subspace of  $C_4(\mathbb{R}^3)$  of collinear configurations labeled by the 4-cycle (1342). Let  $\mathcal{K} \subseteq \mathbb{I}^3$  be a knot, parametrized by  $f : \mathbb{I} \rightarrow \mathbb{I}^3$ . We associate a sign  $\epsilon_x$  to a quadruple  $x = (f(t_1), f(t_2), f(t_3), f(t_4)) \in \mathcal{C}_4$  by defining it to be the sign of the determinant of the  $2 \times 2$  matrix:

$$\begin{bmatrix} |f(t_3) - f(t_2)| \cdot \det[v, f'(t_1), f'(t_3)] & |f(t_3) - f(t_1)| \cdot \det[v, f'(t_2), f'(t_3)] \\ |f(t_4) - f(t_2)| \cdot \det[v, f'(t_4), f'(t_1)] & |f(t_4) - f(t_1)| \cdot \det[v, f'(t_2), f'(t_4)] \end{bmatrix}$$

where  $v = f(t_2) - f(t_1)$ .

With this sign convention in hand, we give an alternate definition of our self-linking invariant.

**Proposition 6.2.** *Let  $\mathcal{K} = \text{im}(f)$  be a knot  $\mathcal{K} \subseteq \mathbb{I}^3$ . If  $C_4[\mathcal{K}]$  is transverse to  $\mathcal{C}_4$ , then*

$$\nu_2(\mathcal{K}) = \sum_{x \in C_4(\mathcal{K}) \cap \mathcal{C}_4} \epsilon_x$$

*Proof.* As in Lemma 5.7, project the link  $C_3[f]^{-1}(\mathbf{Co}_i[\mathbb{I}^3])$  onto  $\Delta^2$  by  $\rho$ , which forgets the  $t_1$  coordinate. Let  $L = \overline{\mathbf{Co}_1[f]} \cup \overline{\mathbf{Co}_3[f]}$ . Because  $\mathbf{Co}_1[f]$  has boundary in  $\Delta_{(1=2)}^3$  and  $\Delta_{(3=4)}^3$ , and  $\mathbf{Co}_3[f]$  has boundary

in  $\Delta_{(2=3)}^3$  and  $\Delta_{(1=0)}^3$ , the crossing points of the  $\rho$ -projection of  $L$  differ from the crossing points of the  $\rho$ -projection of  $\mathbf{Co}_1[f] \cup \mathbf{Co}_3[f]$  by adding crossings where  $\mathbf{Co}_1[f]$  strands cross over  $\mathbf{Co}_3[f]$  strands. Therefore the linking number of  $L$  is precisely the crossing number of the  $\rho$ -projection of  $\mathbf{Co}_1[f] \cup \mathbf{Co}_3[f]$ , where we count only  $\mathbf{Co}_3[f]$  strands crossing over  $\mathbf{Co}_1[f]$ .

We next investigate such crossings. As in Lemma 5.7, denote the two preimages of the crossing point by  $(t_1^*, t_2^*, t_3^*)$  and  $(t'_1, t'_2 = t_2^*, t'_3 = t_3^*)$ . We deduce, by the definitions of  $\mathbf{Co}_i[f]$  and the fact that  $\mathbf{Co}_3[f]$  is the over strand, that  $t_1^* > t'_1$  with  $f(t_3^*)$  between  $f(t_1^*)$  and  $f(t_2^*)$  and  $f(t'_1)$  between  $f(t_2^*)$  and  $f(t_3^*)$  on the same line  $L$ . With respect to  $L$ 's orientation we have the order relation  $f(t_1^*) < f(t_3^*) < f(t_2^*)$  so the only possible order relation for the  $f(t'_i)$ 's on  $L$  is  $f(t'_3) < f(t'_1) < f(t'_2)$  since only the  $t_1$  coordinate changes. Therefore, we have the order relation  $f(t_1^*) < f(t_3^*) < f(t'_1) < f(t_2^*)$  on  $L$  and thus our permutation is  $\sigma_x = (1342)$ .

The sign of  $\epsilon_x$  is straightforward to justify. As argued above, we are counting the transverse intersection number  $C_4[\mathcal{K}] \cap \mathcal{C}_4$ . Orient the image of  $C_4[\mathcal{K}]$  using the standard product orientation of its domain and  $\mathcal{C}_4$  by making the identification  $\mathbb{R}^3 \times (\mathbb{R}^3 - \{0\}) \times (0, \infty) \times (0, 1) \equiv \mathcal{C}_4$  by  $(x, v, t_1, t_2) \mapsto (x, x+v, x-t_1v, x+t_2v)$  and giving it the product orientation. Both the image of  $C_4[\mathcal{K}]$  and  $\mathcal{C}_4$  have trivial tangent bundles, given by the above product structures. Thus, the points in the transverse intersection  $C_4[\mathcal{K}] \cap \mathcal{C}_4$  have orientations given by the sign of the determinant of the basis consisting of the two trivializations,

$$\det \begin{pmatrix} I_{\mathbb{R}^3} & 0 & 0 & 0 & f'(t_1) & 0 & 0 & 0 \\ I_{\mathbb{R}^3} & I_{\mathbb{R}^3} & 0 & 0 & 0 & f'(t_2) & 0 & 0 \\ I_{\mathbb{R}^3} & -\frac{|f(t_3)-f(t_1)|}{|f(t_2)-f(t_1)|} I_{\mathbb{R}^3} & f(t_1) - f(t_2) & 0 & 0 & 0 & f'(t_3) & 0 \\ I_{\mathbb{R}^3} & \frac{|f(t_4)-f(t_1)|}{|f(t_2)-f(t_1)|} I_{\mathbb{R}^3} & 0 & f(t_2) - f(t_1) & 0 & 0 & 0 & f'(t_4) \end{pmatrix}$$

which rapidly reduces to the formula in the statement of the proposition.  $\square$

## 6.2. $\nu_2$ is of type two.

**Theorem 6.3.**  *$\nu_2$  is of finite type two.*

*Proof.* We show the invariant is type two by computing directly that its third derivative (in the sense of finite-type invariant theory) is zero. We show that for every knot  $\mathcal{K}$  and a set of three crossing changes  $c_1, c_2, c_3$ , that the associated alternating sum vanishes:

$$(1) \quad \sum_{\sigma \subset [3]} (-1)^{|\sigma|} \nu_2(\mathcal{K}_\sigma) = 0,$$

where  $[3]$  denotes the set  $\{1, 2, 3\}$  and  $\mathcal{K}_\sigma$  denotes the knot obtained from  $\mathcal{K}$  by applying crossing changes  $c_i$  where  $i \in \sigma$ . The three crossing changes are supported in balls  $B_i, 1 \leq i \leq 3$ . It suffices to check this when the three balls are not collinear, i.e. no straight line intersects all three balls, since an isotopy can always bring us to that situation.

Given a quadriseccant on one of the eight knots  $\mathcal{K}_\sigma$ , we know that it avoids one of the balls, say  $B_3$ . Thus a quadriseccant appears in the knot  $\mathcal{K}_\tau$  where  $\tau \subset [2]$  if and only if it appears in  $\mathcal{K}_{\tau \cup \{3\}}$ . Taking the signed sum, the net contribution is zero.  $\square$

**Corollary 6.4.** *The self-linking invariant,  $\nu_2(\mathcal{K})$  is equal to the  $z^2$  coefficient of the Alexander-Conway polynomial,  $c_2(\mathcal{K})$ .*

*Proof.* The space of type two invariants is spanned by the Conway coefficient  $c_2$  and the constant function 1, which have independent values on the unknot and the trefoil. By Theorem 6.3,  $\nu_2$  is type two. Both  $\nu_2$  and  $c_2$  vanish on the unknot and take value 1 on the trefoil by the previous section, and therefore must coincide.  $\square$

*Remark.* It is straightforward from definitions that counting quadriseccants on the embedding level is type 2, which led Bar-Natan, Hutchings, and D. Thurston to conjecture a corresponding invariant at the level of isotopy.

### 6.3. Quadriseccants and closed knots.

**Definition 6.5.** Let  $\overline{\mathcal{K}}$  denote the convex hull of the knot and define the set of extremal points of the knot to be  $\mathcal{K} \cap \partial\overline{\mathcal{K}}$ , generically a finite number of closed intervals provided the knot is non-trivial.

Given an oriented closed knot  $\mathcal{K}$  with parametrization  $f : S^1 \rightarrow \mathbb{R}^3$  and an extremal point  $p \in \mathcal{K}$ , linearly order the points in  $\mathcal{K} - \{p\}$  using the ordering induced by the orientation of  $\mathcal{K}$ . Consider the component of  $C_4[\mathcal{K} - \{p\}]$  for which  $t_1 \leq t_2 \leq t_3 \leq t_4$ , which we call  $C_4^o[\mathcal{K} - \{p\}]$ . Provided  $C_4[f] : C_4^o[S^1 - f^{-1}(p)] \rightarrow C_4[\mathbb{R}^3]$  is transverse to  $\mathcal{C}_4$ , we can give a point in the intersection  $x \in C_4(\mathcal{K}) \cap \mathcal{C}_4$  such that  $x = (f(t_1), f(t_2), f(t_3), f(t_4))$  a sign  $\epsilon_x$  exactly as in Definition 6.1.

**Lemma 6.6.** *With conventions as above,*

$$c_2\mathcal{K} = \sum_{x \in C_4(\mathcal{K}) \cap \mathcal{C}_4} \epsilon_x.$$

*Proof.* Translate and scale the knot so that its image lies in  $\mathbb{I}^3$ . “Open” the knot at  $p$  to give a long knot  $\tilde{f} : \mathbb{I} \rightarrow \mathbb{I}^3$ . When we open the knot to create  $\tilde{f}$  we may create new quadriseccants, but by design the associated permutation  $\sigma_x$  of these quadruples must fix either 1 or 4. Thus the sum  $\sum_{x \in C_4(\mathcal{K}) \cap \mathcal{C}_4} \epsilon_x$  is precisely  $\nu_2(\tilde{f})$ , which by Corollary 6.4 is  $c_2(\tilde{f})$ .  $\square$

We now establish that the (1342)-quadriseccants of knots with boundary correspond to a special kind quadriseccant of closed knot.

**Definition 6.7.** Let  $L$  be an oriented line that intersects an oriented knot  $\mathcal{K}$  in four points  $P = \{p_0, \dots, p_3\} = \{x_1, \dots, x_4\}$ , where the subscripts of  $x_i$ 's are determined by the orientation of  $L$  and the subscripts of  $p_i$ 's (which are understood modulo four) are consistent with the cyclic ordering given by  $\mathcal{K}$ . Let  $m = \frac{x_2 + x_3}{2}$ . We call  $P$  an *alternating quadriseccant* if  $p_i - m$  and  $p_{i+1} - m$  are negative multiples of each other for all  $i$ .

This definition is invariant under the action the subgroup  $\langle (1234), (14)(23) \rangle \subset S_4$  on indices.

**Definition 6.8.** Let  $\mathcal{K}$  and  $L$  intersect in an alternating quadriseccant  $P$  as above. We call the component of  $\mathcal{K} \setminus P$  that has boundary equal to  $\{x_2, x_3\}$  the *middle component* of the quadriseccant on  $\mathcal{K}$ .

**Figure 6.9.**

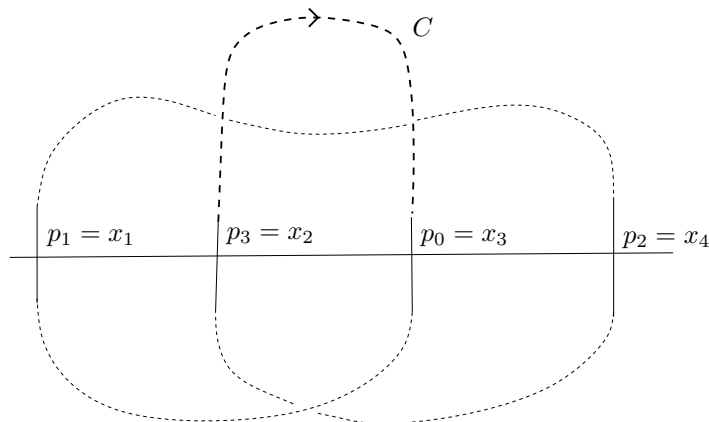

*A quadriseccant  $P = \mathcal{K} \cap L$  with middle component  $C$ .*

**Lemma 6.10.** *Given a quadriseccant  $P = L \cap \mathcal{K}$  of a closed knot  $\mathcal{K}$ , it is a (1342)-labeled quadriseccant for some extremal point  $p \in \mathcal{K}$  if and only if the quadriseccant is alternating and its middle component  $C$  contains an extremal point of the knot.*

*Proof.* If  $p$  is an extremal point making  $x$  into a (1342)-labeled quadriseccant, it is clear that the quadriseccant is alternating. If, on the other hand,  $L$  is a line intersecting  $\mathcal{K}$  in an alternating quadriseccant, and  $p \in C$  is an extremal point, begin assigning a cyclic ordering to the points of  $x$  by giving the label 1 to the first point of  $x$  that occurs after  $p$  in the ordering of  $\mathcal{K}$ . The label 4 must be between the points labeled 1 and 2 as this is a cyclic ordering and 2 and 4 must occur on the same side of the midpoint  $m$ . Thus the permutation associated to this quadriseccant is  $\sigma_x = (1342)$ .  $\square$

The configuration space  $C_4[S^1]$  has six components; let  $C_4^o[S^1]$  denote the component where a configuration  $(t_1, t_2, t_3, t_4)$  has the cyclic ordering  $t_1 \leq t_2 \leq t_3 \leq t_4 \leq t_1$ . Let us also be more definite about the labeling of points in an alternating quadriseccant  $P = L \cap \mathcal{K}$  from Definition 6.7. Choose  $\{p_0, \dots, p_3\} = P$  so that the boundary of the middle component  $C$  of  $P$  on  $\mathcal{K}$  is  $\{+p_0, -p_3\}$ , as in Figure 6.9. Let  $v = p_1 - p_0$ , and let  $p'_i$  be the unit tangent vector of  $\mathcal{K}$  at  $p_i$ . Also, we may assume  $\mathcal{K} \cap \partial\overline{\mathcal{K}}$  has a finite number of components. We let  $n_L$  be the number of components of  $C \cap \partial\overline{\mathcal{K}}$ .

**Proposition 6.11.** *Given an oriented knot  $\mathcal{K} = \text{im}(f)$ , such that  $C_4[f] : C_4^o[S^1] \rightarrow C_4[\mathbb{R}^3]$  is transverse to  $C_4$ , and  $\mathcal{K} \cap \partial\overline{\mathcal{K}}$  is a finite collection of intervals then*

$$c_2\mathcal{K} = \frac{1}{|\pi_0(\mathcal{K} \cap \partial\overline{\mathcal{K}})|} \cdot \sum_L n_L \text{sig} \left( \det \begin{bmatrix} |p_2 - p_1| \cdot \det[v, p'_0, p'_2] & |p_2 - p_0| \cdot \det[v, p'_1, p'_2] \\ |p_3 - p_1| \cdot \det[v, p'_3, p'_0] & |p_3 - p_0| \cdot \det[v, p'_1, p'_3] \end{bmatrix} \right)$$

where the sum is taken over lines  $L$  that intersect  $\mathcal{K}$  in an alternating quadriseccant.

*Proof.* Combining Lemmas 6.6 and 6.10, the above sum is simply  $\frac{1}{|\pi_0(\mathcal{K} \cap \partial\overline{\mathcal{K}})|}$  times the sum of the equation given in Lemma 6.6 where we sum over the components of  $\pi_0\mathcal{K} \cap \partial\overline{\mathcal{K}}$ , choosing one extremal point for each component of  $\mathcal{K} \cap \partial\overline{\mathcal{K}}$ .  $\square$

**Corollary 6.12.** *Given a knot  $S^1 \rightarrow \mathbb{R}^3$  that has a non-zero  $z^2$  coefficient in its Alexander-Conway polynomial, then there exists an alternating quadriseccant of the knot*

Proposition 6.11 gives a partial converse to the main results of [29, 28, 25], in which a knot is shown to be trivial if it has no quadriseccants. Corollary 6.12 resolves a special case of the conjecture of Cantarella, Kuperberg, Kusner, and Sullivan that alternating quadriseccants exist for all non-trivial knots [8]. The full conjecture has recently been resolved in the dissertation of Denne [10], which is currently being written.

**6.4. Geometric applications.** We give simple applications of these results to bounding the complexity of minimal polygonal and polynomial realizations of a knot. The stick number of a knot is the minimum number of line segments among all piecewise linear knots equivalent to a given one in  $\mathbb{R}^3$ . There are various relationships known between the stick number of a knot and other invariants of the knot which are difficult to compute such as the crossing number. See [30] for a survey of known results on the stick number of knots.

Let  $K$  be a polygonal knot. If  $L$  is a straight line that intersects  $K$  in precisely four points, then all the points of  $K \cap L$  sit on different line segments in  $K$ . We associate to  $L$  a set  $\text{seg}(L)$  consisting of the four line segments of  $K$  that contain  $K \cap L$ .

**Lemma 6.13.** *A polygonal knot in general position has finitely many quadriseccants. The function  $L \mapsto \text{seg}(L)$ , is at most two-to-one.*

*Proof.* Let  $f_i(t) = x_i + tv_i$  for some  $x_i \in \mathbb{R}^3$  and  $v_i \in \mathbb{R}^3 - \{0\}$  and  $t \in \mathbb{I}$  be parametrizations of line segments of  $K$  for  $i \in \{1, 2, 3, 4\}$ . Apply a small isotopy of  $K$  so that any three of the four vectors  $v_1, v_2, v_3, v_4$  are linearly independent. Now consider the extensions of  $f_i$  to all of  $\mathbb{R}$ , and restrict our attention to the first

three functions  $f_1, f_2, f_3$ . There are three cases to consider, as the images of the  $f_i$  are disjoint, or one pair, say  $f_1$  and  $f_2$  intersect in a point, or  $f_i$  intersects  $f_{i+1}$  for  $i \in \{1, 2\}$ .

In the first case there is a unique affine-linear transformation  $T$  of  $\mathbb{R}^3$  such that  $T \circ f_1(t) = (t, 0, 0)$ ,  $T \circ f_2(t) = (0, t, 1)$  and  $T \circ f_3(t) = (1, 1, t)$ . Affine-linear transformations do not change collinearity properties, so without loss of generality we can restrict ourselves to studying quadrisecants of these three lines and an arbitrary  $f_4(t) = x_4 + tv_4$ . The closure of the union of all lines  $L$  which intersect each of  $\text{im}(f_i)$  for  $i \in \{1, 2, 3\}$  is the algebraic variety  $V = \{(x, y, z) \in \mathbb{R}^3 : (x + z - 1)y = xz\}$ . Moreover, every point in  $V$  belongs to at most one line that intersects each of  $\text{im}(f_i)$  for  $i \in \{1, 2, 3\}$ . Therefore, a straight line  $L$  that intersects  $\text{im}(f_i)$  for  $i \in \{1, 2, 3, 4\}$  corresponds to a point in the intersection  $V \cap \text{im}(f_4)$ . Because  $V$  is a quadratic surface  $V \cap \text{im}(f_4)$  can consist of 0, 1, 2 or an infinite number of points. Since  $V$  is a ruled surface, infinite intersections  $V \cap \text{im}(f_4)$  occur only when  $\text{im}(f_1) \subset V$  which is a codimension three condition, not occurring generically. This proves the theorem in case 1.

The last two cases are almost identical to the first. In the second, we can use an affine-linear transformation to convert the straight lines  $f_1, f_2, f_3$  into the family  $f_1(t) = (t, 0, 0)$ ,  $f_2(t) = (0, t, 0)$  and  $f_3(t) = (1, 1, t)$ . In this case the algebraic variety of collinear triples is a subvariety of  $\{(x, y, z) : x = y \text{ or } z = 0\}$ , and the result follows immediately. In the third case, we use an affine linear transformation to convert the first three line segments to  $f_1(t) = (t, 0, 0)$ ,  $f_2(t) = (0, t, 0)$  and  $f_3(t) = (0, 1, t)$ , making the variety of collinear triples  $\{(x, y, z) : z = 0 \text{ or } x = 0\}$ .  $\square$

**Theorem 6.14.** *Given a PL knot  $K$ , let  $n(K)$  be the number of line segments in  $K$ . Then*

$$\frac{|c_2|}{2} \leq \binom{n(K)}{4}$$

*Proof.* If  $K$  is in general position, we can assume it has a finite number of quadrisecants, and that no quadrisecant has a point in the 0-skeleton  $K^0$  of  $K$ . Let  $K_\epsilon$  be the epsilon-smoothing of the knot  $K$ , which is a smooth knot such that if  $B_\epsilon(v)$  is the epsilon ball about a vertex  $v$  of  $K$ , then  $K - \cup_{v \in K^0} B_\epsilon(v) = K_\epsilon - \cup_{v \in K^0} B_\epsilon(v)$  and the knots  $K \cap B_\epsilon(v)$  and  $K_\epsilon \cap B_\epsilon(v)$  are isotopic in a restricted sense.

For some  $\epsilon > 0$ ,  $K_\epsilon$  has all the quadrisecants of  $K$ , and we leave it to the reader to argue that it can have no more alternating quadrisecants using compactness of the segments of  $K$  and the fact that none of the quadrisecants intersect  $K^0$ . Because  $K_\epsilon$  satisfies the criteria of Lemma 6.6,  $K$  satisfies the criteria of Lemma 6.13, and both knots have exactly the same collection of alternating quadrisecants, the inequality  $\frac{|c_2|}{2} \leq \binom{n(K)}{4}$  comes immediately from the fact that the function  $L \mapsto \text{seg}(L)$  is at most two to one.  $\square$

In a similar vein is the following theorem.

**Theorem 6.15.** *Let  $\mathcal{K}$  be a long knot  $\mathbb{R}^1 \rightarrow \mathbb{R}^3$  parametrized by polynomials of degree  $n$  with leading coefficient 1. If  $C_4[\mathcal{K}]$  is transverse to  $\mathcal{C}_4$  then  $|c_2(\mathcal{K})| \leq (2n)^4$ .*

*Proof.* If  $x(t)$ ,  $y(t)$  and  $z(t)$  parametrize the knot, then a collinearity at times  $t_1, \dots, t_4$  translates to a solution to a system of equations including for example

$$(x(t_1) - x(t_2))(y(t_2) - y(t_3)) = (y(t_1) - y(t_2))(x(t_2) - x(t_3)).$$

There are four such equations, each of degree  $2n$  so Bezout's theorem implies that if there are finitely many solutions there are at most  $(2n)^4$ .  $\square$

Using Propositions 6.2 and 6.11 to find relationships between  $|c_2|$  and more subtle and geometric but less computable invariants is worthy of further study. The bounds we have just obtained for polygonal and polynomials knots are likely not the best possible. It also seems reasonable that one might be able to get a lower-bound on the total curvature of a knot using the above results on quadrisecants for a knot. According to István Fáry [13], perhaps the first proof of the Fáry-Milnor theorem is due to Heinz Hopf. Fáry mentions that the key part of Hopf's unpublished proof is the quadrisecant result of Pannwitz.

We conclude our paper with illustrations of Proposition 6.11.

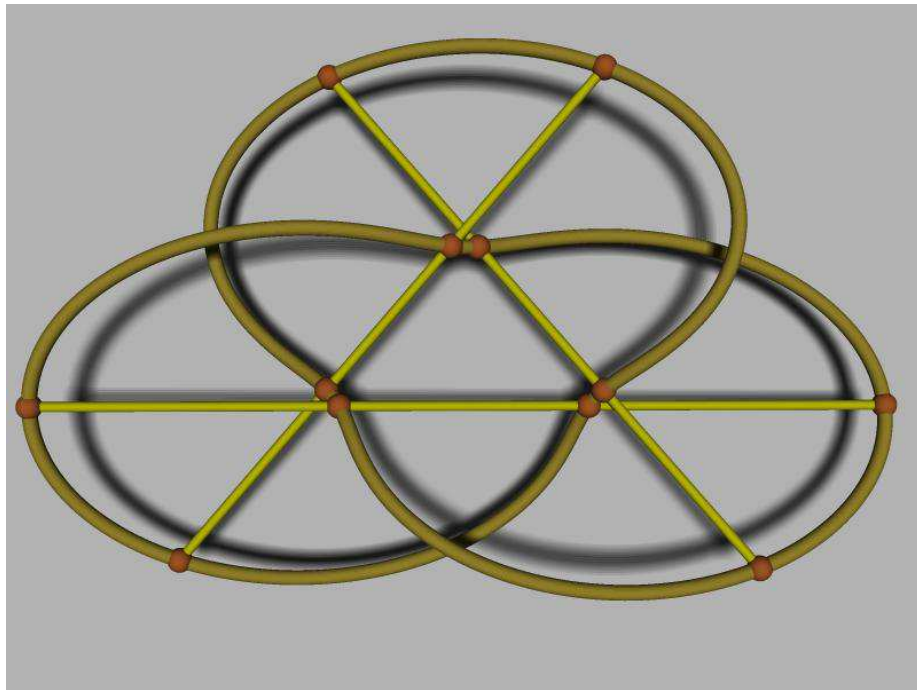

All  $\epsilon_L = +1$ ,  $n_L = 1$ ,  $\pi_0\mathcal{K} \cap \partial\bar{\mathcal{K}} = 3$

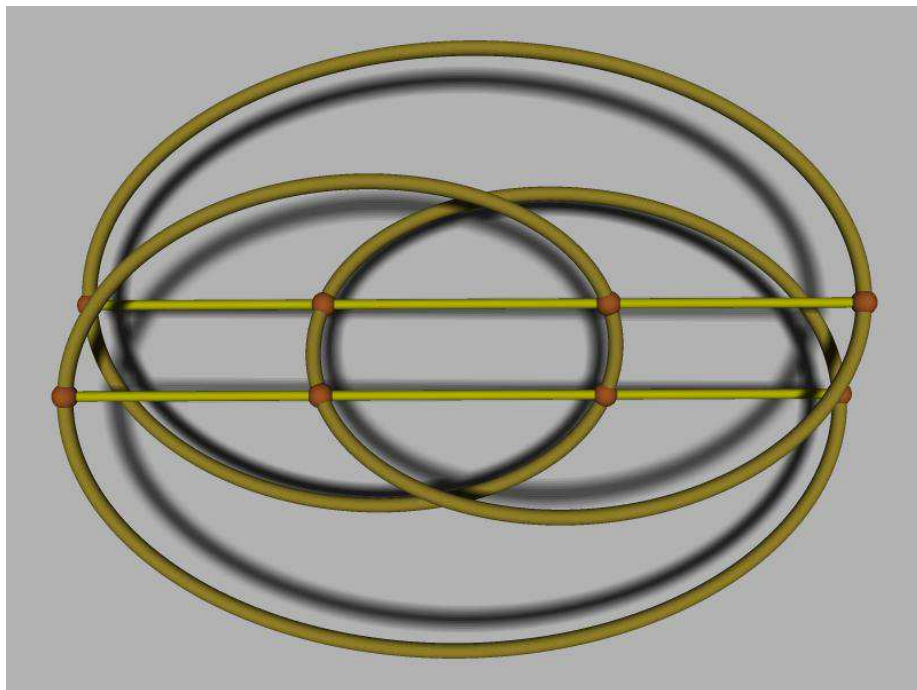

All  $\epsilon_L = +1$ ,  $n_L = 1$ ,  $\pi_0\mathcal{K} \cap \partial\bar{\mathcal{K}} = 2$

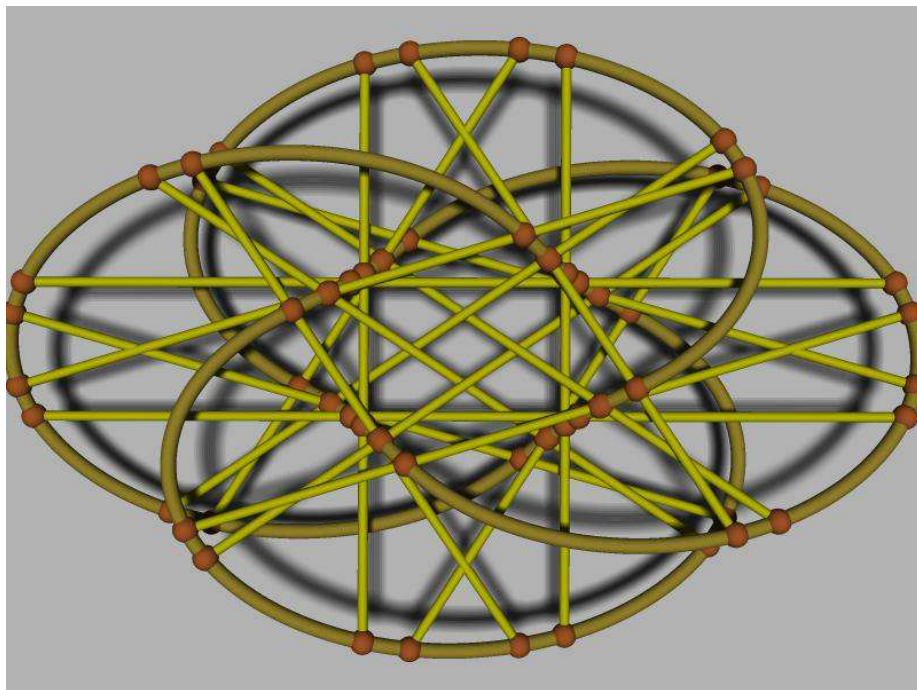

All  $\epsilon_L = +1$ , 4  $L$  have  $n_L = 2$  and 12  $L$  have  $n_L = 1$ ,  $\pi_0\mathcal{K} \cap \partial\bar{\mathcal{K}} = 4$

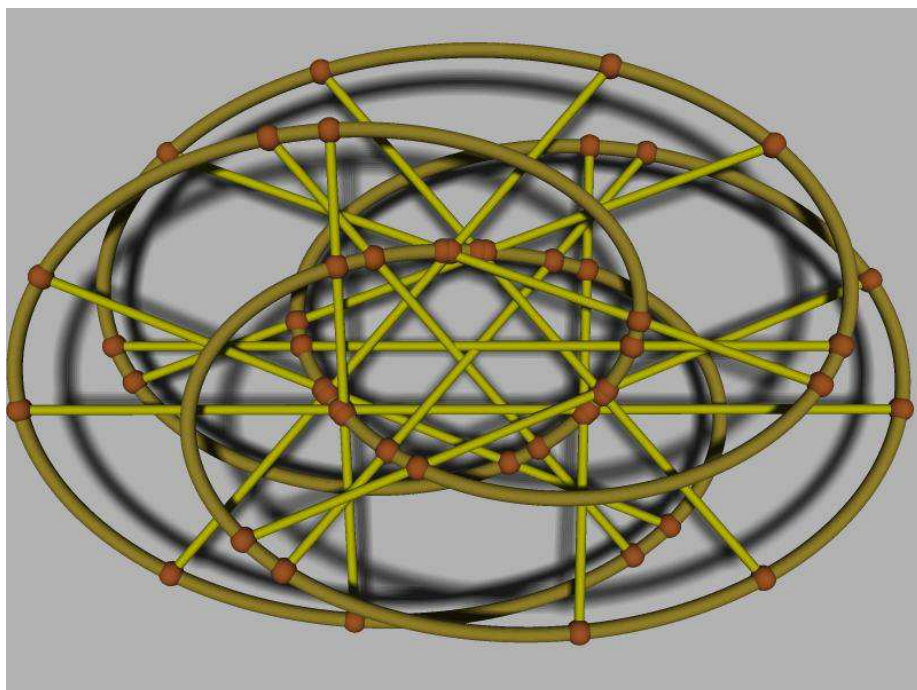

All  $\epsilon_L = +1$ , 3  $L$  have  $n_L = 2$  and 9  $L$  have  $n_L = 1$ ,  $\pi_0\mathcal{K} \cap \partial\bar{\mathcal{K}} = 3$



## REFERENCES

1. D. Altschüler and L. Freidel, *Vassiliev knot invariants and Chern-Simons perturbation theory to all orders*, Comm. Math. Phys. **187** (1997), no. 2, 261–287.
2. S. Axelrod and I. M. Singer, *Chern-Simons perturbation theory. II*, J. Differential Geom. **39** (1994), no. 1, 173–213.
3. D. Bar-Natan, *On the Vassiliev knot invariants*, Topology **34** (1995), no. 2, 423–472.
4. J. S. Birman, *New points of view in knot theory*, Bull. Amer. Math. Soc. (N.S.) **28** (1993), no. 2, 253–287.
5. J. S. Birman and X.-S. Lin, *Knot polynomials and Vassiliev's invariants*, Invent. Math. **111** (1993), no. 2, 225–270.
6. R. H. Bott and C. H. Taubes, *On the self-linking of knots*, J. Math. Phys. **35** (1994), no. 10, 5247–5287.
7. R. D. Budney, J. Conant, K. P. Scannell, and D. P. Sinha, *Mapping space models and finite-type knot invariants*, In preparation.
8. J. Cantarella, G. Kuperberg, R. B. Kusner, and J. M. Sullivan, *The second hull of a knotted curve*, To appear, Amer. J. Math., 2002.
9. J. Conant and P. Teichner, *Grope cobordism of classical knots*, to appear in Topology, math.GT/0012118, 2000.
10. E. Denne, Ph.D. thesis, University of Illinois, Urbana-Champaign, 2003.
11. W. G. Dwyer and D. M. Kan, *Function complexes for diagrams of simplicial sets*, Nederl. Akad. Wetensch. Indag. Math. **45** (1983), no. 2, 139–147.
12. E. R. Fadell and S. Y. Husseini, *Geometry and topology of configuration spaces*, Springer-Verlag, New York-Berlin-Heidelberg, 2001.
13. I. Fáry, *Sur la courbure totale d'une courbe gauche faisant un noeud*, Bull. Soc. Math. France **77** (1949), 128–138.
14. T. G. Goodwillie and J. R. Klein, *Excision statements for spaces of embeddings*, In preparation.
15. T. G. Goodwillie, J. R. Klein, and M. S. Weiss, *Spaces of smooth embeddings, disjunction and surgery*, Surveys on surgery theory, vol. 2 (S. E. Cappell, A. A. Ranicki, and J. M. Rosenberg, eds.), Ann. of Math. Stud., vol. 149, Princeton Univ. Press, Princeton, 2001, pp. 221–284.
16. T. G. Goodwillie and M. S. Weiss, *Embeddings from the point of view of immersion theory. II*, Geom. Topol. **3** (1999), 103–118.
17. M. N. Goussarov, *On  $n$ -equivalence of knots and invariants of finite degree*, Topology of manifolds and varieties (O. Ya. Viro, ed.), Adv. Soviet Math., vol. 18, Amer. Math. Soc., Providence, 1994, pp. 173–192.
18. V. Guillemin and A. Pollack, *Differential topology*, Prentice-Hall, Inc., Englewood Cliffs, 1974.
19. K. Habiro, *Claspers and finite type invariants of links*, Geom. Topol. **4** (2000), 1–83.
20. P. J. Hilton, *On the homotopy groups of the union of spheres*, J. London Math. Soc. (2) **30** (1955), 154–172.
21. P. S. Hirschhorn, *Model categories and their localizations*, Math. Surveys Monographs, vol. 99, Amer. Math. Soc., Providence, 2003.
22. M. L. Kontsevich, *Vassiliev's knot invariants*, I. M. Gelfand Seminar (S. Gelfand and S. Gindikin, eds.), Adv. Soviet Math., vol. 16, Amer. Math. Soc., Providence, 1993, pp. 137–150.
23. M. L. Kontsevich, *Operads and motives in deformation quantization*, Lett. Math. Phys. **48** (1999), no. 1, 35–72.
24. U. Koschorke, *A generalization of Milnor's  $\mu$ -invariants to higher-dimensional link maps*, Topology **36** (1997), no. 2, 301–324.
25. G. Kuperberg, *Quadriseccants of knots and links*, J. Knot Theory Ramifications **3** (1994), no. 1, 41–50.
26. G. Kuperberg and D. P. Thurston, *Perturbative 3-manifold invariants by cut-and-paste topology*, math.GT/9912167, 1999.
27. R. S. Millman and G. D. Parker, *Elements of differential geometry*, Prentice-Hall, Inc., Englewood Cliffs, 1977.
28. H. R. Morton and D. M. Q. Mond, *Closed curves with no quadriseccants*, Topology **21** (1982), no. 3, 235–243.
29. E. Pannwitz, *Eine elementargeometrische Eigenschaft von Verschlingungen und Knoten*, Math. Ann. **108** (1933), 629–672.
30. E. J. Rawdon and R. G. Scharein, *Equilateral stick numbers*, to appear Contemp. Math., 2003.
31. K. P. Scannell and D. P. Sinha, *A one-dimensional embedding complex*, J. Pure Appl. Algebra **170** (2002), no. 1, 93–107.
32. D. P. Sinha, *Manifold-theoretic compactifications of configuration spaces*, In preparation.
33. ———, *The topology of spaces of knots*, Submitted.
34. T. B. Stanford, *Vassiliev invariants and knots modulo pure braid subgroups*, math.GT/9805092, 1998.
35. J. D. Stasheff, *H-spaces from a homotopy point of view*, Lecture Notes in Math., vol. 161, Springer-Verlag, New York-Berlin-Heidelberg, 1970.
36. V. A. Vassiliev, *Complements of discriminants of smooth maps: topology and applications*, Transl. Math. Monographs, vol. 98, Amer. Math. Soc., Providence, 1992.
37. I. Volic, *Finite type knot invariants and calculus of functors*, Ph.D. thesis, Brown University, 2003.
38. M. S. Weiss, *Calculus of embeddings*, Bull. Amer. Math. Soc. (N.S.) **33** (1996), no. 2, 177–187.
39. ———, *Embeddings from the point of view of immersion theory. I*, Geom. Topol. **3** (1999), 67–101.

DEPARTMENT OF MATHEMATICS, HILAN BUILDING, UNIVERSITY OF ROCHESTER, ROCHESTER, NY 14627  
*E-mail address:* [rybu@math.rochester.edu](mailto:rybu@math.rochester.edu)

DEPARTMENT OF MATHEMATICS, CORNELL UNIVERSITY, ITHACA, NY 14853-4201  
*E-mail address:* [jconant@math.cornell.edu](mailto:jconant@math.cornell.edu)

DEPARTMENT OF MATHEMATICS AND COMPUTER SCIENCE, SAINT LOUIS UNIVERSITY, SAINT LOUIS, MISSOURI 63103  
*E-mail address:* [scannell@slu.edu](mailto:scannell@slu.edu)

MATHEMATICS DEPARTMENT, UNIVERSITY OF OREGON, EUGENE, OR 97403  
*E-mail address:* [dps@darkwing.uoregon.edu](mailto:dps@darkwing.uoregon.edu)