

## MANIFOLD-THEORETIC COMPACTIFICATIONS OF CONFIGURATION SPACES

DEV P. SINHA

ABSTRACT. We present new definitions for and give a comprehensive treatment of the canonical compactification of configuration spaces due to Fulton-MacPherson and Axelrod-Singer in the setting of smooth manifolds, as well as a simplicial variant of this compactification initiated by Kontsevich. Our constructions are elementary and give simple global coordinates for the compactified configuration space of a general manifold embedded in Euclidean space. We stratify the canonical compactification, identifying the diffeomorphism types of the strata in terms of spaces of configurations in the tangent bundle, and give completely explicit local coordinates around the strata as needed to define a manifold with corners. We analyze the quotient map from the canonical to the simplicial compactification, showing it is a homotopy equivalence. Using global coordinates we define projection maps and diagonal maps, which for the simplicial variant satisfy cosimplicial identities.

## CONTENTS

1. Introduction	2
1.1. Basic definitions	2
1.2. Review of previous work	2
1.3. A comment on notation, and a little lemma	3
1.4. Acknowledgements	3
2. A category of trees and related categories	4
3. The stratification of the basic compactification	6
3.1. Stratification of $C_n[M]$ using coordinates in $A_n[M]$	6
3.2. Statement of the main theorem	7
3.3. The auxilliary construction $C_n\{\mathbb{R}^m\}$	8
3.4. Proof of Theorem 3.8 for $M = \mathbb{R}^m$	10
3.5. Proof of Theorem 3.8 for general $M$	12
4. First properties	13
4.1. Characterization in $A_n[M]$ and standard projections	13
4.2. Manifold structure, codimensions of strata, functoriality for embeddings, and equivariance	14
4.3. The closures of strata	16
4.4. Configurations in the line and associahedra	17
5. The simplicial compactification	18
6. Diagonal and projection maps	23
References	26

## 1. INTRODUCTION

Configuration spaces are fundamental objects of study in geometry and topology, and over the past ten years, functorial compactifications of configuration spaces have been an important technical tool. We review the state of this active area after giving our definitions.

**1.1. Basic definitions.** We first choose compact notation to manage products of spaces.

*Notation.* If  $S$  is a finite set,  $X^S$  is the product  $X^{\#S}$  where  $\#S$  is the cardinality of  $S$ . Consistent with this, if  $\{X_s\}$  is a collection of spaces indexed by  $S$ , we let  $(X_s)^S = \prod_{s \in S} X_s$ . For coordinates in either case we use  $(x_s)_{s \in S}$  or just  $(x_s)$  when  $S$  is understood. Similarly, a product of maps  $\prod_{s \in S} f_s$  may be written  $(f_s)_{s \in S}$  or just  $(f_s)$ . We let  $\underline{n}$  denote the set  $\{1, \dots, n\}$ , our most common indexing set.

**Definition 1.1.** If  $M$  is a smooth manifold, let  $C_n(M)$  be the subspace of  $(x_i) \in M^{\underline{n}}$  such that  $x_i \neq x_j$  if  $i \neq j$ . Let  $\iota$  denote the inclusion of  $C_n(M)$  in  $M^{\underline{n}}$ .

Suppose that  $M$  were equipped with a metric. The main compactification which we study,  $C_n[M]$ , is homeomorphic to the subspace of  $C_n(M)$  for which  $d(x_i, x_j) \geq \epsilon$  for some sufficiently small  $\epsilon$ . From this model, however, it is not clear how  $C_n(M)$  should be a subspace of the compactification, much less how to establish functoriality or more delicate properties that we will develop.

**Definition 1.2.** For  $(i, j) \in C_2(\underline{n})$ , let  $\pi_{ij}: C_n(\mathbb{R}^m) \rightarrow S^{m-1}$  be the map which sends  $(x_i)$  to the unit vector in the direction of  $x_i - x_j$ . Let  $I$  be the closed interval from 0 to  $\infty$ , the one-point compactification of  $[0, \infty)$ . For  $(i, j, k) \in C_3(\underline{n})$  let  $s_{ijk}: C_n(\mathbb{R}^m) \rightarrow I = [0, \infty]$  be the map which sends  $(x_i)$  to  $(|x_i - x_j|/|x_i - x_k|)$ .

Our compactifications are defined as closures, for which we also set notation.

*Notation.* If  $A$  is a subspace of  $X$ , we let  $cl_X(A)$ , or simply  $cl(A)$  if by context  $X$  is understood, denote the closure of  $A$  in  $X$ .

From now on by a manifold  $M$  we mean a submanifold of some  $\mathbb{R}^m$ , so that  $C_n(M)$  is a submanifold of  $C_n(\mathbb{R}^m)$ . For  $M = \mathbb{R}^m$ , we specify that  $\mathbb{R}^m$  is a submanifold of itself through the identity map.

**Definition 1.3.** Let  $A_n[M]$ , the main ambient space in which we work, be the product  $M^{\underline{n}} \times (S^{m-1})^{C_2(\underline{n})} \times I^{C_3(\underline{n})}$ , and similarly let  $A_n\langle[M]\rangle = M^{\underline{n}} \times (S^{m-1})^{C_2(\underline{n})}$ . Let

$$\alpha_n = \iota \times (\pi_{ij}|_{C_n(M)}) \times ((s_{ijk})|_{C_n(M)}): C_n(M) \rightarrow A_n[M]$$

and define  $C_n[M]$  to be  $cl_{A_n[M]}(im(\alpha_n))$ . Similarly, let  $\beta_n = \iota \times (\pi_{ij}|_{C_n(M)}): C_n(M) \rightarrow A_n\langle[M]\rangle$  and define  $C_n\langle[M]\rangle$  to be  $cl_{A_n\langle[M]\rangle}(im(\beta_n))$ .

We will show in Theorem 4.4 that  $C_n[M]$  is a manifold with corners whose diffeomorphism type depends only on that of  $M$ . Because  $A_n[M]$  is compact when  $M$  is and  $C_n[M]$  is closed in  $A_n[M]$ , we immediately have the following.

**Proposition 1.4.** *If  $M$  is compact,  $C_n[M]$  is compact.*

We call  $C_n[M]$  the canonical compactification of  $C_n(M)$  and  $C_n\langle[M]\rangle$  the simplicial variant. When  $M$  is not compact but is equipped with a complete metric, it is natural to call  $C_n[M]$  the canonical completion of  $C_n(M)$ .

**1.2. Review of previous work.** The compactification  $C_n[M]$  first appeared in work of Axelrod and Singer [1], who translated the definition of Fulton and MacPherson in [10] as a closure in a product of blow-ups from algebraic geometry to the setting of manifolds using spherical blow-ups. Kontsevich made similar constructions at about the same time as Fulton and MacPherson, and his later definition in [15] coincides with our  $\tilde{C}_n\langle[\mathbb{R}^m]\rangle$ , although it seems that he was trying to define  $\tilde{C}_n[\mathbb{R}^m]$ . Kontsevich's oversight was corrected in [11], in which Gaiffi gives a definition of  $C_n[\mathbb{R}^m]$  similar to ours, generalizes

the construction for arbitrary hyperplane arrangements over the real numbers, gives a pleasant description of the category of strata using the language of blow-ups of posets from [9], and also treats blow-ups for stratified spaces locally and so gives rise to a new definition of  $C_n[M]$ , but one which is less explicit than ours and thus less suited for the applications we develop. An alternate approach to  $C_n[M]$  through the theory of operads as pioneered by Getzler and Jones [12] was fully developed and extended to arbitrary manifolds by Markl [18].

Axelrod and Singer used these compactifications to define invariants of three-manifolds coming from Chern-Simons theory, and these constructions have generally been vital in quantum topology [3, 17, 2, 20]. Extensive use of similar constructions has been made in the setting of hyperplane arrangements [6, 27] over the complex numbers. These compactifications have also inspired new computational results [16, 26], and they canonically realize the homology of  $C_n(\mathbb{R}^m)$  [22]. We came to the present definitions of these compactifications so we could define maps and boundary conditions needed for applications to knot theory [4, 24].

New results in this paper include full proofs of many folk theorems, and the following:

- A construction for general manifolds which bypasses the need for blow-ups, uses simple global coordinates, and through which functoriality is immediate.
- Explicit description of the strata in terms of spaces of configurations in the tangent bundle.
- Coordinates about strata which may easily be used for transversality arguments.
- Full treatment of the simplicial variant, including a proof that the projection from the canonical compactification to the simplicial one is a homotopy equivalence.
- A clarification of the central role which Stasheff's associahedron plays in this setting.
- Explicit identification of these compactifications as subspaces of familiar spaces.
- Constructions of diagonal maps, projections, and substitution maps as needed for applications.

In future work [23], we will use these constructions to define an operad structure on these compactifications of configurations in Euclidean space, which has consequences in knot theory. This operad structure was first applied in [12].

We also hope that a unified and explicit exposition of these compactifications using our simplified definition could be of help, especially to those who are new to the subject.

**1.3. A comment on notation, and a little lemma.** There are two lines of notation for configuration spaces of manifolds in the literature, namely  $C_n(M)$  and  $F(M, n)$ . Persuaded by Bott, we choose to use the  $C_n(M)$  notation. Note, however, that  $C_n(M)$  in this paper is  $C_n^0(M)$  in [3] and that  $C_n[M]$  in this paper is  $C_n(M)$  in [3]. Indeed, we warn the reader to pay close attention to the parentheses in our notation:  $C_n(M)$  is the open configuration space;  $C_n[M]$  is the Fulton-MacPherson/Axelrod-Singer compactification, its canonical completion;  $C_n\langle[M]\rangle$ , the simplicial variant, is a quotient of  $C_n[M]$ ;  $C_n\{M\}$ , an auxilliary construction, is a subspace of  $C_n[M]$  containing only one additional stratum. We suggest that those who choose to use  $F(M, n)$  for the open configuration space use  $F[M, n]$  for the compactification.

As closures are a central part of our definitions, we need a lemma from point-set topology that open maps commute with taking closures.

**Lemma 1.5.** *Let  $A$  be a subspace of  $X$ , and let  $\pi : X \rightarrow Y$  be an open map. Then  $\pi(cl_X(A)) \subseteq cl_Y(\pi(A))$ . If  $cl_X(A)$  is compact (for example, when  $X$  is) then this inclusion is an equality.*

*Proof.* First,  $\pi^{-1}(cl_Y(\pi(A)))$  is closed in  $X$  and contains  $A$ , so it contains  $cl_X(A)$  as well. Applying  $\pi$  to this containment we see that  $\pi(cl_X(A)) \subseteq cl_Y(\pi(A))$ .

If  $cl_X(A)$  is compact, so is  $\pi(cl_X(A))$ , which is thus closed in  $Y$ . It contains  $\pi(A)$ , therefore  $cl_Y(\pi(A)) \subseteq \pi(cl_X(A))$ .  $\square$

**1.4. Acknowledgements.** The author would like to thank Dan Dugger for providing a proof and references for Lemma 5.5, Tom Goodwillie for providing the main idea for Lemma 5.12, Ismar Volic for working

with the author on an early draft of this paper, Matt Miller for a careful reading, and Giovanni Gaiffi and Eva-Maria Feitchner for sharing preprints of their work.

## 2. A CATEGORY OF TREES AND RELATED CATEGORIES

In order to understand the compactifications  $C_n[M]$  we have to understand their strata, which are naturally labelled by a poset (or category) of trees.

**Definition 2.1.** Define an  $f$ -tree to be a rooted, connected tree, with labelled leaves, and with no bivalent internal vertices. Thus, an  $f$ -tree  $T$  is a connected acyclic graph with a specified vertex  $v_0$  called the root. The root may have any valence, but other vertices may not be bivalent. The univalent vertices other than perhaps the root are called leaves, and each leaf is labelled uniquely with an element of  $\#l(T)$ , where  $l(T)$  is the set of leaves of  $T$  and  $\#l(T)$  is its cardinality.

**Figure 2.2.** A tree  $T$ .

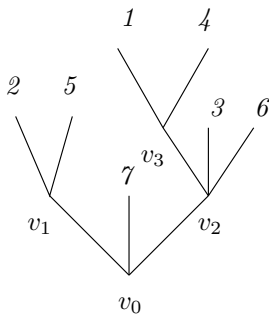

In an  $f$ -tree there is a unique path from any vertex or edge to the root vertex, which we call its root path. We say that one vertex or edge lies over another if the latter is in the root path of the former. For any edge, its boundary vertex closer to the root is called its initial vertex, and its other vertex is called its terminal vertex. If two edges share the same initial vertex, we call them coincident. For a vertex  $v$  there is a canonical ordering of edges for which  $v$  is initial, the collection of which we call  $E(v)$ , the group of edges coincident at  $v$ . Namely, set  $e < f$  if the smallest label for a leaf over  $e$  is smaller than that over  $f$ . We may use this ordering to name these edges  $e_1(v), \dots, e_{\#v}(v)$ , where  $\#v$  is the number of edges in  $E(v)$ .

We will be interested in the set of  $f$ -trees as a set of objects in a category in which morphisms are defined by contracting edges.

**Definition 2.3.** Given an  $f$ -tree  $T$  and a set of non-leaf edges  $E$  the contraction of  $T$  by  $E$  is the tree  $T'$  obtained by taking each edge  $e \in E$ , identifying its initial vertex with its terminal vertex, and then removing  $e$  from the set of edges.

**Definition 2.4.** Define  $\Psi_n$  to be the category whose objects are  $f$ -trees with  $n$  leaves. There is a (unique) morphism in  $\Psi_n$  from  $T$  to  $T'$  if  $T'$  is isomorphic to a contraction of  $T$  along some set of edges.

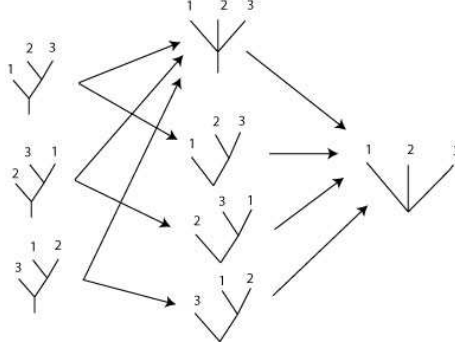
**Figure 2.5.** *The category  $\Psi_3$ .*

Finally, let  $V(T)$  denote the set of non-leaf vertices of  $T$ . Let  $V^i(T)$  denote its subset of internal vertices (thus only excluding the root). Note that a morphism in  $\Psi_{\underline{n}}$  decreases the number of internal vertices, which is zero for the terminal object in  $\Psi_{\underline{n}}$ . Let  $\widetilde{\Psi}_{\underline{n}}$  be the full subcategory of  $f$ -trees whose root is univalent (informally, trees with a trunk). Note that  $\widetilde{\Psi}_{\underline{n}}$  has an operad structure, as defined in [12, 19] (but  $\Psi_{\underline{n}}$  does not have one since we do not allow bivalent vertices).

It is useful to have facility with categories that are essentially equivalent to  $\Psi_{\underline{n}}$ . We will define these categories through the notions of parenthesization and exclusion relation. Further equivalent constructions include the collections of screens of Fulton and MacPherson [10]. The best perspective on these categories is given by the combinatorial blow-up of Feitchner and Kozlov [9]. Indeed, Gaiffi shows in [11] that the poset of strata of a blow-up of an arrangement is the combinatorial blow-up of the original poset associated to the arrangement. Since we focus not on general blow-ups but on compactified configuration spaces in particular, we choose more concrete manifestations of this category.

**Definition 2.6.** A (partial) parenthesization  $\mathcal{P}$  of a set  $S$  is a collection  $\{A_\alpha\}$  of nested subsets of  $S$ , each of cardinality greater than one. By nested we mean that, for any  $\alpha, \beta$ , the intersection  $A_\alpha \cap A_\beta$  is either  $A_\alpha$ ,  $A_\beta$  or empty. The parenthesizations of  $S$  form a poset, which we call  $Pa(S)$ , in which  $\mathcal{P} \geq \mathcal{P}'$  if  $\mathcal{P} \subseteq \mathcal{P}'$ .

Parenthesizations are related to trees in that they may keep track of sets of leaves which lie over the vertices of a tree.

**Definition 2.7.** Define  $f_1: \Psi_{\underline{n}} \rightarrow Pa(\underline{n})$  by sending a tree  $T$  to the collection of sets  $\{A_v\}$ , where  $v \in V^i(T)$  and  $A_v$  is the set of indices of leaves which lie over  $v$ . Define  $g_1: Pa(\underline{n}) \rightarrow \Psi_{\underline{n}}$  by sending a parenthesization to a tree with the following data

- (1) One internal vertex  $v_\alpha$  for each  $A_\alpha$ .
- (2) An edge between  $v_\alpha$  and  $v_\beta$  if  $A_\alpha \subset A_\beta$  but there is no proper  $A_\alpha \subset A_\gamma \subset A_\beta$ .
- (3) A root vertex with an edges connecting it to each internal vertex corresponding to a maximal  $A_\alpha$ .
- (4) Leaves with labels in  $\underline{n}$  with an edge connecting the  $i$ th leaf to either the vertex  $v_\alpha$  where  $A_\alpha$  is the minimal set containing  $i$ , or the root vertex if there is no such  $A_\alpha$ .

We leave to the reader the straightforward verification that  $f_1$  and  $g_1$  are well defined and that the following proposition holds.

**Proposition 2.8.** *The functors  $f_1$  and  $g_1$  are isomorphisms between the categories  $\Psi_{\underline{n}}$  and  $Pa(\underline{n})$ .*

Another way in which to account for the data of which leaves lie above common vertices in a tree is through the notion of an exclusion relation.

**Definition 2.9.** Define an exclusion relation  $R$  on a set  $S$  to be a subset of  $C_3(S)$  such that the following properties hold.

- (1) If  $(x, y), z \in R$ , then  $(y, x), z \in R$  and  $(x, z), y \notin R$ .
- (2) If  $(x, y), z \in R$  and  $(w, x), y \in R$ , then  $(w, x), z \in R$ .

If  $(x, y), z \in R$  we say that  $x$  and  $y$  exclude  $z$ . Let  $Ex(S)$  denote the poset of exclusion relations on  $S$ , where the ordering is defined by inclusion as subsets of  $C_3(S)$ .

We now construct exclusion relations from parenthesizations, and vice-versa.

**Definition 2.10.** Let  $f_2: Pa(\underline{n}) \rightarrow Ex(\underline{n})$  be defined by setting  $(i, j), k \in R$  if  $i, j \in A_\alpha$  but  $k \notin A_\alpha$  for some  $A_\alpha$  in the given parenthesization. Define  $g_2: Ex(\underline{n}) \rightarrow Pa(\underline{n})$  by, given an exclusion relation  $R$ , taking the collection of sets  $A_{\sim i, \neg k}$  where  $A_{\sim i, \neg k}$  is the set of all  $j$  such that  $(i, j), k \in R$ , along with  $i$  when there is such a  $j$ . Let  $Tr = g_1 \circ g_2: Ex(\underline{n}) \rightarrow \Psi_{\underline{n}}$  and let  $\mathcal{E}x = f_2 \circ f_1$ .

As above, we leave the proof of the following elementary proposition to the reader.

**Proposition 2.11.** *The composite  $f_2 \circ g_2$  is the identity functor. If  $f_2(\mathcal{P}) = f_2(\mathcal{P}')$ , then  $\mathcal{P}$  and  $\mathcal{P}'$  may only differ by whether or not they contain the set  $\underline{n}$  itself.*

### 3. THE STRATIFICATION OF THE BASIC COMPACTIFICATION

This section is the keystone of the paper. We first define a stratification of  $C_n[M]$  through coordinates as a subspace of  $A_n[M]$ . For our purposes, a stratification is any expression of a space as a finite disjoint union of locally closed subspaces called strata, which are usually manifolds, such that the closure of each stratum is its union with other strata. We will show that when  $M$  has no boundary, the stratification we define through coordinates coincides with the stratification of  $C_n[M]$  as a manifold with corners. The strata of  $C_n[M]$  are individually simple to describe, so constructions and maps on  $C_n[M]$  are often best understood in terms of these strata.

Before treating  $C_n[M]$  in general, we would like to be completely explicit about the simplest possible case, essentially  $C_2[\mathbb{R}^m]$ .

**Example.** Let  $C_2^*(\mathbb{R}^m) \cong \mathbb{R}^m - 0$  be the subspace of points  $(0, x \neq 0) \in C_2(\mathbb{R}^m)$  and consider it as the subspace of  $\mathbb{R}^m \times S^{m-1}$  of points  $(x \neq 0, \frac{x}{\|x\|})$ . The projection of this subspace onto  $S^{m-1}$  coincides with the tautological positive ray bundle over  $S^{m-1}$ , which is a trivial bundle. The closure  $C_2^*[\mathbb{R}^m]$  is the non-negative ray bundle, which is diffeomorphic to  $S^{m-1} \times [0, \infty)$ . Projecting this closure onto  $\mathbb{R}^m$  is a homeomorphism when restricted to  $\mathbb{R}^m - 0$ , and the preimage of 0 is a copy of  $S^{m-1}$ , the stratum of added points. Thus,  $C_2^*[\mathbb{R}^m]$  is diffeomorphic to the blow-up of  $\mathbb{R}^m$  at 0, in which one replaces 0 by the sphere of directions from which it can be approached. Through this construction,  $C_2^*[\mathbb{R}^m]$  has simple global coordinates inherited from  $\mathbb{R}^m \times S^{m-1}$ .

**3.1. Stratification of  $C_n[M]$  using coordinates in  $A_n[M]$ .** We proceed to define a stratification for  $C_n[M]$  by associating an  $f$ -tree to each point in  $C_n[M]$ .

**Definition 3.1.** Let  $x = ((x_i), (u_{ij}), (d_{ijk})) \in C_n[M]$ . Let  $R(x)$  be the exclusion relation defined by  $(i, j), k \in R(x)$  if  $d_{ijk} = 0$ . Let  $T(x)$  be equal to either  $Tr(R(x))$  or, if all of the  $x_i$  are equal, the  $f$ -tree obtained by adding a new root to  $Tr(R(x))$ .

Note that because  $d_{ijk}d_{ilj} = d_{i\ell k}$  for points in the image of  $C_n(M)$ , by continuity this is true for all of  $C_n[M]$ . So if  $d_{ijk} = 0 = d_{ilj}$ , then  $d_{i\ell k} = 0$ . Therefore,  $R(x)$  satisfies the last axiom for an exclusion relation. The other axiom is similarly straightforward to check to see that  $R(x)$  is well defined.

**Definition 3.2.** Let  $C_T(M)$  denote the subspace of all  $x \in C_n[M]$  such that  $T(x) = T$ , and let  $C_T[M]$  be its closure in  $C_n[M]$ .

The following proposition, which gives a first indication of how the  $C_T(M)$  fit together, is an immediate consequence of the definitions above.

**Proposition 3.3.** *Let  $s = \{(x_i)_j\}_{j=1}^\infty$  be a sequence of points in  $C_n(M)$  which converges to a point in  $C_n[M] \subset A_n[M]$ . The limit of  $s$  is in  $C_T[M]$  if and only if the limit of  $d(x_i, x_j)/d(x_i, x_k)$  approaches zero for every  $(i, j), k \in Ex(T)$  and, in the case where the root valence of  $T$  is one, we also have that all of the  $x_i$  approach the same point in  $M$ .*

To a stratification of a space, one may associate a poset in which stratum  $\alpha$  is less than stratum  $\beta$  if  $\alpha$  is contained in the closure of  $\beta$ .

**Theorem 3.4.** *The poset associated to the stratification of  $C_n[M]$  by the  $C_T(M)$  is isomorphic to  $\Psi_{\underline{n}}$ .*

*Proof.* This theorem follows from the preceding proposition and the fact that if  $T \rightarrow T'$  is a morphism in  $\Psi_{\underline{n}}$ , then  $R(T')$  is contained in  $R(T)$ . □

**3.2. Statement of the main theorem.** Having established an intrinsic definition for the  $C_T(M)$  and a combinatorial description of how they fit together, we now set ourselves to the more difficult task of identifying these spaces explicitly. We describe the spaces  $C_T(M)$  in terms of “infinitesimal configurations”. We will use the term scaling to refer to the action of positive real numbers on a vector space through scalar multiplication.

- Definition 3.5.** (1) Let  $Sim_k$  be the subgroup of the group of affine transformations in  $\mathbb{R}^m$  generated by translation and scalar multiplication.  
 (2) Define  $IC_i(M)$  to be the space of  $i$  distinct points in  $TM$  all lying in one fiber, modulo the action of  $Sim_k$  in that fiber. Let  $p$  be the projection of  $IC_i(M)$  onto  $M$ .

For example  $IC_2(M)$  is diffeomorphic to  $STM$ , the unit tangent bundle of  $M$ . We sometimes refer to  $IC_i(M)$  as the space of infinitesimal configurations of  $i$  points in  $M$ .

Let  $e \in E_0 = E(v_0)$  be a root edge of an  $f$ -tree  $T$ , and let  $V(e) \subseteq V^i(T)$  be the set of internal vertices which lie over  $e$ .

- Definition 3.6.** (1) Define  $IC_e(M)$  to be subspace of the product  $(IC_{\#v}(M))^{V(e)}$  of tuples of infinitesimal configurations all sitting over the same point in  $M$ .  
 (2) Let  $p_e$  be the map from  $IC_e(M)$  onto  $M$  defined projecting onto that point.  
 (3) Let  $D_T(M)$  be the subspace of  $(IC_e(M))^{E_0}$  of points whose image under  $(p_e)$  in  $(M)^{E_0}$  sits in  $C_{\#v_0}(M)$ .

In other words, a point in  $D_T(M)$  is a collection of  $\#v_0$  distinct points  $(x_e)_{e \in E_0}$  in  $M$  with a collection of  $\#v(e)$  infinitesimal configurations at each  $x_e$ .

**Figure 3.7.** *A point in  $D_T(M)$  with  $T$  from Figure 2.2.*

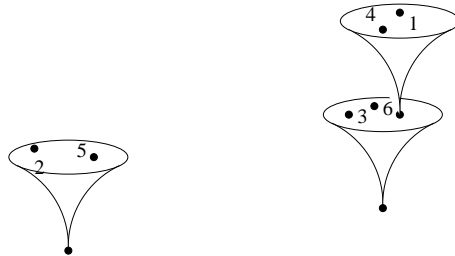

The following theorem is the main theorem of this section.

**Theorem 3.8.**  $C_T(M)$  is diffeomorphic to  $D_T(M)$ .

*Remark.* To intuitively understand  $C_T(M)$  as part of the boundary of  $C_n[M]$  one views an element of  $IC_i(M)$  as a limit of a sequence in  $C_i(M)$  which approaches a point  $(x, x, \dots, x)$  in the (thin) diagonal of  $M^i$ . Eventually, in such a sequence all the points in a configuration would lie in a coordinate neighborhood of  $x$ , which through the exponential map can be identified with  $T_x M$ , and the limit is taken in that tangent space up to rescaling. If  $i > 2$ ,  $IC_i(M)$  is itself not complete, so one allows these infinitesimal configurations to degenerate as well, and this is how the situation is pictured in Figure 3.7. Because  $T(TM) \cong \oplus_3 TM$ , the recursive structure of degenerating sub-configurations is not reflected in the topology of  $D_T(M)$ .

To establish this theorem we focus on the case in which  $M$  is Euclidean space  $\mathbb{R}^m$ , as  $D_T(\mathbb{R}^m)$  admits a simple description.

**Definition 3.9.** Let  $\tilde{C}_n(\mathbb{R}^m)$  be the quotient of  $C_n(\mathbb{R}^m)$  by  $Sim_k$  acting diagonally, and let  $q$  denote the quotient map. Choose coset representatives to identify  $\tilde{C}_n(\mathbb{R}^m)$  with the subspace of  $C_n(\mathbb{R}^m)$  of  $(x_i)$  with  $\sum_i x_i = 0$  and such that the maximum of the  $d(x_i, \vec{0})$  is one.

Because the tangent bundle of  $\mathbb{R}^m$  is trivial,  $IC_i(\mathbb{R}^m) \cong \mathbb{R}^m \times \tilde{C}_i(\mathbb{R}^m)$ , and we have the following.

**Proposition 3.10.**  $D_T(\mathbb{R}^m) = C_{\#v_0}(\mathbb{R}^m) \times \left( \tilde{C}_{\#v}(\mathbb{R}^m) \right)^{V^i(T)}$ .

Alternately,  $D_T(\mathbb{R}^m)$  is the space in which each edge in  $T$  is assigned a point in  $\mathbb{R}^m$ , with coincident edges assigned distinct points, modulo translation and scaling of coincident groups of edges.

Roughly speaking, the proof of Theorem 3.8 when  $M = \mathbb{R}^m$  respects the product decomposition of Proposition 3.10. We start by addressing the stratum associated to the tree  $\Psi$  with a single internal vertex connected to a univalent root.

### 3.3. The auxilliary construction $C_n\{\mathbb{R}^m\}$ .

**Definition 3.11.** Let  $A_n\{M\} = (M)^{\mathbb{Z}} \times (S^{m-1})^{C_2(\mathbb{Z})} \times (0, \infty)^{C_3(\mathbb{Z})}$ , a subspace of  $A_n[M]$ . Note that the image of  $\alpha_n: C_n(M) \rightarrow A_n[M]$  lies in  $A_n\{M\}$ . Let  $C_n\{M\}$  be  $cl_{A_n\{M\}}(im(\alpha_n))$ .

For our purposes,  $C_n\{M\}$  will be useful as a subspace of  $C_n[M]$  to first understand, which we do for  $M = \mathbb{R}^m$ .

**Theorem 3.12.**  $C_n\{\mathbb{R}^m\}$  is diffeomorphic to  $D_n\{\mathbb{R}^m\} = \mathbb{R}^m \times \tilde{C}_n(\mathbb{R}^m) \times [0, \infty)$ .

As a manifold with boundary  $C_n\{\mathbb{R}^m\}$  has two strata, namely  $\mathbb{R}^m \times \tilde{C}_n(\mathbb{R}^m) \times (0, \infty)$ , which we will identify with  $C_n(\mathbb{R}^m)$ , and  $\mathbb{R}^m \times \tilde{C}_n(\mathbb{R}^m) \times 0$ , the points added in this closure. We will see that these correspond to  $C_{\Psi}(\mathbb{R}^m)$  and  $C_{\Psi}(\mathbb{R}^m)$ , respectively.

To prove Theorem 3.12 we define a map  $\nu: D_n\{\mathbb{R}^m\} \rightarrow A_n\{\mathbb{R}^m\}$  and show that it is a homeomorphism onto  $C_n\{\mathbb{R}^m\}$ . The map  $\nu$  will essentially be an expansion from the point in  $\mathbb{R}^m$  of the infinitesimal configuration given by the point in  $\tilde{C}_n(\mathbb{R}^m) \subset (\mathbb{R}^m)^{\mathbb{Z}}$ .

**Definition 3.13.** (1) Define  $\eta: D_n\{\mathbb{R}^m\} \rightarrow (\mathbb{R}^m)^n$  by sending  $x \times (y_i) \times t$  to  $(x + ty_i)$ .

(2) Let  $p$  denote the projection from  $D_n\{\mathbb{R}^m\}$  onto  $\tilde{C}_n(\mathbb{R}^m)$ .

(3) Let  $\tilde{\pi}_{ij}$  and  $\tilde{s}_{ijk}$  denote the maps on  $\tilde{C}_n(\mathbb{R}^m)$  which when composed with  $q$  give the original  $\pi_{ij}$  and  $s_{ijk}$ .

(4) Finally, define  $\nu: D_n\{\mathbb{R}^m\} \rightarrow A_n\{\mathbb{R}^m\}$  by  $\eta \times (\tilde{\pi}_{ij} \circ p) \times (\tilde{s}_{ijk} \circ p)$ .

When  $t > 0$ , the image of  $\eta$  is in  $C_n(\mathbb{R}^m)$ , and moreover we have the following.



**Proposition 3.14.** *The map  $\nu|_{t>0}$  coincides with  $\alpha_n \circ \eta$ , a diffeomorphism from  $\mathbb{R}^m \times \tilde{C}_n(\mathbb{R}^m) \times (0, \infty)$  onto the image of  $\alpha_n$ .*

*Proof.* For  $t > 0$ , the map  $\eta$  satisfies  $\tilde{\pi}_{ij} \circ p = \pi_{ij} \circ \eta$ , and similarly  $\tilde{s}_{ijk} \circ p = s_{ijk} \circ \eta$ , showing that  $\nu|_{t>0}$  coincides with  $\alpha_n \circ \eta$ .

The inverse to  $\nu|_{t>0}$  is the product of: the map which sends  $(x_i)$  to its the center of mass, the quotient map  $q$  to  $\tilde{C}_n(\mathbb{R}^m)$ , and the map whose value is the greatest distance from one of the  $x_i$  to the center of mass. Both  $\nu|_{t>0}$  and its inverse are clearly smooth.  $\square$

**Corollary 3.15.**  $\nu|_{t=0}$  has image in  $C_n\{\mathbb{R}^m\}$ .

We come to the heart of the matter, identifying  $C_n\{\mathbb{R}^m\}$  as a closed subspace of  $A_n\{\mathbb{R}^m\}$ . We will apply this case repeatedly in analysis of  $C_n[\mathbb{R}^m]$ .

**Definition 3.16.** Let  $\tilde{A}_n[\mathbb{R}^m] = (S^{m-1})^{C_2(\underline{n})} \times I^{C_3(\underline{n})}$ , and let  $\tilde{A}_n\{\mathbb{R}^m\} = (S^{m-1})^{C_2(\underline{n})} \times (0, \infty)^{C_3(\underline{n})}$ .

*Convention.* We extend multiplication to  $[0, \infty]$  by setting  $a \cdot \infty = \infty$  if  $a \neq 0$  and  $0 \cdot \infty = 1$ .

**Definition 3.17.** We say that vectors  $\{v_i\}$  are positively dependent if  $\sum a_i v_i = 0$  for some  $\{a_i\}$  with all  $a_i > 0$ . Similarly,  $\{v_i\}$  are non-negatively dependent if all  $a_i \geq 0$ .

**Lemma 3.18.** *The map  $\iota_n = (\tilde{\pi}_{ij}) \times (\tilde{s}_{ijk}) : \tilde{C}_n(\mathbb{R}^m) \rightarrow \tilde{A}_n[\mathbb{R}^m]$  is a diffeomorphism onto its image, which is closed as a subspace of  $\tilde{A}_n\{\mathbb{R}^m\}$ .*

*Proof.* Collinear configurations up to translation and scaling are clearly determined by their image under one  $\tilde{\pi}_{ij}$  and the  $\tilde{s}_{ijk}$ . For non-collinear configurations, we may reconstruct  $\mathbf{x} = (x_i)$  from the  $u_{ij} = \tilde{\pi}_{ij}(\mathbf{x})$  and  $d_{ijk} = \tilde{s}_{ijk}(\mathbf{x})$  up to translation and scaling by for example setting  $x_1 = \vec{0}$ ,  $x_2 = u_{12}$  and then  $x_i = d_{1i2}u_{1i}$  for any  $i$ . These assignments of  $x_i$  are smooth functions, so in fact  $\iota_n$  is a diffeomorphism onto its image.

For the sake of showing that the image of  $\iota_n$  is closed, as well as use in Section 5, we note that  $d_{1i2}$  can be determined from the  $u_{ij}$  by the law of sines. If  $\pm u_{ij}$ ,  $\pm u_{jk}$  and  $\pm u_{ik}$  are distinct, then

$$\frac{|x_i - x_j|}{\sqrt{1 - (u_{ki} \cdot u_{kj})^2}} = \frac{|x_j - x_k|}{\sqrt{1 - (u_{ij} \cdot u_{ik})^2}} = \frac{|x_i - x_k|}{\sqrt{1 - (u_{ji} \cdot u_{jk})^2}}.$$

Thus, in most cases  $d_{1i2} = \sqrt{\frac{1 - (u_{2i} \cdot u_{21})^2}{1 - (u_{i1} \cdot u_{i2})^2}}$ . In general, as long as not all points are collinear, the law of sines above can be used repeatedly to determine all  $d_{ijk}$  from the  $u_{ij}$ , which shows that when restricted to non-collinear configurations,  $(\tilde{\pi}_{ij})$  itself is injective.

We identify the image of  $\iota_n$  as the set of all points  $(u_{ij}) \times (d_{ijk})$  which satisfy the following conditions needed to consistently define an inverse to  $\iota_n$ :

- (1)  $u_{ij} = -u_{ji}$ .
- (2)  $u_{ij}$ ,  $u_{jk}$  and  $u_{ki}$  are positively dependent.
- (3) If  $\pm u_{ij}$ ,  $\pm u_{jk}$  and  $\pm u_{ik}$  are distinct, then  $d_{ijk} = \sqrt{\frac{1 - (u_{ik} \cdot u_{jk})^2}{1 - (u_{ij} \cdot u_{jk})^2}}$ .
- (4)  $d_{ijk}$  are non-zero and finite, and

$$d_{ijk}d_{ikj} = 1 = d_{ijk}d_{jki}d_{kij} = d_{ijk}d_{ilj}d_{ikl}.$$

We say a condition is closed if the subspace of points which satisfy it is closed. Note that Condition 4 follows from Condition 3 when the latter applies.

Condition 1 is clearly closed, and Condition 4 is a closed condition in  $\tilde{A}_n\{\mathbb{R}^m\}$ , since we are already assuming that  $d_{ijk} \in (0, \infty)$ . Condition 3 says that on an open subspace of this image, the  $d_{ijk}$  are a function of the  $u_{ij}$  and gives no restrictions away from this subspace, and so is also a closed condition.

Considering Condition 2, it is a closed condition for  $u_{ij}$ ,  $u_{jk}$  and  $u_{ik}$  to be dependent, but it is not usually closed to be strictly positively dependent. But the only dependence which can occur with a coefficient of zero happens when  $u_{ki} = -u_{jk}$  and  $u_{ij} \neq \pm u_{jk}$ . In this case  $d_{ijk}$  would need to be 0 by Condition 3, which cannot happen in  $\tilde{A}_n\{\mathbb{R}^m\}$ . So in fact Condition 2 is closed within the points in  $\tilde{A}_n\{\mathbb{R}^m\}$  satisfying Condition 3.  $\square$

Because  $\nu|_{t=0}$  is the product of the diagonal map  $\mathbb{R}^m \rightarrow (\mathbb{R}^m)^{\underline{n}}$ , which is a diffeomorphism onto its image, with  $\iota_n$  we may deduce the following.

**Corollary 3.19.**  $\nu|_{t=0}$  is a diffeomorphism onto its image.

We may now finish analysis of  $C_n\{\mathbb{R}^m\}$ .

*Proof of Theorem 3.12.* Proposition 3.14 and Corollary 3.19 combine to give that  $\nu_T: D_T\{\mathbb{R}^m\} \rightarrow C_T\{\mathbb{R}^m\}$  is injective. We thus want to show that it is surjective and has a continuous inverse.

Consider the projection  $p$  from  $C_n\{\mathbb{R}^m\} \subset A_n\{\mathbb{R}^m\}$  to  $(x_i) \in (\mathbb{R}^m)^{\underline{n}}$ . Over  $C_n(\mathbb{R}^m)$  the image of  $\alpha_n$  is its graph, which is locally closed, so  $p^{-1}(C_n(\mathbb{R}^m)) \cong C_n(\mathbb{R}^m)$ . If  $x_i = x_j$  but  $x_i \neq x_k$  for some  $i, j, k$ , continuity of  $s_{ijk}$  would force  $d_{ijk} = 0$ , which is not possible in  $A_n\{\mathbb{R}^m\}$ . Thus no points in  $C_n\{\mathbb{R}^m\}$  lie over such  $(x_i)$ . Over the diagonal of  $(\mathbb{R}^m)^{\underline{n}}$  we know that  $C_n\{\mathbb{R}^m\}$  contains at least the image of  $\nu|_{t=0}$ . But by Lemma 3.18, we may deduce that this image is closed in  $A_n\{\mathbb{R}^m\}$  and thus accounts for all of  $C_n\{\mathbb{R}^m\}$  over the diagonal.

We define an inverse to  $\nu_T$  according to this decomposition over  $(\mathbb{R}^m)^{\underline{n}}$ . For a point in  $C_n(\mathbb{R}^m)$ , the inverse was given in Proposition 3.14. For points over the diagonal ( $x_i = x$ ) in  $(\mathbb{R}^m)^{\underline{n}}$ , the inverse is a product of the map which sends such a point to  $x \in \mathbb{R}^m$ ,  $\iota_n^{-1}$ , and the constant map whose image is  $0 \in [0, \infty)$ . Smoothness of this inverse is straightforward and left to the reader.  $\square$

**3.4. Proof of Theorem 3.8 for  $M = \mathbb{R}^m$ .** Analysis of  $C_T(\mathbb{R}^m)$  parallels that of  $C_n\{\mathbb{R}^m\}$ . A key construction is that of a map  $\nu_T: N_T \rightarrow A_n[\mathbb{R}^m]$ , where  $N_T \subset D_T(\mathbb{R}^m) \times [0, 1)^{V_i(T)}$  is a chosen neighborhood of  $D_T(\mathbb{R}^m) \times (t_v = 0)$ . Although as mentioned before,  $D_T(\mathbb{R}^m)$  is a subspace of  $(\mathbb{R}^m)^{E(T)}$ , we emphasize the role of the vertices of  $T$  in the definition of  $D_T(\mathbb{R}^m)$  by naming coordinates on  $\mathbf{x} \in D_T(\mathbb{R}^m)$  as  $\mathbf{x} = (x_e^v)$ , where  $v \in V(T)$  and  $e \in E(v)$ . Recall that for each  $v \neq v_0$  we consider  $\tilde{C}_{\#v}(\mathbb{R}^m)$  as a subspace of  $C_{\#v}(\mathbb{R}^m)$  in order to fix each  $x_e^v$  as an element of  $\mathbb{R}^m$ .

**Definition 3.20.** (1) Let  $N_T(\mathbb{R}^m)$  be the subset of  $D_T(\mathbb{R}^m) \times [0, 1)^{V_i(T)}$  of points  $\mathbf{x} \times (t_v)$ , where  $\mathbf{x}$  can be any point in  $D_T(\mathbb{R}^m)$ , all  $t_v < r(\mathbf{x})$ , defined by

$$\frac{r(\mathbf{x})}{(1 - r(\mathbf{x}))} = \frac{1}{3} \min\{d(x_e^v, x_{e'}^{v'})\}, \text{ where } v \in V(T), e, e' \in E(v).$$

- (2) By convention, set  $t_{v_0} = 1$ . Let  $s_w: N_T \rightarrow [0, 1)$  send  $\mathbf{x} \times (t_v)$  to the product of  $t_v$  for  $v$  in the root path of  $w$ .
- (3) For any vertex  $v$  of an  $f$ -tree  $T$  define  $y_v: N_T(\mathbb{R}^m) \rightarrow \mathbb{R}^m$  inductively by setting  $y_{v_0} = 0$  and  $y_v(\mathbf{x}) = s_w x_e^w + y_w(\mathbf{x})$ , where  $e$  is the edge for which  $v$  is terminal and  $w$  is the initial vertex of  $e$ . Define  $\eta_T: N_T \rightarrow (\mathbb{R}^m)^{l(T)}$  to be  $(y_\ell)^{l(T)}$ .

**Figure 3.21.**  $\eta_T$  of the point from Figure 3.7 (and some  $t_v > 0$ ) with all  $y_v$  indicated.

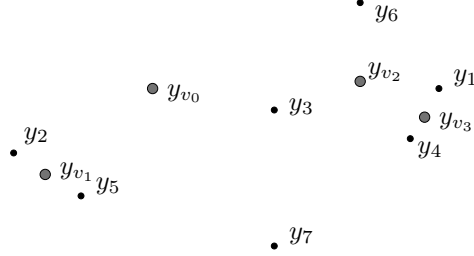

See Figure 3.21 for an illustration of this construction. The most basic case is when  $T = \mathbb{V}$  the terminal object of  $\Psi_n$ , in which case  $N_{\mathbb{V}}(\mathbb{R}^m) = D_{\mathbb{V}}(\mathbb{R}^m) = C_n(\mathbb{R}^m)$  and  $\eta_{\mathbb{V}}$  is the canonical inclusion in  $(\mathbb{R}^m)^{\mathbb{A}}$ .

- Definition 3.22.**
- (1) Given a vertex  $w$  of  $T$ , let  $T_w$  be the  $f$ -tree consisting of all vertices and edges over  $w$ , where  $w$  serves as the root of  $T_w$  and the leaves over  $w$  are re-labelled consistent with the order of their labels in  $T$ .
  - (2) Let  $\rho_w : N_T(\mathbb{R}^m) \rightarrow N_{T_w}(\mathbb{R}^m)$  be the projection onto factors indexed by vertices in  $T_w$ , but with  $t_w$  set to one and the projection onto  $\tilde{C}_{\#w}(\mathbb{R}^m)$  composed with the canonical inclusion to  $C_{\#w}(\mathbb{R}^m)$ .
  - (3) Let  $f_{ij}$  be the composite  $\pi_{i'j'} \circ \eta_{T_v} \circ \rho_v$ , where  $v$  is the join of the leaves labelled  $i$  and  $j$ , and  $i'$  and  $j'$  are the labels of the corresponding leaves of  $T_v$ . Similarly, let  $g_{ijk}$  be the composite  $s_{i'j'k'} \circ \eta_{T_w} \circ \rho_w$  where  $w$  is the join of leaves  $i, j$  and  $k$ .
  - (4) Define  $\nu_T : N_T \rightarrow A_n[\mathbb{R}^m]$  to be the product  $\eta_T \times (f_{ij}) \times (g_{ijk})$ . Let  $\nu_T^0$  be the restriction of  $\nu_T$  to  $D_T \times (0)^n \subset N$ .

**Proposition 3.23.** *The image of  $D_T(\mathbb{R}^m)$  under  $\nu_T^0$  lies in  $C_T(\mathbb{R}^m)$ .*

*Proof.* First note that  $\eta_T|_{(t_i > 0)}$  has image in  $C_n(\mathbb{R}^m)$ . Moreover, if all  $t_i > 0$ ,  $f_{ij}$  coincides with  $\pi_{ij} \circ \eta_T$  and similarly  $g_{ijk} = s_{ijk} \circ \eta_T$ . Thus, the image of  $\nu_T|_{(t_i > 0)}$  lies in  $\alpha_n(C_n(M))$ , which implies that all of the image of  $\nu_T$ , and in particular that of  $\nu_T^0$ , lies in  $C_n[M]$ .

If  $v$  is the join of leaves  $i, j$  and  $k$  and we set  $(y_i) = \nu_{T_v}^0 \circ \rho_v(\mathbf{x}, (t_v))$ , then  $y_{i'} = y_{j'}$  and thus  $d_{ijk} = s_{ijk}(y_i) = 0$  if and only if the join of leaves  $i$  and  $j$  is some vertex which lies (strictly) over  $v$ . Thus, the exclusion relation for  $\nu_T^0(\mathbf{x}, (t_v))$  as an element of  $C_n[M]$  is the exclusion relation associated to  $T$ .  $\square$

The simplest way to see that  $\nu_T^0$  is a homeomorphism onto  $C_T(\mathbb{R}^m)$  is to decompose it as a product and use our analysis of  $C_n\{\mathbb{R}^m\}$  to help define an inverse.

**Definition 3.24.** Let  $A_T[M] \subset A_n[\mathbb{R}^m]$  be the subset of points  $(x_i) \times (u_{ij}) \times (d_{ijk})$  such that

- (1) If the join of leaves  $i$  and  $j$  is not the root vertex, then  $x_i = x_j$ .
- (2) If  $(i, j), k$  is in the exclusion relation  $\mathcal{E}x(T)$ , then  $d_{ijk} = 0$ ,  $d_{ikj} = \infty$ ,  $d_{kij} = 1$ , and  $u_{ik} = u_{jk}$ .

Let  $A_T\{M\}$  be the subspace of  $A_T[M]$  for which if there are no exclusions among  $i, j$  and  $k$ , then  $d_{ijk}$  is non-zero and finite.

We claim that  $C_T(\mathbb{R}^m) = C_n[\mathbb{R}^m] \cap A_T\{\mathbb{R}^m\}$ . The relations between the  $x_i, u_{ij}$  and  $d_{ijk}$  which hold on  $C_n(\mathbb{R}^m)$  also hold on  $C_T(\mathbb{R}^m)$  by continuity. Therefore, the defining conditions of  $A_T\{\mathbb{R}^m\}$  when restricted to its intersection with  $C_n[\mathbb{R}^m]$  will follow from the conditions  $d_{ijk} = 0$  when  $(i, j)k \in \mathcal{E}x(T)$ , which in turn are the only defining conditions for  $C_T[\mathbb{R}^m]$ .

Thus the image of  $\nu_T^0$  lies in  $A_T\{\mathbb{R}^m\}$ . By accounting for diagonal subspaces and reordering terms, we will decompose  $\nu_T^0$  as a product of maps in order to define its inverse. We first set some notation.

**Definition 3.25.** Given a map of sets  $\sigma : R \rightarrow S$  let  $p_{\sigma}^X$ , or just  $p_{\sigma}$ , denote the map from  $X^S$  to  $X^R$  which sends  $(x_i)_{i \in S}$  to  $(x_{\sigma(j)})_{j \in R}$ .

- Definition 3.26.** (1) Given a tree  $T$  choose  $\sigma_0 : \#v_0 \rightarrow \underline{n}$  to be an inclusion of sets such that each point in the image labels a leaf which lies over a distinct root edge of  $T$ .
- (2) Similarly, choose  $\sigma_v : \#v \rightarrow \underline{n}$  to be an inclusion whose image labels leaves which lie over distinct edges for which  $v$  is initial.
- (3) Let  $p_{v_0} : A_n[\mathbb{R}^m] \rightarrow A_{\#v_0}[\mathbb{R}^m]$  be the projection  $p_{\sigma_0} \times p_{C_2(\sigma_0)} \times p_{C_3(\sigma_0)}$ .
- (4) Similarly, let  $p_v : A_n[\mathbb{R}^m] \rightarrow \tilde{A}_{\#v}[\mathbb{R}^m]$  be the projection  $* \times p_{C_2(\sigma_v)} \times p_{C_3(\sigma_v)}$ .
- (5) Let  $p_T$  be the product  $(p_v)^{V(T)}$ .

For example, with  $T$  as in Figure 2.2, the image of  $\sigma_0$  could be  $\{5, 7, 4\}$  and of  $\sigma_{v_1}$  could be  $\{2, 5\}$ .

**Proposition 3.27.** *For any choice of  $\sigma_v$ , the projection  $p_T$  restricted to  $A_T[\mathbb{R}^m]$  is a diffeomorphism onto  $A_{\#v_0}[\mathbb{R}^m] \times \left(\tilde{A}_{\#v}(\mathbb{R}^m)\right)^{V^i(T)}$ , splitting the inclusion of  $A_T[\mathbb{R}^m]$  in  $A_n[\mathbb{R}^m]$ . Moreover, composed with this diffeomorphism,  $\nu_T^0$  is the product  $\alpha_{\#v_0} \times (\iota_{\#v})$ . Analogous results hold for  $A_T\{\mathbb{R}^m\}$ .*

We leave the proof of this proposition, which is essentially unraveling definitions, to the reader. We will now define the inverse to  $\nu_T^0$  one vertex at a time. For  $v \in V^i(T)$ , consider  $p_v(y) \in \tilde{A}_{\#v}\{\mathbb{R}^m\}$ , which by Lemma 1.5 lies in the closure of the image of  $p_v|_{C_n(\mathbb{R}^m)}$ . The image of  $p_v|_{C_n(\mathbb{R}^m)}$  coincides with the image of  $\iota_{\#v}$ , and by Lemma 3.18 the image of  $\iota_{\#v}$  is already closed in  $\tilde{A}_{\#v}\{\mathbb{R}^m\}$ . Moreover,  $\iota_{\#v}$  is a diffeomorphism onto its image, so we may define the following.

- Definition 3.28.** (1) For  $v \in V^i(T)$ , let  $\phi_v : C_T(\mathbb{R}^m) \rightarrow \tilde{C}_{\#v}(\mathbb{R}^m) = \iota_{\#v}^{-1} \circ p_v$ .
- (2) For  $v_0$ , note that if  $y \in C_T(\mathbb{R}^m)$ , then  $p_{v_0}(y)$  lies in the image of  $\alpha_{\#v_0}$ . Define  $\phi_{v_0} = \alpha_{\#v_0}^{-1} \circ p_{v_0}$ .
- (3) Let  $\phi_T = (\phi_v)^{v \in V(T)} : C_T(\mathbb{R}^m) \rightarrow C_{\#v_0}(\mathbb{R}^m) \times (C_{\#v}(\mathbb{R}^m))^{V^i(T)}$ .

In other words,  $\phi_T$  is the composite:

$$(1) \quad C_T(\mathbb{R}^m) \subset A_T\{\mathbb{R}^m\} \xrightarrow{p_v} A_{\#v_0}\{\mathbb{R}^m\} \times \left(\tilde{A}_{\#v}\{\mathbb{R}^m\}\right)^{V^i(T)} \\ \xrightarrow{\alpha_{\#v_0}^{-1} \times (\iota_{\#v}^{-1})^{V^i(T)}} C_{\#v_0}(\mathbb{R}^m) \times \left(\tilde{C}_{\#v}(\mathbb{R}^m)\right)^{V^i(T)} = D_T(\mathbb{R}^m).$$

*Proof of Theorem 3.8 for  $M = \mathbb{R}^m$ .* By Proposition 3.23,  $\nu_T^0$  sends  $D_T(\mathbb{R}^m)$  to  $C_T(\mathbb{R}^m) \subset A_n[\mathbb{R}^m]$ . Definition 3.28 constructs  $\phi_T : C_T(\mathbb{R}^m) \rightarrow D_T(\mathbb{R}^m)$ . By construction, and appeal to Lemma 3.18, they are inverse to one another. We also need to check that  $\nu_T^0$  and  $(\phi_v)$  are smooth, which follows by checking that their component functions only involve addition, projection and  $\iota_n^{-1}$  which we know is smooth from Lemma 3.18.  $\square$

**3.5. Proof of Theorem 3.8 for general  $M$ .** To establish Theorem 3.8 for general  $M$  we first identify  $D_T(M)$  as a subspace of  $D_T(\mathbb{R}^m)$ , and then we will make use of the established diffeomorphism between  $D_T(\mathbb{R}^m)$  and  $C_T(\mathbb{R}^m)$ . To set notation, let  $\epsilon$  be the given embedding of  $M$  in  $\mathbb{R}^m$ .

**Proposition 3.29.** *The subspace  $ID_n(M)$  of  $M \times \tilde{C}_n(\mathbb{R}^m)$  consisting of all  $(m, \mathbf{x})$  such that all  $\pi_{ij}(\mathbf{x})$  are in  $T_m M \subset \mathbb{R}^m$  is diffeomorphic, as a bundle over  $M$ , to  $IC_n(M)$ . Through these diffeomorphisms,  $D_T(M)$  is a subspace of  $D_T(\mathbb{R}^m)$ .*

*Proof sketch.* The first statement follows from the standard identification of  $TM$  as a sub-bundle of  $T\mathbb{R}^m|_M$ . The second statement follows from the first statement and Definition 3.6 of  $D_T(M)$ .  $\square$

From now on, we identify  $D_T(M)$  with this subspace of  $D_T(\mathbb{R}^m)$ .

**Proposition 3.30.**  $C_T(M) \subseteq \nu_T^0(D_T(M))$ .

*Proof.* Since  $C_T(M)$  is already a subspace of  $C_T[\mathbb{R}^m]$ , we just need to check that its points satisfy the condition of Proposition 3.29. Looking at  $(x_i) \times (u_{ij}) \times (d_{ijk}) \in C_n(M)$  inside  $A_n[M]$  we see that the  $u_{ij}$  are vectors which are secant to  $M$ . Thus, in the closure, if  $x_i = x_j$ , then  $u_{ij}$  is tangent to  $M$  at  $x_i$ .  $\square$

To prove the converse to this proposition, we show that  $\nu_T^0(D_T(M))$  lies in  $C_T(M)$  by modifying the maps  $\eta_T$  and  $\nu_T$  so that the image of the latter is in the image of  $\alpha_n$ . The easily remedied defect of  $\eta_T$  is that it maps to the image of the tangent bundle of  $M$  in  $\mathbb{R}^m$ , and not to  $M$  itself.

**Definition 3.31.** (1) Let  $N_T(M) \subset N_T(\mathbb{R}^m)$  be the subspace of  $(\mathbf{x}, (t_v))$  with  $\mathbf{x} \in D_T(M)$ .  
 (2) Let  $\eta_T^* : N_T(M) \rightarrow (\mathbb{R}^m)^n \times (\mathbb{R}^m)^n = T(\mathbb{R}^m)^n$  send  $(\mathbf{x}, (t_v))$  to  $\eta_T(\mathbf{x}, (0)) \times \eta_T(\mathbf{x}, (t_v))$ .

**Proposition 3.32.** *The image of  $\eta_T^*$  lies in  $T\epsilon^n : TM^n \subset T(\mathbb{R}^m)^n$ .*

*Proof.*  $\eta_T(\mathbf{x}, (t_v))$  is defined by adding vectors which by Proposition 3.29 are tangent to  $M$  to the coordinates of  $\eta_T(\mathbf{x}, (t_v))$ , which are in  $M$ .  $\square$

We map to  $M^{\mathbb{Z}}$  by composing with the exponential map  $Exp(M)$ . For each  $\mathbf{x} \in D_T(M)$  let  $U_{\mathbf{x}}$  be a neighborhood of  $\mathbf{x} \times 0$  in  $N_T(M)$  such that the exponential map  $Exp(M^{\mathbb{Z}})$  is injective on  $\eta_T^*(U_{\mathbf{x}})$ .

**Definition 3.33.** (1) Let  $\eta_T^{M,\mathbf{x}} : U_{\mathbf{x}} \rightarrow M^{\mathbb{Z}}$  be the composite  $Exp(M^{\mathbb{Z}}) \circ (T\epsilon^n)^{-1} \circ \eta_T^*$ .  
 (2) Define  $f_{ij}^{M,\mathbf{x}}$  by letting  $(z_i)$  denote  $\eta_T^{M,\mathbf{x}}(\mathbf{y}, (t_v))$  and setting  $f_{ij}^{M,\mathbf{x}} = \pi_{ij} \circ \eta_T^{M,\mathbf{x}}$  if  $z_i \neq z_j$  or  $DExp \circ f_{ij}^{M,\mathbf{x}}$ , where  $DExp$  is the derivative of the exponential map at  $z_i \in TM$  and the composite is well defined since  $TM \subset T\mathbb{R}^m$ .  
 (3) Define  $\nu_T^{M,\mathbf{x}} : U_{\mathbf{x}} \rightarrow A_n[M]$  as the product  $\eta_T^{M,\mathbf{x}} \times (f_{ij}^{M,\mathbf{x}}) \times (s_{ijk} \circ \eta_T^{M,\mathbf{x}})$ .

By construction, the image of  $\nu_T^{M,\mathbf{x}}|_{(t_i > 0)}$  in  $A_n[M]$  lies in the image of  $\alpha_n$ . On  $D_T(M) \cap U_{\mathbf{x}}$  the map  $\nu_T^{M,\mathbf{x}}$  coincides with  $\nu_T^0$  establishing that  $\nu_T^0(D_T(M)) \subset C_T(M)$ . Along with Proposition 3.30 and the fact that  $\nu_T^0$  and its inverse are smooth, this completes the proof of Theorem 3.8.

#### 4. FIRST PROPERTIES

Having proved Theorem 3.8 we derive some first consequences from both the theorem and the arguments of its proof.

**4.1. Characterization in  $A_n[M]$  and standard projections.** To map from  $C_n[M]$ , as we have defined it, one may simply restrict maps from  $A_n[M]$ . To map into  $C_n[M]$  is more difficult, but the following theorem gives conditions to verify that some point in  $A_n[M]$  lies in  $C_n[M]$ .

**Theorem 4.1.**  *$C_n[\mathbb{R}^m]$  is the subspace of  $A_n[\mathbb{R}^m]$  of points  $(x_i) \times (u_{ij}) \times (d_{ijk})$  such that*

- (1) *If  $x_i \neq x_k$ , then  $u_{ij} = \frac{x_i - x_k}{\|x_i - x_k\|}$  and  $d_{ijk} = \frac{d(x_i, x_j)}{d(x_i, x_k)}$ .*
- (2) *If  $\pm u_{ij}, \pm u_{jk}$ , and  $\pm u_{ik}$  are all distinct, then  $d_{ijk} = \sqrt{\frac{1 - (u_{ki} \cdot u_{kj})^2}{1 - (u_{ji} \cdot u_{jk})^2}}$ . Otherwise, if  $u_{ik} = u_{jk} \neq u_{ij}$ , then  $d_{ijk} = 0$ .*
- (3)  *$u_{ij} = -u_{ji}$ , and  $u_{ij}, u_{jk}$ , and  $u_{ki}$  are non-negatively dependent.*
- (4)  *$d_{ijk}d_{ikj}, d_{ijk}d_{ikl}d_{ilj}$  and  $d_{ijk}d_{jki}d_{kij}$  are all equal to one.*

*Moreover,  $C_n[M]$  is the subspace of  $C_n[\mathbb{R}^m]$  where all  $x_i \in M$  and if  $x_i = x_j$ , then  $u_{ij}$  is tangent to  $M$  at  $x_i$ .*

*Proof.* It is simple to check that  $C_n[\mathbb{R}^m]$  satisfies all of the properties listed. In most cases, the properties are given by equalities which hold on  $C_n(\mathbb{R}^m)$  and thus  $C_n[\mathbb{R}^m]$  by continuity. We noted in Proposition 3.30 that if  $x_i = x_j$  in  $C_n[M]$ , then  $u_{ij}$  is tangent to  $M$ .

Conversely, we can start with a point  $x$  which satisfies these properties, and Condition 4 allows us to define  $T(x)$  as in Definition 3.1. We can then either mimic the construction of  $\eta_T(x)$  to find points in

the image of  $\alpha_n$  nearby showing that  $x \in C_n[M]$ , or go through the arguments of Section 3, in particular the proof of Lemma 3.18, to find an element of  $D_T(M)$  which maps to  $x$  under  $\nu_0^T$ . The latter argument proceeds by showing that  $x$  lies in  $A_{T(x)}[\mathbb{R}^m]$ , as we may use the contrapositives to Conditions 1 and 2 along with 3 to show that if  $d_{ijk} = 0$ , then  $x_i = x_j$  and  $u_{ik} = u_{jk}$ . Then,  $p_{v_0}(x)$  lies in the image of  $\alpha_{\#v_0}$  essentially by Condition 1. Next,  $p_v(x)$  lies in the image of  $\iota_{\#v}$  by Conditions 2, 3 and 4, as these conditions coincide with those given for the image of  $\iota$  in Lemma 3.18. We apply the product  $(\phi_v)$  to get a point in  $D_T(\mathbb{R}^m)$  which maps to  $x$  under  $\nu_T^0$ .  $\square$

We next turn our attention to the standard projection maps.

**Theorem 4.2.** *By restricting the projection of  $A_n[M]$  onto  $(M)^n$  to  $C_n[M]$ , we obtain a projection map  $p$  which is onto, which extends the inclusion  $\iota$  of  $C_n(M)$  in  $(M)^n$  and for which every point in  $C_n(M)$  has only one pre-image.*

*Proof.* The fact that  $p$  is onto can be seen through composing  $p$  with the maps  $\nu_0^T$ . It is immediate from definitions that  $p$  extends  $\iota$ . Finally, by our characterization in Theorem 4.1, in particular Condition 1, any point in  $C_n[M]$  which projects to  $C_n(M)$  will be in the image of  $\alpha_n$ .  $\square$

When  $M = \mathbb{R}^m$ , it is meaningful to project onto other factors of  $A_n[\mathbb{R}^m]$  to get similar extensions.

**Theorem 4.3.** *The maps  $\pi_{ij}$  and  $s_{ijk}$  extend to maps from  $C_n[\mathbb{R}^m]$ . Moreover, the extension  $\pi_{ij}$  is an open map.*

*Proof.* The only statement which is not immediate is that  $\pi_{ij}$  is an open map. We check this on each stratum, using the identification of  $C_T(\mathbb{R}^m)$  as a product. When  $\pi_{ij}$  is restricted to  $C_T(\mathbb{R}^m)$  it factors as  $p_v$ , where  $v$  is the join of leaves  $i$  and  $j$ , composed with some  $\tilde{\pi}_{i'j'}$ , each of which is an open map.  $\square$

## 4.2. Manifold structure, codimensions of strata, functoriality for embeddings, and equivariance.

**Theorem 4.4.**  *$C_n[M]$  is a manifold with corners for which the  $\nu_T^{M,\mathbf{x}}$  may serve as charts.*

*Proof.* The domains of  $\nu_T^{M,\mathbf{x}}$  are manifolds with corners, so it suffices to check that these maps are diffeomorphisms onto their images in  $A_n[M]$ , which is itself a manifold with corners. We have already noted that  $\nu_T^{M,\mathbf{x}}$  are smooth on their domain, as they are defined using addition in  $\mathbb{R}^m$ , projection maps, and the exponential map. Moreover, they may be extended using the same formulas to values of  $t_v < 0$ , as needed for smoothness with corners.

For  $M = \mathbb{R}^m$ , the inverse to  $\nu_T$  is relatively straightforward to define. Given  $\mathbf{x} = (x_i) \times (u_{ij}) \times (d_{ijk}) \in A_n[\mathbb{R}^m]$ , first recursively set  $y_v$  to be the average of  $y_w$ , where  $w$  are terminal vertices for edges coincident at  $v$ , starting with  $y_l = x_i$  when  $l$  is the leaf labelled by  $i$ . We let  $(y_v)$ , as  $v$  ranges over terminal vertices for root edges of  $T$ , define  $\mathbf{x}_{v_0} \in C_{\#v_0}(\mathbb{R}^m)$ .

Along the same lines, for each vertex  $v$  first define a point in  $(\mathbb{R}^m)^{l(T_v)}/Sim_k$ , as in the definition of  $\iota_n^{-1}$ , by setting some  $x_i = 0$ , some  $x_k = u_{ik}$  and the rest of the  $x_j$  as  $d_{ijk}x_{ij}$ . Recursively set  $x_w$  to be the average of  $x_u$  for  $u$  directly over  $w$  (which is well defined up to translation and scaling) and let  $(x_w)$  as  $w$  ranges over vertices directly over  $v$  define  $\mathbf{x}_v \in \tilde{C}_{\#v}(\mathbb{R}^m)$ .

Finally, to compute  $t_w$  we look within the construction above of  $\mathbf{x}_v$  for the vertex  $v$  over which  $w$  sits directly. Let  $d_w$  be the greatest distance from one of the  $x_u$ , for  $u$  over  $w$ , to  $x_w$ , and define  $d_v$  similarly. Set  $t_w$  to be  $d_w/d_v$ .

The map which sends  $\mathbf{x}$  as above to  $(\mathbf{x}_v) \times (t_v)$  is the inverse to  $\nu_T$ , and it is smooth, defined by averaging and greatest distance functions. The construction for general  $M$  works similarly, by first composing with the inverse to the exponential map. We leave its construction to the reader.  $\square$

Since a manifold with corners is a topological manifold with boundary, and a topological manifold with boundary is homotopy equivalent to its interiors, we get the following.

**Corollary 4.5.** *The inclusion of  $C_n(M)$  into  $C_n[M]$  is a homotopy equivalence.*

An essential piece of data for a manifold with corners are the dimensions of the strata. Dimension counting for  $D_T(M)$  leads to the following.

**Proposition 4.6.** *The codimension of  $C_T(M)$  is  $\#V^i(T)$ .*

Contrast this with the image of the projection of  $C_T(M)$  in  $M^{\mathbb{Z}}$ , which has codimension equal to  $k \cdot \dim(M)$ , where  $k$  is the sum over all root edges  $e$  of  $n_e - 1$  where  $n_e$  is the number of leaves over  $e$ .

Next, we have the following long-promised result.

**Theorem 4.7.** *Up to diffeomorphism,  $C_n[M]$  is independent of the embedding of  $M$  in  $\mathbb{R}^m$ .*

*Proof.* First note that the definitions of  $D_T(M)$  and  $N_T(M)$  do not use the embedding of  $M$  in  $\mathbb{R}^m$ . Let  $f$  and  $g$  be two embeddings of  $M$  in  $\mathbb{R}^m$ , and let  $\nu_T^{f,\mathbb{Z}}$  and  $\nu_T^{g,\mathbb{Z}}$  denote the respective versions of  $\nu_T^{M,\mathbb{Z}}$ . Then the  $\nu_T^{f,\mathbb{Z}} \circ (\nu_T^{g,\mathbb{Z}})^{-1}$  compatibly define a diffeomorphism between the two versions of  $C_n[M]$ .  $\square$

Since the exponential maps from  $T(M)^n$  to  $(M)^n$  are independent of the embedding of  $M$  in  $\mathbb{R}^k$ , so are  $\nu_T^{M,\mathbb{Z}}$ . Thus, we could use the  $\nu_T^{M,\mathbb{Z}}$  to topologize the union of the  $C_T(M)$  without reference to  $A_n[M]$ . Yet another approach would be to first develop  $C_n[\mathbb{R}^m]$  and then use a diffeomorphism result for these to patch  $C_n[M]$  together from  $C_m[U_i]$  for  $m \leq n$ , where  $U_i$  is a system of charts for  $M$ .

**Corollary 4.8.**  *$C_n[-]$  is functorial in that an embedding  $f: M \rightarrow N$  induces an embedding of manifolds with corners  $C_n[f]: C_n[M] \rightarrow C_n[N]$  which respects the stratifications. Moreover,  $C_T(M)$  is mapped to  $C_T(N)$  by  $Df$  on each factor of  $IC_i(M)$ .*

*Proof.* Since we are free to choose the embedding of  $M$  in  $\mathbb{R}^m$  to define  $C_n[M]$ , we may simply compose the chosen embedding of  $N$  in  $\mathbb{R}^m$  with  $f$ , giving immediately that  $C_n[M]$  is a subspace of  $C_n[N]$ . Moreover, by definition of the stratification according to conditions of  $d_{ijk} = 0$ ,  $C_T(M)$  is a subspace of  $C_T(N)$ . The fact that  $C_n[M]$  is embedded as a submanifold with corners is readily checked on each stratum, using the fact that  $IC_i(M)$  is a submanifold of  $IC_i(N)$  through  $Df$ .  $\square$

An alternate notation for  $C_n[f]$  is  $ev_n(f)$  as it extends the evaluation maps on  $C_n(M)$  and  $M^{\mathbb{Z}}$ .

**Corollary 4.9.** *The group of diffeomorphisms of  $M$  acts on  $C_n[M]$ , extending and lifting its actions on  $C_n(M)$  and  $M^{\mathbb{Z}}$ .*

The construction of  $C_n[M]$  is also compatible with the free symmetric group action  $C_n(M)$ .

**Theorem 4.10.** *The  $\Sigma_n$  action on  $C_n(M)$  extends to one on  $C_n[M]$ , which is free and permutes the strata by diffeomorphisms according to the  $\Sigma_n$  action on  $\Psi_n$ . Thus, the quotient  $C_n[M]/\Sigma_n$  is itself a manifold with corners whose category of strata is isomorphic to  $\tilde{\Psi}_n$ , the category of unlabelled  $f$ -trees.*

*Proof.* The  $\Sigma_n$  action on  $C_n[M]$  may in fact be defined as the restriction of the action on  $A_n[M]$  given by permutation of indices.

The fact that this action is free follows either from a stratum-by-stratum analysis or, more directly, from the fact that if  $\sigma$  is a permutation with a cycle  $(i_1, \dots, i_k)$  with  $k > 1$  and if  $u_{i_1 i_2} = u_{i_2 i_3} = \dots = u_{i_{k-1} i_k} = u$ , then  $u_{i_1 i_k} = u$  as well by Condition 3 of Theorem 4.1. This implies that  $u_{i_k i_1} = -u \neq u$ , which means that  $\sigma$  cannot fix a point in  $C_n[M]$  unless it is the identity.

Finally, note that the coordinate charts  $\nu_T^{M,\mathbb{Z}}$  commute with permutation of indices, so that  $\sigma C_T(M) = C_{\sigma T}(M)$  through a diffeomorphism, giving rise to a manifold structure on the quotient.  $\square$

**4.3. The closures of strata.** We will now see that the passage from the stratum  $C_T(M)$  to its closure, which by Theorem 3.4 consists of the union of  $C_S(M)$  for  $S$  with a morphism to  $T$ , is similar to the construction of  $C_n[M]$  itself. Recall Definition 3.9 of  $\tilde{C}_n(\mathbb{R}^m)$ .

**Definition 4.11.** Let  $\tilde{C}_n[\mathbb{R}^m]$  be defined as the closure of  $\tilde{C}_n(\mathbb{R}^m)$  in  $\tilde{A}_n[\mathbb{R}^m]$ .

Because  $\tilde{A}_n[\mathbb{R}^m]$  is compact, so is  $\tilde{C}_n[\mathbb{R}^m]$ . We give an alternate construction of this space as follows. Extend the action of  $Sim_k$  on  $(\mathbb{R}^m)^{\mathbb{Z}}$  to  $A_n[\mathbb{R}^m]$  by acting trivially on the factors of  $S^{m-1}$  and  $I$ . This action preserves the image of  $\alpha_n$  and so passes to an action on  $C_n[\mathbb{R}^m]$ . This is a special case of Corollary 4.9. Let  $A_n[\mathbb{R}^m]/\sim$  and  $C_n[\mathbb{R}^m]/\sim$  denote the quotients by these actions.

**Lemma 4.12.**  $\tilde{C}_n[\mathbb{R}^m]$  is diffeomorphic to  $C_n[\mathbb{R}^m]/\sim$ .

*Proof.* First note that  $A_n[\mathbb{R}^m]/\sim$  is compact, and thus so is  $C_n[\mathbb{R}^m]/\sim$ . The projection map from  $A_n[\mathbb{R}^m]/\sim$  to  $\tilde{A}_n[\mathbb{R}^m]$  thus sends  $C_n[\mathbb{R}^m]/\sim$  onto  $\tilde{C}_n[\mathbb{R}^m]$  by Lemma 1.5. In the other direction, we may essentially use the maps  $l_k^{-1}$  to define an inverse to this projection, by reconstructing a point in  $(\mathbb{R}^m)^{\mathbb{Z}}$  up to translation and scaling from its images under  $\pi_{ij}$  and  $s_{ijk}$ .  $\square$

We may define a stratification of  $\tilde{C}_n[\mathbb{R}^m]$  labelled by trees in the same fashion as for  $C_n[\mathbb{R}^m]$ , and the strata have a more uniform description than that of  $C_T(\mathbb{R}^m)$ .

**Corollary 4.13.**  $\tilde{C}_T(\mathbb{R}^m)$  is diffeomorphic to  $(\tilde{C}_{\#v}(\mathbb{R}^m))^{V(T)}$ .

*Proof.* We cite Lemma 4.12 and check that  $Sim_k$  is acting on each  $C_T(\mathbb{R}^m)$  non-trivially only on the factor of  $C_{\#v_0}(\mathbb{R}^m)$ , and doing so there by its standard diagonal action.  $\square$

Other results for  $C_n[\mathbb{R}^m]$  have similar analogues for  $\tilde{C}_n[\mathbb{R}^m]$ , which we will not state in general. One of note is that its category of strata is isomorphic to  $\tilde{\Psi}_n$ , the category of trees with a trunk.

**Definition 4.14.** (1) Define  $IC_n[M]$  as a fiber bundle over  $M$  with fiber  $\tilde{C}_n[\mathbb{R}^m]$  built from  $TM$  by taking the same system of charts but choosing coordinate transformations  $\tilde{C}_n[\phi_{ij}]$  from  $\tilde{C}_n[\mathbb{R}^m]$  to itself, where  $\phi_{ij}$  are the coordinate transformations defining  $TM$ .  
(2) Let  $IC_e[M]$  be defined as in Definition 3.6 but with  $IC_n[M]$  replacing  $IC_n(M)$ .  
(3) Let  $D_T[M]$  be defined through the pull-back

$$\begin{array}{ccc} D_T[M] & \longrightarrow & (IC_e[M])^{E_0} \\ \downarrow & & \downarrow \\ C_{\#v_0}[M] & \longrightarrow & (M)^{E_0}. \end{array}$$

**Theorem 4.15.**  $C_T[M]$  is diffeomorphic to  $D_T[M]$ .

*Proof.* Though by definition  $C_T[M]$  is the closure of  $C_T(M)$  in  $C_n[M]$ , it is also the closure of  $C_T(M)$  in any closed subspace of  $A_n[M]$ , and we choose to consider it as a subspace of  $A_T[M]$ . The inclusion of  $C_T(M)$  in  $A_T[M]$  is compatible with fiber bundle structures of these spaces over  $(M)^{E_0}$ . For a general fiber bundle  $F' \rightarrow E' \rightarrow B'$  subspaces respectively of  $F \rightarrow E \rightarrow B$ , the closure  $cl_E(E')$  may be defined by first extending  $E'$  to a bundle over  $cl_B(B')$  (which may be done locally) and then taking the closures fiber-wise. Our result follows from this general statement, the definition of  $C_{\#v_0}[M]$  as the closure of  $C_{\#v_0}(M)$  in  $A_{\#v_0}[M]$ , and the independence of the closure of the fibers  $\tilde{C}_i(\mathbb{R}^m)$  of  $IC_i(M)$  in any  $\tilde{A}_i[\mathbb{R}^m]$ .  $\square$



**4.4. Configurations in the line and associahedra.** The compactification of configurations of points in the line is a fundamental case of this construction. The configuration spaces  $C_n(\mathbb{R})$  and  $C_n(\mathbb{I})$  are disconnected, having one component for each ordering of  $n$  points. These different components each map to a different component of  $A_n[\mathbb{R}]$ , because whether  $x_i < x_j$  or  $x_i > x_j$  will determine a  $+$  or  $-$  for  $u_{ij} \in S^0$ . Let  $C_n^o[\mathbb{R}]$  and  $C_n^o[\mathbb{I}]$  denote the closure of the single component  $x_1 < \dots < x_n$ .

The main result of this subsection is that  $\tilde{C}_n[\mathbb{R}]$  is Stasheff's associahedron  $A_{n-2}$ , of which there is a pleasing description of  $A_n$  which we learned from Devadoss. The truncation of a polyhedron at some face (of any codimension) is the polyhedral subspace of points which are of a distance greater than some sufficiently small epsilon from that face. We may define  $A_n$  as a truncation of  $\Delta^n$ . In the standard way, label the codimension one faces of  $\Delta^n$  with elements of  $n+1$ . Call  $S \subset n+1$  consecutive if  $i, j \in S$  and  $i < k < j$  implies  $k \in S$ , and call a face of  $\Delta^n$  consecutive if the labels of codimension one faces containing it are consecutive. To obtain  $A_n$ , truncate the consecutive faces of  $\Delta^n$ , starting with the vertices, then the edges, and so forth.

**Figure 4.16.** *The third associahedron.*

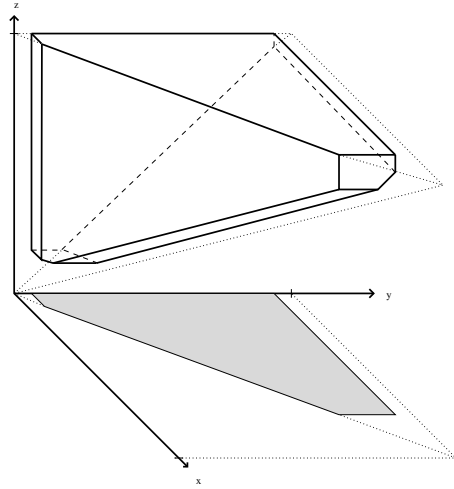

We will use a more conventional definition of the associahedron below. Closely related to the associahedron is the following sub-category of  $\Psi_n$ , whose minimal objects correspond to ways in which one can associate a product of  $n$  factors in a given order.

**Definition 4.17.** Let  $\Psi_n^o$  denote the full sub-category of  $\Psi_n$  whose objects are  $f$ -trees such that the set of leaves over any vertex is consecutive and such that the root vertex has valence greater than one.

Note that any element of  $\Psi_n^o$  has an embedding in the upper half plane with the root at 0, in which the leaves occur in order and which is unique up to isotopy. We may then drop the labels from such an embedding.

In applications to knot theory, we consider manifolds with boundary which have two distinguished points in its boundary, the interval  $\mathbb{I}$  being a fundamental case.

**Definition 4.18.** Given a manifold  $M$  with  $y_0$  and  $y_1$  in  $\partial M$ , let  $C_n[M, \partial]$  be the closure in  $C_{n+2}[M]$  of the subspace of  $C_{n+2}(M)$  of points of the form  $(y_0, x_1, \dots, x_n, y_1) \in (M)^{n+2}$ .

**Theorem 4.19.** *Stasheff's associahedron  $A_n$ ,  $\tilde{C}_{n+2}^o[\mathbb{R}]$  and  $C_n^o[\mathbb{I}, \partial]$  are all diffeomorphic as manifolds with corners. Moreover, their barycentric subdivisions are diffeomorphic to the realization (or order complex) of the poset  $\Psi_n^o$ .*

*Proof.* It is simple to check that  $\tilde{C}_{n+2}^o[\mathbb{R}]$  and  $C_n^o[\mathbb{I}, \partial]$  are diffeomorphic using Lemma 4.12, and the fact that up to translation and scaling, any  $x_0 < x_1 < \dots < x_{n+1} \subset \mathbb{R}$  has  $x_0 = 0$  and  $x_{n+1} = 1$ .

Next, we analyze  $\tilde{C}_{n+2}^o[\mathbb{R}]$  inductively using Corollary 4.13 and Theorem 4.15. First note that because the  $x_i$  are ordered and  $x_0$  can never equal  $x_{n+1}$ , the category of strata of  $\tilde{C}_{n+2}^o[\mathbb{R}]$  is  $\Psi_{n+2}^o$ . For  $n+2=3$ ,  $\tilde{C}_3^o[\mathbb{R}]$  is a one-manifold whose interior is the open interval  $\tilde{C}_3^o(\mathbb{R})$  and which according to  $\Psi_3^o$  has two distinct boundary points, and thus must be an interval. For  $n+2=4$ , the stratification according to  $\Psi_4^o$  and Theorem 4.15 dictate that there are five codimension-one boundary strata each isomorphic to  $\tilde{C}_3^o[\mathbb{R}]$ , which we know inductively to be  $\mathbb{I}$ , and five vertices, each being the boundary of exactly two faces, attached smoothly (with corners) to an open two-disk, making a pentagon.

In general,  $\tilde{C}_{n+2}^o[\mathbb{R}]$  has an open  $n$ -ball for an interior and faces  $\tilde{C}_T^o[\mathbb{R}]$  which inductively we identify as  $(A_{\#v-2})^{v \in V(T)}$  glued according to the poset structure of  $\Psi_{n+2}^o$  to make a boundary sphere, coinciding with a standard definition of  $A_n$  using trees [25].

The last statement of the theorem follows from the general fact that if  $P$  is a polytope each of whose faces (including itself) is homeomorphic to a disk, then the realization of the category of strata of  $P$  is diffeomorphic to its barycentric subdivision.  $\square$

In further work [23] we plan to show that the spaces  $\tilde{C}_n[\mathbb{R}^m]$  form an operad. This construction unifies the associahedra and little disks operads, and was first noticed in [12] and carried out in [18].

To review some of the salient features of the structure of  $C_n[M]$  in general, it is helpful to think explicitly about coordinates on  $C_2^o[I, \partial]$ . On its interior, suitable coordinates are  $0 < x < y < 1$ . Three of the faces are standard, corresponding to those for  $\Delta^2$ . They are naturally labelled  $x=0$ ,  $y=1$  and  $x=y$ , and for example we may use  $y$  as a coordinate on the  $x=0$  face, extending the coordinates on the interior. The final two faces are naturally labelled  $0=x=y$  and  $x=y=1$ . Coordinates on these faces which extend interior coordinates would be  $\frac{x}{y}$  and  $\frac{1-y}{1-x}$ , respectively.

**Figure 4.20.** *The second associahedron, labelled by  $\Psi_4^o$ , with labellings by associativity and coordinates also indicated.*

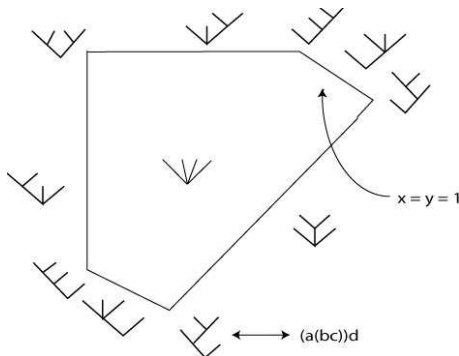

## 5. THE SIMPLICIAL COMPACTIFICATION

To simplify arguments, we assume  $M$  is compact throughout this section. Recall Definition 1.3 of  $C_n\langle[M]\rangle$ , which we call the simplicial compactification. For  $M = \mathbb{I}$ , we see that  $C_n\langle[I]\rangle$  is the closure of  $C_n^o(\mathbb{I})$  in  $\mathbb{I}^n$ , which is simply  $\Delta^n$ . For general manifolds, we will see that  $C_n\langle[M]\rangle$  is in some sense more complicated than  $C_n[M]$ .

Because the projection  $P_A : A_n[M] \rightarrow A_n\langle[M]\rangle$  commutes with the inclusions of  $C_n(M)$ , Lemma 1.5 says that  $P_A$  sends  $C_n[M]$  onto  $C_n\langle[M]\rangle$  when  $M$  is compact.

**Definition 5.1.** Let  $Q_n : C_n[M] \rightarrow C_n\langle[M]\rangle$  be the restriction of  $P_A$ .

The main aim of this section is to understand  $Q_n$  and show that it is a homotopy equivalence. From the analysis of Lemma 3.18 we know that  $(\pi_{ij}) : \tilde{C}_n(\mathbb{R}^m) \rightarrow (S^{m-1})^{n(n-1)}$  is not injective for configurations

in which all points lie on a line. These collinear configurations account for all of the differences between  $C_n[M]$  and  $C_n\langle[M]\rangle$ .

**Lemma 5.2.** *The map  $Q_n$  is one-to-one except at points with some  $x_{i_1} = \cdots = x_{i_m}$  and  $u_{i_h i_j} = \pm u_{i_k i_\ell}$  for any  $h, j, k, \ell$ . The preimages of such points are diffeomorphic to a product of  $A_{m-2}$ 's.*

*Proof.* Conditions 1 and 2 of Theorem 4.1 say that in cases except for these, the coordinates  $d_{ijk}$  in  $C_n[M]$  will be determined by the  $x_i$  or  $u_{ij}$  coordinates. In these cases, the  $d_{ijk}$  are restricted in precisely the same manner as for the definition of  $\tilde{C}_m^o(\mathbb{R})$ , which is diffeomorphic to  $A_{m-2}$  by Theorem 4.19.  $\square$

Thus, the preimage of any point under  $Q_n$  will be contractible, pointing to the fact that  $Q_n$  is a homotopy equivalence. A small difficulty is that under  $Q_n$ , points in the boundary of  $C_T[M]$  will be identified with points in its interior. Moreover, there are identifications made which lie only in the boundary of  $C_T[M]$ . We will first treat configurations in  $\mathbb{R}^m$  up to the action of  $Sim_k$ , the building blocks for the strata of  $C_n[M]$ .

**Definition 5.3.** Let  $\tilde{C}_n\langle[\mathbb{R}^m]\rangle$  be the closure of  $(\tilde{\pi}_{ij})\left(\tilde{C}_n(\mathbb{R}^m)\right)$  in  $\tilde{A}_n\langle[\mathbb{R}^m]\rangle = (S^{m-1})^{C_2(\underline{n})}$ .

The analogue of Lemma 4.12 does not hold in this setting, since as noted before  $(\tilde{\pi}_{ij})$  is not injective for collinear configurations. We will see that  $\tilde{Q}_n : \tilde{C}_n[\mathbb{R}^m] \rightarrow \tilde{C}_n\langle[\mathbb{R}^m]\rangle$  is a homotopy equivalence by exhibiting  $\tilde{Q}_n$  as a pushout by an equivalence. We first state some generalities about fat wedges and pushouts.

**Definition 5.4.** Let  $\{A_i \subseteq X_i\}$  be a collection of subspaces indexed by  $i$  in some finite  $\mathcal{I}$ . Define the fat wedge of  $\{X_i\}$  at  $\{A_i\}$ , denoted  $\boxtimes_{A_i}^{\mathcal{I}} X_i$  or just  $\boxtimes_{A_i} X_i$ , to be the subspace of  $(x_i) \in (X_i)^{\mathcal{I}}$  with at least one  $x_i$  in  $A_i$ .

Suppose for each  $i$  we have a map  $q_i : A_i \rightarrow B_i$  and let  $Y_i$  be defined by the following pushout square:

$$\begin{array}{ccc} A_i & \longrightarrow & X_i \\ q_i \downarrow & & \bar{q}_i \downarrow \\ B_i & \longrightarrow & Y_i. \end{array}$$

There is a map which we call  $\boxtimes q_i$  from  $\boxtimes_{A_i} X_i$  to  $\boxtimes_{B_i} Y_i$ .

**Lemma 5.5.** *With notation as above, if each  $A_i \hookrightarrow X_i$  is a (Hurewicz) cofibration and each  $q_i$  is a homotopy equivalence, then  $\boxtimes q_i$  is a homotopy equivalence.*

*Proof.* First note that in a left proper model category, if you have a diagram

$$\begin{array}{ccccc} B & \longleftarrow & A & \longrightarrow & C \\ \downarrow & & \downarrow & & \downarrow \\ X & \longleftarrow & Y & \longrightarrow & Z, \end{array}$$

where the vertical maps are equivalences and at least one map on each of the horizontal levels is a cofibration, then the induced map of pushouts is an equivalence (see Theorem 13.5.4 in [13]). The Hurewicz model category is left proper because every space is cofibrant (see Theorem 13.1.3 in [13]).

We prove this lemma by induction. Let  $\mathcal{I} = \{1, \dots, n\}$ . Inductively define the diagram  $D_j$  as

$$\begin{array}{ccccc} P_{j-1} \times X_j & \longleftarrow & P_{j-1} \times A_j & \longrightarrow & (X_i)^{i < j} \times A_j \\ \downarrow & & \downarrow & & \downarrow \\ Q_{j-1} \times Y_j & \longleftarrow & Q_{j-1} \times B_j & \longrightarrow & (Y_i)^{i < j} \times B_j, \end{array}$$

where  $P_{j-1}$  is the pushout of the top row of  $D_{j-1}$  and  $Q_{j-1}$  is the pushout of its bottom row. Thus,  $P_n = \boxtimes_{A_i} X_i$  and  $Q_n = \boxtimes_{B_i} Y_i$ . The vertical maps of  $D_j$  are homotopy equivalences by induction, which is immediate if  $n = 1$ . The left most horizontal maps are cofibrations because the product of a Hurewicz cofibration with the identity map is a Hurewicz cofibration (see Corollary 1 in [14]). We apply the pushout result above to get that  $P_n \rightarrow Q_n$  is an equivalence.  $\square$

For analysis of  $\tilde{Q}_n$ , recall that for  $k = 1$ ,  $\tilde{\pi}_{ij}$  sends  $\tilde{C}_n[\mathbb{R}]$  to  $S^0 = \pm 1$ .

**Definition 5.6.** (1) Let  $\lambda_m$  be the image of the map from  $(S^{m-1}) \times \tilde{C}_m[\mathbb{R}] \rightarrow \tilde{C}_m[\mathbb{R}^m]$  which sends  $v, x$  to  $(\pi_{ij}(x) \cdot v) \times (s_{ijk}(x)) \in \tilde{A}_m[\mathbb{R}^m]$ . We call  $\lambda_m$  the subspace of collinear points in  $\tilde{C}_m[\mathbb{R}^m]$ .  
(2) Let  $q_m$  denote the projection of  $(S^{m-1}) \times \tilde{C}_m[\mathbb{R}]$  onto  $S^{m-1} \times \Sigma_m$  by sending each component of  $\tilde{C}_m[\mathbb{R}]$  to a point. Let  $R_m$  be defined as the pushout

$$(2) \quad \begin{array}{ccc} (S^{m-1}) \times \tilde{C}_m[\mathbb{R}] & \xrightarrow{\lambda_m} & \tilde{C}_m[\mathbb{R}^m] \\ q_m \downarrow & & \downarrow \\ S^{m-1} \times \Sigma_m & \longrightarrow & R_m. \end{array}$$

Note that  $R_m$  maps to  $\tilde{C}_m\langle[\mathbb{R}^m]\rangle$ , factoring  $\tilde{Q}_n$ . We will see that this map is a homeomorphism on the image of  $\tilde{C}_m(\mathbb{R}^m)$  in  $R_m$ , but not on its boundary strata.

**Definition 5.7.** (1) By the analogue of Theorem 4.15,  $\tilde{C}_T[\mathbb{R}^m]$  is diffeomorphic to  $(\widetilde{C_{\#v}}[\mathbb{R}^m])^{V(T)}$ .  
Let  $\lambda_T \subset C_T[\mathbb{R}^m]$  be the fat wedge  $\boxtimes_{\lambda_{\#v}} \widetilde{C_{\#v}}[\mathbb{R}^m]$ .  
(2) Let  $L_T$  denote the fat wedge  $\boxtimes_{S^{m-1} \times \Sigma_{\#v}} R_{\#v}$  and let  $q_T = \boxtimes q_{\#v} : \lambda_T \rightarrow L_T$ .  
(3) Let  $\bigcup_T \lambda_T$  denote the union of the  $\lambda_T$  in  $\tilde{C}_n[\mathbb{R}^m]$ . Let  $\bigcup_T L_T$  denote the union of  $L_T$  with identifications  $q_T(x) \sim q_{T'}(y)$  if  $x \in \lambda_T$  is equal to  $y \in \lambda_{T'}$ . Let  $\bigcup_T q_T : \bigcup_T \lambda_T \rightarrow \bigcup_T L_T$  denote the projection defined compatibly by the  $q_T$ .

**Theorem 5.8.** *The projection map  $\tilde{Q}_n : \tilde{C}_n[\mathbb{R}^m] \rightarrow \tilde{C}_n\langle[\mathbb{R}^m]\rangle$  sits in a pushout square*

$$(3) \quad \begin{array}{ccc} \bigcup_T \lambda_T & \longrightarrow & \tilde{C}_n[\mathbb{R}^m] \\ \bigcup_T q_T \downarrow & & \downarrow Q_n \\ \bigcup_T L_T & \longrightarrow & \tilde{C}_n\langle[\mathbb{R}^m]\rangle. \end{array}$$

Before proving this theorem we deduce from it one of the main results of this section.

**Corollary 5.9.**  *$\tilde{Q}_n$  is a homotopy equivalence.*

*Proof.* If we apply Lemma 5.5 to the pushout squares of Equation 2 which define the  $R_{\#v}$ , we deduce that  $q_T$  is a homotopy equivalence. Because the identifications in  $\bigcup_T L_T$  are essentially defined through  $\bigcup_T q_T$ , we deduce that  $\bigcup_T q_T$  is a homotopy equivalence. Because the inclusion  $\bigcup_T \lambda_T \rightarrow \tilde{C}_n[\mathbb{R}^m]$  is a cofibration, we see that  $\tilde{Q}_n$  is a pushout of a homotopy equivalence through a cofibration, and thus is a homotopy equivalence itself.  $\square$

*Proof of Theorem 5.8.* Let  $X$  denote the pushout of the first three spaces in the square of Equation 3. First note that the composite  $\tilde{Q}_n \circ (\bigcup_T q_T)^{-1} : \bigcup_T L_T \rightarrow \tilde{C}_n\langle[\mathbb{R}^m]\rangle$  is well defined, since choices of  $(\bigcup_T q_T)^{-1}$  only differ in their  $d_{ijk}$  coordinates. By the definition of pushout,  $X$  maps to  $\tilde{C}_n\langle[\mathbb{R}^m]\rangle$  compatibly with  $\tilde{Q}_n$ . We show that this map  $F$  is a homeomorphism.

First,  $F$  is onto because  $\tilde{Q}_n$  is onto. The key is that by construction  $F$  is one-to-one. Away from  $\bigcup_T \lambda_T$ ,  $\tilde{Q}_n$  is one-to-one essentially by Lemma 5.2. The projection  $\tilde{Q}_n$  is not one-to-one only on  $x \in \tilde{C}_m[\mathbb{R}^m]$  with some collections of  $\{i_j\}$  such that  $u_{i_h i_j} = \pm u_{i_\ell i_m}$ . But such an  $x$  is in  $\lambda_T(x)$ . The map  $\tilde{Q}_n \circ (\bigcup_T q_T)^{-1}$  is one-to-one since distinct points in  $\bigcup_T L_T$  will have distinct  $u_{ij}$  coordinates when lifted to  $\bigcup_T \lambda_T$  which remain distinct in  $\tilde{C}_n\langle[\mathbb{R}^m]\rangle$ .

Finally since it is a pushout of compact spaces,  $X$  is compact. All spaces in question are subspaces of metric spaces. Thus, since  $F$  is a one-to-one map between metrizable spaces whose domain is compact, it is a homeomorphism onto its image, which is all of  $\tilde{C}_n\langle[\mathbb{R}^m]\rangle$ .  $\square$

**Theorem 5.10.** *The map  $Q_n: C_n[M] \rightarrow C_n\langle[M]\rangle$  is a homotopy equivalence.*

*Proof.* On the interior  $C_n(M)$ ,  $Q_n$  is a homeomorphism.

The effect of  $Q_n$  on  $C_T[M]$  for non-trivial  $T$  is through restriction to  $P_{\#v_0}$  on the base  $C_{\#v_0}[M]$ . Working fiberwise, we see that  $Q_n$  takes each fiber bundle  $\tilde{C}_i[\mathbb{R}^m] \rightarrow IC_i[M] \rightarrow M$  and pushes out fiberwise to get  $\tilde{C}_i\langle[\mathbb{R}^m]\rangle \rightarrow IC_i\langle[M]\rangle \rightarrow M$ . As  $\#v_0 < n$ , by induction and Theorem 5.8,  $Q_n$  restricted to any  $C_T[M]$  is a homotopy equivalence. Since the inclusions of  $C_T[M]$  in each other are cofibrations, we can build a homotopy inverse inductively and deduce that  $Q_n$  is a homotopy equivalence.  $\square$

We also identify  $C_n\langle[M]\rangle$  as a subspace of  $A_n\langle[M]\rangle$  for purposes of defining maps. One approach to this identification would be to use surjectivity of  $Q_n$  and Theorem 4.1, but there are relationships between the  $u_{ij}$  coordinates of points in  $C_n[M]$  implied by their relationships in turn with the  $d_{ijk}$  coordinates. It is simpler to do this coordinate analysis of  $C_n\langle[M]\rangle$  more directly, starting with  $\tilde{C}_n\langle[\mathbb{R}^m]\rangle$ .

- Definition 5.11.**
- (1) A point  $(u_{ij}) \in \tilde{A}_n\langle[\mathbb{R}^m]\rangle$  is anti-symmetric if  $u_{ij} = -u_{ji}$ .
  - (2) A circuit, or  $k$ -circuit, in  $S$  is a collection  $\{i_1 i_2, i_2 i_3, \dots, i_{k-1} i_k\}$  of elements of  $\binom{S}{2}$  for some indexing set  $S$ . Such indices label a path in the complete graph on  $S$ . A circuit is a loop, or  $k$ -loop, if  $i_k = i_1$ . A circuit is straight if it does not contain any loops. The reversal of a circuit is the circuit  $i_k i_{k-1}, \dots, i_2 i_1$ .
  - (3) A point  $(u_{ij}) \in \tilde{A}_n\langle[\mathbb{R}^m]\rangle$  is three-dependent if for 3-loop  $L$  in  $\underline{n}$  we have  $\{u_{ij}\}_{ij \in L}$  is non-negatively dependent.
  - (4) If  $S$  has four elements and is ordered we may associate to a straight 3-circuit  $C = \{ij, jk, k\ell\}$  a permutation of  $S$  denoted  $\sigma(C)$  which orders  $(i, j, k, \ell)$ . A complementary 3-circuit  $C^*$  is a circuit, unique up to reversal, which is comprised of the three pairs of indices not in  $C$ .
  - (5) A point in  $\tilde{A}_n\langle[\mathbb{R}^m]\rangle$  is four-consistent if for any  $S \subset \underline{n}$  of cardinality four and any  $v, w \in S^{m-1}$  we have that

$$(4) \quad \sum_{C \in \mathcal{C}^3(S)} (-1)^{|\sigma(C)|} \left( \prod_{ij \in C} u_{ij} \cdot v \right) \left( \prod_{ij \in C^*} u_{ij} \cdot w \right) = 0,$$

where  $\mathcal{C}^3 S$  is the set of straight 3-circuits modulo reversal and  $|\sigma(C)|$  is the sign of  $\sigma(C)$ .

One may view anti-symmetry as a dependence condition for two-loops of indices.

**Lemma 5.12.** *The image of  $(\tilde{\pi}_{ij})$  is anti-symmetric, three-dependent and four-consistent.*

*Proof.* Let  $(x_i)$  be a coset representative in  $\tilde{C}_n(\mathbb{R}^m)$  and  $u_{ij} = \pi_{ij}((x_i))$ . Three-dependence is immediate as  $(x_i - x_j) + (x_j - x_k) + (x_k - x_i) = 0$ , so  $\|x_i - x_j\|u_{ij} + \|x_j - x_k\|u_{jk} + \|x_k - x_i\|u_{ki} = 0$ .

Four-consistency is more involved. We start in the plane, and we work projectively letting  $a$  be the slope of  $u_{12}$ ,  $b$  of  $u_{34}$ ,  $c$  of  $u_{13}$ ,  $d$  of  $u_{24}$ ,  $e$  of  $u_{14}$  and  $f$  of  $u_{23}$ . If  $a = \infty$  and  $b = 0$ , so up to translation we arrange for  $x_1$  and  $x_2$  on the  $y$ -axis and  $x_3$  and  $x_4$  on the  $x$ -axis, we observe that  $cd = ef$ . To lift our assumptions on  $a$  and  $b$ , we use the fact that any linear fractional transformation of slopes is induced by a

linear transformation of the  $(x_i)$ , and thus preserves the slopes which come from some  $(x_i)$ . We apply the transformation  $t \mapsto \frac{t-b}{t-a}$ , which sends  $a$  to  $\infty$ ,  $b$  to 0, and the equation  $cd - ef = 0$  to the equation

$$(c-b)(d-b)(e-a)(f-a) - (c-a)(d-a)(e-b)(f-b) = 0.$$

The resulting quartic is divisible by  $(a-b)$ . Carrying out the division we get the more symmetric cubic

$$ab(-c-d+e+g) + (a+b)(cd-ef) + [ef(c+d) - cd(e+f)] = 0.$$

Now recalling that for example  $a = \frac{u_{12} \cdot e_2}{u_{12} \cdot e_1}$  where  $\{e_1, e_2\}$  is the standard basis of the plane, we clear denominators and find that we have precisely Equation 4, in the case of the plane where  $v = e_2$  and  $w = e_1$ . To deduce the case of general  $v$  and  $w$  in the plane, we simply change to the  $v, w$  basis when  $v$  and  $w$  are independent. The case of dependent  $v$  and  $w$  follows by continuity. Finally, we invoke the fact that the dot product of  $u_{ij}$  with  $v$  is the same as that of the projection of  $u_{ij}$  onto the plane spanned by  $v$  and  $w$  to deduce the general case from the planar case.  $\square$

**Lemma 5.13.** *If  $(u_{ij}) \in \tilde{A}_4\langle[\mathbb{R}^m]\rangle$  is four-consistent, then any five of the  $u_{ij}$  determines the sixth.*

*Proof.* The four-consistency condition, Equation 4, is multilinear in each variable, and the terms are all nonzero for  $v, w$  in the complement of the hyperplanes orthogonal to the  $\{u_{ij}\}$ . Thus for generic  $v$  and  $w$  one is able to determine the ratio  $\frac{u_{kl} \cdot v}{u_{kl} \cdot w}$  from knowing all other  $u_{ij}$ . A unit vector is determined by such ratios, in fact needing only the ratios between pairs of vectors in some basis.  $\square$

*Remark.* If  $u_{ik}$ ,  $u_{i\ell}$  and  $u_{jk}$  are independent, then the four-consistency condition follows from three-dependency, as  $u_{k\ell}$  must be the intersection of the plane through the origin,  $u_{ik}$  and  $u_{i\ell}$ , and the plane through the origin,  $u_{jk}$  and  $u_{j\ell}$ .

**Theorem 5.14.**  *$\tilde{C}_n\langle[\mathbb{R}^m]\rangle$  is the subspace of anti-symmetric, three-dependent, four-consistent points in  $\tilde{A}_n\langle[\mathbb{R}^m]\rangle$ .*

*Proof.* Let  $DC$  be the subspace of  $\tilde{A}_n\langle[\mathbb{R}^m]\rangle$  of anti-symmetric three-dependent, four-consistent points. We proved in Lemma 5.12 points in the image of  $(\pi_{ij})$  are in  $DC$ . Moreover,  $DC$  is closed, since anti-symmetry, dependence of vectors and four-consistency are closed conditions. We establish the theorem by constructing points in the image of  $(\pi_{ij})$  arbitrarily close to any point in  $DC$ , in a manner reminiscent of the maps  $\nu^T$ .

To a point  $u = (u_{ij}) \in \tilde{C}_n\langle[\mathbb{R}^m]\rangle$  we associate an exclusion relation and thus using Definition 2.10 an  $f$ -tree  $T(u) \in \tilde{\Psi}_n$ , by saying that  $i$  and  $j$  exclude  $k$  if  $u_{ik} = u_{jk} \neq \pm u_{ij}$ . It is immediate that this satisfies the first axiom of an exclusion relation. To check the second axiom, namely transitivity, we also assume that  $j$  and  $k$  exclude  $\ell$  so that  $u_{j\ell} = u_{k\ell} \neq \pm u_{jk}$ . We use four-consistency with  $v$  chosen to be orthogonal to  $u_{ik}$  but not  $u_{ij}$  or  $u_{j\ell}$  (we may assume that we are not in  $\mathbb{R}^1$ , for in that case the exclusion relation would be empty automatically) and  $w$  orthogonal to  $u_{j\ell}$  but not  $u_{jk}$ . All but one of the twelve terms of Equation 4 are automatically zero, with the remaining term being

$$(u_{ij} \cdot v)(u_{j\ell} \cdot v)(u_{\ell k} \cdot v)(u_{jk} \cdot w)(u_{ki} \cdot w)(u_{i\ell} \cdot w).$$

All of these factors are non zero by construction except for  $u_{i\ell} \cdot w$ . We deduce that  $u_{i\ell}$  is orthogonal to all vectors  $w$  which are orthogonal to  $u_{j\ell}$ , which we recall is not orthogonal to  $u_{ij}$  so that  $u_{i\ell} = \pm u_{j\ell} \neq \pm u_{ij}$ . By the non-negativity of coefficients in our three-dependence condition we in fact have  $u_{i\ell} = u_{j\ell}$  so that  $i$  and  $j$  exclude  $\ell$ , as needed.

We next show that if there are no exclusions regarding indices, we can construct a non-continuous inverse  $\rho_n$  to  $(\pi_{ij})$ . If there are no exclusions, then either:

- (1) for any subset of indices  $S$  there is a  $k$  such that  $u_{ik} \neq u_{jk}$  for some  $i, j \in S$ ,
- (2) or, inductively, all of the  $u_{ij}$  are equal up to a sign.

In case (2) let  $v = u_{12}$  and define a total ordering on  $\underline{n}$  by  $i < j$  if  $u_{ij} = v$ . Define  $(x_i) = \rho_n(u_{ij})$  by setting  $x_i = s_i v$ , where  $s_i > s_j$  when  $i > j$ ,  $\sum s_i = 0$  and  $\max\{|s_i|\} = 1$ , noting that there is not a unique choice of  $s_i$ 's. In case (1), we begin by setting  $x_1 = 0$  and  $x_2 = u_{12}$ . Once  $\{x_i\}$  for  $i \in S$  has been determined, choose  $k$  as in (1). Let  $R_{ik}$  be the positive ray through  $x_i$  in the direction of  $u_{ik}$ . Define  $x_k$  as the intersection of  $R_{ik}$  with  $R_{jk}$ , with  $i$  and  $j$  as in (1). These rays intersect for they are coplanar by three-dependence. They are not parallel because  $u_{ik} \neq \pm u_{jk}$ , and the intersection of the two lines containing them lies in each ray because the dependence of  $u_{ij}$ ,  $u_{jk}$  and  $u_{ki}$  is through positive coefficients.

To show that this definition of  $x_k$  is independent of which  $i$  and  $j$  are chosen, we show that we may replace  $j$  by some  $\ell$ . Letting  $S = \{i, j, k, \ell\}$ , we observe that both the image of these  $(x_r)_{r \in S}$  under  $(\pi_{pq})_{p, q \in S}$  and our given  $(u_{pq})_{p, q \in S}$  are four-consistent, by Lemma 5.12 and by assumption respectively. By construction,  $\pi_{pq}((x_r)_{r \in S}) = u_{pq}$  in all cases except perhaps when  $p = k$ ,  $q = \ell$ . But Lemma 5.13, implies this equality in this last case. Thus  $x_k = R_{ik} \cap R_{jk}$  is on the ray  $R_{\ell k}$ , which in turn implies that  $x_k$  is also  $R_{ik} \cap R_{\ell k}$ .

In this way we construct  $x_i$  for all  $i \in \underline{n}$ . By scaling and translating, we choose the coset representative for  $\rho_n((u_{ij}))$  to be the  $(x_i)$  whose center of mass is the origin and such that  $\max\{\|x_i\|\} = 1$ .

Finally, we use these  $\rho_i$  to construct a configuration in  $C_n(\mathbb{R}^m)$  which maps arbitrarily close to any given  $u = (u_{ij}) \in DC$ . For every vertex  $v \in T(u)$  we choose one leaf lying over each edge of  $v$  and let  $S_v$  be the set of their indices. There are no exclusions among the indices in  $S_v$ , so we let  $(x_e)_{e \in E(v)} = \rho_{\#S_v}((u_{ij})_{i, j \in S_v})$ . Given an  $\varepsilon < 1$  let  $x_i(\varepsilon) = \sum_{e \in R} \varepsilon^{h(e)} x_e$ , where  $R$  is the root path of the  $i$ th leaf,  $e$  is an edge in that root path, and  $h(e)$  is the number of edges in  $R$  between  $e$  and the root vertex. By construction, independent of all of the choices made, the image of  $(x_i(\varepsilon))$  under  $(\pi_{ij})$  approaches  $(u_{ij})$  as  $\varepsilon$  tends to zero.  $\square$

**Corollary 5.15.**  *$C_n\langle[M]\rangle$  is the subspace of  $(x_i) \times (u_{ij}) \in A_n\langle[M]\rangle$  such that*

- (1) *if  $x_i \neq x_k$  then  $u_{ij} = \frac{x_i - x_k}{\|x_i - x_k\|}$ ;*
- (2) *the  $(u_{ij})$  are anti-symmetric, three dependent and four-consistent;*
- (3) *If  $x_i = x_j$ , then  $u_{ij}$  is tangent to  $M$  at  $x_i$ .*

We may decompose  $\tilde{C}_n\langle[M]\rangle$  through our construction of associated trees  $T(u)$ . These strata are manifolds, but  $C_n\langle[M]\rangle$  is not a manifold with corners. The singularity which arises is akin to that which occurs when a diameter of a disk gets identified to a point. We will not pursue the matter further here.

## 6. DIAGONAL AND PROJECTION MAPS

As we have seen, the compactifications  $C_n[M]$  and  $C_n\langle[M]\rangle$  are functorial with respect to embeddings of  $M$ . In this section we deal with projection and diagonal maps, leading to functoriality with respect to  $n$ , viewed as the set  $\underline{n}$ .

Our goal is to construct maps for  $C_{\#S}[M]$  and  $C_{\#S}\langle[M]\rangle$  which lift the canonical maps on  $M^S$ . We start with the straightforward case of projection maps. If  $\sigma : \underline{m} \rightarrow \underline{n}$  is an inclusion of sets, recall Definition 3.25 that  $p_\sigma^M$  is the projection onto coordinates in the image of  $\sigma$ .

**Proposition 6.1.** *Let  $\sigma : \underline{m} \rightarrow \underline{n}$  be an inclusion of finite sets. There are projections  $C_\sigma$  from  $C_n[M]$  onto  $C_m[M]$  and from  $C_n\langle[M]\rangle$  onto  $C_m\langle[M]\rangle$  which are consistent with each other, with  $p_\sigma^M$ , and its restriction to  $C_n(M)$ .*

*Proof.* The inclusion  $\sigma$  gives rise to maps from  $C_i(\sigma) : C_i(\underline{m}) \rightarrow C_i(\underline{n})$ . We project  $A_n[M]$  onto  $A_m[M]$  through  $P_\sigma = p_\sigma^M \times p_{C_2(\sigma)}^{S^{m-1}} \times p_{C_3\sigma}^{\mathbb{I}}$ .

Because  $P \circ \alpha_n = \alpha_m$  and all spaces in question are compact, we apply Lemma 1.5 to see that  $P_\sigma$  sends  $C_n[M]$  onto  $C_m[M]$ , extending the projection from  $C_n(M)$  to  $C_m(M)$ . By construction,  $P_\sigma$  commutes with  $p_\sigma^M$ , which is its first factor.

The projection for  $C_n\langle[M]\rangle$  is entirely analogous, defined as the restriction of the map  $P'_\sigma = p_\sigma^M \times p_{C_2(\sigma)}^{S^{m-1}} : A_n\langle[M]\rangle \rightarrow A_m\langle[M]\rangle$ . We leave the routine verification that  $P'$  commutes with all maps in the statement of the theorem to the reader.  $\square$

An inclusion  $\sigma : \underline{m} \rightarrow \underline{n}$  gives rise to a functor  $Ex_\sigma : Ex(\underline{n}) \rightarrow Ex(\underline{m})$  by throwing out any exclusions involving indices not in the image of  $\sigma$ . The corresponding ‘‘pruning’’ functor for trees,  $\Psi_\sigma : \Psi_{\underline{n}} \rightarrow \Psi_{\underline{m}}$ , is defined by removing leaf vertices and edges whose label is not in the image of  $\sigma$ , replacing any non-root bivalent vertex along with its two edges with a single edge, and removing any vertices and edges which have all of the leaves above them removed.

**Proposition 6.2.**  $C_\sigma$  sends  $C_T[M]$  to  $C_{\Psi_\sigma(T)}[M]$ .

*Proof.* The effect of  $C_\sigma$  is to omit indices not in the image of  $\sigma$ , so its effect on exclusion relations is precisely  $Ex_\sigma$ . There is a univalent root vertex for the tree associated to  $C_\sigma(C_T[M])$  if and only if all indices  $j$  for which  $x_j \neq x_i$  have been omitted, which happens precisely when all leaves in  $T$  except for those over a single root edge have been pruned.  $\square$

If  $\sigma : \underline{m} \rightarrow \underline{n}$  is not injective, it is more problematic to construct a corresponding map  $C_n[M] \rightarrow C_m[M]$ . Indeed,  $p_\sigma : M^{\underline{n}} \rightarrow M^{\underline{m}}$  will not send  $C_n(M)$  to  $C_m(M)$ , since the image of  $p_\sigma$  will be some diagonal subspace of  $M^{\underline{m}}$  and the diagonal subspaces are precisely what are removed in defining  $C_n(M)$ . One can attempt to define diagonal maps by ‘‘doubling’’ points, that is adding a point to a configuration which is very close to one of the points in the configuration, but such constructions are non-canonical and will never satisfy the identities which diagonal maps and projections together usually do. But, the doubling idea carries through remarkably well for compactified configuration spaces where one can ‘‘double infinitesimally’’. From the viewpoint of applications in algebraic topology, where projection and diagonal maps are used frequently, the diagonal maps for compactifications of configuration spaces should be of great utility.

Reflecting on the idea of doubling a point in a configuration, we see that doing so entails choosing a direction, or a unit tangent vector, at that point. Thus we first incorporate tangent vectors in our constructions. Recall that we use  $STM$  to denote the unit tangent bundle (that is, the sphere bundle to the tangent bundle) of  $M$ .

**Definition 6.3.** If  $X_n(M)$  is a space with a canonical map to  $M^{\underline{n}}$ , define  $X'_n(M)$  as a pull-back as follows:

$$\begin{array}{ccc} X'_n(M) & \longrightarrow & (STM)^{\underline{n}} \\ \downarrow & & \downarrow \\ X_n(M) & \longrightarrow & M^{\underline{n}}. \end{array}$$

If  $f_n : X_n(M) \rightarrow Y_n(M)$  is a map over  $M^{\underline{n}}$ , let  $f'_n : X'_n(M) \rightarrow Y'_n(M)$  be the induced map on pull-backs.

**Lemma 6.4.**  $C'_n[M]$  is the closure of the image of  $\alpha'_n : C'_n(M) \rightarrow A'_n[M]$ . Similarly,  $C'_n\langle[M]\rangle$  is the closure of the image of  $\beta'_n$ .

*Proof.* We check that  $cl_{A'_n[M]}(\alpha'_n(C'_n(M)))$  satisfies the definition of  $C'_n[M]$  as a pull-back by applying Lemma 1.5 with  $\pi$  being the projection from  $A'_n[M]$  to  $A_n[M]$  and  $A$  being the subspace  $\alpha_n(C'_n(M))$ . The proof for  $C'_n\langle[M]\rangle$  proceeds similarly.  $\square$

We may now treat both diagonal and projection maps for  $C'_n\langle[M]\rangle$ . Starting with  $M = \mathbb{R}^m$ , note that  $A'_n\langle[\mathbb{R}^m]\rangle = (\mathbb{R}^m \times S^{m-1})^{\underline{n}} \times (S^{m-1})^{C_2(\underline{n})}$ , which is canonically diffeomorphic to  $(\mathbb{R}^m)^{\underline{n}} \times (S^{m-1})^{\underline{n}^2}$ , as we let  $u_{ii}$  be the unit tangent vector associated to the  $i$ th factor of  $\mathbb{R}^m$ .

**Definition 6.5.** Using the product decomposition above and considering  $M$  as a submanifold of  $\mathbb{R}^m$ , define  $A_\sigma : A'_n\langle[\mathbb{R}^m]\rangle \rightarrow A'_m\langle[\mathbb{R}^m]\rangle$  as  $p_\sigma^{\mathbb{R}^m} \times p_{\sigma_2}^{S^{m-1}}$  and let  $F_\sigma$  be the restriction of  $A_\sigma$  to  $C_n\langle[M]\rangle$ .



**Proposition 6.6.** *Given  $\sigma : \underline{m} \rightarrow \underline{n}$  the induced map  $F_\sigma$  sends  $C'_n \langle [M] \rangle$  to  $C'_m \langle [M] \rangle$  and commutes with  $p_\sigma^{STM}$ .*

*Proof.* To see that the image of  $F_\sigma$  lies in  $C'_m \langle [M] \rangle$ , it suffices to perform the routine check that its projection to  $A_m \langle [M] \rangle$  satisfies the conditions of Theorem 5.14 using the fact that the domain of  $F_\sigma$ , namely  $C'_n \langle [M] \rangle$ , satisfies similar conditions. Let  $(x_i) \times (u_{ij})$  be  $F_\sigma((y_\ell) \times (v_{\ell m}))$  so that  $x_i = y_{\sigma(i)}$  and  $u_{ij} = v_{\sigma(i)\sigma(j)}$ .

Looking at the first condition of Theorem 5.14,  $x_i \neq x_j$  means  $y_{\sigma(i)} \neq y_{\sigma(j)}$ . By Theorem 5.14 applied to  $C'_n \langle [M] \rangle$  we have that  $v_{\sigma(i)\sigma(j)}$  is the unit vector from  $y_{\sigma(i)}$  to  $y_{\sigma(j)}$ , which implies the corresponding fact for  $u_{ij}$ . Similarly, that the  $(u_{ij})$  are anti-symmetric, three-dependent and four-consistent follows mostly from the corresponding statements for the  $(v_{\ell m})$ . Cases which do not follow immediately in this way, such as three-dependence when the indices  $i, j$  and  $k$  are not distinct, are degenerate and thus straightforward to verify, as for example in this case two of these vectors will be equal up to sign. We leave such verification to the reader.  $\square$

Let  $\mathcal{N}$  denote the full subcategory of the category of sets generated by the  $\underline{n}$ .

**Corollary 6.7.** *Sending  $\underline{n}$  to  $C'_n \langle [M] \rangle$  and  $\sigma$  to  $F_\sigma$  defines a contravariant functor from  $\mathcal{N}$  to spaces.*

*Proof.* We check that  $F_{\sigma \circ \tau} = F_\sigma \circ F_\tau$ . This follows from checking the analogous facts for  $p_\sigma$  and  $p_{\sigma^2}$ , which are immediate.  $\square$

Let  $[n] = \{0, \dots, n\}$ , an ordered set given the standard ordering of integers. Recall the category  $\Delta$ , which has one object for each nonnegative  $n$  and whose morphisms are the non-decreasing ordered set morphisms between the  $[n]$ . A functor from  $\Delta$  to spaces is called a cosimplicial space. There is a canonical cosimplicial space often denoted  $\Delta^\bullet$  whose  $n$ th object is  $\Delta^n$ . To be definite we coordinatize  $\Delta^n$  by  $0 = t_0 \leq t_1 \leq \dots \leq t_n \leq t_{n+1} = 1$ , and label its vertices by elements of  $[n]$  according to the number of  $t_i$  equal to one. The structure maps for this standard object are the linear maps extending the maps of vertices as sets. On coordinates, the linear map corresponding to some  $\sigma : [n] \rightarrow [m]$  sends  $(t_i) \in \Delta^n$  to  $(t_{\sigma^*(j)}) \in \Delta^m$  where  $n - \sigma^*(j)$  is the number of  $i \in [n]$  such that  $\sigma(i) < m - j$ .

The following corollary gives us another reason to refer to  $C_n \langle [M] \rangle$  as the simplicial compactification of  $C_n(M)$ . For applications we are interested in a manifold  $M$  equipped with one inward-pointing tangent vector  $v_0$  and one outward-pointing unit tangent vector  $v_1$  on its boundary. Let  $C'_n \langle [M, \partial] \rangle$  denote the subspace of  $C'_{n+2} \langle [M, \partial] \rangle$  whose first projection onto  $STM$  is  $v_0$  and whose  $n + 2$ nd projection is  $v_1$ . Let  $\phi : \Delta \rightarrow \mathcal{N}$  be the functor which sends  $[n]$  to  $\underline{n+1}$  and relabels the morphism accordingly.

**Corollary 6.8.** *The functor which sends  $[n]$  to  $C'_n \langle [M, \partial] \rangle$  and  $\sigma : [n] \rightarrow [m]$  to the restriction of  $p_\tau$  to  $C'_n \langle [M, \partial] \rangle$  where  $\tau : [m+1] \rightarrow [n+1]$  is the composite  $\phi \circ \sigma^* \circ \phi^{-1}$  defines a cosimplicial space.*

This cosimplicial space models the space of knots in  $M$  [24].

For  $C'_n[M]$ , projection maps still work as in Proposition 6.1, but diagonal maps are less canonical and more involved to describe. We restrict to a special class of diagonal maps for simplicity.

**Definition 6.9.** Let  $\sigma_i : \underline{n+k} \rightarrow \underline{n}$  be defined by letting  $K_i = \{i, i+1, \dots, i+k\}$  and setting

$$\sigma_i(j) = \begin{cases} j & j < K_i \\ i & j \in K_i \\ j - k & j > K_i. \end{cases}$$

We must take products with associahedra in order to account for all possible diagonal maps.

**Definition 6.10.** (1) Define  $\iota_i : I^{C_3(\underline{n})} \times A_{k-1} \rightarrow I^{C_3(\underline{n+k})}$  by recalling that  $A_{k-1} \cong \widetilde{C_{k+1}(\mathbb{R})} \subset I^{C_3(\underline{k})}$  and sending  $(d_{j\ell m})^{C_3(\underline{n})} \times (e_{j\ell m})^{C_3(\underline{k})}$  to  $(f_{j\ell m})^{C_3(\underline{n+k})}$  with

$$f_{j\ell m} = \begin{cases} d_{\sigma_i(j,\ell,m)} & \text{if at most one of } j, \ell, m \in K_i \\ 0 & \text{if } j, \ell \in K_i \text{ but } m \notin K_i \\ 1 & \text{if } \ell, m \in K_i \text{ but } j \notin K_i \\ \infty & \text{if } j, m \in K_i \text{ but } \ell \notin K_i \\ e_{j-i,\ell-i,m-i} & \text{if } j, \ell, m \in K_i. \end{cases}$$

(2) Let  $D_{i,k} : A'_n[M] \times A_{k-1} \rightarrow A'_{n+k}[M]$  be the product of  $A_{\sigma_i} : A'_n\langle[M]\rangle \rightarrow A'_{n+k}\langle[M]\rangle$  with  $\iota_i$ . Let  $\delta_k^i$  denote the restriction of  $D_i$  to  $C'_n[M] \times A_{k-1}$ .

**Proposition 6.11.**  $\delta_k^i$  sends  $C'_n[M] \times A_{k-1}$  to  $C'_{n+k}[M] \subset A'_{n+k}[M]$ .

As with Proposition 6.6, the proof is a straightforward checking that the image of  $\delta_k^i$  satisfies the conditions of Theorem 4.1. One uses the fact that  $C'_n[M]$  satisfies those conditions, along with the definition of  $\iota_i$ . We leave a closer analysis to the reader.

By analysis of the exclusion relation, we see that the image of  $\delta_k^i$  lies in  $C'_S[M]$  where  $S$  is the tree with  $n+k$  leaves, where leaves with labels in  $K_i$  sit over the lone one internal vertex, which is initial for the  $i$ th root edge. In general,  $\delta_k^i$  sends  $C'_T[M]$  to  $C'_{T'}[M]$ , where  $T'$  is obtained from  $T$  by adding  $k+1$  leaves to  $T$ , each of which has the  $i$ th leaf as its initial vertex.

We set  $\delta^i = \delta_1^i : C'_n[M] \rightarrow C'_{n+1}[M]$ , and note that these act as diagonal maps. One can check that composing this with the projection down back to  $C'_n[M]$  is the identity. Unfortunately,  $\delta^i \delta^i \neq \delta^{i+1} \delta^i$  – see Figure 6.12 – so that the  $C'_n[M]$  do not form a cosimplicial space. But note that our  $\delta^2$ , when we restrict  $A_1$  to its boundary, restricts to these two maps and thus provides a canonical homotopy between them. In fact Proposition 6.11 could be used to make an  $A_\infty$  cosimplicial space, but it is simpler to use the  $C'_n\langle[M]\rangle$  if possible.

**Figure 6.12.** An illustration that  $\delta^2 \delta^2 \neq \delta^3 \delta^2$ .

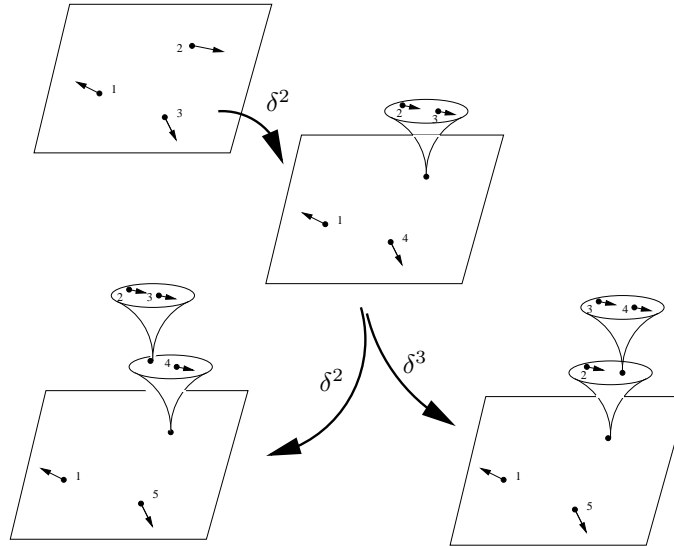

## REFERENCES

- [1] S. Axelrod and I. Singer, Chern-Simons perturbation theory, II. *Jour. Diff. Geom.* **39** (1994), no. 1, 173–213.

- [2] D/ Bar-Natan, S. Garoufalidis, L. Rozansky, and D. Thurston. The Aarhus integral of rational homology 3-spheres I. *Selecta Math. (N.S.)* **8** (2002), no. 3, 315–339.
- [3] R. Bott and C. Taubes, On the self-linking of knots. Topology and physics. *J. Math. Phys.* **35** (1994), no. 10, 5247–5287.
- [4] R. Budney, J. Conant, K. Scannell and D. Sinha, New perspectives on self-linking. To appear in *Advances in Mathematics*.
- [5] A. Cattaneo, P. Cotta-Ramusino, and R Longoni, Configuration spaces and Vassiliev classes in any dimension. *Algebr. Geom. Topol.* **2** (2002), 949–1000.
- [6] C. De Concini and C. Procesi, Wonderful models of subspace arrangements. *Selecta Mathematica (NS)*, **1**, (1995), 459–494.
- [7] S. Devadoss, A space of cyclohedra. *Discrete Comput. Geom.* **29** (2003), no. 1, 61–75.
- [8] E. Faddell and S. Husseini, *Geometry and topology of configuration spaces*. Springer, 2001.
- [9] E. Feitchner and D. Kozlov, Incidence combinatorics of resolutions, preprint 2003.
- [10] W. Fulton and R. MacPherson, Compactification of configuration spaces. *Annals of Mathematics* **139** (1994), 183–225.
- [11] G. Gaiffi, Models for real subspace arrangements and stratified manifolds. *Int. Math. Res. Not.* (2003) no. 12, 627–656.
- [12] E. Getzler and J. Jones, Operads, homotopy algebra and iterated integrals for double loop spaces. hep-th/9403055.
- [13] P. Hirschhorn, *Model categories and their localizations*. Mathematical Surveys and Monographs, **99**. American Mathematical Society, Providence, RI, 2003.
- [14] J. Lillig, A union theorem for cofibrations. *Arch. Math. (Basel)* **24** (1973), 410–415.
- [15] M. Kontsevich, Operads and motives in deformation quantization, *Lett. Math. Phys.* 48 (1999), 35–72.
- [16] I. Kriz, On the rational homotopy type of configuration spaces. *Ann. of Math. (2)* **139** (1994), no. 2, 227–237.
- [17] G. Kuperberg and D. Thurston, Perturbative 3-manifold invariants by cut-and-paste topology. math.GT/9912167.
- [18] M. Markl, A compactification of the real configuration space as an operadic completion. *J. Algebra* **215** (1999), no. 1, 185–204.
- [19] M. Markl, S. Shnider, and J. Stasheff, *Operads in algebra, topology and physics*. Math. Surv. and Monographs, 96. AMS, Providence, RI, 2002.
- [20] S. Poirier, The configuration space integral for links in  $\mathbb{R}^3$ . *Algebr. Geom. Topol.* **2** (2002), 1001–1050.
- [21] S. Saneblidze and R. Umble, A diagonal on the associahedra. math.AT/0011065 (2001).
- [22] D. Sinha, Algebraic and differential topology of configuration spaces, in preparation.
- [23] D. Sinha, Operads and knot spaces. math.AT/0407039.
- [24] D. Sinha, The topology of space of knots. math.AT/0202287.
- [25] J. Stasheff, Homotopy associativity of  $H$ -spaces, I. *Trans. Amer. Math. Soc.* **108** (1963) 275–292.
- [26] B. Totaro, Configuration spaces of algebraic varieties. *Topology* **35** (1996), no. 4, 1057–1067.
- [27] S. Yuzvinsky, Cohomology bases for the De Concini-Procesi models of hyperplane arrangements and sums over trees. *Invent. math.* **127**, (1997), 319–335.

DEPARTMENT OF MATHEMATICS, UNIVERSITY OF OREGON, EUGENE, OR 97403

*E-mail address:* dps@math.uoregon.edu