

Probing Orientifold Behavior Near NS Branes

Dmitri Burshtyn, Shmuel Elitzur and Yaakov Mandelbaum

Racah Institute of Physics, The Hebrew University
Jerusalem 91904, Israel

The effect of NS 5 branes on an orientifold is studied. The orientifold is allowed to pass through a pile of k NS branes forming a regularized CHS geometry. Its effect on open strings in its vicinity is used to study the change in the orientifold charge induced by the NS branes.

1. Introduction

NS 5 branes are non perturbative string configurations. Therefore it is not easy to study the behavior of fundamental strings in their vicinity. Fundamental strings moving far enough from the core of the NS brane are influenced just by the NS 3 flux emanating from it. The behavior of such strings on top of the core is a more difficult problem.

One of the interesting effects of a NS brane is the change of sign of the RR charge of a 6 orientifold passing through it. As was first noted by Evans, Johnson and Shapere [1], when a NS 5 brane divides an $O6$ orientifold into two parts, these parts have opposite signs [2]. This effect is required for consistency of low energy limit field theories built on such a configuration. It is also easy to see a change of the sign between crosscup diagrams on both sides of the NS brane, far enough from it, as a result of the NS 3 flux of it [3]. Here also the perturbative treatment relies on the fundamental string diagrams put far from the NS brane.

String theory in the near horizon of a stack of kNS branes is known as Little String Theory [4]. In general it is not perturbatively controllable. For $k > 1$, the geometry formed around the branes [5] has in fact the form of an exact CFT which is the product $R^{1,5} \times SU(2)_k \times R_\phi$. Here $R^{1,5}$ is the world volume of the stack of branes, $SU(2)_k$ is the S^3 sphere of angular coordinates around it and R_ϕ is the radial coordinate $\sim e^\phi$ away from it. However, there is a linear dependence of the dilaton field along ϕ . The non perturbative nature of the configuration is reflected by the blowing up of the string coupling at the center, $\phi \rightarrow -\infty$, caused by the linear dilaton.

Use can still be made of the exact CFT form of this background if this divergence of the string coupling is properly regularized [6],[7],[8],[9]. This can be done by turning on a super Liouville potential which shields the strong coupling region. Alternatively, the super Liouville system can be replaced by the cigar shaped geometry [10],[11],[12] of the coset $SL(2, R)/U(1)$, where the strong coupling region is cut off geometrically. This type of regularization corresponds to letting the NS branes being distributed along some circle rather than sitting on top of each other. Such a background allows for a perturbative treatment of both closed [9] and open [13] strings in the near horizon neighborhood.

In this paper we use this regularized description to probe the influence of NS branes on an orientifold. An $O6$ will be put into the CFT background described above [14],[15]. The world volume of this orientifold intersects the $SU(2)$ manifold at two points. A probe of N $D4$ branes is further connected to the pile of k NS branes. The strings connecting

these D branes to their $O6$ images will be studied. As this probe of $D4$ branes is rotated with respect to the orientifold, passing the equator of the S^3 sphere, a phase transition is encountered in the gauge theory on these D branes. For odd k it will be a transition from an $SO(N)$ to an $Sp(\frac{N}{2})$ gauge group (or vice versa, depending on the original sign of the orientifold). For even k the gauge group stays the same on both sides of the transition. This is consistent with the expectation that each NS brane causes a change of the sign of the orientifold. The presence of a $(-1)^k$ factor between the charges of the two intersections of the orientifold with the $SU(2)$ manifold has been deduced before in [16] from flux arguments. Here we focus on studying the behavior of open strings and D branes systems under this transition. In [17] and [3] such a configuration was studied for the case $k = 1$. The passing from $SO(N)$ to $Sp(\frac{N}{2})$ and the enhanced gauge symmetry at the transition point were guessed there on the basis of the known change of sign of the orientifold induced by the NS brane. Here, for $k > 1$, the regularized background enables one to follow this process not only far from the NS branes but throughout the transition region.

In sec. 2 an orientifold is put into a WZW $SU(2)_k$ model. This system was analyzed algebraically in [18] and [19], and more geometrically in [20], [16] and [21]. See also [22] for a discussion of the $SO(3)$ case. The action of the orientifold Z_2 gauging on the symmetry generators in the space of open strings connecting a pointlike D brane to its mirror image is studied. In sec. 3 the treatment in [13] of open strings in the regularized background of a stack of k NS branes is reviewed. In sec. 4 an orientifold is put into this background. The results of the previous sections are used to identify a phase transition as the $D4$ branes are moved along the configuration. This transition is connected to the change of the sign of the orientifold induced by the NS branes. Sec. 5 is a conclusion.

2. Orientifold Action on Symmetry Generators

The action of an $SU(2)_k$ WZW model on a world sheet Σ is

$$S = \frac{k}{4\pi} \left[\int_{\Sigma} d^2z L^{kin} + \int_B \omega^{WZ} \right] \quad (2.1)$$

where $L^{kin} = Tr(\partial_z g \partial_{\bar{z}} g^{-1})$, $\omega^{WZ} = \frac{1}{3} Tr(g^{-1} dg)^3$, and B is a 3 manifold bounded by Σ . $g(z, \bar{z})$ is the embedding of Σ into $SU(2)$ group manifold. The variation

$$\delta g = \epsilon_L g - g \epsilon_R \quad (2.2)$$

$\epsilon_{L,R}$ being z, \bar{z} dependent infinitesimal group generators, induces the following variation in the action:

$$\delta S = \frac{k}{2\pi} \int_{\Sigma} d^2z \text{Tr}[\epsilon_L \bar{\partial}(\partial g g^{-1}) - \epsilon_R \partial(g^{-1} \bar{\partial} g)] \quad (2.3)$$

Defining the traceless, anti-hermitian matrix-valued currents

$$\begin{aligned} J &= \partial g g^{-1} \\ \bar{J} &= -g^{-1} \bar{\partial} g \end{aligned} \quad (2.4)$$

eq. (2.3) implies that for g which solves the equations of motion

$$\bar{\partial} J = \partial \bar{J} = 0 \quad (2.5)$$

This expresses the $S\hat{U}(2)_L \times S\hat{U}(2)_R$ symmetry of the WZW model.

Putting an orientifold into the group manifold amounts to modding out by the transformation $R\Omega$, where R is a Z_2 involution of the group manifold and Ω is the reversal of world sheet orientation. We will choose [21] the orientifold position such that it identifies configurations related by

$$g(z, \bar{z}) \rightarrow g^{-1}(-\bar{z}, -z) \quad (2.6)$$

From the definitions of the currents it follows that under the transformation (2.6)

$$\begin{aligned} J(z, \bar{z}) &\rightarrow -\bar{J}(-\bar{z}, -z) \\ \bar{J}(z, \bar{z}) &\rightarrow -J(-\bar{z}, -z) \end{aligned} \quad (2.7)$$

2.1. Antipodal Mirror Branes

Put also a pointlike D brane on the group manifold. Choose first its location at $g = h$ with h such that its mirror image under the transformation R of the orientifold is at the antipodal point, namely, $h^{-1} = -h$. For definiteness let us fix

$$h = \text{exp}i\left(\frac{\pi}{2}\sigma_3\right) \quad (2.8)$$

Consider then the open string connecting the D brane at h to its mirror image at $-h$. (see fig.1)

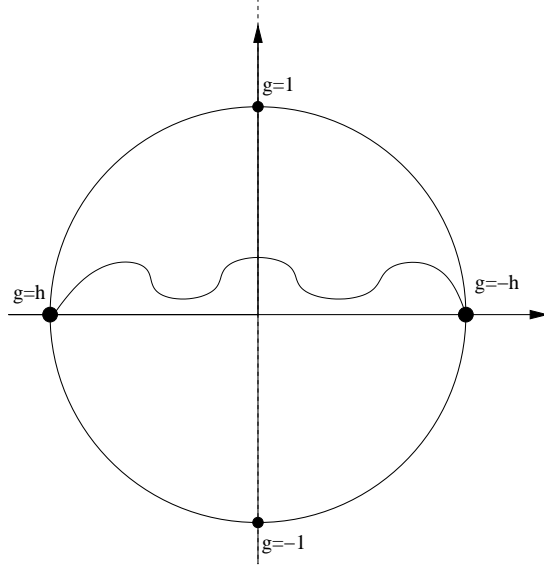

Fig. 1

Realize the world sheet of this string as the upper half plane with the boundary conditions

$$g = h = \exp(i\frac{\pi}{2}\sigma_3) \quad (2.9)$$

on the negative real axis and

$$g = h^{-1} = \exp(-i\frac{\pi}{2}\sigma_3) \quad (2.10)$$

on the positive real axis. The boundary conditions (2.9) imply that on the real axis $(\partial + \bar{\partial})g = 0$. In terms of the currents this gives the boundary conditions

$$J - h\bar{J}h^{-1} = 0 \quad (2.11)$$

on the real axis.

The infinitesimal variation (2.2) is consistent with the boundary conditions only if

$$\epsilon_L = h\epsilon_R h^{-1} \quad (2.12)$$

on the boundary. The induced variation of the action (2.3) can be written as,

$$\begin{aligned} \delta S &\sim \int d^2z \text{Tr}(\epsilon_L \bar{\partial} J + \epsilon_R \partial \bar{J}) \\ &= \int d^2z \text{Tr} \frac{1}{2} [(\epsilon_L + h\epsilon_R h^{-1})(\bar{\partial} J + \partial(h\bar{J}h^{-1})) + (\epsilon_L - h\epsilon_R h^{-1})(\bar{\partial} J - \partial(h\bar{J}h^{-1}))] \end{aligned} \quad (2.13)$$

The combination $\epsilon_L + h\epsilon_R h^{-1}$ in (2.13) is arbitrary while the combination $\epsilon_L - h\epsilon_R h^{-1}$ is forced to vanish on the boundary by (2.12). Therefore on the equations of motion the conservation law

$$\bar{\partial}J + \partial(h\bar{J}h^{-1}) = 0 \quad (2.14)$$

holds everywhere, while the remaining relations, $\bar{\partial}J - \partial(h\bar{J}h^{-1}) = 0$, may be violated on the boundary. This reflects the fact that the two pointlike branes at $g = \pm h$ break the $S\hat{U}(2)_L \times S\hat{U}(2)_R$ symmetry of the model in the open string sector, down to a single $S\hat{U}(2)$ generated by the current $(J, h\bar{J}h^{-1})$. It further follows from (2.14) that everywhere on the upper half-plane, except perhaps at the origin,

$$\bar{\partial}(z^n J) + \partial(\bar{z}^n (h\bar{J}h^{-1})) = 0 \quad (2.15)$$

for any integer n . This is because in the bulk of the half-plane each of the two terms in (2.15) vanishes separately, on the boundary $z = \bar{z}$ and one gets back (2.14).

It follows that the quantities,

$$\int [z^n J dz - \bar{z}^n h\bar{J}h^{-1} d\bar{z}] \quad (2.16)$$

where the integral is taken on any closed path, are zero. On the boundary the integrand in (2.16) vanishes identically due to (2.11). Therefore if we choose the contour of integration as the arc $z = re^{i\theta}$, $\pi \geq \theta \geq 0$ we get that the modes

$$\begin{aligned} J_n &= \frac{1}{2\pi i} \int [z^n J dz - \bar{z}^n h\bar{J}h^{-1} d\bar{z}] \\ &= \frac{1}{2\pi} r^{(n+1)} \int_0^\pi d\theta [e^{i(n+1)\theta} J(r, \theta) + e^{-i(n+1)\theta} h\bar{J}(r, \theta)h^{-1}] \end{aligned} \quad (2.17)$$

are constants of motion. They satisfy the affine Lie algebra relations for $S\hat{U}(2)_k$.

According to (2.7) the orientifold identification takes $J(r, \theta)$ in (2.16) to $-\bar{J}(r, \pi - \theta)$. So this identification acts on the modes as,

$$J_n \rightarrow (-1)^n h J_n h^{-1} \quad (2.18)$$

This is also consistent with the role of the modes J_n as the Laurent coefficients for $J(z)$. In the bulk of the upper half plane J is a holomorphic function and \bar{J} is antiholomorphic. The boundary conditions (2.11) allow one to extend J into an holomorphic function on the whole plane defining

$$J(z, \bar{z}) = h\bar{J}(\bar{z}, z)h^{-1} \quad (2.19)$$

for z in the lower half plane. $J(z)$ so defined on both halves of the complex plane can be Laurent expanded as

$$J(z) = \sum_{n \in \mathbb{Z}} \frac{J_n}{z^{n+1}} \quad (2.20)$$

In terms of the extended $J(z)$, the two terms integrated on the half circle in eq. (2.17) combine together to give the integral of $z^n J(z)$ along the full circle. This means that J_n defined in eq. (2.17) are the same Laurent coefficients defined in (2.20). The orientifold identification (2.7) reads in terms of the extended $J(z)$

$$J(z) \rightarrow -hJ(-z)h^{-1} \quad (2.21)$$

This immediately implies the action (2.18) on the Laurent coefficients.

Denote $J_n = \frac{i}{2} \sum_{a=1}^3 J_n^a \sigma_a$. We have for the orientifold action

$$J_n^3 \rightarrow (-1)^n J_n^3 \quad (2.22)$$

$$J_n^{1,2} \rightarrow -(-1)^n J_n^{1,2} \quad (2.23)$$

In particular for the global $SU(2)$ generators,

$$J_0^3 \rightarrow J_0^3 \quad (2.24)$$

$$J_0^\pm \rightarrow -J_0^\pm \quad (2.25)$$

The two branes at $g = \pm h$ preserve, as seen above, the $\widehat{SU}(2)$ symmetry generated by (2.16). These two points correspond to the two trivial conjugacy classes of $SU(2)$, the points ± 1 , shifted by the element h . According to Alekseev and Schomerus [23], there are altogether $k + 1$ (shifted) conjugacy classes which are allowed to inhabit branes which preserve this $SU(2)$ symmetry. Each of these classes corresponds to one of the $k + 1$ primary fields of $SU(2)_k$. In particular the class at h corresponds to the primary field of spin 0, while that at $-h$ corresponds to the primary field of spin $\frac{k}{2}$. This correspondence, due to Cardy [24], implies that the open strings stretched between two branes, belong to the representations of the chiral algebra which appear in the fusion of the primary fields corresponding to these branes. In our case then, the strings stretched between the brane at h and that at $-h$ belong to the representation of the $\widehat{SU}(2)$ group generated by (2.16) with spin $\frac{k}{2}$. The lightest of those strings form a degenerate multiplet of $k + 1$ members transforming in the spin $\frac{k}{2}$ representation under the global $SU(2)$ generated by

J_0 of (2.16). Let $|m\rangle$ be the state of such a light string which satisfies $J_0^3|m\rangle = m|m\rangle$. Here, $\frac{k}{2} \geq m \geq -\frac{k}{2}$ and $\frac{k}{2} - m$ is an integer. Let V_m be the vertex operator to emit an open string in the state $|m\rangle$. The dimension of each of the V_m operators is $\frac{1}{k+2}[\frac{k}{2}(\frac{k}{2} + 1)] = \frac{k}{4}$.

It follows from eq. (2.24) that the value of m , i.e. the eigenvalue of J_0^3 , is preserved by the orientifold identification. The state $|m\rangle$ must then be taken by this identification to itself up to a complex coefficient. Due to the Z_2 nature of this identification, it should either be taken to itself or to minus itself. Suppose that the orientifold identification does not affect the string in state $|m\rangle$, namely,

$$|m\rangle \rightarrow |m\rangle \quad (2.26)$$

By standard spin algebra, $|m-1\rangle \sim J_0^-|m\rangle$. Since by (2.25) J_0^- is taken to minus itself one concludes that

$$|m-1\rangle \rightarrow -|m-1\rangle \quad (2.27)$$

If the sign of the orientifold is such that it preserves the state $|\frac{k}{2}\rangle$, then all the open strings of types $|\frac{k}{2} - 2n\rangle$ will be preserved as well, while the string states $|\frac{k}{2} - 2n + 1\rangle$ will be projected out by the orientifold. In particular, in such a case, the open string generated by $V_{-\frac{k}{2}}$ is preserved for k even but projected out for k odd.

When there are N D branes, rather than one, each open string state connecting the i th brane to the mirror j th brane, carries a pair of Chan-Paton indices (i, j) . The orientifold identification for $|(i, j); \frac{k}{2}\rangle$ should read now ¹

$$|(i, j); \frac{k}{2}\rangle \rightarrow \pm |(j, i); \frac{k}{2}\rangle \quad (2.28)$$

For the plus sign in (2.28), the arguments above imply that $|(i, j); \frac{k}{2} - 2n\rangle$ survives the orientifold projection only in symmetric combinations of the Chan-Paton indices, while for $|(i, j); \frac{k}{2} - 2n + 1\rangle$ only antisymmetric Chan-Paton combinations survive. The opposite assignments occur for the minus sign in (2.28).

¹ Apparently the orientifold transformation could also act on the Chan-Paton indices [25]. Such a Z_2 type action has the general form of $|(i, j)\rangle \rightarrow \pm P_{jj'} P_{ii'}^{-1} |(j', i')\rangle$ with P a unitary matrix. However, the $U(N) \times U(N)$ gauge symmetry, present in the system before the introduction of the orientifold, enables one to choose a Chan-Paton basis for which $P = 1$.

2.2. Non-antipodal Branes

Consider moving the D brane away from the equator putting it at $g = h$ with

$$h = \exp i\left(\frac{\pi - \alpha}{2}\sigma_3\right) \quad (2.29)$$

(see fig.2)

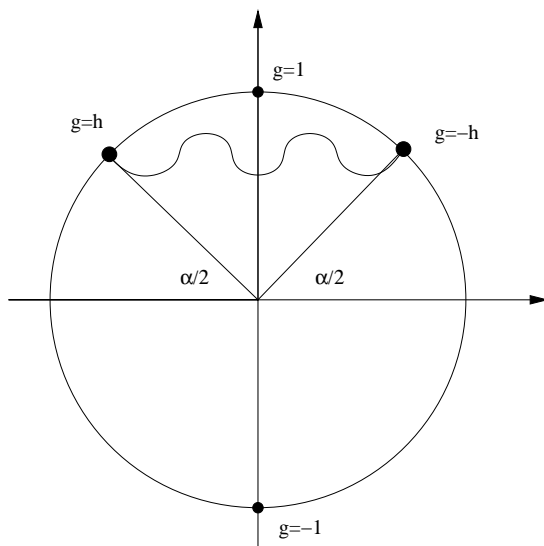

Fig. 2

The boundary conditions for an open string connecting this brane to its mirror brane at h^{-1} are again

$$g = h = \exp i\left(\frac{\pi - \alpha}{2}\sigma_3\right) \quad (2.30)$$

on the negative real axis and

$$g = h^{-1} = \exp\left(-i\left(\frac{\pi - \alpha}{2}\sigma_3\right)\right) = -he^{i\alpha\sigma_3} \quad (2.31)$$

on the positive real axis. For the currents, in analogy with (2.11), we have

$$J - h\bar{J}h^{-1} = 0 \quad (2.32)$$

on the negative real axis and

$$J - h^{-1}\bar{J}h = 0 \quad (2.33)$$

on the positive axis.² Now the infinitesimal transformation (2.2) is consistent with the boundary conditions only if the parameters $\epsilon_{L,R}$ satisfy,

$$\epsilon_L = h\epsilon_R h^{-1} \quad (2.34)$$

on the negative real axis, and

$$\epsilon_L = h^{-1}\epsilon_L h \quad (2.35)$$

on the positive real axis. In terms of the components of $\epsilon_{L,R}$ defined as $\epsilon_{L,R} = i(\epsilon_{L,R}^3\sigma_3 + \epsilon_{L,R}^-\sigma_+ + \epsilon_{L,R}^+\sigma_-)$, (where $\sigma_{\pm} = \frac{1}{2}(\sigma_1 \pm i\sigma_2)$) the constraints on the ϵ parameters read,

$$\begin{aligned} \epsilon_L^3 &= \epsilon_R^3 \\ \epsilon_L^+ &= -e^{i\alpha}\epsilon_R^+ \\ \epsilon_L^- &= -e^{-i\alpha}\epsilon_R^- \end{aligned} \quad (2.36)$$

on the negative axis, and

$$\begin{aligned} \epsilon_L^3 &= \epsilon_R^3 \\ \epsilon_L^+ &= -e^{-i\alpha}\epsilon_R^+ \\ \epsilon_L^- &= -e^{i\alpha}\epsilon_R^- \end{aligned} \quad (2.37)$$

on the positive axis.

Unlike eq. (2.12) here the constraints on the parameters on the positive real axis differ from those on the negative axis. Proceeding as in (2.13) shows that the boundary conditions on the left preserve a different $SU(2)$ subgroup than that preserved by the boundary conditions on the right. Altogether the two mirror branes (even without the orientifold) preserve no common $SU(2)$. Still one can define

$$\begin{aligned} \tilde{\epsilon}_L^+ &= z^{-\frac{\alpha}{\pi}} e^{i\frac{\alpha}{2}} \epsilon_L^+ \\ \tilde{\epsilon}_L^- &= z^{\frac{\alpha}{\pi}} e^{-i\frac{\alpha}{2}} \epsilon_L^- \end{aligned} \quad (2.38)$$

Similarly

$$\begin{aligned} \tilde{\epsilon}_R^+ &= \bar{z}^{-\frac{\alpha}{\pi}} e^{-i\frac{\alpha}{2}} \epsilon_R^+ \\ \tilde{\epsilon}_R^- &= \bar{z}^{\frac{\alpha}{\pi}} e^{i\frac{\alpha}{2}} \epsilon_R^- \end{aligned} \quad (2.39)$$

² Choosing for the boundary condition of (2.33) a group element h different than that chosen for (2.32) is not consistent with the orientifold action.

Here the cut in the fractional powers of z is chosen along the negative real axis. In terms of the $\tilde{\epsilon}$ parameters the boundary conditions constraints are the same on the positive and negative axis,

$$\begin{aligned}\epsilon_R^3 &= \epsilon_L^3 \\ \tilde{\epsilon}_R^+ &= -\tilde{\epsilon}_L^+ \\ \tilde{\epsilon}_R^- &= -\tilde{\epsilon}_L^-\end{aligned}\tag{2.40}$$

As in (2.13) we can then identify the currents preserved by (2.30), (2.31). Defining the current components $J = \frac{i}{2}(J^3\sigma_3 + J^-\sigma_+ + J^+\sigma_-)$, the variation (2.3) is

$$\begin{aligned}\delta S \sim \int d^2z &(\epsilon_L^3 \bar{\partial} J^3 + \epsilon_L^+ \bar{\partial} J^- + \epsilon_L^- \bar{\partial} J^+ + \\ &\epsilon_R^3 \partial \bar{J}^3 + \epsilon_R^+ \partial \bar{J}^- + \epsilon_R^- \partial \bar{J}^+)\end{aligned}\tag{2.41}$$

which, in terms of the $\tilde{\epsilon}$ parameters, reads,

$$\begin{aligned}\delta S \sim \int d^2z &(\epsilon_L^3 \bar{\partial} J^3 + \tilde{\epsilon}_L^+ \bar{\partial}(e^{-i\frac{\alpha}{2}} z^{\frac{\alpha}{\pi}} J^-) + \tilde{\epsilon}_L^- \bar{\partial}(e^{i\frac{\alpha}{2}} z^{-\frac{\alpha}{\pi}} J^+) + \\ &\epsilon_R^3 \partial \bar{J}^3 + \tilde{\epsilon}_R^+ \partial(e^{i\frac{\alpha}{2}} \bar{z}^{\frac{\alpha}{\pi}} \bar{J}^-) + \tilde{\epsilon}_R^- \partial(e^{-i\frac{\alpha}{2}} \bar{z}^{-\frac{\alpha}{\pi}} \bar{J}^+)\end{aligned}\tag{2.42}$$

This can be split as

$$\delta S = \delta S_1 + \delta S_2\tag{2.43}$$

where

$$\begin{aligned}\delta S_1 \sim \int d^2z &[(\epsilon_L^3 + \epsilon_R^3)(\bar{\partial} J^3 + \partial \bar{J}^3) \\ &+ (\tilde{\epsilon}_L^+ - \tilde{\epsilon}_R^+)(\bar{\partial}(e^{-i\frac{\alpha}{2}} z^{\frac{\alpha}{\pi}} J^-) - \partial(e^{i\frac{\alpha}{2}} \bar{z}^{\frac{\alpha}{\pi}} \bar{J}^-)) \\ &+ (\tilde{\epsilon}_L^- - \tilde{\epsilon}_R^-)(\bar{\partial}(e^{i\frac{\alpha}{2}} z^{-\frac{\alpha}{\pi}} J^+) - \partial(e^{-i\frac{\alpha}{2}} \bar{z}^{-\frac{\alpha}{\pi}} \bar{J}^+))]\end{aligned}\tag{2.44}$$

$$\begin{aligned}\delta S_2 \sim \int d^2z &[(\epsilon_L^3 - \epsilon_R^3)(\bar{\partial} J^3 - \partial \bar{J}^3) \\ &+ (\tilde{\epsilon}_L^+ + \tilde{\epsilon}_R^+)(\bar{\partial}(e^{-i\frac{\alpha}{2}} z^{\frac{\alpha}{\pi}} J^-) + \partial(e^{i\frac{\alpha}{2}} \bar{z}^{\frac{\alpha}{\pi}} \bar{J}^-)) \\ &+ (\tilde{\epsilon}_L^- + \tilde{\epsilon}_R^-)(\bar{\partial}(e^{i\frac{\alpha}{2}} z^{-\frac{\alpha}{\pi}} J^+) + \partial(e^{-i\frac{\alpha}{2}} \bar{z}^{-\frac{\alpha}{\pi}} \bar{J}^+))]\end{aligned}\tag{2.45}$$

In (2.44) the combinations of the $\tilde{\epsilon}$ parameters are not constrained by the boundary conditions. The equations of motion then imply,

$$\begin{aligned}\bar{\partial} J^3 + \partial \bar{J}^3 &= 0 \\ \bar{\partial} \tilde{J}^+ - \partial \tilde{J}^+ &= 0 \\ \bar{\partial} \tilde{J}^- - \partial \tilde{J}^- &= 0\end{aligned}\tag{2.46}$$

where

$$\begin{aligned}\tilde{J}^+ &= e^{i\frac{\alpha}{2}} z^{-\frac{\alpha}{\pi}} J^+ \\ \tilde{J}^- &= e^{-i\frac{\alpha}{2}} z^{\frac{\alpha}{\pi}} J^-\end{aligned}\tag{2.47}$$

and

$$\begin{aligned}\tilde{\bar{J}}^+ &= e^{-i\frac{\alpha}{2}} \bar{z}^{-\frac{\alpha}{\pi}} \bar{J}^+ \\ \tilde{\bar{J}}^- &= e^{i\frac{\alpha}{2}} \bar{z}^{\frac{\alpha}{\pi}} \bar{J}^-\end{aligned}\tag{2.48}$$

Note that (2.32) and (2.33) imply the boundary conditions

$$\begin{aligned}J^3 - \bar{J}^3 &= 0 \\ \tilde{J}^+ + \tilde{\bar{J}}^+ &= 0 \\ \tilde{J}^- + \tilde{\bar{J}}^- &= 0\end{aligned}\tag{2.49}$$

everywhere on the real axis. On the other hand the transformation parameters in δS_2 are constrained to vanish on the boundary, hence the corresponding current combinations are not conserved on the boundary. Again for any integer n we have a conservation analogous to (2.46),

$$\begin{aligned}\bar{\partial}(z^n J^3) + \partial(\bar{z}^n \bar{J}^3) &= 0 \\ \bar{\partial}(z^n \tilde{J}^+) - \partial(\bar{z}^n \tilde{\bar{J}}^+) &= 0 \\ \bar{\partial}(z^n \tilde{J}^-) - \partial(\bar{z}^n \tilde{\bar{J}}^-) &= 0\end{aligned}\tag{2.50}$$

since, as before, in the bulk of the half-plane each term for each component of (2.46) vanishes separately, while on the boundary $z = \bar{z}$ so (2.50) reduces to (2.46).

As a result of (2.50) the modes

$$\begin{aligned}J_n^3 &= \frac{1}{2\pi i} \int [z^n J^3 dz - \bar{z}^n \bar{J}^3 d\bar{z}] = \\ &= \frac{1}{2\pi} r^{n+1} \int_0^\pi d\theta [e^{i(n+1)\theta} J^3(r, \theta) + e^{-i(n+1)\theta} \bar{J}^3(r, \theta)]\end{aligned}\tag{2.51}$$

$$\begin{aligned}\tilde{J}_n^+ &= \frac{1}{2\pi i} \int [z^n \tilde{J}^+ dz + \bar{z}^n \tilde{\bar{J}}^+ d\bar{z}] \\ &= \frac{1}{2\pi i} \int [e^{i\frac{\alpha}{2}} z^{n-\frac{\alpha}{\pi}} J^+ dz + e^{-i\frac{\alpha}{2}} \bar{z}^{n-\frac{\alpha}{\pi}} \bar{J}^+ d\bar{z}] \\ &= \frac{1}{2\pi} r^{n+1-\frac{\alpha}{\pi}} \int_0^\pi d\theta [e^{i\frac{\alpha}{2}} e^{i(n+1-\frac{\alpha}{\pi})\theta} J^+(r, \theta) - e^{-i\frac{\alpha}{2}} e^{-i(n+1-\frac{\alpha}{\pi})\theta} \bar{J}^+(r, \theta)]\end{aligned}\tag{2.52}$$

$$\begin{aligned}
\tilde{J}_n^- &= \frac{1}{2\pi i} \int [z^n \tilde{J}^- dz + \bar{z}^n \tilde{J}^- d\bar{z}] \\
&= \frac{1}{2\pi i} \int [e^{-i\frac{\alpha}{2}} z^{n+\frac{\alpha}{\pi}} J^- dz + e^{i\frac{\alpha}{2}} \bar{z}^{n+\frac{\alpha}{\pi}} \bar{J}^- d\bar{z}] \\
&= \frac{1}{2\pi} r^{n+1-\frac{\alpha}{\pi}} \int_0^\pi d\theta [e^{-i\frac{\alpha}{2}} e^{i(n+1+\frac{\alpha}{\pi})\theta} J^-(r, \theta) - e^{i\frac{\alpha}{2}} e^{-i(n+1+\frac{\alpha}{\pi})\theta} \bar{J}^-(r, \theta)]
\end{aligned} \tag{2.53}$$

are conserved. These modes do not generate the standard $SU(2)$ algebra but rather a spectrally flowed version of it. Redefining

$$\tilde{J}_n^3 = J_n^3 - \frac{k\alpha}{2\pi} \delta_{n,0} \tag{2.54}$$

the modified generators $\tilde{J}_n^3, \tilde{J}_n^+$ and \tilde{J}_n^- generate a standard affine $SU(2)_k$ algebra. The Sugawara Virasoro generator \tilde{L}_0 corresponding to these generators is related to the actual L_0 operator of our model as

$$L_0 = \tilde{L}_0 + \frac{\alpha}{\pi} \tilde{J}_0^3 + \frac{k\alpha^2}{4\pi^2} \tag{2.55}$$

In the previous subsection we had the $k+1$ vertex operators V_m , all of dimension $\frac{k}{4}$, creating open strings connecting the brane at h to its mirror image at h^{-1} for the case $\alpha = 0$. Turning on α continuously, these operators remain in spin $\frac{k}{2}$ representation of the modified $SU(2)$ generated by the \tilde{J}_n . Their \tilde{L}_0 dimension is $\frac{k}{4}$. The actual L_0 dimension is then, by (2.55)

$$h_m = \frac{k}{4} + \frac{\alpha}{\pi} m + \frac{k\alpha^2}{4\pi^2} \tag{2.56}$$

The orientifold identification (2.7), takes $J^a(r, \theta)$ in (2.52) and (2.53) into $-\bar{J}^a(r, \pi-\theta)$. Applying this transformation to (2.52), (2.53), we see that the modes \tilde{J}_n transform under this identification, for general α , in the same manner as in eq. (2.22), (2.23), for $\alpha = 0$, namely

$$\tilde{J}_n^3 \rightarrow (-1)^n \tilde{J}_n^3 \tag{2.57}$$

$$\tilde{J}_n^\pm \rightarrow -(-1)^n \tilde{J}_n^\pm \tag{2.58}$$

As in previous subsection, here also in the case of non antipodal branes, this action of the orientifold on \tilde{J}_n can be deduced from their role as Laurent coefficients. Again the functions $\tilde{J}^3(z), \tilde{J}^\pm(z)$ can be extended into the lower half plane defining

$$\tilde{J}^3(z) = \tilde{J}^3(\bar{z}) \tag{2.59}$$

$$\tilde{J}^\pm(z) = -\tilde{J}^\pm(\bar{z}) \tag{2.60}$$

for z in the lower half plane. The function is analytic on the real axis due to the boundary conditions (2.49). Equations (2.51), (2.52) and (2.53) identify then $\tilde{J}_n^3, \tilde{J}_n^\pm$ as the Laurent coefficients of $\tilde{J}^3(z), \tilde{J}^\pm(z)$,

$$\tilde{J}^3(z) = \Sigma \frac{\tilde{J}_n^3}{z^{n+1}} \quad (2.61)$$

$$\tilde{J}^\pm(z) = \Sigma \frac{\tilde{J}_n^\pm}{z^{n+1}} \quad (2.62)$$

The orientifold identification (2.7) takes the extended function $\tilde{J}^3(z)$ into $-\tilde{J}^3(-z)$. Eq. (2.61) implies then (2.57) on the Laurent coefficients. As to $\tilde{J}^+(z, \bar{z})$, by its definition (2.47) it is taken by the orientifold action as

$$\tilde{J}^+(z, \bar{z}) \rightarrow -e^{i\frac{\alpha}{2}} z^{-\frac{\alpha}{\pi}} \bar{J}^+(-\bar{z}, -z) \quad (2.63)$$

According to eq. (2.48) $\bar{J}^+(-\bar{z}, -z) = e^{i\frac{\alpha}{2}} (-z)^{\frac{\alpha}{\pi}} \tilde{J}^+(-\bar{z}, -z)$. For z in the upper half plane, to avoid the cut along the negative axis, $(-z)^{\frac{\alpha}{\pi}}$ should be read as $(e^{-i\pi}z)^{\frac{\alpha}{\pi}}$. Substituting this into (2.63) gives the simple transformation

$$\tilde{J}^+(z, \bar{z}) \rightarrow -\tilde{J}^+(-\bar{z}, -z) \quad (2.64)$$

In terms of the extended holomorphic $\tilde{J}^+(z)$ defined in (2.60), this is

$$\tilde{J}^+(z) \rightarrow \tilde{J}^+(-z) \quad (2.65)$$

The same orientifold action is found for $\tilde{J}^-(z)$. The Laurent expansion (2.62) implies then (2.58) for the orientifold action on \tilde{J}_n^\pm .

In particular for $n = 0$ we have

$$\tilde{J}_0^3 \rightarrow \tilde{J}_0^3 \quad (2.66)$$

$$\tilde{J}_0^\pm \rightarrow -\tilde{J}_0^\pm \quad (2.67)$$

The same argument as in previous subsection implies then that if the orientifold is chosen such that its identification takes the vertex operator $V_{\frac{k}{2}}$ to itself then the vertex operators $V_{\frac{k}{2}-2n}$ for integer n will survive the orientifold projection while the operators $V_{\frac{k}{2}-2n+1}$ will be projected out. More generally, for N branes, the surviving operators of the form

$$V_{\frac{k}{2}-2n}^{(i,j)} \quad (2.68)$$

which emits the open string in state $|(i, j); \frac{k}{2}-2n\rangle$ should be symmetric in the Chan-Paton indices while those of the form

$$V_{\frac{k}{2}-2n+1}^{(i,j)} \quad (2.69)$$

are antisymmetric. This is the same behavior as in previous subsection, now for a general value of α .

2.3. Coincident Branes

The main conclusion of previous discussion is that $V_{\frac{k}{2}}$ and $V_{-\frac{k}{2}}$ behave the same way under the orientifold projection for even k and in opposite ways for odd k . In this subsection we check this conclusion for the limiting cases $\alpha = \pm\pi$, where it can be looked at from a different point of view. By eq. (2.54) with $\alpha = \pi$ the J^3 charge of V_m is $\frac{k}{2} + m$. The dimension of V_m is also, according to eq. (2.56), $\frac{k}{2} + m$. The operator $V_{-\frac{k}{2}}$ has then zero charge and dimension. The other V_m operators with $m < \frac{k}{2}$ have positive integral dimensions. For $\alpha = \pi$ the brane and its mirror image coincide at $g = 1$. The open strings created by V_m connect branes sitting at conjugacy classes of $SU(2)$. Invoking again [23], the conjugacy class at $g = 1$ corresponds to the primary field of spin 0 of the affine $SU(2)$ preserved by the branes. This is the group generated by the modes J_n defined in (2.16), here with $h = 1$. The strings emitted by V_m connect this conjugacy class with itself, hence [24] they belong to the representation contained in the fusion of the zero spin primary field with itself, that is to the zero spin representation. The operator $V_{-\frac{k}{2}}$ which has zero dimension and charge should be identified with the primary field of this representation. The other V_m operators which have positive integral dimensions and non zero charges are from this point of view descendants in this zero spin representation.

For $\alpha = -\pi$ the two branes meet at $g = -1$. They preserve the same $SU(2)$ as for $\alpha = \pi$. The conjugacy class at $g = -1$ correspond to the primary field with the maximal spin $\frac{k}{2}$. The strings connecting these branes belong to the representations in the fusion of the primary field with spin $\frac{k}{2}$ with itself, which is again just the zero spin representation [26]. Here eq. (2.54) gives the operator V_m the charge $m - \frac{k}{2}$ and eq. (2.56) fixes its dimension to be $\frac{k}{2} - m$. The primary field of the zero spin representation should then be the operator $V_{\frac{k}{2}}$ which has zero charge and mass, while the other V_m operators are descendants.

We find then that among the open strings emitted at $g = 1$, between branes corresponding to the spin zero representation, $V_{-\frac{k}{2}}$ is the primary field, while out of those emitted at $g = -1$ between branes corresponding to spin $\frac{k}{2}$, $V_{\frac{k}{2}}$ is the primary. In previous section we found that, for any α , if under the orientifold action $V_{\frac{k}{2}} \rightarrow V_{\frac{k}{2}}$ then under this action $V_{-\frac{k}{2}} \rightarrow (-1)^k V_{-\frac{k}{2}}$. We learn then that the action of the orientifold on strings sitting on the brane corresponding to zero spin primary field, is related by a factor $(-1)^k$ to its action on strings which sit on branes corresponding to spin $\frac{k}{2}$. This is consistent with the analysis of refs. [18],[20],[16],[21]. There it is found that the relative sign between the annulus and the Mobius strip on branes in $SU(2)$ WZW model which correspond to integral spin representations, differs from that sign for branes corresponding to half integral spin.

3. Open Strings near NS Branes

This section is a review of the part of [13] relevant for our subject. Consider a stack of $k > 1$ NS-5 branes spanning the hyper-plane (012345) in 10 dimensional type IIA model, at $x^6 = x^7 = x^8 = x^9 = 0$. The near horizon geometry formed by these branes is [5]

$$\begin{aligned}
 e^{2(\Phi-\Phi_0)} &= \frac{k}{|x|^2} \\
 G_{I,J} &= e^{2(\Phi-\Phi_0)} \delta_{I,J} \\
 G_{\mu\nu} &= \eta_{\mu\nu} \\
 H_{IJK} &= -\epsilon_{IJKM} \partial^M \Phi
 \end{aligned}
 \tag{3.1}$$

where I, J, K, M run from 6 to 10, μ, ν run from 0 to 5 and $|x|^2 = (x^6)^2 + (x^7)^2 + (x^8)^2 + (x^9)^2$. This geometry is shown schematically in fig.3 .

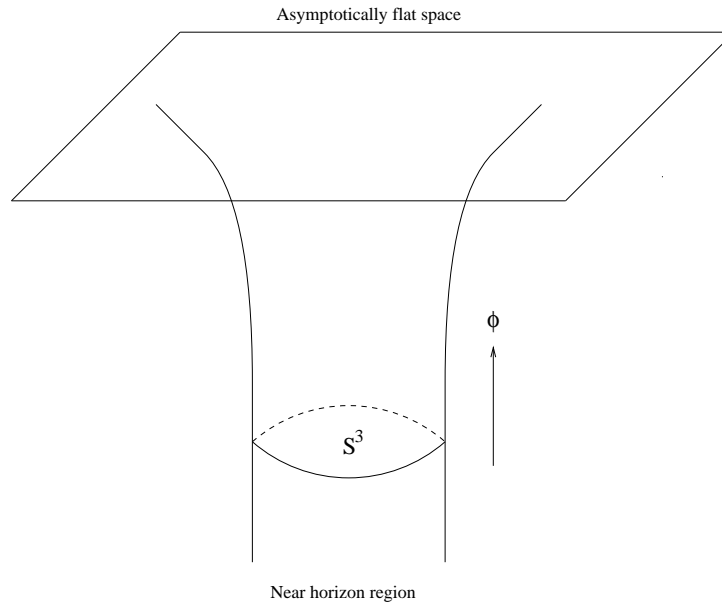

Fig. 3

This background is described by an exact CFT with the target space $R^{5,1} \times R_\phi \times SU(2)_k$. Here R_ϕ represents the radial coordinate $|x|$ with a coordinate ϕ related to it by

$$\phi = \frac{1}{Q} \log \frac{|x|^2}{k}
 \tag{3.2}$$

where

$$Q = \sqrt{\frac{2}{k}}
 \tag{3.3}$$

In terms of the coordinate ϕ the dilaton is linear,

$$\Phi = -\frac{Q}{2}\phi \quad (3.4)$$

The $SU(2)_k$ factor consists of the bosonic angular coordinates parametrizing S^3 in the 4 dimensional space transverse to the branes, and the three corresponding fermions χ_1, χ_2, χ_3 . A group element $g \in SU(2)$ can be parametrized as

$$g = \frac{1}{|x|}[x^7 1 + i(x^8 \sigma_1 + x^9 \sigma_2 + x^6 \sigma_3)] \quad (3.5)$$

g is a point in the $S\hat{U}(2)$ bosonic target space of level $k - 2$. The three fermions $\chi^{1,2,3}$ form another representation of $S\hat{U}(2)$ of level 2.

Let a stack of $ND4$ branes end on the NS 5 branes. These are stretched along the (0123) hyper-plane with their fifth coordinate in the (6, 7) plane forming an angle $\frac{\alpha}{2}$ with the x^6 axis. Let another identical stack end on the NS branes forming an angle $\pi - \frac{\alpha}{2}$ with the x^6 axis in the (6, 7) plane (see fig.4). On the world sheet of an open string connecting the first stack of D-branes to the second one the boundary conditions for g are those of (2.30) and (2.31).

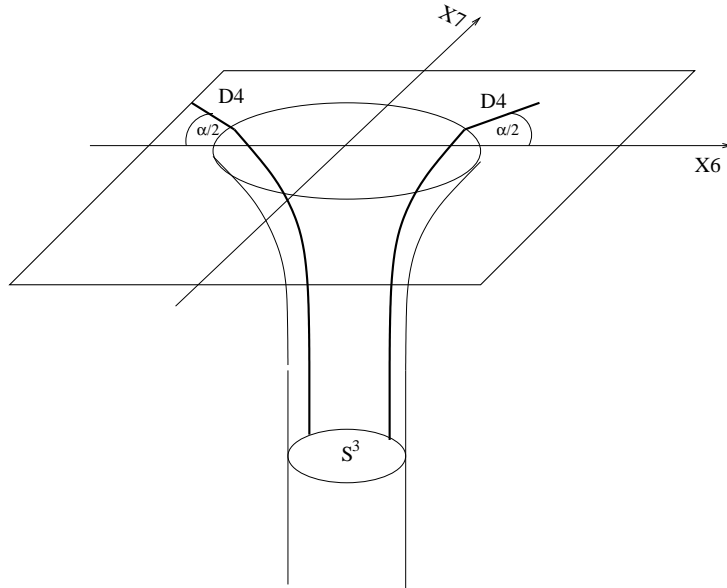

Fig. 4

Denote the currents defined in (2.4) by J_B , the bosonic currents. Their boundary conditions are those of (2.32),(2.33). By world sheet supersymmetry the boundary conditions

on the fermions $\chi^{1,2,3}$ are correlated with those for J_B . Denoting

$$\chi = \chi^1 \sigma_1 + \chi^2 \sigma_2 + \chi^3 \sigma_3 \quad (3.6)$$

the boundary conditions for χ are

$$\chi \pm h \bar{\chi} h^{-1} = 0 \quad (3.7)$$

on the negative axis, and

$$\chi \pm h^{-1} \bar{\chi} h = 0 \quad (3.8)$$

on the positive axis. The signs in (3.7) and (3.8) are equal for an open string in the NS sector, they are opposite for the Ramond sector. Defining

$$J_F = [\chi, \chi] \quad (3.9)$$

the fermionic currents J_F satisfy the same boundary conditions (2.32) and (2.33) as those of the bosonic currents J_B .

A NS vertex operator for emitting a light open string connecting the i th $D4$ brane of the first stack to the j th brane of the second is, in the -1 picture, of the form

$$V = e^{-\varphi} \exp(i(\Sigma_0^3 k_\mu x^\mu)) e^{\beta\phi} V_{m_1}^{B(i,j)} V_{m_2}^F \quad (3.10)$$

where φ is the bosonized susy ghost. The factor $\exp(i(\Sigma_0^3 k_\mu x^\mu))$ in (3.10) describes the 4-dimensional motion of the emitted open string, the factor $e^{\beta\phi}$ is responsible for its motion along the linear dilaton radial direction. The factor $V_{m_1}^{B(i,j)}$, acting on the bosonic $SU(2)$ part, is the same operator discussed in (2.68), (2.69) in the last section. It creates a string belonging to a spin $\frac{k-2}{2}$ for the $SU(2)$ generated by \tilde{J}_{B0} with the value m_1 for the operator \tilde{J}_{B0}^3 . Its dimension h_B is given by eq. (2.56),

$$h_B = \frac{k-2}{4} + \frac{\alpha}{\pi} m_1 + \frac{(k-2)\alpha^2}{4\pi^2} \quad (3.11)$$

$V_{m_2}^F$ is the corresponding fermionic operator. It creates a state with spin 1 under the $SU(2)$ generated by \tilde{J}_{F0} with the value m_2 for the operator \tilde{J}_{F0}^3 . Its dimension h_F is accordingly,

$$h_F = \frac{2}{4} + \frac{\alpha}{\pi} m_2 + \frac{2\alpha^2}{4\pi^2} \quad (3.12)$$

The allowed values of the parameters k_μ and β are subject to the mass shell condition which requires the total dimension of V to be 1. The open strings created by V are light in the sense that no string oscillator is excited in (3.10).

As it stands the background (3.1) is singular, the string coupling e^Φ diverges when $|x| \rightarrow 0$. A regularization which can avoid this singularity leads to a perturbatively controllable background. One way for such a regularization is by turning on a Liouville potential for ϕ , which shields the region $\phi \rightarrow -\infty$. For the sake of spacetime supersymmetry the ϕ field has to be treated as a component of an $N = 2$ Liouville system. This system contains also a $U(1)$ generator. This can be chosen to be the total J^3 current, $J^3 = J_B^3 + J_F^3$. One then bosonizes the current J^3 defining a scalar field Y by

$$J^3 = 2i\sqrt{\frac{k}{2}}\partial Y \quad (3.13)$$

treating ϕ and Y as components of $N = 2$ $2d$ Liouville system. Note that the Liouville superpotential required for the regularization breaks the $SU(2)$ symmetry, assigning a special role to J^3 .

An alternative, equivalent, regularization replaces the linear dilaton coordinate ϕ and the angular coordinate Y , together with their corresponding fermions, by the cigar shaped (super) coset $SL(2, R)/U(1)$ [6],[7],[8],[9]. Instead of shielding the region $\phi \rightarrow -\infty$ by a potential wall, it is cut off the geometry by the tip of the cigar. The resulting CFT becomes then ³

$$R^{1,5} \times SL(2)_k/U(1) \times SU(2)_k/U(1) \quad (3.14)$$

the level of $SL(2)$ is chosen such that the linear dilaton behavior (3.4) is reconstructed for large positive ϕ . Geometrically, this regularization amounts to splitting the k NS-5 branes which generate the configuration, spreading them with small mutual distances from each other along the $(6, 7)$ plane. Here also the $SU(2)$ symmetry is broken by the regularization.

In this language, we shall build a vertex operator for emitting a light open string from a D -brane of the first stack to a brane in the other stack. Denote by $V_{j,m}^{\prime w}$ the $SL(2)_k$ vertex operator corresponding to a unitary representation of $SL(2)$ with the value $-j(j+1)$ for its second Casimir, spectrally flowed w times ($w \in Z$) [27], with $U(1)$ charge m . The

³ The product here is not exactly a direct product, see [13] and references therein for more details.

dimension of this operator is $h = -\frac{j(j+1)}{k}$. Let $[V'_{j,m}]$ denote the $SL(2)/U(1)$ part of $V'_{j,m}$. Accordingly the dimension of $[V'_{j,m}]$ is

$$[h]_{j,m}^w = -\frac{j(j+1)}{k} + \frac{(m+kw)^2}{k} \quad (3.15)$$

Similarly, denote by $[V_{m_1}^{B(i,j)} V_{m_2}^F]$ the $SU(2)/U(1)$ part of the full $SU(2)$ operator $V_{m_1}^{B(i,j)} V_{m_2}^F$ of (3.10). The total J_0^3 charge of $V_{m_1}^{B(i,j)} V_{m_2}^F$ is, by (2.54), $m_1 + m_2 + \frac{k\alpha}{2\pi}$. The dimension of this operator is given by eq. (2.56). The dimension $[h]$ of the $SU(2)$ part $[V_{m_1}^{B(i,j)} V_{m_2}^F]$ is

$$[h] = \frac{k}{4} + \frac{\alpha}{\pi}(m_1 + m_2) + \frac{k\alpha^2}{4\pi^2} - \frac{(m_1 + m_2 + \frac{k\alpha}{2\pi})^2}{k} \quad (3.16)$$

In these terms the full vertex operator for emitting a light open string connecting the two stacks becomes

$$V = e^{-\varphi} \exp(i \sum_0^3 k_\mu x^\mu) [V'_{j, m_1 + m_2 + \frac{k\alpha}{2\pi}}] [V_{m_1}^{B(i,j)} V_{m_2}^F] \quad (3.17)$$

The J_0^3 charge in the $SU(2)$ and $SL(2)$ parts of the vertex operator should be the same. They both refer to the same field Y defined in (3.13).

The near horizon geometry (3.1) and its cigar regularization are adequate for vertex operators which are confined to the neighborhood of the NS branes source. Such are the operators of the form (3.17) with $V'_{j, m_1 + m_2 + \frac{k\alpha}{2\pi}}$ corresponding to a discrete representation of $SL(2, R)$ whose wave function is exponentially suppressed for large $|x|$. In contrast, vertex operators corresponding to continuous representations, which create long strings [27], have their wave functions extended into the far region where the description (3.1) is not appropriate. We will then focus attention on discrete representations. For those, j is a real number. The unitarity bound for $SL(\hat{2}, R)$ models is $-\frac{1}{2} < j < \frac{k-1}{2}$ [9], [27]. In discrete representations of $SL(2)$, if m is the eigenvalue of J^3 then the difference $|m| - j$ is a positive integer.

The mass M of the string emitted by (3.17) is fixed by the mass shell condition to satisfy

$$\frac{M^2}{2} = \frac{1}{2}(k_0^2 - \sum_1^3 k_i^2) = -\frac{1}{2} - \frac{j(j+1)}{k} + \frac{k}{4} [1 + \frac{\alpha^2}{\pi^2} + 4w(w + \frac{\alpha}{\pi})] + (m_1 + m_2)(2w + \frac{\alpha}{\pi}) \quad (3.18)$$

Here,

$$-\frac{k}{2} \leq m_1 + m_2 \leq \frac{k}{2} \quad (3.19)$$

by the $SU(2)$ role of $m_{1,2}$, and

$$|m_1 + m_2 - \frac{k\alpha}{2\pi}| - j \quad (3.20)$$

is a positive integer because of the $SL(2)$ role of $m_1 + m_2 + \frac{k\alpha}{2\pi}$ and the conditions on discrete representations. For $\alpha = 0$ eq. (3.18) reads

$$\frac{kM^2}{2} = \frac{k}{2}\left(\frac{k}{2} - 1\right) - j(j+1) + kw[kw + 2(m_1 + m_2)] \quad (3.21)$$

Subject to the inequality (3.19) and condition (3.20) the mass squared (3.21) is non-negative. This is consistent with the fact that the background with $\alpha = 0$ is space-time supersymmetric. Choosing in (3.21) $w = 0$ and $j = \frac{k}{2} - 1$ one gets zero mass. The conditions on discrete representations fix the value of $m_1 + m_2$ to either $\frac{k}{2}$ or $-\frac{k}{2}$. So out of the $3(k-2)$ allowed values of (m_1, m_2) in (3.17), only the two values $(m_1, m_2) = (\frac{k-2}{2}, 1)$ and $(m_1, m_2) = (-\frac{k-2}{2}, -1)$ correspond to massless particles. (Remember that the $SU(2)$ symmetry is broken by the regularization). Note that these two massless states belong to the representation of the total $SU(2)$ generated by $J_{B0} + J_{F0}$ with spin $\frac{k}{2}$. For non zero α the masses of these two states changes according to (3.18). For the state with $m_1 + m_2 = \frac{k}{2}$ we have $j_+ = \frac{k}{2} + \frac{k\alpha}{2\pi} - 1$. Substituting j_+ for j in (3.18) we get

$$M_+^2 = \frac{\alpha}{\pi} \quad (3.22)$$

For the state with $m_1 + m_2 = -\frac{k}{2}$ we have $j_- = \frac{k}{2} - \frac{k\alpha}{2\pi} - 1$. This gives the mass

$$M_-^2 = -\frac{\alpha}{\pi} \quad (3.23)$$

4. Phase Transition in Presence of an Orientifold

Let an $O6$ orientifold be stretched along the (0123457) plane, at the location $x^6 = x^8 = x^9 = 0$, in the system described in previous section. This amounts to gauging the world sheet symmetry

$$x^I(z, \bar{z}) \rightarrow x^I(-\bar{z}, -z) \quad (4.1)$$

for $I = 0, 1, 2, 3, 4, 5, 7$ and

$$x^I(z, \bar{z}) \rightarrow -x^I(-\bar{z}, -z) \quad (4.2)$$

for $I = 6, 8, 9$. To preserve world sheet supersymmetry, the corresponding fermions are transformed in a correlated way,

$$\psi^I(z, \bar{z}) \rightarrow i\bar{\psi}^I(-\bar{z}, -z) \quad (4.3)$$

for $I = 0, 1, 2, 3, 4, 5, 7$ and

$$\psi^I(z, \bar{z}) \rightarrow -i\bar{\psi}^I(-\bar{z}, -z) \quad (4.4)$$

for $I = 6, 8, 9$.⁴ In terms of the coordinates x^μ , $|x|$ and g in (3.1), the orientifold action is

$$\begin{aligned} x^\mu(z, \bar{z}) &\rightarrow x^\mu(-\bar{z}, -z) \\ |x|(z, \bar{z}) &\rightarrow |x|(-\bar{z}, -z) \\ g(z, \bar{z}) &\rightarrow g^{-1}(-\bar{z}, -z) \end{aligned} \quad (4.5)$$

Since the action on g is identical to that of eq. (2.6) the results of sec. 2 for the action of the orientifold on the bosonic currents and their modes apply to our case. By (2.7) this action on the bosonic current is

$$J_B(z, \bar{z}) \rightarrow -\bar{J}_B(-\bar{z}, -z) \quad (4.6)$$

On the world sheet of the open string which connects the $D4$ branes to their orientifold images, the modes of the bosonic current $\tilde{J}_{Bn}^3, \tilde{J}_{Bn}^\pm$ are defined as in (2.51),(2.52),(2.53) and (2.54). According to (2.57) and (2.58), the orientifold identifies these modes under the transformation

$$\tilde{J}_{Bn}^3 \rightarrow (-1)^n \tilde{J}_{Bn}^3 \quad (4.7)$$

$$\tilde{J}_{Bn}^\pm \rightarrow -(-1)^n \tilde{J}_{Bn}^\pm \quad (4.8)$$

By (4.4) the orientifold action on the χ fermions is,

$$\chi(z, \bar{z}) \rightarrow -i\bar{\chi}(-\bar{z}, -z) \quad (4.9)$$

with matrix valued χ defined in (3.6). This implies the same type of action on J_F defined in (3.9).

$$J_F(z, \bar{z}) \rightarrow -\bar{J}_F(-\bar{z}, -z) \quad (4.10)$$

⁴ The factor i in (4.3) and (4.4) results from the world sheet spin 1/2 of the operators ψ^I . The transition from z, \bar{z} to $-\bar{z}, -z$ changes the sign of the single z and \bar{z} derivative in the fermionic world sheet action. This has to be restored by these factors of i .

As discussed in the previous section, the fermionic current J_F has to have the same boundary conditions as the bosonic current J_B . The fermionic current has then the same type of mode expansion as the bosonic one, whose coefficients \tilde{J}_{Fn} are defined analogously to (2.51), (2.52), (2.53) and (2.54), with $k = 2$ in (2.54). Since the orientifold action on the local currents is the same on the bosonic and fermionic currents, it is also the same on the modes. The orientifold action on the fermionic modes is then also of the form (4.7) and (4.8),

$$\tilde{J}_{Fn}^3 \rightarrow (-1)^n \tilde{J}_{Fn}^3 \quad (4.11)$$

$$\tilde{J}_{Fn}^\pm \rightarrow -(-1)^n \tilde{J}_{Fn}^\pm \quad (4.12)$$

We get then the same type of action also for the modes of the total current $J = J_B + J_F$. For the modes of this current we get again eqs. (2.57) and (2.58), and for $n = 0$ eqs. (2.66) and (2.67), for their orientifold identification.

The arguments of sec. 2 can be repeated here to show that if V_m^S is such a vertex operator which transforms according to the spin S representation under the $SU(2)$ group generated by the total currents $\tilde{J}_0^3, \tilde{J}_0^\pm$ with m being the eigenvalue of \tilde{J}_0^3 , then the orientifold action changes sign between V_m^S and V_{m+1}^S . In particular, if V_S^S is identified with itself under the orientifold action, then, for S integer, V_{-S}^S is also identified with itself and for S half integer V_{-S}^S is identified with minus itself.

Let us follow the low energy behavior of the theory on the stack of $ND4$ branes as a function of the parameter α . To have a 4 dimensional physics assume that these branes connect our pile of $NS5$ branes to another NS brane, call it the NS' brane, sitting in the $(6, 7)$ plane at a finite distance from the origin. The mirror images of these D branes should of course end at the mirror image of this NS' brane under the orientifold projection. We change the value of α by moving the NS' brane around in the $(6, 7)$ plane. Start with the supersymmetric case $\alpha = 0$. In the absence of the orientifold the two stacks of $D4$ branes are not identified with each other. We expect at low energy a $U(N) \times U(N)$ gauge group. We found two types of massless open strings connecting one stack to the other, corresponding to $m_1 + m_2 = \pm \frac{k}{2}$. The vertex operator with $m_1 + m_2 = \frac{k}{2}$ gives rise to a complex massless chiral superfield Q , in the bi-fundamental representation (\bar{N}, N) . The operator with $m_1 + m_2 = -\frac{k}{2}$ gives rise to an anti-chiral superfield denoted by \tilde{Q}^* , in the same representation. Q in the (\bar{N}, N) and \tilde{Q} in the (N, \bar{N}) representation are two chiral fields with J_0^3 charge $\frac{k}{2}$.

The orientifold identifies the two sets of branes, turning the gauge group into a single $U(N)$. For even k , we found that both Q and \tilde{Q}^* have the same orientifold behavior. If the sign of the orientifold is chosen to take the vertex operators corresponding to Q and \tilde{Q}^* to themselves, their Chan-Paton symmetric part survives the projection and the resulting $U(N)$ gauge theory contains two chiral matter superfields, one in the symmetric representation and the other in its conjugate. For the other choice of the sign of the orientifold only the antisymmetric part survives and we get a theory with two fields, one in the antisymmetric representation of $U(N)$ and the other in its conjugate. For an odd k we find that the two vertex operators corresponding to Q and \tilde{Q}^* have opposite behavior under the orientifold transformation. In that case then the low energy gauge theory will contain two massless matter fields, Q in the symmetric representation and \tilde{Q} in the conjugate antisymmetric one (or vice versa). This is indeed the matter content suggested in [17] and [3] for the case $k = 1$.

Now rotate the $D4$ branes to get $\alpha > 0$. Notice that the preceding analysis of the orientifold action on Q and \tilde{Q}^* applies for any value of α . By eq. (3.22) the mass squared M_-^2 becomes negative. The scalar component of the field \tilde{Q} becomes tachyonic. Suppose the sign of the orientifold is such that this field is in the symmetric representation of $U(N)$. From field theory point of view this means that \tilde{Q} gets a non zero vacuum expectation value. An expectation value for a symmetric field breaks the gauge group $U(N)$ down to $SO(N)$. From a geometrical point of view the appearance of a tachyon is a sign of an instability of the system caused by the rotation of the branes into a non zero α position. Presumably the system decays into a more stable position in which the $D4$ branes detach from the pile of the NS branes connecting the NS' brane directly to its image, meeting the orientifold at right angle at a point with $x^7 > 0$ (see fig.5).

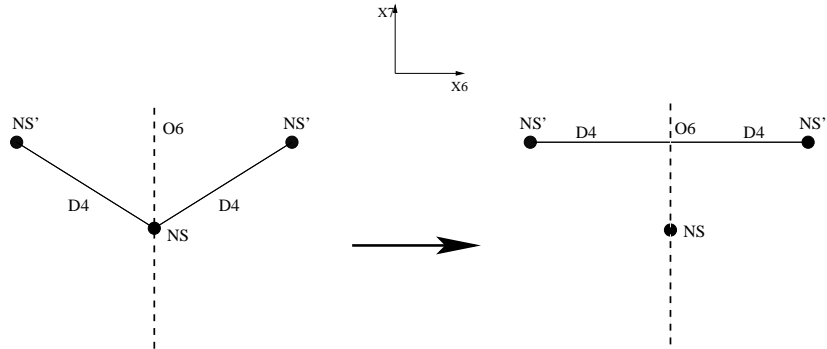

Fig. 5

The latter configuration is definitely more stable than the original one, since it preserves space-time supersymmetry. Combining together field theory and geometry we conclude that when the $D4$ branes meet the orientifold at positive x^7 , the resulting low energy gauge group on them is $SO(N)$. Now let α be negative. According to (3.23) the scalar component of Q becomes tachyonic and gets non zero expectation value. For even k , we have a similar phenomenon. Q is also a symmetric field and the resulting gauge symmetry is again $SO(N)$. Geometrically this $SO(N)$ occurs when the D branes detach from the NS pile meeting the orientifold at $x^7 < 0$ (see fig.6).

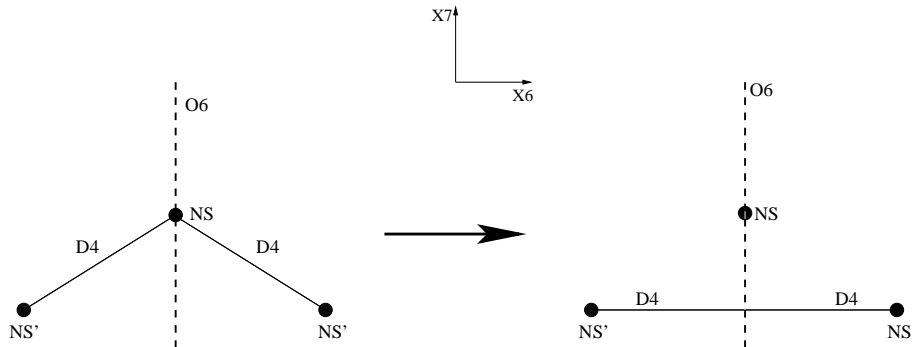

Fig. 6

For generic values of α the theory on the $D4$ branes is $SO(N)$, at the critical point $\alpha = 0$ there is an enhancement of the gauge symmetry to $U(N)$.

If k is odd the picture is different. Unlike \tilde{Q} , the field Q is antisymmetric. Its expectation value breaks the $U(N)$ group down to $Sp(\frac{N}{2})$. Now the enhanced symmetry point $\alpha = 0$ is a phase transition from an $SO(N)$ phase for positive α to a different, $Sp(\frac{N}{2})$ phase for negative α . Geometrically it means that $D4$ branes meeting the orientifold at $x^7 > 0$ have $SO(N)$ gauge group at low energy, while those that meet the orientifold at $x^7 < 0$ have $Sp(\frac{N}{2})$ as their gauge group.

We have then another derivation of the phenomenon of the change of sign of an orientifold when it passes through an odd number, larger than 1, of NS branes. This is in full accordance with the results of [17] and [3] for the case $k = 1$.

As explained in these papers this background with an odd k is not stable by itself. From string theory point of view it has a non zero tadpole for RR form. From field theory perspective the matter content of a symmetric and a conjugate antisymmetric chiral fields in $U(N)$ theory is anomalous. It can be stabilized though by adding 8 half $D6$ branes

parallel to the $O6$ along half of the x^7 axis, ending on the NS branes. According to [28] the 4 – 6 open strings between the $D4$ branes and those half $D6$ branes provide the chiral matter required for cancelling the anomaly. We do not deal with these phenomena here.

A parallel argumentation leading to the same conclusions uses [18], [20], [16] and [21]. Like in sec. 2.3, we can think of the branes as being continuously rotated by angle $\beta = \frac{\pi-\alpha}{2}$ from the positive x^7 axis (fig. 7).

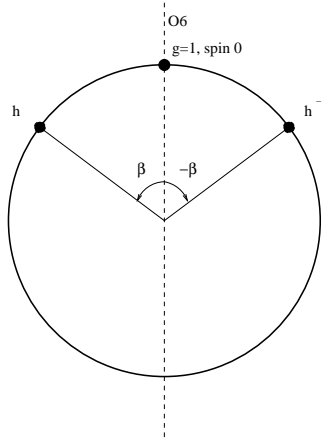

Fig. 7

For $\beta = 0$ the two stacks of D -branes coincide at $g = 1$. They correspond to the primary field of spin 0, so the open strings stretched between them belong to the same representation. The $SU(2)$ part of the vertex operator corresponding to the field Q , $V_{-\frac{k-2}{2}}^{B(i,j)} V_{-1}^F$, has for $\beta = 0$, zero J^3 charge and zero dimension, hence it is to be identified with the primary field of this representation. Since the branes correspond to an integer spin representation, by [18], [20], [16] and [21], it is preserved by the orientifold projection giving rise to a symmetric Chan-Paton configuration. Instead, the D -branes can be thought of as rotated by an angle $\gamma = \frac{\pi+\alpha}{2}$ from the negative x^7 axis (fig. 8).

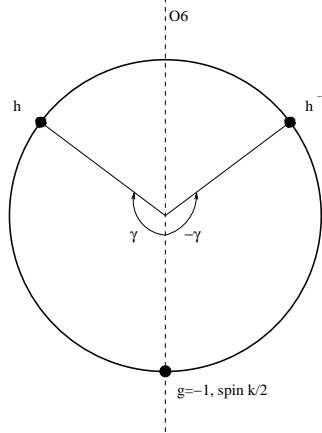

Fig. 8

For $\gamma = 0$ the two stacks coincide at $g = -1$, corresponding to the spin $\frac{k}{2}$ representation. The open strings between them are again in the spin 0 representation. For $\gamma = 0$ the $SU(2)$ part of the vertex operator corresponding to the field Q , $V_{\frac{(k-2)}{2}}^{B(i,j)} V_1^F$, is the one with zero charge and mass. This is then the primary field corresponding to this representation. If k is odd, the spin $\frac{k}{2}$ is half integral, [18], [20], [16], [21] then imply that the orientifold projection takes Q to minus itself, giving rise to a Chan-Paton antisymmetric field. For $0 \leq \beta < \frac{\pi}{2}$ the field \tilde{Q} is tachyonic, by (3.22), breaking the symmetry to $SO(N)$. The field Q is then massive. For $\frac{\pi}{2} < \beta \leq \pi$ the field Q is tachyonic. If k is odd, the breaking then is to $Sp(\frac{N}{2})$.

5. Conclusions

The regularized background of k parallel NS branes was used to study the effect of such branes on the RR charge of an orientifold. The main tool is the alternating sign of orientifold projection among open strings members of $SU(2)$ multiplet found in (2.68) and (2.69). The careful study of the current modes preserved by the D branes and of their orientifold transformation, leading to eq. (2.66) and (2.67), is needed to establish this sign alternation. It was also shown to be consistent with the signs assigned in [18], [20],[16] and [21] to Mobius diagrams on $SU(2)$ branes. In principle one may also obtain this results expressing the vertex operator in terms of the scalar field Y defined in eq. (3.13) as in [13] and studying the orientifold behavior of this field . This analysis is deferred for a possible future publication. In [13], instabilities were identified in a system of 2 stacks of $D4$ branes ending on a pile of k NS branes for a generic angle between them. Introducing

an orientifold into such a system and using the results of sec. 2, these instabilities could be shown to break the gauge symmetry on the D branes either to an orthogonal or to a symplectic group. The choice between these two possibilities characterizes the sign of the orientifold. A change in the sign was identified for odd k . This is a generalization of the analysis of [17] and [3] for $k > 1$. In this way we could follow the change in the nature of the orientifold as a phase transition in the gauge theory on the D branes which end on the pile of NS branes.

Acknowledgements: We thank E. Rabinovici for suggesting the subject and for discussions. We also thank M. Berkooz and A. Givon for discussions. This work is supported in part by the Israel Academy of Sciences and Humanities - Centers of Excellence program, The German-Israel Bi-national Science Foundation and the European RTN network HPRN-CT-2000-00122. S.E. thanks the TH division at CERN for hospitality while part of this work was done.

References

- [1] N. Evans, C. V. Johnson and A. D. Shapere, Nucl. Phys. B **505**, 251 (1997) [arXiv:hep-th/9703210].
- [2] For a review see A. Giveon and D. Kutasov, Rev. Mod. Phys. **71**, 983 (1999) [arXiv:hep-th/9802067].
- [3] S. Elitzur, A. Giveon, D. Kutasov and D. Tsabar, Nucl. Phys. B **524**, 251 (1998) [arXiv:hep-th/9801020].
- [4] For a review see O. Aharony, Class. Quant. Grav. **17**, 929 (2000) [arXiv:hep-th/9911147].
- [5] C. G. Callan, J. A. Harvey and A. Strominger, arXiv:hep-th/9112030.
- [6] H. Ooguri and C. Vafa, Nucl. Phys. B **463**, 55 (1996) [arXiv:hep-th/9511164].
- [7] C. Csaki, J. Russo, K. Sfetsos and J. Terning, “Supergravity models for 3+1 dimensional QCD,” Phys. Rev. D **60**, 044001 (1999) [arXiv:hep-th/9902067].
- [8] A. Giveon, D. Kutasov and O. Pelc, JHEP **9910**, 035 (1999) [arXiv:hep-th/9907178].
- [9] A. Giveon and D. Kutasov, JHEP **0001**, 023 (2000) [arXiv:hep-th/9911039].
- [10] S. Elitzur, A. Forge and E. Rabinovici, Nucl. Phys. B **359**, 581 (1991).
- [11] G. Mandal, A. M. Sengupta and S. R. Wadia, Mod. Phys. Lett. A **6**, 1685 (1991).
- [12] E. Witten, Phys. Rev. D **44**, 314 (1991).
- [13] S. Elitzur, A. Giveon, D. Kutasov, E. Rabinovici and G. Sarkissian, JHEP **0008**, 046 (2000) [arXiv:hep-th/0005052].
- [14] C. V. Johnson, Phys. Rev. D **56**, 5160 (1997) [arXiv:hep-th/9705148].
- [15] S. Forste, D. Ghoshal and S. Panda, Phys. Lett. B **411**, 46 (1997) [arXiv:hep-th/9706057].
- [16] C. Bachas, N. Couchoud and P. Windey, JHEP **0112**, 003 (2001) [arXiv:hep-th/0111002].
- [17] K. Landsteiner, E. Lopez and D. A. Lowe, JHEP **9802**, 007 (1998) [arXiv:hep-th/9801002].
- [18] G. Pradisi, A. Sagnotti and Y. S. Stanev, Phys. Lett. B **354**, 279 (1995) [arXiv:hep-th/9503207].
- [19] A. Sagnotti and Y. S. Stanev, Fortsch. Phys. **44**, 585 (1996) [Nucl. Phys. Proc. Suppl. **55B**, 200 (1997)] [arXiv:hep-th/9605042].
- [20] I. Brunner, JHEP **0201**, 007 (2002) [arXiv:hep-th/0110219].
- [21] L. R. Huiszoon, K. Schalm and A. N. Schellekens, Nucl. Phys. B **624**, 219 (2002) [arXiv:hep-th/0110267].
- [22] N. Couchoud, JHEP **0203**, 026 (2002) [arXiv:hep-th/0201089].
- [23] A. Y. Alekseev and V. Schomerus, Phys. Rev. D **60**, 061901 (1999) [arXiv:hep-th/9812193].
- [24] J. L. Cardy, Nucl. Phys. B **324**, 581 (1989).

- [25] J. Polchinski, *String Theory*, Cambridge University Press 1998, vol.I, p. 191
- [26] P. Di Francesco, P. Mathieu and D. Senechal, *Conformal Field Theory*, NY Springer 1997, p. 684.
- [27] J. M. Maldacena and H. Ooguri, *J. Math. Phys.* **42**, 2929 (2001) [*arXiv:hep-th/0001053*].
- [28] J. H. Brodie and A. Hanany, *Nucl. Phys. B* **506**, 157 (1997) [*arXiv:hep-th/9704043*].