

Hamiltonian Quantization of Chern-Simons theory with $SL(2, \mathbb{C})$ Group

E. BUFFENOIR, K. NOUI, Ph. ROCHE
Laboratoire de physique mathématique et théorique
Université Montpellier 2, 34000 Montpellier, France.

April 17, 2018

Abstract

We analyze the hamiltonian quantization of Chern-Simons theory associated to the real group $SL(2, \mathbb{C})_{\mathbb{R}}$, universal covering of the Lorentz group $SO(3, 1)$. The algebra of observables is generated by finite dimensional spin networks drawn on a punctured topological surface. Our main result is a construction of a unitary representation of this algebra. For this purpose we use the formalism of combinatorial quantization of Chern-Simons theory, i.e we quantize the algebra of polynomial functions on the space of flat $SL(2, \mathbb{C})_{\mathbb{R}}$ -connections on a topological surface Σ with punctures. This algebra, the so called moduli algebra, is constructed along the lines of Fock-Rosly, Alekseev-Grosse-Schomerus, Buffenoir-Roche using only finite dimensional representations of $U_q(sl(2, \mathbb{C})_{\mathbb{R}})$. It is shown that this algebra admits a unitary representation acting on an Hilbert space which consists in wave packets of spin-networks associated to principal unitary representations of $U_q(sl(2, \mathbb{C})_{\mathbb{R}})$. The representation of the moduli algebra is constructed using only Clebsch-Gordan decomposition of a tensor product of a finite dimensional representation with a principal unitary representation of $U_q(sl(2, \mathbb{C})_{\mathbb{R}})$. The proof of unitarity of this representation is non trivial and is a consequence of properties of $U_q(sl(2, \mathbb{C})_{\mathbb{R}})$ intertwiners which are studied in depth. We analyze the relationship between the insertion of a puncture colored with a principal representation and the presence of a world-line of a massive spinning particle in de Sitter space.

I. Introduction

In the pioneering work of [1, 28], it has been shown that there is an “equivalence” between 2+1 dimensional gravity with cosmological constant Λ and Chern-Simons theory with a non compact group of the type $SO(3, 1)$, $ISO(2, 1)$ or $SO(2, 2)$ (depending on the sign of the cosmological constant Λ). A good review on this subject is [15]. As a result the project of quantization of Chern-Simons theory for these groups has spin-offs on the program of canonical quantization of 2+1 quantum gravity. However one should be aware that the two theories, nor in the classical case nor in the quantum case, are not completely equivalent. These discrepancies arise from various reasons.

One of them, fully understood by Matschull [20], is that the Chern-Simons formulation includes degenerate metrics, and the classical phase space of Chern-Simons is therefore quite different from the classical phase space of 2+1 gravity. Another one comes from the structure of boundary terms (horizon, observer, particles) which have to be carefully related in the two models.

In this work, we study Chern-Simons formulation of 2+1 gravity in the case where the cosmological constant is positive i.e Chern-Simons theory on a 3-dimensional compact oriented manifold $M = \Sigma \times \mathbb{R}$ with the real non compact group $SL(2, \mathbb{C})_{\mathbb{R}}$ universal covering of $SO(3, 1)$. This theory has been the subject of numerous studies, the main contributions being the work of E.Witten [29] using geometric quantization and the work of Nelson-Regge [21] using representation of the algebra of observables. We will extend the analysis of Nelson-Regge using the so-called ‘‘combinatorial quantization of Chern-Simons theory’’ developed in [18, 2, 3, 10, 11]. We first give the idea of the construction when the group is compact. Let Σ be an oriented topological compact surface of genus n and let us denote by $G = SU(2)$ and \mathfrak{g} its Lie algebra. The classical phase space of $SU(2)$ -Chern Simons theory is the symplectic manifold $Hom(\pi_1(\Sigma), G)/AdG$. The algebra of functions on this manifold is a Poisson algebra which admits a quantization $M_q(\Sigma, G)$, called Moduli algebra in [2], which is an associative algebra with an involution $*$. Note that q is taken here to be a root of unity $q = e^{i\frac{\pi}{k+2}}$ where $k \in \mathbb{N}$ is the coupling constant in the Chern-Simons action. This algebra is built in two stages. One first defines a quantization of the Poisson algebra $F(G^{2n})$ endowed with the Fock-Rosly Poisson structure [18]. This algebra is denoted \mathcal{L}_n and called the graph algebra [2]. It is the algebra generated by the matrix elements of the $2n$ quantum holonomies around the non trivial cycles a_i, b_i . $U_q(\mathfrak{g})$ acts on \mathcal{L}_n by gauge transformations. The space of invariant elements $\mathcal{L}_n^{U_q(\mathfrak{g})}$ is a subalgebra of \mathcal{L}_n whose vector space basis is entirely described by spin networks drawn on Σ . If we define U_C to be the quantum holonomy around the cycle $C = \prod_{i=1}^n [a_i, b_i^{-1}]$, one defines an ideal \mathcal{I}_C of $\mathcal{L}_n^{U_q(\mathfrak{g})}$ which, when modded out, enforces the relation $U_C = 1$. As a result the moduli algebra is $M_q(\Sigma, G) = \mathcal{L}_n^{U_q(\mathfrak{g})} / \mathcal{I}_C$. In [5, 4] Alekseev and Schomerus have constructed its unique unitary irreducible representation acting on a finite dimensional Hilbert space H . This is done in two steps. They have shown that there exists a unique unitary representation ρ ($*$ -representation) of the loop algebra \mathcal{L}_n acting on a finite dimensional space \mathcal{H} . The algebra generated by the matrix elements of U_C is isomorphic to $U_q(\mathfrak{g})$, therefore $U_q(\mathfrak{g})$ acts on \mathcal{H} . ρ can be restricted to the subalgebra $\mathcal{L}_n^{U_q(\mathfrak{g})}$ and acts on the subspace of invariants $\mathcal{H}^{U_q(\mathfrak{g})} = H$. The ideal \mathcal{I}_C is shown to be annihilated, as a result one obtains by this procedure a unitary representation of the moduli algebra. This representation can be shown to be unique up to equivalence. Note that this construction is however implicit in the sense that no explicit formulae for the action of an element of $M_q(\Sigma, G)$ is given in a basis of $\mathcal{H}^{U_q(\mathfrak{g})}$. In this brief exposition we have oversimplified the picture: q being a root of unity the formalism of weak quasi-Hopf algebras has to be used.

We will modify this construction in order to handle the $SL(2, \mathbb{C})_{\mathbb{R}}$ case. The construction of the moduli algebra in this case is straightforward and is parallel to the construction in the compact case. One defines the graph algebra \mathcal{L}_n , generated by the

matrix elements of the $2n$ quantum $SL(2, \mathbb{C})_{\mathbb{R}}$ holonomies around the non trivial cycles a_i, b_i . This is a non commutative algebra on which $U_q(sl(2, \mathbb{C})_{\mathbb{R}})$ acts. We have chosen q real, in complete agreement with the choice of the real invariant bilinear form on $SL(2, \mathbb{C})_{\mathbb{R}}$ used to represent the $2+1$ gravity action with positive cosmological constant as a Chern-Simons action. One defines similarly $M_q(\Sigma, SL(2, \mathbb{C})_{\mathbb{R}}) = \mathcal{L}_n^{U_q(sl(2, \mathbb{C})_{\mathbb{R}})} / \mathcal{I}_C$ which is a non commutative $*$ -algebra, quantization of the space of functions on the moduli space of flat- $SL(2, \mathbb{C})_{\mathbb{R}}$ connections. Although one can generalize the first step of the construction of [4], i.e constructing unitary representations of \mathcal{L}_n acting on an Hilbert space \mathcal{H} , it is not possible to construct a unitary representation of $M_q(\Sigma, SL(2, \mathbb{C})_{\mathbb{R}})$ by acting on $\mathcal{H}^{U_q(sl(2, \mathbb{C})_{\mathbb{R}})}$. Indeed, there is no vector (of finite norm), except 0, in the Hilbert space \mathcal{H} which is invariant under the action of $U_q(sl(2, \mathbb{C})_{\mathbb{R}})$. This is a typical example of the fact that the volume of the gauge group is infinite (here it comes from the non compactness of $SL(2, \mathbb{C})_{\mathbb{R}}$). To circumvent this problem we use and adapt the formalism of [4] to directly construct a representation of $M_q(\Sigma, SL(2, \mathbb{C})_{\mathbb{R}})$ by acting on a vector space H . In a nutshell, $M_q(\Sigma, SL(2, \mathbb{C})_{\mathbb{R}})$ is generated by spin network colored by finite dimensional representations, whereas vectors in H are integral of spin networks colored by principal representations of $U_q(sl(2, \mathbb{C})_{\mathbb{R}})$. We give explicit formulae for the action of $M_q(\Sigma, SL(2, \mathbb{C})_{\mathbb{R}})$ on H , we endow this space with a structure of Hilbert space and show that the representation is unitary. Our approach uses as central tools the harmonic analysis of $U_q(sl(2, \mathbb{C})_{\mathbb{R}})$ and an explicit construction of Clebsch-Gordan coefficients of principal representations of $U_q(sl(2, \mathbb{C})_{\mathbb{R}})$, which have been developed in [12, 14].

Note that Nelson and Regge have previously succeeded to construct unitary representation of the Moduli algebra in the case of genus one in [21] and in the genus 2 case in the $SL(2, \mathbb{R})$ case in [22]. Our method works for any punctured surface of arbitrary genus and, despite certain technical points which have been mastered, is very natural. It is a non trivial implementation of the concept of refined algebraic quantization developed in [7].

II. Summary of the Combinatorial Quantization Formalism: the compact group case.

Chern-Simons theory with gauge group $G = SU(2)$ is defined on a 3-dimensional compact oriented manifold M by the action

$$S(A) = \frac{\lambda}{4\pi} \int_M \text{Tr}(A \wedge dA + \frac{2}{3} A \wedge A \wedge A) \ , \quad (1)$$

where the gauge field $A = A_\mu dx^\mu$ and Tr is the Killing form on $\mathfrak{g} = \mathfrak{su}(2)$. In the sequel we will investigate the case where Chern-Simons theory has an hamiltonian formulation. We will therefore assume that the manifold $M = \Sigma \times \mathbb{R}$, where the real line can be thought as being the time direction and Σ is a compact oriented surface and we will write $A = A_0 dt + A_1 dx^1 + A_2 dx^2$. In the action (1) A_0 appears as a Lagrange multiplier. Preserving the gauge choice $A_0 = 0$ enforces the first class constraint

$$F_{12}(A) = \partial_1 A_2 - \partial_2 A_1 + [A_1, A_2] = 0. \quad (2)$$

The space $\mathcal{A}(\Sigma, G)$ of G -connections on Σ is an infinite dimensional affine symplectic space with Poisson bracket:

$$\{A_i(x) \otimes A_j(y)\} = \frac{2\pi}{\lambda} \delta(x-y) \epsilon_{ij} t, \quad (3)$$

where $t \in \mathfrak{g} \otimes \mathfrak{g}$ is the Casimir tensor associated to the non-degenerate bilinear form Tr defined by $t = \sum_{a,b} (\eta^{-1})^{ab} T_a \otimes T_b$ where T_a is any basis of \mathfrak{g} , $\eta_{ab} = \text{Tr}(T_a T_b)$ and $i, j \in \{1, 2\}$.

The constraint (2) generates gauge transformations

$${}^g A = g A g^{-1} + dg g^{-1}, \forall g \in C^\infty(\Sigma, G). \quad (4)$$

As a result, the classical phase space of this theory consists of the moduli space of flat G -bundles on the surface Σ modulo the gauge transformations and has been studied in [8].

In order that $\exp(iS(A))$ is gauge invariant under large gauge transformations, λ has to be an integer.

The moduli space of flat connections $M(\Sigma, G)$ is defined using an infinite dimensional version of Hamiltonian reduction, i.e $M(\Sigma, G) = \{A \in \mathcal{A}(\Sigma, G), F(A) = 0\} / \mathcal{G}$ where the group \mathcal{G} is the group of gauge transformations. The quantization of this space can follow two paths: quantize before applying the constraints or quantize after applying the constraints. The approach of Nelson Regge aims at developing the latter but it is cumbersome. We can take advantage of the fact that $M(\Sigma, G)$ is finite dimensional to replace the gauge theory on Σ by a lattice gauge theory on Σ following Fock-Rosly's idea [18]. This method aims at quantizing before applying the constraints but in a finite dimensional framework.

This framework can be generalized to the case of a topological surface Σ with punctures P_1, \dots, P_p . If A is a flat connection on a punctured surface one denotes by $H_x(A)$ the conjugacy class of the holonomy around a small circle centered in x . One chooses $\sigma_1, \dots, \sigma_p$ conjugacy classes in G and defines $M(\Sigma, G; \sigma_1, \dots, \sigma_p) = \{A \in \mathcal{A}(\Sigma, G), F(A) = 0, H_{P_i}(A) = \sigma_i\} / \mathcal{G}$ where the group \mathcal{G} is the group of gauge transformations. The symplectic structure on this space is well analyzed in [6].

II.1. Fock-Rosly description of the moduli space of flat connections.

Functions on $M(\Sigma, G)$, also called observables, are gauge invariant functions on $\{A \in \mathcal{A}(\Sigma, G), F(A) = 0\}$. Wilson loops are examples of observables, and are particular examples of the following construction which associates to any spin-network an observable. Let us consider an oriented graph on Σ , this graph consists in a set of oriented edges (generically denoted by l) which meet at vertices (generically denoted by x). Let $<$ be a choice of an order on the set of oriented edges.

It is convenient to introduce the notations $d(l)$ and $e(l)$ respectively for the departure point and the end point of an oriented edge l .

A spin network associated to an oriented graph on Σ consists in two data:

- a coloring of the set of oriented edges i.e each oriented edge l is associated to a finite dimensional module V_l of the algebra \mathfrak{g} . We denote by π_l the representation associated to V_l . For any l and x we define $V_{(l,x)}^+ = V_l$ if $e(l) = x$ and $V_{(l,x)}^+ = \mathbb{C}$ elsewhere, as well as $V_{(l,x)}^- = V_l^*$ if $d(l) = x$ and $V_{(l,x)}^- = \mathbb{C}$ elsewhere.
- a coloring of the vertices i.e each vertex is associated to an intertwiner $\phi_x \in \text{Hom}_{\mathfrak{g}}(\otimes_l^< (V_{(l,x)}^+ \otimes V_{(l,x)}^-), \mathbb{C})$.

To each spin network \mathcal{N} we can associate a function on $M(\Sigma, G)$, as follows: let $U_l(A) = \pi_l(\overleftarrow{P} \exp \int_l A)$, and define

$$f_{\mathcal{N}}(A) = (\otimes_x \phi_x)(\otimes_l^< U_l(A)) \quad (5)$$

where we have identified $V_l \otimes V_l^*$ with $\text{End}(V_l)$.

The Poisson structure on $M(\Sigma, G)$, can be neatly described in terms of the functions $f_{\mathcal{N}}$ as first understood by Goldman [19]. Given two spin-networks $\mathcal{N}, \mathcal{N}'$ such that their associated graphs are in generic position, we have

$$\{f_{\mathcal{N}}, f_{\mathcal{N}'}\} = \frac{2\pi}{\lambda} \sum_{x \in \mathcal{N} \cap \mathcal{N}'} f_{\mathcal{N} \cup_x \mathcal{N}'} \epsilon_x(\mathcal{N}; \mathcal{N}') \quad , \quad (6)$$

where the graph $\mathcal{N} \cup_x \mathcal{N}'$ is defined to be the union of \mathcal{N} and \mathcal{N}' with the additional vertex x associated to the intertwiner $P_{12}t_{12} : V \otimes V' \rightarrow V' \otimes V$ (which can be viewed as an element of $\text{Hom}(V \otimes V' \otimes V^* \otimes V'^*; \mathbb{C})$) and where the sign $\epsilon_x(\mathcal{N}; \mathcal{N}') = \pm 1$ is the index of the intersection of the two graphs at the vertex x . Quantizing directly this Poisson structure is too complicated (see however [21, 26]). We will explain now Fock-Rosly's construction and the definition of the combinatorial quantization of the moduli space $M_q(\Sigma, G)$.

Finite dimensional representations of G are classified by a positive half integer $I \in \frac{1}{2}\mathbb{N}$, and we will denote V^I the associated module with representation $\frac{I}{\pi}$.

Let Σ be a surface of genus n , with p punctures associated to a conjugacy class $\sigma_i, i = 1, \dots, p$ of G . Fock-Rosly's idea amounts to replace the surface by an oriented fat graph \mathcal{T} drawn on it and the space of connections on Σ by the space of holonomies on this fat graph. We assume that the surface is divided by the graph into plaquettes such that either this plaquette is contractible or contains a unique puncture. Let us denote \mathcal{T}^0 the set of vertices of the graph, \mathcal{T}^1 the set of edges and \mathcal{T}^2 the set of faces.

The orientation of the surface induces at each vertex x a cyclic order on the set of edges L_x incident to x .

We can now introduce the space of discrete connections, which is an equivalent name for lattice gauge field on \mathcal{T} . The space of discrete connections $\mathcal{A}(\mathcal{T})$ on the surface Σ is defined as

$$\mathcal{A}(\mathcal{T}) = \{U(l) \in G ; l \in \mathcal{T}^1\} \quad (7)$$

and the group of gauge transformations $G^{\mathcal{T}^0}$ acts on the discrete connections as follows:

$$U(l)^g = g(e(l)) U(l) g(d(l))^{-1} \quad , \forall g \in G^{\mathcal{T}^0} . \quad (8)$$

The discrete connections can be viewed as functionals of the connection $A \in \mathcal{A}(\Sigma, G)$ as $U(l) = \overleftarrow{P} \exp \int_l A$. If $f \in \mathcal{T}^2$, let $U(f)$ be the conjugacy class of $\prod_{l \in \partial f} U(l)$. For each $f \in \mathcal{T}^2$, we denote $\sigma_f = 1$ if f is contractible and $\sigma_f = \sigma_i$ if f contains the puncture P_i . The group $G^{\mathcal{T}^0}$ has a natural Lie-Poisson structure:

$$\{g_1^I(x) , g_2^J(x)\} = \frac{2\pi}{\lambda} [r_{12}^{IJ} , g_1^I(x) g_2^J(x)] , \quad (9)$$

$$\{g_1^I(x) , g_2^J(y)\} = 0 \text{ if } x \neq y , \quad (10)$$

where we have used the notations

$$g_1^I(x) = g^I(x) \otimes \mathbf{1}^J , g_2^J(x) = \mathbf{1}^I \otimes g^J(x) , \quad (11)$$

and $g^I(x) \in \text{End}(\overset{I}{V}) \otimes F(G)_x$ ($F(G)_x$ being the functions on the group at the vertex x), $r \in \mathfrak{g}^{\otimes 2}$ is a classical r-matrix which satisfies the classical Yang-Baxter equation and $r_{12} + r_{21} = t_{12}$.

Fock and Rosly [18] have introduced a Poisson structure on the functions on $\mathcal{A}(\mathcal{T})$ denoted $\{, \}_{FR}$ such that the gauge transformation map

$$G^{\mathcal{T}^0} \times \mathcal{A}(\mathcal{T}) \rightarrow \mathcal{A}(\mathcal{T}) \quad (12)$$

is a Poisson map.

Note however that this Poisson structure is not canonical and depends on an additional item (called in their paper a ciliation), which is a linear order $<_x$ compatible with the cyclic order defined on the set of edges incident to the vertex x .

We shall give here the Poisson structure on the space of discrete connections in the case where \mathcal{T} is a triangulation:

$$\{\overset{I}{U}_1(l) , \overset{J}{U}_2(l')\}_{FR} = \frac{2\pi}{\lambda} (r_{12}^{IJ} \overset{I}{U}_1(l) \overset{J}{U}_2(l')) , \text{ if } e(l) = e(l') = x \text{ and } l <_x l' \quad (13)$$

$$\{\overset{I}{U}_1(l) , \overset{J}{U}_2(l)\}_{FR} = \frac{2\pi}{\lambda} (r_{12}^{IJ} \overset{I}{U}_1(l) \overset{J}{U}_2(l) + \overset{I}{U}_1(l) \overset{J}{U}_2(l) r_{21}^{IJ}) , \quad (14)$$

$$\{\overset{I}{U}_1(l) , \overset{J}{U}_2(l')\}_{FR} = 0 \text{ if } l \cap l' = \emptyset , \quad (15)$$

the other relations can be deduced from the previous ones using the relation $U(-l)U(l) = 1$.

The moduli space can be described as: $M(\Sigma, G, \sigma_1, \dots, \sigma_p) = \{\mathcal{A}(\mathcal{T}), U(f) = \sigma_f, f \in \mathcal{T}^2\} / G^{\mathcal{T}^0}$. The major result of [18] is that the Poisson structure $\{, \}_{FR}$ descends to this quotient, is not degenerate, independent of the choice of the fat graph and on the

ciliation and is the Poisson structure associated to the canonical symplectic structure on $M(\Sigma, G; \sigma_1, \dots, \sigma_p)$.

A quantization of Fock-Rosly Poisson bracket has been analyzed in [2, 3, 10]. In order to give a sketch of this construction we will first recall standard results on quantum groups.

II.2. Basic notions on quantum groups.

Basic definitions and properties of the quantum envelopping algebra $U_q(\mathfrak{g})$ where $\mathfrak{g} = su(2)$ are recalled in the appendix A.1. $U_q(\mathfrak{g})$ is a quasi-triangular ribbon Hopf-algebra with counit $\epsilon : U_q(\mathfrak{g}) \rightarrow \mathbb{C}$, coproduct $\Delta : U_q(\mathfrak{g}) \rightarrow U_q(\mathfrak{g})^{\otimes 2}$ and antipode $S : U_q(\mathfrak{g}) \rightarrow U_q(\mathfrak{g})$. For a review on quantum groups, see [16]. The universal R-matrix R is an element of $U_q(\mathfrak{g})^{\otimes 2}$ denoted by $R = \sum_i x_i \otimes y_i = R^{(+)}$. It is also convenient to introduce $R' = \sum_i y_i \otimes x_i$ and $R^{(-)} = R'^{-1}$. Let $u = \sum_i S(y_i) x_i$, $uS(u)$ is in the center of $U_q(\mathfrak{g})$ and there exists a central element v (the ribbon element) such that $v^2 = uS(u)$. We will define the group-like element $\mu = q^{2Jz}$.

Finite dimensional irreducible representations $\overset{I}{\pi}$ of $U_q(\mathfrak{g})$ are labelled by $I \in \frac{1}{2}\mathbb{N}$ and let us define $\overset{I}{V}$ the associated module. The tensor product $\overset{I}{\pi} \otimes \overset{J}{\pi}$ of two representations is decomposed into irreducible representations $\overset{K}{\pi}$

$$\overset{I}{\pi} \otimes \overset{J}{\pi} = \sum_K N_K^{IJ} \overset{K}{\pi}, \quad (16)$$

where the integers $N_K^{IJ} \in \{0, 1\}$ are the multiplicities. For any representations $\overset{I}{\pi}, \overset{J}{\pi}, \overset{K}{\pi}$, we define the Clebsch-Gordan maps Ψ_{IJ}^K (resp. Φ_K^{IJ}) as a basis of $Hom_{U_q(\mathfrak{g})}(\overset{I}{V} \otimes \overset{J}{V}, \overset{K}{V})$ (resp. $Hom_{U_q(\mathfrak{g})}(\overset{K}{V}, \overset{I}{V} \otimes \overset{J}{V})$). These basis can always be chosen such that:

$$N_K^{IJ} \Psi_{IJ}^L \Phi_K^{IJ} = N_K^{IJ} \delta_K^L id_V, \quad \sum_K \Phi_K^{IJ} \Psi_{IJ}^K = id_{\overset{I}{V} \otimes \overset{J}{V}}. \quad (17)$$

For any finite dimensional representation I , we will define the quantum trace of an element $M \in End(\overset{I}{V})$ as $tr_q(M) = tr_{\overset{I}{V}}(\overset{I}{\mu} M)$. The element $c_I = tr_q((\overset{I}{\pi} \otimes id)(RR'))$ is a central element of $U_q(\mathfrak{g})$. For any finite dimensional representation I and for any irreducible module V associated to the representation π (not necessarily of finite dimension), we will denote by $\vartheta_{I\pi}$ the complex number defined by $\pi(c_I) = \vartheta_{I\pi} id_V$. For $\mathfrak{g} = su(2)$, $\vartheta_{IJ} = \vartheta_{\overset{I}{\pi}\overset{J}{\pi}} = \frac{[(2I+1)(2J+1)]}{[2I+1][2J+1]}$ where $I, J \in \frac{1}{2}\mathbb{N}$ label irreducible representations of $U_q(su(2))$ and quantum numbers $[x]$ is defined in the appendix.

Let us denote by $\{e_i^I \mid i = 1 \dots \dim \overset{I}{V}\}$ a particular basis of $\overset{I}{V}$ and $\{e^i \mid i = 1 \dots \dim \overset{I}{V}\}$ its dual basis. By duality, the space $Pol_q(G)$ of polynomials on the quantum group inherits a structure of Hopf-algebra. It is generated as a vector space by the

coefficients of the representations $\overset{I}{\pi}$, which will be denoted by $\overset{I}{g}_b^a = \langle \overset{I}{e}^a | \overset{I}{\pi}(\cdot) | \overset{I}{e}_b \rangle$. To simplify the notations, we define $\overset{I}{g} = \sum_{a,b} \overset{I}{E}_a^b \otimes \overset{I}{g}_b^a \in \text{End}(\overset{I}{V}) \otimes \text{Pol}_q(G)$ where the elements $\{\overset{I}{E}_a^b\}_{a,b}$ is the canonical basis of $\text{End}(\overset{I}{V})$. By a direct application of the definitions, we have the fusion relations

$$\overset{I}{g}_1 \overset{J}{g}_2 = \sum_K \Phi_K^{IJ} \overset{K}{g} \Psi_{IJ}^K, \quad (18)$$

which imply the exchange relations $\overset{IJ}{R}_{12} \overset{I}{g}_1 \overset{J}{g}_2 = \overset{J}{g}_2 \overset{I}{g}_1 \overset{IJ}{R}_{12}$, where $\overset{IJ}{R}_{12} = (\overset{I}{\pi} \otimes \overset{J}{\pi})(R) \in \text{End}(\overset{I}{V}) \otimes \text{End}(\overset{J}{V})$.

The coproduct is

$$\Delta(\overset{I}{g}_b^a) = \sum_c \overset{I}{g}_c^a \otimes \overset{I}{g}_b^c. \quad (19)$$

Up to this point, it is possible to give a presentation, of FRT type, of the defining relations of $U_q(\mathfrak{g})$. Let us introduce, for each representation I , the element $\overset{I}{L}^{(\pm)} \in \text{End}(\overset{I}{V}) \otimes U_q(\mathfrak{g})$ defined by $\overset{I}{L}^{(\pm)} = (\overset{I}{\pi} \otimes id)(R^{(\pm)})$. The duality bracket is given by

$$\langle \overset{I}{L}_1^{(\pm)}, \overset{J}{g}_2 \rangle = \overset{IJ}{R}_{12}^{(\pm)}. \quad (20)$$

These matrices satisfy the relations:

$$\overset{I}{L}_1^{(\pm)} \overset{J}{L}_2^{(\pm)} = \sum_K \Phi_K^{IJ} \overset{K}{L}^{(\pm)} \Psi_{IJ}^K, \quad (21)$$

$$\overset{IJ}{R}_{12}^{(\pm)} \overset{I}{L}_1^{(+)} \overset{J}{L}_2^{(-)} = \overset{J}{L}_2^{(-)} \overset{I}{L}_1^{(+)} \overset{IJ}{R}_{12}^{(\pm)}, \quad (22)$$

$$\Delta(\overset{I}{L}^{(\pm)a}_b) = \sum_c \overset{I}{L}^{(\pm)c}_b \otimes \overset{I}{L}^{(\pm)a}_c. \quad (23)$$

The first fusion equation implies the exchange relations

$$\overset{IJ}{R}_{12} \overset{I}{L}_1^{(\pm)} \overset{J}{L}_2^{(\pm)} = \overset{J}{L}_2^{(\pm)} \overset{I}{L}_1^{(\pm)} \overset{IJ}{R}_{12}. \quad (24)$$

II.3. Combinatorial Quantization of the moduli space of flat connections.

We are now ready to define a quantization of the space of flat connections along the lines of [2]. Because this construction can be shown to be independent of the choice of ciliated fat graph, we will choose a specific graph, called standard graph, which is shown in figure 1.

This graph consists in one vertex x , $p+1$ 2-cells and $2n+p$ 1-cells. The $2n+p$ 1-cells are given with the orientation and the order $<$ of the picture.

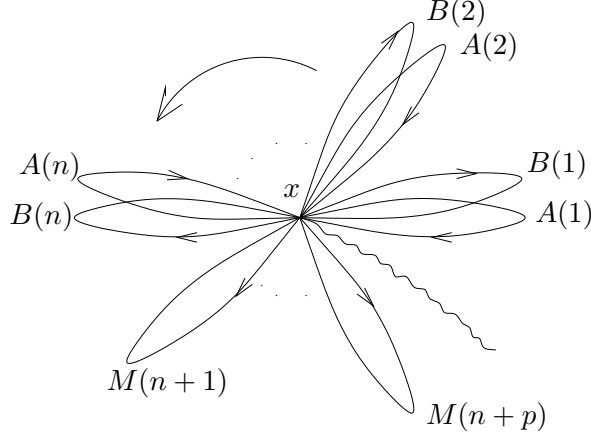

Figure 1: Standard Graph.

The space of discrete connections on this graph consists in the holonomies $\{M(j) \mid j = n+1, \dots, n+p\}$ around the punctures and the holonomies $\{A(i), B(i) \mid i = 1, \dots, n\}$ around the handles. We can choose the associated curves in such a way that they have the same base point x on the surface.

We associate to this graph \mathcal{T} a quantization of the Fock-Rosly Poisson structure on the space of discrete connections on \mathcal{T} as follows:

Definition 1 (Alekseev-Grosse-Schomerus)[2] *The graph algebra $\mathcal{L}_{n,p}$ is an associative algebra generated by the matrix elements of $(A(i))_{i=1, \dots, n}$, $(B(i))_{i=1, \dots, n}$, $(M(i))_{i=n+1, \dots, n+p} \in \text{End}(\overset{I}{V}) \otimes \mathcal{L}_{n,p}$ and satisfying the relations:*

$$\overset{I}{U}_1(i) \overset{IJ}{R'} \overset{J}{U}_2(i) \overset{IJ}{R}{}^{(-)} = \sum_K \Phi_K^{IJ} \overset{K}{U}(i) \Psi_{IJ}^K \quad (\text{Loop Equation}) \quad \forall i, \quad (25)$$

$$\overset{IJ}{R} \overset{I}{U}_1(i) \overset{IJ}{R}{}^{-1} \overset{J}{U}_2(j) = \overset{J}{U}_2(j) \overset{IJ}{R} \overset{I}{U}_1(i) \overset{IJ}{R}{}^{-1} \quad \forall i < j, \quad (26)$$

$$\overset{IJ}{R} \overset{I}{A}_1(i) \overset{IJ}{R'} \overset{J}{B}_2(i) = \overset{J}{B}_2(i) \overset{IJ}{R} \overset{I}{A}_1(i) \overset{IJ}{R}{}^{-1} \quad \forall i, \quad (27)$$

where $U(i)$ is indifferently $A(i)$, $B(i)$ or $M(i)$. The relations are chosen in such a way that the co-action δ :

$$\begin{aligned} \delta : \mathcal{L}_{n,p} &\rightarrow F_q(G) \otimes \mathcal{L}_{n,p} \\ \overset{I}{U}(i)_b^a &\mapsto \sum_{c,d} \overset{I}{g}_c^a S(\overset{I}{g}_b^d) \otimes \overset{I}{U}(i)_d^c = (\overset{I}{g} \overset{I}{U}(i) S(\overset{I}{g}))_b^a \end{aligned} \quad (28)$$

is a morphism of algebra.

This last property is the quantum version of the fact that the map (28) is a Poisson map. Equivalently the coaction δ provides a right action of $U_q(\mathfrak{g})$ on $\mathcal{L}_{n,p}$ as follows:

$$\forall a, b \in \mathcal{L}_{n,p}, \forall \xi \in U_q(\mathfrak{g}), (ab)^\xi = a^{\xi(1)} b^{\xi(2)}, \quad (29)$$

$$\overset{I}{U}(i)^\xi = \overset{I}{\pi}(\xi(1)) \overset{I}{U}(i) \overset{I}{\pi}(S(\xi(2))), \quad (30)$$

where $U(i)$ is indifferently $A(i), B(i)$ or $M(i)$.

Let us notice that, from (25), $\overset{I}{U}(i)$ admits an inverse matrix $\overset{I}{U}(i)^{-1}$, see [2, 10].

The space of gauge invariant elements is the subspace of coinvariant elements of $\mathcal{L}_{n,p}$ i.e $\mathcal{L}_{n,p}^{inv} = \{a \in \mathcal{L}_{n,p}, \delta(a) = 1 \otimes a\}$. This is an algebra because δ is a morphism of algebra.

In $\mathcal{L}_{n,p}^{inv}$ we still have to divide out by the flatness condition, i.e the quantum version of the fact that the holonomies on contractible curves are trivial and that around punctures they belong to a fixed conjugacy class. Let us define

$$\overset{I}{C} = \overset{I}{G}(1) \cdots \overset{I}{G}(n) \cdot \overset{I}{M}(n+1) \cdots \overset{I}{M}(n+p) \quad (31)$$

where $\overset{I}{G}(i) = v_I^2 \overset{I}{A}(i) \overset{I}{B}(i)^{-1} \overset{I}{A}(i)^{-1} \overset{I}{B}(i)$. The elements $\overset{I}{C}$ satisfy the loop equation (25). We will denote by \mathcal{C} the subalgebra of $\mathcal{L}_{n,p}$ generated by the matrix elements of $\overset{I}{C}, \forall I$. It can be shown that $tr_q(\overset{I}{C})$ and $tr_q(\overset{I}{M}(i)), i = n+1, \dots, n+p$ are central elements of the algebra $\mathcal{L}_{n,p}^{inv}$.

We would like first to divide out by the relation $\overset{I}{C} = 1$.

An annoying fact is that the matrix elements of $\overset{I}{C} - 1$ do not belong to $\mathcal{L}_{n,p}^{inv}$. As a result in order to divide out by this relation we have to slightly modify the picture.

Let I be a finite dimensional representation of $U_q(\mathfrak{g})$ and let $\mathcal{J}_I \subset \mathcal{L}_{n,p} \otimes End(\overset{I}{V})$ such that $X \in \mathcal{J}_I$ if and only if $X = \sum_{a,b} X_b^a \otimes E_a^b$ with $\delta(X_b^a) = \sum_{a',b'} g_{a'}^a X_{b'}^{a'} S(g_b^{b'})$.

For any $Y \in \mathcal{J}_I$ we define the invariant element $\langle Y(\overset{I}{C} - 1) \rangle = \sum_{a,b} \overset{I}{\mu}^{bb} Y_a^b (\overset{I}{C}_b^a - \delta_b^a)$.

Let \mathcal{I}_C be the ideal of $\mathcal{L}_{n,p}^{inv}$ generated by the elements $\langle Y(\overset{I}{C} - 1) \rangle$ where I is any finite dimensional representation of $U_q(\mathfrak{g})$ and Y is any element of \mathcal{J}_I .

Definition 2 We define $\mathfrak{M}_q(\Sigma, G, p)$ to be the algebra $\mathcal{L}_{n,p}^{inv} / \mathcal{I}_C$. When there is no puncture this is the Moduli algebra of [2], and we will write in this case $M_q(\Sigma, G) = \mathfrak{M}_q(\Sigma, G, p = 0)$.

In the case of punctures a quantization of the coadjoint orbits is necessary. This is also completely consistent with quantization of Chern-Simons theory, where punctures are associated to vertical lines colored by representations of the group G .

Definition 3 Let π_1, \dots, π_p be the representations associated to the vertical lines coloring the punctures. We can define, following [2], the moduli algebra $M_q(\Sigma, G, \pi_1, \dots, \pi_p) = \mathfrak{M}_q(\Sigma, G, p) / \{tr_q(\overset{I}{M}(n+i)) = \vartheta_{I\pi_i}, i = 1, \dots, p, \forall I\}$.

In order to introduce a generating family of gauge invariant elements we have to define the notion of quantum spin-network. The definition of this object is the same as in the classical case except that the coloring of the edges are representations of $U_q(\mathfrak{g})$ and that the coloring of the vertices are $U_q(\mathfrak{g})$ -intertwiners. To each quantum spin-network one associates an element of $M_q(\Sigma, G)$ by the same equation as (5), the order $<$ is now essential because it orders non commutative holonomies in the tensor product.

In the following proposition, we will construct an explicit basis of the vector space $\mathcal{L}_{n,p}^{inv}$ labelled by quantum spin networks. This will provide, after moding out by the relations defining the moduli algebra, a generating family of this algebra.

We will need the following notations: if $L = (L_1, \dots, L_r)$ and $L' = (L'_1, \dots, L'_s)$ are sequences, we denote LL' to be the sequence $(L_1, \dots, L_r, L'_1, \dots, L'_s)$. If L is a sequence we denote $L_{<j} = (L_1, \dots, L_{j-1})$. If $L = (L_1, \dots, L_r)$ is a finite sequence of irreducible representations of $U_q(\mathfrak{g})$ we denote $V(L) = \otimes_{j=1}^r V^{L_j}$ and we will denote

$$R^{NL(\pm)} = R^{NL_1(\pm)} \dots R^{NL_r(\pm)} .$$

For W an irreducible representation of $U_q(\mathfrak{g})$ and $S = (S_3, \dots, S_r)$ a $(r-2)$ -uplet of irreducible representations of $U_q(\mathfrak{g})$, we define the intertwiners:

$\Psi_L^W(S) \in Hom_{U_q(\mathfrak{g})}(V(L), V^W)$ by

$$\Psi_L^W(S) = \Psi_{S_r L_r}^W \dots \Psi_{S_3 L_3}^{S_4} \Psi_{L_1 L_2}^{S_3} \quad (32)$$

and $\Phi_W^L(S) \in Hom_{U_q(\mathfrak{g})}(V^W, V(L))$ defined by

$$\Phi_W^L(S) = \Phi_{S_3}^{L_1 L_2} \Phi_{S_4}^{S_3 L_3} \dots \Phi_W^{S_r L_r} . \quad (33)$$

Definition 4 We will define a ‘‘palette’’ as being a family $P = (I, J, N; K, L, U, T, W)$ where I, J, K, L (resp. N) (resp. U, T) are n -uplets (resp. p -uplets) (resp. $n+p-2$ -uplets) of irreducible finite dimensional representations of $U_q(\mathfrak{g})$ and W is an irreducible finite dimensional representations of $U_q(\mathfrak{g})$. Any palette P defines a unique quantum spin-network \mathcal{N}_P associated to the standard graph, precisely: (I, J, N) is coloring of the non contractible cycles $A(i), B(i), M(n+i)$ and (K, L, U, T, W) is associated to the intertwiner $\Psi_{IJN}^W(KU) \otimes \Phi_{LT}^{JJN}$ coloring the vertex of this spin-network.

We first define, for $i = 1, \dots, n$, $\theta(i) \in \mathcal{L}_{n,p} \otimes Hom(V^{L_i}, V^{K_i})$ by:

$$\theta(i) = \Psi_{J_i I_i}^{K_i} B(i) R'_{I_i}^{J_i I_i} A(i) R_{I_i(-)}^{J_i I_i(-)} \Phi_{L_i}^{J_i I_i} .$$

We can now associate to I, J, K, L the element $\theta_n^{I,J(\pm)}(K, L) \in \mathcal{L}_{n,p} \otimes Hom(V(L), V(K))$ by

$$\theta_n^{I,J(\pm)}(K, L) = \prod_{j=1}^n (R^{(\pm)} \theta(j)). \quad (34)$$

We associate to N the element of $\mathcal{L}_{n,p} \otimes \text{Hom}(V(N), V(N))$

$$\theta_p^N(\pm) = \prod_{j=1}^p (R^{(\pm)} M^{N_j}(n+j)). \quad (35)$$

We can introduce the elements of $\mathcal{L}_{n,p} \otimes \text{Hom}(V(LN), V(KN))$

$$\Omega_{n,p}^{I,J,N(\pm)}(K, L) = \theta_n^{I,J(\pm)}(K, L) \left(\prod_{j=1}^p R^{(\pm)} \right)^{N_j L} \theta_p^N(\pm) \left(\prod_{j=1}^{n+p} R^{(\pm)} \right)^{(LN)_j(LN)_{<j}}. \quad (36)$$

Proposition 1 *Let P be a palette labelling a quantum spin network \mathcal{N}_P associated to the standard graph. We will define an element of $\mathcal{L}_{n,p}$*

$$\mathcal{O}_{n,p}^P(\pm) = \frac{v_K^{1/2}}{v_I^{1/2} v_J^{1/2}} \text{tr}_q(\Psi_{KN}^W(U) \Omega_{n,p}^{I,J,N(\pm)}(K, L) \Phi_W^{LN}(T)) \quad (37)$$

where we have defined $v_I^{1/2} = v_{I_1}^{1/2} \cdots v_{I_n}^{1/2}$.

The elements $\mathcal{O}_{n,p}^P(\pm)$ are gauge invariant elements and if $\epsilon \in \{+, -\}$ is fixed the nonzero elements of the family $\mathcal{O}_{n,p}^{P(\epsilon)}$ is a basis of $\mathcal{L}_{n,p}^{U_q(\mathfrak{g})}$ when P runs over all the palettes.

Proof: It is a simple consequence of

$$\delta(\Omega_{n,p}^{I,J,N(\pm)}(K, L)) = g(KN) \Omega_{n,p}^{I,J,N(\pm)}(K, L) S(g(LN)) \quad (38)$$

where $g(L) = g_1^{L_1} \cdots g_p^{L_p}$ and that $\text{tr}_q(\cdot)$ is invariant under the adjoint action. \square

Remarks.

1. The family $\mathcal{O}_{n,p}^P(+)$ can be linearly expressed in term of the family $\mathcal{O}_{n,p}^P(-)$, and the coefficients of these linear transformations can be exactly computed in terms of $6j$ coefficients.

2. The particular normalization of these families has been chosen in order to simplify the action of the star on these elements (see next section).

We will denote also by the same notation the image of $\mathcal{O}_{n,p}^P(\pm)$ in the quantum moduli space $M_q(\Sigma, G, \pi_1, \cdots, \pi_p)$.

Example.

In the case where the surface is a torus with no puncture ($n = 1$ and $p = 0$), the spin-networks are labelled by the colors IJ of the two non-contractible cycles and the choice of the intertwiner is fixed by a finite dimensional representation W . As a result the vector space of gauge invariant functions $\mathcal{L}_{1,0}^{inv}$ is linearly generated by the following observables:

$$\mathcal{O}_{1,0}^{IJW} = \frac{v_W^{1/2}}{v_I^{1/2}v_J^{1/2}} tr_q(\Psi_{JI}^W \begin{matrix} J & JI \\ B & R' \end{matrix} \begin{matrix} I & JI \\ A & R^{(-)} \end{matrix} \Phi_{W}^{JI}) , \quad (39)$$

for all finite dimensional representations IJW . The Moduli algebra is generated as an algebra by the Wilson loops around the handles in the fundamental representation, i.e.

$$W_A = tr_q(A^I) , W_B = tr_q(B^I) \text{ where } I = \frac{1}{2}. \quad (40)$$

II.4 Alekseev's Isomorphisms Theorem

The construction of the representation theory of $\mathcal{L}_{n,p}$ uses Alekseev's method [2, 3, 5]: we first build representations of $\mathcal{L}_{0,p}$ (the multi-loop algebra), then we build representations of $\mathcal{L}_{n,0}$ (the multi-handle algebra) and we use these results to build representations of the graph algebra $\mathcal{L}_{n,p}$.

Lemma 1 *The algebra $\mathcal{L}_{0,p}$ is isomorphic to the algebra $U_q(\mathfrak{g})^{\otimes p}$.*

The algebra $\mathcal{L}_{0,p}$ is generated by the matrix elements of $M^I(i)$, $i = 1, \dots, p$, and the algebra $U_q(\mathfrak{g})^{\otimes p}$ is generated by the matrix elements of $L^I(j)^{(\pm)}$, $j = 1, \dots, p$, where the label j denotes one of the p copies of $U_q(\mathfrak{g})$. An explicit isomorphism in term of these generators can be constructed as follows:

$$\begin{aligned} \mathcal{L}_{0,p} \otimes End(\dot{V}) &\longrightarrow U_q(\mathfrak{g})^{\otimes p} \otimes End(\dot{V}) \\ M^I(i) &\mapsto \mathfrak{F}^I(i) \mathfrak{M}^I(i) \mathfrak{F}^I(i)^{-1} , \end{aligned} \quad (41)$$

where we have defined

$$\mathfrak{M}^I(i) = L^I(i)^{(+)} L^I(i)^{(-)-1} \quad , \quad \mathfrak{F}^I(i) = L^I(1)^{(-)} \dots L^I(i-1)^{(-)} . \quad (42)$$

Proof: See [5] \square

As an immediate consequence, the representations of the loop algebra $\mathcal{L}_{0,p}$ are those of $U_q(\mathfrak{g})^{\otimes p}$. A basis of the irreducible finite dimensional module labelled by J is denoted as usual by $(e_i^J | i = 1 \dots dim(\dot{V}))$. The action of the generators on this basis is given by:

$$L^I(\pm)_b^a \triangleright e_i^J = e_j^J R^I(\pm)_{bi}^{aj} . \quad (43)$$

From this relation and the explicit isomorphism of the lemma 1, it is easy to find out explicit expressions for the representations of $\mathcal{L}_{0,p}$ on the module $\dot{V}^{I_1} \otimes \dots \otimes \dot{V}^{I_p}$. In

particular, the action of $\overset{I}{M}(i)$ on the basis $\overset{I_1}{e}_{i_1} \otimes \cdots \otimes \overset{I_p}{e}_{i_p}$ is given in term of product of R-matrices.

The previous theorem can be modified in order to apply to the algebra $\mathcal{L}_{n,0}$. However, this algebra can not be represented as a direct product of several copies of $U_q(\mathfrak{g})$. An easy way to understand this point is to consider, for example, the center of each algebras. The loop algebra $\mathcal{L}_{0,1}$ admits a subalgebra generated by the $\overset{I}{W}(i) = tr_q(\overset{I}{M}(i))$ which are central elements. One can show that the center of the handle algebra $\mathcal{L}_{1,0}$ is trivial [2, 3]. To understand the representations of $\mathcal{L}_{n,0}$, we therefore have to introduce one more object: the Heisenberg double.

Definition 5 *Let A be a Hopf algebra (typically $U_q(\mathfrak{g})$) and A^* its dual. The Heisenberg double is an algebra defined as a vector space by*

$$H(A) = A \otimes A^* ;$$

the algebra law is defined by the following algebra morphisms

$$\begin{aligned} A &\hookrightarrow H(A) & ; & & A^* &\hookrightarrow H(A) \\ x &\mapsto x \otimes 1 & & & f &\mapsto 1 \otimes f \end{aligned}$$

and the exchange relations

$$xf = (x \otimes 1)(1 \otimes f) = x \otimes f = \sum_{(x),(f)} \langle x_{(1)}, f_{(2)} \rangle (1 \otimes f_{(1)})(x_{(2)} \otimes 1) , \quad (44)$$

where we have used Sweedler notation $\Delta(x) = \sum_{(x)} x_{(1)} \otimes x_{(2)}$.

In the case where $A = U_q(\mathfrak{g})$, the Heisenberg double may be seen as a quantization of $Fun(T^*G)$. So, we can interpret the elements of A^* as functions and those of A as derivations.

Proposition 2 *$H(A)$ admits a unique irreducible representation Π realized in the module A^* as follows:*

$$\begin{aligned} \Pi : H(A) &\longrightarrow End(A^*), \\ A^* \ni f &\mapsto m_f \quad / \quad m_f(g) = fg \quad , \forall g \in A^* \\ A \ni x &\mapsto \nabla_x \quad / \quad \nabla_x(g) = g_{(1)} \langle x, g_{(2)} \rangle \quad , \forall g \in A^*. \end{aligned}$$

In the case where $A = U_q(\mathfrak{g})$, $H(A)$ is generated as a vector space by $\overset{I(+)_a}{L}_b \overset{J(-)_c}{L}_d \otimes \overset{K}{g}_f^e$, and the exchange relations (44) take the simple form:

$$\overset{I(\pm)}{L}_1 \overset{J}{g}_2 = \overset{J}{g}_2 \overset{I(\pm)}{L}_1 \overset{IJ(\pm)}{R}_{12} . \quad (45)$$

In order to understand the relation between the multi-handle algebra and the Heisenberg double $H(U_q(\mathfrak{g}))$, it is convenient to introduce left derivations $\tilde{L}^I \in \text{End}(V^I) \otimes H(U_q(\mathfrak{g}))$:

$$\tilde{L}^I = v_7^2 \overset{I}{g} \overset{I}{L}^{(+)-1} \overset{I}{L}^{(-)} \overset{I}{g}^{-1} = \tilde{L}^{I(+)} \tilde{L}^{I(-)-1} , \quad (46)$$

where the last formula corresponds to the Gauss decomposition. As usual, left and right derivations commute with each other

$$\tilde{L}_1^{I(\epsilon)} \overset{J(\sigma)}{L}_2 = \overset{J(\sigma)}{L}_2 \tilde{L}_1^{I(\epsilon)} , \forall (\epsilon, \sigma) \in \{+, -\} , \quad (47)$$

and realize two independent embeddings of $U_q(\mathfrak{g})$ in $H(U_q(\mathfrak{g}))$. From the relations of the Heisenberg double, it is easy to show the following relations:

$$\tilde{L}_1^{I(\pm)} \overset{J}{L}_2^{(\pm)} = \sum_K \Phi_K^{IJ} \tilde{L}^{(\pm)K} \Psi_{IJ}^K , \quad (48)$$

$$\overset{IJ(\pm)}{R}_{12} \tilde{L}_1^{I(+)} \tilde{L}_2^{J(-)} = \tilde{L}_2^{J(-)} \tilde{L}_1^{I(+)} \overset{IJ(\pm)}{R}_{12} , \quad (49)$$

$$\overset{IJ(\pm)}{R}_{12} \tilde{L}_1^{I(\pm)} \overset{J}{g}_2 = \overset{J}{g}_2 \tilde{L}_1^{I(\pm)} . \quad (50)$$

The action of the elements $\tilde{L}_1^{I(\pm)}, \tilde{L}_1^{J(\pm)}, \overset{J}{g}_2$ through representation Π are expressed as:

$$\tilde{L}_1^{I(\pm)} \triangleright \overset{J}{g}_2 = \overset{J}{g}_2 \overset{IJ(\pm)}{R}_{12} , \tilde{L}_1^{J(\pm)} \triangleright \overset{J}{g}_2 = \overset{IJ(\pm)-1}{R}_{12} \overset{J}{g}_2 , \quad (51)$$

$$\overset{I}{g}_1 \triangleright \overset{J}{g}_2 = \overset{I}{g}_1 \overset{J}{g}_2 = \sum_K \Phi_K^{IJ} \overset{K}{g} \Psi_{IJ}^K . \quad (52)$$

The following lemma, due to Alekseev [5], describes the structure of $\mathcal{L}_{n,0}$:

Lemma 2 *The algebra $\mathcal{L}_{n,0}$ is isomorphic to the algebra $H(U_q(\mathfrak{g}))^{\otimes n}$.*

$$\begin{aligned} \mathcal{L}_{n,0} \otimes \text{End}(V^I) &\longrightarrow H(U_q(\mathfrak{g}))^{\otimes n} \otimes \text{End}(V^I) \\ \overset{I}{A}(i) &\mapsto \overset{I}{\mathfrak{H}}(i) \overset{I}{\mathfrak{A}}(i) \overset{I}{\mathfrak{H}}(i)^{-1} \\ \overset{I}{B}(i) &\mapsto \overset{I}{\mathfrak{H}}(i) \overset{I}{\mathfrak{B}}(i) \overset{I}{\mathfrak{H}}(i)^{-1} , \end{aligned}$$

where we have defined

$$\overset{I}{\mathfrak{A}}(i) = \overset{I}{L}(i)^{(+)} \overset{I}{g}(i) \overset{I}{L}(i)^{(-)-1} , \quad \overset{I}{\mathfrak{B}}(i) = \overset{I}{L}(i)^{(+)} \overset{I}{L}(i)^{(-)-1} , \quad (53)$$

$$\overset{I}{\mathfrak{H}}(i) = (\overset{I}{L}(1)^{(-)} \overset{I}{L}(1)^{(-)}) \dots (\overset{I}{L}(i-1)^{(-)} \overset{I}{L}(i-1)^{(-)}) . \quad (54)$$

Remark: this lemma can be used to build representations of the the multi-handle algebra $\mathcal{L}_{n,0}$. The two monodromies $\overset{I}{A}$ and $\overset{I}{B}$ act on the vector space $F_q(G)$ as follows:

$$\overset{I}{A}_1 \triangleright \overset{J}{g}_2 = \sum_{i,K} \overset{I}{x}_{i1} \Phi_K^{IJ} \overset{K}{g} \overset{K}{y}_i \Psi_{IJ}^K \overset{IJ}{R}'_{12} \quad , \quad \overset{I}{B}_1 \triangleright \overset{J}{g}_2 = \overset{J}{g}_2 \overset{IJ}{R}_{12} \overset{IJ}{R}'_{12} \quad , \quad (55)$$

where $R = \sum_i x_i \otimes y_i$. In the case of the multi-handle algebra, the action of the monodromies is given in term of product of R-matrices with Clebsh-Gordan maps.

The following lemma shows that the graph algebra $\mathcal{L}_{n,p}$ is isomorphic to $\mathcal{L}_{n,0} \otimes \mathcal{L}_{0,p}$. As a result, from the previous theorems, representations of the graph algebra $\mathcal{L}_{n,p}$ is constructed from the representations of the multi-loop algebra and the multi-handle algebra.

Lemma 3 *The algebra $\mathcal{L}_{n,p}$ is isomorphic to the algebra $H(U_q(\mathfrak{g}))^{\otimes n} \otimes U_q(\mathfrak{g})^{\otimes p}$, the isomorphism is given by*

$$\begin{aligned} \mathcal{L}_{n,p} \otimes \text{End}(\overset{I}{V}) &\longrightarrow H(U_q(\mathfrak{g}))^{\otimes n} \otimes U_q(\mathfrak{g})^{\otimes p} \otimes \text{End}(\overset{I}{V}) \\ \overset{I}{A}(i) &\mapsto \overset{I}{\mathfrak{K}}(i) \overset{I}{\mathfrak{A}}(i) \overset{I}{\mathfrak{K}}(i)^{-1} \\ \overset{I}{B}(i) &\mapsto \overset{I}{\mathfrak{K}}(i) \overset{I}{\mathfrak{B}}(i) \overset{I}{\mathfrak{K}}(i)^{-1} \quad , \\ \overset{I}{M}(n+i) &\mapsto \overset{I}{\mathfrak{K}}(n+i) \overset{I}{\mathfrak{M}}(n+i) \overset{I}{\mathfrak{K}}(n+i)^{-1} \quad , \end{aligned}$$

where we have defined

$$\overset{I}{\mathfrak{A}}(i) = \overset{I}{L}(i)^{(+)} \overset{I}{g}(i) \overset{I}{L}(i)^{(-)-1} \quad , \quad \overset{I}{\mathfrak{B}}(i) = \overset{I}{L}(i)^{(+)} \overset{I}{L}(i)^{(-)-1} \quad , \quad (56)$$

$$\overset{I}{\mathfrak{M}}(n+i) = \overset{I}{L}(n+i)^{(+)} \overset{I}{L}(n+i)^{(-)-1} \quad , \quad (57)$$

$$\overset{I}{\mathfrak{K}}(i) = \overset{I}{\mathfrak{H}}(i) \quad , \quad \overset{I}{\mathfrak{K}}(n+i) = \overset{I}{\mathfrak{H}}(n+1) \overset{I}{\mathfrak{F}}(i) \quad , \quad (58)$$

where $\overset{I}{\mathfrak{H}}(i)$ and $\overset{I}{\mathfrak{F}}(i)$ have already been introduced.

Let $\overset{I}{C}$ as defined by (31), it can easily be shown that:

$$\overset{I}{C} = \overset{I}{C}^{(+)} \overset{I}{C}^{(-)-1} \quad \text{with} \quad (59)$$

$$\overset{I}{C}^{(\pm)} = \prod_{j=1}^n \overset{I}{L}^{(\pm)}(j) \overset{I}{L}^{(\pm)}(j) \prod_{k=1}^p \overset{I}{L}^{(\pm)}(n+k). \quad (60)$$

From the relations (25) satisfied by $\overset{I}{C}$, one obtains that the algebra \mathcal{C} is isomorphic to $\mathcal{L}_{0,1}$ and hence to $U_q(\mathfrak{g})$. Let us denote by $i : U_q(\mathfrak{g}) \rightarrow \mathcal{C}$ the isomorphism of algebra defined by

$$i(\overset{I}{L}^{(\pm)-1}) = \overset{I}{C}^{(\pm)}.$$

An important property is that the adjoint action of \mathcal{C} on the graph algebra is equivalent to the action of $U_q(\mathfrak{g})$, namely we have:

$$i(\xi_{(1)}) a i(S(\xi_{(2)})) = a^\xi, \quad \forall a \in \mathcal{L}_{n,p}, \forall \xi \in U_q(\mathfrak{g}). \quad (61)$$

This last property follows easily from the relation

$${}^I C_1^{(\pm)} {}^J U_2(i) {}^I C_1^{(\pm)-1} = {}^{IJ} R_{12}^{(\pm)} {}^J U_2(i) {}^{IJ} R_{12}^{(\pm)-1}$$

where $U(i)$ is indifferently $A(i), B(i), M(i)$. Note that the classical property that the constraint (2) generates gauge transformation is turned into (61) after quantization.

Finally, the representation theory of the graph-algebra $\mathcal{L}_{n,p}$ is obtained from those of the quantum group $U_q(\mathfrak{g})$ and the Heisenberg double $H(U_q(\mathfrak{g}))$. If $I = (I_1, \dots, I_p)$ are irreducible $U_q(\mathfrak{g})$ -modules, $\mathcal{H}_{n,p}[I] = F_q(G)^{\otimes n} \otimes \overset{I_1}{V} \otimes \dots \otimes \overset{I_p}{V}$ are irreducible modules of $\mathcal{L}_{n,p}$ defining the representation denoted $\rho_{n,p}[I]$.

$\mathcal{H}_{n,p}[I]$ is also a $U_q(\mathfrak{g})$ -module associated to the representation $\rho_{n,p}[I] \circ i$. As a result the subset of invariant elements is the vector space $\mathcal{H}_{n,p}[I]^{U_q(\mathfrak{g})} = \{v \in \mathcal{H}_{n,p}[I], ({}^I C^{(\pm)} - 1) \triangleright v = 0\}$.

Proposition 3 (Alekseev) *The representation $\rho_{n,p}[I]$ of $\mathcal{L}_{n,p}$ restricted to $\mathcal{L}_{n,p}^{inv}$ leaves $\mathcal{H}_{n,p}[I]^{U_q(\mathfrak{g})}$ invariant. As a result one obtains a representation of $\mathcal{L}_{n,p}^{inv}$ acting on $\mathcal{H}_{n,p}[I]^{U_q(\mathfrak{g})} = H_{n,p}[I]$. This representation annihilates the ideal \mathcal{I}_C , therefore one obtains a representation of $\mathfrak{M}_q(\Sigma, G, p)$. Moreover $\rho_{n,p}[I]$ annihilates the ideals generated by the relations $tr_q(M(n+i)) = \vartheta_{J\pi_i}, i = 1, \dots, p$, where $\pi_i = \overset{I_i}{\pi}$. As a result $\rho_{n,p}[I]$ descends to the quotient, defines a representation denoted $\tilde{\rho}_{n,p}[I]$, of $M_q(\Sigma, G; \pi_1, \dots, \pi_p)$.*

This proposition is a direct consequence of the above constructions and the fact that $tr_q(M(n+i))$ is represented by $tr_q((\overset{J}{\pi} \otimes \text{id})(RR'))$.

To complete the construction of combinatorial quantization, the space of states $H_{n,p}[I]$ has to be endowed with a structure of Hilbert space and the algebra of observables $M_q(\Sigma, G; \pi_1, \dots, \pi_p)$ has to be endowed with a star structure such that the representation $\tilde{\rho}_{n,p}[I]$ is unitary.

In the case of Chern-Simons theory with $G = SU(2)$, this last step of the construction has been fully studied in [2, 3, 4]. We refer to these works for full details but let us put the emphasis on the following points:

- q is a root of unit which admits the following classical expansion (large λ expansion) $q = 1 + i\frac{2\pi}{\lambda} + o(\frac{1}{\lambda})$;
- $U_q(su(2))$ is endowed with a structure of star weak-quasi Hopf: truncation on the spectrum of finite dimensional unitary irreducible representations holds and the representations $\tilde{\rho}_{n,p}[I]$ is the unique finite dimensional irreducible representation of $M_q(\Sigma, G; \pi_1, \dots, \pi_p)$.

In the next section we will modify the previous constructions and apply them to the case of the group $SL(2, \mathbb{C})_{\mathbb{R}}$.

III Combinatorial Quantization in the $SL(2, \mathbb{C})_{\mathbb{R}}$ case.

III.1. Chern-Simons theory with $SL(2, \mathbb{C})_{\mathbb{R}}$ group.

Let $G = SU(2)$, we will denote by $G^{\mathbb{C}} = SL(2, \mathbb{C})$ the complex group and by $SL(2, \mathbb{C})_{\mathbb{R}}$ the realification of $SL(2, \mathbb{C})$. The real Lie algebra of $SL(2, \mathbb{C})_{\mathbb{R}}$ denoted $sl(2, \mathbb{C})_{\mathbb{R}}$ can equivalently be described by a star structure on its complexification $(sl(2, \mathbb{C})_{\mathbb{R}})^{\mathbb{C}} = sl(2, \mathbb{C}) \oplus sl(2, \mathbb{C})$.

Chern-Simons theory with gauge group $SL(2, \mathbb{C})_{\mathbb{R}}$ is defined on a 3-dimensional compact oriented manifold M by the action

$$S(A) = \frac{\lambda}{4\pi} \int_M \text{Tr}(A \wedge dA + \frac{2}{3}A \wedge A \wedge A) + \frac{\bar{\lambda}}{4\pi} \int_M \text{Tr}(\bar{A} \wedge d\bar{A} + \frac{2}{3}\bar{A} \wedge \bar{A} \wedge \bar{A}) \quad , \quad (62)$$

where the gauge field $A = A_{\mu} dx^{\mu}$ is a $sl(2, \mathbb{C})$ 1-form on M and Tr is the Killing form on $sl(2, \mathbb{C})$.

Following[29], we can always write $\lambda = k + is$, with s real and k integer in order that $\exp(iS(A))$ is invariant under large gauge transformation.

In this paper we will choose the case $k = 0$ which is selected when one expresses the action of 2 + 1 pure gravity with positive cosmological constant as a $SL(2, \mathbb{C})_{\mathbb{R}}$ Chern Simons action [28].

We shall apply the program of combinatorial quantization in this case. From the expression of the Poisson structure on the space of flat connections, it is easy to see that q has to satisfy $q = 1 + \frac{2\pi}{s} + o(\frac{1}{s})$ when s is large. As a result we will develop the combinatorial quantization construction using the Hopf algebra $U_q(sl(2, \mathbb{C})_{\mathbb{R}})$ with q real.

An introduction to the notion of complexification and realification in the Hopf algebra context can be found in the chapter 2 of [13].

III.2. Combinatorial Quantization Formalism in the $SL(2, \mathbb{C})_{\mathbb{R}}$ case: the algebraic structures.

In this part we describe the modifications that have to be made to construct all the algebraic structures of the combinatorial quantization formalism in the $SL(2, \mathbb{C})_{\mathbb{R}}$ case.

In Fock-Rosly construction, we first change G to $SL(2, \mathbb{C})_{\mathbb{R}}$. The Lie algebra \mathfrak{g} is changed into $sl(2, \mathbb{C})_{\mathbb{R}}$ which is equivalent to the Lie algebra $sl(2, \mathbb{C}) \oplus \overline{sl(2, \mathbb{C})}$ with star structure \star defined by $(a \oplus \bar{b})^{\star} = -(b \oplus \bar{a})$. Let \dagger be the star structure on $sl(2, \mathbb{C})$ selecting the compact form, $-\dagger$ identifies $sl(2, \mathbb{C})$ and $\overline{sl(2, \mathbb{C})}$ as \mathbb{C} -Lie algebras. As a result we can equivalently describe $sl(2, \mathbb{C})_{\mathbb{R}}$ as being the Lie algebra $sl(2, \mathbb{C}) \oplus sl(2, \mathbb{C})$ with star structure $(a \oplus b)^{\star} = (b^{\dagger} \oplus a^{\dagger})$. We will denote by $\overset{I}{\pi}$ for $I \in \frac{1}{2}\mathbb{Z}^+$ the irreducible representations of dimension $2I + 1$ of $su(2)$ which are also \dagger representations of $sl(2, \mathbb{C})$, and let e_a be an orthonormal basis of this module. The contragredient representation of $\overset{I}{\pi}$, denoted $\overset{\check{I}}{\pi}$ is equivalent to the conjugate representation because it is a \dagger representation. In the $su(2)$ case it is moreover equivalent to the representation $\overset{I}{\pi}$ through the intertwiner $\overset{I}{W}: \overset{\check{I}}{\pi} = \overset{I}{W} \overset{I}{\pi} \overset{I}{W}^{-1}$ where $\overset{I}{W} \overset{a}{b} = (-1)^{I-a} \delta_{-b}^a$.

Finite dimensional irreducible representations of $sl(2, \mathbb{C})_{\mathbb{R}}$ are labelled by a couple $I = (I^l, I^r)$ of positive half integers and we will denote by $\overset{I}{\mathbb{V}} = \overset{I^l}{V} \otimes \overset{I^r}{V}$ the $sl(2, \mathbb{C}) \oplus sl(2, \mathbb{C})$ module labelled by the couple $I = (I^l, I^r)$ associated to the representation $\overset{I}{\Pi} = \overset{I^l}{\pi} \otimes \overset{I^r}{\pi}$. These representations, except the trivial one, are not \star -representations.

From the action (62) the Poisson bracket on the space of $sl(2, \mathbb{C}) \oplus sl(2, \mathbb{C})$ -connections is expressed by

$$\{A_i^l(x) \otimes A_j^l(y)\} = \frac{2\pi}{\lambda} \delta(x-y) \epsilon_{ij} t^{ll} \quad (63)$$

$$\{A_i^r(x) \otimes A_j^r(y)\} = -\frac{2\pi}{\lambda} \delta(x-y) \epsilon_{ij} t^{rr} \quad (64)$$

$$\{A_i^l(x) \otimes A_j^r(y)\} = 0 \quad (65)$$

where t^{ll} (resp. t^{rr}) is the embedding of t in the $l \otimes l$ (resp. $r \otimes r$) component of $(sl(2, \mathbb{C}) \oplus sl(2, \mathbb{C}))^{\otimes 2}$. Note that we have $A_i^l(x)^\dagger = -A_j^r(x)$ and $t^{\dagger\dagger} = t$.

The spin-networks are defined analogously by replacing finite dimensional representations of \mathfrak{g} by finite dimensional representations of $sl(2, \mathbb{C}) \oplus sl(2, \mathbb{C})$.

For any representation $\overset{I}{\Pi}$ of $sl(2, \mathbb{C}) \oplus sl(2, \mathbb{C})$ with $I = (I^l, I^r)$, we define $\overset{I}{\mathbb{G}} \in \text{End}(\overset{I}{\mathbb{V}}) \otimes \text{Pol}(SL(2, \mathbb{C})_{\mathbb{R}})$ the matrix of coordinate functions on $SL(2, \mathbb{C})_{\mathbb{R}}$. We have

$$\overset{(I^l, I^r)}{\mathbb{G}}_{bb'}^{aa'} \star = \overset{(\tilde{I}^r, \tilde{I}^l)}{\mathbb{G}}_{b'b}^{a'a} = ((\overset{I^l}{W} \otimes \overset{I^r}{W}) \overset{(I^l, I^r)}{\mathbb{G}} (\overset{I^l}{W}^{-1} \otimes \overset{I^r}{W}^{-1}))_{b'b}^{a'a}. \quad (66)$$

We denote the holonomy of the $sl(2, \mathbb{C}) \oplus sl(2, \mathbb{C})$ connection in the representation $\overset{I}{\Pi}$ by $\overset{I}{\mathbb{U}}(l)$, they satisfy the same relation

$$\overset{(I^l, I^r)}{\mathbb{U}}_{bb'}^{aa'} \star = ((\overset{I^l}{W} \otimes \overset{I^r}{W}) \overset{(I^l, I^r)}{\mathbb{U}} (\overset{I^l}{W}^{-1} \otimes \overset{I^r}{W}^{-1}))_{b'b}^{a'a}. \quad (67)$$

We can define a Fock-Rosly structure on them, the Poisson bracket is the same as (13,14,15) where the classical r matrix of $\mathfrak{su}(2)$ has been replaced by the r matrix of $sl(2, \mathbb{C})_{\mathbb{R}}$: $r_{sl(2, \mathbb{C})_{\mathbb{R}}} = r_{12}^{ll} - r_{21}^{rr}$.

We refer the reader to the article ([12, 13]) for a thorough study of the quantum group $U_q(sl(2, \mathbb{C})_{\mathbb{R}})$, see also the appendix (A.1) where basic definitions as well as fundamental results on harmonic analysis are described. It is important to stress that $U_q(sl(2, \mathbb{C})_{\mathbb{R}})$ admits two equivalent definitions.

The first one is $U_q(sl(2, \mathbb{C})_{\mathbb{R}}) = U_q(sl(2, \mathbb{C})) \otimes U_q(sl(2, \mathbb{C}))$ as an algebra with a suitable structure of coalgebra and \star structure.

The second one, suitable for the study of harmonic analysis, is $U_q(sl(2, \mathbb{C})_{\mathbb{R}}) = D(U_q(\mathfrak{su}(2)))$, the quantum double of $U_q(\mathfrak{su}(2))$, which is the quantum analog of Iwasawa decomposition.

$U_q(sl(2, \mathbb{C})_{\mathbb{R}})$ is a quasi-triangular ribbon Hopf algebra endowed with a star structure (see appendix A.1). Finite dimensional representations of $U_q(sl(2, \mathbb{C})_{\mathbb{R}})$ are labelled by a couple $I = (I^l, I^r) \in (\frac{1}{2}\mathbb{Z}^+)^2 = \mathbb{S}_F$. The explicit description of these representations

is contained in the appendix A.1. The decomposition of the tensor product of these representations, and the explicit form of the Clebsch-Gordan maps, are described in the appendix A.2. For any finite dimensional irreducible representation $\overset{I}{\mathbb{V}}$, we will define $\overset{I}{\mathbb{V}}$ the associated module. Let us denote by $\{\overset{A}{e}_i(I), i = -A, \dots, A, A = |I^l - I^r|, \dots, I^l + I^r\}$ an orthonormal basis of this vector space, and $\{\overset{A}{e}^i(I)\}$ the dual basis. The algebra $Pol(SL_q(2, \mathbb{C})_{\mathbb{R}})$ of polynomials on $SL_q(2, \mathbb{C})_{\mathbb{R}}$ is generated by the matrix elements of the representations $\overset{I}{\mathbb{G}}_{Bb}^{Aa} = \langle \overset{A}{e}^a(I) | \overset{I}{\mathbb{H}}(\cdot) | \overset{B}{e}_b(I) \rangle$. As in the previous section, let us introduce for each representation I the elements $\overset{I}{\mathbb{L}}^{(\pm)Aa}_{Bb} \in End(\overset{I}{\mathbb{V}}) \otimes U_q(sl(2, \mathbb{C})_{\mathbb{R}})$ defined by $\overset{I}{\mathbb{L}}^{(\pm)} = (\overset{I}{\mathbb{H}} \otimes id)(\mathbb{R}^{(\pm)})$ where \mathbb{R} is the $U_q(sl(2, \mathbb{C})_{\mathbb{R}})$ R-matrix arising from the construction of the quantum double. Thanks to the factorisation theorem, i.e. $U_q(sl(2, \mathbb{C})_{\mathbb{R}}) = U_q(sl(2)) \otimes_{R^{-1}} U_q(sl(2))$ as a Hopf algebra [12, 13], \mathbb{R} is expressed in term of $U_q(sl(2))$ R-matrices as $\mathbb{R}^{(\pm)} = R_{14}^{(-)} R_{24}^{(\mp)} R_{13}^{(\pm)} R_{23}^{(+)}$. It is therefore easy to obtain the ribbon elements of $U_q(sl(2, \mathbb{C})_{\mathbb{R}})$ from those of $U_q(sl(2))$:

$$v_I = v_{I^l} v_{I^r}^{-1}, \quad \overset{I}{\mu} = \overset{I^l}{\mu} \otimes \overset{I^r}{\mu}. \quad (68)$$

Let us now study the properties of the star structure on $U_q(sl(2, \mathbb{C})_{\mathbb{R}})$ and, by duality, on $Pol(SL_q(2, \mathbb{C})_{\mathbb{R}})$. In the case of $U_q(sl(2, \mathbb{C})_{\mathbb{R}})$, the star structure, recalled in the appendix, is an antilinear involutive antimorphism satisfying in addition the condition

$$\forall a \in U_q(sl(2, \mathbb{C})_{\mathbb{R}}), \quad (\star \otimes \star) \Delta(a) = \Delta(a^{\star}). \quad (69)$$

It is easy to show the following relation between the antipode and the \star :

$$S \circ \star = \star \circ S^{-1}. \quad (70)$$

The universal R-matrix of $U_q(sl(2, \mathbb{C})_{\mathbb{R}})$ satisfies $\mathbb{R}^{\star \otimes \star} = \mathbb{R}^{-1}$ which is compatible with (69) and is a key property in order to build a star structure on the graph algebra associated to $U_q(sl(2, \mathbb{C})_{\mathbb{R}})$.

By duality, $Pol(SL_q(2, \mathbb{C})_{\mathbb{R}})$ is endowed with a star structure using the following definition:

$$\alpha^{\star}(a) = \overline{\alpha(S^{-1}a^{\star})} \quad \forall (\alpha, a) \in Pol(SL_q(2, \mathbb{C})_{\mathbb{R}}) \times U_q(sl(2, \mathbb{C})_{\mathbb{R}}). \quad (71)$$

Let $I = (I^l, I^r) \in \mathbb{S}_F$ labelling a finite-dimensional representation of $U_q(sl(2, \mathbb{C})_{\mathbb{R}})$ and let us define by $\tilde{I} = (I^r, I^l)$. The following properties of the action of the \star and of the complex conjugation are proved in the appendix A.3. The explicit action of the \star involution on the generators $\overset{I}{\mathbb{G}}_{Bb}^{Aa}$ of $Pol(SL_q(2, \mathbb{C})_{\mathbb{R}})$ is:

$$\overset{I}{\mathbb{G}}^{\star} = \tilde{W} \overset{\tilde{I}}{\mathbb{G}} \tilde{W}^{-1} \quad (72)$$

where we have defined $\overset{I}{W}_{Bb}^{Aa} = \overset{\tilde{I}}{W}_{Bb}^{Aa} = e^{i\pi A} v_A^{-1/2} w_{ab} \delta_B^A$. By duality, the action of \star on the generators $\overset{I}{\mathbb{L}}^{(\pm)Aa}_{Bb}$ of $U_q(sl(2, \mathbb{C})_{\mathbb{R}})$ is:

$$\overset{I}{\mathbb{L}}^{(\pm)\star} = \overset{\tilde{I}}{W} \overset{\tilde{I}}{\mathbb{L}}^{(\pm)} \overset{\tilde{I}}{W}^{-1}. \quad (73)$$

We endow the graph-algebra with the following star structure:

Proposition 4 *The graph-algebra $\mathcal{L}_{n,p}$ is endowed with a star structure defined on the generators $\overset{I}{\mathbb{A}}(i)$, $\overset{I}{\mathbb{B}}(i)$, $\overset{I}{\mathbb{M}}(i)$ (denoted generically $\overset{I}{\mathbb{U}}(i)$), by*

$$\overset{I}{\mathbb{U}}(i)^\star = \sum_j v_{\tilde{I}}^{-1} \overset{\tilde{I}}{W} S^{-1}(\tilde{x}_j) \overset{\tilde{I}}{\mathbb{U}}(i) \overset{\tilde{I}}{y}_j \overset{\tilde{I}}{\mu} \overset{\tilde{I}}{W}^{-1}, \quad (74)$$

where $\mathbb{R} = \sum_j x_j \otimes y_j$. This star structure is an involutive antilinear automorphism which in the classical limit gives back the star properties (67) on the holonomies. The definition of this star structure is chosen in order that the coaction δ is a star morphism.

Proof: We just have to prove that it is an involution and that it is compatible with the defining relations of the graph algebra. These two properties are straightforward to verify. \square

The star structure on the graph algebra induces a star structure on the algebra $\mathcal{L}_{n,p}^{inv}$. The action of this star structure on the generating family labelled by spin-network is described in the following proposition:

Proposition 5 *The action of the star structure on $\mathcal{L}_{n,p}^{inv}$ satisfies:*

$$\overset{P}{\mathcal{O}}_{n,p}^{(\pm)\star} = \overset{\tilde{P}}{\mathcal{O}}_{n,p}^{(\mp)} \quad (75)$$

where \tilde{P} is the spin network deduced from P by turning all the colors I of P into \tilde{I} .

Proof: This follows from the action of the star on the monodromies, the commutation relations of the monodromies and the properties with respect to the complex conjugation. \square

$\mathfrak{M}_q(\Sigma, SL(2, \mathbb{C})_{\mathbb{R}}, p)$ is the algebra defined by $\mathfrak{M}_q(\Sigma, SL(2, \mathbb{C})_{\mathbb{R}}, p) = \mathcal{L}_{n,p} / \mathcal{I}_C$. Let $\overset{\alpha}{\Pi}$ be an irreducible unitary representation of $U_q(sl(2, \mathbb{C})_{\mathbb{R}})$, labelled by the couple $\alpha \in \mathbb{S}_P$ we can still define the complex numbers $\vartheta_{I\alpha}$ where $I \in \mathbb{S}_F$. The explicit formula, which is proved in the appendix A.3, for $\vartheta_{I\alpha}$ is

$$\vartheta_{I\alpha} = \frac{[(2I^l + 1)(2\alpha^l + 1)] [(2I^r + 1)(2\alpha^r + 1)]}{[2\alpha^l + 1] [2\alpha^r + 1]}. \quad (76)$$

Let $\overset{\alpha_1}{\Pi}, \dots, \overset{\alpha_p}{\Pi}$ be irreducible unitary representations of $U_q(sl(2, \mathbb{C})_{\mathbb{R}})$ attached to the punctures of Σ , the moduli space $M_q(\Sigma, SL(2, \mathbb{C})_{\mathbb{R}}; \alpha_1, \dots, \alpha_p)$ is defined by:

$$M_q(\Sigma, SL(2, \mathbb{C})_{\mathbb{R}}; \alpha_1, \dots, \alpha_p) = \mathfrak{M}_q(\Sigma, G, p) / \{tr_q(\overset{I}{\mathbb{M}}(n+i)) = \vartheta_{I\alpha_i}, i = 1, \dots, p, \forall I \in \mathbb{S}_F\}. \quad (77)$$

Proposition 6 *The star structure on the graph algebra defines a natural star structure on the algebras $\mathfrak{M}_q(\Sigma, SL(2, \mathbb{C})_{\mathbb{R}}, p)$ and $M_q(\Sigma, SL(2, \mathbb{C})_{\mathbb{R}}; \alpha_1, \dots, \alpha_p)$.*

Proof: This is a simple consequence of the fact that $\overline{\vartheta_{I\alpha}} = \vartheta_{\tilde{I}\alpha}$ for $\alpha \in \mathbb{S}_P$ and $I \in \mathbb{S}_F$.
□

The Heisenberg double of $U_q(sl(2, \mathbb{C})_{\mathbb{R}})$ is defined by $H(U_q(sl(2, \mathbb{C})_{\mathbb{R}})) = U_q(sl(2, \mathbb{C})_{\mathbb{R}}) \otimes Pol(SL_q(2, \mathbb{C})_{\mathbb{R}})$.

In order to build unitary representations of the graph algebra and the moduli algebra in the next chapter we have to study the properties of Alekseev isomorphism with respect to the star structure. The already defined star structures on $U_q(sl(2, \mathbb{C})_{\mathbb{R}})$ and $Pol(SL_q(2, \mathbb{C})_{\mathbb{R}})$ naturally extend to a star structure on $H(U_q(sl(2, \mathbb{C})_{\mathbb{R}}))$, and therefore to $H(U_q(sl(2, \mathbb{C})_{\mathbb{R}}))^{\otimes n} \otimes U_q(sl(2, \mathbb{C})_{\mathbb{R}})^{\otimes p}$.

Proposition 7 *The Alekseev isomorphism defined in lemma 3*

$$\mathcal{L}_{n,p} \xrightarrow{\sim} H(U_q(sl(2, \mathbb{C})_{\mathbb{R}}))^{\otimes n} \otimes U_q(sl(2, \mathbb{C})_{\mathbb{R}})^{\otimes p}$$

is a star-isomorphism.

Proof: Using the star structure on $H(U_q(sl(2, \mathbb{C})_{\mathbb{R}}))^{\otimes n} \otimes U_q(sl(2, \mathbb{C})_{\mathbb{R}})^{\otimes p}$, we first show that:

$${}^I\mathfrak{B}(i)^\star = \sum_j v_{\tilde{I}}^{-1} \tilde{W} S^{-1}(\tilde{x}_j) \tilde{\mathfrak{B}}(i) \tilde{y}_j \tilde{\mu} \tilde{W}^{-1} . \quad (78)$$

In order to prove this, we introduce the permutation P_{12} and we have

$$\begin{aligned} {}^I\mathfrak{B}(i)^\star &= tr_2(P_{12} \mathbb{L}_1^{(-)-1\star} \mathbb{L}_2^{(+)\star}) \\ &= tr_2(P_{12} \tilde{W}_1 \tilde{\mu}_1^{-1} \tilde{\mathbb{L}}_1^{(-)-1} \tilde{\mu}_1 \tilde{W}_1^{-1} \tilde{W}_2 \tilde{\mathbb{L}}_2^{(+)} \tilde{W}_2^{-1}) \\ &= \tilde{W}_1 tr_2(P_{12} \tilde{\mathbb{L}}_1^{(-)-1} \tilde{\mathbb{L}}_2^{(+)} \tilde{\mu}_2^{-1}) \tilde{\mu}_1 \tilde{W}_1^{-1} \\ &= \tilde{W}_1 tr_2(P_{12} S^{-1}(\tilde{x}_{j2}) \tilde{\mathbb{L}}_2^{(+)} \tilde{\mathbb{R}} \tilde{\mathbb{L}}_1^{(-)-1} \tilde{y}_{j1} \tilde{\mu}_2^{-1}) \tilde{\mu}_1 \tilde{W}_1^{-1} \\ &= v_{\tilde{I}}^{-1} \tilde{W} S^{-1}(\tilde{x}_j) \tilde{\mathfrak{B}}(i) \tilde{y}_j \tilde{\mu} \tilde{W}^{-1} . \end{aligned}$$

Then, it is easy to compute that the star acts on ${}^I\mathfrak{R}(i)$ and on its inverse as:

$${}^I\mathfrak{R}(i)^\star = \tilde{W}(i) \tilde{\mathfrak{R}}(i) \tilde{W}(i)^{-1} , \quad {}^I\mathfrak{R}(i)^{-1\star} = \tilde{W}(i) \tilde{\mu}^{-1} \tilde{\mathfrak{R}}(i)^{-1} \tilde{\mu} \tilde{W}(i)^{-1} . \quad (79)$$

Finally, from the previous relations, we have

$$\begin{aligned}
(\mathfrak{K}(i) \mathfrak{B}(i) \mathfrak{K}(i)^{-1})^\star &= \left(\text{tr}_{23}(P_{12}P_{23} \mathfrak{K}_3(i) \mathfrak{B}_2(i) \mathfrak{K}_1(i)^{-1}) \right)^\star \\
&= \text{tr}_{23}(\mathfrak{K}_1(i)^{-1\star} \mathfrak{B}_2(i)^\star \mathfrak{K}_3(i)^\star) \\
&= \text{tr}_{23}(\tilde{\mathfrak{K}}_1(i)^{-1} \tilde{\mu}_1 \tilde{W}_1^{-1} \tilde{v}_2^{-1} S^{-1}(\tilde{x}_{2(j)}) \tilde{\mathfrak{B}}_2(i) \tilde{y}_{2(j)} \tilde{W}_3 \tilde{\mathfrak{K}}_3(i)) \\
&= \tilde{v}^{-1} \tilde{W} S^{-1}(\tilde{x}_{(j)}) \tilde{\mathfrak{K}}(i) \tilde{x}_{(k)} S^{-1}(\tilde{x}_{(l)}) \tilde{\mathfrak{B}}(i) \tilde{y}_{(l)} \tilde{y}_{(k)} \tilde{\mathfrak{K}}(i)^{-1} \tilde{y}_{(j)} \tilde{\mu} \tilde{W}^{-1} \\
&= \tilde{v}^{-1} \tilde{W} S^{-1}(\tilde{x}_{(j)}) \left(\tilde{\mathfrak{K}}(i) \tilde{\mathfrak{B}}(i) \tilde{\mathfrak{K}}(i)^{-1} \right) \tilde{y}_{(j)} \tilde{\mu} \tilde{W}^{-1} .
\end{aligned}$$

As a result, we have shown that the property holds true for the monodromies $\mathbb{B}(i)$. The other cases are proved along the same lines. \square

III. Unitary Representations of the Moduli Algebra in the $SL(2, \mathbb{C})_{\mathbb{R}}$ case.

III.1 Unitary representation of the graph algebra.

The reader is invited to read the appendix A.1 where the basic results on harmonic analysis are recalled.

Proposition 8 $H(U_q(sl(2, \mathbb{C})_{\mathbb{R}}))$ admits a unitary representation acting on the space $Fun_{cc}(SL_q(2, \mathbb{C})_{\mathbb{R}})$ endowed with the hermitian form (183) and constructed as:

$$\begin{aligned}
H(U_q(sl(2, \mathbb{C})_{\mathbb{R}})) &\longrightarrow \text{End}(Fun_{cc}(SL_q(2, \mathbb{C})_{\mathbb{R}})), \\
Pol(SL_q(2, \mathbb{C})_{\mathbb{R}}) \ni f &\mapsto m_f \quad / \quad m_f(g) = fg \quad , \forall g \in Fun_{cc}(SL_q(2, \mathbb{C})_{\mathbb{R}}) \\
U_q(sl(2, \mathbb{C})_{\mathbb{R}}) \ni x &\mapsto \nabla_x \quad / \quad \nabla_x(g) = g_{(1)} \langle x, g_{(2)} \rangle \quad , \forall g \in Fun_{cc}(SL_q(2, \mathbb{C})_{\mathbb{R}}).
\end{aligned}$$

Proof: Trivial to check. \square

From the Alekseev isomorphism and the study of harmonic analysis on $SL_q(2, \mathbb{C})_{\mathbb{R}}$, we obtain a simple description of unitary representations of the graph algebra $\mathcal{L}_{n,p}$:

Proposition 9 Let $\alpha_1, \dots, \alpha_p \in \mathbb{S}_P$ we denote by $\mathcal{H}_{n,p}[\alpha] = Fun_{cc}(SL_q(2, \mathbb{C})_{\mathbb{R}})^{\otimes n} \otimes \mathbb{V}(\alpha)$ the pre-Hilbert space with sesquilinear form $\langle, \rangle = (\otimes_{i=1}^n \langle, \rangle_i) \otimes (\otimes_{j=1}^p \langle, \rangle_{j+n})$ where \langle, \rangle_i is the L^2 hermitian form (183) on the i -th copy of $Fun_{cc}(SL_q(2, \mathbb{C})_{\mathbb{R}})$ and \langle, \rangle_{n+j} is the hermitian form on \mathbb{V}^{α_j} . $\mathcal{H}_{n,p}[\alpha]$ is endowed with a structure of $\mathcal{L}_{n,p}$ module using the Alekseev isomorphism. This representation is unitary, in the sense that:

$$\forall a \in \mathcal{L}_{n,p}, \forall v, w \in \mathcal{H}_{n,p}, \quad \langle a^\star \triangleright v, w \rangle = \langle v, a \triangleright w \rangle . \quad (80)$$

Proof: This is a simple consequence of the previous proposition. \square .

We now come to the central part of our work: the construction of a unitary representation of the moduli-algebra. We could have hoped to apply the same method as

in proposition (3), unfortunately this is not possible because there is no normalizable states in $\mathcal{H}_{n,p}$ or in its completion with respect to \langle, \rangle which are invariant under the action of $U_q(sl(2, \mathbb{C})_{\mathbb{R}})$ induced from the algebra generated by $\overset{I}{C}$. We cannot exclude the existence of a quantum analogue of Faddeev-Popov procedure to solve this problem but we were unable to proceed along this path. Instead we will give explicit formulas for the action of $\overset{P}{\mathcal{O}}_{n,p}(\pm)$ on the space of invariant vectors, with a suitable hermitian form, and verify that this representation is unitary. We will enlarge the representation space of the graph algebra as follows: we will transfer the representation of the graph-algebra on the dual conjugate space $\overline{\mathcal{H}_{n,p}[\alpha]^*}$ as follows:

$$\forall \bar{\phi} \in \overline{\mathcal{H}_{n,p}[\alpha]^*}, \forall v \in \mathbb{V}[\alpha], \forall a \in \mathcal{L}_{n,p}, (a \triangleright \bar{\phi}, \bar{v}) = (\bar{\phi}, \overline{a^* \triangleright v}) = \overline{(\phi, a^* \triangleright v)}. \quad (81)$$

$\overline{\mathcal{H}_{n,p}[\alpha]^*}$ is naturally endowed with a structure of $U_q(SL(2, \mathbb{C})_{\mathbb{R}})$ module which admits, as we will see, invariant elements. This method is similar in spirit to the concept of refined algebraic quantization program [7]. In order not to complicate notations, we will prefer to work with the right module $\mathcal{H}_{n,p}[\alpha]^*$ associated to the anti-representation:

$$\forall \phi \in \mathcal{H}_{n,p}[\alpha]^*, \forall v \in \mathbb{V}[\alpha], \forall a \in \mathcal{L}_{n,p}, (\phi \triangleleft a, v) = (\phi, a \triangleright v), \quad (82)$$

this is of course completely equivalent. We will continue to denote by $\rho_{n,p}[\alpha]$ this antirepresentation.

The construction of a unitary representation of the moduli algebra is exposed through elementary steps: the p-punctured sphere, the genus-n surface and finally the general case.

III.2 Unitary Representation of the moduli algebra

III.2.1. The moduli algebra of a p-punctured sphere

This first subsection is devoted to a precise description of unitary representations of the moduli-algebra on a sphere with p punctures associated to unitary irreducible representations $\alpha_1, \dots, \alpha_p$.

Let us begin with some particular examples. The three first cases (i.e. $p = 1, 2$ or 3) are singular in the sense that the representation of the moduli algebra is one-dimensional or zero-dimensional.

In the case of the one-punctured sphere, the moduli algebra has the following structure:

- $M_q(S^2, SL(2, \mathbb{C})_{\mathbb{R}}; \Pi) = \{0\}$ if Π is not the trivial representation
- $M_q(S^2, SL(2, \mathbb{C})_{\mathbb{R}}; \Pi) = \mathbb{C}$ where $I = (0, 0)$.

As a result the representation is non zero-dimensional if and only if the representation associated to the puncture is the trivial representation. In this case the corresponding one dimensional representation $H_{0,1}$ is trivially unitarizable.

In the case of the two-punctured sphere, the moduli algebra has the following structure:

- $M_q(S^2, SL(2, \mathbb{C})_{\mathbb{R}}; \overset{\alpha_1}{\Pi}, \overset{\alpha_2}{\Pi}) = \{0\}$ if $\overset{\alpha_1}{\Pi}$ is not equivalent to $\overset{\alpha_2}{\Pi}$
- $M_q(S^2, SL(2, \mathbb{C})_{\mathbb{R}}; \overset{\alpha_1}{\Pi}, \overset{\alpha_1}{\Pi}) = \mathbb{C}$.

As a result the representation is non-zero dimensional if and only if the representations associated to the two punctures are the same, i.e. $\alpha_1 = \alpha_2$. The associated module is $(\mathbb{V}(\alpha_1, \alpha_1)^*)^{U_q(sl(2, \mathbb{C})_{\mathbb{R}})}$ generated by $\overset{\alpha}{\omega}_{0,2}$ where $\alpha = (\alpha_1, \alpha_1)$, such that

$$\langle \overset{\alpha}{\omega}_{0,2}, e_i(\alpha_1) \otimes e_j(\alpha_1) \rangle = \Psi_{\alpha_1 \alpha_1}^0 (e_i(\alpha_1) \otimes e_j(\alpha_1)) . \quad (83)$$

We can endow this module with a Hilbert structure $\langle . | . \rangle$ such that $\langle \overset{\alpha}{\omega}_{0,2} | \overset{\alpha}{\omega}_{0,2} \rangle = 1$. This is a unitary one-dimensional module $H_{0,2}(\alpha)$ of the moduli algebra because of the property $\overline{\vartheta_{I\Pi}} = \vartheta_{I\Pi}$ for unitary representations Π , and $I \in \mathbb{S}_F$.

In the case of three punctures, the moduli algebra has the following structure:

- $M_q(S^2, SL(2, \mathbb{C})_{\mathbb{R}}; \overset{\alpha_1}{\Pi}, \overset{\alpha_2}{\Pi}, \overset{\alpha_3}{\Pi}) = \mathbb{C}$ if $m_{\alpha_1} + m_{\alpha_2} + m_{\alpha_3} \in \mathbb{Z}$,
- $M_q(S^2, SL(2, \mathbb{C})_{\mathbb{R}}; \overset{\alpha_1}{\Pi}, \overset{\alpha_2}{\Pi}, \overset{\alpha_3}{\Pi}) = \{0\}$ in the other cases.

In the first case, let us denote by $\alpha = (\alpha_1, \alpha_2, \alpha_3)$. The associated module is $(\mathbb{V}(\alpha)^*)^{U_q(sl(2, \mathbb{C})_{\mathbb{R}})}$ generated by $\overset{\alpha}{\omega}_{0,3}$ such that

$$\langle \overset{\alpha}{\omega}_{0,3}, e_i(\alpha_1) \otimes e_j(\alpha_2) \otimes e_k(\alpha_3) \rangle = (\Psi_{\alpha_3 \alpha_3}^0 \Psi_{\alpha_1 \alpha_2}^{\alpha_3}) (e_i(\alpha_1) \otimes e_j(\alpha_2) \otimes e_k(\alpha_3)) . \quad (84)$$

We can endow this module with a Hilbert structure $\langle . | . \rangle$ such that $\langle \overset{\alpha}{\omega}_{0,3} | \overset{\alpha}{\omega}_{0,3} \rangle = 1$. This is a unitary one-dimensional module $H_{0,3}(\alpha)$ of the moduli algebra for the same reasons as before.

Definition 6 Let $\alpha = (\alpha_1, \dots, \alpha_n) \in \mathbb{S}^n, \beta = (\beta_3, \dots, \beta_n) \in \mathbb{S}^{n-2}, \kappa \in \mathbb{S}$, we define $\Psi_{\alpha}^{\kappa}(\beta) \in Hom_{U_q(sl(2, \mathbb{C})_{\mathbb{R}})}(\mathbb{V}(\alpha), \overset{\kappa}{\mathbb{V}})$ as

$$\Psi_{\alpha}^{\kappa}(\beta) = \Psi_{\beta_n \alpha_n}^{\kappa} \Psi_{\beta_{n-1} \alpha_{n-1}}^{\beta_n} \dots \Psi_{\beta_3 \alpha_3}^{\beta_4} \Psi_{\alpha_1 \alpha_2}^{\beta_3} . \quad (85)$$

Definition 7 For any family $\beta = (\beta_3, \dots, \beta_{p-1}) \in \mathbb{S}^{p-3}$ we define the linear form $\overset{\alpha}{\omega}_{0,p}[\beta] \in \mathbb{V}(\alpha)^*$ by:

$$\overset{\alpha}{\omega}_{0,p}[\beta] = \Psi_{\alpha}^0(\beta_3, \dots, \beta_{p-1}, \alpha_p) . \quad (86)$$

These linear forms satisfy the constraints

$$\overset{\alpha}{\omega}_{0,p}[\beta] \triangleleft C_{0,p}^{I(\pm)} = \overset{\alpha}{\omega}_{0,p}[\beta] , \quad (87)$$

$$\overset{\alpha}{\omega}_{0,p}[\beta] \triangleleft tr_q(I \mathbb{M}(n+i)) = \vartheta_{I\alpha_i} \overset{\alpha}{\omega}_{0,p}[\beta] , \quad \forall I \in \mathbb{S}_F, \forall i = 1, \dots, p . \quad (88)$$

In particular $\hat{\omega}_{0,p}^\alpha[\beta]$ are invariant elements of $\mathbb{V}(\alpha)^*$. It will be convenient to denote $\hat{\omega}_{0,p}^\alpha[\beta]_a^I = \langle \hat{\omega}_{0,p}^\alpha[\beta], \bigotimes_{i=1}^p e_{a_i}^{I_i}(\alpha_i) \rangle$.

We will now smear $\hat{\omega}_{0,p}^\alpha[\beta]$ with a function f sufficiently regular, in order to obtain “wave packet.” We have chosen functions which are analytic in the spirit of the Paley-Wiener theorem.

In the sequel we will use the following notations: we define $\mathcal{S} = (\frac{1}{2}\mathbb{Z})^2$ and for $\beta \in \mathbb{S}^k$, we will denote by $\rho_\beta = (\rho_{\beta_1}, \dots, \rho_{\beta_k})$ and $m_\beta = (m_{\beta_1}, \dots, m_{\beta_k})$. Reciprocally $m \in (\frac{1}{2}\mathbb{Z})^k, \rho \in \mathbb{C}^k$ is associated to a unique element $\beta(m, \rho) \in \mathbb{S}^k$. If f is a complex valued function on \mathbb{S}^k we will denote by f_m the function on \mathbb{C}^k defined by $f_m(\rho) = f(\beta(m, \rho))$.

Definition 8 We define $\mathbb{A}^{(k)}$ to be the set of functions f on \mathbb{S}^k such that

- $f(\beta_1, \dots, \beta_{r-1}, \underline{\beta_r}, \beta_{r+1}, \dots, \beta_k) = f(\beta_1, \dots, \beta_{r-1}, \beta_r, \beta_{r+1}, \dots, \beta_k), \quad \forall r = 1, \dots, k,$
- f_m is a non zero function for only a finite number of $m \in \frac{1}{2}\mathbb{Z}^k,$
- f_m is a Laurent series in the variables $q^{i\rho_{\beta_1}}, \dots, q^{i\rho_{\beta_k}},$ convergent for all $\rho_{\beta_1}, \dots, \rho_{\beta_k} \in \mathbb{C}.$

For $\beta \in \mathbb{S}^{p-3}$ we define

$$\hat{\Xi}_{0,p}[\alpha, \beta]^{-1} = e^{i\pi(\alpha_1 + \dots + \alpha_p)} \zeta(\alpha_1, \alpha_2, \beta_3) \prod_{j=3}^{p-2} \zeta(\beta_j, \alpha_j, \beta_{j+1}) \zeta(\beta_{p-1}, \alpha_{p-1}, \alpha_p) \prod_{j=3}^{p-1} \nu_1(d_j). \quad (89)$$

For $I = (I_1, \dots, I_p)$ we denote $\nu^I(\alpha) = \prod_{j=1}^p \nu^{(I_j)}(\alpha_j)$.

Lemma 4 $\hat{\omega}_{0,p}^\alpha[\beta]_a^I \hat{\Xi}_{0,p}[\alpha, \beta] \nu^I(\alpha)$ is equal to $P[\alpha, \beta]/Q[\beta]$ where $P[\alpha, \beta]$ is a Laurent polynomial in the variables $q^{i\rho_{\alpha_1}}, \dots, q^{i\rho_{\alpha_p}}, q^{i\rho_{\beta_3}}, \dots, q^{i\rho_{\beta_{p-1}}}$ and $Q[\beta] = \prod_{j=3}^{p-1} (i\rho_{\beta_j} - B_j)_{2B_j+1}$ with $B_j \in \frac{1}{2}\mathbb{N}$. Let M be the set of $J \in (\frac{1}{2}\mathbb{N})^{p-3}$ such that the inequalities: $Y(J_3, I_1, I_2) = 1, \dots, Y(J_{p-2}, I_{p-2}, J_{p-1}) = 1, Y(I_{p-1}, J_{p-1}, I_p) = 1$ hold. We have $B_j = \max\{J_j, J \in M\}$.

Proof: Trivial application of the proposition (24) of the Appendix A.2. \square

For $\beta \in \mathbb{S}^{p-3}$ we define $\xi[\beta] = \prod_{j=3}^{p-1} \xi(2\beta_j^I + 1), \mathcal{P}[\beta] = \prod_{j=3}^{p-1} \mathcal{P}(\beta_j)$, where ξ and the Plancherel weight \mathcal{P} are defined in the appendix A.1, as well as $\Xi_{0,p}[\alpha, \beta] = \hat{\Xi}_{0,p}[\alpha, \beta] \xi[\beta]$.

Proposition 10 We can define a subset of $\mathbb{V}(\alpha)^*$ by:

$$H_{0,p}(\alpha) = \{\hat{\omega}_{0,p}^\alpha(f) = \int_{\mathbb{S}^{p-3}} d\beta \mathcal{P}[\beta] f(\beta) \Xi_{0,p}[\alpha, \beta] \hat{\omega}_{0,p}^\alpha[\beta], \text{ with } f \in \mathbb{A}^{(p-3)}\}. \quad (90)$$

The map $\mathbb{A}^{(p-3)} \rightarrow H_{0,p}(\alpha)$ which sends f to $\hat{\omega}_{0,p}^\alpha(f)$ is an injection.

Proof: In order to show that $\tilde{\omega}_{0,p}^\alpha(f)$ is well defined it is sufficient to show that $\xi[\beta]\Xi_{0,p}[\alpha, \beta] \tilde{\omega}_{0,p}^\alpha[\beta]_a^I$ is a Laurent series in $q^{i\rho_{\beta_3}}, \dots, q^{i\rho_{\beta_{p-1}}}$, which is the case because $\xi[\beta]$ cancels the simple poles of $\Xi_{0,p}[\alpha, \beta] \tilde{\omega}_{0,p}^\alpha[\beta]_a^I$. The sum over m_β is finite because of the condition on f .

We now prove injectivity of this map. Assume that $\tilde{\omega}_{0,p}^\alpha(f)$ is zero, we would therefore have $\tilde{\omega}_{0,p}^\alpha(f)(av) = 0$ for all $a \in U_q(\mathfrak{sl}(2, \mathbb{C})_{\mathbb{R}})^{\otimes p}$ and $v \in \mathbb{V}[\alpha]$. If c is a central element of $U_q(\mathfrak{sl}(2, \mathbb{C})_{\mathbb{R}})$ we denote by $c(\beta)$ its value on the module \mathbb{V}^β . In particular if c_3, \dots, c_{p-1} are elements of the center of $U_q(\mathfrak{sl}(2, \mathbb{C})_{\mathbb{R}})$, we take $a = \Delta(c_3) \dots \Delta^{(p-2)}(c_p)$ where $\Delta^{(k)}$ are the iterated coproducts, and using the intertwiner property we obtain that $\tilde{\omega}_{0,p}^\alpha(fg(c_3, \dots, c_{p-1})) = 0$ where $g(c_3, \dots, c_{p-1})(\beta) = \prod_{j=3}^{p-1} c_j(\beta_j)$. By a similar argument as the one used in [12] (proof of Th 12 (Plancherel Theorem)), we obtain that f has to satisfy the identity: $f(\beta)\Xi_{0,p}[\alpha, \beta] \tilde{\omega}_{0,p}^\alpha[\beta] = 0$. It remains to show that this implies $f = 0$. This follows from a similar argument exposed in [14] (Th 4) which uses the asymptotics of the reduced elements. \square

We define, for $\alpha \in \mathbb{S}_P^p, \beta \in \mathbb{S}_P^{p-3}$,

$$M_{0,p}[\alpha, \beta] = M(\alpha_1, \alpha_2, \beta_3) \prod_{j=3}^{p-2} M(\beta_j, \alpha_j, \beta_{j+1}) M(\beta_{p-1}, \alpha_{p-1}, \alpha_p) \quad (91)$$

where M is defined in the appendix A.2, and we denote for $\alpha \in \mathbb{S}_P^p, \beta \in \mathbb{S}_P^{p-3}$

$$\Upsilon_{0,p}[\alpha, \beta] = \frac{|\Xi_{0,p}[\alpha, \beta]|^2}{M_{0,p}[\alpha, \beta]}. \quad (92)$$

Lemma 5 $\Upsilon_{0,p}[\alpha, \beta]$ is an analytic function of the real variables $\rho_{\beta_3}, \dots, \rho_{\beta_{p-1}}$ and therefore admits an analytic continuation for $\rho_{\beta_3}, \dots, \rho_{\beta_{p-1}} \in \mathbb{C}^{p-3}$, i.e $\beta_3, \dots, \beta_{p-1} \in \mathbb{S}^{p-3}$.

Proof: We can extend M to \mathbb{S}^3 as follows [14]:

$$M(\alpha, \beta, \gamma) = \psi_1(\alpha, \beta, \gamma) \frac{(q^{-1} - q)q^{m_\alpha + m_\beta + m_\gamma}}{\nu_1(d_{\alpha^l})\nu_1(d_{\alpha^r})\nu_1(d_{\beta^l})\nu_1(d_{\beta^r})\nu_1(d_{\gamma^l})\nu_1(d_{\gamma^r})} \Theta(\alpha, \beta, \gamma) \quad (93)$$

where

$$\Theta(\alpha, \beta, \gamma) = \frac{\theta(2\alpha^r + 1)\theta(2\beta^r + 1)\theta(2\gamma^r + 1)}{\theta(\alpha^r + \beta^r + \gamma^r + 2)\theta(\underline{\alpha}^r + \beta^r + \gamma^r + 2)\theta(\alpha^r + \underline{\beta}^r + \gamma^r + 2)\theta(\alpha^r + \beta^r + \underline{\gamma}^r + 2)}$$

$$\psi_1(\alpha, \beta, \gamma) = \frac{\varphi(2\alpha^r, -2m_\alpha - 1)\varphi(2\beta^r, -2m_\beta - 1)\varphi(2\gamma^r, -2m_\gamma - 1)}{\varphi(i\rho_{\alpha+\beta+\gamma}, m_{\alpha+\beta+\gamma})\varphi(i\rho_{\underline{\alpha}+\beta+\gamma}, m_{\underline{\alpha}+\beta+\gamma})\varphi(i\rho_{\alpha+\underline{\beta}+\gamma}, m_{\alpha+\underline{\beta}+\gamma})\varphi(i\rho_{\alpha+\beta+\underline{\gamma}}, m_{\alpha+\beta+\underline{\gamma}})}$$

Moreover $|\Xi_{0,p}[\alpha, \beta]|^2$ can be extended to $\beta_3, \dots, \beta_{p-1} \in \mathbb{S}^{p-3}$ by

$$|\Xi_{0,p}[\alpha, \beta]|^2 = \frac{\prod_{j=3}^{p-1} (-1)^{2m_{\beta_j}} q^{4im_{\beta_j}\rho_{\beta_j}}}{\psi_{2(\alpha_1, \alpha_2, \beta_3)} \prod_{j=3}^{p-2} \psi_{2(\beta_j, \alpha_j, \beta_{j+1})} \psi_{2(\beta_{p-1}, \alpha_{p-1}, \alpha_p)}} \Xi_{0,p}[\alpha, \beta]^2 \quad (94)$$

where

$$\psi_{2(\alpha,\beta,\gamma)} = \frac{q^{\frac{i}{2}(\rho_{\alpha+\beta+\gamma}|m_{\alpha+\beta+\gamma}|+\rho_{\underline{\alpha}+\beta+\gamma}|m_{\underline{\alpha}+\beta+\gamma}|+\rho_{\alpha+\underline{\beta}+\gamma}|m_{\alpha+\underline{\beta}+\gamma}|+\rho_{\alpha+\beta+\underline{\gamma}}|m_{\alpha+\beta+\underline{\gamma}}|)}{\varphi(-i\rho_{\alpha+\beta+\gamma},|m_{\alpha+\beta+\gamma}|)\varphi(-i\rho_{\underline{\alpha}+\beta+\gamma},|m_{\underline{\alpha}+\beta+\gamma}|)\varphi(-i\rho_{\alpha+\underline{\beta}+\gamma},|m_{\alpha+\underline{\beta}+\gamma}|)\varphi(-i\rho_{\alpha+\beta+\underline{\gamma}},|m_{\alpha+\beta+\underline{\gamma}}|)}.$$

Due to the following obvious properties,

$$\begin{aligned}\varphi_{(2\beta^r, -2m_{\beta-1})}^2 &= (-1)^{2m_{\beta}+1} \\ \varphi(i\rho_{\alpha+\beta+\gamma}, m_{\alpha+\beta+\gamma})\varphi(-i\rho_{\alpha+\beta+\gamma}, |m_{\alpha+\beta+\gamma}|) &= e^{i\frac{\pi}{2}(|m_{\alpha+\beta+\gamma}|-m_{\alpha+\beta+\gamma})} \\ (\nu_1(d_{\beta^l})\nu_1(d_{\underline{\beta}^r}))^2 &= (d_{\beta^l})_1(d_{\underline{\beta}^r})_1\end{aligned}$$

and the fact that $\Xi_{0,p}[\alpha, \beta]^2 (\Theta_{(\alpha_1, \alpha_2, \beta_3)} \prod_{j=3}^{p-2} \Theta_{(\beta_j, \alpha_j, \beta_{j+1})} \Theta_{(\beta_{p-1}, \alpha_{p-1}, \alpha_p)})^{-1}$ is analytic in the complex variables $\rho_{\beta_3}, \dots, \rho_{\beta_{p-1}}$, $\Upsilon_{0,p}[\alpha, \beta]$ is an analytic function of the real variables $\rho_{\beta_3}, \dots, \rho_{\beta_{p-1}}$. We will still use the notation $\Upsilon_{0,p}[\alpha, \beta]$ to denote its analytic continuation for $\rho_{\beta_3}, \dots, \rho_{\beta_{p-1}} \in \mathbb{C}$. \square

Remark: Note that $\Theta(\alpha, \beta, \gamma)$ is left invariant under permutation of α, β, γ and that $\Theta(\alpha, \beta, \gamma)$ is left invariant under the following shifts: $\Theta(\alpha + s, \beta, \gamma) = \Theta(\alpha, \beta, \gamma)$ for $s \in \mathbb{Z}^2$, and $\Theta(\alpha, \beta, \gamma) = \Theta(\alpha + (i\frac{\pi}{\ln q}, i\frac{\pi}{\ln q}), \beta, \gamma)$.

Proposition 11 *The space $H_{0,p}(\alpha)$ is endowed with the following pre-Hilbert space structure:*

$$\langle \tilde{\omega}_{0,p}(f) | \tilde{\omega}_{0,p}(g) \rangle = \int_{\mathbb{S}_P^{p-3}} d\beta \mathcal{P}[\beta] \overline{f(\beta)} \Upsilon_{0,p}[\alpha, \beta] g(\beta) . \quad (95)$$

Proof: We use injectivity of the map $f \mapsto \tilde{\omega}_{0,p}^\alpha(f)$ to show that this hermitian product is unambiguously defined. The convergence of the integrals in the real variables $\rho_{\beta_3}, \dots, \rho_{\beta_{p-1}}$ is ensured by the analyticity of the integrand and the convergence of the sums in $m_{\beta_3}, \dots, m_{\beta_{p-1}}$ comes from the fact that the wave packets have finite support in these discrete variables.

The positivity of this hermitian product is due to formulas (92)(204). Showing it is definite is trivial. \square

The major theorem of this section is the result that $H_{0,p}(\alpha)$ is a right unitary module of the moduli algebra $M_q(S^2, \overset{\alpha}{\Pi})$. This is a non trivial result which is divided in the following steps. In Lemma 1 we compute the action of an element of $M_q(S^2, \overset{\alpha}{\Pi})$ on $\tilde{\omega}_{0,p}^\alpha[\beta]$. In particular if β is in \mathbb{S}_P , the result is a linear combination of $\tilde{\omega}_{0,p}^\alpha[\gamma]$, with γ in \mathbb{S} . This comes from the fact that the observables are constructed with intertwiners of finite dimensional representations of $U_q(sl(2, \mathbb{C})_{\mathbb{R}})$ and that the tensor product of finite dimensional representations and principal representations decomposes as a finite direct sum of infinite dimensional representations, non unitary in general, of \mathbb{S} type as in (187). As a result the action of an element a of $M_q(S^2, \overset{\alpha}{\Pi})$ on $\tilde{\omega}_{0,p}^\alpha[f]$ can be defined after the

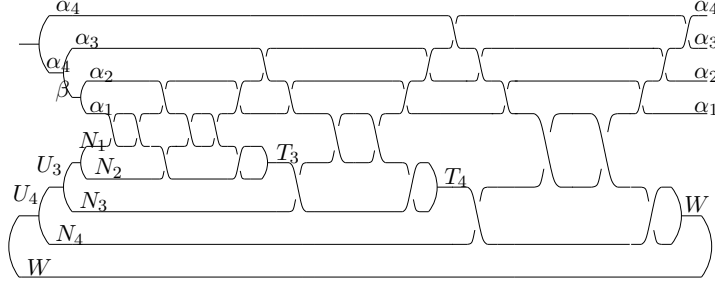

Figure 2: Expression of $\mathcal{F}_{0,4}^{P(+)}$.

use of a change of integration in the complex plane, thanks to Cauchy theorem. The proof of unitarity of this representation is reduced to properties of the kernel $\Upsilon_{0,p}$ under shifts.

Proposition 12 *Let $\beta \in \mathbb{S}^{p-3}$, the action of $\mathcal{O}_{0,p}^{P(\pm)} \in \mathcal{L}_{0,p}^{inv}$ on $\tilde{\omega}_{0,p}[\beta]$ is given by:*

$$\tilde{\omega}_{0,p}[\beta] \triangleleft \mathcal{O}_{0,p}^{P(\pm)} = \sum_{s \in \mathbb{S}^{p-3}} K_{0,p}^{P(\pm)} \left(\begin{array}{c} \alpha \\ \beta, s \end{array} \right) \tilde{\omega}_{0,p}[\beta + s] , \quad (96)$$

where:

1. the functions $K_{0,p}^{P(\pm)} \left(\begin{array}{c} \alpha \\ \beta, s \end{array} \right)$ are non zero only for a finite set of $s \in \mathbb{S}^{p-3}$ according to the selection rules imposed by the palette P . Moreover any element s of this finite set satisfy $s^l, s^r \in \mathbb{Z}^{p-3}$.

2. the functions $K_{0,p}^{P(\pm)} \left(\begin{array}{c} \alpha \\ \beta, s \end{array} \right)$ belong to $\frac{\Xi_{0,p}[\alpha, \beta + s]}{\Xi_{0,p}[\alpha, \beta]} \mathbb{C}(q^{i\rho_{\alpha_1}}, \dots, q^{i\rho_{\alpha_p}}, q^{i\rho_{\beta_3}}, \dots, q^{i\rho_{\beta_{p-3}}})$,

and more precisely we have: $K_{0,p}^{P(\pm)} \left(\begin{array}{c} \alpha \\ \beta, s \end{array} \right) \frac{\Xi_{0,p}[\alpha, \beta]}{\Xi_{0,p}[\alpha, \beta + s]} = \frac{P[\alpha, \beta]}{\prod_{j=3}^{p-1} Q_j(q^{i\rho_{\beta_j}})}$ where $P[\alpha, \beta] \in \mathbb{C}(q^{i\rho_{\alpha_1}}, \dots, q^{i\rho_{\alpha_p}})[q^{i\rho_{\beta_3}}, q^{-i\rho_{\beta_3}}, \dots, q^{i\rho_{\beta_{p-1}}}, q^{-i\rho_{\beta_{p-1}}}]$ and Q_j is a polynomial with zeroes in $\{q^n, n \in \frac{1}{2}\mathbb{Z}\}$.

Proof:

$$(\tilde{\omega}_{0,p}[\beta] \triangleleft \mathcal{O}_{0,p}^{P(\pm)}) I_a(\alpha) = \mathcal{F}_{0,p}^{P(\pm)} \left(\begin{array}{c} \alpha \\ \beta \end{array} \right) I_a(\alpha), \quad (97)$$

where $\mathcal{F}_{0,p}^{P(\pm)} \left(\begin{array}{c} \alpha \\ \beta \end{array} \right)$ are elements of $\text{Hom}_{U_q(\mathfrak{sl}(2, \mathbb{C})_{\mathbb{R}})}(\mathbb{V}, \mathbb{C})$. The picture for $\mathcal{F}_{0,p}^{P(+)} \left(\begin{array}{c} \alpha \\ \beta \end{array} \right)$

is shown in figure 2, whereas the picture for $\mathcal{F}_{0,p}^{P(-)} \left(\begin{array}{c} \alpha \\ \beta \end{array} \right)$ is the same after having turned overcrossing colored by couples of finite dimensional representations into the corresponding undercrossing. The picture for $p > 4$ punctures is a straightforward generalization.

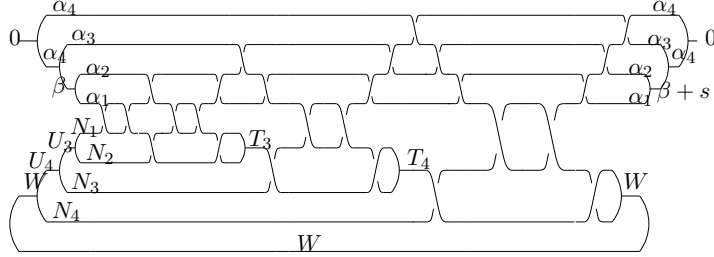

Figure 3: Expression of $K_{0,4}^{P(+)}$.

When $\alpha_1, \dots, \alpha_n, \beta_3, \dots, \beta_{p-3}$ are fixed elements of \mathbb{S}_F , the non zero elements of the family $\{\tilde{\omega}_{0,p}^\alpha[\beta + s], s \in \mathcal{S}^{p-3}\}$, form a basis of $\text{Hom}_{\text{U}_q(\text{sl}(2, \mathbb{C})_{\mathbb{R}})}(\tilde{\mathbb{V}}, \mathbb{C})$. As a result we obtain

$$\mathcal{F}_{0,p}^{P(\pm)} \begin{pmatrix} \alpha \\ \beta \end{pmatrix} = \sum_{s \in \mathcal{S}^{p-3}} K_{0,p}^{P(\pm)} \begin{pmatrix} \alpha \\ \beta, s \end{pmatrix} \tilde{\omega}_{0,p}^\alpha[\beta + s], \quad (98)$$

where $K_{0,p}^{P(\pm)} \begin{pmatrix} \alpha \\ \beta, s \end{pmatrix}$ can be computed as:

$$K_{0,p}^{P(\pm)} \begin{pmatrix} \alpha \\ \beta, s \end{pmatrix} = \mathcal{F}_{0,p}^{P(\pm)} \begin{pmatrix} \alpha \\ \beta \end{pmatrix} \tilde{\eta}[\beta + s] \quad (99)$$

with $\tilde{\eta}[\beta] = \Phi_{\beta_3}^{\alpha_1 \alpha_2} \Phi_{\beta_4}^{\beta_3 \alpha_3} \dots \Phi_{\alpha_p}^{\beta_{p-1} \alpha_{p-1}} \Phi_0^{\alpha_p \alpha_p}$.

$K_{0,p}^{P(+)} \begin{pmatrix} \alpha \\ \beta, s \end{pmatrix}$ is therefore represented by the picture of figure 3. The same comments for the figure representing $\mathcal{F}_{0,p}^{P(\pm)} \begin{pmatrix} \alpha \\ \beta \end{pmatrix}$ apply here.

Note that the selection rules in the finite dimensional case, implies that if $\tilde{\omega}_{0,p}^\alpha[\beta] \neq 0$ then the possible non zero elements $\tilde{\omega}_{0,p}^\alpha[\beta + s]$ are those for s satisfying $s^l, s^r \in \mathbb{Z}^{p-3}$.

Using the property (22) of factorization of finite dimensional intertwiners, we obtain that

$$K_{0,p}^{P(\pm)} \begin{pmatrix} \alpha \\ \beta, s \end{pmatrix} = K_{0,p}^{Pl(\pm)} \begin{pmatrix} \alpha^l \\ \beta^l, s^l \end{pmatrix} K_{0,p}^{Pr(\pm)} \begin{pmatrix} \alpha^r \\ \beta^r, s^r \end{pmatrix} \quad (100)$$

where $K_{0,p}^{Pl(\pm)} \begin{pmatrix} \alpha^l \\ \beta^l, s^l \end{pmatrix}, K_{0,p}^{Pr(\pm)} \begin{pmatrix} \alpha^r \\ \beta^r, s^r \end{pmatrix}$ are computed (223) in the appendix (B.1) and expressed in terms of $6j(0)$ coefficients. As a result it is straightforward to define a continuation of $K_{0,p}^{P(\pm)} \begin{pmatrix} \alpha \\ \beta, s \end{pmatrix}$ for $\alpha_1, \dots, \alpha_p, \beta_3, \dots, \beta_{p-1} \in \mathbb{S}, s \in \mathcal{S}^{p-3}$ maintaining (100) and by replacing where needed $6j(0)$ by $6j(1)$ or $6j(3)$ in (223).

It can be checked, from this definition, that $\frac{\Xi_{0,p}[\alpha,\beta]}{\Xi_{0,p}[\alpha,\beta+s]} \frac{P}{K}_{0,p}(\pm) \begin{pmatrix} \alpha \\ \beta, s \end{pmatrix}$ is a rational function in $q^{i\rho_{\alpha_1}}, \dots, q^{i\rho_{\alpha_p}}, q^{i\rho_{\beta_3}}, \dots, q^{i\rho_{\beta_{p-3}}}$.

We recall that $\omega_{0,p}^\alpha [\beta]_a^I \Xi_{0,p}[\alpha, \beta] \nu^I(\alpha)$ is an element of $\mathbb{C}(q^{i\rho_{\alpha_1}}, \dots, q^{i\rho_{\alpha_p}}, q^{i\rho_{\beta_3}}, \dots, q^{i\rho_{\beta_{p-3}}})$. From this property we can deduce the more general result that $\mathcal{F}_{0,p}(\pm) \begin{pmatrix} \alpha \\ \beta \end{pmatrix}^I e_a(\alpha) \Xi_{0,p}[\alpha, \beta] \nu^I(\alpha)$ is also an element of $\mathbb{C}(q^{i\rho_{\alpha_1}}, \dots, q^{i\rho_{\alpha_p}}, q^{i\rho_{\beta_3}}, \dots, q^{i\rho_{\beta_{p-3}}})$. The property in $q^{i\rho_{\beta_3}}, \dots, q^{i\rho_{\beta_{p-3}}}$ is a direct consequence of the definition of $\Xi_{0,p}[\alpha, \beta]$, the only non trivial fact is to show that this also holds for $q^{i\rho_{\alpha_1}}, \dots, q^{i\rho_{\alpha_p}}$. This comes from the structure of the graph in the figure 2, the expression of \mathbb{R} in terms of the coefficients $\Lambda_{AD}^{BC}(\alpha)$, and the fact that $\frac{\mathcal{N}^{(A)}(\alpha)}{\mathcal{N}^{(D)}(\alpha)} \Lambda_{AD}^{BC}(\alpha)$ is a Laurent polynomial in $q^{i\rho_\alpha}$.

As a result we obtain that:

$$\Xi_{0,p}[\alpha, \beta] \nu^I(\alpha) \frac{P}{\mathcal{F}_{0,p}}(\pm) \begin{pmatrix} \alpha \\ \beta \end{pmatrix}^I_a - \sum_{s \in \mathcal{S}^{p-3}} \frac{\Xi_{0,p}[\alpha, \beta]}{\Xi_{0,p}[\alpha, \beta + s]} \frac{P}{K}_{0,p}(\pm) \begin{pmatrix} \alpha \\ \beta, s \end{pmatrix} (\omega_{0,p}[\beta + s])_a^I \Xi[\alpha, \beta + s] \nu^I(\alpha),$$

is an element of $\mathbb{C}(q^{i\rho_{\alpha_1}}, \dots, q^{i\rho_{\alpha_p}}, q^{i\rho_{\beta_3}}, \dots, q^{i\rho_{\beta_{p-1}}})$ which vanishes for an infinite number of sufficiently large $i\rho_{\alpha_1}, \dots, i\rho_{\alpha_p}, i\rho_{\beta_3}, \dots, i\rho_{\beta_{p-1}} \in \frac{1}{2}\mathbb{Z}^+$. As a result this rational function is nul and we obtain relation (96). \square

Remark. If $a \in \mathcal{L}_{0,p}^{inv}$, $a = \sum_P \lambda_P \mathcal{O}_{0,p}^{P(\pm)}$ we define

$$K_{0,p}^a(\pm) \begin{pmatrix} \alpha \\ \beta, s \end{pmatrix} = \sum_P \lambda_P K_{0,p}^{P(\pm)} \begin{pmatrix} \alpha \\ \beta, s \end{pmatrix}.$$

We will now endow $H_{0,p}(\alpha)$ with a structure of right $\mathcal{L}_{0,p}^{inv}$ module in the following sense:

Proposition 13 $\mathcal{L}_{0,p}^{inv}$ acts on $\mathbb{V}(\alpha)^*$ with $\rho_{0,p}[\alpha]$ and leaves the space $(\mathbb{V}(\alpha)^*)^{U_q(sl(2, \mathbb{C})_{\mathbb{R}})}$ invariant. However the subspace $H_{0,p}(\alpha)$ is in general not invariant. We define the domain of $a \in \mathcal{L}_{0,p}^{inv}$ associated to $\rho_{0,p}[\alpha]$ to be the subspace $D(a) \subset \mathbb{A}^{(p-3)}$ defined as:

f belongs to $D(a)$ if and only if for all $s \in \mathcal{S}^{p-3}$ the functions

$$\beta \mapsto K_{0,p}^a(\pm) \begin{pmatrix} \alpha \\ \beta, s \end{pmatrix} \frac{\Xi_{0,p}[\alpha, \beta] \mathcal{P}[\beta]}{\Xi_{0,p}[\alpha, \beta + s] \mathcal{P}[\beta + s]} f(\beta)$$

are elements of $\mathbb{A}^{(p-3)}$. The action of a on an element $\omega_{0,p}^\alpha(f) \in D(a) \subset H_{0,p}(\alpha)$ belongs to $H_{0,p}(\alpha)$, and we have:

$$\omega_{0,p}^\alpha(f) \triangleleft a = \omega_{0,p}^\alpha(f \triangleleft a),$$

with

$$(f \triangleleft a)(\beta) = \sum_{s \in \mathcal{S}^{p-3}} f(\beta - s) K_{0,p}^a(\pm) \begin{pmatrix} \alpha \\ \beta - s, s \end{pmatrix} \frac{\Xi_{0,p}[\alpha, \beta - s] \mathcal{P}[\beta - s]}{\Xi_{0,p}[\alpha, \beta] \mathcal{P}[\beta]}. \quad (101)$$

In general the domain $D(a)$ is not equal to $\mathbb{A}^{(p-3)}$, but it always contains $Q_a[\beta] \mathbb{A}^{(p-3)}$ where $Q_a[\beta] = \prod_{j=3}^{p-3} ((2\beta_j^l + n_j)_{k_j})^{p_j} ((2\beta_j^r + n'_j)_{k'_j})^{p'_j}$ for some n_j, n'_j integers and k_j, k'_j, p_j, p'_j non negative integers depending on a .

Proof: This property follows from the invariance of the sum of integrals under the change $\beta \mapsto \beta - s$, which amounts to replace m_β by $m_\beta - m_s$ and ρ_β by $\rho_\beta - \rho_s$ with $\rho_s \in i\mathbb{Z}$ given by $i\rho_s = s^l + s^r + 1$. The former is a change of index in a sum whereas the latter is implied by Cauchy Theorem if the function considered is analytic, which follows from the definition of $D(a)$. \square

It is clear from the properties (88), that the anti-representation $\rho_{0,p}[\alpha]$ on $H_{0,p}[\alpha]$ depends to the quotient, and defines an anti-representation $\tilde{\rho}_{0,p}[\alpha]$ of $M_q(S^2, SL(2, \mathbb{C})_{\mathbb{R}}; \alpha)$.

Our main result is that $\tilde{\rho}_{0,p}[\alpha]$ is unitary.

Theorem 1 *The anti-representation $\tilde{\rho}_{0,p}[\alpha]$ of $M_q(S^2, SL(2, \mathbb{C})_{\mathbb{R}}; \alpha)$ is unitary:*

$$\forall a \in M_q(S^2, SL(2, \mathbb{C})_{\mathbb{R}}, [\alpha]), \forall v \in D(a^*), \forall w \in D(a), \langle v \triangleleft a^* | w \rangle = \langle v | w \triangleleft a \rangle. \quad (102)$$

where $\langle . | . \rangle$ is the positive sesquilinear form defined by (95).

Proof: The first step amounts to extend to \mathbb{S}^{p-3} the function $\beta \mapsto \Upsilon_{0,p}[\alpha, \beta]$ entering in the definition of $\langle . | . \rangle$. For this task we use lemma 5. As a result, the extension of $\Upsilon_{0,p}[\alpha, \beta]$, denoted by the same notation, is an entire function in the variables $\rho_{\beta_3}, \dots, \rho_{\beta_{p-1}}$. We then compute:

$$\begin{aligned} & \langle \tilde{\omega}_{0,p}^\alpha(f) | \tilde{\omega}_{0,p}^\alpha(g) \triangleleft \tilde{\mathcal{O}}_{0,p}^{(+)} \rangle = \\ & \sum_s \int_{\mathbb{S}_P^{p-3}} d\beta \mathcal{P}(\beta + s) \overline{f(\beta)} \Upsilon_{0,p}[\alpha, \beta] g(\beta + s) K_{0,p}^{P(+)} \left(\begin{array}{c} \alpha \\ \beta + s, -s \end{array} \right) \frac{\Xi_{0,p}[\alpha, \beta + s]}{\Xi_{0,p}[\alpha, \beta]}. \end{aligned}$$

On the other hand we have:

$$\begin{aligned} & \langle \tilde{\omega}_{0,p}^\alpha(f) \triangleleft (\tilde{\mathcal{O}}_{0,p}^{(+)})^* | \tilde{\omega}_{0,p}^\alpha(g) \rangle = \langle \tilde{\omega}_{0,p}^\alpha(f) \triangleleft \tilde{\mathcal{O}}_{0,p}^{(-)} | \tilde{\omega}_{0,p}^\alpha(g) \rangle = \\ & = \sum_s \int_{\mathbb{S}_P^{p-3}} d\beta \mathcal{P}(\beta + s) \overline{f(\beta + s)} \Upsilon_{0,p}[\alpha, \beta] g(\beta) \overline{K_{0,p}^{\tilde{P}(-)} \left(\begin{array}{c} \alpha \\ \beta + s, -s \end{array} \right)} \frac{\overline{\Xi_{0,p}[\alpha, \beta + s]}}{\overline{\Xi_{0,p}[\alpha, \beta]}} \\ & = \sum_s \int_{\mathbb{S}_P^{p-3}} d\beta \mathcal{P}(\beta + s) \overline{f(\beta + s)} \Upsilon_{0,p}[\alpha, \beta] g(\beta) K_{0,p}^{\tilde{P}(-)} \left(\begin{array}{c} \bar{\alpha} \\ \bar{\beta} + s, -s \end{array} \right) \frac{\overline{\Xi_{0,p}[\alpha, \beta + s]}}{\overline{\Xi_{0,p}[\alpha, \beta]}}. \end{aligned}$$

Using Cauchy theorem to shift ρ_β in $\rho_\beta + \rho_s$ and simultaneously changing the index of the sum over the dumb variable m_β and s , the last expression is also equal to:

$$\sum_s \int_{\mathbb{S}_P^{p-3}} d\beta \mathcal{P}[\beta] \overline{f(\beta)} \Upsilon_{0,p}[\alpha, \beta + s] g(\beta + s) K_{0,p}^{\tilde{P}(-)} \left(\begin{array}{c} \bar{\alpha} \\ \bar{\beta}, -\tilde{s} \end{array} \right) \frac{\overline{\Xi_{0,p}[\alpha, \beta]}}{\overline{\Xi_{0,p}[\alpha, \beta + s]}}.$$

As a result, proving unitarity is equivalent to showing the relation:

$$\begin{aligned} \Upsilon_{0,p}[\alpha, \beta] K_{0,p}^{P(+)} \left(\begin{array}{c} \alpha \\ \beta + s, -s \end{array} \right) \frac{\Xi_{0,p}[\alpha, \beta + s]}{\Xi[\alpha, \beta]} \mathcal{P}[\beta + s] = \\ \Upsilon_{0,p}[\alpha, \beta + s] K_{0,p}^{\tilde{P}(-)} \left(\begin{array}{c} \bar{\alpha} \\ \bar{\beta}, -\tilde{s} \end{array} \right) \frac{\overline{\Xi_{0,p}[\alpha, \beta]}}{\overline{\Xi_{0,p}[\alpha, \beta + s]}} \mathcal{P}[\beta], \end{aligned} \quad (103)$$

when $\beta \in \mathbb{S}^{p-3}$. We now make use of the symmetries of the relations satisfied by $\overset{P}{K}_{0,p}^{(+)} \left(\begin{array}{c} \alpha \\ \beta, s \end{array} \right)$ proved in the proposition (31) of the appendix A.3.

$$\overset{P}{K}_{0,p}^{(-)} \left(\begin{array}{c} \bar{\alpha} \\ \bar{\beta}, -\bar{s} \end{array} \right) = \overset{P}{K}_{0,p}^{(-)} \left(\begin{array}{c} \tilde{\alpha} \\ \tilde{\beta}, -\tilde{s} \end{array} \right) = \overset{P}{K}_{0,p}^{(+)} \left(\begin{array}{c} \alpha \\ \underline{\beta} - s, s \end{array} \right) = \psi_{0,p}[\alpha, \beta, s] \overset{P}{K}_{0,p}^{(+)} \left(\begin{array}{c} \alpha \\ \beta + s, -s \end{array} \right)$$

As a result the unitarity condition is equivalent to prove the following quasi-invariance under imaginary integer shifts:

$$\frac{\Upsilon_{0,p}[\alpha, \beta]}{|\Xi_{0,p}[\alpha, \beta]|^2 \mathcal{P}(\beta)} = \frac{\Upsilon_{0,p}[\alpha, \beta + s]}{|\Xi_{0,p}[\alpha, \beta + s]|^2 \mathcal{P}(\beta + s)} \psi_{0,p}[\alpha, \beta, s] \quad (104)$$

which, due to the explicit expression of $\Upsilon_{0,p}[\alpha, \beta]$, reduces to

$$\frac{\psi_{1(\alpha_1, \alpha_2, \beta_3 + s_3)} \prod_{j=3}^{p-2} \psi_{1(\beta_j + s_j, \alpha_j, \beta_{j+1} + s_{j+1})} \psi_{1(\alpha_{p-1}, \beta_{p-1} + s_{p-1}, \alpha_p)}}{\psi_{1(\alpha_1, \alpha_2, \beta_3)} \prod_{j=3}^{p-2} \psi_{1(\beta_j, \alpha_j, \beta_{j+1})} \psi_{1(\alpha_{p-1}, \beta_{p-1}, \alpha_p)}} = \psi_{0,p}[\alpha, \beta, s] \quad (105)$$

which is a trivial fact. \square

III.2.2 The moduli algebra of a genus-n surface

In this subsection, we will construct a unitary representation of the moduli algebra on a surface of arbitrary genus n . The graph algebra $\mathcal{L}_{n,0}$ is isomorphic to $H(U_q(sl(2, \mathbb{C})_{\mathbb{R}}))^{\otimes n}$ and acts on $Fun_{cc}(SL(2, \mathbb{C})_{\mathbb{R}})^{\otimes n}$. In order to find invariant vectors, we will apply the technique developed in the p -punctures case: we will transfer this action on the dual space $(Fun_{cc}(SL(2, \mathbb{C})_{\mathbb{R}})^{\otimes n})^*$ and extract a subspace of invariant elements. We use the notations of the end of appendix A.1. Let $\alpha \in \mathbb{S}^n$, we define an element $\prod_{k=n}^1 \overset{\alpha_k}{\mathbb{G}}(k) \in (U_q(sl(2, \mathbb{C})_{\mathbb{R}})^*)^{\otimes n} \otimes \otimes_{k=n}^1 \text{End}(\overset{\alpha_k}{\mathbb{V}})$, where $\overset{\alpha_k}{\mathbb{G}}(k) = p_k(\overset{\alpha_k}{\mathbb{G}})$ where p_k is the inclusion of $U_q(sl(2, \mathbb{C})_{\mathbb{R}})^*$ in the k -th copy of $(U_q(sl(2, \mathbb{C})_{\mathbb{R}})^*)^n$.

From this element we construct an element of $(Fun_{cc}(SL(2, \mathbb{C})_{\mathbb{R}})^{\otimes n})^* \otimes \otimes_{k=n}^1 \text{End}(\overset{\alpha_k}{\mathbb{V}})$ defined as $\iota^{\otimes n}(\otimes_{k=n}^1 \overset{\alpha_k}{\mathbb{G}}) = \prod_{k=n}^1 \iota(\overset{\alpha_k}{\mathbb{G}}(k))$ where ι is recalled in the appendix A.1 The action of the lattice algebra on $\iota(\overset{\alpha_k}{\mathbb{G}}(k))$ is easily computed by dualization:

$$\begin{aligned} \iota(\overset{\alpha_k}{\mathbb{G}}(k)) \triangleleft \overset{I}{\mathbb{L}}(\pm)(k) &= \iota(\overset{\alpha_k}{\mathbb{G}}(k)) \overset{I}{\mathbb{R}}^{\alpha_k(\pm)-1} \quad , \quad \iota(\overset{\alpha_k}{\mathbb{G}}(k)) \triangleleft \overset{I}{\mathbb{L}}(\pm)(j) = \iota(\overset{\alpha_k}{\mathbb{G}}(k)) \quad \forall j \neq k, \\ \iota(\overset{\alpha_k}{\mathbb{G}}(k)) \triangleleft \overset{I}{\mathbb{L}}(\pm)(k) &= \overset{I}{\mathbb{R}}^{\alpha_k(\pm)} \iota(\overset{\alpha_k}{\mathbb{G}}(k)) \quad , \quad \iota(\overset{\alpha_k}{\mathbb{G}}(k)) \triangleleft \overset{I}{\mathbb{L}}(\pm)(j) = \iota(\overset{\alpha_k}{\mathbb{G}}(k)) \quad \forall j \neq k, \\ \iota(\overset{\alpha_k}{\mathbb{G}}(k)) \triangleleft \overset{I}{\mathbb{G}}(k) &= \sum_{\alpha'_k \in \mathbb{S}(\alpha_k, I)} \Phi_{\alpha'_k}^{\alpha_k I} \iota(\overset{\alpha'_k}{\mathbb{G}}(k)) \Psi_{\alpha_k I}^{\alpha'_k} \quad , \quad \iota(\overset{\alpha_k}{\mathbb{G}}(k)) \triangleleft \overset{I}{\mathbb{G}}(j) = \iota(\overset{\alpha_k}{\mathbb{G}}(k)) \iota(\overset{I}{\mathbb{G}}(j)) \quad \forall j \neq k. \end{aligned} \quad (106)$$

Before studying the general case, it is interesting to give a detailed exposition of the genus one case which contains all the ideas without being too cumbersome.

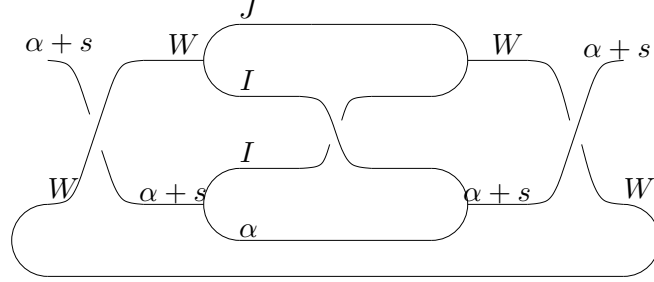

Figure 4: Expression of $K_{1,0}^P$.

Given $\alpha \in \mathbb{S}$, we can define the character $\omega_{1,0}(\alpha) \in (\text{Fun}_{cc}(SL_q(2, \mathbb{C})))^*$ of this representation by ([12]):

$$\omega_{1,0}(\alpha) = \sum_{ABC} \begin{pmatrix} j & l & C \\ A & B & n \end{pmatrix} \begin{pmatrix} n & B & A \\ C & m & i \end{pmatrix} \Lambda_A^{BC}(\alpha) \iota(k_j^A \otimes E_l^B). \quad (107)$$

The algebra $\mathcal{L}_{1,0}^{inv}$ acts on the right of $(\text{Fun}_{cc}(SL_q(2, \mathbb{C})))^*$ with $\rho_{1,0}$ and we obviously have:

$$\omega_{1,0}(\alpha) \triangleleft \overset{I}{C}_{1,0} = \omega_{1,0}(\alpha). \quad (108)$$

Lemma 6 The element $\overset{IJW}{\mathcal{O}}_{1,0}$ acts on the invariant element $\omega_{1,0}(\alpha)$ as follows:

$$\omega_{1,0}(\alpha) \triangleleft \overset{IJW}{\mathcal{O}}_{1,0} = \sum_{s \in \mathcal{S}} \Lambda_{II}^{WJ}[\alpha, s] \omega_{1,0}(\alpha + s) \quad (109)$$

where $\Lambda_{II}^{WJ}[\alpha, s]$ is given in the definition (11).

Proof: Computing the action of $\overset{IJW}{\mathcal{O}}_{1,0}$ on $\omega_{1,0}(\alpha)$ amounts to evaluate the intertwiner given by the graph (figure 4) which is equal to $\Lambda_{II}^{WJ}[\alpha, s]$. \square

Proposition 14 We define a subset of $(\text{Fun}_{cc}(SL_q(2, \mathbb{C})))^*$ by:

$$H_{1,0} = \{ \omega_{1,0}(f) = \int_{\mathbb{S}_P} d\alpha \mathcal{P}(\alpha) f(\alpha) \omega_{1,0}(\alpha), \quad f \in \mathbb{A} \}. \quad (110)$$

$\rho_{1,0}$ defines a right action of $\mathcal{L}_{1,0}^{inv}$ on $(\text{Fun}_{cc}(SL_q(2, \mathbb{C})))^*$ which in general does not leave $H_{1,0}$ invariant. To the element $\overset{IJW}{\mathcal{O}}_{1,0}$ in $\mathcal{L}_{1,0}^{inv}$ we define its domain $D(\overset{IJW}{\mathcal{O}}_{1,0}) \subset \mathbb{A}$ as: f belongs to $D(\overset{IJW}{\mathcal{O}}_{1,0})$ if and only if $\alpha \mapsto \Lambda_{II}^{WJ}[\alpha, s] \frac{\mathcal{P}(\alpha)}{\mathcal{P}(\alpha+s)} f(\alpha)$ is an element of \mathbb{A} for all $s \in \mathcal{S}$. We therefore have:

$$\omega_{1,0}(f) \triangleleft \overset{IJW}{\mathcal{O}}_{1,0} = \omega_{1,0}(f \triangleleft \overset{IJW}{\mathcal{O}}_{1,0}) \quad (111)$$

with

$$(f \triangleleft \mathcal{O}_{1,0}^{IJW})(\alpha) = \sum_{s \in \mathcal{S}} f(\alpha + s) \Lambda_{II}^{WJ}[\alpha + s, -s] \frac{\mathcal{P}(\alpha + s)}{\mathcal{P}(\alpha)}. \quad (112)$$

The map $\mathbb{A} \rightarrow H_{1,0}$ which sends f to $\omega_{1,0}(f)$ is an injection. We can therefore endow $H_{1,0}$ with the following pre-Hilbert structure

$$\langle \omega_{1,0}(f) | \omega_{1,0}(g) \rangle = \int_{\mathbb{S}_P} d\alpha \mathcal{P}(\alpha)^2 \overline{f(\alpha)} g(\alpha). \quad (113)$$

The right action $\rho_{1,0}$ acting on $H_{1,0}$ descends to the quotient $M_q(\Sigma_{1,0}, SL(2, \mathbb{C})_{\mathbb{R}})$ defines a right action $\tilde{\rho}_{1,0}$, which is unitary.

Proof: It is important to note that $\langle \omega_{1,0}(\alpha), \phi \rangle$ where $\phi \in Fun_{cc}(SL_q(2, \mathbb{C})_{\mathbb{R}})$ is a Laurent polynomial in $q^{i\rho\alpha}$ because $\Lambda_{AA}^{BC}(\alpha)$ is itself a Laurent polynomial in $q^{i\rho\alpha}$. As a result $\omega_{1,0}(f)$ is well defined for $f \in \mathbb{A}$ and the proof of the relation (112) follows from Cauchy theorem.

The proof of the injection is a straightforward consequence of the proof of Theorem 12 of [12]. Indeed if we have $\omega_{1,0}(f) = 0$, it implies that $\int_{\mathbb{S}_P} d\alpha \mathcal{P}(\alpha) \Lambda_A^{BC}(\alpha) f(\alpha) = 0$, for every A, B, C . The proof of Plancherel theorem 12 of [12] precisely shows that under weaker condition on f than $f \in \mathbb{A}$ the last relation implies $f = 0$.

To prove the unitarity, we compute

$$\langle \omega_{1,0}(f) | \omega_{1,0}(g) \triangleleft \mathcal{O}_{1,0}^{IJW} \rangle = \sum_{s \in \mathcal{S}} \int_{\mathbb{S}_P} d\alpha \mathcal{P}(\alpha) \mathcal{P}(\alpha + s) \overline{f(\alpha)} \Lambda_{II}^{WJ}[\alpha + s, -s] g(\alpha + s).$$

On the other hand we have

$$\begin{aligned} \langle \omega_{1,0}(f) \triangleleft \mathcal{O}_{1,0}^{IJW} | \omega_{1,0}(g) \rangle &= \sum_{s \in \mathcal{S}} \int_{\mathbb{S}_P} d\alpha \mathcal{P}(\alpha) \mathcal{P}(\alpha + s) \overline{f(\alpha + s)} \overline{\Lambda_{II}^{\tilde{W}\tilde{J}}[\alpha + s, -s]} g(\alpha) \\ &= \sum_{s \in \mathcal{S}} \int_{\mathbb{S}_P} d\alpha \mathcal{P}(\alpha) \mathcal{P}(\alpha + s) \overline{f(\alpha + s)} \Lambda_{II}^{\tilde{W}\tilde{J}}[\bar{\alpha} + s, -s] g(\alpha). \end{aligned}$$

Using Cauchy theorem to shift ρ_β and changing the index of the sum, the last expression is equal to

$$\sum_{s \in \mathcal{S}} \int_{\mathbb{S}_P} d\alpha \mathcal{P}(\alpha) \mathcal{P}(\alpha + s) \overline{f(\alpha)} \Lambda_{II}^{\tilde{W}\tilde{J}}[\bar{\alpha}, -\tilde{s}] g(\alpha + s).$$

As a result, proving the unitarity is equivalent to showing the relation:

$$\Lambda_{II}^{\tilde{W}\tilde{J}}[\bar{\alpha}, -\tilde{s}] = \Lambda_{II}^{WJ}[\alpha + s, -s],$$

which is consequence of the equality: $\Lambda_{AD}^{BC}(\alpha) = \Lambda_{AD}^{BC}(\underline{\alpha})$. \square

The simplest non trivial observables are the Wilson loops $\overset{I}{W}_A$ and $\overset{I}{W}_B$ around the handles taken in the representation $I \in \mathbb{S}_F$. It is straightforward, from the previous proposition, to compute the action of these observables:

$$(f \triangleleft \overset{I}{W}_A)(\alpha) = \sum_{s^l = -I^l, s^r = -I^r}^{s^l = I^l, s^r = I^r} \frac{v_{\alpha+s}}{v_\alpha} f(\alpha + s) \quad (114)$$

$$(f \triangleleft \overset{I}{W}_B)(\alpha) = \vartheta_{I\alpha} f(\alpha). \quad (115)$$

From the representation of the Heisenberg double, W_A acts by multiplication in the real space and by finite difference in the Fourier space whereas W_B acts by left and right derivations in the real space and by multiplication in the Fourier space.

This closes the construction for the genus one. The generalization to the genus n is similar in spirit although the technical details are much more involved. This is what we will now develop. We will assume that $n \geq 2$.

Let $\alpha, \beta, \gamma \in \mathbb{S}$ and let $A \in \text{End}(\overset{\alpha}{\mathbb{V}})$ of finite dimensional corank, we can define $(A \otimes 1)\Phi_\gamma^{\alpha\beta} \in \text{Hom}(\overset{\gamma}{\mathbb{V}}, \overset{\alpha}{\mathbb{V}} \otimes \overset{\beta}{\mathbb{V}})$ as follows

$$(A \otimes 1)\Phi_\gamma^{\alpha\beta}(v) = \sum_{I, J, i, j} \langle \overset{I}{e}_i \ast \otimes \overset{J}{e}_j \ast, \Phi_\gamma^{\alpha\beta}(v) \rangle (A \overset{I}{e}_i) \otimes \overset{J}{e}_j \quad (116)$$

where the sums are finite. A similar conclusion holds true for $(1 \otimes B)\Phi_\gamma^{\alpha\beta}$ with $\text{corank}(B) < +\infty$.

Definition 9 Let $\lambda = (\lambda_1, \dots, \lambda_n)$ element of \mathbb{S}^n , and $\sigma = (\sigma_3, \dots, \sigma_n), \tau = (\tau_3, \dots, \tau_n)$ elements of \mathbb{S}^{n-2} and $\kappa \in \mathbb{S}$. We define for $2 \leq n$

$$\begin{aligned} \wp_2 &= \Psi_{\lambda_2 \lambda_1}^{\sigma_3} \iota(\overset{\lambda_2}{\mathbb{G}}(2)) \overset{\lambda_2}{\mu}^{-1} \overset{\lambda_2 \lambda_1}{\mathbb{R}'} \overset{\lambda_2}{\mu} \iota(\overset{\lambda_1}{\mathbb{G}}(1)) \overset{\lambda_2 \lambda_1}{\mathbb{R}}^{(-)} \Phi_{\tau_3}^{\lambda_2 \lambda_1}, \\ &\in (\text{Fun}_{cc}(SL_q(2, \mathbb{C})_{\mathbb{R}})^{\otimes n})^* \otimes \text{Hom}(\overset{\tau_3}{\mathbb{V}}, \overset{\sigma_3}{\mathbb{V}}), \\ \wp_i &= \Psi_{\lambda_i \sigma_i}^{\sigma_{i+1}} \iota(\overset{\lambda_i}{\mathbb{G}}(i)) \overset{\lambda_i}{\mu}^{-1} \overset{\lambda_i \sigma_i}{\mathbb{R}'} \overset{\lambda_i}{\mu} \wp_{i-1} \overset{\lambda_i \sigma_i}{\mathbb{R}}^{(-)} \Phi_{\tau_{i+1}}^{\lambda_i \tau_i}, \\ &\in (\text{Fun}_{cc}(SL_q(2, \mathbb{C})_{\mathbb{R}})^{\otimes n})^* \otimes \text{Hom}(\overset{\tau_{i+1}}{\mathbb{V}}, \overset{\sigma_{i+1}}{\mathbb{V}}), \quad \forall i = 3, \dots, n, \end{aligned} \quad (117)$$

with the convention $\tau_{n+1} = \sigma_{n+1} = \kappa$.

We can introduce $\omega_{n,0}[\kappa, \lambda, \sigma, \tau] \in (\text{Fun}_{cc}(SL_q(2, \mathbb{C})_{\mathbb{R}})^{\otimes n})^*$ as being:

$$\omega_{n,0}(\kappa, \lambda, \sigma, \tau) = \text{tr}_\kappa(\wp_n). \quad (118)$$

$\omega_{n,0}[\kappa, \lambda, \sigma, \tau]$ is well defined because $\langle \omega_{n,0}[\kappa, \lambda, \sigma, \tau], f_n \otimes \dots \otimes f_1 \rangle = \text{tr}_\kappa(\langle \wp_n, f_n \otimes \dots \otimes f_1 \rangle)$ and $\langle \wp_n, f_n \otimes \dots \otimes f_1 \rangle$ is, by construction, of finite rank and finite corank.

Proposition 15 $\omega_{n,0}[\kappa, \lambda, \sigma, \tau]$ are invariant vectors: $\omega_{n,0}[\kappa, \lambda, \sigma, \tau] \triangleleft \overset{I}{C}_{n,0} = \omega_{n,0}[\kappa, \lambda, \sigma, \tau]$.

Proof:Using

$$\iota(\mathbb{G}(i)) \triangleleft C_{n,0}^{(\pm)-1} = \mathbb{R}^{I\lambda_i(\pm)-1} \iota(\mathbb{G}(i)) \begin{matrix} I \\ \mu \end{matrix} \begin{matrix} I\lambda_i(\pm) \\ \mathbb{R} \end{matrix} \begin{matrix} I \\ \mu^{-1} \end{matrix},$$

it is immediate to show, by recursion, that

$$\wp_i \triangleleft C_{n,0}^{(\pm)-1} = \mathbb{R}^{I\sigma_{i+1}(\pm)-1} \wp_i \begin{matrix} I \\ \mu \end{matrix} \begin{matrix} I\tau_{i+1}(\pm) \\ \mathbb{R} \end{matrix} \begin{matrix} I \\ \mu^{-1} \end{matrix} \quad \forall i = 2, \dots, n-1.$$

and then

$$\wp_n \triangleleft C_{n,0}^{(\pm)-1} = \mathbb{R}^{I\kappa(\pm)-1} \wp_n \begin{matrix} I \\ \mu \end{matrix} \begin{matrix} I\kappa(\pm) \\ \mathbb{R} \end{matrix} \begin{matrix} I \\ \mu^{-1} \end{matrix}$$

which allows us to conclude. \square

We will denote for $n \geq 2$,

$$\begin{aligned} \hat{\Xi}_{n,0}[\kappa, \lambda, \sigma, \tau]^{-1} &= e^{2i\pi(\lambda_1 + \dots + \lambda_n - \kappa)} \nu_1(d_\kappa)^2 \zeta(\lambda_1, \lambda_2, \tau_3) \prod_{j=3}^n \zeta(\lambda_j, \tau_j, \tau_{j+1}) \times \\ &\times \zeta(\lambda_1, \lambda_2, \sigma_3) \prod_{j=3}^n \zeta(\lambda_j, \sigma_j, \sigma_{j+1}) \prod_{j=3}^n \nu_1(d_{\sigma_j}) \nu_1(d_{\tau_j}). \end{aligned} \quad (119)$$

We have the analogue of the lemma (4) :

Lemma 7 *Let $f \in Fun_{cc}(SL_q(2, \mathbb{C}))^{\otimes n}$, for every $x \in \kappa \cup \lambda \cup \sigma \cup \tau$ there exists $I_x \in \frac{1}{2}\mathbb{N}$, such that*

$$\hat{\Xi}_{n,0}[\kappa, \lambda, \sigma, \tau] \prod_{x \in \kappa \cup \lambda \cup \sigma \cup \tau} (\nu^{(I_x)}(x))^2 < \omega_{n,0}[\kappa, \lambda, \tau, \sigma], f >$$

is a Laurent polynomial in the variables $(q^{i\rho_x})$, $x \in \kappa \cup \lambda \cup \sigma \cup \tau$.

Proof:The proof is analogous to the related lemma of the p-punctures case. \square

We will denote $\Xi_{n,0}[\kappa, \lambda, \sigma, \tau] = \hat{\Xi}_{n,0}[\kappa, \lambda, \sigma, \tau] \xi[\kappa] \xi[\lambda] \xi[\tau] \xi[\sigma]$.

Proposition 16 *We can define a subset of $(Fun_{cc}(SL_q(2, \mathbb{C}))^{\otimes n})^*$ by:*

$$H_{n,0} = \{\omega_{n,0}(f), f \in \mathbb{A}^{(3n-3)}\} \quad (120)$$

where

$$\omega_{n,0}(f) = \int_{\mathbb{S}_P^{3n-3}} dk d\lambda d\sigma d\tau \omega_{n,0}[\kappa, \lambda, \sigma, \tau] \Xi_{n,0}[\kappa, \lambda, \sigma, \tau] \mathcal{P}[\kappa, \lambda, \sigma, \tau] f(\kappa, \lambda, \sigma, \tau). \quad (121)$$

The map $\mathbb{A}^{(3n-3)} \rightarrow H_{n,0}$ which sends f to $\omega_{n,0}(f)$ is an injection.

Proof:The proof of the injection is similar to p punctures case. \square

We define for $n \geq 2$,

$$\begin{aligned} M_{n,0}[\kappa, \lambda, \sigma, \tau] &= M(\lambda_1, \lambda_2, \tau_3) \prod_{j=3}^n M(\lambda_j, \tau_j, \tau_{j+1}) \times \\ &\times M(\lambda_1, \lambda_2, \sigma_3) \prod_{j=3}^n M(\lambda_j, \sigma_j, \sigma_{j+1}) \end{aligned} \quad (122)$$

with $\tau_{n+1} = \sigma_{n+1} = \kappa$.

We define for $(\kappa, \lambda, \sigma, \tau) \in \mathbb{S}_P^{3n-3}$ the function

$$\Upsilon_{n,0}[\kappa, \lambda, \sigma, \tau] = \frac{|\Xi_{n,0}[\kappa, \lambda, \sigma, \tau]|^2 \mathcal{P}(\lambda)}{M_{n,0}[\kappa, \lambda, \sigma, \tau] \mathcal{P}(\kappa)}.$$

It can be checked that this function is analytic in $\rho_x \in \mathbb{R}$ for $x \in \kappa \cup \lambda \cup \sigma \cup \tau$, and we will still denote by $\Upsilon_{n,0}[\kappa, \lambda, \sigma, \tau]$ the analytic continuation to \mathbb{S}^{3n-3} .

Proposition 17 *The space $H_{n,0}$ is endowed with a structure of pre-Hilbert space as follows:*

$$\langle \omega_{n,0}(f) | \omega_{n,0}(g) \rangle = \int_{\mathbb{S}_P^{3n-3}} d\kappa d\lambda d\sigma d\tau \mathcal{P}(\kappa, \lambda, \sigma, \tau) \overline{f[\kappa, \lambda, \sigma, \tau]} \Upsilon_{n,0}[\kappa, \lambda, \sigma, \tau] g[\kappa, \lambda, \sigma, \tau]. \quad (123)$$

Proof:Same proof as in the p -puncture case: use the injectivity of the map to show that the scalar product is defined unambiguously and the fact that $\Upsilon_{n,0}$ is analytic. \square

Proposition 18 *Let $(\kappa, \lambda, \sigma, \tau) \in \mathbb{S}^{3n-3}$, the action of $\mathcal{O}_{n,0}^{P(\pm)} \in \mathcal{L}_{0,p}^{inv}$ on $\omega_{n,0}[\kappa, \lambda, \sigma, \tau]$ is given by:*

$$\omega_{n,0}[\kappa, \lambda, \sigma, \tau] \triangleleft \mathcal{O}_{n,0}^{P(\pm)} = \sum_{(k,\ell,s,t) \in \mathbb{S}^{3n-3}} K_{n,0}^{P(\pm)} \left(\begin{array}{c} \kappa; k \\ \lambda, \sigma, \tau; \ell, s, t \end{array} \right) \omega_{n,0}[\kappa + k, \lambda + \ell, \sigma + s, \tau + t] \quad (124)$$

where:

1. the functions $K_{n,0}^{P(\pm)} \left(\begin{array}{c} \kappa; k \\ \lambda, \sigma, \tau; \ell, s, t \end{array} \right)$ are non zero only for a finite set of $(k, \ell, s, t) \in \mathbb{S}^{3n-3}$ according to the selection rules imposed by the palette P . Moreover any element (k, ℓ, s, t) of this finite set satisfy $(s^l, t^l), (s^r, t^r) \in \mathbb{Z}^{2n-4}$.

2. the function $K_{n,0}^{P(\pm)} \left(\begin{array}{c} \kappa; k \\ \lambda, \sigma, \tau; \ell, s, t \end{array} \right)$ belongs to $\frac{\Xi_{n,0}[\kappa+k, \lambda+\ell, \sigma+s, \tau+t]}{\Xi_{n,0}[\kappa, \lambda, \sigma, \tau]} \mathbb{C}(q^{i\rho_x})_{x \in \kappa \cup \lambda \cup \tau \cup \sigma}$.

Proof:Using the expression of the observables and their action on $(Fun_{cc}(SL_q(2, \mathbb{C}))^{\otimes n})^*$, we have for $f \in Fun_{cc}(SL_q(2, \mathbb{C}))^{\otimes n}$,

$$\left(\bigotimes_{i=1}^n \iota(\mathbb{G}^{(i)}) \triangleleft \mathcal{O}_{n,0}^{P(\pm)} \right)(f) = \sum_{\ell_1, \dots, \ell_n \in \mathcal{S}} tr_{\lambda_1 + \ell_1, \dots, \lambda_n + \ell_n} (F_{n,0}^{P(\pm)}(\lambda, \ell) \bigotimes_{i=1}^n \iota(\mathbb{G}^{(i)}) (f)), \quad (125)$$

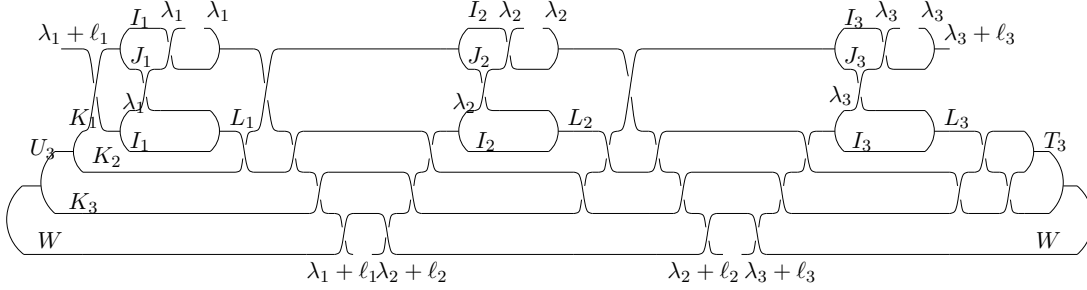

Figure 5: Expression of $F_{3,0}^{P(+)}$.

where $F_{n,0}^{P(\pm)}(\lambda, \ell)$ are elements of $End_{U_q(sl(2, \mathbb{C})_{\mathbb{R}})}(\otimes_{i=1}^n \mathbb{V}^{\lambda_i + \ell_i} \otimes \mathbb{V}^{\lambda_i})$. Note that the sum over ℓ does not exist in the p -puncture case. It now appears because the expression of the observable contains multiplication by \mathbb{G}^I (with $I \in \mathbb{S}_F$), which therefore corresponds, after acting on $\omega_{n,0}[\kappa, \lambda, \sigma, \tau]$, to tensor representations of the principal series with finite dimensional representations. The picture for $F_{n,0}^{P(+)}(\lambda, \ell)$ is shown in figure 5 (for the case $n = 3$), whereas the picture for $F_{n,0}^{P(-)}(\lambda, \ell)$ is the same after having turned overcrossing colored by couples of finite dimensional representations into the corresponding undercrossing. The picture for arbitrary genus n is a straightforward generalization.

We will use the same method as in the proposition (12), i.e we first define and prove everything in the case where $(\kappa, \lambda, \sigma, \tau)$ belongs to \mathbb{S}_F^{3n-3} and then we use the continuation method to extend it to \mathbb{S}_P^{3n-3} . We have

$$(\omega_{n,0}[\kappa, \lambda, \sigma, \tau] \triangleleft \mathcal{O}_{n,0}^{P(\pm)})(f) = \sum_{\ell} F_{n,0}^{P(\pm)} \left(\begin{matrix} \kappa \\ \lambda, \sigma, \tau; \ell \end{matrix} \right) \quad (126)$$

where $F_{n,0}^{P(\pm)} \left(\begin{matrix} \kappa \\ \lambda, \sigma, \tau; \ell \end{matrix} \right)$ are elements of $(Fun_{cc}(SL_q(2, \mathbb{C}))^{\otimes n})^*$ and is a linear combination of the elements $\omega_{n,0}[\kappa + k, \lambda + \ell, \sigma + s, \tau + t]$ as follows:

$$F_{n,0}^{P(\pm)} \left(\begin{matrix} \kappa \\ \lambda, \sigma, \tau; \ell \end{matrix} \right) = \sum_{k,s,t} K_{n,0}^{P(\pm)} \left(\begin{matrix} \kappa; k \\ \lambda, \sigma, \tau; \ell, s, t \end{matrix} \right) \omega_{n,0}[\kappa + k, \lambda + \ell, \sigma + s, \tau + t]. \quad (127)$$

$K_{n,0}^{P(+)} \left(\begin{matrix} \kappa; k \\ \lambda, \sigma, \tau; \ell, s, t \end{matrix} \right)$ is represented by the picture 6, and the same comments for the figure representing $F_{n,0}^{P(\pm)}(\lambda, \ell)$ apply here.

Note that the selection rules in the finite dimensional case, implies that if $\omega_{n,0}[\kappa, \lambda, \sigma, \tau] \neq 0$ then the possible non zero elements $\omega_{n,0}[\kappa + k, \lambda + \ell, \sigma + s, \tau + t]$ are those for s and t satisfying $s^l, s^r, t^l, t^r \in \mathbb{Z}^{n-2}$.

Using the property (22) of factorization of finite dimensional intertwiners, we obtain

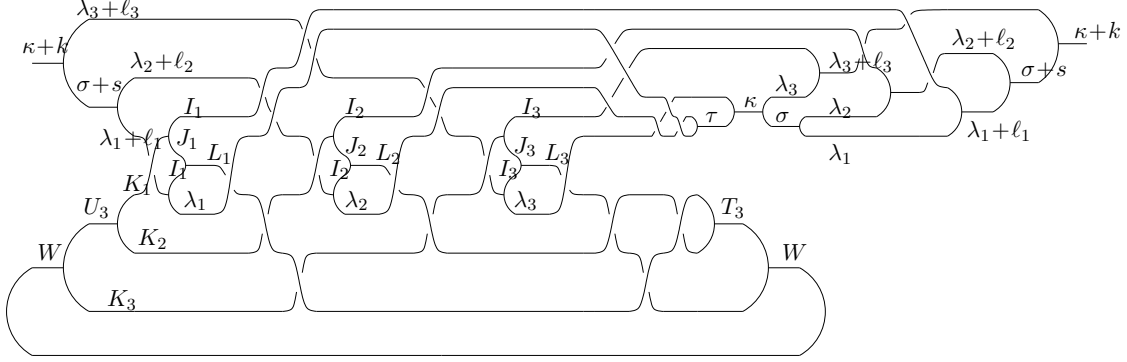

Figure 6: Expression of $K_{3,0}^{P(+)}$.

that

$$K_{n,0}^{P(\pm)} \left(\begin{array}{c} \kappa; k \\ \lambda, \sigma, \tau; \ell, s, t \end{array} \right) = K_{n,0}^{P^l(\pm)} \left(\begin{array}{c} \kappa^l; k^l \\ \lambda^l, \sigma^l, \tau^l; \ell^l, s^l, t^l \end{array} \right) K_{n,0}^{P^r(\pm)} \left(\begin{array}{c} \kappa^r; k^r \\ \lambda^r, \sigma^r, \tau^r; \ell^r, s^r, t^r \end{array} \right) \quad (128)$$

where the functions $K_{n,0}^{P^l(\pm)}$, $K_{n,0}^{P^r(\pm)}$ are computed in the proposition (32) and expressed in terms of $6j$ symbols. The definition of the continuation of $K_{n,0}^{P^l(\pm)}$ and $K_{n,0}^{P^r(\pm)}$ precisely uses these expressions where $6j(0)$ are replaced by $6j(1)$ and $6j(3)$ where needed. \square

If $a \in \mathcal{L}_{n,0}^{inv}$ we define $K_{n,0}^{a(\pm)} \left(\begin{array}{c} \kappa; k \\ \lambda, \sigma, \tau; \ell, s, t \end{array} \right)$ by linearity as in the p -puncture case.

We will now endow $H_{n,0}$ with a structure of right $\mathcal{L}_{n,0}^{inv}$ module in the following sense:

Proposition 19 $\mathcal{L}_{n,0}^{inv}$ acts on $(Fun_{cc}(SL_q(2, \mathbb{C}))^{\otimes n})^*$ with $\rho_{n,0}$ and leaves $(Fun_{cc}(SL_q(2, \mathbb{C}))^{\otimes n})^{*inv}$ invariant. The subspace $H_{n,0}$ is in general not invariant. We define the domain of $a \in \mathcal{L}_{n,0}^{inv}$ associated to $\rho_{n,0}$ to be the subspace $D(a) \subset \mathbb{A}^{(3n-3)}$ defined as: f belongs to $D(a)$ if and only if for all $(k, \ell, s, t) \in \mathcal{S}^{3n-3}$ the functions

$$(\kappa, \lambda, \sigma, \tau) \mapsto K_{n,0}^{a(\pm)} \left(\begin{array}{c} \kappa; k \\ \lambda, \sigma, \tau; \ell, s, t \end{array} \right) \frac{(\Xi_{n,0}\mathcal{P})[\kappa, \lambda, \sigma, \tau]f(\kappa, \lambda, \sigma, \tau)}{(\Xi_{n,0}\mathcal{P})[\kappa+k, \lambda+\ell, \sigma+s, \tau+t]}$$

are elements of $\mathbb{A}^{(3n-3)}$. The action of a on an element $\omega_{n,0}(f) \in D(a) \subset H_{n,0}$ belongs to $H_{n,0}$, and we have:

$$\omega_{n,0}(f) \triangleleft a = \omega_{n,0}(f \triangleleft a) ,$$

with

$$(f \triangleleft a)(\kappa, \lambda, \sigma, \tau) = \sum_{(k, \ell, s, t) \in \mathcal{S}^{3n-3}} \frac{K_{n,0}^{a(\pm)} \left(\begin{array}{c} \kappa-k; k \\ \lambda-\ell, \sigma-s, \tau-t; \ell, s, t \end{array} \right) f[\kappa-k, \lambda-\ell, \sigma-s, \tau-t]}{(\Xi_{n,0}\mathcal{P})[\kappa-k, \lambda-\ell, \sigma-s, \tau-t]^{-1}(\Xi_{n,0}\mathcal{P})[\kappa, \lambda, \sigma, \tau]} . \quad (129)$$

Theorem 2 *The representation $\tilde{\rho}_{n,0}$ of $M_q(\Sigma, SL(2, \mathbb{C})_{\mathbb{R}})$ is unitary:*

$$\forall a \in M_q(\Sigma, SL(2, \mathbb{C})_{\mathbb{R}}), \forall v \in D(a^*), \forall w \in D(a), \langle v \triangleleft a^* | w \rangle = \langle v | w \triangleleft a \rangle. \quad (130)$$

where $\langle . | . \rangle$ is the positive sesquilinear form defined by (123).

Proof: Using Cauchy theorem for the integration in ρ_x and reindexing the summation on m_x for $x \in \lambda \cup \sigma \cup \tau \cup \kappa$ the proof of unitarity of the representation reduces to the identity:

$$\begin{aligned} \Upsilon_{n,0}(\kappa, \lambda, \sigma, \tau) \frac{P_{n,0}(\pm)}{K_{n,0}} \left(\begin{array}{c} \kappa + k; -k \\ \lambda + \ell, \sigma + s, \tau + t; -\ell, -s, -t \end{array} \right) \frac{(\Xi_{n,0}\mathcal{P})(\kappa + k, \lambda + \ell, \sigma + s, \tau + t)}{\Xi_{n,0}(\kappa, \lambda, \sigma, \tau)} = \\ \Upsilon_{n,0}(\kappa + k, \lambda + \ell, \sigma + s, \tau + t) \frac{\tilde{P}_{n,0}(\mp)}{K_{n,0}} \left(\begin{array}{c} \bar{\kappa}; -\tilde{k} \\ \bar{\lambda}, \bar{\sigma}, \bar{\tau}; -\tilde{\ell}, -\tilde{s}, -\tilde{t} \end{array} \right) \frac{\overline{(\Xi_{n,0}\mathcal{P})(\kappa, \lambda, \sigma, \tau)}}{\Xi_{n,0}(\kappa + k, \lambda + \ell, \sigma + s, \tau + t)}. \end{aligned} \quad (131)$$

when $(\kappa, \lambda, \sigma, \tau) \in \mathbb{S}_P^{3n-3}$.

In order to show this relation, we make use of the following identities which are proved in the appendix:

$$\begin{aligned} \frac{\tilde{P}_{n,0}(-)}{K_{n,0}} \left(\begin{array}{c} \bar{\kappa}; -\tilde{k} \\ \bar{\lambda}, \bar{\sigma}, \bar{\tau}; -\tilde{\ell}, -\tilde{s}, -\tilde{t} \end{array} \right) &= \frac{\tilde{P}_{n,0}(-)}{K_{n,0}} \left(\begin{array}{c} \tilde{\kappa}; -\tilde{k} \\ \tilde{\lambda}, \tilde{\sigma}, \tilde{\tau}; -\tilde{\ell}, -\tilde{s}, -\tilde{t} \end{array} \right) = \\ &= \frac{[d_\lambda]}{[d_{\lambda+\ell}]} \frac{[d_{\kappa+k}]}{[d_\kappa]} \frac{P_{n,0}(+)}{K_{n,0}} \left(\begin{array}{c} \underline{\kappa} - k; k \\ \underline{\lambda} - \ell, \underline{\sigma} - s, \underline{\tau} - t; \ell, s, t \end{array} \right) = \\ &= \psi_{n,0}(\kappa, \lambda, \sigma, \tau; k, \ell, s, t) \frac{[d_\lambda]}{[d_{\lambda+\ell}]} \frac{[d_{\kappa+k}]}{[d_\kappa]} \frac{P_{n,0}(+)}{K_{n,0}} \left(\begin{array}{c} \kappa + k; -k \\ \lambda + \ell, \sigma + s, \tau + t; -\ell, -s, -t \end{array} \right). \end{aligned}$$

As a result showing unitarity is reduced to showing the quasi-invariance under shifts:

$$\frac{\Upsilon_{n,0}[\kappa, \lambda, \sigma, \tau]}{|\Xi_{n,0}[\kappa, \lambda, \sigma, \tau]|^2 \mathcal{P}(\lambda)^2 \mathcal{P}(\sigma, \tau)} = \frac{\psi_{n,0}(\kappa, \lambda, \sigma, \tau; k, \ell, s, t) \Upsilon_{n,0}[\kappa + k, \lambda + \ell, \sigma + s, \tau + t]}{|\Xi_{n,0}[\kappa + k, \lambda + \ell, \sigma + s, \tau + t]|^2 \mathcal{P}(\lambda + \ell)^2 \mathcal{P}(\sigma + s, \tau + t)}. \quad (132)$$

This is a direct consequence of the fact that $\Upsilon_{n,0}$ is expressed in terms of the function Θ which satisfies: $\Theta(\alpha + s, \beta + s, \gamma) = \Theta(\alpha, \beta, \gamma)$ for $s \in \mathcal{S}$. \square

III.3. The moduli algebra for the general case

This subsection generalizes the previous ones: we construct a unitary representation of the moduli algebra on a punctured surface of arbitrary genus n . The graph algebra $\mathcal{L}_{n,p}$ is isomorphic to $H(U_q(sl(2, \mathbb{C})_{\mathbb{R}}))^{\otimes n} \otimes U_q(sl(2, \mathbb{C})_{\mathbb{R}})^{\otimes p}$ and acts on $\mathcal{H}_{n,p}(\alpha) = Fun_{cc}(SL(2, \mathbb{C})_{\mathbb{R}})^{\otimes n} \otimes \mathbb{V}(\alpha)$ where $\alpha = (\alpha_1, \dots, \alpha_p) \in \mathbb{S}_P^p$ denotes the representations assigned to the punctures.

Before expressing a theorem for the general case similar to theorems 1 and 2, it is interesting to study the representation of the moduli algebra on the one punctured torus.

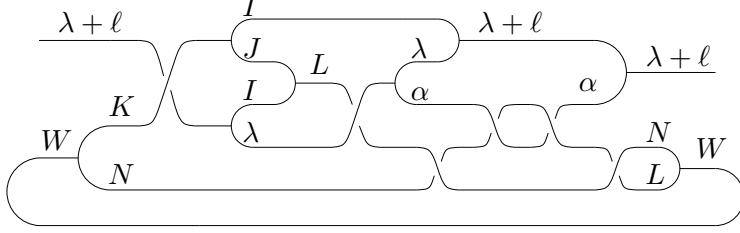

Figure 7: Expression of $K_{1,1}^{P(+)}$.

Given $\alpha, \lambda \in \mathbb{S}$, we can define $\tilde{\omega}_{1,1}^\alpha(\lambda) \in (Fun_{cc}(SL_q(2, \mathbb{C})_{\mathbb{R}}) \otimes \mathbb{V}(\alpha))^*$ by:

$$\langle \tilde{\omega}_{1,1}^\alpha(\lambda), f \otimes v \rangle = tr_\lambda(\langle \mathbb{G}, f \rangle \Psi_{\alpha\lambda}^\lambda(v \otimes id)) \quad (133)$$

where $f \in Fun_{cc}(SL_q(2, \mathbb{C})_{\mathbb{R}})$ and $v \in \mathbb{V}(\alpha)$. The algebra $\mathcal{L}_{1,1}^{inv}$ acts on the right of $(Fun_{cc}(SL_q(2, \mathbb{C})_{\mathbb{R}}) \otimes \mathbb{V}(\alpha))^*$ with $\rho_{1,1}$ and we have:

$$\tilde{\omega}_{1,1}^\alpha(\lambda) \triangleleft \overset{I}{C}_{1,1} = \tilde{\omega}_{1,1}^\alpha(\lambda) \quad (134)$$

$$\tilde{\omega}_{1,1}^\alpha(\lambda) \triangleleft tr_q(\overset{I}{M}) = \vartheta_{I\alpha} \tilde{\omega}_{1,1}^\alpha(\lambda). \quad (135)$$

An observable is given by a palette $P = (I, J, N; K, L, W) \in \mathbb{S}_F^6$ as follows:

$$\mathcal{O}_{1,1}^{P(\pm)} = \frac{v_K^{1/2}}{v_I^{1/2} v_J^{1/2}} tr_W(\mu \overset{W}{\Psi}_{KN} \overset{(I,J)}{\theta} (K, L) \overset{NL}{\mathbb{R}}(\pm) \overset{NNL}{M} \overset{NNL(\pm)-1}{\mathbb{R}} \Phi_W^{LN})$$

where $\overset{(I,J)}{\theta}(K, L) = \Psi_{JI}^K \overset{JJI'}{B} \overset{IJI'}{\mathbb{R}}(-) \Phi_L^{JI}$. After a direct computation, we can show that the action of this observable on $\tilde{\omega}_{1,1}^\alpha(\lambda)$ is given by:

$$\tilde{\omega}_{1,1}^\alpha(\lambda) \triangleleft \mathcal{O}_{1,1}^{P(\pm)} = \sum_{\ell \in \mathcal{S}} K_{1,1}^{P(\pm)} \left(\begin{matrix} \alpha \\ \lambda; \ell \end{matrix} \right) \tilde{\omega}_{1,1}^\alpha(\lambda + \ell) \quad (136)$$

where $K_{1,1}^{P(+)} \left(\begin{matrix} \alpha \\ \lambda; \ell \end{matrix} \right)$ is given by the graph (figure 7). The expression for $K_{1,1}^{P(-)} \left(\begin{matrix} \alpha \\ \lambda; \ell \end{matrix} \right)$ is given by the same graph after having turned overcrossing colored by couples of finite dimensional representations into the corresponding undercrossing.

For $\alpha, \lambda \in \mathbb{S}$, we define

$$\Xi_{1,1}[\alpha, \lambda]^{-1} = \hat{\Xi}_{1,1}[\alpha, \lambda] \xi(\lambda)^2 \quad (137)$$

$$\hat{\Xi}_{1,1}[\alpha, \lambda] = e^{i\pi\lambda} \zeta(\lambda, \lambda, \alpha) \nu_1(d_\lambda) \quad (138)$$

For $\alpha, \lambda \in \mathbb{S}_P$, we define $M_{1,1}[\alpha, \lambda] = M(\alpha, \lambda, \lambda)$ where M is defined in the appendix A.2 and we denote

$$\Upsilon_{1,1}[\alpha, \lambda] = \frac{|\Xi_{1,1}(\alpha, \lambda)|^2}{M_{1,1}[\alpha, \lambda]}. \quad (139)$$

We can show, as in the lemma 5, that $\Upsilon_{1,1}[\alpha, \lambda]$ is an analytic function of the real variable ρ_λ and therefore admits an analytic continuation for $\lambda \in \mathbb{S}$.

Proposition 20 *We define a subset of $(Fun_{cc}(SL_q(2, \mathbb{C})_{\mathbb{R}}) \otimes \mathbb{V}(\alpha))^*$ by:*

$$H_{1,1}(\alpha) = \{\tilde{\omega}_{1,1}^\alpha(f) = \int_{\mathbb{S}_F} d\lambda \mathcal{P}(\lambda) \Xi_{1,1}[\alpha, \lambda] f(\lambda) \tilde{\omega}_{1,1}^\alpha(\lambda), f \in \mathbb{A}\}. \quad (140)$$

For the elements f belonging to the domain of $\tilde{\mathcal{O}}_{1,1}^{P(\pm)}$ we have :

$$\tilde{\omega}_{1,1}^\alpha(f) \triangleleft \tilde{\mathcal{O}}_{1,1}^{P(\pm)} = \tilde{\omega}_{1,1}^\alpha(f \triangleleft \tilde{\mathcal{O}}_{1,1}^{P(\pm)}) \quad (141)$$

where

$$(f \triangleleft \tilde{\mathcal{O}}_{1,1}^{P(\pm)})(\lambda) = \sum_{\ell \in \mathcal{S}} K_{1,1}^{P(\pm)} \left(\begin{array}{c} \alpha \\ \lambda + \ell; -\ell \end{array} \right) \frac{\mathcal{P}(\lambda + \ell) \Xi_{1,1}[\alpha, \lambda + \ell]}{\mathcal{P}(\lambda) \Xi_{1,1}[\alpha, \lambda]} f(\lambda + \ell) \quad (142)$$

The map $\mathbb{A} \longrightarrow H_{1,1}(\alpha)$ is an injection. We can therefore endow $H_{1,1}(\alpha)$ with the following pre-Hilbert structure

$$\langle \tilde{\omega}_{1,1}^\alpha(f) | \tilde{\omega}_{1,1}^\alpha(g) \rangle = \int_{\mathbb{S}_P} d\lambda \mathcal{P}(\lambda) \overline{f(\lambda)} \Upsilon_{1,1}[\alpha, \lambda] g(\lambda) . \quad (143)$$

$\tilde{\rho}_{1,1}$ is an antirepresentation of $M_q(\Sigma_1, SL(2, \mathbb{C})_{\mathbb{R}}; \alpha)$ which is unitary.

Proof: It is easy to show that $\tilde{\omega}_{1,1}^\alpha(f)$ is well defined and the expression (142) of the action of $\tilde{\rho}_{1,1}$ follows from Cauchy theorem. Using the usual method of proof, unitarity is equivalent to the identity:

$$\begin{aligned} \Upsilon_{1,1}[\alpha, \lambda] K_{1,1}^{P(\pm)} \left(\begin{array}{c} \alpha \\ \lambda + \ell; -\ell \end{array} \right) \frac{\Xi_{1,1}[\alpha, \lambda + \ell]}{\Xi_{1,1}[\alpha, \lambda]} \mathcal{P}(\lambda + \ell) = \\ \Upsilon_{1,1}[\alpha, \lambda + \ell] K_{1,1}^{\tilde{P}(\mp)} \left(\begin{array}{c} \bar{\alpha} \\ \bar{\lambda}; -\bar{\ell} \end{array} \right) \frac{\overline{\Xi_{1,1}[\alpha, \lambda]}}{\Xi_{1,1}[\alpha, \lambda + \ell]} \overline{\mathcal{P}(\lambda)} \end{aligned} \quad (144)$$

when $(\alpha, \lambda) \in \mathbb{S}_P^2$.

In order to show this relation, we make use of the following identities which are proved in the appendix:

$$\tilde{K}_{1,1}^{\tilde{P}(\mp)} \left(\begin{array}{c} \bar{\alpha} \\ \bar{\lambda}; -\bar{\ell} \end{array} \right) = K_{1,1}^{P(\pm)} \left(\begin{array}{c} \alpha \\ \lambda - \ell; \ell \end{array} \right) \quad (145)$$

$$= \psi_{1,1}(\alpha, \lambda; \ell) K_{1,1}^{P(\pm)} \left(\begin{array}{c} \alpha \\ \lambda + \ell; -\ell \end{array} \right) . \quad (146)$$

As a result, showing unitarity reduces to the relation:

$$\frac{\Upsilon_{1,1}[\alpha, \lambda]}{|\Xi_{1,1}[\alpha, \lambda]|^2 \mathcal{P}(\lambda)} = \psi_{1,1}(\alpha, \lambda; \ell) \frac{\Upsilon_{1,1}[\alpha, \lambda + \ell]}{|\Xi_{1,1}[\alpha, \lambda + \ell]|^2 \mathcal{P}(\lambda + \ell)} \quad (147)$$

which holds. \square

This proposition closes the construction for the torus with one puncture. All the tools are now ready to construct a right unitary module of the moduli algebra $M_q(\Sigma_n, SL(2, \mathbb{C})_{\mathbb{R}}; \alpha)$. For this reason, we will just describe the representation of the moduli algebra without giving the technical details.

Proposition 21 *Let $\alpha = (\alpha_1, \dots, \alpha_p) \in \mathbb{S}^p$, $\lambda = (\lambda_1, \dots, \lambda_n) \in \mathbb{S}^n$, $\beta = (\beta_3, \dots, \beta_p) \in \mathbb{S}^{p-2}$, $\sigma = (\sigma_3, \dots, \sigma_{n+1})$, $\tau = (\tau_3, \dots, \tau_{n+1})$ elements of \mathbb{S}^{n-1} and $\delta \in \mathbb{S}$. We define $\overset{\alpha}{\omega}_{n,p}(\beta, \lambda, \sigma, \tau, \delta) \in (Fun_{cc}(SL_q(2, \mathbb{C})_{\mathbb{R}})^{\otimes n} \otimes \mathbb{V}(\alpha))^*$ by*

$$\langle \overset{\alpha}{\omega}_{n,p}(\beta, \lambda, \sigma, \tau, \delta), \phi \otimes v \rangle = tr_{\sigma_{n+1}} \left(\langle \wp_n(\lambda, \sigma, \tau), \phi \rangle \Psi_{\delta}^{\tau_{n+1}} \left(\Psi_{\alpha}^{\delta}(\beta) \right) (v) \right) \quad (148)$$

where $\phi \in Fun_{cc}(SL_q(2, \mathbb{C})_{\mathbb{R}})^{\otimes n}$ and $v \in \mathbb{V}(\alpha)$.

$\Psi_{\alpha}^{\delta}(\beta) \in Hom_{U_q(sl(2, \mathbb{C})_{\mathbb{R}})}(\mathbb{V}(\alpha), \overset{\delta}{\mathbb{V}})$ has been introduced in the definition 6 and $\wp_n(\lambda, \sigma, \tau) \in (Fun_{cc}(SL_q(2, \mathbb{C})_{\mathbb{R}})^{\otimes n})^* \otimes Hom(\overset{\tau_{n+1}}{\mathbb{V}}, \overset{\sigma_{n+1}}{\mathbb{V}})$ has been introduced in the definition 9. $\overset{\alpha}{\omega}_{n,p}(\beta, \lambda, \sigma, \tau, \delta)$ are invariant vectors:

$$\overset{\alpha}{\omega}_{n,p}(\beta, \lambda, \sigma, \tau, \delta) \triangleleft \overset{I}{C}_{n,p} = \overset{\alpha}{\omega}_{n,p}(\beta, \lambda, \sigma, \tau, \delta) \quad , \quad (149)$$

and they satisfy the constraints:

$$\overset{\alpha}{\omega}_{n,p}(\beta, \lambda, \sigma, \tau, \delta) \triangleleft tr_q(\overset{I}{\mathbb{M}}(n+i)) = \vartheta_{I\alpha_i} \overset{\alpha}{\omega}_{n,p}(\beta, \lambda, \sigma, \tau, \delta) \quad , \quad \forall i = 1, \dots, p \quad . \quad (150)$$

Proof: The proof of the invariance is a direct consequence of the factorization $\overset{I}{C}_{n,p}(\pm) = \overset{I}{C}_{n,0}(\pm) \overset{I}{C}_{0,p}(\pm)$. The action of $tr_q(\overset{I}{\mathbb{M}}(n+i))$ is obtained immediately. \square

We will define:

$$\hat{\Xi}_{n,p}[\alpha, \beta, \lambda, \sigma, \tau, \delta]^{-1} = \hat{\Xi}_n[\lambda, \sigma, \tau]^{-1} \hat{\Xi}_c[\sigma_{n+1}, \tau_{n+1}, \delta]^{-1} \hat{\Xi}_p[\alpha, \beta, \delta]^{-1} \quad ,$$

where

$$\begin{aligned} \hat{\Xi}_n[\lambda, \sigma, \tau]^{-1} &= e^{i\pi(2\lambda_1 + \dots + 2\lambda_n - \sigma_{n+1} - \tau_{n+1})} \zeta(\lambda_1, \lambda_2, \sigma_3) \prod_{j=3}^n \nu_1(d_{\sigma_j}) \zeta(\lambda_j, \sigma_j, \sigma_{j+1}) \\ &\quad \times \zeta(\lambda_1, \lambda_2, \tau_3) \prod_{j=3}^n \nu_1(d_{\tau_j}) \zeta(\lambda_j, \tau_j, \tau_{j+1}) \\ \hat{\Xi}_p[\alpha, \beta, \delta]^{-1} &= e^{i\pi(\alpha_1 + \dots + \alpha_n)} \zeta(\alpha_1, \alpha_2, \beta_3) \prod_{j=3}^{p-1} \nu_1(d_{\beta_j}) \zeta(\alpha_j, \beta_j, \beta_{j+1}) \\ &\quad \times \nu_1(d_{\delta}) \zeta(\alpha_p, \beta_p, \delta) \\ \hat{\Xi}_c[\sigma_{n+1}, \tau_{n+1}, \delta]^{-1} &= e^{i\pi(\sigma_{n+1} + \delta - \tau_{n+1})} \nu_1(d_{\tau_{n+1}}) \zeta(\sigma_{n+1}, \tau_{n+1}, \delta) \quad . \end{aligned}$$

From these functions, we also define

$$\Xi_{n,p}[\alpha, \beta, \lambda, \sigma, \tau, \delta] = \hat{\Xi}_{n,p}[\alpha, \beta, \lambda, \sigma, \tau, \delta] \xi(\beta) \xi(\lambda) \xi(\sigma) \xi(\tau) \xi(\delta) .$$

We will also denote $M_{n,p}[\alpha, \beta, \lambda, \sigma, \tau, \delta] = M_n[\lambda, \sigma, \tau] M_c[\sigma_{n+1}, \tau_{n+1}, \delta] M_p[\alpha, \beta, \delta]$ with:

$$\begin{aligned} M_n[\lambda, \sigma, \tau] &= M(\lambda_1, \lambda_2, \sigma_3) M(\lambda_1, \lambda_2, \tau_3) \prod_{j=3}^n (M(\lambda_i, \sigma_i, \sigma_{i+1}) M(\lambda_i, \tau_i, \tau_{i+1})) \\ M_p[\alpha, \beta, \delta] &= M(\alpha_1, \alpha_2, \beta_3) M(\alpha_p, \beta_p, \delta) \prod_{j=3}^n M(\alpha_i, \beta_i, \beta_{i+1}) \\ M_c[\sigma_{n+1}, \tau_{n+1}, \delta] &= M(\sigma_{n+1}, \tau_{n+1}, \delta). \end{aligned}$$

Finally, for $\alpha = \alpha_1, \dots, \alpha_p \in \mathbb{S}_P^p$, $\lambda = (\lambda_1, \dots, \lambda_n) \in \mathbb{S}_P^n$, $\beta = (\beta_3, \dots, \beta_p) \in \mathbb{S}_P^{p-2}$, $\sigma = (\sigma_3, \dots, \sigma_{n+1})$, $\tau = (\tau_3, \dots, \tau_{n+1})$ elements of \mathbb{S}_P^{n-1} and $\delta \in \mathbb{S}_P$, we denote:

$$\Upsilon_{n,p}[\alpha, \beta, \lambda, \sigma, \tau, \delta] = \frac{|\Xi_{n,p}[\alpha, \beta, \lambda, \sigma, \tau, \delta]|^2}{M_{n,p}[\alpha, \beta, \lambda, \sigma, \tau, \delta]} \frac{\mathcal{P}(\lambda)}{\mathcal{P}(\tau_{n+1})} . \quad (151)$$

We can show that $\Upsilon_{n,p}[\alpha, \beta, \lambda, \sigma, \tau, \delta]$ is analytic in ρ_x for $x \in \beta \cup \lambda \cup \sigma \cup \tau \cup \delta$ and we will still denote by $\Upsilon_{n,p}[\alpha, \beta, \lambda, \sigma, \tau, \delta]$ the analytic continuation to $\alpha, \beta, \lambda, \sigma, \tau, \delta \in \mathbb{S}^{3n+p-3}$.

Theorem 3 We define a subset of $(Fun_{cc}(SL_q(2, \mathbb{C})_{\mathbb{R}})^{\otimes n})^* \otimes \mathbb{V}(\alpha)^*$ by:

$$\begin{aligned} H_{n,p}(\alpha) = \{ \overset{\alpha}{\omega}_{n,p}(f) = \int_{\mathbb{S}_P^{3n+p-3}} d\beta d\lambda d\sigma d\tau d\delta \mathcal{P}(\beta, \lambda, \sigma, \tau, \delta) \Xi_{n,p}[\alpha, \beta, \lambda, \sigma, \tau, \delta] \\ f(\beta, \lambda, \sigma, \tau, \delta) \overset{\alpha}{\omega}_{n,p}(\beta, \lambda, \sigma, \tau, \delta), f \in \mathbb{A} \} \end{aligned} \quad (152)$$

The map $\mathbb{A}^{3n+p-3} \rightarrow H_{n,p}(\alpha)$ which sends f to $\overset{\alpha}{\omega}_{n,p}(f)$ is an injection.

The algebra $\mathcal{L}_{n,p}^{inv}$ acts on the right of $(Fun_{cc}(SL_q(2, \mathbb{C})_{\mathbb{R}})^{\otimes n})^* \otimes \mathbb{V}(\alpha)^*$ with $\rho_{n,p}$ which descends to a right action $\tilde{\rho}_{n,p}$ on $H_{n,p}$ by:

$$\overset{\alpha}{\omega}_{n,p}(f) \triangleleft \overset{P}{\mathcal{O}}_{n,p} = \overset{\alpha}{\omega}_{n,p}(f \triangleleft \overset{P}{\mathcal{O}}_{n,p}) . \quad (153)$$

The subspace $H_{n,p}(\alpha)$ is in general not invariant. We define the domain of $a \in \mathcal{L}_{n,p}^{inv}$ to be the subspace $D(a)$.

We can endow $H_{n,p}(\alpha)$ with a pre-Hilbert structure as follows:

$$\begin{aligned} \langle \overset{\alpha}{\omega}_{n,p}(f) | \overset{\alpha}{\omega}_{n,p}(g) \rangle = \int_{\mathbb{S}_P^{3n+p-3}} d\beta d\lambda d\sigma d\tau d\delta \mathcal{P}(\beta, \lambda, \sigma, \tau, \delta) \Upsilon_{n,p}[\alpha, \beta, \lambda, \sigma, \tau, \delta] \\ \overline{f(\beta, \lambda, \sigma, \tau, \delta)} g(\beta, \lambda, \sigma, \tau, \delta) . \end{aligned} \quad (154)$$

The representation $\tilde{\rho}_{n,p}$ of $M_q(\Sigma, SL(2, \mathbb{C})_{\mathbb{R}})$ is unitary:

$$\forall a \in M_q(\Sigma, SL(2, \mathbb{C})_{\mathbb{R}}), \forall v \in D(a^*), \forall w \in D(a), \langle v \triangleleft a^* | w \rangle = \langle v | w \triangleleft a \rangle . \quad (155)$$

Proof: We perform the proof similarly to the proof of the theorems 1 and 2.

First, using usual continuation arguments, we compute the action of $\mathcal{O}_{n,p}^{P(\pm)}$ on $\tilde{\omega}_{n,p}^\alpha$ $[\beta, \lambda, \sigma, \tau, \delta]$ when $\alpha = \alpha_1, \dots, \alpha_p \in \mathbb{S}^p$, $\lambda = (\lambda_1, \dots, \lambda_n) \in \mathbb{S}^n$, $\beta = (\beta_3, \dots, \beta_p) \in \mathbb{S}^{p-2}$, $\sigma = (\sigma_3, \dots, \sigma_{n+1})$, $\tau = (\tau_3, \dots, \tau_{n+1})$ elements of \mathbb{S}^{n-1} and $\delta \in \mathbb{S}$. We show that:

$$\tilde{\omega}_{n,p}^\alpha [\beta, \lambda, \sigma, \tau, \delta] \triangleleft \mathcal{O}_{n,p}^{P(\pm)} = \sum_{b,\ell,s,t,d \in \mathcal{S}} K_{n,p}^{P(\pm)} \left(\begin{array}{c} \alpha \\ \beta, \lambda, \sigma, \tau, \delta; b, \ell, s, t, d \end{array} \right) \tilde{\omega}_{n,p}^\alpha [\beta + b, \lambda + \ell, \sigma + s, \tau + t, \delta + d] \quad (156)$$

The functions $K_{n,p}^{P(\pm)} \left(\begin{array}{c} \alpha \\ \beta, \lambda, \sigma, \tau, \delta; b, \ell, s, t, d \end{array} \right)$, defined by the graph in picture (fig 22), are non zero only for a set of $b, \ell, s, t, d \in \mathcal{S}$ according to the selection rules imposed by the palette P .

If $a \in \mathcal{L}_{n,p}^{inv}$, we define $K_{n,p}^{a(\pm)} \left(\begin{array}{c} \alpha \\ \beta, \lambda, \sigma, \tau, \delta; b, \ell, s, t, d \end{array} \right)$ by linearity as in the previous cases. The subspace $H_{n,p}(\alpha)$ is in general not left invariant by the action of $\mathcal{L}_{n,p}^{inv}$. So, we define the domain $D(a)$ of a such that: f belongs to $D(a)$ if and only if for all $b, \ell, s, t, d \in \mathcal{S}$ the functions

$$\begin{aligned} (\alpha, \beta, \lambda, \sigma, \tau, \delta) &\mapsto K_{n,p}^{a(\pm)} \left(\begin{array}{c} \alpha \\ \beta, \lambda, \sigma, \tau, \delta; b, \ell, s, t, d \end{array} \right) f(\beta, \lambda, \sigma, \tau, \delta) \\ &\frac{\Xi_{n,p}[\alpha, \beta, \lambda, \sigma, \tau, \delta] \mathcal{P}[\beta, \lambda, \sigma, \tau, \delta]}{\Xi_{n,p}[\alpha, \beta + b, \lambda + \ell, \sigma + s, \tau + t, \delta + d] \mathcal{P}[\beta + b, \lambda + \ell, \sigma + s, \tau + t, \delta + d]} \end{aligned} \quad (157)$$

are elements of $\mathbb{A}^{(3n+p-3)}$. The action $\rho_{n,p}$ of $\mathcal{L}_{n,p}^{inv}$ on $(Fun_{cc}(SL_q(2, \mathbb{C})_{\mathbb{R}})^{\otimes n} \otimes \mathbb{V}(\alpha))^*$ descends to an action $\tilde{\rho}_{n,p}$ on $H_{n,p}[\alpha]$ defined by:

$$\tilde{\omega}_{n,p}^\alpha (f) \triangleleft a = \tilde{\omega}_{n,p}^\alpha (f \triangleleft a), \quad (158)$$

with

$$\begin{aligned} (f \triangleleft a)(\beta, \lambda, \sigma, \tau, \delta) &= \sum_{b,\ell,s,t,d \in \mathcal{S}} K_{n,p}^{a(\pm)} \left(\begin{array}{c} \alpha \\ \beta - b, \lambda - \ell, \sigma - s, \tau - t, \delta - d; b, \ell, s, t, d \end{array} \right) \\ &\frac{\Xi_{n,p}[\alpha, \beta - b, \lambda - \ell, \sigma - s, \tau - t, \delta - d] \mathcal{P}[\beta - b, \lambda - \ell, \sigma - s, \tau - t, \delta - d]}{\Xi_{n,p}[\alpha, \beta, \lambda, \sigma, \tau, \delta] \mathcal{P}[\beta, \lambda, \sigma, \tau, \delta]} \\ &f(\beta - b, \lambda - \ell, \sigma - s, \tau - t, \delta - d). \end{aligned} \quad (159)$$

Finally, using Cauchy theorem, unitarity reduces to the identity:

$$\begin{aligned}
& \Upsilon_{n,p}[\alpha, \beta, \lambda, \sigma, \tau, \delta] \overset{P}{\tilde{K}}_{n,p}^{(\pm)} \left(\begin{array}{c} \alpha \\ \beta + b, \lambda + \ell, \sigma + s, \tau + t, \delta + d; -b, -\ell, -s, -t, -d \end{array} \right) \\
& \frac{\Xi_{n,p}[\alpha, \beta + b, \lambda + \ell, \sigma + s, \tau + t, \delta + d] \mathcal{P}[\beta + b, \lambda + \ell, \sigma + s, \tau + t, \delta + d]}{\Xi_{n,p}[\alpha, \beta, \lambda, \sigma, \tau, \delta]} = \\
& \Upsilon_{n,p}[\alpha, \beta + b, \lambda + \ell, \sigma + s, \tau + t, \delta + d] \overset{P}{\tilde{K}}_{n,p}^{(\mp)} \left(\begin{array}{c} \bar{\alpha} \\ \bar{\beta}, \bar{\lambda}, \bar{\sigma}, \bar{\tau}, \bar{\delta}; -\bar{b}, -\bar{\ell}, -\bar{s}, -\bar{t}, -\bar{d} \end{array} \right) \\
& \frac{\overline{\Xi_{n,p}[\alpha, \beta, \lambda, \sigma, \tau, \delta]} \mathcal{P}[\beta, \lambda, \sigma, \tau, \delta]}{\overline{\Xi_{n,p}[\alpha, \beta + b, \lambda + \ell, \sigma + s, \tau + t, \delta + d]}} \tag{160}
\end{aligned}$$

where $\alpha, \beta, \lambda, \sigma, \tau \in \mathbb{S}_P$. In order to show this relation, we make use of the identities related in the proposition 35 given in the appendix and the proof of unitarity reduces to the relation

$$\begin{aligned}
& \frac{\Upsilon_{n,p}[\alpha, \beta, \lambda, \sigma, \tau, \delta]}{|\Xi_{n,p}[\alpha, \beta, \lambda, \sigma, \tau, \delta]|^2 \mathcal{P}[\beta, \lambda, \sigma, \tau]} \frac{\mathcal{P}(\tau_{n+1})}{\mathcal{P}(\lambda)} \psi_{n,p}^{-1}(\alpha, \beta, \lambda, \sigma, \tau, \delta; b, \ell, s, t, d) = \\
& \frac{\Upsilon_{n,p}[\alpha, \beta + b, \lambda + \ell, \sigma + s, \tau + t, \delta + d]}{|\Xi_{n,p}[\alpha, \beta + b, \lambda + \ell, \sigma + s, \tau + t, \delta + d]|^2 \mathcal{P}[\beta + b, \lambda + \ell, \sigma + s, \tau + t, \delta + d]} \frac{\mathcal{P}(\tau_{n+1} + t_{n+1})}{\mathcal{P}(\lambda + \ell)}
\end{aligned}$$

which holds immediately. \square

IV. Discussion and Conclusion

The major result of our work is the proof that there exists a unitary representation of the quantization of the moduli space of the flat $SL(2, \mathbb{C})_{\mathbb{R}}$ connections on a punctured surface. This is a non trivial result which necessitates to integrate the formalism of combinatorial quantization and harmonic analysis on $SL_q(2, \mathbb{C})_{\mathbb{R}}$. However we have not studied in details properties of this unitary representation. It would indeed be interesting to analyze the domains of definition of the operators $\rho_{n,p}(\mathcal{O})$ and to study the possible extensions of $\rho_{n,p}(\mathcal{O})$. Related mathematical questions, which are answered positively in the compact group case, are the following:

- is the representation $\rho_{n,p}$ irreducible?
- in this case, is it the only irreducible representation up to equivalence?
- Does this representation provides a unitary representation of the mapping class group?

What remains also to be done is to relate precisely the quantization of $SL(2, \mathbb{C})_{\mathbb{R}}$ Chern-Simons theory to quantum gravity in de Sitter space.

Discarding the problem of degenerate metrics, the two theories are classically equivalent. As pointed out in [1, 28], three dimensional lorentzian gravity written in the first order formalism is a gauge theory, specifically a Chern-Simons theory associated

to the Lorentz group when the cosmological constant Λ is positive. This equivalence was extensively studied (see for example [15] and the references therein) and it is possible to relate the observables of Chern-Simons theory with the geometric parameters associated to the metric solution of Einstein equations. As usual we denote by l_P the Planck length, $l_P = \hbar G$ and the cosmological constant Λ is related to the cosmological length l by $\Lambda = l^{-2}$. These two length scales define a dimensionless constant l_P/l . The semiclassical regime is obtained when \hbar approaches zero, and the relation between Chern-Simons $SL(2, \mathbb{C})_{\mathbb{R}}$ and gravity, imposes $q = 1 - l_P/l + o(l_P/l)$. It is a central question to control the other terms of the expansion and the non perturbative corrections. This issue is not addressed here but could possibly be done by comparing two expectation value of observables in $SL(2, \mathbb{C})_{\mathbb{R}}$ -Chern-Simons theory and in quantum gravity in de Sitter space. The construction of a unitary representation of the observables, provided in our work, is a step in this direction.

In the rest of this discussion we will provide a relation between the mass and the spin of a particle and the parameters (m, ρ) of the insertion of a principal representation.

Let us first give the metric of de Sitter space associated to massive and spinning particles. In a neighbourhood of a massive spinning particle of mass m_p and spin j , the metrics takes the form of Kerr-de Sitter solution ([9, 23]):

$$\begin{aligned} ds^2 &= -(8l_P M - \frac{r^2}{l^2} + \frac{(8l_P j)^2}{4r^2})dt^2 \\ &\quad + (8l_P M - \frac{r^2}{l^2} + \frac{(8l_P j)^2}{4r^2})^{-1}dr^2 + r^2(-\frac{8l_P j}{2r^2}dt + d\phi)^2 \\ &= -\frac{(r^2 + r_+^2)(r_+^2 - r^2)}{r^2}dt^2 + \frac{r^2}{(r^2 + r_-^2)(r_+^2 - r^2)}dr^2 + r^2(d\phi + \frac{r_+ r_-}{r^2}dt)^2 \end{aligned}$$

where we have defined

$$r_+ = 2l\sqrt{l_P M + l_P\sqrt{M^2 + \frac{j^2}{l^2}}}, \quad r_- = 2l\sqrt{-l_P M + l_P\sqrt{M^2 + \frac{j^2}{l^2}}},$$

where $8l_P M = 1 - 8l_P m_p$.

This metric has a cosmological event horizon located in $r = r_+$. Following [23], this metric can be conveniently written as

$$ds^2 = \sinh^2 R \left(\frac{r_+ dt}{l} - r_- d\phi \right)^2 - l^2 dR^2 + \cosh^2 R \left(\frac{r_- dt}{l} + r_+ d\phi \right)^2$$

with $r^2 = r_+^2 \cosh^2 R + r_-^2 \sinh^2 R$. In this coordinate system, the cosmological horizon is located at $R = 0$; the exterior of the horizon is described for real R and the interior for imaginary value of R . To this metric we can associate an orthonormal cotriad e_μ^a with $g_{\mu\nu} = e_\mu^a e_\nu^b \eta_{ab}$ and its spin connection ω_μ^a . These data define a flat $SL(2, \mathbb{C})_{\mathbb{R}}$ connection

$$A_\mu = \omega_\mu^a J_a + \frac{1}{l} e_\mu^a P_a$$

where J_a, P_a are the generators of $so(3, 1)$ and $\omega_\mu^a = \frac{1}{2}\epsilon_{abc}\omega_\mu^{ab}$. The explicit value of the connection is given by Park ([23]) in the spinorial representation and a trivial computation shows that:

$$W_{cl}(A) = 2 \cosh \left(2\pi \frac{r_- - ir_+}{l} \right) \quad (161)$$

where $W_{cl}(A)$ is the classical holonomy of the connection along a circle centered around the world-line of the particle.

In the quantization of Chern-Simons theory that we provided, a puncture is colored with a principal unitary representation $\alpha = (m, \rho)$. The monodromy $M_q^I(A)$ around a puncture belongs to the center of the moduli algebra and it is defined by $M_q^I(A) = \vartheta_{I\alpha}$. In order to compare it to the classical case, one can trivially evaluate the associated holonomy in the *spinorial* representation $I = (1/2, 0)$:

$$W_q(A) = q^{m+i\rho} + q^{-(m+i\rho)}. \quad (162)$$

At the semi classical level, the comparison between (161, 162), implies the relations:

$$\mp 2\pi r_+ = \rho l_P \quad , \quad \pm 2r_- = m l_P . \quad (163)$$

which is equivalent to

$$32\pi^2 l_P M = \frac{l_P^2}{j^2} (\rho^2 - m^2) \quad , \quad 16\pi^2 j = \frac{1}{\pi^2} \frac{l_p^2}{l^2} \rho m . \quad (164)$$

From these relations we note that r_- is quantized in units of l_P whereas r_+ has a continuous spectrum. It is much more delicate to understand what is the physical meaning of holonomies around several punctures. In particular, the energy of such a system in de Sitter space is not, a priori, well defined in the absence of boundaries, even at the classical level. It should be a good challenge to understand the classical and quantum behaviour of particules in dS space in the light of Chern-Simons theory on a p -punctured sphere. We will give an analysis of this problem in a future work.

A comparison, similar to the analysis given above, between the classical geometry and the quantization in the Chern-Simons approach has been given in [17] for the genus one case. The generalization to the genus n case is open. Of particular interest is the construction of coherent states, lying in $H_{n,p}$ and approaching a classical 3 metric. This subject is up to now still in its infancy.

Appendix A: Quantum Lorentz group

A.1 Representations and harmonic analysis

In this work we have chosen $q \in \mathbb{R}, 0 < q < 1$.

For $x \in \mathbb{C}$, we denote $[x]_q = [x] = \frac{q^x - q^{-x}}{q - q^{-1}}, d_x = 2x + 1$, and $v_x^{1/4} = \exp(i\frac{\pi}{2}x)q^{-\frac{x(x+1)}{2}}$.

The square root of a complex number is defined by:

$$\forall x \in \mathbb{C}, \sqrt{x} = \sqrt{|x|}e^{i\frac{Arg(x)}{2}}, \text{ where } x = |x|e^{iArg(x)}, Arg(x) \in]-\pi, \pi], \quad (165)$$

For all complex number z with non zero imaginary part, we define $\epsilon(z) = \text{sign}(\text{Im}(z))$.

We will define the following basic functions: $\forall z \in \mathbb{C}, \forall n \in \mathbb{Z}$,

$$(z)_\infty = (q^{2z}, q^2)_\infty = \prod_{k=0}^{+\infty} (1 - q^{2z+2k}), \quad (z)_n = \frac{(z)_\infty}{(z+n)_\infty},$$

$$\nu_\infty(z) = \prod_{k=0}^{+\infty} \sqrt{1 - q^{2z+2k}}, \quad \nu_n(z) = \frac{\nu_\infty(z)}{\nu_\infty(z+n)}.$$

Let us define the function ξ, θ :

$$\xi(z) = (z)_\infty(1-z)_\infty, \xi(z) = \xi(z + i\frac{\pi}{\ln q}) \quad (166)$$

$$\theta(z) = \xi(z)q^{z^2-z}e^{i\pi z}/(1)_\infty^2, \theta(z+1) = \theta(z). \quad (167)$$

With our choice of square root, we have $\overline{\nu_n(z)} = \nu_n(\bar{z})$. It is also convenient to introduce the following function $\varphi: \mathbb{C} \times \mathbb{Z} \rightarrow \{1, i, -i, -1\}$, defined by

$$\varphi(z, n) = \nu_n(z - n + 1)\nu_{-n}(n - z)q^{-nz + \frac{1}{2}n(n-1)}. \quad (168)$$

We will recall in this appendix fundamental results on $U_q(sl(2, \mathbb{C})_{\mathbb{R}})$. We will give a summary of the harmonic analysis on $SL_q(2, \mathbb{C})_{\mathbb{R}}$, for a complete treatment see [12, 13].

$U_q(su(2))$, for $q \in]0, 1[$, is defined as being the star Hopf algebra generated by the elements $J_\pm, q^{\pm J_z}$, and the relations:

$$q^{\pm J_z} q^{\mp J_z} = 1, \quad q^{J_z} J_\pm q^{-J_z} = q^{\pm 1} J_\pm, \quad [J_+, J_-] = \frac{q^{2J_z} - q^{-2J_z}}{q - q^{-1}}. \quad (169)$$

The coproduct is defined by

$$\Delta(q^{\pm J_z}) = q^{\pm J_z} \otimes q^{\pm J_z}, \quad \Delta J_\pm = q^{-J_z} \otimes J_\pm + J_\pm \otimes q^{J_z}, \quad (170)$$

and the star structure is given by:

$$(q^{J_z})^\star = q^{J_z}, \quad J_\pm^\star = q^{\mp 1} J_\mp. \quad (171)$$

This Hopf algebra is a ribbon quasi-triangular Hopf algebra. The action of the generators on an orthonormal basis of an irreducible representation of spin I is given by the following expressions:

$$q^{J_z} \overset{I}{e}_m = q^m \overset{I}{e}_m, \quad (172)$$

$$J_{\pm} \overset{I}{e}_m = q^{\pm \frac{1}{2}} \sqrt{[I \pm m + 1][I \mp m]} \overset{I}{e}_{m \pm 1}. \quad (173)$$

The element μ is given by $\mu = q^{2J_z}$.

For a representation $\pi = \overset{I}{\pi}$ of $U_q(\mathfrak{su}(2))$, we define the conjugate representation $\bar{\pi}(x) = \overline{\pi(S^{-1}x^*)}$ and we have $\bar{\pi}(x) = \overset{I}{w} \pi(x) \overset{I}{w}^{-1}$ with $\overset{I}{w}$ matrices whose components are defined by $\overset{I}{w}_n^{\bar{m}} = w_{mn} = v_I^{1/2} e^{-i\pi m} q^m \delta_{m,-n}$.

$U_q(\mathfrak{sl}(2, \mathbb{C})_{\mathbb{R}})$ is defined to be the quantum double of $U_q(\mathfrak{su}(2))$. Therefore $U_q(\mathfrak{sl}(2, \mathbb{C})_{\mathbb{R}}) = U_q(\mathfrak{su}(2)) \otimes U_q(\mathfrak{su}(2))^*$ as a vector space, where $U_q(\mathfrak{su}(2))^*$ denotes the restricted dual of $U_q(\mathfrak{su}(2))$, i.e the Hopf algebra spanned by the matrix elements of finite dimensional representations of $U_q(\mathfrak{su}(2))$.

A basis of $U_q(\mathfrak{su}(2))^*$ is the set of matrix elements in an orthonormal basis of irreducible unitary representations of $U_q(\mathfrak{su}(2))$, which we will denote by $\overset{B}{g}_j^i, B \in \frac{1}{2}\mathbb{Z}^+, i, j = -B, \dots, B$.

It can be shown that $U_q(\mathfrak{su}(2))^*$ is isomorphic, as a star Hopf algebra, to the quantum envelopping algebra $U_q(\mathfrak{an}(2))$ where $\mathfrak{an}(2)$ is the Lie algebra of traceless complex upper triangular 2×2 matrices with real diagonal.

$U_q(\mathfrak{su}(2))$ being a factorizable Hopf algebra, it is possible to give a nice generating family of $U_q(\mathfrak{su}(2))$. Let us introduce, for each $I \in \frac{1}{2}\mathbb{Z}^+$ the elements $\overset{I}{L}^{(\pm)} \in \text{End}(\mathbb{C}^{d_I}) \otimes U_q(\mathfrak{su}(2))$ defined by $\overset{I}{L}^{(\pm)} = (\overset{I}{\pi} \otimes id)(R^{(\pm)})$. The matrix elements of $\overset{I}{L}^{(\pm)}$ when I describes $\frac{1}{2}\mathbb{Z}^+$ span the vector space $U_q(\mathfrak{su}(2))$.

The star Hopf algebra structure on $U_q(\mathfrak{sl}(2, \mathbb{C})_{\mathbb{R}})$ is described in details in [12]. Let us simply recall that we have:

$$\overset{I}{L}^{(\pm) i} \overset{J}{L}^{(\pm) k} = \sum_{Kmn} \begin{pmatrix} i & k & K \\ I & J & m \end{pmatrix} \overset{K}{L}^{(\pm) m} \begin{pmatrix} n & I & J \\ K & j & l \end{pmatrix}, \quad \overset{IJ}{R}_{12} \overset{I}{L}_1^{(+)} \overset{J}{L}_2^{(-)} = \overset{J}{L}_2^{(-)} \overset{I}{L}_1^{(+)} \overset{IJ}{R}_{12},$$

$$\overset{I_i}{g}_j \overset{J_k}{g}_l = \sum_{Kmn} \begin{pmatrix} i & k & K \\ I & J & m \end{pmatrix} \overset{K}{g}_n \begin{pmatrix} n & I & J \\ K & j & l \end{pmatrix}, \quad \overset{IJ}{R}_{12}^{(\pm)} \overset{I}{L}_1^{(\pm) J} \overset{J}{g}_2 = \overset{J}{g}_2 \overset{I}{L}_1^{(\pm) I} \overset{IJ}{R}_{12}^{(\pm)},$$

$$\Delta(\overset{I}{L}_b^{(\pm) a}) = \sum_c \overset{I}{L}_b^{(\pm) c} \otimes \overset{I}{L}_c^{(\pm) a}, \quad \Delta(\overset{I}{g}_b^a) = \sum_c \overset{I}{g}_b^c \otimes \overset{I}{g}_c^a,$$

$$(\overset{I}{L}_b^{(\pm) a})^* = S^{-1}(\overset{I}{L}_a^{(\mp) b}), \quad (\overset{I}{g}_b^a)^* = S^{-1}(\overset{I}{g}_a^b).$$

The center of $U_q(\mathfrak{sl}(2, \mathbb{C})_{\mathbb{R}})$ is a polynomial algebra in two variables Ω_+, Ω_- and we have $\Omega_{\pm} = \text{tr}(\overset{1}{\mu}^{-1} \overset{1}{L}^{(\mp) -1} \overset{1}{g})$.

We will denote by \mathbb{S} the set of couples $\alpha = (\alpha^l, \alpha^r) \in \mathbb{C}^2$ such that $m_\alpha = \alpha^l - \alpha^r \in \frac{1}{2}\mathbb{Z}$. We will define $i\rho_\alpha = \alpha^l + \alpha^r + 1$. Reciprocally we will denote $\alpha(m, \rho) \in \mathbb{S}$ the unique element associated to $m \in \frac{1}{2}\mathbb{Z}$ and $\rho \in \mathbb{C}$.

We will use the following definitions: $\alpha \in \mathbb{S}$, $v_\alpha^{1/4} = v_{\alpha^l}^{1/4} v_{\alpha^r}^{-1/4}$, $e^{i\pi\alpha} = e^{i\pi\alpha^l} e^{i\pi\alpha^r}$. We define $[d_\alpha] = [d_{\alpha^r}][d_{\alpha^l}]$ as well as $\nu_1(d_\alpha) = \nu_1(d_{\alpha^r})\nu_1(d_{\alpha^l})$. We can extend φ to $\mathbb{S} \times \mathbb{Z} \times \mathbb{Z}$ as follows: $\varphi(\alpha, s) = \varphi(\alpha^l, s^l)\varphi(\alpha^r, s^r)$. For $\alpha = (\alpha_1, \dots, \alpha_n) \in \mathbb{S}^n$ and $s = (s_1, \dots, s_n) \in (\mathbb{Z}^2)^n$, we define: $\phi(\alpha, s) = \prod_{i=1}^n \phi(\alpha_i, s_i)$.

We distinguish two subsets of the previous one, \mathbb{S}_P (resp. \mathbb{S}_F), defined by $\rho_\alpha \in \mathbb{R}$ (resp. $(\alpha^l, \alpha^r) \in \frac{1}{2}\mathbb{Z}^+ \times \frac{1}{2}\mathbb{Z}^+$).

For $\alpha \in \mathbb{S}_F$ we define the vector space $\overset{\alpha}{\mathbb{V}} = \bigoplus_{C=|\alpha^l-\alpha^r|}^C \overset{C}{V}$.

For $\alpha \in \mathbb{S} \setminus \mathbb{S}_F$ we define the vector space $\overset{\alpha}{\mathbb{V}} = \bigoplus_{C, C-|\alpha^l-\alpha^r| \in \mathbb{N}}^C \overset{C}{V}$.

For $\alpha \in \mathbb{S}$ we define a representation $\overset{\alpha}{\Pi}$ on the vector space $\overset{\alpha}{\mathbb{V}}$ by the following expressions of the action of the generators of $U_q(sl(2, \mathbb{C})_{\mathbb{R}})$:

$$\overset{B}{L}(\pm)_j^i \overset{C}{e}_r = \sum_n^C \overset{C}{e}_n \overset{BC}{R}(\pm)_{jr}^{in}, \quad (174)$$

$$\overset{B}{g}_j^i \overset{C}{e}_r = \sum_{DEpk}^E \overset{E}{e}_p \begin{pmatrix} p & i & D \\ E & B & k \end{pmatrix} \begin{pmatrix} k & B & C \\ D & j & r \end{pmatrix} \Lambda_{EC}^{BD}(\alpha), \quad (175)$$

where $\overset{C}{e}_r, r = -C, \dots, C$ is an orthonormal basis of $\overset{C}{V}$ and the complex numbers $\Lambda_{EC}^{BD}(\alpha)$ have been defined in [12]. It is a basic result that these coefficients can be expressed in terms of $6j$ symbols [12, 14] as follows:

$$\Lambda_{AD}^{BC}(\alpha) = \sum_p \left\{ \begin{matrix} B & C & A \\ \alpha^l & \alpha^r & \alpha^l + p \end{matrix} \right\}_{(\epsilon)} \left\{ \begin{matrix} B & C & D \\ \alpha^l & \alpha^r & \alpha^l + p \end{matrix} \right\}_{(\epsilon)} \frac{v_{\alpha^l+p} v_A^{1/4} v_D^{1/4}}{v_{\alpha^r} v_B^{1/2} v_C^{1/2}} \quad (176)$$

$$= \sum_p \left\{ \begin{matrix} B & C & A \\ \alpha^r & \alpha^l & \alpha^l + p \end{matrix} \right\}_{(\epsilon)} \left\{ \begin{matrix} B & C & D \\ \alpha^r & \alpha^l & \alpha^l + p \end{matrix} \right\}_{(\epsilon)} \frac{v_{\alpha^l} v_B^{1/2} v_C^{1/2}}{v_{\alpha^l+p} v_A^{1/4} v_D^{1/4}}, \quad (177)$$

with $\epsilon = 0$ if $\alpha \in \mathbb{S}_F$ and $\epsilon = 1$ in the other case.

Let $A \in \frac{1}{2}\mathbb{Z}$, $\alpha \in \mathbb{S}$ we denote

$$\nu^{(A)}(\alpha) = \nu_{2A+1}(\alpha^l + \alpha^r - A + 1), \quad (178)$$

$$N^{(A)}(\alpha) = \frac{\nu_\infty(A + i\rho_\alpha + 1)\nu_\infty(i\rho_\alpha - A)}{(m_\alpha + i\rho_\alpha)_\infty \nu_1(m_\alpha + i\rho_\alpha)} e^{-i\pi \frac{m_\alpha}{2} \epsilon(i\rho)} e^{i\pi A} q^{-\frac{m_\alpha}{2}}. \quad (179)$$

We have shown in [12] that both $\frac{N^{(A)}(\alpha)}{N^{(D)}(\alpha)} \Lambda_{AD}^{BC}(\alpha)$ and $\frac{N^{(D)}(\alpha)}{N^{(A)}(\alpha)} \Lambda_{AD}^{BC}(\alpha)$ are Laurent polynomials in $q^{i\rho_\alpha}$.

A representation $\overset{\alpha}{\pi}$ associated to an element $\alpha \in \mathbb{S}_P$ is said to belong to the principal series (infinite dimensional unitary representation) whereas a representation $\overset{\alpha}{\pi}$ associated to an element $\alpha \in \mathbb{S}_F$ is an irreducible finite dimensional representation.

The action of the center on the module $\overset{\alpha}{\mathbb{V}}$ is such that $\overset{\alpha}{\Pi}(\Omega_{\pm}) = \omega_{\pm}(\alpha)id$ where $\omega_{+}(\alpha) = q^{2\alpha^l+1} + q^{-2\alpha^l-1}, \omega_{-}(\alpha) = q^{2\alpha^r+1} + q^{-2\alpha^r-1}$.

For $\alpha = (\alpha^l, \alpha^r) \in \mathbb{S}$ we can define the elements $\tilde{\alpha}, \bar{\alpha}$ and $\underline{\alpha}$ defined by $\tilde{\alpha} = (\alpha^r, \alpha^l), \bar{\alpha} = (\alpha^l, \alpha^r)$ and $\underline{\alpha} = (-\alpha^l - 1, -\alpha^r - 1)$.

The two modules $\overset{\alpha}{\mathbb{V}}$ and $\overset{\underline{\alpha}}{\mathbb{V}}$ are equivalent and we have $\Lambda_{AD}^{BC}(\alpha) = \Lambda_{AD}^{BC}(\underline{\alpha})$. Note also that $\overset{\alpha}{\mathbb{V}}$ is a module equivalent to $\overset{\beta}{\mathbb{V}}$ if $\beta = (\alpha^l + i\frac{\pi}{\ln q}, \alpha^r + i\frac{\pi}{\ln q})$ because $\Lambda_{AD}^{BC}(\alpha)$ depends only on $q^{2\alpha^l+1}$ and $q^{2\alpha^r+1}$. As a result we can always assume that $\rho_{\alpha} \in] + \frac{\pi}{\ln q}, -\frac{\pi}{\ln q}]$.

We can endow $\overset{\alpha}{\mathbb{V}}$ with a structure of pre-Hilbert space by defining the hermitian form $\langle \cdot, \cdot \rangle$ such that the basis $\{\overset{C}{e}_r(\alpha), C - |m_{\alpha}| \in \frac{1}{2}\mathbb{Z}^+, r = -C, \dots, C\}$ of $\overset{\alpha}{\mathbb{V}}$ is orthonormal.

Representations of the principal series are unitary in the sense that $\forall v, w \in \overset{\alpha}{\mathbb{V}}, \forall a \in U_q(sl(2, \mathbb{C})_{\mathbb{R}}), \langle a^*v, w \rangle = \langle v, aw \rangle$, this last property being equivalent to the relation: $\Lambda_{AD}^{BC}(\tilde{\alpha}) = \Lambda_{AD}^{BC}(\alpha)$.

When $\alpha \in \mathbb{S}_P$, we will denote by $\overset{\alpha}{\mathbb{H}}$ the separable Hilbert space, completion of $\overset{\alpha}{\mathbb{V}}$ which Hilbertian basis is $\{\overset{C}{e}_r(\alpha), C - |m_{\alpha}| \in \frac{1}{2}\mathbb{Z}^+, r = -C, \dots, C\}$.

Let us now recall some basic facts about the algebra of functions on $SL_q(2, \mathbb{C})_{\mathbb{R}}$ [24, 12]. We will use the notations of [12]. The space of compact supported functions on the quantum Lorentz group, denoted $Fun_c(SL_q(2, \mathbb{C})_{\mathbb{R}})$ is, by definition, $Fun(SU_q(2)') \otimes \left(\bigoplus_{I \in \frac{1}{2}\mathbb{Z}^+} End(\mathbb{C}^{d_I}) \right)$. This is a C^* algebra without unit. It contains the dense *-subalgebra [10] $Fun_{cc}(SL_q(2, \mathbb{C})_{\mathbb{R}}) = Pol(SU_q(2)') \otimes \left(\bigoplus_{I \in \frac{1}{2}\mathbb{Z}^+} End(\mathbb{C}^{d_I}) \right)$ which is a multiplier Hopf algebra [27], and which can be understood as being the quantization of the algebra generated by polynomials functions on $SU(2)$ and compact supported functions on $AN(2)$.

$(k_n^m \otimes E_q^p)_{C,D,m,n,p,q}$ is a vector basis of $Fun_{cc}(SL_q(2, \mathbb{C})_{\mathbb{R}})$ which is defined, for example, by duality from the generators of the envelopping algebra:

$$\langle \overset{A}{L}(\pm)^i_j \otimes \overset{B}{g}_l^k, k_n^m \otimes \overset{D}{E}_q^p \rangle = \overset{AC}{R}(\pm)^{im}_{jn} \delta_{B,D} \delta_q^k \delta_l^p. \quad (180)$$

We can describe completely the structure of the multiplier Hopf algebra in this basis;

$$\begin{aligned} k_j^i \otimes E_l^k \cdot k_n^m \otimes E_q^p &= \sum_{Frs} \begin{pmatrix} i & m & F \\ A & C & r \end{pmatrix} \begin{pmatrix} s & A & C \\ F & j & n \end{pmatrix} \delta_l^p \delta_{B,D} \delta_q^r \otimes E_s^k \\ \Delta(k_j^i \otimes E_l^k) &= \mathcal{F}_{23}^{-1} \left(\sum_{\substack{C,D,m, \\ p,q,r,s}} \begin{pmatrix} q & s & B \\ C & D & l \end{pmatrix} \begin{pmatrix} k & C & D \\ B & p & r \end{pmatrix} k_m^i \otimes E_q^p \otimes k_j^m \otimes E_r^s \right) \mathcal{F}_{23} \\ \epsilon(k_j^i \otimes E_l^k) &= \delta_j^i \delta_{B,0} \quad (k_j^i \otimes E_l^k)^* = S^{-1}(k_j^i) \otimes E_l^k \quad \text{with } \mathcal{F}_{12}^{-1} = \sum_{J,x,y} E_y^x \otimes S^{-1}(k_x^y). \end{aligned} \quad (181)$$

The space of right and left invariant linear forms (also called Haar measures) on $Fun_c(SL_q(2, \mathbb{C})_{\mathbb{R}})$

is a vector space of dimension one and we will pick one element h , which is defined by:

$$h(k_j^A \otimes E_l^B) = \delta_{A,0} (\mu^{-1})_l^m [d_B]. \quad (182)$$

This Haar measure can be used to define an hermitian form on $Fun_c(SL_q(2, \mathbb{C})_{\mathbb{R}})$:

$$\forall f, g \in Fun_c(SL_q(2, \mathbb{C})_{\mathbb{R}}), \quad \langle f, g \rangle = h(f^* g). \quad (183)$$

Using the associated L^2 norm, $\|a\|_{L^2} = h(a^* a)^{\frac{1}{2}}$, we can complete the space $Fun_c(SL_q(2, \mathbb{C})_{\mathbb{R}})$ into the Hilbert space of L^2 functions on the quantum Lorentz group, denoted $L^2(SL_q(2, \mathbb{C})_{\mathbb{R}})$.

$Fun_{cc}(SL_q(2, \mathbb{C})_{\mathbb{R}})$ is a multiplier Hopf algebra with basis $(u_i) = ((k_n^C \otimes E_r^D)_{C,D,m,n,p,r})$. The restricted dual of $Fun_{cc}(SL_q(2, \mathbb{C})_{\mathbb{R}})$, denoted $\tilde{U}_q(sl(2, \mathbb{C})_{\mathbb{R}})$, is the vector space spanned by the dual basis $(u^i) = (\tilde{X}_m^C \otimes \tilde{g}_p^D)$. It is also, by duality, a multiplier Hopf algebra and $U_q(sl(2, \mathbb{C})_{\mathbb{R}})$ is included as an algebra in the multiplier algebra $M(\tilde{U}_q(sl(2, \mathbb{C})_{\mathbb{R}}))$. If Π is the principal representation of $U_q(sl(2, \mathbb{C})_{\mathbb{R}})$, acting on $\overset{\alpha}{\mathbb{V}}$, it is possible [10] to associate to it a unique representation $\tilde{\Pi}$ of $\tilde{U}_q(sl(2, \mathbb{C})_{\mathbb{R}})$, acting on $\overset{\alpha}{\mathbb{V}}$, such that $\tilde{\Pi}(\tilde{X}_m^C)(\tilde{e}_r^D) = \delta_{C,D} \delta_r^m \tilde{e}_m^D$.

We define for all f element of $Fun_{cc}(SL_q(2, \mathbb{C})_{\mathbb{R}})$, the operator $\Pi(f) = \sum_i \tilde{\Pi}(u^i) h(u_i f)$. It is easy to show that $\Pi(f)$ is of finite rank and of finite corank.

The matrix elements of the representation $\tilde{\Pi}$ are the linear form on $U_q(sl(2, \mathbb{C})_{\mathbb{R}})$ which expression is:

$$\overset{\alpha}{G}_{Bj}^{Ai} = \sum_{MD} \begin{pmatrix} m & r \\ A & D \end{pmatrix} \begin{pmatrix} M \\ x \end{pmatrix} \begin{pmatrix} x \\ M \end{pmatrix} \begin{pmatrix} D & B \\ s & j \end{pmatrix} \Lambda_{AB}^{DM}(\alpha) k_m^A \otimes E_r^D. \quad (184)$$

We have a natural inclusion $Fun_{cc}(SL_q(2, \mathbb{C})_{\mathbb{R}}) \xrightarrow{\iota} (Fun_{cc}(SL_q(2, \mathbb{C})_{\mathbb{R}}))^*$ defined thanks to the Haar measure h on the quantum group ([12]) by: if $f \in Fun(SL_q(2, \mathbb{C}))$ we have $\iota(f)(a) = h(fa)$, $\forall a \in Fun_{cc}(SL_q(2, \mathbb{C}))$. ι extends naturally to $(U_q(sl(2, \mathbb{C})_{\mathbb{R}}))^*$ and we trivially have: $\overset{\alpha}{\tilde{\Pi}}(f)_{Bj}^{Ai} = \langle \iota(\overset{\alpha}{G}_{Bj}^{Ai}), f \rangle$.

If f is a function on \mathbb{S}_P , we will define f_m to be the function defined by $f_m(\rho) = f(\alpha(m, \rho))$. We will denote

$$\int_{\mathbb{S}_P} d(\alpha) f(\alpha) = \sum_{m \in \frac{1}{2}\mathbb{Z}} \frac{2\pi}{|\ln q|} \int_{\frac{\pi}{\ln q}}^{\frac{-\pi}{\ln q}} d\rho f_m(\rho). \quad (185)$$

The Plancherel formula can be written as:

$$\forall \psi \in Fun_{cc}(SL_q(2, \mathbb{C})_{\mathbb{R}}), \quad \|\psi\|_{L^2}^2 = \int_{\mathbb{S}_P} d(\alpha) \mathcal{P}(\alpha) \operatorname{tr}(\overset{\alpha}{\tilde{\Pi}}(\mu^{-1}) \overset{\alpha}{\tilde{\Pi}}(\psi) (\overset{\alpha}{\tilde{\Pi}}(\psi))^{\dagger})$$

where we have denoted $\mathcal{P}(m, \rho) = (q - q^{-1})^2 [m + i\rho][m - i\rho]$.

A.2 Tensor Product and Clebsch-Gordan maps.

The aim of this section is to give explicit formulae for the intertwiners (Clebsch-Gordan maps) between the representation $\overset{\alpha}{\mathbb{H}} \otimes \overset{\beta}{\mathbb{H}}$ and the representation $\overset{\gamma}{\mathbb{H}}$, in term of complex continuations of 6-j symbols of $U_q(su(2))$, where α, β, γ belong to \mathbb{S}_P or to \mathbb{S}_F . Let us recall that the tensor product of these representations decomposes as:

$$\overset{\alpha}{\mathbb{V}} \otimes \overset{\beta}{\mathbb{V}} = \bigoplus_{\substack{\alpha^l + \beta^l, \gamma^r = \alpha^r + \beta^r \\ \gamma^l = |\alpha^l - \beta^l|, \gamma^r = |\alpha^r - \beta^r|}} \overset{\gamma}{\mathbb{V}}, \quad \text{where } \alpha, \beta \in \mathbb{S}_F, \quad (186)$$

$$\overset{\alpha}{\mathbb{V}} \otimes \overset{\beta}{\mathbb{V}} = \bigoplus_{\substack{m = \alpha^l, n = \alpha^r \\ m = -\alpha^l, n = -\alpha^r}} \overset{(m,n)+\beta}{\mathbb{V}}, \quad \alpha \in \mathbb{S}_F, \beta \in \mathbb{S}, \quad (187)$$

$$\overset{\alpha}{\mathbb{H}} \otimes \overset{\beta}{\mathbb{H}} = \bigoplus_{m_\gamma \in J_{m_\alpha, m_\beta}} \int^\oplus d\rho_\gamma \overset{\gamma}{\mathbb{H}}, \quad \alpha, \beta, \gamma \in \mathbb{S}_P, \quad (188)$$

where $J_{m,n} = \{p \in \frac{1}{2}\mathbb{Z}, m + n + p \in \mathbb{Z}\}$.

Let $(\alpha, \beta, \gamma) \in \mathbb{S}^3$, the intertwiner $\Psi_{\alpha,\beta}^\gamma: \overset{\alpha}{\mathbb{V}} \otimes \overset{\beta}{\mathbb{V}} \rightarrow \overset{\gamma}{\mathbb{V}}$ is defined in [14] by:

$$\Psi_{\alpha,\beta}^\gamma(\overset{A}{e}_i(\alpha) \otimes \overset{B}{e}_j(\beta)) = \sum_{C,k} \overset{C}{e}_k(\gamma) \begin{pmatrix} Ck & \alpha & \beta \\ \gamma & Ai & Bj \end{pmatrix} = \sum_{C,k} \overset{C}{e}_k(\gamma) \begin{pmatrix} k & A & B \\ C & i & j \end{pmatrix} \begin{bmatrix} C & \alpha & \beta \\ \gamma & A & B \end{bmatrix} \quad (189)$$

where the reduced elements $\begin{bmatrix} C & \alpha & \beta \\ \gamma & A & B \end{bmatrix}$ are defined by:

$$\begin{aligned} \begin{bmatrix} C & \alpha & \beta \\ \gamma & A & B \end{bmatrix} &= \sqrt{[dB]} e^{-i\pi B} \sum_p \left\{ \begin{matrix} C & \gamma^r & \gamma^l \\ \beta^l & \alpha^l & \alpha^l + p \end{matrix} \right\} \left\{ \begin{matrix} C & B & A \\ \alpha^r & \alpha^l & \alpha^l + p \end{matrix} \right\} \left\{ \begin{matrix} B & \beta^r & \beta^l \\ \gamma^r & \alpha^l + p & \alpha^r \end{matrix} \right\} \\ &= \frac{v_{\alpha^r}^{1/2} v_{\alpha^l}^{1/4} v_{\beta^l}^{1/4} v_{\gamma^r}^{1/4} v_B^{1/4} v_C^{1/4}}{v_{\alpha^l+p}^{1/2} v_{\alpha^r}^{1/4} v_{\beta^r}^{1/4} v_{\gamma^l}^{1/4} v_A^{1/4}} q^{(\alpha^r + \beta^l - \gamma^r)} e^{i\pi(\alpha^r + \beta^l - \gamma^r)} \frac{\nu_1(d_{\gamma^r})}{\nu_1(d_{\alpha^r})\nu_1(d_{\beta^l})} \quad (190) \end{aligned}$$

where ν_1 is defined in the appendix of [14], and is such that $\nu_1(x)^2 = 1 - q^{2x}$, and the 6j coefficients are of type 0, 1 or 3 depending on the nature of α, β, γ and their expressions are given in [14].

Remarks:

1. Note that from the analysis of proposition 24, the only possible singularities of this expression appear when one of the numbers $2\alpha^l + 1, 2\beta^l + 1, 2\gamma^l + 1$ is an integer. We shall denote such a configuration special. This is explained from the fact that generically $\dim \text{Hom}(\overset{\alpha}{\mathbb{V}} \otimes \overset{\beta}{\mathbb{V}}, \overset{\gamma}{\mathbb{V}}) = 1$ except possibly for the case where $2\alpha^l + 1, 2\beta^l + 1, 2\gamma^l + 1$ is an integer. A couple $(\alpha, \beta) \in \mathbb{S}^2$ is said to be of finite type if α or β belongs to \mathbb{S}_F . In this case, if $\gamma \in \mathbb{S}$, $N_{\alpha,\beta}^\gamma = \dim \text{Hom}(\overset{\alpha}{\mathbb{V}} \otimes \overset{\beta}{\mathbb{V}}, \overset{\gamma}{\mathbb{V}})$ is zero or one dimensional. We denote by $\mathbb{S}(\alpha, \beta)$ the set of elements $\gamma \in \mathbb{S}$ such that $N_{\alpha,\beta}^\gamma = 1$.

2. The formula of the reduced element gives in particular for the special configuration where $\alpha = \beta \neq (-\frac{1}{2}, -\frac{1}{2}), \gamma = 0 : \Psi_{\alpha,\alpha}^0 : \overset{\alpha}{\mathbb{V}} \otimes \overset{\alpha}{\mathbb{V}} \rightarrow \mathbb{C}$ with:

$$\Psi_{\alpha,\alpha}^0(e_i^A(\alpha) \otimes e_j^B(\alpha)) = \begin{pmatrix} 00 & \alpha & \alpha \\ 0 & Ai & Bj \end{pmatrix} = \begin{pmatrix} 0 & A & B \\ 0 & i & j \end{pmatrix} \begin{bmatrix} 0 & \alpha & \alpha \\ 0 & A & B \end{bmatrix} \quad (191)$$

where the reduced element $\begin{bmatrix} 0 & \alpha & \alpha \\ 0 & A & B \end{bmatrix}$ is defined as:

$$\begin{bmatrix} 0 & \alpha & \alpha \\ 0 & A & B \end{bmatrix} = Y_{(A;m_\alpha)}^{(1)} \delta_{A,B} e^{-i\pi A} \sqrt{[d_A]} q^{\alpha^r + \alpha^l} \frac{e^{i\pi\alpha}}{\nu_1(d_\alpha)}.$$

3. Let $(\alpha, \beta, \gamma) \in \mathbb{S}^3$, we can define the intertwiner

$$\tilde{\Psi}_{\alpha,\beta}^\gamma = \Psi_{\alpha,\beta}^\gamma q^{(-\alpha^r - \beta^l + \gamma^r)} e^{-i\pi(\alpha^r + \beta^l - \gamma^r)} \frac{v_{\beta^r}^{1/4} v_{\gamma^l}^{1/4} \nu_1(d_{\alpha^r}) \nu_1(d_{\beta^l})}{v_{\beta^l}^{1/4} v_{\gamma^r}^{1/4} \nu_1(d_{\gamma^r})} \quad (192)$$

which is the intertwiner that we used in our previous work [14].

The new normalisation is such that when $\alpha, \beta, \gamma \in \mathbb{S}_F$ the following proposition holds.

Proposition 22 . Let $I \in \mathbb{S}_F$, the module $\overset{I}{\mathbb{V}}$ decomposes as $\overset{I}{\mathbb{V}} = \overset{I^l}{V} \otimes \overset{I^r}{V}$ according to the isomorphism $\mathfrak{U}_q(sl(2, \mathbb{C})_{\mathbb{R}}) = \mathfrak{U}_q(sl(2)) \otimes_{R^{-1}} \mathfrak{U}_q(sl(2))$. The basis $e_i^A(I)$ defined by (174)(175) is expressed as

$$e_i^A(I) = \begin{pmatrix} t & u & A \\ I^l & I^r & i \end{pmatrix} v_{I^l}^{\frac{1}{4}} v_{I^r}^{\frac{1}{4}} v_A^{-\frac{1}{4}} e_t \otimes e_u. \quad (193)$$

The expression of the $\mathfrak{U}_q(sl(2, \mathbb{C})_{\mathbb{R}})$ intertwiner $\Psi_{IJ}^K = \Psi_{I^l J^l}^{K^l} \otimes \Psi_{I^r J^r}^{K^r} R^{-1}$ in this basis is exactly given by the formulas (189)(190).

Proof: Trivial computation. \square

We will denote by $(\overset{\alpha}{\mathbb{V}})^{r*}$ the restricted dual of $\overset{\alpha}{\mathbb{V}}$ defined as $(\overset{\alpha}{\mathbb{V}})^{r*} = \bigoplus_{C, C - |\alpha^l - \alpha^r| \in \mathbb{N}} \overset{C}{V}^*$. It is endowed with a structure of $U_q(sl(2, \mathbb{C})_{\mathbb{R}})$ module and the two modules $(\overset{\alpha}{\mathbb{V}})^{r*}$ and $\overset{\alpha}{\mathbb{V}}$ are isomorphic from remark 2.

Similarly we can define for $(\alpha, \beta, \gamma) \in \mathbb{S}^3$ and $(A, B, C) \in \frac{1}{2}\mathbb{Z}^+$,

$$\begin{aligned} \begin{bmatrix} A & B & \gamma \\ \alpha & \beta & C \end{bmatrix} &= \sqrt{[d_B]} e^{-i\pi B} \sum_p \left\{ \begin{matrix} C & \gamma^r & \gamma^l \\ \beta^l & \alpha^l & \alpha^l + p \end{matrix} \right\} \left\{ \begin{matrix} C & B & A \\ \alpha^r & \alpha^l & \alpha^l + p \end{matrix} \right\} \left\{ \begin{matrix} B & \beta^r & \beta^l \\ \gamma^r & \alpha^l + p & \alpha^r \end{matrix} \right\} \\ &= \frac{v_{\alpha^l + p}^{1/2} v_{\alpha^r}^{1/4} v_{\beta^r}^{1/4} v_{\gamma^l}^{1/4}}{v_{\alpha^r}^{1/2} v_{\alpha^l}^{1/4} v_{\beta^l}^{1/4} v_{\gamma^r}^{1/4}} \frac{v_A^{1/4}}{v_B^{1/4} v_C^{1/4}} q^{(\alpha^r + \beta^l - \gamma^r)} e^{i\pi(\alpha^r + \beta^l - \gamma^r)} \frac{\nu_1(d_{\gamma^r})}{\nu_1(d_{\alpha^r}) \nu_1(d_{\beta^l})} \quad (194) \end{aligned}$$

We endow $(\overset{\alpha}{\mathbb{V}}^{r*} \otimes \overset{\beta}{\mathbb{V}}^{r*})^*$ with the structure of $U_q(sl(2, \mathbb{C})_{\mathbb{R}})$ module such that the natural inclusion $\overset{\alpha}{\mathbb{V}} \otimes \overset{\beta}{\mathbb{V}} \hookrightarrow (\overset{\alpha}{\mathbb{V}}^{r*} \otimes \overset{\beta}{\mathbb{V}}^{r*})^*$ is an intertwiner. As a result we can define for $\alpha, \beta, \gamma \in \mathbb{S}$ the intertwiner $\Phi_{\gamma}^{\alpha, \beta} : \overset{\gamma}{\mathbb{V}} \rightarrow (\overset{\alpha}{\mathbb{V}}^{r*} \otimes \overset{\beta}{\mathbb{V}}^{r*})^*$ by:

$$\begin{aligned} \Phi_{\gamma}^{\alpha, \beta}(\overset{C}{e}_k(\gamma)) &= \sum_{A, i; B, j} \overset{A}{e}_i(\alpha) \otimes \overset{B}{e}_j(\beta) \begin{pmatrix} Ai & Bj \\ \alpha & \beta \end{pmatrix} \left| \begin{matrix} \gamma \\ Ck \end{matrix} \right. \\ &= \sum_{A, i; B, j} (\overset{A}{e}_i(\alpha) \otimes \overset{B}{e}_j(\beta)) \begin{pmatrix} i & j \\ A & B \end{pmatrix} \left| \begin{matrix} C \\ k \end{matrix} \right. \begin{bmatrix} A & B \\ \alpha & \beta \end{bmatrix} \left| \begin{matrix} \gamma \\ C \end{matrix} \right. \end{pmatrix}. \quad (195)$$

Note that it is only in the case where (α, β) is of finite type that the sum is finite, and in that case $\Phi_{\gamma}^{\alpha, \beta}$ is an intertwiner from $\overset{\gamma}{\mathbb{V}}$ to $\overset{\alpha}{\mathbb{V}} \otimes \overset{\beta}{\mathbb{V}}$.

The normalization of the intertwiners has been chosen in order to have the following orthogonality relations: if (α, β) is of finite type, we have

$$\Psi_{\alpha, \beta}^{\gamma'} \Phi_{\gamma}^{\alpha, \beta} = N_{\alpha, \beta}^{\gamma} \delta_{\gamma}^{\gamma'} id_{\overset{\gamma}{\mathbb{V}}}, \quad (196)$$

$$\sum_{\gamma \in \mathbb{S}(\alpha, \beta)} \Phi_{\gamma}^{\alpha, \beta} \Psi_{\alpha, \beta}^{\gamma} = id_{\overset{\alpha}{\mathbb{V}} \otimes \overset{\beta}{\mathbb{V}}}. \quad (197)$$

Proposition 23 *The reduced element satisfy the following symmetries:*

$$\begin{bmatrix} C \\ \gamma \end{bmatrix} \left| \begin{matrix} \alpha & \beta \\ A & B \end{matrix} \right. = \begin{bmatrix} B & A \\ \beta & \alpha \end{bmatrix} \left| \begin{matrix} \gamma \\ C \end{matrix} \right. \quad (198)$$

$$\begin{bmatrix} C \\ \gamma \end{bmatrix} \left| \begin{matrix} \alpha & \beta \\ A & B \end{matrix} \right. = \begin{bmatrix} A & B \\ \tilde{\alpha} & \tilde{\beta} \end{bmatrix} \left| \begin{matrix} \tilde{\gamma} \\ C \end{matrix} \right. \quad (199)$$

$$\begin{bmatrix} C \\ \gamma \end{bmatrix} \left| \begin{matrix} \alpha & \beta \\ A & B \end{matrix} \right. = q^{\alpha^r + \alpha^l - \gamma^l - \gamma^r} e^{i\pi(C-A+\alpha-\gamma)} \frac{[d_A]^{\frac{1}{2}} \nu_1(d_{\gamma})}{[d_C]^{\frac{1}{2}} \nu_1(d_{\alpha})} \begin{bmatrix} A \\ \tilde{\alpha} \end{bmatrix} \left| \begin{matrix} \tilde{\gamma} & \beta \\ C & B \end{matrix} \right. \quad (200)$$

Proof: Left to the reader. \square

The following proposition precises the nature of the singularities of $\Psi_{\alpha, \beta}^{\gamma}$ in the variables $q^{i\rho_{\alpha}}, q^{i\rho_{\beta}}, q^{i\rho_{\gamma}}$. Let $\alpha, \beta, \gamma \in \mathbb{S}$ we denote

$$\varsigma(\alpha, \beta, \gamma) = \nu_{|m_{\alpha} + m_{\beta} + m_{\gamma}|} \left(\frac{1}{2} (i\rho_{\alpha} + i\rho_{\beta} + i\rho_{\gamma} + 1 - |m_{\alpha} + m_{\beta} + m_{\gamma}|) \right) \quad (201)$$

$$\zeta(\alpha, \beta, \gamma) = \varsigma(\alpha, \beta, \gamma) \varsigma(\underline{\alpha}, \beta, \gamma) \varsigma(\alpha, \underline{\beta}, \gamma) \varsigma(\alpha, \beta, \underline{\gamma}). \quad (202)$$

Note that $\varsigma(\alpha, \beta, \gamma) = \varsigma(\tilde{\alpha}, \tilde{\beta}, \tilde{\gamma})$.

Proposition 24 *The reduced elements $\begin{bmatrix} C \\ \gamma \end{bmatrix} \left| \begin{matrix} \alpha & \beta \\ A & B \end{matrix} \right.$ satisfies the property:*

$$\begin{bmatrix} C \\ \gamma \end{bmatrix} \left| \begin{matrix} \alpha & \beta \\ A & B \end{matrix} \right. e^{-i\pi(\alpha + \beta - \gamma)} = \frac{\zeta(\alpha, \beta, \gamma) \nu_1(2\gamma^l + 1) \nu_1(2\gamma^r + 1)}{\nu^{(A)}(\alpha) \nu^{(B)}(\beta) \nu^{(C)}(\gamma)} P_{m_{\alpha} m_{\beta} m_{\gamma}}^{ABC}(q^{i\rho_{\alpha}}, q^{i\rho_{\beta}}, q^{i\rho_{\gamma}}) \quad (203)$$

where $P_{m_{\alpha} m_{\beta} m_{\gamma}}^{ABC}$ is a polynomial.

Proof: This property comes from a careful study of the expression of the reduced element in term of $6j(1)$ and $6j(3)$ given by (190). First of all from the expression of the $6j$, the square roots can only be of the form $\nu_1(z+n)$, where $n \in \mathbb{Z}$ and $z \in \{2\alpha^l + 1, 2\beta^l + 1, 2\gamma^l + 1, \epsilon_\alpha \alpha^l + \epsilon_\beta \beta^l + \epsilon_\gamma \gamma^l\}$ with $\epsilon_\alpha, \epsilon_\beta, \epsilon_\gamma \in \{1, -1\}$.

We first study the behaviour in β and γ . It is easy to see from the explicit definition of the $6j(3)$ (given in [14]) that the behaviour in β and in γ is of the form

$$\frac{\nu_1(2\gamma^l + 1)\nu_1(2\gamma^r + 1)}{\nu^{(B)}(\beta)\nu^{(C)}(\gamma)}U(\alpha, \beta, \gamma)$$

with U having no singularities in $\beta^l + n, \gamma^l + n$. Using the first and second relation of the previous proposition, we can exchange the role of α and β . This explains the behaviour $\frac{\nu_1(2\gamma^l + 1)\nu_1(2\gamma^r + 1)}{\nu^{(A)}(\alpha)\nu^{(B)}(\beta)\nu^{(C)}(\gamma)}$.

We now analyze how it depends on the variable $\rho_\alpha + \rho_\beta + \rho_\gamma$. From the expression of the $6j$ given in ([14]), we obtain that the reduced element can be expressed as $\frac{\nu_\infty(\alpha^r + \beta^r + \gamma^r + 2)}{\nu_\infty(\alpha^l + \beta^l + \gamma^l + 2)}R(\alpha, \beta, \gamma)$ where $R(\alpha, \beta, \gamma)$ has no singularities in $\alpha^l + \beta^l + \gamma^l + n$ as well as $\frac{\nu_\infty(\alpha^l + \beta^l + \gamma^l + 2)}{\nu_\infty(\alpha^r + \beta^r + \gamma^r + 2)}T(\alpha, \beta, \gamma)$ where $T(\alpha, \beta, \gamma)$ has no singularities in $\alpha^l + \beta^l + \gamma^l + n$. In order to prove this we just expand the $6j$ using its definition and the trivial symmetries of the $6j$. As a result when $m_\alpha + m_\beta + m_\gamma \geq 0$, $\frac{\nu_\infty(\alpha^r + \beta^r + \gamma^r + 2)}{\nu_\infty(\alpha^l + \beta^l + \gamma^l + 2)} = \varsigma(\alpha, \beta, \gamma)$ and we obtain the announced result. In the case where $m_\alpha + m_\beta + m_\gamma < 0$ we use the other behaviour. This analysis therefore implies that the reduced element is equal to $\varsigma(\alpha, \beta, \gamma)S(\alpha, \beta, \gamma)$ with S regular in $\alpha^l + \beta^l + \gamma^l + n$. The analysis for the combination $\alpha^l + \beta^l - \gamma^l$ is similar. Indeed it is easy to show using only the definition of the $6j$ and a trivial symmetry that the behaviour is of the form $\frac{\nu_\infty(\alpha^r + \beta^r - \gamma^r + 1)}{\nu_\infty(\alpha^l + \beta^l - \gamma^l + 1)}U(\alpha, \beta, \gamma)$ with U regular in $\alpha^l + \beta^l - \gamma^l + n$. If $m_\alpha + m_\beta - m_\gamma > 0$ then we obtain the announced behaviour $\varsigma(\alpha, \beta, \gamma)$, if not we use the first two relations of the previous formula to exchange α, β, γ with $\tilde{\beta}, \tilde{\alpha}, \tilde{\gamma}$, and we are back to the situation $m_{\tilde{\alpha}} + m_{\tilde{\beta}} - m_{\tilde{\gamma}} > 0$. The other combination $-\alpha^l + \beta^l + \gamma^l$ is deduced from the previous analysis by using the third relation of the previous proposition. Finally the combination $\alpha^l - \beta^l + \gamma^l$ is obtained using the exchange of the role of α and β . This completes the proof. \square

In [14] we introduced a function $M : \mathbb{S}_p^3 \rightarrow \mathbb{R}^+$, as follows:

$$M(\alpha, \beta, \gamma) = \left| \frac{(1-q^2)(1)_\infty^2 q^{2(m_\alpha + m_\beta + m_\gamma)}}{(d_{\alpha^l})_1 (d_{\beta^l})_1 (d_{\gamma^l})_1} \right| \times \left| \frac{\xi(d_{\alpha^r}, d_{\beta^r}, d_{\gamma^r})}{\xi(\alpha^r + \beta^r + \gamma^r + 2, \underline{\alpha}^r + \beta^r + \gamma^r + 2, \alpha^r + \underline{\beta}^r + \gamma^r + 2, \alpha^r + \beta^r + \underline{\gamma}^r + 2)} \right|. \quad (204)$$

This function is such that the intertwiner:

$$\begin{aligned} \tilde{\Psi}_{\alpha\beta} : \overset{\alpha}{\mathbb{V}} \otimes \overset{\beta}{\mathbb{V}} &\rightarrow \int^\oplus d\gamma \overset{\gamma}{\mathbb{H}} \\ v \otimes w &\mapsto (\gamma \mapsto M(\alpha, \beta, \gamma)^{\frac{1}{2}} \tilde{\Psi}_{\alpha\beta}^\gamma(v \otimes w)) \end{aligned}$$

is an isometry.

A.3 Miscellaneous properties

Proposition 25 Let $I = (I^l, I^r) \in \mathbb{S}_F$ indexing the finite-dimensional representation Π^I of $U_q(\mathfrak{sl}(2, \mathbb{C})_{\mathbb{R}})$. The star acts on the elements of $SL_q(2, \mathbb{C})_{\mathbb{R}}$ as:

$$\mathbb{G}^{\star} = \tilde{W} \tilde{\mathbb{G}} \tilde{W}^{-1} \quad (205)$$

where we have defined $\tilde{W}_{Bb}^{Aa} = e^{i\pi A} v_A^{-1/2} w_{ab} \delta_B^A$.

Proof: From the expression of the matrix element of the representation (184), we have

$$\mathbb{G}_{Bj}^{Ai} = \sum_{MD} \begin{pmatrix} m & r & M \\ A & D & x \end{pmatrix} \begin{pmatrix} x & D & B \\ M & s & j \end{pmatrix} \Lambda_{AB}^{DM}(I) k_m^A \otimes E_r^s.$$

Then the star acts as:

$$\mathbb{G}_{Bj}^{Ai \star} = \sum_{MD} \begin{pmatrix} m & r & M \\ A & D & x \end{pmatrix} \begin{pmatrix} x & D & B \\ M & s & j \end{pmatrix} \overline{\Lambda_{AB}^{DM}(I)} S^{-1}(k_i^m) \otimes E_s^r.$$

Using the relations

$$\overline{\Lambda_{AB}^{DM}(I)} = e^{i\pi(2D+2M-A-B)} \Lambda_{AB}^{DM}(I), \quad (206)$$

$$S^{-1}(k_i^m) = w^{-1 mu} k_u^A w_{li}^A, \quad (207)$$

a straightforward computation implies

$$\mathbb{G}_{Bj}^{Ai \star} = e^{i\pi A} v_A^{-1/2} w_{li}^A \tilde{\mathbb{G}}_{Bu}^{Al} e^{-i\pi B} v_B^{1/2} w^{-1 ui}.$$

□

Proposition 26 The star acts on the elements of $U_q(\mathfrak{sl}(2, \mathbb{C})_{\mathbb{R}})$ as:

$$\mathbb{L}(\pm) \star = \tilde{W} \tilde{\mathbb{L}}(\pm) \tilde{W}^{-1}. \quad (208)$$

Proof: By definition, $\mathbb{L}(\pm)_{Bb}^{Aa} = (\Pi \otimes id)(\mathbb{R}(\pm))_{Bb}^{Aa}$, then

$$\mathbb{L}(\pm)_{Bb}^{Aa \star} = \overline{\Pi(x_i)_{Bb}^{Aa} y_i^*},$$

where we have denoted $\mathbb{R} = \sum_i x_i \otimes y_i$. The previous proposition and the relation $\mathbb{R}(\pm) \star \otimes \star = \mathbb{R}(\pm)^{-1} = (S \otimes id)(\mathbb{R})$ imply (208). A similar proof implies as well:

$$\mathbb{L}(\pm)^{-1 \star} = \tilde{W} \tilde{\mu}^{-1} \tilde{\mathbb{L}}(\pm)^{-1} \tilde{\mu} \tilde{W}^{-1}.$$

□

It is also immediate to note that the R-matrix and the ribbon-element μ satisfy the relations:

$$\overline{\mathbb{R}^{IJ}} = \bar{W} \otimes \bar{W} \mathbb{R}^{IJ} \bar{W}^{-1} \otimes \bar{W}^{-1} , \quad (209)$$

$$\overline{\mu} = \bar{W} \bar{\mu} \bar{W}^{-1} . \quad (210)$$

In order to define the star on the moduli algebra, we also need the following proposition:

Proposition 27 *The complex conjugates of the Clebsch-Gordan maps of $U_q(sl(2, \mathbb{C})_{\mathbb{R}})$ satisfy:*

$$\overline{\Phi_K^{IJ}} = \lambda_{\tilde{K}}^{\tilde{I}\tilde{J}} (\bar{W} \otimes \bar{W}) \mathbb{R}^{\tilde{I}\tilde{J}} \Phi_{\tilde{K}}^{\tilde{I}\tilde{J}} \bar{W}^{-1} , \quad (211)$$

$$\overline{\Psi_{IJ}^K} = \lambda_{\tilde{K}}^{\tilde{I}\tilde{J}-1} \bar{W} \Psi_{\tilde{I}\tilde{J}}^{\tilde{K}} \mathbb{R}^{\tilde{I}\tilde{J}-1} (\bar{W}^{-1} \otimes \bar{W}^{-1}) , \quad (212)$$

where we have defined

$$\lambda_{\tilde{K}}^{\tilde{I}\tilde{J}} = e^{i\pi(I^r - I^l + J^r - J^l + K^l - K^r)} \frac{v_{K^r}^{1/2} v_{I^l}^{1/2} v_{J^l}^{1/2}}{v_{I^r}^{1/2} v_{J^r}^{1/2} v_{K^l}^{1/2}} , \quad (213)$$

for $I, J, K \in \mathbb{S}_F$.

Proof: We will give the proof of the first relation, the other one is similar. Φ_K^{IJ} is an intertwiner and then for $x \in U_q(sl(2, \mathbb{C})_{\mathbb{R}})$ we have

$$\bar{\Pi}^I(x_{(1)}) \otimes \bar{\Pi}^J(x_{(2)}) \Phi_K^{IJ} = \Phi_K^{IJ} \bar{\Pi}^K(x) .$$

We take the complex-conjugate of the previous equation and an easy computation leads to:

$$\begin{aligned} \overline{\bar{\Pi}^I(x_{(1)}) \otimes \bar{\Pi}^J(x_{(2)}) \Phi_K^{IJ}} &= \overline{\Phi_K^{IJ} \bar{\Pi}^K(x)} , \\ \overline{\bar{\Pi}^I(S^{-1}(x_{(2)}^*)) \otimes \bar{\Pi}^J(S^{-1}(x_{(1)}^*)) \Phi_K^{IJ}} &= \overline{\Phi_K^{IJ} \bar{\Pi}^K(S^{-1}(x^*))} , \\ \overline{\bar{\Pi}^{\tilde{I}}(x_{(1)}) \otimes \bar{\Pi}^{\tilde{J}}(x_{(2)}) (\mathbb{R}^{-1} \bar{W}^{-1} \otimes \bar{W}^{-1} \Phi_K^{\tilde{I}\tilde{J}} \bar{W})} &= \overline{(\mathbb{R}^{-1} \bar{W}^{-1} \otimes \bar{W}^{-1} \Phi_K^{\tilde{I}\tilde{J}} \bar{W}) \bar{\Pi}^{\tilde{K}}(x)} . \end{aligned}$$

As $\text{Hom}(\bar{V}^{\tilde{K}}; \bar{V}^{\tilde{I}} \otimes \bar{V}^{\tilde{J}})$ is at most one dimensional, there exists $\lambda_{\tilde{K}}^{\tilde{I}\tilde{J}} \in \mathbb{C}$ such that:

$$\overline{\Phi_K^{IJ}} = \lambda_{\tilde{K}}^{\tilde{I}\tilde{J}} \bar{W} \otimes \bar{W} \mathbb{R}^{\tilde{I}\tilde{J}} \Phi_{\tilde{K}}^{\tilde{I}\tilde{J}} \bar{W}^{-1} .$$

Let us show that $\lambda_{\tilde{K}}^{\tilde{I}\tilde{J}}$ is given by the expression (213). We have

$$\langle e^A \otimes e^B | \Phi_K^{IJ} | e^C \rangle = \left[\begin{array}{cc|c} A & B & K \\ I & J & C \end{array} \right] \left(\begin{array}{cc|c} i & j & C \\ A & B & k \end{array} \right) ,$$

and a direct calculation shows that

$$\begin{aligned}
& \langle e^i \otimes e^j | \overset{I}{W} \otimes \overset{J}{W} \overset{IJ}{\mathbb{R}} \Phi_K^{IJ} \overset{K}{W}^{-1} | e_k \rangle = \\
& = \sum_{B'} \overset{I}{W}_{Al}^{Ai} \overset{J}{W}_{Bm}^{Bj} \overset{IJ}{R}_{an B'p}^{Al B'm} \langle e^n \otimes e^p | \Phi_K^{IJ} | e_r \rangle \overset{I}{W}_{Ck}^{-1Cr} \\
& = \sum_{B'} \Lambda_{BB'}^{AC}(J) \left[\begin{array}{c|c} A & B' \\ I & J \end{array} \middle| \begin{array}{c} K \\ C \end{array} \right] e^{i\pi(A+B-C)} \left(\begin{array}{c|c} i & j \\ A & B \end{array} \middle| \begin{array}{c} C \\ k \end{array} \right) \quad (\text{using the expressions of } R \text{ and } \Phi) \\
& = \sum_{B'MN} \left\{ \begin{array}{c|c} A & C \\ J^r & J^l \end{array} \middle| \begin{array}{c} B \\ N \end{array} \right\} \left\{ \begin{array}{c|c} A & C \\ J^l & J^r \end{array} \middle| \begin{array}{c} B' \\ N \end{array} \right\} \frac{v_{J^r} v_A^{1/2} v_C^{1/2}}{v_N v_B^{1/4} v_{B'}^{1/4}} e^{i\pi(A+B-C)} \frac{v_{K^r}^{1/4} v_{K^l}^{1/4}}{v_C^{1/4}} \frac{v_A^{1/4}}{v_{I^r}^{1/4} v_{I^l}^{1/4}} \frac{v_{B'}^{1/4}}{v_{J^r}^{1/4} v_{J^l}^{1/4}} \\
& \quad \left\{ \begin{array}{c|c} A & C \\ J^l & J^r \end{array} \middle| \begin{array}{c} B' \\ M \end{array} \right\} \left\{ \begin{array}{c|c} K^r & I^l \\ J^r & C \end{array} \middle| \begin{array}{c} M \\ K^l \end{array} \right\} \left\{ \begin{array}{c|c} I^l & N \\ J^r & I^r \end{array} \middle| \begin{array}{c} K^r \\ A \end{array} \right\} \frac{v_{I^r}^{1/2} v_N^{1/2}}{v_{K^r}^{1/2} v_A^{1/2}} \left(\begin{array}{c|c} i & j \\ A & B \end{array} \middle| \begin{array}{c} C \\ k \end{array} \right) \\
& = \sum_M \left\{ \begin{array}{c|c} A & C \\ J^l & J^r \end{array} \middle| \begin{array}{c} B \\ M \end{array} \right\} \left\{ \begin{array}{c|c} K^r & I^l \\ J^l & C \end{array} \middle| \begin{array}{c} M \\ K^l \end{array} \right\} \left\{ \begin{array}{c|c} I^l & M \\ J^r & I^r \end{array} \middle| \begin{array}{c} K^r \\ A \end{array} \right\} \\
& \quad \frac{v_{J^r}^{1/2} v_C^{1/4} v_A^{1/4}}{v_M^{1/2} v_B^{1/4}} \frac{v_{J^r}^{1/4} v_{I^r}^{1/4} v_{K^l}^{1/4}}{v_{J^l}^{1/4} v_{I^l}^{1/4} v_{K^r}^{1/4}} e^{i\pi(A+B-C)} \left(\begin{array}{c|c} i & j \\ A & B \end{array} \middle| \begin{array}{c} C \\ k \end{array} \right) \quad (\text{using orthogonality on } 6j(0)) \\
& = \sum_M \left\{ \begin{array}{c|c} A & C \\ J^r & J^l \end{array} \middle| \begin{array}{c} B \\ M \end{array} \right\} \left\{ \begin{array}{c|c} K^l & I^r \\ J^r & C \end{array} \middle| \begin{array}{c} M \\ K^r \end{array} \right\} \left\{ \begin{array}{c|c} I^r & M \\ J^l & I^l \end{array} \middle| \begin{array}{c} K^l \\ A \end{array} \right\} \quad (\text{using Yang-Baxter equation}) \\
& \quad \frac{v_B^{1/4} v_C^{1/4}}{v_A^{1/4}} \frac{v_M^{1/2}}{v_{J^l}^{1/2}} \frac{v_{J^r}^{1/4} v_{I^r}^{1/4} v_{K^l}^{1/4}}{v_{J^l}^{1/4} v_{I^l}^{1/4} v_{K^r}^{1/4}} e^{i\pi(A+B-C)} \left(\begin{array}{c|c} i & j \\ A & B \end{array} \middle| \begin{array}{c} C \\ k \end{array} \right)
\end{aligned}$$

As a result, from the defining relation of the reduced element given in the appendix A.2, one obtains the announced value (213) for $\lambda_{\bar{K}}^{\bar{I}\bar{J}}$. \square

The $6j$ -symbols of $U_q(\mathfrak{sl}(2, \mathbb{C})_{\mathbb{R}})$ when it includes at least a finite-dimensional representation are easily defined and are expressed as a product of two continuations of $6j$ -symbols of $U_q(\mathfrak{su}(2))$.

Definition 10 Let $I \in \mathbb{S}_F, \alpha, \beta, \gamma \in \mathbb{S}$, the space of intertwiners $\text{Hom}(\overset{I}{\mathbb{V}} \otimes \overset{\alpha}{\mathbb{V}} \otimes \overset{\beta}{\mathbb{V}}, \overset{\gamma}{\mathbb{V}})$ is a finite dimensional space of dimension at most $\dim \overset{I}{\mathbb{V}}$. The non zero elements $\Psi_{\alpha'\beta}^{\gamma} \Psi_{I\alpha}^{\alpha'}$ with $\alpha' \in \mathbb{S}(I, \alpha)$ form a basis of this space. The intertwiner $\Psi_{I\gamma'}^{\gamma} \Psi_{\alpha\beta}^{\gamma'}$ with $\gamma' \in \mathbb{S}(I, \gamma)$ can be expressed in this basis and the components are the $6j$ coefficients of $U_q(\mathfrak{sl}(2, \mathbb{C})_{\mathbb{R}})$ when it includes at least a finite-dimensional representation:

$$\Psi_{I\gamma'}^{\gamma} \Psi_{\alpha\beta}^{\gamma'} = \sum_{\alpha' \in \mathbb{S}(I, \alpha)} \left\{ \begin{array}{c|c} I & \alpha \\ \beta & \gamma \end{array} \middle| \begin{array}{c} \alpha' \\ \gamma' \end{array} \right\} \Psi_{\alpha'\beta}^{\gamma} \Psi_{I\alpha}^{\alpha'}. \quad (214)$$

Proposition 28 *These 6j-symbols of $U_q(sl(2, \mathbb{C})_{\mathbb{R}})$ are expressed as a product of two continuations of 6j-symbols of $U_q(su(2))$:*

$$\left\{ \begin{array}{c|c} I & K \\ J & L \end{array} \middle| \begin{array}{c} M \\ N \end{array} \right\} = \left\{ \begin{array}{c|c} I^l & K^l \\ J^l & L^l \end{array} \middle| \begin{array}{c} M^l \\ N^l \end{array} \right\}_{(0)} \left\{ \begin{array}{c|c} I^r & K^r \\ J^r & L^r \end{array} \middle| \begin{array}{c} M^r \\ N^r \end{array} \right\}_{(0)} \quad (215)$$

$$\left\{ \begin{array}{c|c} I & K \\ \beta & \beta' \end{array} \middle| \begin{array}{c} M \\ \beta' \end{array} \right\} = \left\{ \begin{array}{c|c} I^l & K^l \\ \beta^l & \beta'^l \end{array} \middle| \begin{array}{c} M^l \\ \beta''^l \end{array} \right\}_{(1)} \left\{ \begin{array}{c|c} I^r & K^r \\ \beta^r & \beta'^r \end{array} \middle| \begin{array}{c} M^r \\ \beta''^r \end{array} \right\}_{(1)} \quad (216)$$

$$\left\{ \begin{array}{c|c} I & \alpha \\ \beta & \gamma \end{array} \middle| \begin{array}{c} \alpha' \\ \gamma' \end{array} \right\} = \left\{ \begin{array}{c|c} I^l & \alpha^l \\ \beta^l & \gamma^l \end{array} \middle| \begin{array}{c} \alpha'^l \\ \gamma'^l \end{array} \right\}_{(3)} \left\{ \begin{array}{c|c} I^r & \alpha^r \\ \beta^r & \gamma^r \end{array} \middle| \begin{array}{c} \alpha'^r \\ \gamma'^r \end{array} \right\}_{(3)} \quad (217)$$

where $I, J, K, L, M, N \in \mathbb{S}_F$ and $\alpha, \beta, \gamma, \alpha', \beta', \gamma', \beta'', \gamma'' \in \mathbb{S}$ with the constraint that $\rho_x = \rho_{x'}$ with $x = \alpha, \beta, \beta', \gamma$.

Proof: The first relation (215) is a trivial application of proposition 22. The two other relations follows from standard continuation arguments. \square

Proposition 29 *Let $\bar{\Pi}^\alpha$ be an irreducible unitary representation of $U_q(sl(2, \mathbb{C})_{\mathbb{R}})$, labelled by the couple $\alpha \in \mathbb{S}_P$. The explicit formula for $\vartheta_{I\alpha}$ where $I \in \mathbb{S}_F$ is*

$$\vartheta_{I\alpha} = \frac{[(2I^l + 1)(2\alpha^l + 1)] [(2I^r + 1)(2\alpha^r + 1)]}{[2\alpha^l + 1] [2\alpha^r + 1]}. \quad (218)$$

Proof:

$$\begin{aligned} tr_I(\mu \begin{array}{c|c} I & \alpha \\ \mathbb{R} & \mathbb{R} \end{array} \middle| \begin{array}{c} C \\ C \end{array})_{C^c} &= \sum_A \mu_{Aa}^I \mu_{Ab}^{I\alpha} \mu_{Cd}^{C^c} \mu_{Ca}^{\alpha I} \\ &= \sum_{AFG} \mu_a^A \left(\begin{array}{c|c} c & a \\ C & A \end{array} \middle| \begin{array}{c} F \\ f \end{array} \right) \left(\begin{array}{c|c} f & A \\ F & b \end{array} \middle| \begin{array}{c} C \\ d \end{array} \right) \Lambda_{CD}^{AF}(\alpha) \\ &\quad \left(\begin{array}{c|c} b & d \\ A & C \end{array} \middle| \begin{array}{c} G \\ g \end{array} \right) \left(\begin{array}{c|c} g & C \\ G & c \end{array} \middle| \begin{array}{c} A \\ a \end{array} \right) \Lambda_A^{DG}(I) \\ &= \sum_{AF} \frac{[d_F]}{[d_C]} \Lambda_C^{AF}(\alpha) \Lambda_A^{CF}(I) . \end{aligned}$$

From the linear relation (101) of [12], we deduce the following relation (when one takes $A = D$ and sums over C):

$$\sum_{MN} \Lambda_A^{MN}(\alpha) \Lambda_M^{AN}(I) [d_N] = \frac{[(2I^l + 1)(2\alpha^l + 1)]}{[2\alpha^l + 1]} \sum_C [d_C] \Lambda_A^{I^r C}(\alpha) \frac{v_A^{1/2} v_{I^r}^{1/2}}{v_C^{1/2}} .$$

As a result, we have

$$tr_I(\mu \begin{array}{c|c} I & \alpha \\ \mathbb{R} & \mathbb{R} \end{array} \middle| \begin{array}{c} C \\ C \end{array})_{C^c} = \frac{[(2I^l + 1)(2\alpha^l + 1)]}{[2\alpha^l + 1]} \frac{1}{[d_C]} \sum_A [d_A] \Lambda_C^{I^r A}(\alpha) \frac{v_C^{1/2} v_{I^r}^{1/2}}{v_A^{1/2}} .$$

$$\begin{aligned}
\begin{array}{c} Ai^\alpha \\ \text{---} \\ Bj^\beta \end{array} \begin{array}{c} \gamma \\ \text{---} \\ Ck \end{array} &= \left(\begin{array}{cc|c} Ai & Bj & \gamma \\ \alpha & \beta & Ck \end{array} \right) & \begin{array}{c} Ck^\gamma \\ \text{---} \\ Bj^\beta \end{array} \begin{array}{c} \alpha \\ \text{---} \\ Ai \end{array} &= \left(\begin{array}{c|cc} Ck & \alpha & \beta \\ \gamma & Ai & Bj \end{array} \right) \\
\begin{array}{c} Ai^\alpha \\ \text{---} \\ Bj^\beta \end{array} \begin{array}{c} \beta \\ \text{---} \\ Ck \end{array} &= \begin{array}{c} \alpha\beta \\ \mathbb{R} \end{array} \begin{array}{c} -1Ai \\ \text{---} \\ Dl \end{array} \begin{array}{c} Bj \\ \text{---} \\ Ck \end{array} & \begin{array}{c} Ai^\alpha \\ \text{---} \\ Bj^\beta \end{array} \begin{array}{c} \beta \\ \text{---} \\ Ck \end{array} &= \begin{array}{c} \alpha\beta \\ \mathbb{R} \end{array} \begin{array}{c} Ai \\ \text{---} \\ Dl \end{array} \begin{array}{c} Bj \\ \text{---} \\ Ck \end{array} \\
\begin{array}{c} Ai^\alpha \\ \text{---} \\ Bj^\alpha \end{array} &= \begin{array}{c} \alpha \\ \mathbb{W} \end{array} \begin{array}{c} -1Ai \\ \text{---} \\ Bj \end{array} & \begin{array}{c} \alpha \\ \text{---} \\ Ai \end{array} &= \begin{array}{c} \alpha \\ \mathbb{W} \end{array} \begin{array}{c} Ai \\ \text{---} \\ Bj \end{array}
\end{aligned}$$

Figure 8: Pictorial representation.

From the lemma 6 of [12], we finally have

$$\frac{1}{[d_C]} \sum_A [d_A] \Lambda_C^{rA}(\alpha) \frac{v_C^{1/2} v_r^{1/2}}{v_A^{1/2}} = \frac{[(2I^r + 1)(2\alpha^r + 1)]}{[2\alpha^r + 1]}. \quad (219)$$

□

Definition 11 Let A, B, C, D elements of \mathbb{S}_F , $\alpha \in \mathbb{S}$, and $s \in \mathcal{S}$ we define

$$\Lambda_{AD}^{BC}(\alpha, s) = \sum_{t \in \mathcal{S}} \left\{ \begin{array}{cc|c} B & C & A \\ \alpha + s & \alpha & \alpha + t \end{array} \right\} \left\{ \begin{array}{cc|c} B & C & D \\ \alpha + s & \alpha & \alpha + t \end{array} \right\} \frac{v_{\alpha+t} v_A^{1/4} v_D^{1/4}}{v_\alpha v_B^{1/2} v_C^{1/2}} \quad (220)$$

$$= \Lambda_{A'D'}^{B'C'}(\alpha^l + s^l, \alpha^l) \Lambda_{A''D''}^{B''C''}(\alpha^r, \alpha^r + s^r). \quad (221)$$

Appendix B: Graphical proofs

This appendix is devoted to technical parts of the article that are proved using graphical methods. We need first to introduce our conventions on the graphical description of intertwiners of $U_q(\mathfrak{sl}(2, \mathbb{C})_{\mathbb{R}})$ which are summarized in figure 8.

B.1 The p -punctured sphere

We will present in this subsection an explicit expression of the function $K_{0,p}^{P(\pm)} \left(\begin{array}{c} \alpha \\ \beta, s \end{array} \right)$ in terms of $6j$ symbols. We have used a pictorial representation of this function in the case $p = 4$. The case of p -punctures is a straightforward generalisation. This enables us to give an explicit expression for the general case which is described in the following proposition. We need to introduce new functions at this stage. If P is the palette

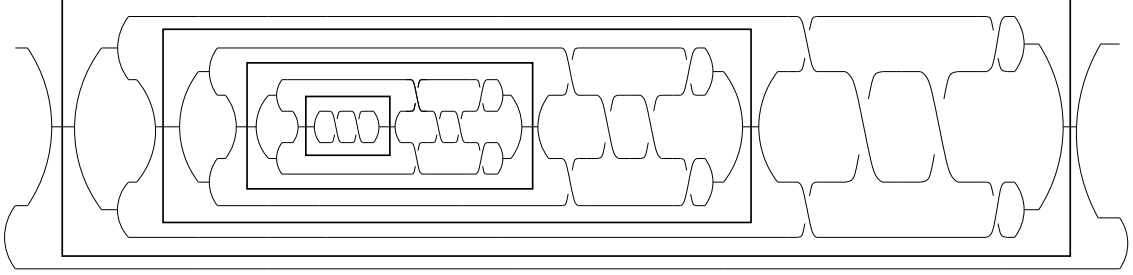

Figure 9: Iterative decomposition of $K_{0,p}^{P(\pm)}$.

$P = (IJNKLUTW)$, with $I = J = K = L = \emptyset$ in the p-punctured sphere case, we denote $P(i)$ the quintuplet $(N_i, U_i, U_{i+1}, T_i, T_{i+1})$. Let $Q = (N, U, U', T, T') \in \mathbb{S}_F^5$, $\alpha, \beta, \beta' \in \mathbb{S}$, $s, t, s', t' \in \mathcal{S}$, we define the function:

$$\begin{aligned} \mathcal{K}^{Q(\pm)} \left(\begin{array}{c|c} \alpha & t, t' \\ \beta, \beta' & s, s' \end{array} \right) &= \sum_{a,b,c,d \in \mathcal{S}^4} \frac{v_N v_\alpha v_{\beta'+s'}^{1/2}}{v_{\alpha+a} v_{\beta'+c}^{1/2}} \left(\frac{v_{T'}^{1/2} v_{\beta'+b}^{1/2} v_{\beta'+d}^{1/2}}{v_T^{1/2} v_N^{1/2} v_{\beta'+c}^{1/2} v_{\beta'+t'}^{1/2}} \right)^{\pm 1} \left\{ \begin{array}{cc|c} N & U & U' \\ \beta' & \beta'+t' & \beta'+b \end{array} \right\} \\ &\left\{ \begin{array}{cc|c} U & \beta & \beta+t \\ \alpha & \beta'+b & \beta' \end{array} \right\} \left\{ \begin{array}{cc|c} T & \beta+s & \beta+t \\ \alpha & \beta'+b & \beta'+c \end{array} \right\} \left\{ \begin{array}{cc|c} N & \alpha & \alpha+a \\ \beta+s & \beta'+d & \beta'+c \end{array} \right\} \left\{ \begin{array}{cc|c} N & \alpha & \alpha+a \\ \beta+s & \beta'+d & \beta'+s' \end{array} \right\} \\ &\left\{ \begin{array}{cc|c} T & N & T' \\ \beta'+s' & \beta'+t' & \beta'+d \end{array} \right\} \left\{ \begin{array}{cc|c} N & \beta'+c & \beta'+d \\ T & \beta'+t' & \beta'+b \end{array} \right\}. \quad (222) \end{aligned}$$

Proposition 30 *The following identity holds:*

$$K_{0,p}^{P(\pm)} \left(\begin{array}{c|c} \alpha \\ \beta, s \end{array} \right) = [dW] \sum_{\substack{t \in \mathcal{S}^{p+1} \\ t_1=t_2, t_{p+1}=(0,0)}} \prod_{i=1}^p \mathcal{K}^{P(i)(\pm)} \left(\begin{array}{c|c} \alpha_i \\ \beta_i, \beta_{i+1} \end{array} \left| \begin{array}{c} t_i, t_{i+1} \\ s_i, s_{i+1} \end{array} \right. \right), \quad (223)$$

where $t \in \mathcal{S}^{p-1}$ and we have used the following conventions: $s_1 = s_2 = (0, 0)$, $U_1 = T_1 = (0, 0)$, $U_2 = T_2 = N_1$, $\beta_1 = (0, 0)$, $\beta_2 = \alpha_1$, $\beta_p = \alpha_p$, $\beta_{p+1} = (0, 0)$, $s_p = (0, 0)$ and $U_{p+1} = T_{p+1} = W$.

Proof: To prove this identity, we first prove it in the case where $\alpha_1, \dots, \alpha_p, \beta_3, \dots, \beta_{p-1} \in \mathbb{S}_F$. $K_{0,p}^{P(\pm)} \left(\begin{array}{c|c} \alpha \\ \beta, s \end{array} \right)$ is represented by the graph in figure 3, this graph is recasted in the graph shown in picture 9 after having used orthogonality relations: we have made a summation on the coloring $\beta_i + t_i$ of the lines crossing a box. This graph clearly shows an iterative structure, where the generic element is represented by the picture 10. The value of this elementary graph is $\mathcal{K}^{P(i)(\pm)} \left(\begin{array}{c|c} \alpha_i \\ \beta_i, \beta_{i+1} \end{array} \left| \begin{array}{c} t_i, t_{i+1} \\ s_i, s_{i+1} \end{array} \right. \right)$ and is easily expressed in terms of $6j$ coefficients. The proof of the proposition when $\alpha_1, \dots, \alpha_p, \beta_3, \dots, \beta_{p-1} \in \mathbb{S}$ is straightforward from continuation argument. \square

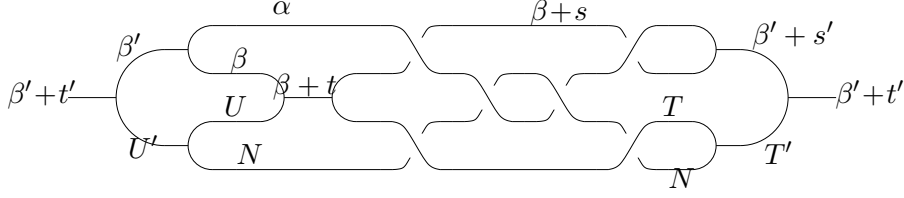

Figure 10: Elementary block in the p -punctured case.

A $U_q(\mathfrak{sl}(2, \mathbb{C})_{\mathbb{R}})$ palette P is equivalent to a couple of two $U_q(\mathfrak{sl}(2))$ palettes denoted (P^l, P^r) . It is trivial to show that $\overset{(P^l, 0)}{K}_{0,p}^{(\pm)} \begin{pmatrix} \alpha \\ \beta, s \end{pmatrix}$ (resp. $\overset{(0, P^r)}{K}_{0,p}^{(\pm)} \begin{pmatrix} \alpha \\ \beta, s \end{pmatrix}$) depends only on the variables α^l, β^l, s^l (resp. α^r, β^r, s^r). We can therefore define $\overset{P^l}{K}_{0,p}^{(\pm)} \begin{pmatrix} \alpha^l \\ \beta^l, s^l \end{pmatrix} = \overset{(P^l, 0)}{K}_{0,p}^{(\pm)} \begin{pmatrix} \alpha \\ \beta, s \end{pmatrix}$ and similarly for the right variables. From the proposition (28) the following factorisation property is satisfied:

$$\overset{P}{K}_{0,p}^{(\pm)} \begin{pmatrix} \alpha \\ \beta, s \end{pmatrix} = \overset{P^l}{K}_{0,p}^{(\pm)} \begin{pmatrix} \alpha^l \\ \beta^l, s^l \end{pmatrix} \overset{P^r}{K}_{0,p}^{(\pm)} \begin{pmatrix} \alpha^r \\ \beta^r, s^r \end{pmatrix}. \quad (224)$$

The proof of the unitarity of the representation of the moduli algebra uses as central tools the following proposition.

Proposition 31 *The functions $\overset{P}{K}_{0,p}^{(\pm)} \begin{pmatrix} \alpha \\ \beta, s \end{pmatrix}$ satisfy the symmetries:*

1. $\overline{\overset{P}{K}_{0,p}^{(\pm)} \begin{pmatrix} \alpha \\ \beta, s \end{pmatrix}} = \overset{P}{K}_{0,p}^{(\pm)} \begin{pmatrix} \bar{\alpha} \\ \bar{\beta}, s \end{pmatrix}$
2. $\overset{P}{K}_{0,p}^{(\pm)} \begin{pmatrix} \alpha \\ \beta, s \end{pmatrix} = \overset{\tilde{P}}{K}_{0,p}^{(\mp)} \begin{pmatrix} \tilde{\alpha} \\ \tilde{\beta} + \tilde{s}, -\tilde{s} \end{pmatrix}$
3. $\overset{P}{K}_{0,p}^{(\pm)} \begin{pmatrix} \alpha \\ \beta, -s \end{pmatrix} = \psi_{0,p}[\alpha, \beta, s] \overset{P}{K}_{0,p}^{(\pm)} \begin{pmatrix} \alpha \\ \beta, s \end{pmatrix}$ with $\psi_{0,p}[\alpha, \beta, s] \in \{+1, -1\}$.

Proof: The first property is a simple consequence of the following facts: q is real, $\overline{\nu_p(z)} = \nu_p(\bar{z})$, the explicit expression of $\overset{P}{K}_{0,p}^{(\pm)} \begin{pmatrix} \alpha \\ \beta, s \end{pmatrix}$ in terms of $6j$ and $v_I^{1/2} v_{\alpha}^{1/2} v_{\alpha+p}^{-1/2} = v_I^{1/2} v_{\alpha}^{1/2} v_{\alpha+p}^{-1/2}$, if $I \pm p \in \mathbb{N}$.

To prove the second relation, we first notice that it is equivalent to prove the relation:

$$\begin{aligned} \overset{P}{K}_{0,p}^{(\pm)} \begin{pmatrix} \alpha \\ \beta, s \end{pmatrix} \frac{\Xi_{0,p}[\alpha, \beta]}{\Xi_{0,p}[\alpha, \beta + s]} &= \overset{\tilde{P}}{K}_{0,p}^{(\mp)} \begin{pmatrix} \tilde{\alpha} \\ \tilde{\beta} + \tilde{s}, -\tilde{s} \end{pmatrix} \frac{\Xi_{0,p}[\tilde{\alpha}, \tilde{\beta} + \tilde{s}]}{\Xi_{0,p}[\tilde{\alpha}, \tilde{\beta}]} \frac{\Xi_{0,p}[\alpha, \beta] \Xi_{0,p}[\tilde{\alpha}, \tilde{\beta}]}{\Xi_{0,p}[\alpha, \beta + s] \Xi_{0,p}[\tilde{\alpha}, \tilde{\beta} + \tilde{s}]} \\ &= \overset{\tilde{P}}{K}_{0,p}^{(\mp)} \begin{pmatrix} \tilde{\alpha} \\ \tilde{\beta} + \tilde{s}, -\tilde{s} \end{pmatrix} \frac{\Xi_{0,p}[\tilde{\alpha}, \tilde{\beta} + \tilde{s}]}{\Xi_{0,p}[\tilde{\alpha}, \tilde{\beta}]} \frac{\Xi_{0,p}[\alpha, \beta]^2}{\Xi_{0,p}[\alpha, \beta + s]^2} \end{aligned} \quad (225)$$

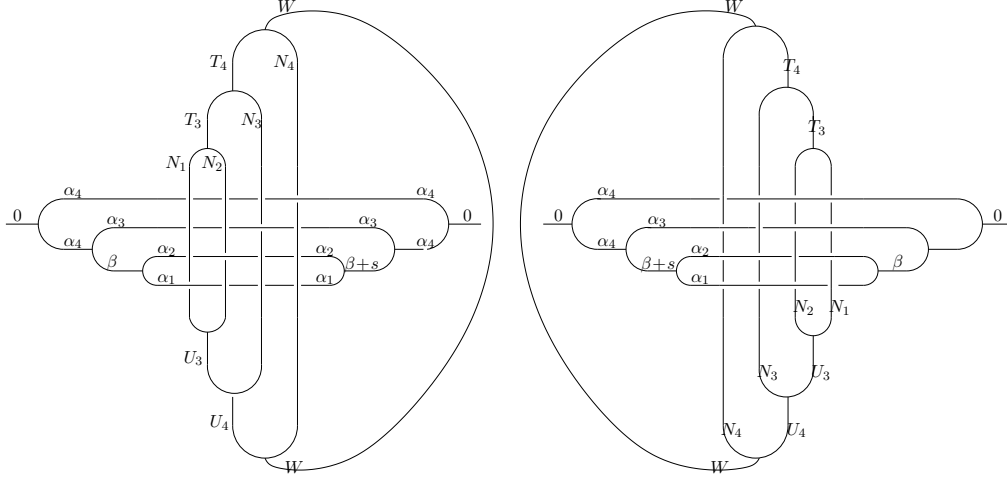

Figure 11: Equivalent expressions of $K_{0,4}^{P(+)}$ after trivial topological moves.

which is an identity on rational functions in $q^{i\rho_{\alpha_1}}, \dots, q^{i\rho_{\alpha_p}}, q^{i\rho_{\beta_3}}, \dots, q^{i\rho_{\beta_{p-3}}}$. As a result, using the standard continuation argument, it is sufficient to show the second relation when $\alpha_1, \dots, \alpha_p, \beta_3, \dots, \beta_{p-3} \in \mathbb{S}_F$. $K_{0,p}^{P(+)} \left(\begin{array}{c} \alpha \\ \beta, s \end{array} \right)$ is represented by the picture () which is the same, after topological moves, as the left graph (figure 3). This graph, after a flip, is equal to the right graph (figure 3). The value of this graph is equal to the value of the graph pictured in figure (12), because of the property $\mathbb{R}^{IJ(+)} = \mathbb{R}^{\bar{I}\bar{J}(-)}$. This last graph is equal to $K_{0,p}^{\bar{P}(-)} \left(\begin{array}{c} \tilde{\alpha} \\ \tilde{\beta} + \tilde{s}, -\tilde{s} \end{array} \right)$. This ends the proof of the second property.

The third property follows from a detailed computation making use of the explicit expression of $K_{0,p}^{P(+)} \left(\begin{array}{c} \alpha \\ \beta, s \end{array} \right)$ in terms of $6j$. Using the symmetries of the $6j$ proved in [14], a direct computation show that:

$$\mathcal{K}^{\mathcal{Q}(\pm)} \left(\begin{array}{c} \underline{\alpha} \\ \underline{\beta}, \underline{\beta}' \end{array} \middle| \begin{array}{c} -t, -t' \\ -s, -s' \end{array} \right) = e^{i\pi(U-U'+T-T'+s-s')} \psi_{0,p}(\alpha, \beta, \beta', s, s') \mathcal{K}^{\mathcal{Q}(\pm)} \left(\begin{array}{c} \alpha \\ \beta, \beta' \end{array} \middle| \begin{array}{c} t, t' \\ s, s' \end{array} \right) \quad (226)$$

with

$$\psi(\alpha, \beta, \beta', s, s') = \frac{\mathcal{V}(\alpha+\beta+\beta', s+s') \mathcal{V}(\alpha+\beta-\beta', s-s')}{\mathcal{V}(-\alpha+\beta+\beta', -s+s') \mathcal{V}(\alpha-\beta+\beta', -s-s')} \quad (227)$$

It is easy to show that the selection rules imply that $\psi(\alpha, \beta, \beta', s, s') \in \{+1, -1\}$. As a result we obtain the third property with

$$\psi[\alpha, \beta, s] = \prod_{i=1}^p \psi_{0,p}(\alpha_i, \beta_i, \beta_{i+1}, s_i, s_{i+1}). \quad (228)$$

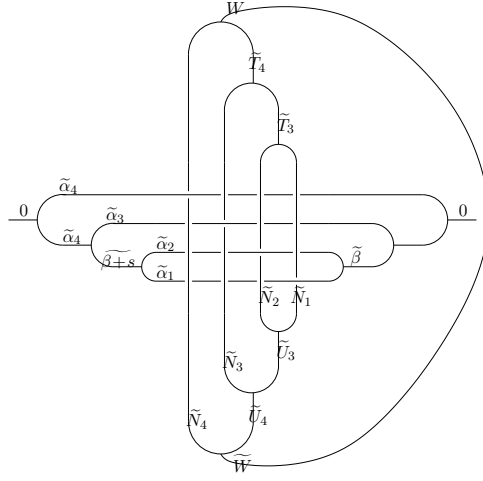

Figure 12: Expression of $K_{0,4}^{P(+)}$ after trivial manipulations.

B.2 The genus-n surface

Like the previous subsection, we will present in this one an explicit expression of the function $K_{n,0}^{P(\pm)} \left(\begin{matrix} \kappa; k \\ \lambda, \sigma, \tau; \ell, s, t \end{matrix} \right)$ in terms of $6j$ symbols. We have used a pictorial representation of this function in the case $n = 3$ (the case $n = 2$ being degenerate). The case of arbitrary genus n is a straightforward generalisation. We need to introduce new functions at this stage.

If P is the palette $P = (IJNKLUTW)$, with $N = \emptyset$ for the genus- n case, we denote $P(i)$ the 8-uplet $(I_i, J_i, K_i, L_i, U_i, U_{i+1}, T_i, T_{i+1})$. If $I' = (I'_3, \dots, I'_{n+1}) \in \mathbb{S}_F^{n-2}$, we denote $II'(i) = (I_i, I'_i, I'_{i+1})$. Let $Q = (I, J, K, L, U, U', T, T') \in \mathbb{S}_F^8$, $Q' = (I, J, K) \in \mathbb{S}_F^3$, $\lambda, \sigma, \sigma', \tau, \tau' \in \mathbb{S}$ and $\ell, s, s', t, t', a, b, b', c, c' \in \mathcal{S}$, we define the functions:

$$\begin{aligned}
\mathcal{K}^{Q(\pm)} \left(\begin{matrix} \tau' & b', c' \\ \lambda, \tau & \ell, a, b, c \end{matrix} \right) &= \sum_{x,y,z \in \mathcal{S}, X, Y \in \mathbb{S}_F} \left(\frac{v_K^{1/2} v_{T'}^{1/2}}{v_X^{1/2} v_L^{1/2}} \right)^{\pm 1} \frac{v_X^{1/2} v_I^{1/2} v_L^{1/2}}{v_K^{1/2} v_Y^{1/2} v_L^{1/2}} \frac{v_{\lambda+y}^{3/2}}{v_{\lambda+z}^{1/2} v_{\lambda+l}^{1/2} v_{\lambda+a}^{1/2}} \frac{v_{\tau'+c'}}{v_{\tau+x}^{1/2}} \\
&\left\{ \begin{matrix} U' & \tau+t & \tau+x \\ \lambda+l & \tau'+c' & \tau'+t' \end{matrix} \right\} \left\{ \begin{matrix} K & U & U' \\ \tau+t & \tau+x & \tau+c \end{matrix} \right\} \left\{ \begin{matrix} K & T & X \\ \tau+b & \tau+x & \tau+c \end{matrix} \right\} \\
&\left\{ \begin{matrix} T & L & T' \\ \lambda+a & \lambda+z & \lambda+y \end{matrix} \right\} \left\{ \begin{matrix} T & K & X \\ \lambda+l & \lambda+z & \lambda+y \end{matrix} \right\} \left\{ \begin{matrix} T' & \lambda+a & \lambda+z \\ \tau+b & \tau'+c' & \tau'+b' \end{matrix} \right\} \\
&\left\{ \begin{matrix} X & \lambda+l & \lambda+z \\ \tau'+c' & \tau+b & \tau+x \end{matrix} \right\} \left\{ \begin{matrix} K & I & Y \\ \lambda & \lambda+y & \lambda+l \end{matrix} \right\} \left\{ \begin{matrix} I & J & L \\ I & Y & K \end{matrix} \right\} \left\{ \begin{matrix} L & I & Y \\ \lambda & \lambda+y & \lambda+a \end{matrix} \right\} \quad (229)
\end{aligned}$$

$$\begin{aligned} \mathcal{N}'^{(1)} \left(\begin{array}{c|c} \tau' & t', b' \\ \lambda, \tau & \ell, t, a, b \end{array} \right) &= \sum_{x \in \mathcal{S}} \frac{v_\tau^{1/2} v_\lambda^{1/2} v_K^{1/2} v_{\tau+b}^{1/2}}{v_{\tau'}^{1/2} v_{\tau+x}^{1/2} v_J^{1/2}} \left\{ \begin{array}{c|c} I & \lambda \\ \tau'+b' & \tau+b \end{array} \middle| \begin{array}{c} \lambda+a \\ \tau+x \end{array} \right\} \\ &\quad \left\{ \begin{array}{c|c} K & \tau \\ \lambda & \tau'+b' \end{array} \middle| \begin{array}{c} \tau+x \\ \tau' \end{array} \right\} \left\{ \begin{array}{c|c} I & J \\ \tau & \tau+x \end{array} \middle| \begin{array}{c} K \\ \tau+b \end{array} \right\} \end{aligned} \quad (230)$$

$$\begin{aligned} \mathcal{N}'^{(2)} \left(\begin{array}{c|c} \sigma' & s' \\ \lambda, \sigma & \ell, s \end{array} \right) &= \sum_{x \in \mathcal{S}} \frac{v_{\lambda+x}^{1/2}}{v_{\lambda+l}^{1/2} v_J^{1/2}} \left\{ \begin{array}{c|c} K & \lambda+a \\ \sigma & \sigma'+s' \end{array} \middle| \begin{array}{c} \lambda+x \\ \sigma' \end{array} \right\} \\ &\quad \left\{ \begin{array}{c|c} J & I \\ \lambda+a & \lambda+x \end{array} \middle| \begin{array}{c} K \\ \lambda+l \end{array} \right\} \left\{ \begin{array}{c|c} J & \sigma \\ \sigma'+s' & \lambda+l \end{array} \middle| \begin{array}{c} \sigma+s \\ \lambda+x \end{array} \right\} \end{aligned} \quad (231)$$

Proposition 32 *The following identity holds:*

$$\begin{aligned} K_{n,0}^{P(\pm)} \left(\begin{array}{c} \kappa; k \\ \lambda, \sigma, \tau; \ell, s, t \end{array} \right) &= \frac{[d_W]}{[d_\kappa]} \sum_{a,b,I'} K_{n,0}^{P(\pm)} \left(\begin{array}{c} \kappa; k \\ \lambda, \tau; \ell, a, b \end{array} \right) \\ &\quad II'_{n,0}^{(1)} \left(\begin{array}{c} \kappa; k \\ \lambda, \tau; \ell, t, a, b \end{array} \right) II'_{n,0}^{(2)} \left(\begin{array}{c} \kappa; k \\ \lambda, \sigma; \ell, s \end{array} \right) \end{aligned} \quad (232)$$

where we have defined the functions

$$G_{n,0}^{P(\pm)} \left(\begin{array}{c} \kappa; k \\ \lambda, \tau; \ell, a, b \end{array} \right) = \sum_c \prod_{i=1}^n \mathcal{K}^{P(i)}(\pm) \left(\begin{array}{c|c} \tau_{i+1} & b_{i+1}, c_{i+1} \\ \lambda_i, \tau_i & \ell_i, a_i, b_i, c_i \end{array} \right) \quad (233)$$

$$II'_{n,0}^{(1)} \left(\begin{array}{c} \kappa; k \\ \lambda, \tau; \ell, t, a, b \end{array} \right) = \prod_{i=1}^n \mathcal{N}'^{(1)} \left(\begin{array}{c|c} \tau_{i+1} & t_{i+1}, b_{i+1} \\ \lambda_i, \tau_i & \ell_i, t_i, a_i, b_i \end{array} \right) \quad (234)$$

$$II'_{n,0}^{(2)} \left(\begin{array}{c} \kappa; k \\ \lambda, \sigma; \ell, s \end{array} \right) = \prod_{i=1}^n \mathcal{N}'^{(2)} \left(\begin{array}{c|c} \sigma_{i+1} & s_{i+1} \\ \lambda_i, \sigma_i & \ell_i, s_i \end{array} \right). \quad (235)$$

In the sums, $a = (a_1, \dots, a_n) \in \mathcal{S}^n$, $b = (b_2, \dots, b_{n+1}) \in \mathcal{S}^n$, $c = (c_2, \dots, c_{n+1}) \in \mathcal{S}^{n-2}$ and we impose: $\tau_{n+1} = \sigma_{n+1} = \kappa$, $\tau_2 = \sigma_2 = \lambda_1$, $\tau_1 = \sigma_1 = (0, 0)$, $U_1 = T_1 = (0, 0)$, $U_2 = K_2$, $T_2 = L_2$, $I'_2 = I_1$ and $U_{n+1} = T_{n+1} = W$.

Proof: To prove this identity, we first prove it in the case where $\kappa, \lambda, \sigma, \tau \in \mathbb{S}_F^{3n-3}$. $K_{n,0}^{P(\pm)} \left(\begin{array}{c} \kappa; k \\ \lambda, \sigma, \tau; \ell, s, t \end{array} \right)$ is represented by the graph in figure 6. This graph is recasted in the graph shown in pictures 13,14 after having used topological moves and orthogonality relations: we have made a summation on all the coloring of the lines crossing a box. This graph clearly decomposes into three parts and each part shows an iterative structure whose generic elements are represented by the picture 15.

The value of each elementary graph is respectively $\mathcal{K}^{P(i)}(\pm) \left(\begin{array}{c|c} \tau_{i+1} & b_{i+1}, c_{i+1} \\ \lambda_i, \tau_i & \ell_i, a_i, b_i, c_i \end{array} \right)$, $\mathcal{N}'^{(i)}(1) \left(\begin{array}{c|c} \tau_{i+1} & t_{i+1}, b_{i+1} \\ \lambda_i, \tau_i & \ell_i, t_i, a_i, b_i \end{array} \right)$ and $\mathcal{N}'^{(i)}(2) \left(\begin{array}{c|c} \sigma_{i+1} & s_{i+1} \\ \lambda_i, \sigma_i & \ell_i, s_i \end{array} \right)$. It is easily expressed in

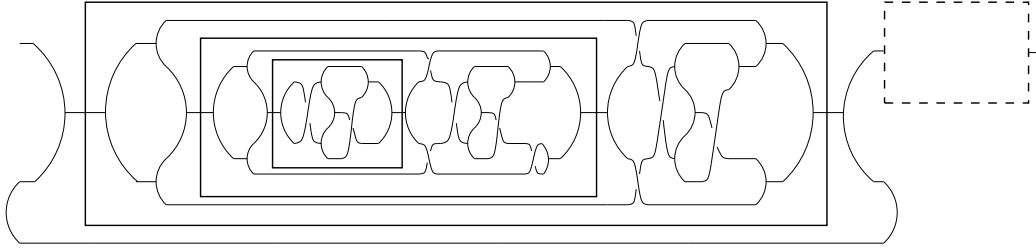

Figure 13: The first part of the decomposition.

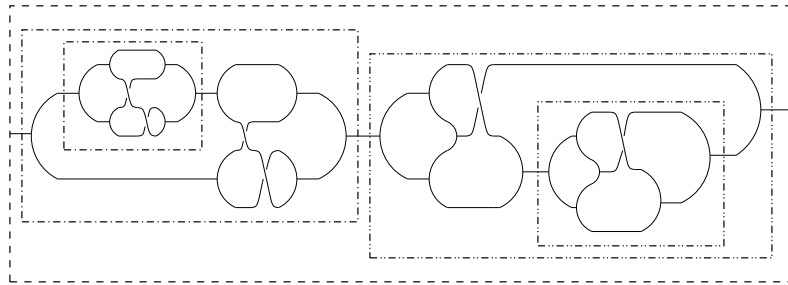

Figure 14: The second and third part of the decomposition. This picture represents the dashed box of the previous picture.

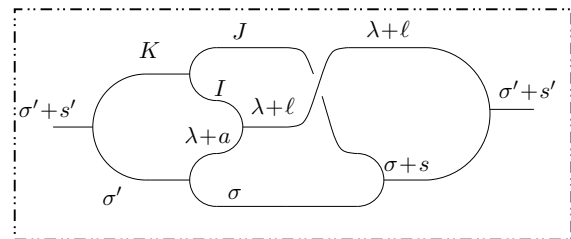
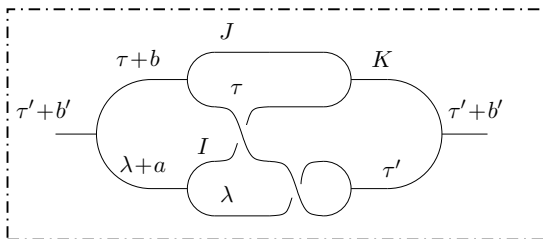
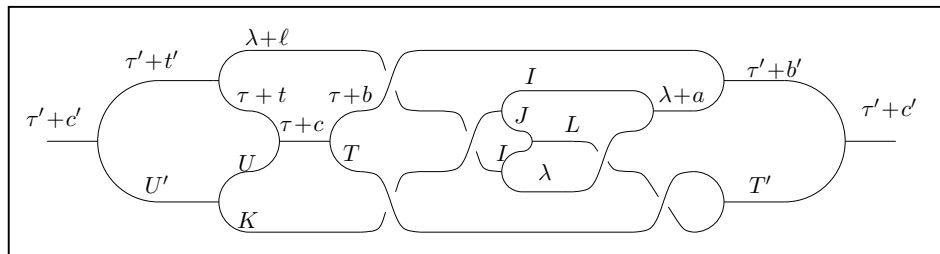

Figure 15: Elementary blocks in the genus n case.

terms of $6j$ coefficients which explains the definitions (229,230,231). The proof of the proposition when $\kappa, \lambda, \sigma, \tau \in \mathbb{S}^{n-3}$ is straightforward from the continuation argument. \square

Using the same argument and the same definitions as in the p -punctured case, the following factorisation property is also satisfied:

$$K_{n,0}^{P(\pm)} \left(\begin{array}{c} \kappa; k \\ \lambda, \sigma, \tau; \ell, s, t \end{array} \right) = K_{n,0}^{P_l(\pm)} \left(\begin{array}{c} \kappa^l; k^l \\ \lambda^l, \sigma^l, \tau^l; \ell^l, s^l, t^l \end{array} \right) K_{0,p}^{P_r(\pm)} \left(\begin{array}{c} \kappa^r; k^r \\ \lambda^r, \sigma^r, \tau^r; \ell^r, s^r, t^r \end{array} \right). \quad (236)$$

The proof of unitarity of the representation of the moduli algebra uses as central tools the following proposition.

Proposition 33 *The functions $K_{n,0}^{P(\pm)} \left(\begin{array}{c} \kappa, k \\ \lambda, \sigma, \tau; \ell, s, t \end{array} \right)$ satisfy the symmetries:*

1. $\overline{K_{n,0}^{P(\pm)} \left(\begin{array}{c} \kappa, k \\ \lambda, \sigma, \tau; \ell, s, t \end{array} \right)} = K_{n,0}^{P(\pm)} \left(\begin{array}{c} \bar{\kappa}, k \\ \bar{\lambda}, \bar{\sigma}, \bar{\tau}; \ell, s, t \end{array} \right)$
2. $K_{n,0}^{P(\pm)} \left(\begin{array}{c} \kappa, k \\ \lambda, \sigma, \tau; \ell, s, t \end{array} \right) = \frac{[d_\lambda]}{[d_{\lambda+\ell}]} \frac{[d_{\kappa+k}]}{[d_\kappa]} \tilde{K}_{n,0}^{\tilde{P}(\mp)} \left(\begin{array}{c} \tilde{\kappa} + \tilde{k}, -\tilde{k} \\ \tilde{\lambda} + \tilde{\ell}, \tilde{\sigma} + \tilde{s}, \tilde{\tau} + \tilde{t}; -\tilde{\ell}, -\tilde{s}, -\tilde{t} \end{array} \right)$
3. $K_{n,0}^{P(\pm)} \left(\begin{array}{c} \underline{\kappa}; -k \\ \underline{\lambda}, \underline{\sigma}, \underline{\tau}; -\ell, -s, -t \end{array} \right) = \psi_{n,0}[\kappa, \lambda, \sigma, \tau; k, \ell, s, t] K_{n,0}^{P(\pm)} \left(\begin{array}{c} \kappa; k \\ \lambda, \sigma, \tau; \ell, s, t \end{array} \right)$
with $\psi_{n,0}[\kappa, \lambda, \sigma, \tau; k, \ell, s, t] \in \{+1, -1\}$.

Proof: The proof of the first property is the same as the p -punctured case. The third property is also proved along similar lines. The only property which is drastically different from the p -puncture case is the second one. Indeed, contrary to the p -puncture case, it cannot be reduced to topological moves on graphs. To prove the second relation, we first use the standard continuation argument so that it is sufficient to show the same relation when $\kappa, \lambda, \sigma, \tau \in \mathbb{S}_F^{3n-3}$.

The idea of this proof is to decompose the previous graph in different units which satisfy the required property. We will perform it in the case $n = 2$. This proof can be generalised for an arbitrary genus n . Let $P = (I_1, I_2, J_1, J_2, K_1, K_2, L_1, L_2, W)$ the palette associated to the genus $n = 2$; we also introduce $S = (S_1, S_2) \in \mathbb{S}_F^2$ and $M \in \mathbb{S}_F$; finally we denote the quadruplet $PS(i) = (I_i, J_i, L_i, S_i)$, for $i \in \{1, 2\}$. Let us define new functions $\mathcal{E}^{S(i)}(\lambda_i; \ell_i)$, $\mathcal{C}^{P,S,M} \left(\begin{array}{c} \kappa; k \\ \lambda; \ell \end{array} \right)$ and $\mathcal{D}^{P,S,M(\pm)}$ respectively by the graphic expressions given in the figures 16, 17, 18.

Proposition 34 *The previous functions satisfy the properties:*

1. $\mathcal{E}^S(\lambda; \ell) = \mathcal{E}^{\tilde{S}}(\tilde{\lambda} + \tilde{\ell}; -\tilde{\ell})$ for any $S \in \mathbb{S}_F^4$, $\lambda \in \mathbb{S}$ and $\ell \in \mathcal{S}$
2. $\sum_M \mathcal{C}^{P,S,M} \left(\begin{array}{c} \kappa; k \\ \lambda; \ell \end{array} \right) \mathcal{D}^{P,S,M(\pm)} = \sum_M \tilde{\mathcal{C}}^{\tilde{P},\tilde{S},M} \left(\begin{array}{c} \tilde{\kappa} + \tilde{k}, -\tilde{k} \\ \tilde{\lambda} + \tilde{\ell}; -\tilde{\ell} \end{array} \right) \tilde{\mathcal{D}}^{\tilde{P},\tilde{S},M(\mp)}$
for any $P, S \in \mathbb{S}_F$, $\lambda \in \mathbb{S}^2$, $\kappa \in \mathbb{S}$, $\ell \in \mathcal{S}^2$ and $k \in \mathcal{S}$.

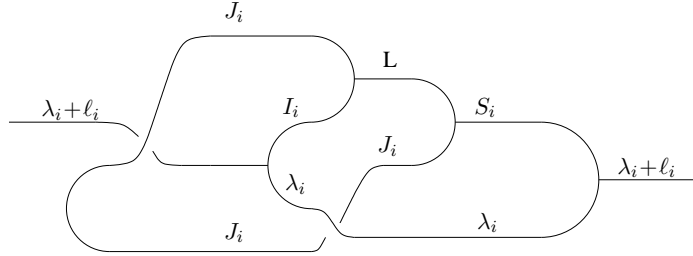

Figure 16: Definition of $\mathcal{E}^{S(i)}(\lambda_i, \ell_i)$.

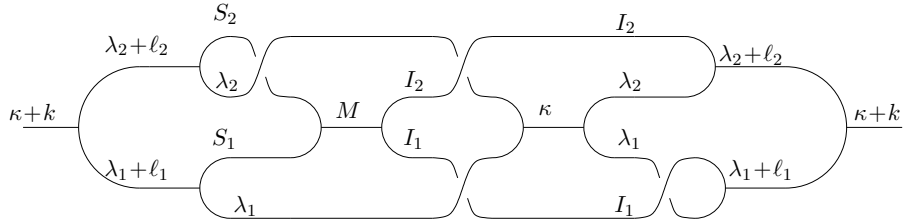

Figure 17: Definition of $\mathcal{C}^{P,S,M}$.

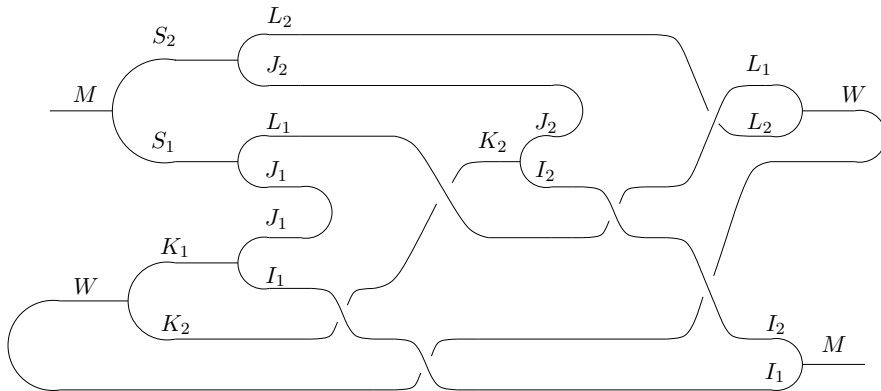

Figure 18: Definition of $\mathcal{D}^{P,S,M(+)}$. The expression of $\mathcal{D}^{P,S,M(-)}$ is obtained after having turned all overcrossing into undercrossing but not those which permute the representations (L_1, K_2) and (L_1, L_2) .

Proof: The first point is straightforward when we evaluate the explicit expression of the graph 16. Indeed, by a direct manipulation, we show that:

$$\mathcal{E}^{PS(j)}(\lambda_j; \ell_j) = \frac{v_{I_j}^{1/2}}{v_{S_j}^{1/2}} e^{i\pi(I_j - L_j)} \frac{[d_{L_j}]^{1/2}}{[d_{I_j}]^{1/2}} \Lambda_{I_j S_j}^{J_j L_j}(\lambda_j + \ell_j, \lambda_j) ,$$

where $\Lambda_{I_i S_i}^{J_i L_i}(\lambda_i + \ell_i, \lambda_i)$ have already been introduced in the appendix A.1. and satisfies the required property.

The second point is more technical and it is proved in two steps. On one hand, after moves on the graph 17, described in figure 20, we obtain the identity:

$$\begin{aligned} & \mathcal{C}^{P,S,M} \left(\begin{array}{c} \kappa; k \\ \lambda; \ell \end{array} \right) = \\ & \sum_N \frac{v_{I_2}^{1/2}}{v_{I_1}^{3/2} v_{S_2}^{1/2}} \frac{e^{i\pi(N-M)} [d_M]^{1/2}}{v_M^{1/4} v_N^{1/4} [d_N]^{1/2}} \Lambda_{MN}^{S_2 S_1}(I_1, I_2) \tilde{\mathcal{C}}^{P, \tilde{S}, \tilde{M}} \left(\begin{array}{c} \tilde{\kappa} + \tilde{k}; -\tilde{k} \\ \tilde{\lambda} + \tilde{\ell}; -\tilde{\ell} \end{array} \right) \frac{[d_{\lambda_1}][d_{\lambda_2}]}{[d_{\lambda_1 + \ell_1}][d_{\lambda_2 + \ell_2}]} \frac{[d_{\kappa+k}]}{[d_{\kappa}]} . \end{aligned}$$

On the other hand, we can evaluate the expression of $\mathcal{D}^{P,S,M(\pm)}$ in term of $6j$ coefficients

$$\begin{aligned} \mathcal{D}^{P,S,M(+)} &= \frac{v_{J_1}^{1/2} v_{J_2}^{1/2}}{v_{S_2}^{1/2} v_{L_1}^{1/2} v_{I_1}^{1/2} v_{K_2}^{1/2}} e^{i\pi(I_1 + I_2 - K_1 - K_2)} \frac{[d_{K_1}]^{1/2} [d_{K_2}]^{1/2}}{[d_{I_1}]^{1/2} [d_{I_2}]^{1/2}} \\ & \sum_X \left\{ \begin{array}{c} L_1 \ J_1 \\ X \ L_2 \end{array} \middle| \begin{array}{c} S_1 \\ W \end{array} \right\} \left\{ \begin{array}{c} M \ S_1 \\ L_2 \ J_2 \end{array} \middle| \begin{array}{c} S_2 \\ X \end{array} \right\} \left\{ \begin{array}{c} K_2 \ K_1 \\ J_1 \ X \end{array} \middle| \begin{array}{c} W \\ I_1 \end{array} \right\} \left\{ \begin{array}{c} I_1 \ K_2 \\ J_2 \ M \end{array} \middle| \begin{array}{c} X \\ I_2 \end{array} \right\} \end{aligned} \quad (237)$$

$$\begin{aligned} \mathcal{D}^{P,S,M(-)} &= \frac{v_{K_1} v_{I_1}^{1/2} v_{S_2}^{1/2} v_{K_2}^{1/2}}{v_{L_1}^{1/2} v_{J_2}^{1/2} v_{J_1}^{1/2}} e^{i\pi(I_1 + J_2 + M - K_2 - 2W)} \frac{[d_W][d_{K_2}]^{1/2}}{[d_{I_1}]^{1/2} [d_{J_2}]^{1/2} [d_M]^{1/2}} \\ & \sum_X \left\{ \begin{array}{c} L_1 \ W \\ K_2 \ X \end{array} \middle| \begin{array}{c} L_2 \\ K_1 \end{array} \right\} \left\{ \begin{array}{c} J_1 \ K_1 \\ X \ S_1 \end{array} \middle| \begin{array}{c} I_1 \\ L_1 \end{array} \right\} \left\{ \begin{array}{c} I_2 \ I_1 \\ S_1 \ S_2 \end{array} \middle| \begin{array}{c} M \\ X \end{array} \right\} \left\{ \begin{array}{c} I_2 \ S_2 \\ L_2 \ K_2 \end{array} \middle| \begin{array}{c} X \\ J_2 \end{array} \right\} \end{aligned} \quad (238)$$

and we can easily show that:

$$\sum_M \mathcal{D}^{P,S,M(\pm)} \frac{v_{I_2}^{1/2}}{v_{I_1}^{1/2}} \frac{e^{i\pi(N-M)} [d_M]^{1/2}}{v_M^{1/4} v_N^{1/4} [d_N]^{1/2}} \Lambda_{MN}^{S_2 S_1}(I_1, I_2) = \tilde{\mathcal{D}}^{P, \tilde{S}, N(\mp)} . \quad (239)$$

As a consequence, the second relation holds. \square

We are now ready to perform the proof of the second symmetry relation of the proposition 33. The graphical expression of $K_{2,0}^{P(\pm)} \left(\begin{array}{c} \kappa, k \\ \lambda; \ell \end{array} \right)$ is obtained directly from the picture 6. After some trivial topological moves, we introduce orthogonality relations and we show that (figure 19):

$$K_{2,0}^{P(\pm)} \left(\begin{array}{c} \kappa, k \\ \lambda; \ell \end{array} \right) = \sum_{S_1, S_2, M} \mathcal{E}^{PS(1)}(\lambda_1, \ell_1) \mathcal{E}^{PS(2)}(\lambda_2, \ell_2) \mathcal{C}^{P,S,M} \left(\begin{array}{c} \kappa, k \\ \lambda; \ell \end{array} \right) \mathcal{D}^{P,S,M(\pm)} . \quad (240)$$

Finally, the symmetry relation is a direct consequence of the proposition 34. The structure of the proof is similar for the general case $n > 2$. \square

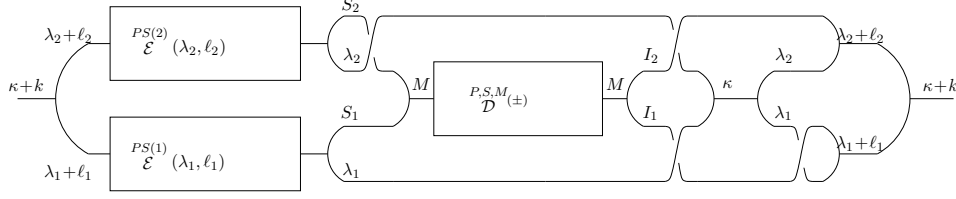

Figure 19: Decomposition of $K_{2,0}^{P(\pm)}$.

B.1 The p-punctured genus-n surface

In this appendix, we will give the technical details concerning the proof of unitarity in the case of a p-punctured genus-n surface. In the following, we will extensively study the one puncture torus and we will give the properties for the general case without giving the cumbersome proves.

The function $K_{1,1}^{P(\pm)} \left(\begin{array}{c} \alpha \\ \lambda; \ell \end{array} \right)$, defined by the graph (7), satisfy the following symmetries:

1. $\overline{K_{1,1}^{P(\pm)} \left(\begin{array}{c} \alpha \\ \lambda; \ell \end{array} \right)} = K_{1,1}^{P(\pm)} \left(\begin{array}{c} \bar{\alpha} \\ \bar{\lambda}; \ell \end{array} \right)$
2. $K_{1,1}^{P(\pm)} \left(\begin{array}{c} \alpha \\ \lambda; \ell \end{array} \right) = \tilde{K}_{1,1}^{\tilde{P}(\mp)} \left(\begin{array}{c} \tilde{\alpha} \\ \tilde{\lambda} + \tilde{\ell}; -\tilde{\ell} \end{array} \right)$
3. $K_{1,1}^{P(\pm)} \left(\begin{array}{c} \underline{\alpha} \\ \underline{\lambda}; -\ell \end{array} \right) = \psi_{1,1}(\alpha, \lambda, \ell) K_{1,1}^{P(\pm)} \left(\begin{array}{c} \alpha \\ \lambda; \ell \end{array} \right)$,
with $\psi_{1,1}(\alpha, \lambda, \ell) \in \{+1, -1\}$.

The first and the third properties are proved in the same spirit as in the previous cases. The proof of the second property cannot be reduced to topological moves on graphs. This property is proved along similar lines as we proved the genus 2 case.

After topological moves, we decompose the graph in different units, by using orthogonality relations, as follows (figure 21):

$$K_{1,1}^{P(\pm)} \left(\begin{array}{c} \alpha \\ \lambda; \ell \end{array} \right) = \sum_{S,M \in \mathbb{S}_F} \mathcal{E}^{PS}(\lambda; \ell) \mathcal{C}^{P,S,M} \left(\begin{array}{c} \alpha \\ \lambda; \ell \end{array} \right) \mathcal{D}^{P,S,M(\pm)} \quad (241)$$

where $P = (I, J, N, K, L, W) \in \mathbb{S}_F^6$ is the palette and $PS = (I, J, L, S) \in \mathbb{S}_F^4$. We show that these functions satisfies the similar properties as in the proposition 34. As a result, $K_{1,1}^{P(\pm)} \left(\begin{array}{c} \alpha \\ \lambda; \ell \end{array} \right)$ satisfy the required symmetry relation. This closes the proof of unitarity for the one-punctured torus.

For the general case, the function $K_{n,p}^{P(\pm)} \left(\begin{array}{c} \alpha \\ \beta, \lambda, \sigma, \tau, \delta; b, \ell, s, t, d \end{array} \right)$ is obtained from the graph in figure 22 where we can notice an obvious iterative structure.

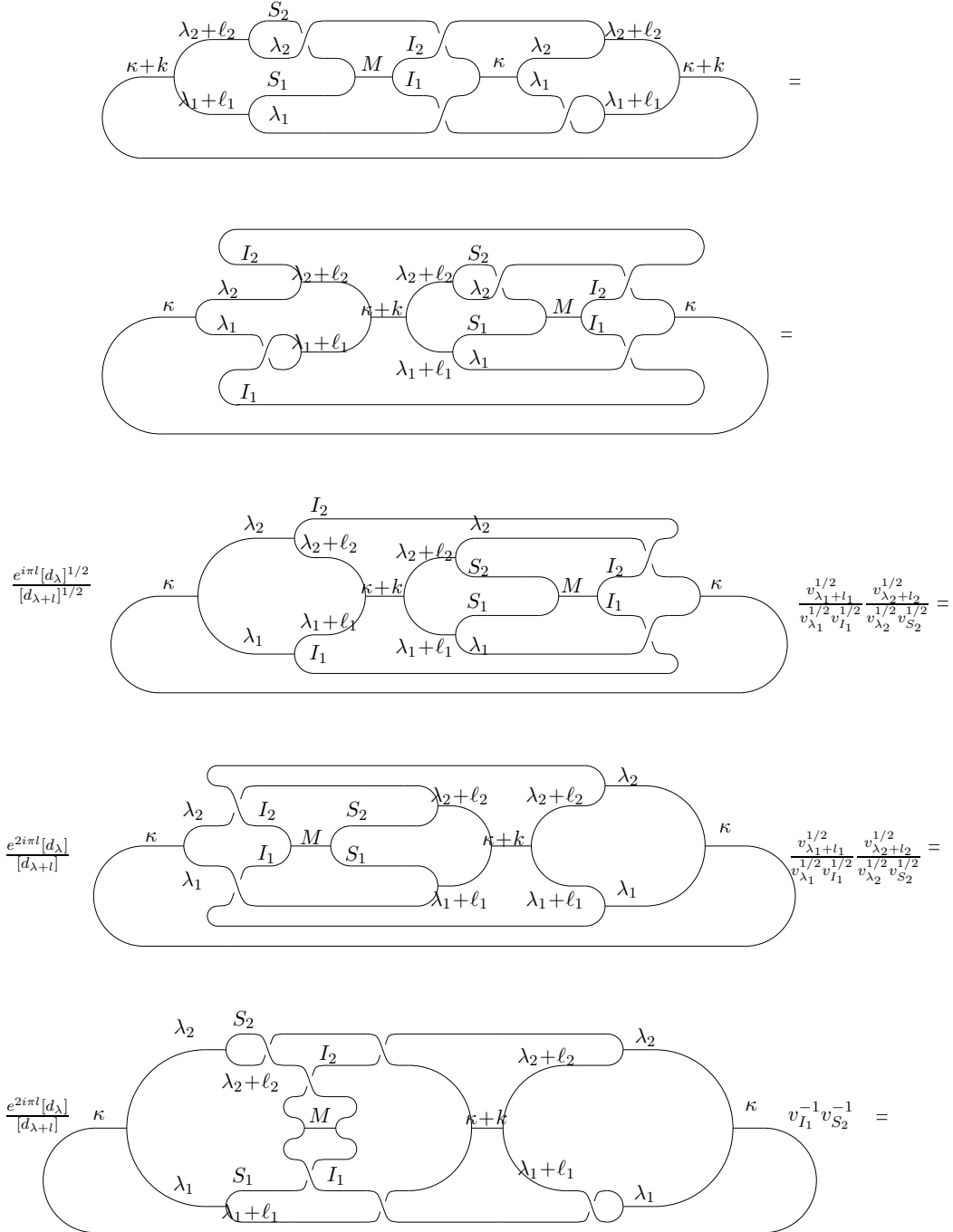

Figure 20: This sequence of graphs shows the main lines of proof of the symmetry relation 237. All the representations are supposed to be finite. To obtain the final result, we have to introduce two orthogonality relations between (I_1, I_2) and (S_1, S_2) in the last picture. The obtained graph decomposes in a graph similar to the first one and a residual graph whose value is given in 237.

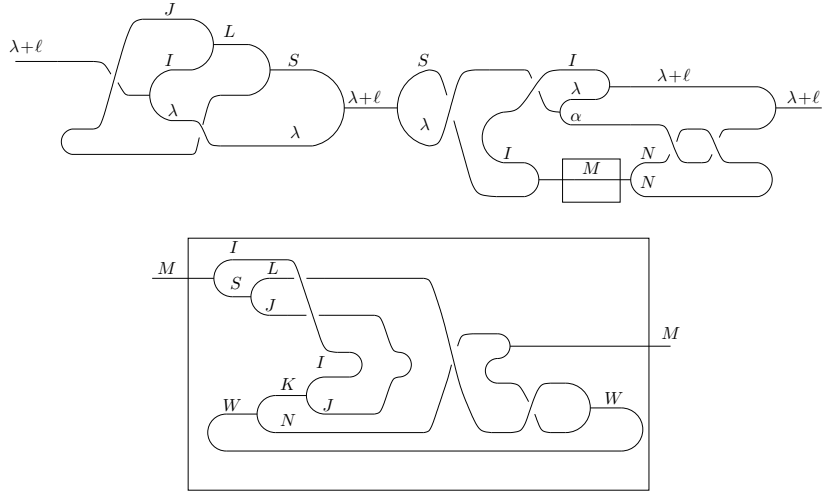

Figure 21: Expression of $K_{1,1}^{P(+)}$ after topological moves and introducing orthogonality relations. The first unit on the top is $\mathcal{E}^{PS}(\lambda; \ell)$; the second on the top is $\mathcal{C}^{P,S,M}$; the last one on the box is $\mathcal{D}^{P,S,M(+)}$.

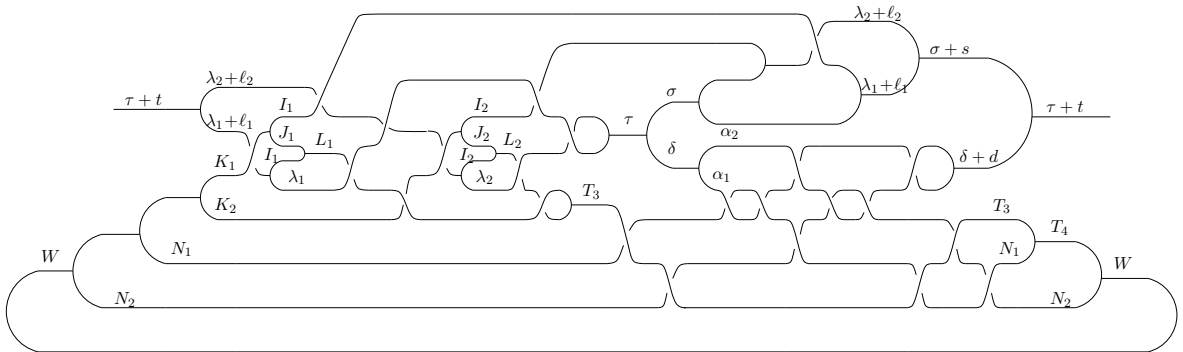

Figure 22: Expression of $K_{2,2}^{P(+)}$.

This function satisfy the usual symmetry relations which are central to prove unitarity of the moduli algebra:

Proposition 35 *The function $K_{n,p}^{P(\pm)} \left(\begin{array}{c} \alpha \\ \beta, \lambda, \sigma, \tau, \delta; b, \ell, s, t, d \end{array} \right)$ satisfy the relations:*

1.
$$\overline{K_{n,p}^{P(\pm)} \left(\begin{array}{c} \alpha \\ \beta, \lambda, \sigma, \tau, \delta; b, \ell, s, t, d \end{array} \right)} = K_{n,p}^{P(\pm)} \left(\begin{array}{c} \bar{\alpha} \\ \bar{\beta}, \bar{\lambda}, \bar{\sigma}, \bar{\tau}, \bar{\delta}; b, \ell, s, t, d \end{array} \right)$$
2.
$$K_{n,p}^{P(\pm)} \left(\begin{array}{c} \alpha \\ \beta, \lambda, \sigma, \tau, \delta; b, \ell, s, t, d \end{array} \right) = \frac{[d\lambda]}{[d\lambda+\ell]} \frac{[d\tau_{n+1}+t_{n+1}]}{[d\tau_{n+1}]} \\ \times \tilde{K}_{n,p}^{\tilde{P}(\mp)} \left(\begin{array}{c} \tilde{\alpha} \\ \tilde{\beta} + \tilde{b}, \tilde{\lambda} + \tilde{\ell}, \tilde{\sigma} + \tilde{s}, \tilde{\tau} + \tilde{t}, \tilde{\delta} + \tilde{d}; -\tilde{b}, -\tilde{\ell}, -\tilde{s}, -\tilde{t}, -\tilde{d} \end{array} \right)$$
3.
$$K_{n,p}^{P(\pm)} \left(\begin{array}{c} \underline{\alpha} \\ \underline{\beta}, \underline{\lambda}, \underline{\sigma}, \underline{\tau}, \underline{\delta}; -b, -\ell, -s, -t, -d \end{array} \right) = \psi_{n,p}(\alpha, \beta, \lambda, \sigma, \tau, \delta, b, \ell, s, t, d) \\ \times K_{n,p}^{P(\pm)} \left(\begin{array}{c} \alpha \\ \beta, \lambda, \sigma, \tau, \delta; b, \ell, s, t, d \end{array} \right), \text{ with } \psi_{n,p}(\alpha, \beta, \lambda, \sigma, \tau, \delta, b, \ell, s, t, d) \in \{+1, -1\}.$$

This proposition is proved along the same lines as the corresponding proposition for the genus-n case. \square

References

- [1] A.Achucarro, P.K.Townsend, "A Chern-Simons action for three dimensional anti de Sitter supergravity theories," Phys.Lett. B 180, 89-92, (1986).
- [2] A.Yu.Alekseev, H.Grosse, V.Schomerus, "Combinatorial Quantization of the Hamiltonian Chern-Simons theory I," Commun.Math.Phys.172:317-358, (1995)hep-th/9403066
- [3] A.Yu.Alekseev, H.Grosse, V.Schomerus, "Combinatorial Quantization of the Hamiltonian Chern-Simons theory II," Commun.Math.Phys.174:561-604, (1995) hep-th/9408097
- [4] A.Yu.Alekseev, V.Schomerus, Representation theory of Chern-Simons Observables, q-alg/9503016
- [5] A.Yu.Alekseev, Integrability in the Hamiltonian Chern-Simons Theory, st.Petersburg.Math.J, Vol.6 (1995),No.2, hep-th/9311074
- [6] A.Yu.Alekseev, A.Z.Malkin Symplectic Structure of the moduli space of flat connections on a Riemann Surface, Comm.Math.Phys,166:99-120,(1995) hep-th/9312004
- [7] A.Ashtekar, J.Lewandowski, D.Marolf, J.Mourao, T.Thiemann, Quantization of diffeomorphism invariant theories of connections with local degrees of freedom, J.Math.Physics, bf 36 6456 (1995) ; gr-qc/9504018

- [8] M.Atiyah, *The Geometry and Physics of Knots*, Cambridge University Press 1990
- [9] V.Balasubramanian, J. de Boer, D. Minic, “Mass, Entropy and Holography in Asymptotically de Sitter Spaces,” hep-th/0110108
- [10] E.Buffenoir, Ph.Roche, “Two dimensional lattice gauge theory based on a quantum group,” *Commun.Math.Phys.* 170 (1995) 669-698.hep-th/9405126
- [11] E.Buffenoir, Ph.Roche, “Link invariants and combinatorial quantization of hamiltonian Chern-Simons theory,” *Commun.Math.Phys.*181:331-365,1996.q-alg/9507001
- [12] E.Buffenoir, Ph.Roche, “Harmonic Analysis on the quantum Lorentz Group,” *Comm.Math.Phys*,**207**, 499-555, (1999)
- [13] E.Buffenoir, Ph.Roche, “Harmonic Analysis on the quantum Lorentz Group,” preprint q-alg/9710022.
- [14] E.Buffenoir, Ph.Roche, “Tensor Product of Principal Unitary Representations of Quantum Lorentz group and Askey-Wilson polynomials”, *J.Math.Phys.*41:7715-7751,2000 math.qa/9910147
- [15] S.Carlip, “Quantum Gravity in 2+1 dimensions”, Cambridge Monographs on Mathematical Physics (1998).
- [16] V.Chari, A.Presley *A Guide to Quantum groups*, Cambridge University Press, (1995).
- [17] K. Ezawa “Classical and quantum evolution of the de Sitter and the anti-de Sitter universes in (2+1)-dimensions”, *Phys.Rev. D*49 (1994) 5211-5226
- [18] V.V.Fock, A.A.Rosly, “Poisson structure on moduli of flat connections on Riemann surfaces and r -matrix”, math.QA/9802054
- [19] W.Goldman *The symplectic nature of fundamental groups of surfaces* *Adv.Math.* 54, 200-225 (1984)
- [20] H-J.Matschull, “On the relation between 2+1 Einstein gravity and Chern Simons theory”, *Class.Quant.Grav.* 16 (1999) 2599-2609 gr-qc/9903040
- [21] J.E.Nelson, T.Regge, “Homotopy groups and 2+1 quantum gravity,” *Nucl.Phys.* B328, 190-202
- [22] J.E.Nelson, T.Regge, “Quantisation of 2+1 gravity for genus 2,” *Phys.Rev. D*50 (1994) 5125-5129gr-qc/9311029
- [23] M.I. Park, “Statistical entropy of Three-dimensional Kerr-De Sitter Space,” *Phys.Let. B*440 (1998) 275hep-th/9806119
- [24] P.Podles, S.L.Woronowicz, “Quantum deformation of the Lorentz Group,” *Comm.Math.Phys*, **130**, 381-431, (1990).

- [25] W.Pusz, “Irreducible unitary representations of quantum Lorentz group,” *Comm.math.Phys*, **152**, 591-626 (1993).
- [26] V. Turaev, *Algebras of loops on surfaces, algebras of knots, and quantization*. Braid group, knot theory and statistical mechanics, II, 324–360, *Adv. Ser. Math. Phys.*, 17, World Sci. Publishing, River Edge, NJ, 1994.
- [27] A.Van Daele, Multiplier Hopf algebras, *Trans.American.Math.Society*, **342** vol 2, 917-932 (1994)
- [28] E.Witten, “2+1 dimensional gravity as an exactly soluble system,” *Nucl.Phys.B*.311,46-78 (1988)
- [29] E.Witten, “Quantization of Chern-Simons gauge theory with complex gauge group,” *Comm.Math.Phys.* 137, 29-66 (1991)