

The Structure of Electroweak Corrections Due to Extended Gauge Symmetries

R. Sekhar Chivukula^{1*}, Hong-Jian He²,
Joseph Howard¹, and Elizabeth H. Simmons^{1*†}

¹ Physics Department, Boston University
590 Commonwealth Ave., Boston, MA 02215 USA

² Center for Particle Physics and Department of Physics
University of Texas at Austin, Austin, TX 78712, USA

October 30, 2018

Abstract

This paper studies models with extended electroweak gauge sectors of the form $SU(2) \times SU(2) \times U(1) \times [SU(2) \text{ or } U(1)]$. We establish the general behavior of corrections to precision electroweak observables in this class of theories and connect our results to previous work on specific models whose electroweak sectors are special cases of our extended group.

*Address after 8-16-03: Department of Physics and Astronomy, Biomedical Physical Sciences Building, East Lansing, MI, 48825-2320

†e-mail addresses: sekhar@msu.edu, hjhe@physics.utexas.edu, howard@bu.edu, esimmons@msu.edu

1 Introduction

Understanding the dynamics of mass generation requires looking beyond the standard model of particle physics. Models with extended electroweak gauge sectors play a large role in recent work on the origins of electroweak symmetry breaking, the large top quark mass and the top-bottom mass splitting [1, 2]. Some theories include an extended $SU(2) \times SU(2)$ structure for the weak interactions; the fermions may transform under the groups in a variety of flavor non-universal ways. Examples include non-commuting extended technicolor (NCETC) [3, 4], topflavor [5, 6, 7], and the ununified standard model (UUM) [8, 9] and related theories [10]. Other theories include an extended $U(1) \times U(1)$ structure. Examples include topcolor-assisted technicolor [11, 12], flavor-universal topcolor-assisted-technicolor [13, 14], topflavor-seesaw [7], and string theories [15] or string-inspired models [16].

This paper studies the phenomenology of models with replicated electroweak gauge symmetries, based on a framework with the gauge structure $SU(2) \times SU(2) \times U(1) \times [SU(2) \text{ or } U(1)]$. We discuss flavor-universal theories of this type in detail and show how to extend our results in a straightforward manner to flavor non-universal theories.

We begin, in section 2, by establishing the conventions we shall use and demonstrate that many specific models discussed in the literature are special cases of our general framework. In section 3, we examine the corrections the extended gauge sector causes in the low-energy current-current interactions of both the charged and neutral gauge sectors. We find that the form of the corrections depends neatly on the charge assignments of the fermions under the extended electroweak group. In section 4, we perform a similar analysis of the masses and couplings of the W and Z bosons in our general framework. Again, the fermion transformation properties dictate the form of the leading corrections to the Zff and Wff couplings. In section 5, we perform a global fit of precision electroweak data to the theories in which the leading predicted corrections to observables are smallest. We discuss our conclusions and their application to other models in the literature in section 6.

2 Replicated Electroweak Gauge Symmetries

The general framework [17] for the models we will discuss is based on the gauge structure $SU(2) \times SU(2) \times U(1) \times [SU(2) \text{ or } U(1)]$, and is illustrated in the figure below. This figure employs the conventions of “moose” notation

[18],

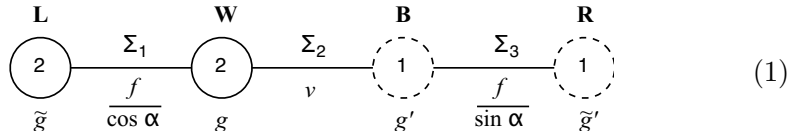

in which the circles represent gauge groups with the specified gauge coupling, and the solid lines represent separate $(SU(2) \times SU(2)/SU(2))$ nonlinear sigma model fields which break the gauged or global symmetries to which they are attached. Each solid circle represents an $SU(2)$ or $U(1)$ group for which the entire global symmetry has been gauged; the dotted circle represents a global $SU(2)$ in which only a $U(1)$ subgroup has been gauged.

For convenience, the coupling constants of the gauge theories will be specified by

$$\tilde{g}' = \frac{e}{\cos \theta \sin \phi}, \quad g' = \frac{e}{\cos \theta \cos \phi}, \quad g = \frac{e}{\sin \theta \cos \omega}, \quad \tilde{g} = \frac{e}{\sin \theta \sin \omega}, \tag{2}$$

and the f -constants (the analogs of f_π in QCD) of the nonlinear sigma models by

$$\frac{f}{\sin \alpha}, \quad v, \quad \frac{f}{\cos \alpha}. \tag{3}$$

The nonlinear sigma fields will break the extended gauge group first (at scale f) to an intermediate electroweak group $SU(2) \times U(1)$ and then (at scale v) to the unbroken electromagnetic group $U(1)_{EM}$. Hence the low-energy spectrum of the theory includes a massless photon, a set of W and Z bosons which closely resemble those of the standard model, and an extra set of heavy W and Z bosons corresponding to the generators broken at scale f .

As we will see, the Lagrangian parameters e , θ , and v , will be approximately equal to the electric charge, weak mixing angle, and Higgs expectation value in the one-doublet standard model. The scale f sets the masses of the extra gauge bosons, and the theory reduces to the standard model in the limit $f \rightarrow \infty$. The angle α allows us to independently vary the breaking scale of the duplicated $SU(2)$ or $U(1)$ gauge symmetries. The angles ϕ and ω determine the couplings of the gauge bosons which become massive at scale f . This analysis will assume that the ratio $\frac{v}{f} \ll 1$ since precision electroweak data already tells us that the observed W and Z bosons closely resemble those of the standard model.

The symmetry structure of this model is similar to that proposed in the BESS (*Breaking Electroweak Symmetry Strongly*) model [19, 20], an effective

Lagrangian description motivated by strong electroweak symmetry breaking. The BESS model is in turn an application of “hidden local symmetry” to electroweak physics [21]. Accordingly, we refer to our paradigm as “Generalized BESS” (GBESS). The symmetry structure in the limit $f \rightarrow \infty$ is precisely that expected in a “technicolor” model [22, 23], and the theory has a custodial symmetry in the limit where g' and \tilde{g}' go to zero.

GBESS is the simplest model of an extended electroweak gauge symmetry incorporating both replicated $SU(2)$ and $U(1)$ gauge groups. As such the electroweak sector of a number of models in the literature can be thought of as forming special cases of GBESS. For example *Noncommuting Extended Technicolor* (NCETC) [3, 4], can be framed in the moose notation as follows:

$$\begin{array}{c}
 \begin{array}{ccccc}
 \textcircled{2} & \xrightarrow{f} & \textcircled{2} & \xrightarrow{v} & \textcircled{1} \\
 \text{\scriptsize } SU(2)_2 & \times & \text{\scriptsize } SU(2)_1 & \times & \text{\scriptsize } U(1)_Y \\
 / & & \backslash & & \\
 \text{"Light Fermions"} & \longleftrightarrow & \text{"Heavy Fermions"} & &
 \end{array} \\
 \end{array} \tag{4}$$

where the gauge groups correspond, from left to right, to the $SU(2)_2 \times SU(2)_1 \times U(1)$ electroweak structure of the model. In the “heavy” case of NCETC, the fermions transforming under $SU(2)_2$ are those of the first and second generations as shown, while the third generation transform under $SU(2)_1$; in the “light” case, the fermion assignments are reversed (per the double-headed arrow). The electroweak gauge structure of the Ununified Standard Model [8, 9] is the same,

$$\begin{array}{c}
 \begin{array}{ccccc}
 \textcircled{2} & \xrightarrow{f} & \textcircled{2} & \xrightarrow{v} & \textcircled{1} \\
 \text{\scriptsize } SU(2)_q & \times & \text{\scriptsize } SU(2)_l & \times & \text{\scriptsize } U(1)_Y \\
 / & & \backslash & & \\
 \text{Quarks} & & \text{Leptons} & &
 \end{array} \\
 \end{array} \tag{5}$$

but it is the quarks and leptons which now transform under separate $SU(2)$ groups, reflecting the distinct weak interactions of these species in this model. As another example, the electroweak structure of *topcolor* [11, 12], has the form

$$\begin{array}{c}
 \begin{array}{ccccc}
 \textcircled{2} & \xrightarrow{v} & \textcircled{1} & \xrightarrow{f} & \textcircled{1} \\
 \text{\scriptsize } SU(2)_w & \times & \text{\scriptsize } U(1)_1 & \times & \text{\scriptsize } U(1)_2 \\
 & & / & & \backslash \\
 \text{"Light Fermions"} & & & & \text{"Heavy Fermions"}
 \end{array} \\
 \end{array} \tag{6}$$

which illustrates the separate hypercharge interactions of the 3rd generation and light fermions.

Finally, *electroweak* $SU(3)$ [24, 25, 26] has the gauge structure $SU(3) \times SU(2) \times U(1)$ which can be represented as follows

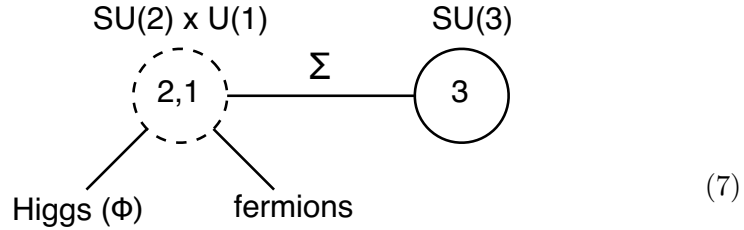

where the dashed circle reflects the fact that the gauged $SU(2) \times U(1)$ is a subgroup of a global $SU(3)$ group. Note that all fermions and the conventional Higgs field (ϕ) are charged under this $SU(2) \times U(1)$. The Σ transforms as a $(2,3)_{-\frac{1}{2}}$ of the gauge symmetries. If we focus on the $SU(2) \times U(1)$ subgroup of the $SU(3)$ gauge group which is preserved by the $SU(3) \times SU(3)/SU(3)$ chiral symmetry breaking structure, this model can be redrawn.

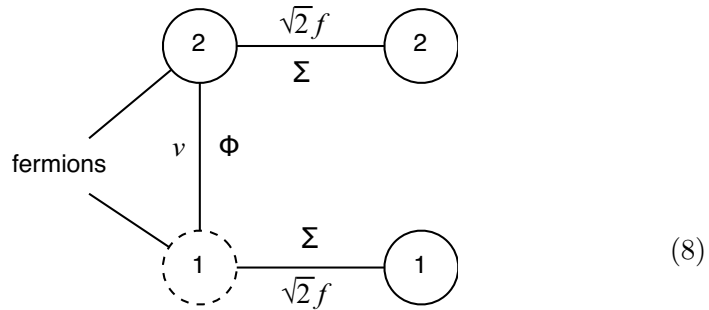

This unfolds to reveal the linear moose form of GBESS once more, with the coupling values shown below

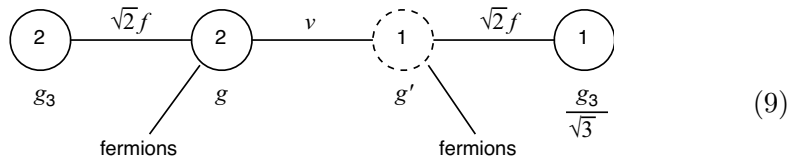

and with the standard model fermions transforming under the inner two groups. Note that for $g, g' \gg g_3$ one finds $\sin^2(\theta_W) \approx \frac{1}{4}$. The general properties of precision electroweak constraints on these models[4, 27, 28] can correspondingly be viewed as special cases of what follows, as we will discuss below.

3 Low-Energy Interactions

Important constraints on models with extended electroweak symmetries arise from low-energy measurements, of which the most sensitive are the muon lifetime (used to determine G_F), atomic parity violation (APV), and neutrino-nucleon scattering. In the usual fashion, we may summarize the low-energy interactions in terms of four-fermion operators. The form of these interactions will depend, however, on the fermion charge assignments. For simplicity, we focus on models in which the fermion charge assignments are flavor universal. To illustrate the model-dependence of the results, we consider two examples.

First, we consider the case (hereafter, Case I) in which the ordinary fermions are charged only under the two groups at the middle of the moose

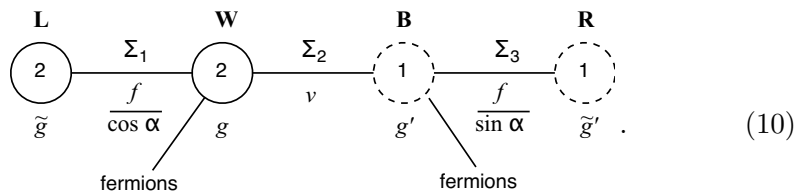

In this case the charged current interactions may be computed to be

$$L^{CC} = -\frac{2}{v^2} J^{\mu+} J_{\mu}^{-}, \quad (11)$$

and the neutral current interactions to be

$$L^{NC} = -\frac{2}{v^2} (J_3^{\mu} - Q^{\mu} \sin^2 \theta)^2 - \frac{2}{f^2} (\cos^2 \alpha \sin^4 \theta \sin^4 \omega + \sin^2 \alpha \cos^4 \theta \sin^4 \phi) Q^{\mu} Q_{\mu}. \quad (12)$$

In these expressions, the currents $J_{\pm,3}^{\mu}$ and Q^{μ} are the conventional weak and electromagnetic currents. From these, we see that the strength of G_F , APV, and neutrino scattering is determined by v in the usual way. Furthermore, comparing the two equations, we see that the strength of the charged and neutral current interactions, the so-called low-energy ρ parameter, is precisely one (at tree-level). This last fact is a direct consequence of the Georgi-Weinberg neutral current theorem [29].

As an alternative, consider the case (hereafter, Case II) in which the $SU(2)$ charges of the ordinary fermions arise from transforming under the

charged currents of Case III (Case IV) are identical to those of Case I (Case II). The low-energy neutral currents may be written in the general form:

$$L^{NC} = -\frac{2}{v^2}(J_3^\mu - Q^\mu \sin^2 \theta)^2 - \frac{2 \cos^2 \alpha}{f^2} (t_3 J_3^\mu - t_Q Q^\mu)^2 - \frac{2 \sin^2 \alpha}{f^2} (u_3 J_3^\mu - u_Q Q^\mu)^2 \quad (16)$$

where the coefficients t_3 , t_Q , u_3 , u_Q are summarized in Table 1. Note that in Cases III and IV the strengths of the $J_3 J_3$ and $J^+ J^-$ portions of the interactions are no longer equal.

Case	t_3	t_Q	u_3	u_Q
I (W, B)	0	$s_\theta^2 s_\omega^2$	0	$c_\theta^2 s_\phi^2$
II (L, B)	1	$s_\theta^2 s_\omega^2$	0	$c_\theta^2 s_\phi^2$
III (W, R)	0	$s_\theta^2 s_\omega^2$	1	$1 - c_\theta^2 s_\phi^2$
IV (L, R)	1	$s_\theta^2 s_\omega^2$	1	$1 - c_\theta^2 s_\phi^2$

Table 1: Coefficients of the order v^2/f^2 corrections to low-energy neutral currents (per equation 16) in Cases I-IV. For each Case we note the gauge groups ($SU(2)_{L \text{ or } W}$, $U(1)_{B \text{ or } R}$) under which the fermions are charged. For brevity, we abbreviate $\cos^2 \alpha$ as c_α^2 , and $\sin^2 \alpha$ as s_α^2 , and so forth.

4 Z-Pole Constraints - General Structure

Many of the most significant constraints on physics beyond the standard model arise from precise measurements at the Z-pole. To interpret these measurements, we must compute the masses of the light W and Z bosons (which are the same in Cases I-IV) and their shifted couplings to ordinary fermions in terms of the Lagrangian parameters.

The charged weak bosons of the $SU(2)_L$ and $SU(2)_W$ groups of GBESS mix with one another¹. Diagonalizing the mass-squared matrix

$$\frac{e^2}{4 \sin^2 \theta} \frac{f^2}{\cos^2 \alpha \sin^2 \omega} \begin{pmatrix} 1 & -\tan \omega \\ -\tan \omega & \tan^2 \omega \left[1 + \frac{v^2 \cos^2 \alpha}{f^2} \right] \end{pmatrix} \quad (17)$$

¹If one were to gauge the full global $SU(2)_R$ of GBESS, the charged weak bosons of group R would not mix with those of groups L and W and would simply have masses $M_{R^\pm}^2 = \frac{e^2 f^2}{4 \cos^2 \theta} \left(\frac{1}{\sin^2 \alpha \sin^2 \phi} \right)$.

for the charged L and W bosons yields masses for the light W

$$M_W^2 = \frac{e^2 v^2}{4 \sin^2 \theta} \left(1 - \cos^2 \alpha \sin^4 \omega \frac{v^2}{f^2} \right) + O\left(\frac{v^4}{f^4}\right), \quad (18)$$

and its heavy counterpart (at leading order)

$$M_{L^\pm}^2 = \frac{e^2 f^2}{4 \sin^2 \theta} \left(\frac{1}{\cos^2 \alpha \sin^2 \omega \cos^2 \omega} \right) \quad (19)$$

All four neutral bosons in GBESS mix with one another. Diagonalizing the mass-squared matrix (from which an overall factor of $[e^2 f^2 / 4 \cos^2 \theta \sin^2 \theta]$ has been removed)

$$\begin{pmatrix} \frac{\cos^2 \theta}{\cos^2 \alpha \sin^2 \omega} & -\frac{\cos^2 \theta}{\cos^2 \alpha \sin \omega \cos \omega} & 0 & 0 \\ -\frac{\cos^2 \theta}{\cos^2 \alpha \sin \omega \cos \omega} & \frac{\cos^2 \theta}{\cos^2 \omega} \left[\frac{v^2}{f^2} + \frac{1}{\cos^2 \alpha} \right] & -\frac{v^2 \cos \theta \sin \theta}{f^2 \cos \omega \cos \phi} & 0 \\ 0 & -\frac{v^2 \cos \theta \sin \theta}{f^2 \cos \omega \cos \phi} & \frac{\sin^2 \theta}{\cos^2 \phi} \left[\frac{v^2}{f^2} + \frac{1}{\sin^2 \alpha} \right] & -\frac{\sin^2 \theta}{\sin^2 \alpha \sin \phi \cos \phi} \\ 0 & 0 & -\frac{\sin^2 \theta}{\sin^2 \alpha \sin \phi \cos \phi} & \frac{\sin^2 \theta}{\sin^2 \alpha \sin^2 \phi} \end{pmatrix} \quad (20)$$

yields a massless photon, a light Z state with mass

$$M_Z^2 = \frac{e^2 v^2}{4 \sin^2 \theta \cos^2 \theta} \left(1 - (\cos^2 \alpha \sin^4 \omega + \sin^2 \alpha \sin^4 \phi) \frac{v^2}{f^2} \right) + \dots \quad (21)$$

and two heavy Z states with leading-order masses

$$M_{N1}^2 = \frac{e^2 f^2}{4 \cos^2 \theta} \left(\frac{1}{\sin^2 \alpha \sin^2 \phi \cos^2 \phi} \right) \quad (22)$$

$$M_{N2}^2 = \frac{e^2 f^2}{4 \sin^2 \theta} \left(\frac{1}{\cos^2 \alpha \sin^2 \omega \cos^2 \omega} \right) \quad (23)$$

By comparing our expression for M_Z^2 with our previous results for the relationships between G_F and v in Cases I and II, we can see that the fermion charge assignments have a major effect on the predicted values of electroweak observables. The leading corrections to the standard model relation between G_F , α , M_Z^2 , and the appropriately defined weak mixing angle $\sin^2 \theta_W$ are generically of order v^2/f^2 in Case II. In Case I, the dominant corrections are further suppressed by factors of $\sin^4 \omega$ or $\sin^4 \phi$. Then, if one views the electroweak predictions of GBESS in terms of *corrections* to

the corresponding standard model results, these corrections in Case I are (potentially) suppressed by ratios of coupling constants relative to the size of corrections in Case II. This leads generically to weaker constraints in Case I models, meaning that new phenomena associated with such models (such as extra gauge bosons) can exist at lower energy scales.

In order to make predictions for electroweak observables, we need to compute the couplings of the ordinary fermions to the light gauge boson eigenstates. For Case I theories, we find that the couplings to the left-handed fermions to the W are

$$\frac{e}{\sin \theta} \left(1 - \cos^2 \alpha \sin^4 \omega \frac{v^2}{f^2} \right) + \dots \quad (24)$$

and for the Z we find the couplings

$$\begin{aligned} & \frac{e}{\sin \theta \cos \theta} \left[1 - (\cos^2 \alpha \sin^4 \omega + \sin^2 \alpha \sin^4 \phi) \frac{v^2}{f^2} + \dots \right] T_3 \\ & - \frac{e}{\sin \theta \cos \theta} \left(\sin^2 \theta - \sin^2 \alpha \sin^4 \phi \frac{v^2}{f^2} + \dots \right) Q . \end{aligned} \quad (25)$$

Examining our expressions for the shifted gauge-boson masses and couplings, we see that, for Case I, all corrections to standard model predictions may be expressed in terms of two combinations of Lagrangian parameters:

$$c_1 = \cos^2 \alpha \sin^4 \omega \frac{v^2}{f^2}, \quad c_2 = \sin^2 \alpha \sin^4 \phi \frac{v^2}{f^2} . \quad (26)$$

This allows us to compute bounds on model parameters in terms of fits to c_1 and c_2 , greatly simplifying the calculations.

For Cases II-IV, the leading corrections to gauge-boson couplings at order v^2/f^2 are suppressed by only two powers of $\sin \omega$ or $\sin \phi$. To facilitate comparison of the forms of the couplings in the different Cases, we write the general formula for W couplings to left-handed fermions

$$\frac{e}{\sin \theta} \left(1 + a_{\pm} \frac{v^2}{f^2} \right) \quad (27)$$

and for Z couplings to fermions

$$\frac{e}{\sin \theta \cos \theta} \left[1 + a_3 \frac{v^2}{f^2} \right] T_3 - \frac{e}{\sin \theta \cos \theta} \left[\sin^2 \theta + a_Q \frac{v^2}{f^2} \right] Q . \quad (28)$$

and tabulate the factors a_{\pm} , a_3 , and a_Q in Table 2. The general pattern is that when the fermions couple to a group on the interior (exterior) of the moose, the leading correction at order v^2/f^2 goes as \sin^4 (\sin^2) of the associated mixing angle. Thus the corrections in models where fermions couple to an exterior group can be significantly larger than those in Case I.

Case	a_{\pm}	a_3	a_Q
I (W, B)	$-c_{\alpha}^2 s_{\omega}^4$	$-c_{\alpha}^2 s_{\omega}^4 - s_{\alpha}^2 s_{\phi}^4$	$-s_{\alpha}^2 s_{\phi}^4$
II (L, B)	$c_{\alpha}^2 s_{\omega}^2 c_{\omega}^2$	$c_{\alpha}^2 s_{\omega}^2 c_{\omega}^2 - s_{\alpha}^2 s_{\phi}^4$	$-s_{\alpha}^2 s_{\phi}^4$
III (W, R)	$-c_{\alpha}^2 s_{\omega}^4$	$-c_{\alpha}^2 s_{\omega}^4 + s_{\alpha}^2 s_{\phi}^2 c_{\phi}^2$	$s_{\alpha}^2 s_{\phi}^2 c_{\phi}^2$
IV (L, R)	$c_{\alpha}^2 s_{\omega}^2 c_{\omega}^2$	$c_{\alpha}^2 s_{\omega}^2 c_{\omega}^2 + s_{\alpha}^2 s_{\phi}^2 c_{\phi}^2$	$s_{\alpha}^2 s_{\phi}^2 c_{\phi}^2$

Table 2: Coefficients of the order v^2/f^2 corrections to fermion couplings to W and Z bosons (per equations 27, 28) in Cases I-IV. For each Case we note the gauge groups ($SU(2)_{L \text{ or } W}$, $U(1)_{B \text{ or } R}$) under which the fermions are charged. For brevity, we abbreviate $\cos^2 \alpha$ as c_{α}^2 , and $\sin^2 \alpha$ as s_{α}^2 , and so forth.

5 Flavor-Universal Analysis and Results

From the calculations in the previous two sections of the paper, we may compute the values of all precisely measured electroweak quantities in terms of the Lagrangian parameters. Using the procedure outlined in Burgess *et al.*, [30] we find that the leading contributions to the observables are given in Table 3. As mentioned earlier, all correction terms of order $\frac{v^2}{f^2}$ are of the forms c_1 and c_2 defined in eqn. 26, meaning that they involve the fourth power of either $\sin \omega$ or $\sin \phi$. In contrast, Table 2 illustrates the corrections of order $\frac{v^2}{f^2}$ for Case II-IV models are suppressed by fewer powers of these mixing angles; one expects terms proportional to $\sin^2 \omega$ in Cases II, IV and to $\sin^2 \phi$ in Cases III, IV. We therefore perform a detailed comparison to the data only for models of Case I, in which all fermions are charged under the middle two groups of the moose.

We have made a global fit of the predictions of GBESS (Case I) to the electroweak observables listed in the most recent compilation by the LEP Electroweak Working Group [31]. These include Z-pole observables as well as the width of the W boson, and low-energy atomic parity violation and neutrino-nucleon scattering. The 68%, 95%, and 99% confidence level fits for the parameters $c_{1,2}$ are shown in Figure 1.

The best fit values are

$$c_1^{bestfit} = 0.000563, \quad c_2^{bestfit} = -0.000108; \quad (29)$$

note that the negative value of $c_2^{bestfit}$ is unphysical given the definition 26 of c_2 . The best-fit value of χ^2/df is 30.5/20 for GBESS; the probability of a χ^2/df of this size or greater is only 6.4%. Fitting the same data to the

Observable	Case I
Γ_Z	$(\Gamma_Z)_{SM}(1 - 0.896c_1 + 0.155c_2)$
R_e	$(R_e)_{SM}(1 + 0.082c_1 + 0.912c_2)$
R_μ	$(R_\mu)_{SM}(1 + 0.082c_1 + 0.912c_2)$
R_τ	$(R_\tau)_{SM}(1 + 0.082c_1 + 0.912c_2)$
σ_h	$(\sigma_h)_{SM}(1 - 0.007c_1 - 0.078c_2)$
R_b	$(R_b)_{SM}(1 - 0.018c_1 - 0.201c_2)$
R_c	$(R_c)_{SM}(1 + 0.035c_1 + 0.388c_2)$
A_{FB}^e	$(A_{FB}^e)_{SM} + 0.176c_1 + 1.95c_2$
A_{FB}^μ	$(A_{FB}^\mu)_{SM} + 0.176c_1 + 1.95c_2$
A_{FB}^τ	$(A_{FB}^\tau)_{SM} + 0.176c_1 + 1.95c_2$
$A_\tau(P_\tau)$	$(A_\tau(P_\tau))_{SM} + 0.781c_1 + 8.65c_2$
$A_e(P_\tau)$	$(A_e(P_\tau))_{SM} + 0.781c_1 + 8.65c_2$
A_{FB}^b	$(A_{FB}^b)_{SM} + 0.555c_1 + 6.15c_2$
A_{FB}^c	$(A_{FB}^c)_{SM} + 0.431c_1 + 4.77c_2$
A_{LR}	$(A_{LR})_{SM} + 0.781c_1 + 8.65c_2$
M_W^2	$(M_W^2)_{SM}(1 + 0.430c_1 + 1.43c_2)$
M_W^2/M_Z^2	$(M_W^2/M_Z^2)_{SM}(1 + 0.430c_1 + 1.43c_2)$
$g_L^2(\nu N \rightarrow \nu X)$	$(g_L^2(\nu N \rightarrow \nu X))_{SM} + 0.239(c_1 + c_2)$
$g_R^2(\nu N \rightarrow \nu X)$	$(g_R^2(\nu N \rightarrow \nu X))_{SM} - 0.092(c_1 + c_2)$
$g_{eV}(\nu e \rightarrow \nu e)$	$(g_{eV}(\nu e \rightarrow \nu e))_{SM} - 0.661(c_1 + c_2)$
$g_{eA}(\nu e \rightarrow \nu e)$	$(g_{eA}(\nu e \rightarrow \nu e))_{SM}$
$Q_W(Cs)$	$(Q_W(Cs))_{SM} + 72.7(c_1 + c_2)$

Table 3: Corrections to precision observables in terms of the parameters c_1 and c_2 discussed in the text.

standard model, the χ^2/df is 30.97/22, corresponding to a 9.7% probability. At present, no known model of this type gives a better fit to the data than the standard model.

Note that the constraints from the fit on c_2 (which depends on $\sin\phi$) are significantly stronger than those on c_1 (which depends on $\sin\omega$). In a flavor-universal model, $\sin^2\theta_{eff}$ (the ratio of a fermion's coupling to Q to its coupling to T_3) is the same for each species. The majority of precision electroweak observables can be expressed in terms of ratios of the Z boson's couplings to various fermions – meaning that these observables depend only on $\sin^2\theta_{eff}$. Now the shift in $\sin^2\theta_{eff}$ from the standard model prediction (as inferred from G_F , α , and M_Z at tree level) depends as follows on $\sin\phi$

and $\sin \omega$

$$\begin{aligned} \delta(\sin^2 \theta_{eff}) \approx & - \left(\frac{\sin^4 \theta}{\cos^2 \theta - \sin^2 \theta} \right) \cos^2 \alpha \sin^4 \omega \frac{v^2}{f^2} \\ & - \left(1 + \frac{\sin^4 \theta}{\cos^2 \theta - \sin^2 \theta} \right) \sin^2 \alpha \sin^4 \phi \frac{v^2}{f^2} . \end{aligned} \quad (30)$$

Since the first term in parentheses is ~ 0.1 and the second such term is ~ 1.1 , then $\sin^2 \theta_{eff}$ and the electroweak observables are far more sensitive to $\sin \phi$ than to $\sin \omega$.

For a given value of α , we may unfold these constraints to produce a 95% lower bound on f in terms of $\sin \omega$ and $\sin \phi$. A sense of the reach of these bounds is given in Figure 2, plotted for $\alpha = \pi/4$. For typical values of $\sin \phi$ and $\sin \omega$, the bounds on the scale f range from a few TeV. Note that the standard model structure is formally recovered in the limit where both $\sin \phi$ and $\sin \omega$ approach zero.

6 Discussion and Conclusions

In studying the Generalized BESS class of models with extended electroweak gauge groups, we have seen how the assignment of fermion charges affects the structure of corrections to precision electroweak observables. Having fermions transform under the outer $SU(2)$ or $U(1)$ group of the linear moose (as in Cases II-IV) results in leading corrections that are suppressed by only two powers of the sine of the weak (ω) or hypercharge (ϕ) mixing angle, respectively. If all fermions are charged only under the innermost groups (as in Case I), all corrections to electroweak observables are instead suppressed by $\sin^4 \omega$ or $\sin^4 \phi$.

This fourth-power suppression was previously noted in the so-called *degenerate BESS* model [20] in which a parity symmetry imposed the condition $\alpha = \pi/4$. Our results show that the suppression is independent of α , and arises purely from the choice of gauge charges for the fermions. Degenerate BESS exhibits the suppression not because of the parity symmetry (as originally supposed) but because its fermion couplings are as in Case I.

As noted earlier, a number of models in the literature [3, 4, 8, 9, 11, 12, 24, 25, 26] are special cases of the GBESS framework. We can now understand the structure of the electroweak corrections found in the literature on these models in terms of the general properties outlined above. Many of these models are flavor non-universal, in contrast to the universal case discussed here. In such cases, one applies the rules outlined here separately to each

species of fermion. For example, consider the heavy case of NCETC (equation 4). This is an example of GBESS in the limit where $(\sin \alpha, \sin \phi) \rightarrow 0$ because there is no fourth group in the moose. The first and second generation fermions behave as in Case II of GBESS because they couple to the outer $SU(2)_2$ group; the 3rd generation fermions behave as in Case I. Therefore we predict the Fermi constant to be $\sqrt{2}G_F = v^{-2} + f^{-2}$ and the Z coupling to left-handed fermions to be

$$\frac{e}{\sin \theta \cos \theta} \left[1 + \frac{v^2}{f^2} (\cos^2 \omega \sin^2 \omega T_3^L - \sin^4 \omega T_3^H) \right] \quad (31)$$

where the separate weak generators for the heavy (H) and light (F) fermions are distinguished. Both of these results match what was found in [4]. In the light case of NCETC, it is the light fermions which behave as in our Case I and the heavy fermions as in Case II; the predictions for G_F and the Z boson coupling to fermions are modified accordingly.²

Many of the specific models cited above correspond to taking a weak-coupling limit for the extra gauge groups (i.e., taking $\sin \phi$ or $\sin \omega$ of order 1), in which case the bounds on f are of order 10 TeV, as consistent with results in the literature for topcolor, NCETC, UUM and electroweak $SU(3)$ [4, 27, 32, 28]. This tends to make the extra gauge bosons too heavy to observe easily in collider experiments. Formally the corrections to electroweak observables vanish when the couplings of the extra gauge groups become strong, that is in the limit $(\sin \phi, \sin \omega) \rightarrow 0$. The phenomenologically interesting question is whether there are *any* viable models corresponding to this limit, which would result in interesting structure at accessible scales.

Acknowledgments

Work partially supported by the US Department of Energy under grants DE-FG02-91ER40676 and DE-FG03-93ER40757. E.H.S. and R.S.C. acknowledge the hospitality of the Aspen Center for Physics where part of this work was completed.

²In making a comparison with light NCETC [4], one must note the following difference of conventions. In our discussion, we move fermions from one gauge group to another, leaving the order of the moose and the names of the couplings unaltered. In changing from heavy to light NCETC the original reference effectively moved the $U(1)$ hypercharge group to the left-hand end of the moose and swapped the couplings g and \tilde{g} . Thus to compare with this reference we must make the exchange $\sin \omega \rightarrow \cos \omega$.

References

- [1] C. T. Hill and E. H. Simmons, Phys. Rept. **381**, 235 (2003) [arXiv:hep-ph/0203079].
- [2] E. H. Simmons, arXiv:hep-ph/0211335.
- [3] R. S. Chivukula, E. H. Simmons and J. Terning, Phys. Lett. B **331**, 383 (1994) [arXiv:hep-ph/9404209].
- [4] R. S. Chivukula, E. H. Simmons and J. Terning, Phys. Rev. D **53**, 5258 (1996) [arXiv:hep-ph/9506427].
- [5] D. J. Muller and S. Nandi, Phys. Lett. B **383**, 345 (1996) [arXiv:hep-ph/9602390].
- [6] E. Malkawi, T. Tait and C. P. Yuan, Phys. Lett. B **385**, 304 (1996) [arXiv:hep-ph/9603349].
- [7] H. J. He, T. Tait and C. P. Yuan, Phys. Rev. D **62**, 011702 (2000) [arXiv:hep-ph/9911266].
- [8] H. Georgi, E. E. Jenkins and E. H. Simmons, Phys. Rev. Lett. **62**, 2789 (1989) [Erratum-ibid. **63**, 1540 (1989)].
- [9] H. Georgi, E. E. Jenkins and E. H. Simmons, Nucl. Phys. B **331**, 541 (1990).
- [10] X. Y. Li and E. Ma, arXiv:hep-ph/0212029.
- [11] C. T. Hill, Phys. Lett. B **266**, 419 (1991).
- [12] C. T. Hill, Phys. Lett. B **345**, 483 (1995) [arXiv:hep-ph/9411426].
- [13] K. D. Lane, Phys. Lett. B **433**, 96 (1998) [arXiv:hep-ph/9805254].
- [14] M. B. Popovic and E. H. Simmons, Phys. Rev. D **58**, 095007 (1998) [arXiv:hep-ph/9806287].
- [15] M. Cvetič and P. Langacker, arXiv:hep-ph/9707451.
- [16] G. Cleaver, M. Cvetič, J. R. Espinosa, L. L. Everett, P. Langacker and J. Wang, Phys. Rev. D **59**, 055005 (1999) [arXiv:hep-ph/9807479].
- [17] R. S. Chivukula, E. H. Simmons, J. Howard and H. J. He, arXiv:hep-ph/0304060.

- [18] H. Georgi, Nucl. Phys. B **266**, 274 (1986).
- [19] R. Casalbuoni, S. De Curtis, D. Dominici and R. Gatto, Phys. Lett. B **155**, 95 (1985).
- [20] R. Casalbuoni, A. Deandrea, S. De Curtis, D. Dominici, R. Gatto and M. Grazzini, Phys. Rev. D **53**, 5201 (1996) [arXiv:hep-ph/9510431].
- [21] M. Bando, T. Kugo and K. Yamawaki, Phys. Rept. **164**, 217 (1988).
- [22] S. Weinberg, Phys. Rev. D **13**, 974 (1976).
- [23] S. Weinberg, Phys. Rev. D **19**, 1277 (1979).
- [24] F. Pisano and V. Pleitez, Phys. Rev. D **46**, 410 (1992) [arXiv:hep-ph/9206242].
- [25] P. H. Frampton, Phys. Rev. Lett. **69**, 2889 (1992).
- [26] S. Dimopoulos and D. E. Kaplan, Phys. Lett. B **531**, 127 (2002) [arXiv:hep-ph/0201148].
- [27] R. S. Chivukula and J. Terning, Phys. Lett. B **385**, 209 (1996) [arXiv:hep-ph/9606233].
- [28] C. Csaki, J. Erlich, G. D. Kribs and J. Terning, Phys. Rev. D **66**, 075008 (2002) [arXiv:hep-ph/0204109].
- [29] H. Georgi and S. Weinberg, Phys. Rev. D **17**, 275 (1978).
- [30] C. P. Burgess, S. Godfrey, H. Konig, D. London and I. Maksymyk, Phys. Rev. D **49**, 6115 (1994) [arXiv:hep-ph/9312291].
- [31] LEP Electroweak Working Group, arXiv:hep-ex/0212036.
- [32] R. S. Chivukula and E. H. Simmons, Phys. Rev. D **66**, 015006 (2002) [arXiv:hep-ph/0205064].

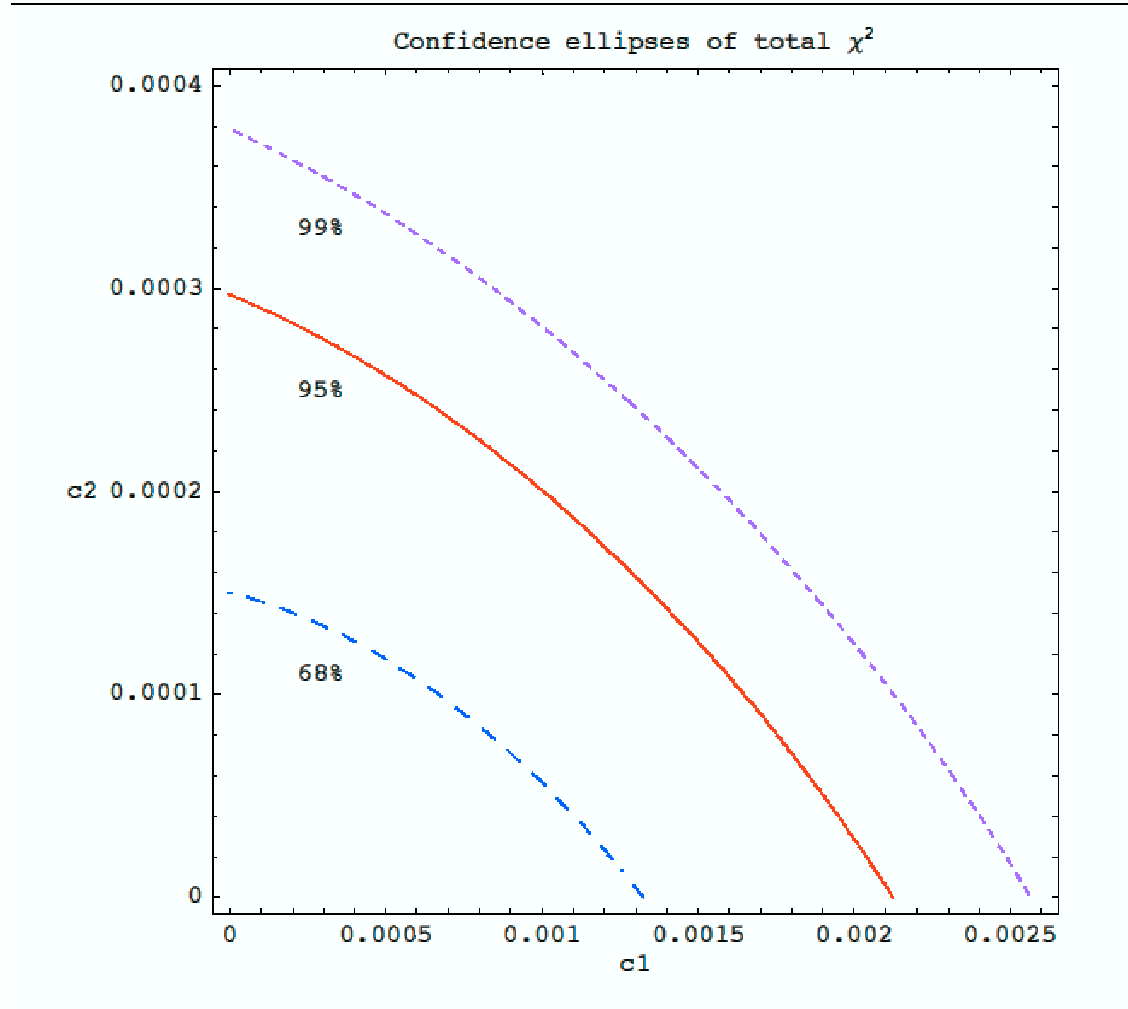

Figure 1: Constraints on c_1 and c_2 at the 68%, 95%, and 99% confidence level based on fits to precision electroweak data.[31]

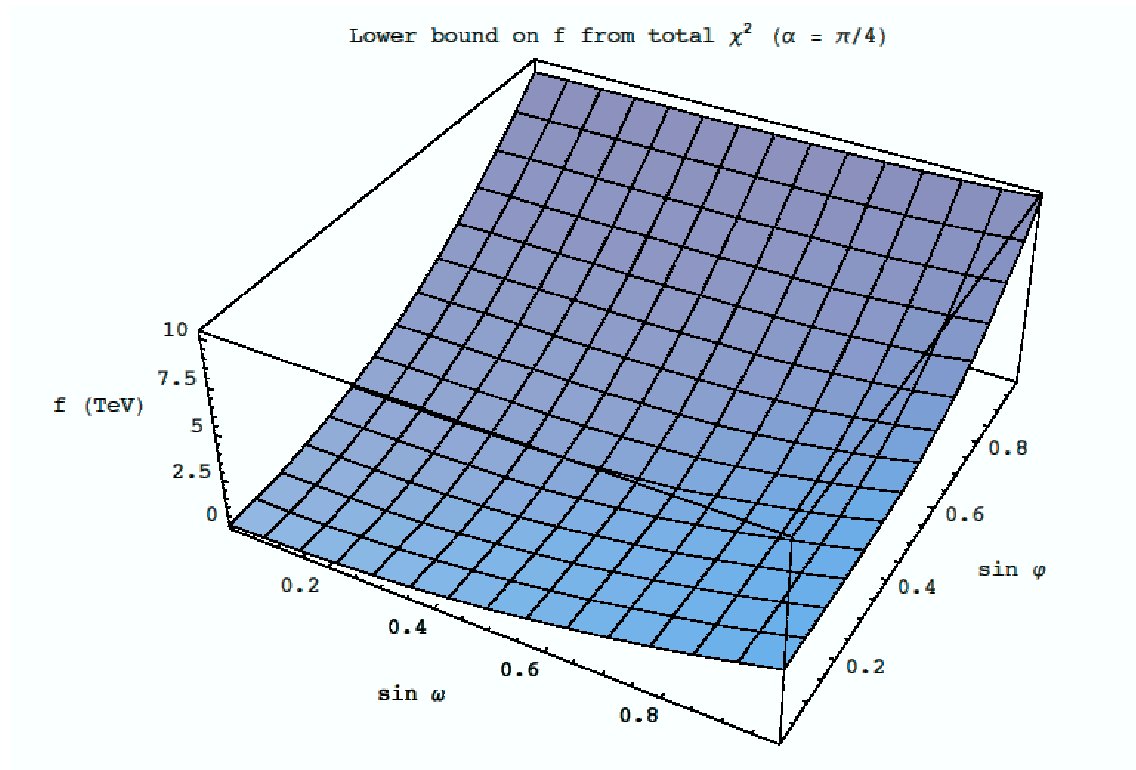

Figure 2: The lower-bound on f at 95% confidence level for $\alpha = \pi/4$, as a function of $\sin \omega$ and $\sin \phi$, based on fits to precision electroweak data.[31]