

hep-ph/0004022
DESY 00-054
April 2000
Revised: July 2000

A perturbative treatment of double gluon exchange in γ^* -proton DIS

Hamid Kharraziha¹

II. Institut für Theoretische Physik

Universität Hamburg

D-22761 Hamburg, Germany

hamid.kharraziha@desy.de

Tel: +49 40 8998 2234 Fax: +49 40 8998 2267

Abstract

A new model for the exchange of two gluons between the virtual photon and the proton, in non-diffractive deeply inelastic electron-proton scattering, is developed and studied. This model relies on a perturbative calculation, previously applied to diffraction, and a general result from Regge theory. As a first application of the model, we study corrections to the momentum transfer to the quark-anti-quark pair, at the photon-vertex. We find a significant enhancement of the cross-section at $\sim Q^2$ momentum transfers, and large negative corrections for small momentum transfers. The implication of this result for jet-distributions measured at HERA, is discussed.

PACS: 13.60.-r

Keywords: QCD, DIS, Multiple interactions.

¹Supported by the EU Fourth Framework Programme "Training and Mobility of Researchers", Network "Quantum Chromodynamics and the Deep Structure of Elementary Particles", contract FMRX-CT98-0194 (DG 12 - MIHT).

1 Introduction

In an additive parton model description, the rapid growth of the electron-proton cross-section with the total energy s , is interpreted as a growth in the number of partons (mainly gluons), inside the proton. When the density of the partons is sufficiently large, it is generally expected that they will start to self interact (screening corrections), and that the quark probe, which measures the number of gluons, will interact with several gluons simultaneously (shadowing). Such corrections are expected to slow down the energy growth of the cross-section, in a way that the Froissart bound, $\sigma \propto \log^2(s)$ [1], is not violated.

It has, however, been shown, for large enough virtualities of the photon, $Q^2 > 1 \text{ GeV}^2$, where perturbation theory is applicable, that the structure function measured at HERA, is described both by models that do not include multiple interaction effects [2], and by models where multiple interactions have a significant contribution (See e.g. [3]). The main theoretical uncertainty, is the non-perturbative nature of the proton. Different perturbative behaviour can describe the same structure function, by making different non-perturbative assumptions for the proton.

One way of settling this ambiguity, is to study more exclusive observables, e.g. properties in the final-state distribution, in addition to the structure function. A striking example of this is the observation of rapidity gap events. The appearance of large regions in rapidity with no hadrons in the final state, are generally considered to be a signal of the exchange of a colour singlet state between the proton and the probe. In a perturbative description, this is only possible by the exchange of, at least, two gluons. Thus, the rapidity gap events, indicate the significance of multiple interactions.

It is nowadays, well established that, in many cases, multiple interactions have a significant effect also on the non-diffractive final states. This became first evident, in proton-anti-proton scattering. It was observed that multiple interactions considerably increase the fluctuations in the final-state multiplicities of charged hadrons. Assuming universality for the hadronisation process, it was shown [4] that multiple interactions are necessary for the description of high multiplicity distributions, measured by the UA5 collaboration for proton-anti-proton scattering at 540 GeV [5]. Direct measurements of the cross-section for double independent parton scatterings, have been made, from the appearance of two uncorrelated pairs of balanced high- p_{\perp} jets [6,7] (In [7], the measurement was made on 3 jets + photon final-states.).

The same phenomenon is observed in the case of electron-proton scattering at very low virtualities of the photon. The hadronic component of the quasi real photon, enables a description of multiple interactions, similar to the case of hadron-hadron scatterings. Again, one picks out two (or more) partons from each projectile, and

describe the multiple interaction process as simultaneous $2 \rightarrow 2$ scatterings [8]. In this way, the inclusive distribution of each scattering becomes the same as for single scattering, or in other words, inclusive final-state distributions are not changed. In photon-proton scattering, a clear signal for multiple interactions were found in the form of the so called "Pedestal effect" with an enhanced low- p_{\perp} activity in the surrounding of high- p_{\perp} jets [9].

In this article, the *independent* multiple scatterings, described above, is complemented with a model which relies on a perturbative treatment of the coupling of the photon, to two gluons inside the proton. This model results in a different kind of final-state, compared to the case of two independent scatterings. It does not necessarily lead to an increase in the jet activity in the photon direction, but instead, it leads to a change of the inclusive jet distributions. It is perhaps also more relevant for virtual photons, which should not be expected to have non-perturbative hadronic properties.

In Section 2, the basic ideas behind the model are described. One of the main ingredients is a perturbative treatment of the photon vertex which is relevant for, and has previously been applied to, diffractive events in electron-proton scattering [10]. A general result from Regge theory (The AGK cutting rules [11]), is then used to relate this perturbative calculation, to the corresponding double gluon exchange corrections to non-diffractive DIS events. By following this strategy, the relevant formulas (Eqs. (12) and (13)) are derived in Section 3. In Section 4, the four-gluon impact factor of the proton is determined, by phenomenological arguments.

In Section 5, the model is used to make numerical estimates for the effects on the momentum transfer (p_{\perp}) between the proton and the quark-anti-quark pair at the photon vertex. We find that the differential cross-section $d\sigma/dp_{\perp}^2$, for $p_{\perp}^2 \sim Q^2$ is increased with about 10%, for $Q^2 = 10 \text{ GeV}^2$ and $x_B = 0.0001$, relevant for the HERA region, and that this correction grows rapidly towards lower values of x_B and Q^2 . It is however pointed out that the uncertainties in this estimate are large, in this first treatment. In the low- p_{\perp} region, we find large negative corrections. This is interpreted as a signal for saturation in the p_{\perp} -distribution.

In the Appendix, we make a consistency check for the validity of the AGK-rules, in the sense they have been used for the model. This is however not a full QCD calculation.

It should be mentioned, that the same kind of physics that is discussed here, can be treated inside a formalism that has been developed for radiation process in medium [12, 13]. So far, this study has been concentrated on the effect of energy loss in medium, but recently [13], it was extended to also cover effects on transverse momenta distributions. Explicit studies in this respect for e-p scattering, has however not yet been done.

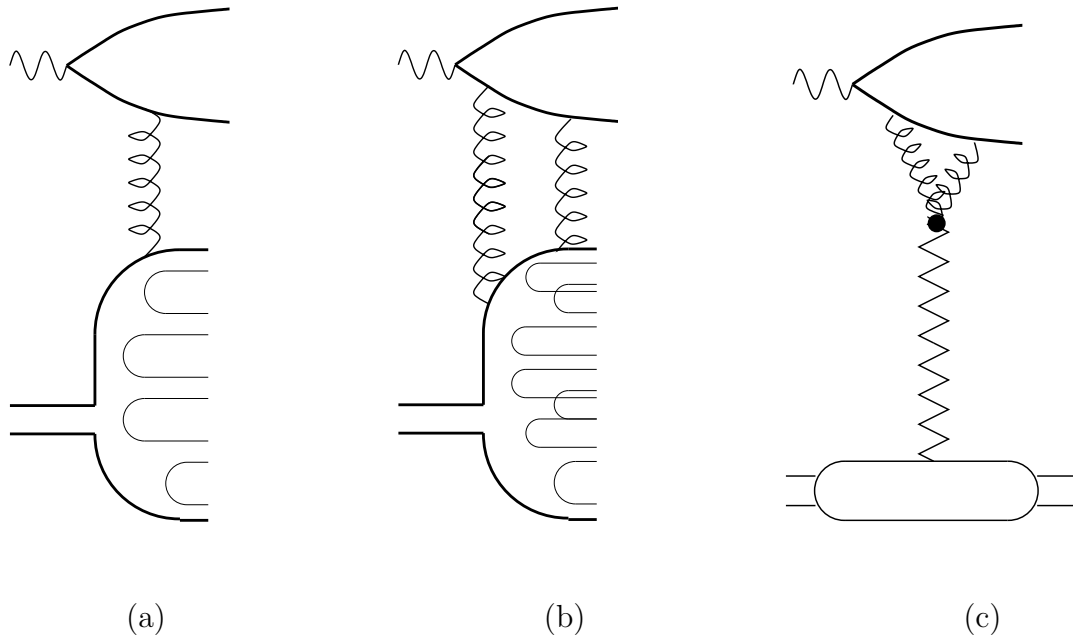

Figure 1: (a) Normal DIS: A single gluon is exchanged between the quark-pair (above) and the proton (below). The proton breaks up into a high-mass hadronic state. (b) Non-diffractive double gluon exchange: The hadronic state becomes more dense. (c) Diffractive event: A pomeron is exchanged. It couples to the quark-pair as a system of two gluons in colour singlet.

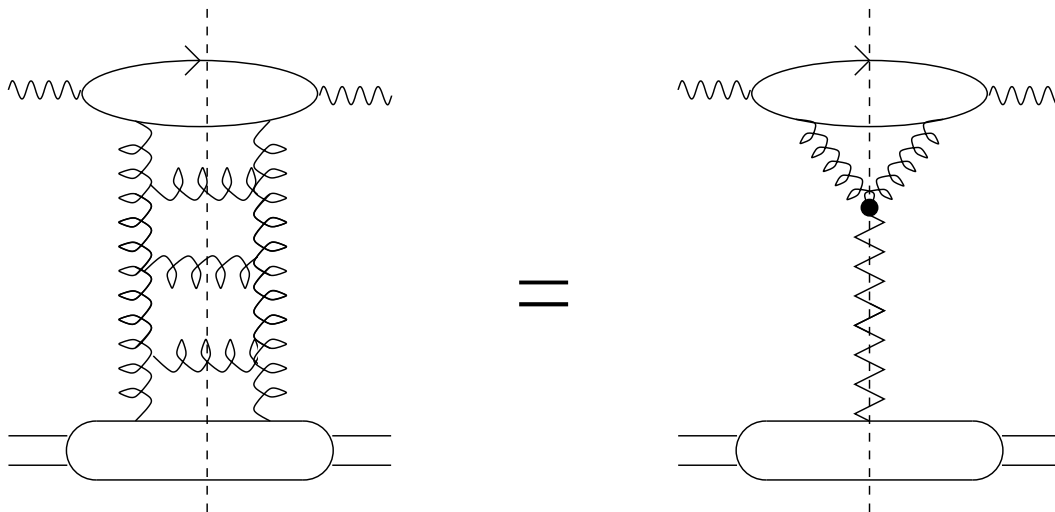

Figure 2: The BFKL ladder and its representation as one-pomeron exchange.

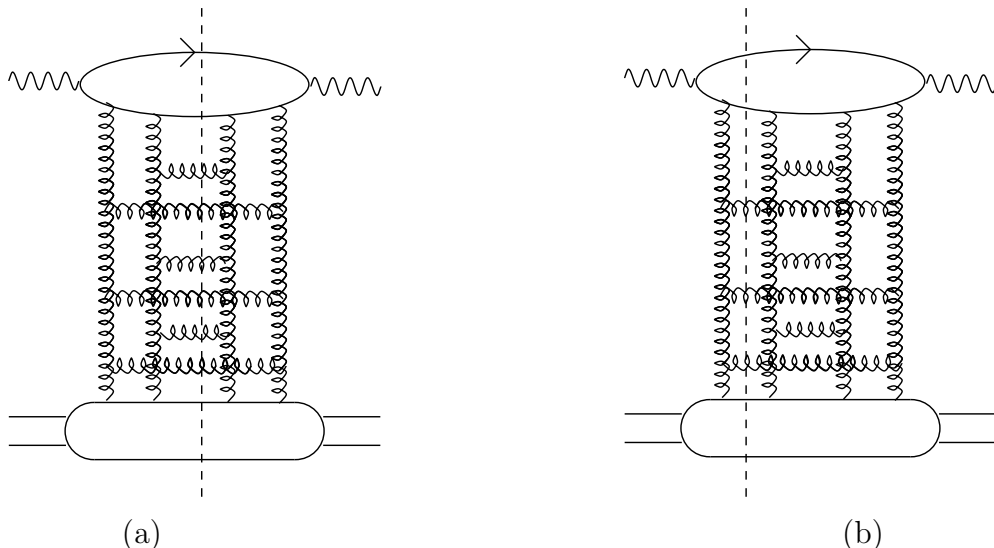

Figure 3: Examples of two-ladder exchange, with different final states: (a) Both ladders are cut and the final-state distribution is doubly dense, compared to normal DIS. (b) One ladder is cut. This gives the same final-state distribution as the leading contribution.

2 A model for perturbative double gluon exchange

The details of the present model are outlined in the following two sections. Here, we discuss the physical problem in general, and describe the main assumption that are used in the model.

In the region of low x_B and moderate Q^2 , the leading $\log(s)$ (LLs) calculations of BFKL [14] are expected to be valid, and gave in fact, a qualitatively correct prediction for the growth of the cross-section, towards lower x_B -values, $\sigma \propto x_B^{-\lambda}$. (It should be mentioned that also models based on DGLAP evolution give a good description of the strong rise of the structure function [2].) In this frame work, the leading contribution to the cross-section is given by the exchange of a colour singlet gluonic ladder between the proton and a quark loop at the photon vertex (See Fig. 2). The rungs in the ladder appear as gluon emissions into the final-state. After the hadronisation process, one will then end up with a hadronic final-state with a very large mass, $W^2 = Q^2/x_B$. The BFKL prediction for the value of the exponent $\lambda = 4\bar{\alpha}\log(2) \approx 0.55$, for $\bar{\alpha} \equiv N\alpha_s/\pi = 0.2$ with $N = 3$ colours, is observed to be too large compared to measurements of the structure function. Sub-leading corrections are expected to lower this value to around $\lambda = 0.3 - 0.4$ (See e.g. [15] and [16]). For this cross-section, down to the next-to-leading order, we will use the notation $\sigma_1^{(2)}$, since it corresponds to the process that the quark pair absorbs

a single gluon from the proton and has its contributions given from diagrams with two reggeised gluons coupled to the quark loop.

The multiple interaction effects that we are interested in here, appear first at the sub-sub-leading level and are currently not fully calculated. For double gluon exchange² (With the cross-section given from diagrams with four reggeised gluons coupled to the quark loop.) one can however expect contributions with two exchanged ladders, which would lead to a faster energy growth than the leading contribution. We will use results from Regge theory, as a way to determine just these fast growing contributions at the sub-sub-leading level.

In the language of Regge theory, the gluon ladder which appears in the leading BFKL contribution corresponds to the exchange of a pomeron, with the final-state cut going across it. In Regge theory, one can also discuss the possibility of the exchange of several pomerons. Two-pomeron exchange, with the final-state cut going in between the two pomerons, has been successfully used for the description of diffractive events in electron-proton scattering [10]. There, the pomeron and its coupling to the proton, was determined by phenomenological arguments, while, at the photon vertex, the pomeron was assumed to couple as two gluons in the colour singlet state. The leading part of the amplitude for pomeron exchange is expected to be purely imaginary. According to the Cutkosky rule [17], this means that it is, to leading order, given by its s-discontinuity,

$$\mathcal{A}_{\text{diff}} \approx i\text{Im}\mathcal{A}_{\text{diff}} = \frac{i}{2}\text{disc}_s\mathcal{A}_{\text{diff}}$$

The diffractive cross-section, which we will denote σ_0 , is in this way determined from a triple discontinuity and the calculations are considerably simplified.

In Regge theory, the two-pomeron exchange gives two other types of contributions, but with non-diffractive final-states. These are given by the possibilities that the cut goes through one or both of the pomerons. We will base the modelling of double gluon exchange and a higher order correction to single gluon exchange on these non-diffractive contributions of two-pomeron exchange. The contributions to double gluon exchange, the process that the quark pair absorbs two gluons, are given from diagrams like the one in Fig. 3a with two cut pomerons. The contribution from diagrams with one cut pomeron (Fig. 3b), correspond to the higher order correction to single gluon exchange.

Throughout in this article, we denote the cross-section of single gluon exchange σ_1 and the cross-section of double gluon exchange with σ_2 . Single gluon exchange has

²Note that we are here discussing the underlying physical process of two exchanged gluons, however, the processes of double gluon exchange and the correction to single gluon exchange, have their contribution given from Feynman diagrams with four exchanged gluons. We use the notion 'single' and 'double' when discussing the physical process, and numbers e.g. 'two-', 'four-' for the discussion of Feynman diagrams.

two separate contributions, $\sigma_1 = \sigma_1^{(2)} + \sigma_1^{(4)}$, where $\sigma_1^{(2)}$ is the BFKL cross-section with two reggeised gluons coupled to the quark loop, while $\sigma_1^{(4)}$ is the sub-sub-leading correction, with four reggeised gluons. (Some sub-leading corrections in the gluon ladder are also included by using the lower value of the exponent λ .) The diffractive cross-section is denoted σ_0 . For the sake of discussion, a tilde will be used for the cross-sections defined in Regge theory. Thus, we will denote the two-pomeron exchange cross-section with i cut pomerons with $\tilde{\sigma}_i$. However, in the present approach, each of these will be identified with the respective untilded cross-section (With the same sub-script).

For the non-diffractive contributions of two-pomeron exchange, i.e. σ_2 and $\sigma_1^{(4)}$, it is not certain that the use of the Cutkosky rule gives the complete answer, since the amplitudes (The diagram on either side of the cut in Fig. 3 a and b.) can have real contributions, also at the level, in the LLs expansion, that we are interested in. We will resolve this uncertainty, by using a result in Regge theory. In an article by Abramovski, Gribov and Kancheli [11], it was shown that the relative size of the contributions of two-pomeron exchange, but with different number of cut pomerons is given by

$$\tilde{\sigma}_0 : \tilde{\sigma}_1 : \tilde{\sigma}_2 = 1 : -4 : 2. \quad (1)$$

The main ingredient in their proof was factorisation into one, approximately imaginary, signature factor for each pomeron, and a single vertex function for the coupling of the two pomerons to the external particles. However, they used an underlying ϕ^3 -theory of scalar particles, in order to show that the vertex functions are not changed in the different cuttings. We will make the non-trivial assumption that the AGK rules are valid also in our case. This allows us to use the diffractive calculation, where the Cutkosky rule is applicable, to determine the other two contributions $\sigma_1^{(4)}$ and σ_2 .

As described above, the diffractive cross-section is given from diagrams with one pomeron on each side of the final-state cut. Each pomeron couples to the quark loop as two gluons in the colour singlet state and with the transverse momenta relatively well balanced. For the case of double gluon exchange σ_2 (Fig. 3a) one also has two gluons that couples to the quarks, on each side of the final-state cut, but they arise from two different pomerons. They are not necessarily in the colour singlet state, and the momenta can be rather unbalanced, due to perturbative QCD radiation. Finally, the higher order correction to single gluon exchange, $\sigma_1^{(4)}$ (Fig. 3b) is given from diagrams with one gluon on one side of the cut and three on the other. In this case, the transferred momentum and colour is given from that of the single gluon. In all the three cases, we will assume that each individual gluon, identified by its origin from the pomerons, has the same momentum distribution as determined in the diffractive case, from the triple discontinuity calculation. In this way, we can calculate the momentum transfer also

for the two non-diffractive contributions. The normalisation of each contribution is determined from the AGK cutting rules (and the diffractive calculation), so that the relative size of the inclusive cross-sections will satisfy Eq. (1).

The applicability of the AGK rules in QCD was discussed for the case of quark-quark scattering in the report article of Gribov, Levin and Ryskin [19] and the case of photon-proton scattering was treated more recently, in a article by Bartels and Ryskin [18]. This latter treatment was based on contributions from triple discontinuities, as for the diffractive cross-section discussed above, but for arbitrary colour states.

In the present model we are assuming that there are further important contributions, apart from the triple discontinuities, which would arise from the real parts of the relevant amplitudes³. We will not here attempt to calculate these sub-leading contributions from first principles, but the usage of the AGK cutting rules suggest that these are necessary in our treatment.

In the Appendix, we show, for the symmetric colour exchange part of σ_2 , that the triple discontinuity result completely agrees with the AGK rules as they are used here. We are thus assuming that σ_2 has important contributions from the real part of the relevant amplitudes, but only in the case that the two exchanged gluons are in a anti-symmetric colour state.

We end this section with a more intuitive discussion of the above results, in particular, the interpretation of the higher order correction $\sigma_1^{(4)}$ and its AGK factor relative to σ_2 . Consider a model, e.g. the BFKL formalism, which approximates the cross-section with the single gluon exchange cross-section, $\sigma_1^{(2)}$. The inclusive cross-section can, in this approximation, be described as the sum of all possibilities to exchange a single gluon between the quark pair and the proton. However, the possibility of the simultaneous exchange of a second gluon is not excluded, but it goes beyond the accuracy of the calculation. In the leading BFKL calculation, the correction is formally small, since it has two extra factors of the strong coupling but no new factors of $\log(s)$. This approximation leads to an overestimate of the total cross-section because, roughly speaking, events with double gluon exchange contribute twice. On the other hand, the one gluon exchange approximation underestimates the momentum transfer to the quark pair, simply because two exchanged gluons in general carry more momentum than one. When double gluon exchange corrections are included, as in the present model, we have two separate kinds of events: We have a new kind of events with two exchanged gluons, with the cross-section σ_2 , and we have the single gluon exchange events with a modified cross-section $\sigma_1 = \sigma_1^{(2)} + \sigma_1^{(4)}$. The role of $\sigma_1^{(4)}$ is to correct for the double counting (in $\sigma_1^{(2)}$) of the double gluon exchange events. Therefore, one can intuitively expect

³Note that we here in general use the word ‘‘amplitude’’ for the diagram on either side of the final-state cut.

the AGK relation $\sigma_1^{(4)} = -2\sigma_2$ to be valid.

There are two important implications from this. First, that the total higher order correction is negative. We know this because, σ_2 corresponds to the probability of a certain process, and must be positive, while the total correction, $\sigma^{(4)} = \sigma_1^{(4)} + \sigma_2 = -\sigma_2$ is negative. The other implication, that we can expect and will become more explicit in the treatment below, is that the differential cross-section at a certain finite momentum transfer is safe towards the exchange of a very soft gluon. If one of the two exchanged gluons is very soft, σ_2 will get a contribution at a momentum transfer which is close to the momentum of the harder gluon. The correction $\sigma_1^{(4)}$ on the other will get half of its contribution at the softer momentum and half of it at the higher one. At the larger momentum transfer, the two contributions will, in the limit, cancel exactly, while there will be an extra contribution, which we usually do not have good control over, around the point of zero momentum transfer. In a perturbative treatment, it is therefore better to study corrections to the differential cross-section instead of the inclusive.

3 The coupling of two gluons to the photon

Let us start with a more detailed discussion of the amplitude which is relevant for the exchange of two gluons in the photon-proton scattering process. On the upper side, we have a virtual photon which breaks up into a quark-anti quark pair. On the lower side we have the incoming proton. Two gluons are exchanged between the proton and the quark pair, either as two separate exchanged gluons or they can combine into one gluon which is absorbed by the quark-pair. The proton transforms into a hadronic state with high mass, in the case of non-diffractive DIS, and a lower mass state in case of pomeron exchange.

The two gluons can be in either of the colour states of a singlet, an anti-symmetric octet or a symmetric octet. Higher representations are not possible for the gluons in this process since the outgoing quark pair lies in the $3 \otimes \bar{3} = 1 \oplus 8$ colour space. We will now consider the different colour states separately and describe them in the frame work of the leading logs expansion (LLs). Denote the amplitude for singlet exchange \mathcal{A}_1 , for anti-symmetric octet exchange \mathcal{A}_{8a} and for the symmetric octet \mathcal{A}_{8s} . The leading part of \mathcal{A}_{8a} is known. It factorises into the amplitude for one-gluon exchange and, to $\mathcal{O}(\alpha_s^2)$, a factor $\omega(t)\log(s)$ where ω is the trajectory function of a reggeised gluon and t is the momentum transfer. In the partonic language, it corresponds to the exchange of a single gluon, and the factor $\omega(t)\log(s)$ corresponds to a virtual emission. In our case we will be interested in contributions that belong to the next order of the LLs expansion, that is, they lack any factors of $\log(s)$, but contain two factors of the strong coupling α_s .

In the following, it will be useful to separate the amplitudes into their real and imaginary parts. The reason is that the imaginary parts are (for asymptotic s) easily calculable through the Cutkoski rule. We can then use the AGK cutting rules to also determine some contributions, due to the real parts of the amplitudes, which are important in the model. In Regge theory, it is expected that both of the amplitudes \mathcal{A}_1 and \mathcal{A}_{8s} correspond to the exchange of even signature reggeons. The leading part of a reggeon with even signature is expected to be purely imaginary, thus we can assume $\mathcal{A}_1 = i\text{Im}\mathcal{A}_1$ and $\mathcal{A}_{8s} = i\text{Im}\mathcal{A}_{8s}$. The leading part of \mathcal{A}_{8a} is real (as mentioned above) while the next-to leading contribution has both a real and an imaginary part. In our case, when the two gluon exchange amplitude is multiplied with its conjugate, the contributions $\mathcal{A}_1\mathcal{A}_1^\dagger$, $\mathcal{A}_{8s}\mathcal{A}_{8s}^\dagger$ and $\text{Im}\mathcal{A}_{8a}\text{Im}\mathcal{A}_{8a}^\dagger$ can be calculated in the asymptotic limit, using the Cutkosky relation, while the relevant contributions from $\text{Re}\mathcal{A}_{8a}^{(\text{NLLs})}\text{Re}\mathcal{A}_{8a}^{\dagger(\text{NLLs})}$ can be related to the others by the AGK cutting rules ⁴.

3.1 The four-gluon impact factor

For the diffractive cross-section, denoted σ_0 above, we will use the result of [20], where the four-gluon impact factor of the photon is calculated in the asymptotic limit. This impact factor is given by multiply cut Feynman diagrams where the four gluons couple to a photon via a quark loop (See Fig. 4b). σ_0 is then given by convoluting this impact factor with the part of the proton's impact factor which contributes to pomeron exchange (That is, with one pomeron-proton vertex on each side of the final state cut, the first term of the second row in Fig. 5). The proton's impact factor is discussed more detailed in the next section. There, we will relate it to the impact factor that is used in single pomeron exchange and to the phenomenology of high energy elastic and diffractive scatterings.

We will now explain why the multiply cut photon impact factor is relevant for the calculation of σ_0 . The main argument is that the leading part of the amplitude for pomeron exchange is purely imaginary. According to the Cutkoski rule, it is then given by its s-discontinuity times a factor $i/2$. For the $\mathcal{O}(\alpha_s^2)$ amplitude that we are considering, taking the s-discontinuity means that we have to take into account all planar diagrams (where the gluons do not cross or interact) and put a cut in between the two gluons. The practical meaning of the cut is that all particles that cross it are on mass shell. When the amplitude is multiplied with its conjugate, we will end up with planar diagrams with four-gluons exchanged between the proton

⁴This does, in no way, lead to a full determination of $\text{Re}\mathcal{A}_{8a}^{(\text{NLLs})}$. It will give determination of the part of $\text{Re}\mathcal{A}_{8a}^{(\text{NLLs})}$, which contains one gluon from each pomeron, so that $\text{Re}\mathcal{A}_{8a}^{(\text{NLLs})}\text{Re}\mathcal{A}_{8a}^{\dagger(\text{NLLs})}$ grows with energy, as fast as the other terms. We will in this way, not learn anything of e.g. the vertex corrections for the reggeised gluon.

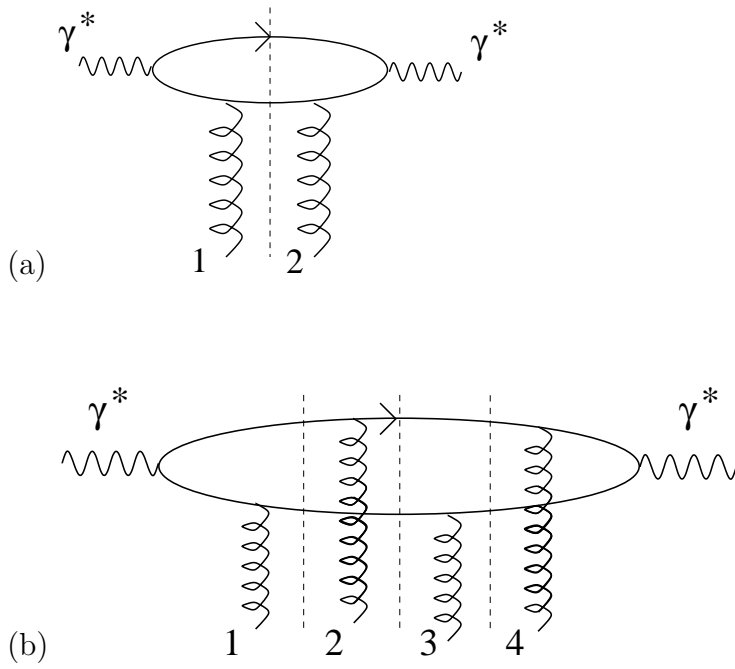

Figure 4: (a) One of the four Feynman diagrams that contribute to the two-gluon impact factor of the photon, $D_{(2;0)}(\mathbf{k}_1, \mathbf{k}_2)$. (b) One of the 16 contributions to the impact factor $D_{(4;0)}(\mathbf{k}_1, \mathbf{k}_2, \mathbf{k}_3, \mathbf{k}_4)$. The triple-discontinuity is relevant for the diffractive cross-section, since the amplitude for pomeron exchange is purely imaginary, to leading order. Note that cut particles are on mass-shell, while the gluons (and the photon) can be virtual.

and the quark loop and with cutting lines in between all the gluons. The sum of the upper parts of these diagrams will then directly correspond to the multiply cut photon impact factor defined in [20].

Before describing the explicit expression for the photonic four-gluon impact factor, it is useful to discuss the corresponding one with only two gluons (Fig. 4a). This impact factor is given by planar diagrams where two gluons couple to the quark loop in all possible ways and with a cut in between the gluons. It has the form of a colour tensor, with index a_1 and a_2 for gluon one and two respectively, and is a function of the transverse momenta (In Breit frame), \mathbf{k}_1 and \mathbf{k}_2 , of the gluons. It is given by

$$D_{(2;0)}^{a_1 a_2}(\mathbf{k}_1, \mathbf{k}_2) = g^2 \delta_{a_1 a_2} \frac{1}{2} \left[D_{(2;0)}(\mathbf{k}_1) + D_{(2;0)}(\mathbf{k}_2) - D_{(2;0)}(\mathbf{k}_1 + \mathbf{k}_2) \right] \quad (2)$$

where $D_{(2;0)}(\mathbf{k})$ denotes the forward impact factor which, after the loop integration, has the analytic form [21]

$$D_{(2;0)}(\mathbf{k}) = \frac{1}{2(2\pi)^2} \sum_f e_f^2 \int_0^1 d\alpha \int_0^1 dy \frac{[1 - 2\alpha(1 - \alpha)][1 - 2y(1 - y)]k^2}{\alpha(1 - \alpha)Q^2 + y(1 - y)k^2} \quad (3)$$

Here, Q^2 is the virtuality of the photon, α is the energy fraction of one of the quarks and y is a Feynman parameter introduced in order to do the transverse momentum integration. The sum is over quark flavours. This expression is valid for transverse polarisations of the photon and for massless quarks. For simplicity, we will disregard longitudinal polarisation and quark masses. This impact factor has the important property that it goes linearly to zero whenever one of its arguments goes to zero. The interpretation is that when the gluon becomes soft, it has a long wavelength and can not resolve the quark anti-quark pair. Since the quark pair is in a singlet system, the gluon does not interact.

Later on, it will be useful to write the two-gluon impact factor of the proton, in the form

$$\phi_2^{a_1 a_2}(\mathbf{k}_1, \mathbf{k}_2) = g^2 \frac{N}{N^2 - 1} \delta_{a_1 a_2} f_2(\mathbf{k}_1, \mathbf{k}_2), \quad (4)$$

where N is the number of colours ($N = 3$). With this definition, we can identify the function f_2 in the forward limit, with the gluon distribution in the proton. The cross-section for γ^* -proton scattering, to $\mathcal{O}(\alpha_s^2)$ is given by

$$\sigma_1^{(2)} = D_2 \otimes \phi_2.$$

The sub-script specifies that this is a contribution to the one gluon exchange process and the (2) denotes the order in α_s . The convolution procedure is defined by summation over colour indices and integration over the transverse momentum loop,

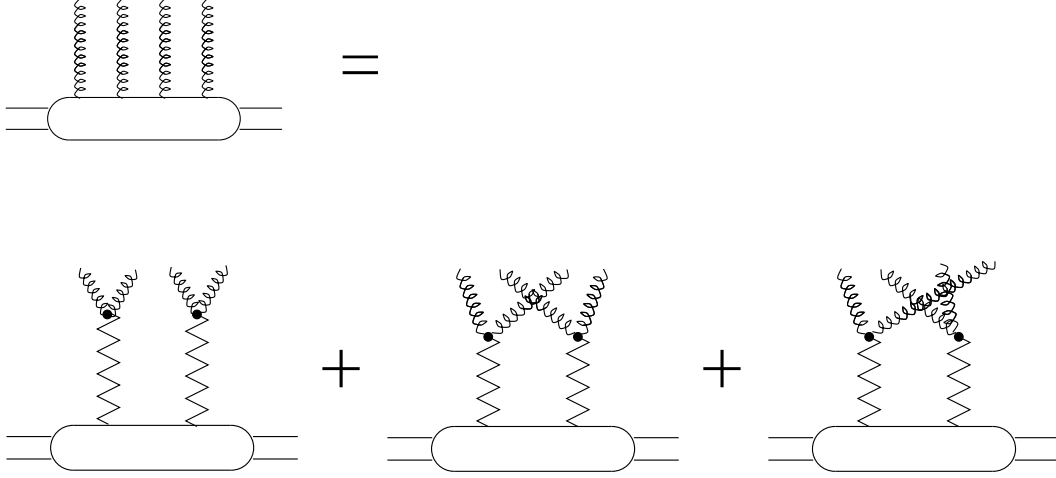

Figure 5: The assumed form for the four-gluon impact factor of the proton. Only the first term contributes to the diffractive cross-section, σ_0 . The other two terms are needed in the consistency check for the AGK rules (In the Appendix).

with the measure⁵

$$d\mathcal{K}_2 \equiv \frac{d^2\mathbf{k}_1}{(2\pi)^2} \frac{d^2\mathbf{k}_2}{(2\pi)^2} \frac{(2\pi)^2 \delta(\mathbf{k}_1 + \mathbf{k}_2)}{k_1^2 k_2^2}.$$

For the momentum transfer, p_\perp , we can write the differential cross section

$$\frac{d\sigma_1^{(2)}}{dp_\perp^2} = \pi g^4 N \int d\mathcal{K}_2 \delta(\mathbf{k}_1 - \mathbf{p}_\perp) f_2(\mathbf{k}_1, \mathbf{k}_2) D_2(\mathbf{k}_1, \mathbf{k}_2) \quad (5)$$

We can now write the explicit form of the four-gluon impact factor [20]

$$D_{(4;0)}^{a_1 a_2 a_3 a_4}(\mathbf{k}_1, \mathbf{k}_2, \mathbf{k}_3, \mathbf{k}_4) = \quad (6)$$

$$g^4 d^{a_1 a_2 a_3 a_4} D_{(4;0)}^A(\mathbf{k}_1, \mathbf{k}_2, \mathbf{k}_3, \mathbf{k}_4) + g^4 d^{a_2 a_1 a_3 a_4} D_{(4;0)}^B(\mathbf{k}_1, \mathbf{k}_2, \mathbf{k}_3, \mathbf{k}_4)$$

with

$$D_{(4;0)}^A(\mathbf{k}_1, \mathbf{k}_2, \mathbf{k}_3, \mathbf{k}_4) = D_{(2;0)}(\mathbf{k}_1 + \mathbf{k}_2 + \mathbf{k}_3, \mathbf{k}_4) + D_{(2;0)}(\mathbf{k}_1, \mathbf{k}_2 + \mathbf{k}_3 + \mathbf{k}_4) \\ - D_{(2;0)}(\mathbf{k}_1 + \mathbf{k}_4, \mathbf{k}_2 + \mathbf{k}_3), \quad (7)$$

$$D_{(4;0)}^B(\mathbf{k}_1, \mathbf{k}_2, \mathbf{k}_3, \mathbf{k}_4) = D_{(2;0)}(\mathbf{k}_1 + \mathbf{k}_3 + \mathbf{k}_4, \mathbf{k}_2) + D_{(2;0)}(\mathbf{k}_1 + \mathbf{k}_2 + \mathbf{k}_4, \mathbf{k}_3) \\ - D_{(2;0)}(\mathbf{k}_1 + \mathbf{k}_2, \mathbf{k}_3 + \mathbf{k}_4) - D_{(2;0)}(\mathbf{k}_1 + \mathbf{k}_3, \mathbf{k}_2 + \mathbf{k}_4).$$

Here, g is the strength of the strong coupling and d is a colour tensor defined by $d^{abcd} = \text{tr}[t^a t^b t^c t^d] + \text{tr}[t^d t^c t^b t^a]$, where t^a denote the SU(3) generators. It will be useful for the following, to separate $D_{(4;0)}$ into two parts. One part, with the gluons

⁵Note that the convolution procedure has the dimension of cross-section.

one and two (and consequently gluons 3 and 4) in a symmetric colour state, and one part for the anti-symmetric colour state. This separation is unique ((+) for symmetric and (-) for anti-symmetric).

$$D_{(4;0)}^{a_1 a_2 a_3 a_4}(\mathbf{k}_1, \mathbf{k}_2, \mathbf{k}_3, \mathbf{k}_4) = g^4 d_+^{a_1 a_2 a_3 a_4} D_{(4;0)}^{(+)}(\mathbf{k}_1, \mathbf{k}_2, \mathbf{k}_3, \mathbf{k}_4) + g^4 d_-^{a_1 a_2 a_3 a_4} D_{(4;0)}^{(-)}(\mathbf{k}_1, \mathbf{k}_2, \mathbf{k}_3, \mathbf{k}_4) \quad (8)$$

with

$$\begin{aligned} d_+^{a_1 a_2 a_3 a_4} &\equiv (d^{a_1 a_2 a_3 a_4} + d^{a_2 a_1 a_3 a_4}) / 2 \\ d_-^{a_1 a_2 a_3 a_4} &\equiv (d^{a_1 a_2 a_3 a_4} - d^{a_2 a_1 a_3 a_4}) / 2 \\ D_{(4;0)}^{(+)}(\mathbf{k}_1, \mathbf{k}_2, \mathbf{k}_3, \mathbf{k}_4) &\equiv D_{(4;0)}^A(\mathbf{k}_1, \mathbf{k}_2, \mathbf{k}_3, \mathbf{k}_4) + D_{(4;0)}^B(\mathbf{k}_1, \mathbf{k}_2, \mathbf{k}_3, \mathbf{k}_4) \\ D_{(4;0)}^{(-)}(\mathbf{k}_1, \mathbf{k}_2, \mathbf{k}_3, \mathbf{k}_4) &\equiv D_{(4;0)}^A(\mathbf{k}_1, \mathbf{k}_2, \mathbf{k}_3, \mathbf{k}_4) - D_{(4;0)}^B(\mathbf{k}_1, \mathbf{k}_2, \mathbf{k}_3, \mathbf{k}_4) \end{aligned} \quad (9)$$

The impact factor $D_{(4;0)}$ vanishes linearly whenever k_1 or k_4 becomes soft. This is, in general not the case for k_2 and k_3 . This can be interpreted as that the gluons 1 and 4 interact with a colour less quark pair, while gluons 2 and 3 interact with the quarks in an octet state. One can however check that the symmetric part, $D_{(4;0)}^{(+)}$, vanishes with any of its argument. Further, it is invariant under the permutation of the momenta of the gluons. We know this because it can be written as the sum of permutations of $D_{(2;0)}(\mathbf{k}_1, \mathbf{k}_2 + \mathbf{k}_3 + \mathbf{k}_4)$ and $-D_{(2;0)}(\mathbf{k}_1 + \mathbf{k}_2, \mathbf{k}_3 + \mathbf{k}_4)$. (Note that $D_{(2;0)}(\mathbf{k}_1, \mathbf{k}_2) = D_{(2;0)}(\mathbf{k}_2, \mathbf{k}_1)$.)

The diffractive cross-section σ_0 , which will be determined in the following, will have all of its contribution given from $D_{(4;0)}^{(+)}$. In our treatment, this will be the case also for the non-diffractive σ_2 and $\sigma_1^{(4)}$, since these are determined from σ_0 and the AGK rules. This means that we are assuming that the non-diffractive cross-sections have additional contributions other than from the multiply cut impact factor. This could, for example be from Feynman diagrams with triple gluon vertices, where two gluons merge into one before they are absorbed by the quark pair. One can speculate that such contributions are important, because they allow the "second" exchanged gluon to, in all possible ways, interact with the system of the quark, anti-quark and the "first" gluon, which in total is in the colour singlet state.

3.2 The diffractive contribution

For the part of the proton impact factor, denoted $\phi_{4(\mathcal{P})}$, which is used in the calculation of σ_0 , we assume the form

$$\phi_{4(\mathcal{P})}^{a_1 a_2 a_3 a_4}(\mathbf{k}_1, \mathbf{k}_2, \mathbf{k}_3, \mathbf{k}_4) = g^4 \frac{N^2}{(N^2 - 1)^2} \delta_{a_1 a_2} \delta_{a_3 a_4} f_4(\mathbf{k}_1, \mathbf{k}_2; \mathbf{k}_3, \mathbf{k}_4) \quad (10)$$

The Kronecker deltas assure colour singlet exchange, and the function f will be determined in the next section. For now, it is sufficient to mention that it is dimensionless, it goes linearly to zero whenever one of its arguments goes to zero, and it has the following symmetry properties:

$$\begin{aligned} f_4(\mathbf{k}_1, \mathbf{k}_2; \mathbf{k}_3, \mathbf{k}_4) &= f_4(\mathbf{k}_2, \mathbf{k}_1; \mathbf{k}_3, \mathbf{k}_4) \\ &= f_4(\mathbf{k}_1, \mathbf{k}_2; \mathbf{k}_4, \mathbf{k}_3) \\ &= f_4(\mathbf{k}_3, \mathbf{k}_4; \mathbf{k}_1, \mathbf{k}_2). \end{aligned}$$

The cross-section σ_0 , for pomeron exchange, is now given by the convolution of the two impact factors, $D_{(4;0)}$ and $\phi_{4(\mathcal{P})}$,

$$\sigma_0 = \frac{1}{4} D_{(4;0)} \otimes \phi_{4(\mathcal{P})}$$

where the factor of one fourth is because of the double use of the Cutkoski rules.

Later on, in section 5, we will be interested in the momentum transfer between the proton and the quark pair. Therefore, we write in more detail, the differential cross-section for a transverse momentum exchange p_\perp

$$\begin{aligned} \frac{d\sigma_0}{dp_\perp^2} &= \frac{1}{4} \cdot \pi g^8 \frac{N}{2} & (11) \\ &\times \int d\mathcal{K}_4 \delta(\mathbf{k}_1 + \mathbf{k}_2 - \mathbf{p}_\perp) f_4(\mathbf{k}_1, \mathbf{k}_2; \mathbf{k}_3, \mathbf{k}_4) D_{(4;0)}^{(+)}(\mathbf{k}_1, \mathbf{k}_2, \mathbf{k}_3, \mathbf{k}_4) \\ d\mathcal{K}_4 &\equiv \frac{d^2\mathbf{k}_1}{(2\pi)^2} \frac{d^2\mathbf{k}_2}{(2\pi)^2} \frac{d^2\mathbf{k}_3}{(2\pi)^2} \frac{d^2\mathbf{k}_4}{(2\pi)^2} \frac{(2\pi)^2 \delta(\mathbf{k}_1 + \mathbf{k}_2 + \mathbf{k}_3 + \mathbf{k}_4)}{k_1^2 k_2^2 k_3^2 k_4^2} \end{aligned}$$

For the colour part of the problem, we have used the result (with d_+ defined in eq. (9)).

$$\delta_{ab} \delta_{cd} d_+^{abcd} = 2C_f^2 N$$

Where $C_f = (N^2 - 1)/2N$ is the colour factor for gluon emission from a quark.

3.3 Non-diffractive contributions

We will now make use of the AGK rules to relate Eq. (11) to the processes of non-diffractive double gluon exchange and single gluon exchange. It is then important to note that \mathbf{k}_1 and \mathbf{k}_2 are the internal momenta of the pomeron, up to now, on one side of the final-state cut, and $\mathbf{k}_3, \mathbf{k}_4$ are the momenta of the pomeron on the other side. The AGK cutting rules relate the contribution $\tilde{\sigma}_0$ with no cut pomerons to the contributions $\tilde{\sigma}_1$ of one cut and $\tilde{\sigma}_2$ of two cut pomerons. We will now identify $\tilde{\sigma}_0$ with the diffractive cross-section σ_0 , which we have considered to now, and $\tilde{\sigma}_2$ and $\tilde{\sigma}_1$, with the cross-section for non-diffractive double gluon exchange σ_2 , and

the higher order correction to single gluon exchange $\sigma_1^{(4)}$, respectively. We assume further that the relation $\sigma_2 : \sigma_1^{(4)} : \sigma_0 = 2 : -4 : 1$ is valid on a more exclusive level with fixed values of the transverse momenta k_i .

For clarity in the following two equations, we will change notations: $\mathbf{k}_1 = \mathbf{k}_{a1}$, $\mathbf{k}_2 = \mathbf{k}_{a2}$ for the gluons that emerge from the pomeron a, and $\mathbf{k}_3 = \mathbf{k}_{b1}$, $\mathbf{k}_4 = \mathbf{k}_{b2}$, for the others. In the case of two cut pomerons, the momentum transfer (The sum of the momenta on either side of the cut) can be written as either $\mathbf{p}_\perp = \mathbf{k}_{a1} + \mathbf{k}_{b1}$ or $\mathbf{p}_\perp = \mathbf{k}_{a1} + \mathbf{k}_{b2}$. Because of symmetry properties of the impact factors, the two possibilities give the same result, and choosing the first one we get

$$\begin{aligned} \frac{d\sigma_2}{dp_\perp^2} &= \frac{1}{2} \cdot \pi g^8 \frac{N}{2} \\ &\times \int d\mathcal{K}_4 \delta(\mathbf{k}_{a1} + \mathbf{k}_{b1} - \mathbf{p}_\perp) f_4(\mathbf{k}_{a1}, \mathbf{k}_{a2}; \mathbf{k}_{b1}, \mathbf{k}_{b2}) D_{(4;0)}^{(+)}(\mathbf{k}_{a1}, \mathbf{k}_{a2}, \mathbf{k}_{b1}, \mathbf{k}_{b2}) \end{aligned} \quad (12)$$

With $d\mathcal{K}_4$ defined in Eq. (11), f_4 defined in Eq. (10) and $D_{(4;0)}^{(+)}$ defined in Eqs. (9) and (7). For the case of one cut pomeron, we have any of the possibilities $\mathbf{p}_\perp = \mathbf{k}_i$ but again the choice is irrelevant⁶ With $\mathbf{p}_\perp = \mathbf{k}_{a1}$ we get

$$\begin{aligned} \frac{d\sigma_1^{(4)}}{dp_\perp^2} &= (-1) \cdot \pi g^8 \frac{N}{2} \\ &\times \int d\mathcal{K}_4 \delta(\mathbf{k}_{a1} - \mathbf{p}_\perp) f_4(\mathbf{k}_{a1}, \mathbf{k}_{a2}; \mathbf{k}_{b1}, \mathbf{k}_{b2}) D_{(4;0)}^{(+)}(\mathbf{k}_{a1}, \mathbf{k}_{a2}, \mathbf{k}_{b1}, \mathbf{k}_{b2}) \end{aligned} \quad (13)$$

It is important to note that we do not consider all exchanges which are in the colour singlet state, as pomeron exchanges. Above, the pomeron was described by two gluons in colour singlet. For the contributions with two cut pomerons, we have, on each side of the cut, one gluon from each pomeron. These two gluons could very well also be in a colour singlet state, but we would not consider the process to be pomeron exchange. (This contribution is however colour suppressed with a factor $1/(N^2 - 1)$.) It is not certain that the (partonic) process of the exchange of two gluons in a singlet state, as opposed to pomeron exchange, should lead to a rapidity gap in the final-state distribution of hadrons, since that would correspond to (non-perturbative) colour screening, in the hadronisation process (See e.g. [22]). We will leave this question open, but refer to the contribution of σ_2 as non-diffractive.

We will now summarise the main assumptions that was needed to derive the main result of this section, that is, Eqs. (12) and (13). We started by considering the

⁶Note that the number of independent choices for p_\perp , coincides with the AGK weights.

process of pomeron exchange. There, we assumed that the amplitude is imaginary to leading order and we could therefore use the four-gluon impact factor calculated in [20]. Further on, we made some assumptions on the form of the proton impact factor (The part of it which corresponds to pomeron exchange), including some symmetry properties. Finally we assumed that the AGK cutting rules are valid so that we could relate the process of pomeron exchange to the processes of double gluon exchange and a sub-leading correction to single gluon exchange. The AGK rules were assumed to be valid for fixed values of the internal momenta (the momenta of the two gluons) in each pomeron, while originally [11], they were stated as a relation between the inclusive cross-sections.

In section 5, we will use the Eqs. (12) and (13) to make some estimates of observable effects of double gluon exchange. In the next section, the impact factor of the proton, is discussed and determined on a more quantitative level.

4 The proton impact factor

We will start with a discussion of the two-gluon impact factor, ϕ_2 , of the proton. This is related to the conventional unintegrated structure function or the parton distribution of the proton, and there are a large number of calculations and measurements available for its determination. It would, however, be inconsistent to make a direct use of the available parton distributions, since these have, in the normal case, been fitted to data, without considering effects from multiple interaction. Instead, we make a simple ansatz for ϕ_2 , by using the measured parton distributions at large momentum fractions, $x_p \sim 0.1$, where corrections from double gluon exchange should be small, and by assuming an exponential growth towards lower x_p -values.

In the second part of this section, we will determine the four-gluon impact factor, ϕ_4 , from the square of the parton distribution, times a normalization factor which is determined from two separate measurements in proton-anti-proton scattering. The uncertainty in ϕ_2 , and consequently in ϕ_4 will lead to one of the main uncertainties in the final result. In a more careful treatment, it is possible to determine these functions more accurately than will be done here. We will instead try to keep things as simple as possible, with the aim of just an order of magnitude estimate in the final results.

4.1 The two-gluon impact factor

With our way of defining the two-gluon impact factor, in Eq. (4), the function $f_2(\mathbf{k}_1, \mathbf{k}_2)$ is, in the forwards limit, given by the number of gluons, $n(k)$, inside the

proton, that an exchanged gluon, with transverse momentum k can resolve.

$$f_2(\mathbf{k}, -\mathbf{k}) = n(k) \quad (14)$$

The exact meaning of "resolve", in this case, is that we require the transverse momentum of the exchanged gluon to be smaller than half of the invariant energy of one of the quarks, from the photon side, together with the "resolved" gluon in the proton, $k^2 < \hat{s}/4$. This leads to a value, $\hat{x}(k^2)$, for the smallest possible momentum fraction, x_p , that a resolved gluon can have. Apart from k^2 , this limit (\hat{x}) depends on the proton-photon CMS energy (W) and the momentum fraction, α of the participating quark from the photon side

$$x_p > \frac{4}{\alpha} \frac{k^2}{W^2} \equiv \hat{x}.$$

In any case, we will always require that $x_p > x_B/\alpha$. We will not try to determine α from event to event, but instead, in this case, use the typical value $\alpha = 0.5$.

To determine the number of resolved gluons, we will assume a constant contribution of $n = 2$ from the region $0.1 < x_p < 1$. We will further assume a density of two gluons per unit of $\log(x_p)$ at the point $x_p = 0.1$ and from there, that it grows like $x_p^{-\lambda}$. For the value of the exponent, we will consider the two cases $\lambda = 0.3$ and $\lambda = 0.4$, respectively. (The gluon distributions, $xg_\lambda(x)$, are plotted in Fig. 6.) This results in the following expression for the number of gluons with $x_p > \hat{x}$

$$\hat{n}(\hat{x}) = 2 + \frac{2}{\lambda} \left(\left(\frac{\hat{x}}{0.1} \right)^{-\lambda} - 1 \right) \theta(0.1 - \hat{x}) \quad (15)$$

where, θ is the step-function.

Finally, we have to take into account coherence between the gluons inside the proton. When the wavelength of the exchanged gluon is at the order of the proton size, it cannot resolve the individual gluons and the effective number of gluons will decrease. Therefore, we will assume that the effective number of gluons, goes to zero, linearly with k^2 and that the suppression starts around a scale μ^2 . This effect is taken into account by multiplying $\hat{n}(\hat{x})$ with a factor $k^2/(\mu^2 + k^2)$. The suppression scale is set to $\mu^2 = 0.1 \text{ GeV}^2$ which is a typical value for the momentum transfer in elastic scattering of hadrons (See the discussion in the second part of this section). This leads, finally, to

$$n(k) = \frac{k^2}{\mu^2 + k^2} \hat{n} \left(\frac{4}{\alpha} \frac{k^2}{W^2} \right) \quad (16)$$

with \hat{n} defined in eq. (15).

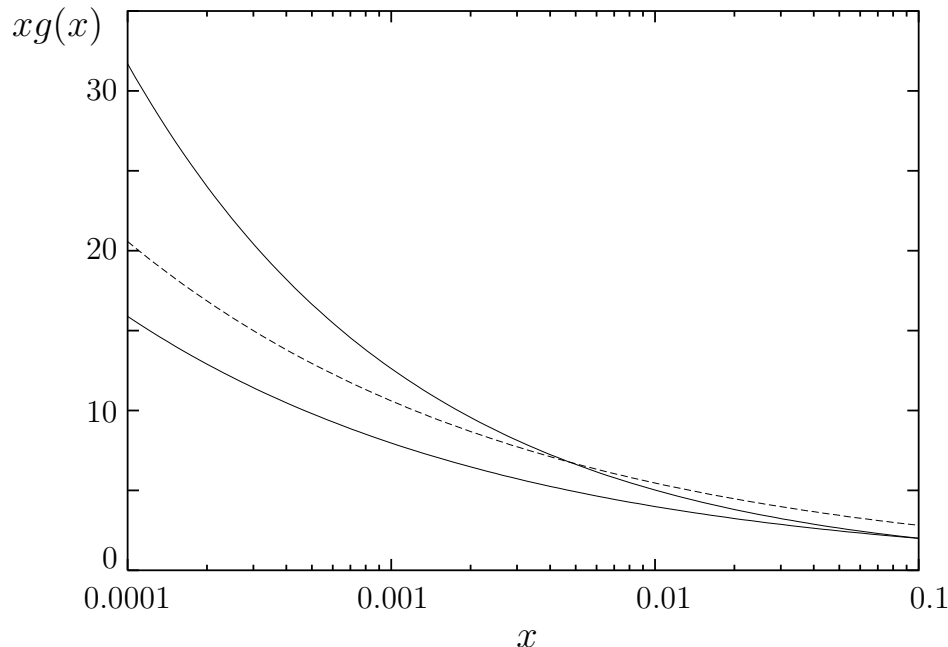

Figure 6: The assumed gluon distribution, $xg(x)$, for $\lambda = 0.3$ (lower solid curve) and $\lambda = 0.4$ (upper solid curve). The dashed curve is the gluon distribution of the GWB model.

This function is plotted in Fig. 7, again for $\lambda = 0.3$ and $\lambda = 0.4$ and with $Q^2 = 10 \text{ GeV}^2$ and $x_B = 0.0001$. We note that the two λ -values result in almost a factor of two difference in the low- k^2 region. This will be one of our main uncertainties. As mentioned before, it would be inconsistent to use the available measured parton distributions, since these have been fitted to data, without any account of multiple scattering. Here, we have instead fixed the parton distribution at a large momentum fraction $x_p = 0.1$, where saturation effects should be small, and then assumed a BFKL like x_p -dependence.

The turnover of $n(k^2)$ in Fig. 7, occurs at the point where $\hat{x} = x_B/\alpha$. This happens at $k^2 = x_B W^2/4 = Q^2/4$.

4.1.1 A comparison with the Golec-Biernat Wüsthoff model

As stated before, our parton distribution is poorly constrained, because the available fits are in general made without any concern to multiple interaction effects. There are however several saturation models that have been fitted to the structure function, and it is in some cases possible to extract the corresponding parton distribution from these fits. We will use the model of Golec-Biernat and Wüsthoff [23, 24], which is perhaps the simplest one available and which describes

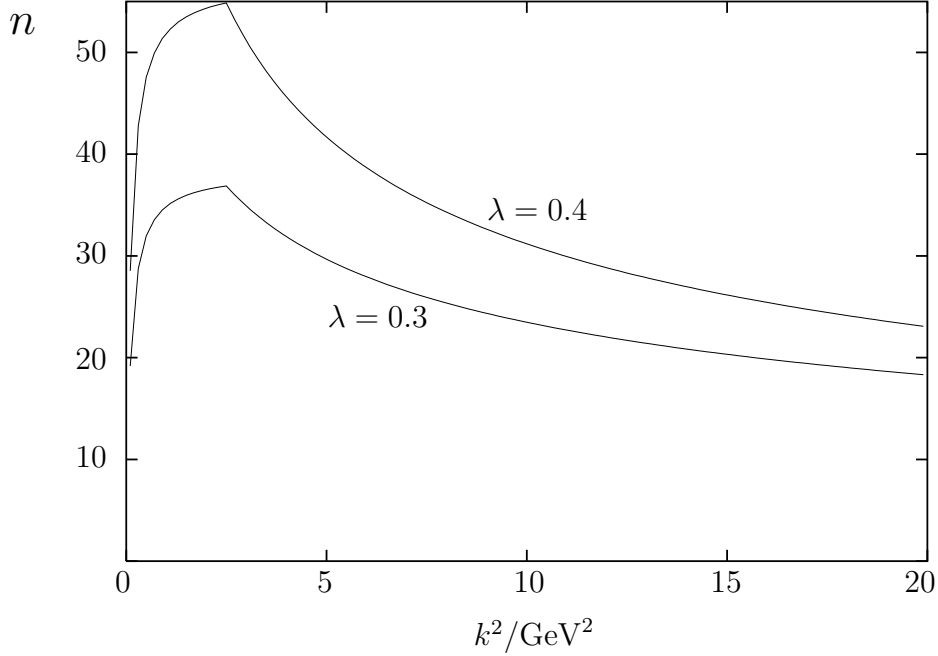

Figure 7: The number of resolved gluons $n(k^2)$, for $\lambda = 0.3$ and $\lambda = 0.4$, respectively.

the measured structure function very well, over a large range of Q^2 , in particular down to the photo-production region.

Let us start with a minimal recollection of the GBW model. The description of the DIS process is as follows, that the virtual photon splits into a quark-anti-quark pair which then propagates through the proton and exchanges one or several gluons. The γ^* -proton cross-section is, in the GBW model given by

$$\sigma_\pi(x, Q^2) = \int d^2\mathbf{r} |\Psi_\pi(\mathbf{r})|^2 \hat{\sigma}(x, r^2) \quad (17)$$

where Ψ is the wave function of the photon (Integrated over the energy fraction of the quarks), π is the polarisation of the photon and \mathbf{r} is a vector in impact parameter space. The dipole cross-section $\hat{\sigma}$ is, in this model, set to be

$$\hat{\sigma}(x, r^2) = \sigma_0 \left\{ 1 - \exp\left(-\frac{r^2}{4R_0^2(x)}\right) \right\} \quad (18)$$

with

$$R_0(x) = \frac{1}{Q_0} \left(\frac{x}{x_0}\right)^{\lambda/2} \quad (19)$$

The parameters are σ_0 , x_0 and λ , while Q_0 is set to 1 GeV and is no real parameter.

A fit to HERA data resulted in the following values [23]: $\sigma_0 = 23.03$ mb, $x_0 = 3.04 \cdot 10^{-4}$ and $\lambda = 0.288$.

The validity of the GBW model lies in that it is a simple model which, with a few parameters, can describe the structure function over a large range of Q^2 . In fact, the authors refer to it as a model which contains saturation, but they only briefly mention multiple interactions as a possible explanation for saturation [24].

It lies however close at hand to interpret the exponential in the dipole cross-section (Eq. 18) as the poissonian probability of not having any interactions. (The probability of not having any randomly scattered partons inside an area r^2 , with the average density of partons $1/(4R_0^2)$.) The GBW model is thus a model which incorporates shadowing to all orders in the number of exchanged gluons. An expansion of the exponent gives us the corrections that appear when each higher order is taken into account.

A formula, which is useful for extracting the gluon distribution, gives the following relation between the dipole cross-section and the (gluonic) unintegrated structure function $\mathcal{F}_g(x, k^2)$ (Defined as a distribution in k^2 , as in [24])

$$\hat{\sigma}(x, r) = \frac{4\pi\alpha_s}{3} \int \frac{d^2\mathbf{k}}{k^2} [1 - e^{i\mathbf{r}\cdot\mathbf{k}}] \mathcal{F}_g(x, k^2). \quad (20)$$

This relation can be inverted, but if we use $\hat{\sigma}$ as it is, then \mathcal{F} will not correspond to the gluon distribution. That would be true only if we knew that the dipole absorbs one and only one gluon in each collision.

It is however possible to get the gluon distribution of the GBW model by expanding the dipole cross-section in orders of exchanged gluons, that is, expanding the exponent of $\hat{\sigma}$. The first term, then would give us the structure function, if multiple interactions were absent. This structure function would fit data poorly, especially in the low- Q^2 region, but it would instead directly corresponds to the gluon distribution.

Using the first term in an expansion of $\hat{\sigma}$ we get

$$\sigma_0 \frac{r^2}{4R_0^2(x)} = \frac{4\pi\alpha_s}{3} \int \frac{d^2\mathbf{k}}{k^2} [1 - e^{i\mathbf{r}\cdot\mathbf{k}}] \mathcal{F}_g^1(x, k^2), \quad (21)$$

where the superscript indicates that \mathcal{F}_g^1 is calculated from single gluon exchange. This equation is inverted to give

$$\mathcal{F}_g^1(x, k^2) = \frac{\sigma_0}{4R_0^2} \frac{3}{\pi^2\alpha_s} \delta(k^2) \quad (22)$$

where δ is Dirac's function. We thus find that the first term in the expansion of $\hat{\sigma}$ gives a distribution peaked at zero transverse momentum. The full $\hat{\sigma}$, on the other

hand, gives a broader distribution, which is peaked at a finite k^2 . (When $xg(x, k^2)$ is integrated over all k^2 we get however the same result in both cases.)

For the gluon distribution, we finally get

$$xg(x, Q^2) \equiv \int_0^{Q^2} \mathcal{F}_g^1(x, k^2) dk^2 = \frac{\sigma_0}{4R_0^2(x)} \frac{3}{\pi^2 \alpha_s} \quad (23)$$

The gluon distribution that we find from the GBW model is thus independent of Q^2 . This could be expected, since there is no transverse momentum evolution of the parton distribution incorporated into the model. The GBW model thus fails to describe the structure function in the high Q^2 limit, but the fit shows that the strong Q^2 dependence in the lower region can be explained as a saturation effect, and is not necessarily related to the usual DGLAP scaling violation mechanism.

Inserting the fitted parameters we get

$$xg(x) \approx \frac{0.436}{\alpha_s} x^{-\lambda}. \quad (24)$$

This is plotted in Fig. 6 for $\alpha_s = 0.3$. Note that x in the GBW model corresponds to x_B of the e-p scattering. The momentum fraction of the interacting gluons is not well defined in the model, but is in general somewhat larger than x_B . This correction would increase the gluon distribution. We conclude that our assumed gluon distributions, with a relatively large exponent and independent of Q^2 , are supported by data.

4.2 The four-gluon impact factor

Now that we have ϕ_2 in the forward limit, we can continue with the discussion of how it can be used to determine the two-pomeron-proton form factor, $\phi_{4(\mathcal{P})}$. We will rely on the picture that ϕ_2 corresponds to a pomeron-proton vertex, and $\phi_{4(\mathcal{P})}$ is, roughly speaking, given by the square of ϕ_2 . We will also use the fact that in high energy elastic and diffractive scattering, one observes low values (well below 1 GeV²) of the typical momentum transfer. In this article, we will be interested in the momentum transfer in DIS processes, and for p_\perp^2 values above 1 GeV². With all the transverse momenta k_i larger than the typical pomeron momentum, we can write the function $f_4(\mathbf{k}_1, \mathbf{k}_2; \mathbf{k}_3, \mathbf{k}_4)$, defined in eq. (10), in the following approximative way (assuming $\sum_i \mathbf{k}_i = 0$)

$$\begin{aligned} f_4(\mathbf{p}_1 + \mathbf{r}, -\mathbf{p}_1; \mathbf{p}_2 - \mathbf{r}, -\mathbf{p}_2) &= f_2(\mathbf{p}_1 + \mathbf{r}, -\mathbf{p}_1) f_2(\mathbf{p}_2 - \mathbf{r}, -\mathbf{p}_2) P(\mathbf{r}) \\ &\approx n(p_1) n(p_2) P(\mathbf{r}) \end{aligned} \quad (25)$$

Here, we have made the substitutions

$$\begin{aligned}
\mathbf{k}_1 &= \mathbf{p}_1 + \mathbf{r} \\
\mathbf{k}_2 &= -\mathbf{p}_1 \\
\mathbf{k}_3 &= \mathbf{p}_2 - \mathbf{r} \\
\mathbf{k}_4 &= -\mathbf{p}_2
\end{aligned}
\tag{26}$$

and the function $P(\mathbf{r})$ carries all the dependence on the pomeron momentum and a possible normalisation constant. This function will have the effect of an overall normalization factor, in the final result

$$\mathcal{N} \equiv \int P(\mathbf{r}) \frac{d^2\mathbf{r}}{(2\pi)^2}.
\tag{27}$$

For the function $P(\mathbf{r})$ we assume the simple exponential form

$$P(\mathbf{r}) = ae^{-\frac{b}{2}r^2}.
\tag{28}$$

which gives

$$\mathcal{N} = \frac{a}{2\pi b}.
\tag{29}$$

The value of the parameters a and b will be determined from two different measurements from high energy proton-anti-proton scattering.

The first one, we refer to, is a measurement of the exponential slope for the momentum transfer, t , in elastic $\bar{p}p$ scattering. In our model this is described by the convolution of the two-pomeron form-factor, $\phi_{4(\mathcal{P})}$, with itself. With the approximative form in eq. (25), the transverse momentum distribution in pomeron exchange is then given by $P^2(r) \propto e^{-br^2}$. Therefore, our parameter b is directly given by the exponential slope in $\bar{p}p$ scattering.

This slope varies however weakly with the total energy. We will use the result [25] from UA4 at CERN, where protons (and anti-protons) were scattered at $\sqrt{s} = 546$ GeV. This energy is perhaps most relevant for the HERA experiment. The measured slope actually varies with the value of t , it becomes flatter for higher values of $-t$. Since we want to fix a normalization, the low- t region, which dominates, should be more relevant. In [25], a fit is made to the measured distribution, and in the region $-t < 0.15$ GeV², the result for the slope is ⁷ $b = 15.2 \pm 0.2$ GeV⁻².

The other measurement is that of the so called "effective" cross-section σ_{eff} in $\bar{p}p$ scattering. This cross-section can be defined from the cross-section σ_2 for having two independent high- p_\perp scatterings (Resulting in four uncorrelated high- p_\perp

⁷We are making the approximation $r^2 = -t$. This is of course a very good estimate.

jets.) in a single $\bar{p}p$ collision. The effective cross-section is then given by a relation between σ_2 and the square of the *inclusive* cross-section for a single high- p_\perp scattering, according to

$$\sigma_{\text{eff}} = \frac{1}{2} \frac{\sigma_1^2}{\sigma_2}$$

In practice, it turned out to be experimentally much more efficient to measure σ_{eff} from events, with one of the four jets, replaced by a photon. This measurement was made by CDF [7], and gave the result $\sigma_{\text{eff}} = 14.5 \pm 1.7_{-2.3}^{+1.7}$ mb.

In our model, the cross-section for one gluon exchange, is given, to leading order, by⁸

$$\sigma_1^{(2)} = \phi_2 \otimes \phi_2 = g^4 \frac{N^2}{N^2 - 1} \int \frac{d^2 \mathbf{k}}{(2\pi)^2 k^4} n^2(k)$$

In this case, we can neglect the higher order contribution, $\sigma_1^{(4)}$ since σ_1 is the *inclusive* cross-section for one scattering.

We can now determine the cross-section for double scattering via $\sigma_2 = 2\sigma_0$ and

$$\begin{aligned} \sigma_0 &= \frac{1}{4} \phi_4 \otimes \phi_4 = \frac{g^8}{4} \left(\frac{N^2}{N^2 - 1} \right)^2 \times \\ &\int [f_4(\mathbf{p}_1 + \mathbf{r}, -\mathbf{p}_1; \mathbf{p}_2 - \mathbf{r}, -\mathbf{p}_2)]^2 \frac{d^2 \mathbf{p}_1}{(2\pi)^2 (\mathbf{p}_1 + \mathbf{r})^2 p_1^2} \frac{d^2 \mathbf{p}_2}{(2\pi)^2 (\mathbf{p}_2 - \mathbf{r})^2 p_2^2} \frac{d^2 \mathbf{r}}{(2\pi)^2} \end{aligned} \quad (30)$$

where we have made the substitution in eq. (26). With the assumption that p_1 and p_2 are much larger than r , we can make the approximation in eq. (25)

$$\begin{aligned} \sigma_0 &= \frac{g^8}{4} \left(\frac{N^2}{N^2 - 1} \right)^2 \int n^2(p_1) n^2(p_2) P^2(r) \frac{d^2 \mathbf{p}_1}{(2\pi)^2 p_1^4} \frac{d^2 \mathbf{p}_2}{(2\pi)^2 p_2^4} \frac{d^2 \mathbf{r}}{(2\pi)^2} \\ &= \frac{1}{4} \sigma_1^2 \int P^2(r) \frac{d^2 \mathbf{r}}{(2\pi)^2} \end{aligned} \quad (31)$$

This leads to the simple relation

$$\sigma_{\text{eff}} = \frac{1}{2} \frac{\sigma_1^2}{\sigma_2} = \frac{1}{4} \frac{\sigma_1^2}{\sigma_0} = \frac{1}{\int P^2(r) \frac{d^2 r}{(2\pi)^2}} \quad (32)$$

and it gives us the second relation, for the determination of a

$$\frac{1}{\sigma_{\text{eff}}} = \int P^2(r) \frac{d^2 r}{(2\pi)^2} = \frac{a^2}{4\pi b} \quad (33)$$

⁸We have simplified the notation considerably by suppressing dependencies on the longitudinal variables. The final result is not affected by this.

From Eqs. (33) and (29), and with the values $b \approx 15 \text{ GeV}^{-2}$ and $\sigma_{\text{eff}} \approx 15 \text{ mb} \approx 37 \text{ GeV}^{-2}$ we get $a \approx 2.3$, and the normalization factor

$$\mathcal{N} = \frac{1}{\sqrt{\pi b \sigma_{\text{eff}}}} \approx 0.024 \text{ GeV}^2$$

Now, we have everything we need for the calculation of the relative effect of double gluon exchange, on the distribution of the momentum transfer in γ^* -proton scattering.

5 Numerical results for the momentum-transfer

In this section, we will present some numerical results from the model for double gluon exchange, that we have developed. We will consider γ^* -proton scattering, and make an estimate of the relative effects from double gluon exchange, on the distribution of transverse momentum, that is exchanged between the proton and the quark pair that originates from the virtual photon.

More specifically, we will make an estimate of the function

$$\Delta(p_{\perp}^2) \equiv \left(\frac{d\sigma_2}{dp_{\perp}^2} + \frac{d\sigma_1^{(4)}}{dp_{\perp}^2} \right) / \frac{d\sigma_1^{(2)}}{dp_{\perp}^2} \quad (34)$$

We will now write the formulas for the three differential cross-sections in detail. For the $\mathcal{O}(\alpha_s^2)$ contribution to one gluon exchange, we have, from Eqs. (5) and (14)

$$\frac{d\sigma_1^{(2)}}{dp_{\perp}^2} = 4N\pi\alpha_s^2 D_2(p_{\perp}) \frac{1}{p_{\perp}^4} n(p_{\perp}) \quad (35)$$

For the contribution from double gluon exchange, we get from eq. (12) and the substitution in eq. (26)

$$\begin{aligned} \frac{d\sigma_2}{dp_{\perp}^2} &= \frac{\pi}{4} g^8 N \frac{1}{(2\pi)^6} \int \frac{d^2\mathbf{p}_1}{(\mathbf{p}_1 + \mathbf{r})^2 p_1^2} \frac{d^2\mathbf{p}_2}{(\mathbf{p}_2 - \mathbf{r})^2 p_2^2} d^2\mathbf{r} \delta(\mathbf{p}_1 + \mathbf{p}_2 - \mathbf{p}_{\perp}) \times \\ &\times f_4(\mathbf{p}_1 + \mathbf{r}, -\mathbf{p}_1; \mathbf{p}_2 - \mathbf{r}, -\mathbf{p}_2) D_{(4;0)}^{(+)}(\mathbf{p}_1 + \mathbf{r}, -\mathbf{p}_1, \mathbf{p}_2 - \mathbf{r}, -\mathbf{p}_2) \\ &\approx 4N\pi\alpha_s^4 \frac{\mathcal{N}}{p_{\perp}^4} \int \frac{d^2\mathbf{p}_1}{p_1^4} \frac{p_{\perp}^4}{(\mathbf{p}_{\perp} - \mathbf{p}_1)^4} n(p_1) n(\mathbf{p}_{\perp} - \mathbf{p}_1) \times \\ &\times D_{(4;0)}^{(+)}(\mathbf{p}_1, -\mathbf{p}_1, \mathbf{p}_{\perp} - \mathbf{p}_1, \mathbf{p}_1 - \mathbf{p}_{\perp}) \end{aligned} \quad (36)$$

where we have made the approximation in eq. (25) and used the definition in eq. (27). The normalization constant has the value $\mathcal{N} \approx 0.024 \text{ GeV}^2$. In the same

way, we can write for the $\mathcal{O}(\alpha_s^4)$ correction to the single gluon process⁹ eq. (13)

$$\begin{aligned} \frac{d\sigma_1^{(4)}}{dp_\perp^2} &= -\frac{\pi}{2}g^8N\frac{1}{(2\pi)^6}\int\frac{d^2\mathbf{p}_1}{(\mathbf{p}_1+\mathbf{r})^2p_1^2}\frac{d^2p_2}{(\mathbf{p}_2-\mathbf{r})^2p_2^2}d^2\mathbf{r}\delta(\mathbf{p}_1-\mathbf{p}_\perp)\times \\ &\times f_4(\mathbf{p}_1+\mathbf{r},-\mathbf{p}_1;\mathbf{p}_2-\mathbf{r},-\mathbf{p}_2)D_{(4;0)}^{(+)}(\mathbf{p}_1+\mathbf{r},-\mathbf{p}_1,\mathbf{p}_2-\mathbf{r},-\mathbf{p}_2) \\ &\approx -8N\pi\alpha_s^4\frac{\mathcal{N}}{p_\perp^4}\int\frac{d^2\mathbf{p}_2}{p_2^4}n(p_\perp)n(p_2)D_{(4;0)}^{(+)}(\mathbf{p}_\perp,-\mathbf{p}_\perp,\mathbf{p}_2,-\mathbf{p}_2) \end{aligned} \quad (37)$$

With the relation

$$D_{(4;0)}^{(+)}(\mathbf{p}_1,-\mathbf{p}_1,\mathbf{p}_2,-\mathbf{p}_2)=2D_{(2;0)}(\mathbf{p}_1)+2D_{(2;0)}(\mathbf{p}_2)-D_{(2;0)}(\mathbf{p}_1+\mathbf{p}_2)-D_{(2;0)}(\mathbf{p}_1-\mathbf{p}_2)$$

derived from the Eqs. (2), (7) and (9), we can, finally, write the result for the correction function, defined in eq. (34)

$$\begin{aligned} \Delta(p_\perp^2) &= \alpha_s^2\mathcal{N}\int\frac{d^2\mathbf{p}_1}{p_1^4}\frac{n(p_1)}{D_{(2;0)}(p_\perp)}\left\{\frac{p_\perp^4}{n(p_\perp)}\frac{n(\mathbf{p}_\perp-\mathbf{p}_1)}{(\mathbf{p}_\perp-\mathbf{p}_1)^4}\times \right. \\ &\times \left[2D_{(2;0)}(\mathbf{p}_1)+2D_{(2;0)}(\mathbf{p}_\perp-\mathbf{p}_1)-D_{(2;0)}(\mathbf{p}_\perp)-D_{(2;0)}(2\mathbf{p}_1-\mathbf{p}_\perp)\right] \\ &\left.-2\left[2D_{(2;0)}(\mathbf{p}_1)+2D_{(2;0)}(\mathbf{p}_\perp)-D_{(2;0)}(\mathbf{p}_\perp+\mathbf{p}_1)-D_{(2;0)}(\mathbf{p}_\perp-\mathbf{p}_1)\right]\right\}. \end{aligned} \quad (38)$$

In Fig. 8, two different estimates of the correction function $\Delta(p_\perp^2)$ are plotted for electron-proton DIS at $x_B = 0.0001$ and $Q^2 = 10 \text{ GeV}^2$. The integration over \mathbf{p}_1 was done numerically. For the two-gluon impact factor $D_{(2;0)}$ (See eq. (3)) the y integration was done analytically, while, for the α dependence, the constant value $\alpha(1-\alpha) = 1/6$ was inserted¹⁰. The larger estimate of Δ in Fig. 8, is given by $\lambda = 0.4$ and a constant coupling $\alpha_s = 0.3$. The smaller estimate is from the choices $\lambda = 0.3$ and $\alpha_s = 0.2$.

The lower choice for the coupling, corresponds to a scale of the order 20 GeV^2 . Though we are interested in the distribution at rather large p_\perp values, it seems likely that the correction to the p_\perp -distribution is mainly due to an additional rather soft gluon, with a transverse momentum of the order 1 GeV^2 . In case, this is the correct scale as the argument of α_s for the second gluon, the larger value for the coupling, would be more appropriate.

We see in fig. (8) that the correction function has its maximum at around 15 GeV^2 with the maximal corrections of 6 % and 23 %, respectively, in the two estimates. Towards higher p_\perp values, the correction decreases, but continues to be positive.

⁹This is by no means all of the $\mathcal{O}(\alpha_s^4)$ corrections to the one gluon exchange process (Not even, in the asymptotic limit). The idea is that, it is all of the $\mathcal{O}(\alpha_s^4)$ correction, in the asymptotic limit, which is proportional to n^2 .

¹⁰The average value of $\alpha(1-\alpha)$ in the range $[0 : 1]$. This is, of course, an approximation.

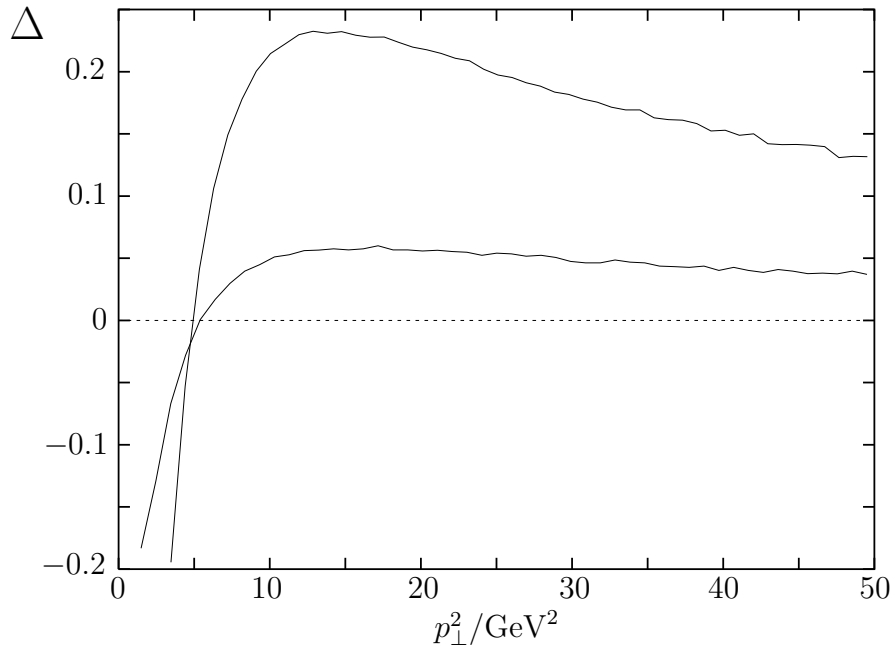

Figure 8: Upper and lower estimates for the correction function $\Delta(p_{\perp}^2)$, (Eq. (34)).

For the low p_{\perp} values, there is a large negative correction. In this region, the correction from three-gluon exchange should be positive. In the case that the negative corrections in this region are large (At the order of one, or greater) they could not be trusted since the positive correction from three gluon exchange would also be large. When it comes to the negative corrections in the low- p_{\perp} region, one is, for any treatment with a fixed number of exchanged gluons, always dependent on some kind of lower cut-off.

These negative corrections, at the order of one, are however, a signal for an interesting phenomenon that have been expected from other models (See e.g. [26]), namely, saturation in the transverse momentum distribution. If multiple gluon exchange to all orders, are taken into account, one expects that the, p_{\perp} -distribution, which is peaked at zero for one gluon exchange, will instead become flat below a lower limit, Λ . One can make the interpretation, that the density of gluons is so large, in this region, so that in almost every scattering event, at least one of them is absorbed by the quarks. The limit, Λ , is expected to grow, towards lower x_B -values [26].

We will now list the main approximations that have been used and that can affect our result for the p_{\perp} distribution. The severity of each of these approximations is estimated by the factor, ρ , that the (positive) maximal value of the correction function, Δ is changed, if we would do the approximation, in another, but still reasonable way. In this respect, we will refer the lower estimate as the "Default"

choice (See Table 1.).

There are three entities that are directly proportional to the final result. These are the normalisation factor \mathcal{N} , the square of the coupling constant α_s^2 and the number of resolved partons $n(k)$.

For the normalisation factor, \mathcal{N} , the experimental uncertainty in σ_{eff} of about 10 %, will result in the same relative error in Δ . An error, perhaps equally important, should arise from our simple physical assumptions in the determination of \mathcal{N} . Further, the two choices of $\alpha_s = 0.2$ and $\alpha_s = 0.3$ give a relative factor $\rho = 2.25$.

The discussion of errors on the number of partons $n(k)$ is more involved, but important. From Eqs. (15) and (16), one can see that there are three parameters that determine $n(k)$. These are the exponent λ , the gluon density at $x_p = 0.1$ (This was set to 2) and the scale at which, coherence effects in the proton sets in, $\mu^2 = 0.1 \text{ GeV}^2$.

The scale μ^2 has rather small effects on the maximal (positive) value of Δ . An increase to the value $\mu^2 = 0.5 \text{ GeV}^2$, reduced the maximal positive correction from $\sim 6\%$ to $\sim 4\%$ ($\rho = 0.67$). The maximum was shifted to larger p_\perp values, with approximately 5 GeV^2 .

For the dependence on λ , by changing the value from 0.3 to 0.4, the number of resolved gluons, in the low- k^2 region is more than doubled (See Fig. 7). This results in an doubling of the maximal correction, that is $\rho = 2$.

There is another uncertainty on our gluon density $n(k)$, which is related to the fact that we have used a formalism which is valid in the asymptotic $s \rightarrow \infty$ limit. In the derivation of $n(k)$, we introduced the lower limit $\hat{x}(k^2)$, for the momentum fraction, that a resolved gluon could have. This limit was derived from a local invariant energy squared \hat{s} and we required, for the exchanged gluon that $k^2 < \hat{s}/4$. One should expect that, compared to the asymptotic result, there is a suppression also, in a range below this value (In the case of time-like cascades, see e.g. [27]). To estimate the significance of this approximation, the function $n(k)$ was reevaluated with the limit $k^2 < \hat{s}/8$. This lead to a reduction of $n(k)$ of about 20 %, over the whole range, except for p_\perp values below 2 GeV^2 , where n was not changed. In this region, the limit \hat{x} is insignificant because it becomes smaller than x_B . The effect on the correction function Δ , was that it had the same shape and maximal value, but was shifted to lower p_\perp values, a distance of 5 GeV^2 . So, in this case, we had $\rho = 1$.

It might be interesting to check how the maximal value of the correction, Δ , varies with the values of x_B and Q^2 . Therefore, separate runs were made for $(x_B, Q^2) = (10^{-3}, 10 \text{ GeV}^2)$, $(10^{-5}, 10 \text{ GeV}^2)$, $(10^{-4}, 20 \text{ GeV}^2)$ and $(10^{-4}, 5 \text{ GeV}^2)$ (See Table 1 for the results for ρ). The conclusion is that the effect of double gluon exchange increases rapidly towards, lower values of both x_B and Q^2 . Another observation

from these runs is that the maximum always occurred at p_{\perp}^2 values slightly above Q^2 . The Q^2 -dependence of the maximal correction, seems to be consistent with the expectation that multiple interactions is a higher twist effect. A $1/Q^2$ -behaviour could also be explained by the fact that Δ is dimension less, but proportional to \mathcal{N} which has the dimension [energy]². (The dependence on μ^2 was observed above to be weak, perhaps logarithmic.).

Entity	Alternative procedure (Default)	ρ
\mathcal{N}	[Experimental errors]	$\pm 10\%$
\mathcal{N}	[Theory assumptions]	$\pm 10\%$
α_s	Set to 0.3 (0.2)	2.25
n	$\mu^2 = 0.5 \text{ GeV}^2$ (0.1 GeV^2)	0.67
n	$\lambda = 0.4$ ($\lambda = 0.3$)	2
n	\hat{x} determined by $k^2 < \hat{s}/8$ ($k^2 < \hat{s}/4$)	1
x_B	10^{-5} (10^{-4})	1.9
x_B	10^{-3} (10^{-4})	0.5
Q^2	5 GeV^2 (10 GeV^2)	1.8
Q^2	20 GeV^2 (10 GeV^2)	0.5

Table 1: Estimate of various uncertainties in the final answer. ρ is the relative effect on the maximal correction. In the second part of the table, the dependence on x_B and Q^2 , is displayed.

There have been several measurements and analyses of jet-distributions at HERA, in the region of low x_B and $Q^2 > 1 \text{ GeV}^2$, that is relevant for the discussion here (E.g. [28]). The high- p_{\perp} jet activity, has been described by the definition of jet-rates: The fraction of the cross-section, with a number of jets above some high p_{\perp} -value. There has also been specific studies of the fraction of the photon energy, that is carried in these jets. In this way, one determines if it is more likely that the jet originates from a quark (high energy fraction) or a gluon, which is more likely to be in the proton direction (low fraction of the photon energy).

The result, for the momentum transfer, that has been presented here, can not be directly compared with the measured jet-distributions. The main reason is that the transverse momenta of the quarks was integrated out. It is, of course, not necessary to do this, but the p_{\perp} -distribution of the individual quarks, in the high- p_{\perp} region, is very much dependent on the energy that is available for the quark-anti-quark system. In the leading $\log(s)$ formalism, that we have used, there is no information on this energy (It is assumed to be infinite), and one would have to determine it, by other arguments¹¹.

¹¹This means that we have overestimated the cross-sections, in the treatment above, but this

So far, there has not been any direct measurements of the momentum transfer to the quark pair. In the case of very high momentum transfers, $p_{\perp}^2 > Q^2$, one could, however, be rather certain, that this will lead to two jets, with transverse momenta $\sim p_{\perp}$, originating from one of the quarks, and the gluon which takes the recoil (The largest recoil, in the case of double gluon exchange). The other quark, with a lower transverse momentum, should then be observable as the photon remnant. Our correction to the momentum transfer, would therefore lead to similar corrections (enhancements) in the so called "resolved-photon" events, with high p_{\perp} .

Another interesting observation, that one could perhaps make at HERA, is related to the negative correction, in the region of low momentum transfers. If the saturation limit (Λ above) is sufficiently large, it should be observable in the p_{\perp} -distribution of the quark jets, in a frame were the proton and the photon have zero transverse momentum. This would be possible, only if Λ is large enough, in the region of the lowest x_B -values, available at HERA, so that the effect is not drowned by the hadronisation process. From the larger estimate, above, this saturation should be expected to occur at $\Lambda^2 \sim 2 \text{ GeV}^2$.

6 Summary

We have studied the process of double gluon exchange, in non-diffractive γ^* -proton DIS. A new model was developed, based on previous descriptions of diffractive events, as the perturbative exchange of two gluons, originating from one pomeron [10]. The relation to the non-diffractive process, was determined from a general result from Regge theory: The AGK cutting rules [11]. The validity of this procedure has, however, not been fully proven (In the leading $\log(s)$ expansion, these contributions are next-to-next-to-leading.).

As a first application of the model, we studied the corrections to the transverse momentum transfer to the quark-anti-quark pair, at the photon vertex. We found significant enhancements (At the order of 10%) of the cross-section for large momentum transfers, and large negative corrections, (~ 1) for momentum transfers close to zero. The prediction for the negative corrections is however not reliable, but signals saturation in the transverse momentum distribution, in an all orders (in the number of exchanged gluons), treatment. The possibility of the observation of these effects in the measured jet-distributions at HERA, was discussed.

The results presented here, should be taken as order of magnitude estimates, and a description of the general behaviour. It should be possible to make the model more accurate, in order to make direct comparisons with data. Some of the necessary

error is small inclusively over the quark momenta and should rather well factor out in the relative correction Δ .

improvements, like a new fit of the parton distributions, are straight forward, but involved. The most effective way of doing this would probably be to include the perturbative multiple interaction as a new feature in existing models for DIS.

Acknowledgements

Many people have been kindly helpful with comments and suggestions. Among them are Joachim Bartels, Torbjörn Sjöstrand and Anders Edin.

A consistency check

In section 3, we could make use of the Cutkoski rule since the amplitude for pomeron exchange is purely imaginary to leading order. This is expected for amplitudes which describe the exchange of a symmetric colour state. We will now, with the same method as σ_0 was calculated, calculate the contribution to σ_2 which is due to just the imaginary part of the amplitude for two gluon exchange. For the exchange of symmetric colour states, this is the leading contribution. Consequently, our method should give the correct AGK relation $\sigma_2 : \sigma_0 = 2 : 1$, for the parts of σ_2 which are due to the exchange the symmetric colour states and the corresponding part of σ_0 . The main argument is that both σ_0 and the symmetric part of σ_2 , have their contributions given from the symmetric part, $D^{(+)}(\mathbf{k}_1, \mathbf{k}_2, \mathbf{k}_3, \mathbf{k}_4)$ (Defined in Eqs. (9) and (7)), of the photon impact factor, and that this function is invariant under permutations of its arguments.

To do this, we need the full impact factor of the proton (Fig. 5), whereas, before, we used only the part with one pomeron-proton vertex on each side of the final-state cut. We choose a form which is explicitly symmetric in the simultaneous exchange of the colour and momentum of any two gluons.

$$\begin{aligned} \phi_4^{a_1 a_2 a_3 a_4}(\mathbf{k}_1, \mathbf{k}_2, \mathbf{k}_3, \mathbf{k}_4) &= & (39) \\ \phi_{4(\mathcal{P})}^{a_1 a_2 a_3 a_4}(\mathbf{k}_1, \mathbf{k}_2, \mathbf{k}_3, \mathbf{k}_4) &+ \phi_{4(\mathcal{P})}^{a_1 a_3 a_2 a_4}(\mathbf{k}_1, \mathbf{k}_3, \mathbf{k}_2, \mathbf{k}_4) + \phi_{4(\mathcal{P})}^{a_1 a_4 a_3 a_2}(\mathbf{k}_1, \mathbf{k}_4, \mathbf{k}_3, \mathbf{k}_2) \end{aligned}$$

with $\phi_{4(\mathcal{P})}$ defined in eq. (10).

When the impact factor above is convoluted with the photon's impact factor, we will get three terms, arising from the three terms in ϕ_4 . The first of these is what was discussed before, the cross-section σ_0 , while the sum of the other terms is the contribution to σ_2 . As discussed before, for the contributions to σ_2 which are due to the exchange of symmetric colour states, we can again make use of the multiply cut photon impact factor, but now, convolute it with the second and third terms of ϕ_4 . To do this, we have to make projections into the symmetric colour states.

In the case of σ_2 , we can do this by putting in a symmetry projector on the colours of gluon one and two. This part of the impact factor has already been singled out in eq. (8). We can now see that, in the convolution with the second or third terms of ϕ_4 , we get the same colour factor:

$$d_+^{abcd}\delta_{ac}\delta_{bd} = d_+^{abcd}\delta_{ad}\delta_{bc} = \left(C_f - \frac{1}{2N}\right) NC_f$$

Further, the two terms have the factors

$$D^{(+)}(\mathbf{k}_1, \mathbf{k}_2, \mathbf{k}_3, \mathbf{k}_4) f(\mathbf{k}_1, \mathbf{k}_3; \mathbf{k}_2, \mathbf{k}_4)$$

and

$$D^{(+)}(\mathbf{k}_1, \mathbf{k}_2, \mathbf{k}_3, \mathbf{k}_4) f(\mathbf{k}_1, \mathbf{k}_4; \mathbf{k}_3, \mathbf{k}_2)$$

respectively. Since $D^{(+)}$ is invariant under permutations of the momenta, these two factors are equal to each other (After renumbering) and also equal to the corresponding factor which appears for σ_0 .

The corresponding colour factor for σ_0 is

$$d_+^{abcd}\delta_{ab}\delta_{cd} = 2NC_f^2$$

From the AGK rule, this would mean that the total contribution to σ_2 should have the factor $4NC_f^2$. Above, we have calculated the contribution from the exchange of symmetric colour states. Consequently, the validity of the AGK rule, gives for the anti-symmetric exchange part of σ_2 , that it should come with the same momentum dependence, and with the colour factor

$$4NC_f^2 - 2\left(C_f - \frac{1}{2N}\right) NC_f = N^2 C_f$$

We will now calculate the colour factor for the part of σ_0 which corresponds to the symmetric colour exchange in σ_2 ¹². For σ_0 , the colour symmetry projector should be connected with one gluon from each pomeron, e.g. the gluons 2 and 3 or 1 and 3. There is also a second requirement, namely that the two colour indices that are symmetrised over are directly connected to each other through one quark line. This is the case for the symmetrisation procedure that was used for the σ_2 contribution:

$$d^{a_1 a_2 a_3 a_4} \rightarrow d_+^{a_1 a_2 a_3 a_4} \equiv \frac{1}{2} (d^{a_1 a_2 a_3 a_4} + d^{a_2 a_1 a_3 a_4})$$

The symmetrisation is done over neighbouring sites of the tensor d .

For σ_0 , this can be done in the following way for the first term in Eq. (6)

$$d^{a_1 a_2 a_3 a_4} \rightarrow \frac{1}{2} (d^{a_1 a_2 a_3 a_4} + d^{a_1 a_3 a_2 a_4})$$

¹²It is acknowledged that the exact definition of this procedure is perhaps not known.

and for the second term

$$d^{a_2 a_1 a_3 a_4} \rightarrow \frac{1}{2} (d^{a_2 a_1 a_3 a_4} + d^{a_2 a_3 a_1 a_4})$$

After this procedure, and multiplying with $\delta_{a_1 a_2} \delta_{a_3 a_4}$, we get the same colour factor, $(C_f - 1/2N)NC_f$, also for the σ_0 contribution.

Thus, after the symmetrisations, we get the same contribution to σ_0 from the first term of ϕ_4 , as each of the contributions from the other two terms to σ_2 . That is, the symmetrised contributions satisfy the AGK relation $\sigma_0 : \sigma_2 = 1 : 2$. This result depends on the form of ϕ_4 that has been used, but we have shown that it is possible to choose a form, inspired by an underlying picture of two pomerons that couple in all possible ways, so that the AGK rule is satisfied.

References

- [1] M. Froissart, *Phys. Rep.* **123** (1961) 1053.
- [2] M. Glück, E. Reya, A. Vogt, *Eur. Phys. J.* **C5** (1998) 461;
A.D. Martin, R.G. Roberts, W.J. Stirling, R.S. Thorne, *Eur. Phys. J.* **C14** (2000) 133;
H.L. Lai et al. (CTEQ Collaboration), *Eur. Phys. J.* **C12** (2000) 375;
A.N. Khorramian, F. Arash, *Nucl. Phys.* **B79** (1999) 274 (Proc. Suppl.).
- [3] E. Gotsman, *Nucl. Phys.* **B79** (1999) 192 (Proc. Suppl.);
M. McDermott, L. Frankfurt, V. Guzey, M. Strikman, *hep-ph/9912547*.
- [4] T. Sjöstrand, M. van Zijl, *Phys. Rev.* **D36** (1987) 2019.
- [5] G.J. Alner et. al. (UA5 Collaboration), *Phys. Lett.* **B138** (1984) 304.
- [6] T. Åkesson et al. (AFS Collaboration), *Z. Phys.* **C34** (1987) 163;
J. Alitti et al. (UA2 Collaboration), *Phys. Lett.* **B268** (1991) 145;
F. Abe et al. (CDF Collaboration), *Phys. Rev.* **D47** (1993) 4857.
- [7] F. Abe et al. (CDF Collaboration), *Phys. Rev. Lett.* **79** (1997) 584; *Phys. Rev.* **D56** (1997) 3811.
- [8] G. Schuler, T. Sjöstrand, *Phys. Lett.* **B300** (1993) 169; *Nucl. Phys.* **B407** (1993) 539;
J.M. Butterworth, J.R. Forshaw, *J. Phys.* **G19** (1993) 1657;
J.M. Butterworth, J.R. Forshaw, M.H. Seymour, *Z. Phys.* **C72** (1996) 637.
- [9] J. Breitweg et al., (ZEUS Collaboration), *Eur. Phys. J.* **C1** (1998) 109.
- [10] A. Donnachie, P.V. Landshoff, *Nucl. Phys.* **B244** (1984) 322; *Nucl. Phys.* **B303** (1988) 634;
N. Nikolaev, B.G. Zakharov, *Z. Phys.* **C53** (1992) 331;
M. Diehl, *Z. Phys.* **C66** (1995) 181;
J. Bartels, M. Wüsthoff, *J. Phys.* **G22** (1996) 929.

- [11] V.A. Abramovski, V.N. Gribov, O.V. Kancheli, *Yad. Fiz.* **18** (1973) 595, *Sov. J. Nucl. Phys.* **18** (1974) 308.
- [12] R. Baier, Yu.L. Dokshitzer, S. Peigne, D. Schiff, *Phys. Lett.* **B345** (1995) 277; J. Knoll, D.N. Voskresenskii, *Phys. Lett.* **B351** (1995) 43; R. Baier, Yu.L. Dokshitzer, A.H. Mueller, D. Schiff, *Nucl. Phys.* **B531** (1998) 403; *Nucl. Phys.* **B484** (1997) 265; R. Baier, D. Schiff, B.G. Zakharov, *hep-ph/0002198*.
- [13] B.G. Zakharov, *JETP Lett.* **70** (1999) 176.
- [14] E.A. Kuraev, L.N. Lipatov and V.S. Fadin, *Zh. Eksp. Teor. Fiz.* **72** (1977) 373, *Sov. Phys. JETP* **45** (1977) 199; Ya.Ya. Balitsky and L.N. Lipatov, *Yad. Fiz.* **28** (1978) 1597, *Sov. J. Nucl. Phys.* **28** (1978) 822.
- [15] B. Andersson, G. Gustafson, J. Samuelsson, *Nucl. Phys.* **B467** (1996) 443.
- [16] M. Ciafaloni, D. Colferai, G. Salam, *Phys. Rev.* **D60** (1999) 114036.
- [17] R.E. Cutkosky, *J. Math. Phys.* **1** (1960) 429.
- [18] J. Bartels, M.G. Ryskin, *Z. Phys.* **C76** (1997) 241.
- [19] L.V. Gribov, E.M. Levin, M.G. Ryskin, *Phys. Rep.* **100** (1983) 1.
- [20] J. Bartels, *Z. Phys.* **C60** (1993) 471.
- [21] A.H. Mueller, *Nucl. Phys.* **B335** (1990) 115; E.M. Levin, M.G. Ryskin, *Yad. Fiz.* **53** (1991) 1052, *Sov. J. Nucl. Phys.* **53** (1991) 653.
- [22] A. Edin, G. Ingelman, J. Rathsman, *Phys. Lett.* **B366** (1996) 371; *Z. Phys.* **C75** (1997) 57.
- [23] K. Golec-Biernat, M. Wüsthoff, *Phys. Rev.* **D59** (1999) 014017.
- [24] K. Golec-Biernat, M. Wüsthoff, *Phys. Rev.* **D60** (1999) 114023.
- [25] M. Bozzo, et al. (UA4 Collaboration), *Phys. Lett.* **B147** (1984) 385.
- [26] L. McLerran, *hep-ph/9903536*.
- [27] G. Gustafson, *Nucl. Phys.* **B392** (1993) 251.
- [28] C. Adloff et al. (H1 Collaboration), *hep-ex/9806029*; *hep-ex/9812024*; J. Breitweg et al., (ZEUS Collaboration), *Phys. Lett.* **B474** (2000) 223; *hep-ex/0002010*.