

Solving non-uniqueness in agglomerative hierarchical clustering using multidendrograms

Alberto Fernández and Sergio Gómez

Universitat Rovira i Virgili, Tarragona, Spain

Summary. In agglomerative hierarchical clustering, pair-group methods suffer from a problem of non-uniqueness when two or more distances between different clusters coincide during the amalgamation process. The traditional approach for solving this drawback has been to take any arbitrary criterion in order to break ties between distances, which results in different hierarchical classifications depending on the criterion followed. In this article we propose a variable-group algorithm that consists in grouping more than two clusters at the same time when ties occur. We give a tree representation for the results of the algorithm, which we call a *multidendrogram*, as well as a generalisation of the Lance and Williams' formula which enables the implementation of the algorithm in a recursive way.

Keywords: Agglomerative methods; Cluster analysis; Dendrograms; Hierarchical classification; Lance and Williams' formula; Ties in proximity

1. Introduction

Clustering methods group individuals into groups of individuals or *clusters*, so that individuals in a cluster are close to one another. In agglomerative hierarchical clustering (see e.g. Cormack (1971); Sneath and Sokal (1973), section 5.5; Gordon (1999), chapter 4), one begins with a proximity matrix between individuals, each one forming a singleton cluster. Then, clusters are themselves grouped into groups of clusters or *superclusters*, the process being repeated until a complete hierarchy is formed. Among the different types of agglomerative methods we find single linkage, complete linkage, unweighted average, weighted average, etc., which differ in the definition of the proximity measure between clusters.

Except for the single linkage case, all the other clustering techniques suffer from a non-uniqueness problem, sometimes called the *ties in proximity* problem, which is caused by ties either occurring in the initial proximity data or arising during the amalgamation process. Some clustering methods like complete linkage are more susceptible than others to encounter ties during the clustering process, since they do not originate new proximity values different from the initial ones. With regard to the presence of ties in the original data, they are more frequent when one works with binary variables, but they can also appear using continuous variables, specially if the precision of experimental data is low. Sometimes, on the contrary, the absence of ties might be due to the representation of data with more decimal digits than it should be done. Moreover, in general, the larger the data set, the more ties arise (MacCuish et al. (2001)).

Address for correspondence: Sergio Gómez, Departament d'Enginyeria Informàtica i Matemàtiques, Universitat Rovira i Virgili, Campus Sescelades, Avinguda dels Països Catalans 26, E-43007 Tarragona, Spain.
E-mail: sergio.gomez@urv.cat

The ties in proximity problem is well-known from several studies in different fields, for example in biology (Hart (1983); Backeljau et al. (1996); Arnau et al. (2005)), in psychology (Van der Kloot et al. (2005)), or in chemistry (MacCuish et al. (2001)). Nevertheless, this problem is frequently ignored in software packages (Morgan and Ray (1995); Backeljau et al. (1996); Van der Kloot et al. (2005)), and those packages which do not ignore it fail to adopt a common standard with respect to ties. Many of them simply break the ties in any arbitrary way, thus producing a single hierarchy. In some cases the analysis is repeated a given number of times with randomised input data order, and then additional criteria can be used for selecting one of the possible solutions (see e.g. Arnau et al. (2005)). In other cases, some requirements are given on the number of individuals and the number of characteristics needed to generate proximity data without ties (Hart (1983); MacCuish et al. (2001)). None of these proposals can ensure the complete absence of ties, neither can all their requirements be satisfied always. In ill conditioned problems (those susceptible to the occurrence of too many ties), it is unfeasible to perform an exhaustive search for all possible hierarchical classifications, due to its high computational cost. With regard to this, Van der Kloot et al. (2005) analyse two data sets using lots of random permutations of the input data order, and with additional criteria they evaluate the “quality” of each solution. They show that the “best” solutions frequently emerge after many permutations, and they also notice that the goodness of these solutions necessarily depends on the number of permutations used.

What we propose in this article is an agglomerative hierarchical clustering algorithm that solves the ties in proximity problem by considering simultaneously all the clusters that fall into a tie. In order to do so we must be able to calculate the distance separating any two superclusters, hence we have generalised the definition of distance between clusters to the superclusters case, for the most commonly used agglomerative hierarchical clustering techniques. We also give the corresponding generalisation of Lance and Williams’ formula, which enables us to compute these distances in a recursive way. Moreover, we introduce a new tree representation for the results obtained with the agglomerative algorithm: the multidendrogram.

In Section 2 we introduce our proposal of clustering algorithm and the multidendrogram representation for the results. Section 3 gives the corresponding generalisation of some hierarchical clustering strategies. In section 4, Lance and Williams’ formula is also generalised consistently with the new proposal. Section 5 shows some results corresponding to data from a real example, and we finish with some conclusions in Section 6.

2. Agglomerative hierarchical algorithm

2.1. Pair-group approach

Agglomerative hierarchical procedures build a hierarchical classification in a bottom-up way, from a proximity matrix containing dissimilarity data between individuals of a set $\Omega = \{x_1, x_2, \dots, x_n\}$ (the same analysis could be done using similarity data). Initially each individual x_i forms a singleton cluster $\{x_i\}$. Then, at each iteration of the process, a pair of clusters separated by the shortest distance are amalgamated to form a new cluster (supercluster), and the distances between the new cluster and the rest of the clusters are computed. Amalgamation of the closest pair of clusters continues until all the individuals belong to a single cluster. Following Sneath and Sokal (1973), this type of approach is known as a *pair-group* method, in opposition to *variable-group* methods which will be discussed in

the next subsection. The corresponding algorithm has the following steps:

- 0) Initialise n singleton clusters with one individual in each of them: $\{x_1\}, \{x_2\}, \dots, \{x_n\}$. Initialise also the distances between clusters, $D(\{x_i\}, \{x_j\})$, with the values of the distances between individuals, $d(x_i, x_j)$:

$$D(\{x_i\}, \{x_j\}) = d(x_i, x_j) \quad \forall i, j = 1, 2, \dots, n.$$

- 1) Find the shortest distance separating two different clusters.
- 2) Select two clusters X_i and $X_{i'}$ separated by such shortest distance and merge them into a new supercluster $X_i \cup X_{i'}$.
- 3) Compute the distances $D(X_i \cup X_{i'}, X_j)$ between the new supercluster $X_i \cup X_{i'}$ and each of the other clusters X_j .
- 4) If all individuals are not in a single cluster yet, then go back to step 1.

Depending on the criterion used for the calculation of distances in step 3, we can implement different agglomerative hierarchical methods. In this article we study some of the most commonly used ones, which are: single linkage, complete linkage, unweighted average, weighted average, unweighted centroid, weighted centroid and joint between-within. The problem of non-uniqueness may arise at step 2 of the algorithm, when two or more pairs of clusters are separated by the shortest distance value (i.e., the shortest distance is tied). Every choice for breaking ties may have important consequences, because it changes the collection of clusters and the distances between them, possibly resulting in different hierarchical classifications. It must be noted here that not all tied distances will produce ambiguity: they also have to be the shortest ones. On the other hand, ambiguity is not limited to cases with ties in the original proximity values, but ties may arise during the clustering process too.

The use of any hierarchical clustering technique on a finite set Ω with n individuals results in an n -tree on Ω , which is defined as a subset T of parts of Ω satisfying the following conditions:

- (i) $\Omega \in T$
- (ii) $\emptyset \notin T$
- (iii) $\forall x \in \Omega \quad \{x\} \in T$
- (iv) $\forall X, Y \in T \quad (X \cap Y = \emptyset \quad \vee \quad X \subseteq Y \quad \vee \quad Y \subseteq X)$.

An n -tree gives only the hierarchical structure of a classification, but the use of a hierarchical clustering technique also associates a height h with each of the clusters obtained. All this information is gathered in the definition of a *valued tree* on Ω , which is a pair (T, h) where T is an n -tree on Ω and $h : T \rightarrow \mathbb{R}$ is a function such that $\forall X, Y \in T$:

- (i) $h(X) \geq 0$
- (ii) $h(X) = 0 \iff |X| = 1$
- (iii) $X \subsetneq Y \implies h(X) < h(Y)$,

where $|X|$ denotes the cardinality of X .

For example, suppose that we have a graph with four individuals like that of Fig. 1, where the initial distance between any two individuals is the value of the shortest path connecting them. This means, for example, that the initial distance between x_2 and x_4 is equal to 5.

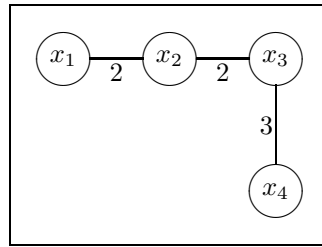

Fig. 1. Toy graph with four individuals and shortest path distances

Using the unweighted average criterion, we can obtain three different valued trees. The graphical representation of valued trees are the so called *dendrograms*, and Fig. 2 shows the three corresponding dendrograms obtained for our toy graph. The first two dendrograms are quite similar, but the third one shows a considerably different hierarchical structure. Hence, if the third dendrogram is the only one obtained by a software package, one could extract from it the wrong conclusion that x_3 is closer to x_4 than it is to x_2 .

2.2. Variable-group proposal: multidendrograms

Any decision taken to break ties in the toy graph of Fig. 1 would be arbitrary. In fact, the use of an unfortunate rule might lead us to the worst dendrogram of the three. A logical solution to the pair-group criterion problem might be to assign the same importance to all tied distances and, therefore, to use a variable-group criterion. In our example of Fig. 1 this means the amalgamation of individuals x_1 , x_2 and x_3 in a single cluster at the same time. The immediate consequence is that we have to calculate the distance between the new cluster $\{x_1\} \cup \{x_2\} \cup \{x_3\}$ and the cluster $\{x_4\}$. In the unweighted average case this distance is equal to 5, that is, the arithmetic mean among the values 7, 5 and 3, corresponding respectively to the distances $D(\{x_1\}, \{x_4\})$, $D(\{x_2\}, \{x_4\})$ and $D(\{x_3\}, \{x_4\})$. We must also decide at which height are to be amalgamated x_1 , x_2 and x_3 into the new cluster, which could be any value between the minimum and the maximum distances that separate any two of them. In this case the minimum distance is 2 and corresponds to both of the tied distances $D(\{x_1\}, \{x_2\})$ and $D(\{x_2\}, \{x_3\})$, whilst the maximum distance is the one separating x_1 from x_3 and it is equal to 4.

Following the variable-group criterion on a finite set Ω with n individuals, we no longer get several valued trees, but we obtain a unique tree which we call a *multivalued tree* on Ω ,

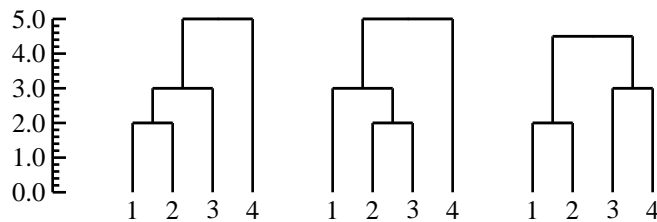

Fig. 2. Unweighted average dendrograms for the toy example

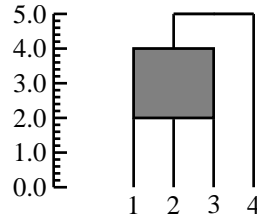

Fig. 3. Unweighted average multidendrogram for the toy example

and we define it as a triplet (T, h_l, h_u) where T is an n -tree on Ω and $h_l, h_u : T \rightarrow \mathbb{R}$ are two functions such that $\forall X, Y \in T$:

- (i) $0 \leq h_l(X) \leq h_u(X)$
- (ii) $h_l(X) = 0 \iff h_u(X) = 0 \iff |X| = 1$
- (iii) $X \subsetneq Y \implies [h_l(X) < h_l(Y) \wedge h_u(X) \leq h_l(Y)]$.

A multivalued tree associates with every cluster X in the hierarchical classification two height values, $h_l(X)$ and $h_u(X)$, corresponding respectively to the lower and upper bounds at which member individuals can be merged into cluster X . When $h_l(X)$ and $h_u(X)$ coincide for every cluster X , the multivalued tree is just a valued tree. But, when there is any cluster X for which $h_l(X) < h_u(X)$, it is like having multiple valued trees because every selection of a height $h(X)$ inside the interval $[h_l(X), h_u(X)]$ corresponds to a different valued tree. We also introduce here the concept of *multidendrogram* to refer to the graphical representation of a multivalued tree. In Fig. 3 we show the corresponding multidendrogram for the toy example. The shadowed region between heights 2 and 4 refers to the interval between the respective values of h_l and h_u for cluster $\{x_1\} \cup \{x_2\} \cup \{x_3\}$, which in turn also correspond to the minimum and maximum distances separating any two of the constituent clusters $\{x_1\}$, $\{x_2\}$ and $\{x_3\}$.

Let us consider the situation shown in Fig. 4, where nine different clusters are to be grouped into superclusters. The clusters to be amalgamated should be those separated by the shortest distance. The picture shows the edges connecting clusters separated by such shortest distance, so we observe that there are six pairs of clusters separated by shortest edges. A pair-group clustering algorithm typically would select any of these pairs, for instance (X_8, X_9) , and then it would compute the distance between the new supercluster $X_8 \cup X_9$ and the rest of the clusters X_i , for all $i \in \{1, 2, \dots, 7\}$. What we propose here is to follow a variable-group criterion and create as many superclusters as groups of clusters connected by shortest edges. In Fig. 4, for instance, the nine initial clusters would be grouped into the four following superclusters: X_1 , $X_2 \cup X_3$, $X_4 \cup X_5 \cup X_6$ and $X_7 \cup X_8 \cup X_9$. Then, all the pairwise distances between the four superclusters should be computed. In general, we must be able to compute distances $D(X_I, X_J)$ between any two superclusters $X_I = \bigcup_{i \in I} X_i$ and $X_J = \bigcup_{j \in J} X_j$, each one of them made up of several clusters indexed by $I = \{i_1, i_2, \dots, i_p\}$ and $J = \{j_1, j_2, \dots, j_q\}$, respectively.

The algorithm that we propose in order to ensure uniqueness in agglomerative hierarchical clustering has the following steps:

- 0) Initialise n singleton clusters with one individual in each of them: $\{x_1\}, \{x_2\}, \dots, \{x_n\}$. Initialise also the distances between clusters, $D(\{x_i\}, \{x_j\})$, with the values of

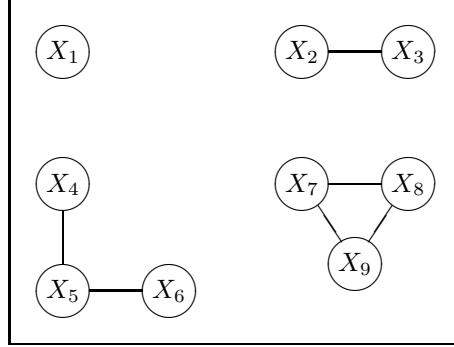

Fig. 4. Simultaneous occurrence of different superclusters

the distances between individuals, $d(x_i, x_j)$:

$$D(\{x_i\}, \{x_j\}) = d(x_i, x_j) \quad \forall i, j = 1, 2, \dots, n.$$

- 1) Find the shortest distance separating two different clusters, and record it as D_{lower} .
- 2) Select all the groups of clusters separated by shortest distance D_{lower} and merge them into several new superclusters X_I . The result of this step can be some superclusters made up of just one single cluster ($|I| = 1$), as well as some superclusters made up of various clusters ($|I| > 1$). Notice that the latter superclusters all must satisfy the condition $D_{min}(X_I) = D_{lower}$, where

$$D_{min}(X_I) = \min_{i \in I} \min_{\substack{i' \in I \\ i' \neq i}} D(X_i, X_{i'}).$$

- 3) Update the distances between clusters following the next substeps:
 - 3.1) Compute the distances $D(X_I, X_J)$ between superclusters, and record the minimum of them as D_{next} (this will be the shortest distance D_{lower} in the next iteration of the algorithm).
 - 3.2) For each supercluster X_I made up of various clusters ($|I| > 1$), assign a common amalgamation interval $[D_{lower}, D_{upper}]$ for all its constituent clusters $X_i, i \in I$, where

$$D_{upper} = \min\{D_{max}(X_I), D_{next}\}$$

and

$$D_{max}(X_I) = \max_{i \in I} \max_{\substack{i' \in I \\ i' \neq i}} D(X_i, X_{i'}).$$

- 4) If all individuals are not in a single cluster yet, then go back to step 1.

The recording of D_{next} in substep 3.1 and its ulterior use in 3.2 is necessary in order to prevent the appearance of *reversals*. Let us remember that a reversal arises in a valued tree when it contains at least two clusters X and Y for which $X \subset Y$ but $h(X) > h(Y)$ (see Morgan and Ray (1995) for examples of reversals in dendrograms). From the methods considered in this article, only the centroid ones (weighted and unweighted) may produce reversals. Hence, except for these two methods, the appearance of reversals in the resulting hierarchical classifications is also prevented with the use of this algorithm.

3. Generalisation of agglomerative hierarchical clustering methods

In the variable-group clustering algorithm previously proposed we have seen the necessity of agglomerating simultaneously two families of clusters, respectively indexed by $I = \{i_1, i_2, \dots, i_p\}$ and $J = \{j_1, j_2, \dots, j_q\}$, into two superclusters $X_I = \bigcup_{i \in I} X_i$ and $X_J = \bigcup_{j \in J} X_j$. In the following subsections we derive, for each of the most commonly used agglomerative hierarchical clustering strategies, the distance between the two superclusters, $D(X_I, X_J)$, in terms of the distances between the respective component clusters, $D(X_i, X_j)$.

3.1. Single linkage

In *single linkage* clustering, also called *nearest neighbour* or *minimum* method, the distance between two clusters X_i and X_j is defined as the distance between the closest pair of individuals, one in each cluster:

$$D(X_i, X_j) = \min_{x \in X_i} \min_{y \in X_j} d(x, y). \quad (1)$$

This means that the distance between two superclusters X_I and X_J can be defined as

$$D(X_I, X_J) = \min_{x \in X_I} \min_{y \in X_J} d(x, y) = \min_{i \in I} \min_{x \in X_i} \min_{j \in J} \min_{y \in X_j} d(x, y). \quad (2)$$

Notice that this formulation generalises the definition of distance between clusters in the sense that equation (1) is recovered from equation (2) when $|I| = |J| = 1$, that is, when superclusters I and J are both composed of a single cluster. Grouping terms and using the definition in equation (1), we get the equivalent definition:

$$D(X_I, X_J) = \min_{i \in I} \min_{j \in J} D(X_i, X_j). \quad (3)$$

3.2. Complete linkage

In *complete linkage* clustering, also known as *furthest neighbour* or *maximum* method, cluster distance is defined as the distance between the most remote pair of individuals, one in each cluster:

$$D(X_i, X_j) = \max_{x \in X_i} \max_{y \in X_j} d(x, y). \quad (4)$$

Starting from equation (4) and following the same reasoning as in the single linkage case, we extend the definition of distance to the superclusters case as

$$D(X_I, X_J) = \max_{i \in I} \max_{j \in J} D(X_i, X_j). \quad (5)$$

3.3. Unweighted average

Unweighted average clustering, also known as *group average* method or *UPGMA* (Unweighted Pair-Group Method using Averages), iteratively forms clusters made up of pairs of previously formed clusters, based on the arithmetic mean distances between their member individuals. It uses an unweighted averaging procedure, that is, when clusters are joined to form a larger cluster, the distance between this new cluster and any other cluster is

calculated weighting each individual in those clusters equally, regardless of the structural subdivision of the clusters:

$$D(X_i, X_j) = \frac{1}{|X_i||X_j|} \sum_{x \in X_i} \sum_{y \in X_j} d(x, y). \quad (6)$$

When the variable-group strategy is followed, the UPGMA name of the method should be modified to that of *UVGMA* (Unweighted Variable-Group Method using Averages), and the distance definition between superclusters in this case should be

$$D(X_I, X_J) = \frac{1}{|X_I||X_J|} \sum_{x \in X_I} \sum_{y \in X_J} d(x, y) = \frac{1}{|X_I||X_J|} \sum_{i \in I} \sum_{x \in X_i} \sum_{j \in J} \sum_{y \in X_j} d(x, y).$$

Using equation (6), we get the desired definition in terms of the distances between component clusters:

$$D(X_I, X_J) = \frac{1}{|X_I||X_J|} \sum_{i \in I} \sum_{j \in J} |X_i||X_j| D(X_i, X_j). \quad (7)$$

In this case, $|X_I|$ is the number of individuals in supercluster X_I , that is, $|X_I| = \sum_{i \in I} |X_i|$.

3.4. *Weighted average*

In *weighted average* strategy, also called *WVGMA* (Weighted Variable-Group Method using Averages) in substitution of the pair-group name *WPGMA*, we calculate the distance between two superclusters X_I and X_J by taking the arithmetic mean of the pairwise distances, not between individuals in the original matrix of distances, but between component clusters in the matrix used in the previous iteration of the procedure:

$$D(X_I, X_J) = \frac{1}{|I||J|} \sum_{i \in I} \sum_{j \in J} D(X_i, X_j). \quad (8)$$

This method is related to the unweighted average one in that the former derives from the latter when we consider

$$|X_i| = 1 \quad \forall i \in I \quad \text{and} \quad |X_j| = 1 \quad \forall j \in J. \quad (9)$$

It weights the most recently admitted individuals in a cluster equally to its previous members. The weighting discussed here is with reference to individuals composing a cluster and not to the average distances in Lance and Williams' recursive formula (see next section), in which equal weights apply for weighted clustering and different weights apply for unweighted clustering (Sneath and Sokal (1973)).

3.5. *Unweighted centroid*

The next three clustering techniques assume that individuals can be represented by points in Euclidean space. This method and the next one further assume that the measure of dissimilarity between any pair of individuals is the squared Euclidean distance between the corresponding pair of points. When the dissimilarity between two clusters X_i and X_j is defined to be the squared distance between their centroids, we are performing *unweighted centroid* (or simply *centroid*) clustering, also called *UPGMC* (Unweighted Pair-Group Method using Centroids):

$$D(X_i, X_j) = \|\bar{x}_i - \bar{x}_j\|^2, \quad (10)$$

where \bar{x}_i and \bar{x}_j are the centroids of the points in clusters X_i and X_j respectively, and $\|\cdot\|$ is the Euclidean norm. Therefore, under the variable-group point of view, the method could be named *UVGMC* and the distance between two superclusters can be generalised to the definition:

$$D(X_I, X_J) = \|\bar{x}_I - \bar{x}_J\|^2. \quad (11)$$

In Appendix A it is proved that this definition can be expressed in terms of equation (10) as

$$\begin{aligned} D(X_I, X_J) &= \frac{1}{|X_I||X_J|} \sum_{i \in I} \sum_{j \in J} |X_i||X_j| D(X_i, X_j) \\ &\quad - \frac{1}{|X_I|^2} \sum_{i \in I} \sum_{\substack{i' \in I \\ i' > i}} |X_i||X_{i'}| D(X_i, X_{i'}) - \frac{1}{|X_J|^2} \sum_{j \in J} \sum_{\substack{j' \in J \\ j' > j}} |X_j||X_{j'}| D(X_j, X_{j'}). \end{aligned} \quad (12)$$

3.6. Weighted centroid

In *weighted centroid* strategy, also called *median* method or *WVGM*C (Weighted Variable-Group Method using Centroids) extending the pair-group name *WPGMC*, we modify the definition of dissimilarity between two clusters given in the unweighted centroid case, assigning each cluster the same weight in calculating the ‘‘centroid’’. Now the centre of a supercluster X_I is the average of the centres of the constituent clusters:

$$\bar{x}_I = \frac{1}{|I|} \sum_{i \in I} \bar{x}_i.$$

This clustering method is related to the unweighted centroid one by relation (9), which also related the weighted average strategy to the corresponding unweighted average. So, in this case we define the distance between two superclusters as

$$\begin{aligned} D(X_I, X_J) &= \frac{1}{|I||J|} \sum_{i \in I} \sum_{j \in J} D(X_i, X_j) \\ &\quad - \frac{1}{|I|^2} \sum_{i \in I} \sum_{\substack{i' \in I \\ i' > i}} D(X_i, X_{i'}) - \frac{1}{|J|^2} \sum_{j \in J} \sum_{\substack{j' \in J \\ j' > j}} D(X_j, X_{j'}). \end{aligned} \quad (13)$$

3.7. Joint between-within

Székely and Rizzo (2005) propose an agglomerative hierarchical clustering method that minimises a *joint between-within* cluster distance, measuring both heterogeneity between clusters and homogeneity within clusters. This method extends Ward’s minimum variance method (Ward (1963)) by defining the distance between two clusters X_i and X_j in terms of any power $\alpha \in (0, 2]$ of Euclidean distances between individuals:

$$\begin{aligned} D(X_i, X_j) &= \frac{|X_i||X_j|}{|X_i| + |X_j|} \left(\frac{2}{|X_i||X_j|} \sum_{x \in X_i} \sum_{y \in X_j} \|x - y\|^\alpha \right. \\ &\quad \left. - \frac{1}{|X_i|^2} \sum_{x \in X_i} \sum_{x' \in X_i} \|x - x'\|^\alpha - \frac{1}{|X_j|^2} \sum_{y \in X_j} \sum_{y' \in X_j} \|y - y'\|^\alpha \right). \end{aligned} \quad (14)$$

When $\alpha = 2$, cluster distances are a weighted squared distance between cluster centres

$$D(X_i, X_j) = \frac{2|X_i||X_j|}{|X_i| + |X_j|} \|\bar{x}_i - \bar{x}_j\|^2,$$

equal to twice the cluster distance that is used in Ward's method.

In Appendix A we derive the following recursive formula for updating cluster distances as a generalisation of equation (14):

$$\begin{aligned} D(X_I, X_J) &= \frac{1}{|X_I| + |X_J|} \sum_{i \in I} \sum_{j \in J} (|X_i| + |X_j|) D(X_i, X_j) \\ &\quad - \frac{|X_J|}{|X_I|(|X_I| + |X_J|)} \sum_{i \in I} \sum_{\substack{i' \in I \\ i' > i}} (|X_i| + |X_{i'}|) D(X_i, X_{i'}) \\ &\quad - \frac{|X_I|}{|X_J|(|X_I| + |X_J|)} \sum_{j \in J} \sum_{\substack{j' \in J \\ j' > j}} (|X_j| + |X_{j'}|) D(X_j, X_{j'}). \end{aligned} \quad (15)$$

4. Generalisation of Lance and Williams' formula

Lance and Williams (1966) put the most commonly used agglomerative hierarchical strategies into a single system, avoiding the necessity of a separate computer program for each of them. Assume three clusters X_i , $X_{i'}$ and X_j , containing $|X_i|$, $|X_{i'}|$ and $|X_j|$ individuals respectively and with distances between them already determined as $D(X_i, X_{i'})$, $D(X_i, X_j)$ and $D(X_{i'}, X_j)$. Further assume that the smallest of all distances still to be considered is $D(X_i, X_{i'})$, so that X_i and $X_{i'}$ are joined to form a new supercluster $X_i \cup X_{i'}$, with $|X_i| + |X_{i'}|$ individuals. Lance and Williams express $D(X_i \cup X_{i'}, X_j)$ in terms of the distances already defined, all known at the moment of fusion, using the following recurrence relation:

$$\begin{aligned} D(X_i \cup X_{i'}, X_j) &= \alpha_i D(X_i, X_j) + \alpha_{i'} D(X_{i'}, X_j) + \beta D(X_i, X_{i'}) \\ &\quad + \gamma |D(X_i, X_j) - D(X_{i'}, X_j)|. \end{aligned} \quad (16)$$

With this technique superclusters can always be computed from previous clusters and it is not necessary to return to the original dissimilarity data during the clustering process. The values of the parameters α_i , $\alpha_{i'}$, β and γ determine the nature of the sorting strategy. Table 1 gives the values of the parameters that define the most commonly used agglomerative hierarchical clustering methods.

We next give a generalisation of formula (16) compatible with the amalgamation of more than two clusters simultaneously. Suppose that one wants to agglomerate two superclusters X_I and X_J , respectively indexed by $I = \{i_1, i_2, \dots, i_p\}$ and $J = \{j_1, j_2, \dots, j_q\}$. We define

Table 1. Parameter values for the Lance and Williams' formula

| Method | α_i | $\alpha_{i'}$ | β | γ |
|----------------------|--------------------------------------------|-----------------------------------------------|---------------------------------------------|----------------|
| Single linkage | $\frac{1}{2}$ | $\frac{1}{2}$ | 0 | $-\frac{1}{2}$ |
| Complete linkage | $\frac{1}{2}$ | $\frac{1}{2}$ | 0 | $+\frac{1}{2}$ |
| Unweighted average | $\frac{ X_i }{ X_i + X_{i'} }$ | $\frac{ X_{i'} }{ X_i + X_{i'} }$ | 0 | 0 |
| Weighted average | $\frac{1}{2}$ | $\frac{1}{2}$ | 0 | 0 |
| Unweighted centroid | $\frac{ X_i }{ X_i + X_{i'} }$ | $\frac{ X_{i'} }{ X_i + X_{i'} }$ | $-\frac{ X_i X_{i'} }{(X_i + X_{i'})^2}$ | 0 |
| Weighted centroid | $\frac{1}{2}$ | $\frac{1}{2}$ | $-\frac{1}{4}$ | 0 |
| Joint between-within | $\frac{ X_i + X_j }{ X_i + X_{i'} + X_j }$ | $\frac{ X_{i'} + X_j }{ X_i + X_{i'} + X_j }$ | $-\frac{ X_j }{ X_i + X_{i'} + X_j }$ | 0 |

the distance between them as

$$\begin{aligned}
 D(X_I, X_J) = & \sum_{i \in I} \sum_{j \in J} \alpha_{ij} D(X_i, X_j) + \sum_{i \in I} \sum_{\substack{i' \in I \\ i' > i}} \beta_{ii'} D(X_i, X_{i'}) + \sum_{j \in J} \sum_{\substack{j' \in J \\ j' > j}} \beta_{jj'} D(X_j, X_{j'}) \\
 & + \delta \sum_{i \in I} \sum_{j \in J} \gamma_{ij} [D_{max}(X_I, X_J) - D(X_i, X_j)] \\
 & - (1 - \delta) \sum_{i \in I} \sum_{j \in J} \gamma_{ij} [D(X_i, X_j) - D_{min}(X_I, X_J)], \tag{17}
 \end{aligned}$$

where

$$D_{max}(X_I, X_J) = \max_{i \in I} \max_{j \in J} D(X_i, X_j)$$

and

$$D_{min}(X_I, X_J) = \min_{i \in I} \min_{j \in J} D(X_i, X_j).$$

Table 2 shows the values for the parameters α_{ij} , $\beta_{ii'}$, $\beta_{jj'}$, γ_{ij} and δ which determine the clustering method computed by formula (17). They are all gathered from the respective formulae (3), (5), (7), (8), (12), (13) and (15), derived in the previous section.

5. Glamorganshire soils example

We show here a real example which has been studied by Morgan and Ray (1995) using the complete linkage method. It is the *Glamorganshire soils* example, formed by similarity data between 23 different soils. A table with the similarities can be found also in Morgan and Ray (1995), where the values are given with an accuracy of three decimal places. In order to work with dissimilarities, first of all we have transformed the similarities $s(x_i, x_j)$ into the corresponding dissimilarities $d(x_i, x_j) = 1 - s(x_i, x_j)$.

The original data present a tied value for pairs of soils (3,15) and (3,20), which is responsible for two different dendrograms using the complete linkage strategy. We show them in Figs. 5 and 6. Morgan and Ray (1995) explain that the 23 soils have been categorised

Table 2. Parameter values for the variable-group formula

| <i>Method</i> | α_{ij} | $\beta_{ii'}$ | $\beta_{jj'}$ | γ_{ij} | δ |
|----------------------|-----------------------------------|-----------------------------------------------------------|-----------------------------------------------------------|--------------------|----------|
| Single linkage | $\frac{1}{ I J }$ | 0 | 0 | $\frac{1}{ I J }$ | 0 |
| Complete linkage | $\frac{1}{ I J }$ | 0 | 0 | $\frac{1}{ I J }$ | 1 |
| Unweighted average | $\frac{ X_i X_j }{ X_I X_J }$ | 0 | 0 | 0 | — |
| Weighted average | $\frac{1}{ I J }$ | 0 | 0 | 0 | — |
| Unweighted centroid | $\frac{ X_i X_j }{ X_I X_J }$ | $-\frac{ X_i X_{j'} }{ X_I ^2}$ | $-\frac{ X_j X_{j'} }{ X_J ^2}$ | 0 | — |
| Weighted centroid | $\frac{1}{ I J }$ | $-\frac{1}{ I ^2}$ | $-\frac{1}{ J ^2}$ | 0 | — |
| Joint between-within | $\frac{ X_i + X_j }{ X_I + X_J }$ | $-\frac{ X_j }{ X_I } \frac{ X_i + X_{j'} }{ X_I + X_J }$ | $-\frac{ X_i }{ X_J } \frac{ X_j + X_{j'} }{ X_I + X_J }$ | 0 | — |

into eight “great soil groups” by a surveyor. Focusing on soils 1, 2, 6, 12 and 13, which are the only members of the brown earths soil group, we see that the dendrogram in Fig. 5 does not place them in the same cluster until they join soils from other five soil groups, forming the cluster (1, 2, 3, 20, 12, 13, 15, 5, 6, 8, 14, 18). From this point of view, the dendrogram in Fig. 6 is better, since the corresponding cluster loses soils 8, 14 and 18, each representing a different soil group. So, in this case, we have two possible solution dendrograms and the probability of obtaining the “good” one is, hence, of one half.

On the other way, in Fig. 7 we can see the multidendrogram corresponding to the *Glamorganshire soils* data. It is clear from this tree representation the existence of a tie comprising soils 3, 15 and 20. Besides, the multidendrogram gives us the good classification, that is, the one with soils 8, 14 and 18 out of the brown earths soil group. Except for the internal structure of the cluster (1, 2, 3, 15, 20), the rest of the multidendrogram hierarchy coincides with that of the dendrogram shown in Fig. 6.

Finally, notice that the incidence of ties depends on the accuracy with which proximity values are available. In this example, if dissimilarities had been measured to four decimal places, then the tie causing the non-unique complete linkage dendrogram might have disappeared. On the contrary, the probability of ties is higher if lower accuracy data are used. For instance, when we consider the same soils data but with an accuracy of only two decimal places, we obtain the multidendrogram shown in Fig. 8, where three different ties can be observed.

6. Conclusions

The non-uniqueness problem in agglomerative hierarchical clustering generates several hierarchical classifications out from a unique set of tied proximity data. In such cases, selecting a unique classification can be misleading. This problem has traditionally been dealt with distinct criteria, the most of the times consisting on the selection of one out from various resulting hierarchies. In this article we have proposed a variable-group algorithm for agglomerative hierarchical clustering that solves the ties in proximity problem. The output of this algorithm is a uniquely determined sort of valued tree, which we call a multivalued tree, whilst graphically we represent it with a multidendrogram.

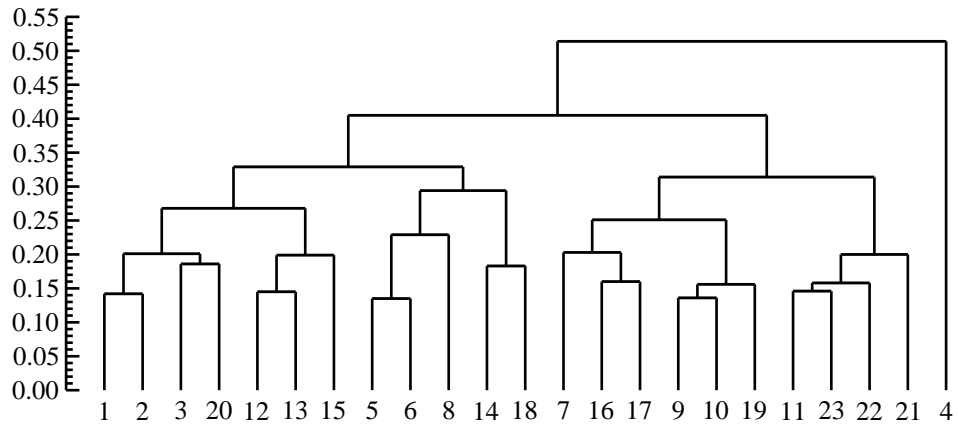

Fig. 5. First complete linkage dendrogram for the soils data

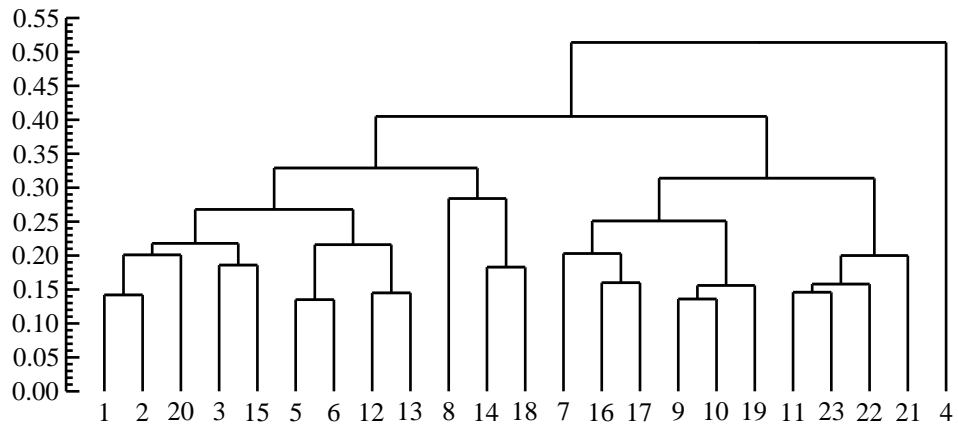

Fig. 6. Second complete linkage dendrogram for the soils data

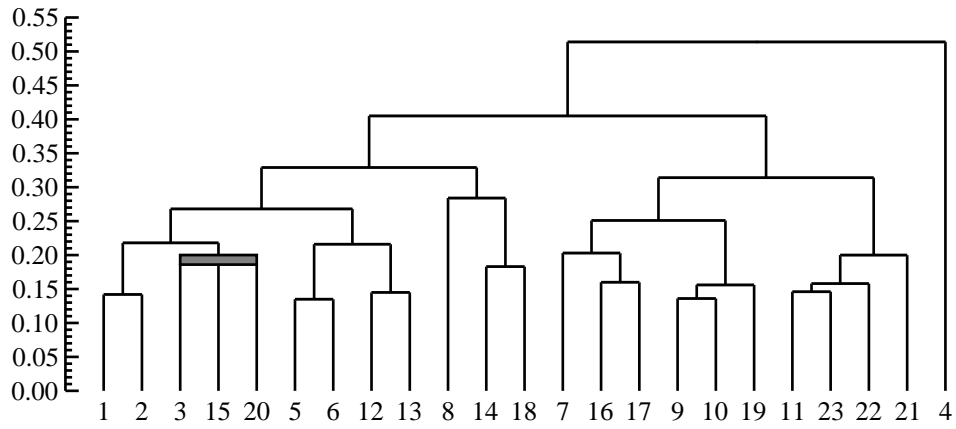

Fig. 7. Complete linkage multidendrogram for the soils data

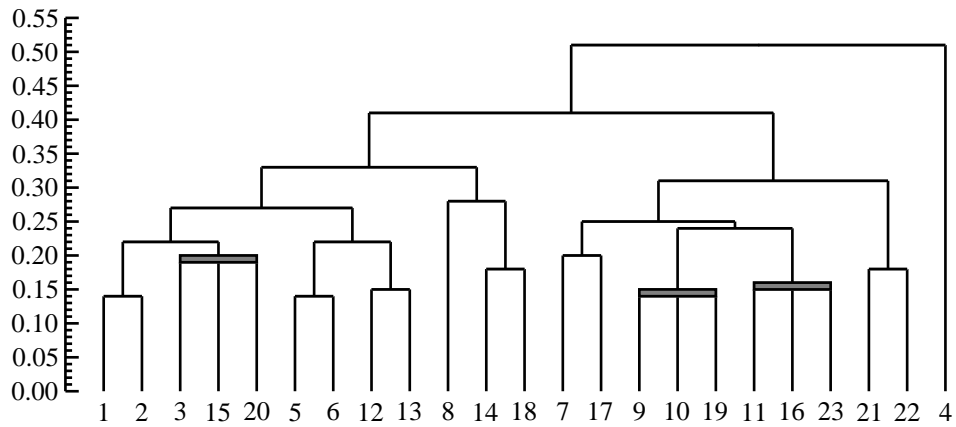

Fig. 8. Complete linkage multidendrogram for the soils data with an accuracy of two decimal places

In addition we have generalised the definition of distance between clusters for the most commonly used agglomerative hierarchical methods, in order to be able to compute them using the variable-group algorithm. We have also given the corresponding generalisation of Lance and Williams' formula, which enables us to get agglomerative hierarchical classifications in a recursive way. Finally, we have showed the possible usefulness of our proposal with some results obtained using data from a real example.

Acknowledgements

We thank A. Arenas for discussion and helpful comments. This work has been supported by DGES of the Spanish Government Project No. FIS2006-13321-C02-02. A.F. also thanks support from Universitat Rovira i Virgili.

A. Proofs of formulations

A.1. Proof for the unweighted centroid method

Given a cluster X_i , its centroid is

$$\bar{x}_i = \frac{1}{|X_i|} \sum_{x \in X_i} x,$$

and the centroid of a supercluster X_I can be expressed in terms of its constituent centroids by the equation:

$$\bar{x}_I = \frac{1}{|X_I|} \sum_{i \in I} |X_i| \bar{x}_i. \quad (18)$$

Now, given two superclusters X_I and X_J , the distance between them defined in equation (11) is

$$D(X_I, X_J) = \|\bar{x}_I - \bar{x}_J\|^2 = \bar{x}_I^2 + \bar{x}_J^2 - 2\bar{x}_I \bar{x}_J.$$

If we substitute each centroid by its definition (18), we obtain:

$$\begin{aligned} D(X_I, X_J) &= \frac{1}{|X_I|^2} \sum_{i \in I} \sum_{i' \in I} |X_i| |X_{i'}| \bar{x}_i \bar{x}_{i'} + \frac{1}{|X_J|^2} \sum_{j \in J} \sum_{j' \in J} |X_j| |X_{j'}| \bar{x}_j \bar{x}_{j'} \\ &\quad - \frac{1}{|X_I| |X_J|} \sum_{i \in I} \sum_{j \in J} |X_i| |X_j| 2\bar{x}_i \bar{x}_j. \end{aligned}$$

Now, since

$$2\bar{x}_i \bar{x}_j = \bar{x}_i^2 + \bar{x}_j^2 - (\bar{x}_i - \bar{x}_j)^2,$$

we have that

$$\begin{aligned} D(X_I, X_J) &= \frac{1}{|X_I|^2} \sum_{i \in I} \sum_{i' \in I} |X_i| |X_{i'}| \bar{x}_i \bar{x}_{i'} + \frac{1}{|X_J|^2} \sum_{j \in J} \sum_{j' \in J} |X_j| |X_{j'}| \bar{x}_j \bar{x}_{j'} \\ &\quad - \frac{1}{|X_I| |X_J|} \sum_{i \in I} \sum_{j \in J} |X_i| |X_j| \bar{x}_i^2 - \frac{1}{|X_I| |X_J|} \sum_{i \in I} \sum_{j \in J} |X_i| |X_j| \bar{x}_j^2 \\ &\quad + \frac{1}{|X_I| |X_J|} \sum_{i \in I} \sum_{j \in J} |X_i| |X_j| (\bar{x}_i - \bar{x}_j)^2. \end{aligned}$$

But this can be rewritten as

$$\begin{aligned} D(X_I, X_J) &= \frac{1}{|X_I||X_J|} \sum_{i \in I} \sum_{j \in J} |X_i||X_j|(\bar{x}_i - \bar{x}_j)^2 \\ &\quad - \frac{1}{|X_I|} \sum_{i \in I} |X_i|\bar{x}_i^2 + \frac{1}{|X_I|^2} \sum_{i \in I} \sum_{i' \in I} |X_i||X_{i'}|\bar{x}_i\bar{x}_{i'} \\ &\quad - \frac{1}{|X_J|} \sum_{j \in J} |X_j|\bar{x}_j^2 + \frac{1}{|X_J|^2} \sum_{j \in J} \sum_{j' \in J} |X_j||X_{j'}|\bar{x}_j\bar{x}_{j'}, \end{aligned}$$

and, grouping terms,

$$\begin{aligned} D(X_I, X_J) &= \frac{1}{|X_I||X_J|} \sum_{i \in I} \sum_{j \in J} |X_i||X_j|(\bar{x}_i - \bar{x}_j)^2 \\ &\quad - \frac{1}{|X_I|^2} \sum_{i \in I} \sum_{i' \in I} |X_i||X_{i'}|(\bar{x}_i^2 - \bar{x}_i\bar{x}_{i'}) - \frac{1}{|X_J|^2} \sum_{j \in J} \sum_{j' \in J} |X_j||X_{j'}|(\bar{x}_j^2 - \bar{x}_j\bar{x}_{j'}). \end{aligned}$$

The second and third terms can be simplified a little more, thanks to the equality

$$\sum_{i \in I} \sum_{i' \in I} |X_i||X_{i'}|(\bar{x}_i^2 - \bar{x}_i\bar{x}_{i'}) = \sum_{i \in I} \sum_{\substack{i' \in I \\ i' > i}} |X_i||X_{i'}|(\bar{x}_i^2 + \bar{x}_{i'}^2 - 2\bar{x}_i\bar{x}_{i'}).$$

With this simplification, we have that

$$\begin{aligned} D(X_I, X_J) &= \frac{1}{|X_I||X_J|} \sum_{i \in I} \sum_{j \in J} |X_i||X_j|(\bar{x}_i - \bar{x}_j)^2 \\ &\quad - \frac{1}{|X_I|^2} \sum_{i \in I} \sum_{\substack{i' \in I \\ i' > i}} |X_i||X_{i'}|(\bar{x}_i - \bar{x}_{i'})^2 - \frac{1}{|X_J|^2} \sum_{j \in J} \sum_{\substack{j' \in J \\ j' > j}} |X_j||X_{j'}|(\bar{x}_j - \bar{x}_{j'})^2, \end{aligned}$$

and, recalling the definition of distance between two clusters given in equation (10), we finally obtain the desired form of equation (12).

A.2. Proof for the joint between-within method

We give here a proof based on that of Székely and Rizzo (2005) for their agglomerative hierarchical formulation. Using the following constants:

$$\begin{aligned} \theta_{ij} &= \frac{1}{|X_i||X_j|} \sum_{x \in X_i} \sum_{y \in X_j} \|x - y\|^\alpha, \\ \theta_{ii} &= \frac{1}{|X_i|^2} \sum_{x \in X_i} \sum_{x' \in X_i} \|x - x'\|^\alpha, \end{aligned} \tag{19}$$

the definition (14) of distance between two clusters X_i and X_j is

$$D(X_i, X_j) = \frac{|X_i||X_j|}{|X_i| + |X_j|} (2\theta_{ij} - \theta_{ii} - \theta_{jj}).$$

Consider now the superclusters X_I and X_J formed by merging clusters X_i , for all $i \in I$, and X_j , for all $j \in J$. Define the corresponding constants:

$$\begin{aligned}\theta_{IJ} &= \frac{1}{|X_I||X_J|} \sum_{x \in X_I} \sum_{y \in X_J} \|x - y\|^\alpha = \frac{1}{|X_I||X_J|} \sum_{i \in I} \sum_{j \in J} \sum_{x \in X_i} \sum_{y \in X_j} \|x - y\|^\alpha, \\ \theta_{II} &= \frac{1}{|X_I|^2} \sum_{x \in X_I} \sum_{x' \in X_I} \|x - x'\|^\alpha = \frac{1}{|X_I|^2} \sum_{i \in I} \sum_{i' \in I} \sum_{x \in X_i} \sum_{x' \in X_{i'}} \|x - x'\|^\alpha \\ &= \frac{1}{|X_I|^2} \sum_{i \in I} \left(\sum_{x \in X_i} \sum_{x' \in X_i} \|x - x'\|^\alpha + 2 \sum_{\substack{i' \in I \\ i' > i}} \sum_{x \in X_i} \sum_{x' \in X_{i'}} \|x - x'\|^\alpha \right),\end{aligned}$$

so that in terms of the original constants (19) we have:

$$\begin{aligned}\theta_{IJ} &= \frac{1}{|X_I||X_J|} \sum_{i \in I} \sum_{j \in J} |X_i||X_j|\theta_{ij}, \\ \theta_{II} &= \frac{1}{|X_I|^2} \sum_{i \in I} \left(|X_i|^2\theta_{ii} + 2 \sum_{\substack{i' \in I \\ i' > i}} |X_i||X_{i'}|\theta_{ii'} \right).\end{aligned}$$

Therefore, the distance between superclusters X_I and X_J is given by

$$\begin{aligned}D(X_I, X_J) &= \frac{|X_I||X_J|}{|X_I| + |X_J|} (2\theta_{IJ} - \theta_{II} - \theta_{JJ}) \\ &= \frac{|X_I||X_J|}{|X_I| + |X_J|} \left[\frac{2}{|X_I||X_J|} \sum_{i \in I} \sum_{j \in J} |X_i||X_j|\theta_{ij} \right. \\ &\quad \left. - \frac{1}{|X_I|^2} \sum_{i \in I} \left(|X_i|^2\theta_{ii} + 2 \sum_{\substack{i' \in I \\ i' > i}} |X_i||X_{i'}|\theta_{ii'} \right) \right. \\ &\quad \left. - \frac{1}{|X_J|^2} \sum_{j \in J} \left(|X_j|^2\theta_{jj} + 2 \sum_{\substack{j' \in J \\ j' > j}} |X_j||X_{j'}|\theta_{jj'} \right) \right].\end{aligned}$$

Simplify

$$\begin{aligned}&\sum_{i \in I} \left(|X_i|^2\theta_{ii} + 2 \sum_{\substack{i' \in I \\ i' > i}} |X_i||X_{i'}|\theta_{ii'} \right) = \\ &= \sum_{i \in I} \left[|X_i|^2\theta_{ii} + \sum_{\substack{i' \in I \\ i' > i}} |X_i||X_{i'}|(2\theta_{ii'} - \theta_{ii} - \theta_{i'i'} + \theta_{ii} + \theta_{i'i'}) \right] \\ &= \sum_{i \in I} \left[|X_i|^2\theta_{ii} + \sum_{\substack{i' \in I \\ i' > i}} |X_i||X_{i'}|(\theta_{ii} + \theta_{i'i'}) + \sum_{\substack{i' \in I \\ i' > i}} (|X_i| + |X_{i'}|)D(X_i, X_{i'}) \right] \\ &= |X_I| \sum_{i \in I} |X_i|\theta_{ii} + \sum_{i \in I} \sum_{\substack{i' \in I \\ i' > i}} (|X_i| + |X_{i'}|)D(X_i, X_{i'}),\end{aligned}$$

where in last equality we have used the equivalence

$$\sum_{i \in I} \left[|X_i|^2 \theta_{ii} + \sum_{\substack{i' \in I \\ i' > i}} |X_i| |X_{i'}| (\theta_{ii} + \theta_{i'i'}) \right] = |X_I| \sum_{i \in I} |X_i| \theta_{ii}.$$

Hence,

$$\begin{aligned} (|X_I| + |X_J|)D(X_I, X_J) &= 2 \sum_{i \in I} \sum_{j \in J} |X_i| |X_j| \theta_{ij} \\ &\quad - |X_J| \sum_{i \in I} |X_i| \theta_{ii} - \frac{|X_J|}{|X_I|} \sum_{i \in I} \sum_{\substack{i' \in I \\ i' > i}} (|X_i| + |X_{i'}|) D(X_i, X_{i'}) \\ &\quad - |X_I| \sum_{j \in J} |X_j| \theta_{jj} - \frac{|X_I|}{|X_J|} \sum_{j \in J} \sum_{\substack{j' \in J \\ j' > j}} (|X_j| + |X_{j'}|) D(X_j, X_{j'}), \end{aligned}$$

or, equivalently,

$$\begin{aligned} (|X_I| + |X_J|)D(X_I, X_J) &= \sum_{i \in I} \sum_{j \in J} |X_i| |X_j| 2\theta_{ij} - \sum_{i \in I} |X_i| \theta_{ii} \sum_{j \in J} |X_j| - \sum_{i \in I} |X_i| \sum_{j \in J} |X_j| \theta_{jj} \\ &\quad - \frac{|X_J|}{|X_I|} \sum_{i \in I} \sum_{\substack{i' \in I \\ i' > i}} (|X_i| + |X_{i'}|) D(X_i, X_{i'}) - \frac{|X_I|}{|X_J|} \sum_{j \in J} \sum_{\substack{j' \in J \\ j' > j}} (|X_j| + |X_{j'}|) D(X_j, X_{j'}), \end{aligned}$$

which is also the same as

$$\begin{aligned} (|X_I| + |X_J|)D(X_I, X_J) &= \sum_{i \in I} \sum_{j \in J} (|X_i| + |X_j|) D(X_i, X_j) \\ &\quad - \frac{|X_J|}{|X_I|} \sum_{i \in I} \sum_{\substack{i' \in I \\ i' > i}} (|X_i| + |X_{i'}|) D(X_i, X_{i'}) - \frac{|X_I|}{|X_J|} \sum_{j \in J} \sum_{\substack{j' \in J \\ j' > j}} (|X_j| + |X_{j'}|) D(X_j, X_{j'}). \end{aligned}$$

And this is exactly the desired formulation given in equation (15).

References

- Arnau, V., S. Mars, and I. Marín (2005). Iterative cluster analysis of protein interaction data. *Bioinformatics* 21(3), 364–378.
- Baceljau, T., L. De Bruyn, H. De Wolf, K. Jordaens, S. Van Dongen, and B. Winnepenninckx (1996). Multiple UPGMA and neighbor-joining trees and the performance of some computer packages. *Mol. Biol. Evol.* 13(2), 309–313.
- Cormack, R. M. (1971). A review of classification (with discussion). *J. R. Statist. Soc. A* 134, 321–367.
- Gordon, A. D. (1999). *Classification* (2nd ed.). Chapman & Hall/CRC.

- Hart, G. (1983). The occurrence of multiple UPGMA phenograms. In J. Felsenstein (Ed.), *Numerical Taxonomy*, pp. 254–258. Springer-Verlag Berlin Heidelberg.
- Lance, G. N. and W. T. Williams (1966). A generalized sorting strategy for computer classifications. *Nature* 212, 218.
- MacCuish, J., C. Nicolaou, and N. E. MacCuish (2001). Ties in proximity and clustering compounds. *J. Chem. Inf. Comput. Sci.* 41, 134–146.
- Morgan, B. J. T. and A. P. G. Ray (1995). Non-uniqueness and inversions in cluster analysis. *Appl. Statist.* 44(1), 117–134.
- Sneath, P. H. A. and R. R. Sokal (1973). *Numerical Taxonomy: The Principles and Practice of Numerical Classification*. W. H. Freeman and Company.
- Székely, G. J. and M. L. Rizzo (2005). Hierarchical clustering via joint between-within distances: Extending Ward’s minimum variance method. *J. Class.* 22, 151–183.
- Van der Kloot, W. A., A. M. J. Spaans, and W. J. Heiser (2005). Instability of hierarchical cluster analysis due to input order of the data: The PermuCLUSTER solution. *Psychological Methods* 10(4), 468–476.
- Ward, J. H., J. (1963). Hierarchical grouping to optimize an objective function. *J. Am. Statist. Ass.* 58, 236–244.