

Statistical Machine Translation by Generalized Parsing*

I. Dan Melamed
New York University

Wei Wang
Language Weaver Inc.

Designers of statistical machine translation (SMT) systems have begun to employ tree-structured translation models. Systems involving tree-structured translation models tend to be complex. This article aims to reduce the conceptual complexity of such systems, in order to make them easier to design, implement, debug, use, study, understand, explain, modify, and improve. In service of this goal, the article extends the theory of semiring parsing to arrive at a novel abstract parsing algorithm with five functional parameters: a logic, a grammar, a semiring, a search strategy, and a termination condition. The article then shows that all the common algorithms that revolve around tree-structured translation models, including hierarchical alignment, inference for parameter estimation, translation, and structured evaluation, can be derived by generalizing two of these parameters — the grammar and the logic. The article culminates with a recipe for using such generalized parsers to train, apply, and evaluate an SMT system that is driven by tree-structured translation models.

1. Introduction

Today's best statistical machine translation (SMT) systems are driven by translation models that are weighted finite-state transducers (WFSTs) (Och and Ney, 2002; Kumar and Byrne, 2003). Figure 1 shows a typical example of a WFST translation model, and the way it is composed of a series of sub-transducers. Models of this type and our methods for using them have become increasingly sophisticated in recent years, leading to steady advances in the accuracy of the best MT systems. However, such translation models run counter to our intuitions about how expressions in different languages are related. In the short term, SMT research based on WFSTs may be a necessary stepping stone, and it is still possible to make improvements by hill-climbing on objective criteria. In the long term, the price of implausible models is reduced insight. There is a growing awareness in the SMT research community that major advances can come only from deeper intuitions about the relationship of our models to the phenomena being modeled.

From an engineering point of view, modeling translational equivalence using WFSTs is like approximating a high-order polynomial with line segments. Given enough parameters, the approximation can be arbitrarily good. In practice, the number of parameters that can be reliably estimated is limited either by the amount of available training data or by the available computing resources. Suitable training data will always be limited for most of the world's languages. On the other hand, for resource-rich language pairs where the amount of training data is practically infinite, the limiting factor is the number of model parameters that fit into our computers' memories. Either way, the relatively low expressive power of WFSTs limits the quality of SMT systems.

* A preliminary version of this article was published by Melamed (2004b). This article improves and extends every section of that preliminary version, and adds several new sections.

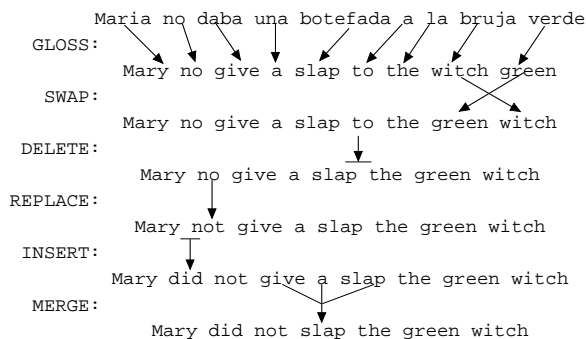
**Figure 1**

Translation by finite-state transduction. Adapted from Knight and Köhn (2003).

To advance the state of the art, SMT system designers have begun to experiment with tree-structured translation models (Wu, 1996; Alshawi, 1996; Yamada and Knight, 2002; Gildea, 2003; Chiang, 2005, e.g.). Tree-structured translation models have the potential to encode more information using fewer parameters. For example, suppose we wish to express the preference for adjectives to follow nouns in language L1 and to precede them in language L2. A model that knows about parts of speech needs only one parameter to record this binary preference. Some finite-state translation models can encode parts of speech and other word classes (Och, Tillmann, and Ney, 1999). However, they cannot encode the preferred relative order of noun *phrases* and adjectival *phrases*, because this kind of knowledge involves parameters over recursive structures. To encode such knowledge, a model must be at least tree-structured. For example, a syntax-directed transduction schema (SDTS) (Aho and Ullman, 1969) needs only one parameter to know that an English noun phrase of the form (Det AdjP N) such as “the green and blue shirt” translates to Arabic in the order (Det N AdjP). A well-known principle of machine learning is that, everything else being equal, models with fewer parameters are more likely to make accurate predictions on previously unseen data.

Several authors have added tree-structured information to systems that were primarily based on WFSTs (Koehn, Och, and Marcu, 2003; Eng et al., 2003). Such a system can be easier to build, especially given pre-existing software for WFST-based SMT. However, such a system cannot reach the potential parameter efficiency of a tree-structured translation model, because it is still saddled with the large number of parameters required by the underlying WFSTs. Such hybrid systems are improving all the time. Yet, one cannot help but wonder how much faster they would improve if they were to shed their historical baggage.

To realize the full potential of tree-structured models, an SMT system must use them as the primary models in every stage of its operation, including training, application to new inputs, and evaluation. Switching to a less efficient model at any stage can result in an explosion in the number of parameters necessary to encode the same information. If the resulting model no longer fits in memory, then the system is forced to lose information, and thus also accuracy.¹ Even when memory is not an issue, the increased number of parameters risks an increase in generalization error.

For these reasons, among others, the SMT research community is highly motivated to build systems whose every process is driven primarily by tree-structured models.

¹An alternative is to swap the model out to secondary storage, slowing down the system by several orders of magnitude.

Unfortunately, from a naive point of view, such systems tend to be conceptually complex — much more complex than WFST-based systems. Complex systems present significant obstacles to research:

- They take a long time to design, to implement, to debug and to document. Given the fast pace of our field of research, good software engineering is usually postponed until after the next conference paper deadline. So, typical implementations are difficult to modify and to extend even for their authors, let alone for anybody else.
- The large number of possible variations in the algorithms involved and in their parameters makes it difficult to run controlled experiments. The large number of independent variables makes it difficult to assign credit/blame for changes in the system's accuracy. Improvements are typically obtained by trial and error, and followed by post-hoc explanations that may or may not be scientifically valid.
- The large number of variables that can affect the outcome of an experiment make the experiments difficult to describe in detail. Experiments that are not fully described are difficult to replicate. Perhaps this is why most of the literature to date on tree-structured translation models compares those models only to variations of themselves and to WFST-based models, but not to other tree-structured models in the literature.

Despite the fast pace of research in this area, it is likely that research would progress more quickly if it were not hindered by the above obstacles.

The primary aim of this article is to reduce the conceptual complexity of SMT systems driven by tree-structured translation models, and thereby to reduce the obstacles outlined above. In service of this goal, Section 2 extends the theory of semiring parsing to arrive at a novel analysis of many common parsing algorithms. This analysis led to two insights, which are expounded in Sections 3 through 9. First, under a certain parameterization, all of the non-trivial algorithms that are necessary for this approach to SMT are special cases of just one algorithm. Second, the one key algorithm that is necessary for this type of SMT is a direct generalization of ordinary parsing. These insights imply that:

- Implementation of an SMT system driven by tree-structured translation models requires only one non-trivial software module. The software engineering effort of the implementation, as well as of any subsequent extensions, is thereby reduced by an order of magnitude. This reduction in effort makes the enterprise feasible for a much larger number of researchers. The “Statistical Machine Translation by Parsing” Team at the 2005 JHU Language Engineering Workshop took advantage of this new-found feasibility to build the first publicly available toolkit for machine translation by parsing.²
- An innovation or improvement in one algorithm will often be applicable to all the others. Conversely, a deeper understanding of the relationships among these algorithms can lead to new insights about the whole class.
- Many of the problems that SMT research will encounter can be solved by generalizing existing solutions from the parsing literature. Such generalizations typically require less effort than completely new solutions, as this article shall demonstrate.

²See <http://www.clsp.jhu.edu/ws2005/groups/statistical/GenPar.html>.

The article makes no empirical claims about the merits of tree-structured translation models or translation by parsing. Instead, the aim is to reduce the effort necessary for research into what those merits might be.

2. Anatomy of a Parser

In natural language processing, a parser is an algorithm for inferring linguistic structure. We limit our attention to parsers that infer structure incrementally using a grammar (Jurafsky and Martin, 2000), rather than by reranking a list of pre-existing structures (Collins and Koo, 2005), or by inferring an entire parse tree as a point in a high-dimensional feature space (Taskar et al., 2004).³ However, the grammar need not be generative or probabilistic. Our only requirement for the grammar is that it should assign values to parts of parse tree structures. These values can range over booleans (structure is possible or not), probabilities, feature weights (Chiang, 2005), or other values such as confidence estimates (Turian and Melamed, 2005).

To facilitate our generalization of ordinary parsers to algorithms necessary for SMT, we shall recast them in terms of an abstract parsing algorithm with five functional parameters: a grammar, a logic, a semiring, a search strategy, and a termination condition. We shall then express all the algorithms necessary for SMT by generalizing two of those parameters — the grammar and the logic. This characterization will make it easier to compare and contrast these algorithms. The use of logics to describe parsers is not new (e.g. Shieber, Schabes, and Pereira (1995, and references therein)). Klein and Manning (2003) have compared different search strategies for a fixed parsing logic and grammar. The parameterization of parsing algorithms by semirings was studied by Goodman (1998), who also presented an abstract parsing algorithm. The abstract parsing algorithm in Section 2.5 is more detailed and more general. Before presenting this algorithm, we shall explain some of its parameters. We presume that readers are already familiar with probabilistic context-free grammars and ordinary parsers (Jurafsky and Martin, 2000).

2.1 Logics for Parsing

A parser's **logic** determines the parser's possible states and transitions. The specification of a parsing logic has three parts:

- a set of term type signatures,
- a set of inference rule type signatures,
- a set of axiom terms.

Terms are the building blocks of inference rules. **Items** are terms that represent partial parses. Terms that represent grammatical constraints such as production rules are sometimes called **grammar terms**. When the parser runs, the term and inference rule types are instantiated and their variables are assigned values. The state of a parser can be uniquely specified by the values of all possible terms.

In the parser's initial state, all terms have a particular default value, such as "false" or "zero probability," depending on the semiring (see below). **Axioms** are term instances (not types) that are assigned non-default values during the parser's initialization procedure. The most common kinds of axioms come from the grammar and from the input. Typically, each input word gives rise to an axiom. If the grammar involves production rules, then each production rule becomes an axiom too. As a parser

³At the time of writing, parsing by structured classification is too expensive to train for practical purposes, and reranking approaches rely on the kind of parsers that we focus on.

Table 1

Logic D1C. w_i are input words; X, Y and Z are nonterminal labels; t is a terminal; i and j are word boundary positions; n is the length of the input.

Term Types	
terminal items	$\langle i, t \rangle$
nonterminal items	$[X; (i, j)]$
terminating productions	$X \Rightarrow t$
nonterminating productions	$X \Rightarrow Y Z$
Axioms	
input words	$\langle i, w_i \rangle$ for $1 \leq i \leq n$
grammar terms	as given by the grammar
Inference Rule Types	
<i>Scan</i>	$\frac{\langle i, t \rangle, X \Rightarrow t}{[X; (i-1, i)]}$
<i>Compose</i>	$\frac{[Y; (i, j)], [Z; (j, k)], X \Rightarrow Y Z}{[X; (i, k)]}$

runs, it can change the values of terms from their initial value to some other value. Melamed (2004b) presented a different formulation, where the values of terms are initially unknown. The present formulation is cleaner because it obviates the need for term values that are not semiring values (see Section 2.3).

Inference rules describe the parser's possible transitions from one state to another. We shall express inference rules as sequents: $\frac{x_1, \dots, x_k}{y}$ means that the value of the **consequent** y depends on the values of the **antecedents** x_1, \dots, x_k . For example, if we are dealing with probabilities, then the probability of the consequent might be defined as the product of the probabilities of the antecedents. The exact relationship between these values depends on the semiring, explained below. Every change in term value corresponds to the invocation of an inference rule where that term is a consequent.

For example, consider Logic D1C, shown in Table 1. This is a logic for parsing under context-free grammars (CFGs) in Chomsky Normal Form (CNF). This logic has four term types. Two term types represent production rules in the grammar. The other two term types are items. Each of the logic's terminal items relates a terminal symbol to a word position. Each of the logic's nonterminal items relates a nonterminal symbol to a span. Each span consists of boundaries i and j , which range over positions between and around the words in the input. The position to the left of the first word is zero, and the position to the right of the j th word is j . Thus, $0 \leq i < j \leq n$, where n is the length of the input.

Parser D1C is any inference procedure based on Logic D1C. For every run, Parser D1C is initialized with axioms that represent its grammar's production rules and the words in its input. It then commences to fire inferences. A *Scan* inference can fire for the i th

word w_i if that word appears on the right-hand side (RHS) of a terminating production in the grammar. If a word appears on the RHS of multiple productions (with different left-hand sides), then multiple *Scan* inferences can fire for that word. The span of each item inferred by a *Scan* inference always has the form $(i - 1, i)$ because such items always span one word, so the distance between the item's boundaries is always one.

Parser D1C spends most of its time composing pairs of items into larger items. It can *Compose* two items whenever they satisfy both of the following constraints:

- *Immediate Dominance (ID)*. Their labels must match the nonterminals on the RHS of a nonterminating production rule in the grammar.
- *Linear Precedence (LP)*. The order of the items' spans over the input must match the order of their labels in the antecedent production rule.

If two spans overlap, then their order is undefined, and they cannot *Compose*. Thus, the LP constraint ensures that no part of the input is covered more than once, so that every partial parse is a tree (rather than a more general graph). The reason items store their spans is to help the parser to enforce the LP constraint.

Some previous publications included a goal item in the logic specification. For example, (Goodman, 1998)'s parsing logics specify the goal of finding a constituent that covers the input text and has the grammar's start symbol as its label. More generally, however, goal items can vary independently of the logic. For example, we might want to use Logic D1C to find all the noun phrases in the input, rather than a single parse for the whole sentence. For this reason, our logics do not specify goals.

2.2 Search strategies

A parsing logic specifies how terms can be inferred, but it does not specify the order of inferences. When a parser needs an inference to evaluate, it consults its **search strategy**. Goodman (1998) required one particular search strategy for his abstract parsing algorithm, which depended on a topological sort of all possible terms. Melamed (2004b) used inference rules to specify a partial order on the computations of term values, although he allowed the order to be determined on the fly. Here we leave all ordering decisions to the search strategy, which may or may not consult the logic. A variety of search strategies are in common use. For example, the CKY algorithm (Kasami, 1965; Younger, 1967) always infers smaller items before larger ones. Alternatively, given term costs such as negative log-probabilities, we can run the parser as a uniform-cost search, inferring less costly consequents before more costly ones. If we are interested in just the single best parse or the n -best parses, then A* strategies of varying sophistication can be employed to speed up the search (Klein and Manning, 2003). The benefit of a separate search strategy is the usual benefit of abstraction: analyses of logics unobscured by search strategies are applicable to a larger class of algorithms, as we shall show in Section 8.

2.3 Semirings for Parsing

A semiring consists of a set, binary operators \oplus and \otimes over that set, and an identity element in the set for each of the two operators. For example, we can define a semiring over the set of integers, where \oplus and \otimes are the usual addition and multiplication operators, and the identity elements are 0 and 1. A semiring's set need not consist of numbers and its operators need not be arithmetic.

Of particular relevance here are semirings that have been proposed specifically for the purpose of describing parsing algorithms in a compact way. Parsing semirings in-

interact with parsing logics according to the following equation:

$$V(y) = \bigoplus_{\substack{x_1, \dots, x_k \\ \text{such that } \frac{x_1 \dots x_k}{y}}} \bigotimes_{i=1}^k V(y_i) \quad (1)$$

In this equation, x and y range over terms, and $V()$ is a function that maps terms to semiring values (i.e. elements of the semiring's set). The equation says that the semiring value of any term is a sum, over all inferences where that term is a consequent, of the product of the values of the antecedents of the inference. The definitions of sum and product here depend on the semiring. Some examples will help to make these abstract ideas more concrete.

The boolean semiring over the set $\{\text{TRUE}, \text{FALSE}\}$ defines \oplus as disjunction and \otimes as conjunction. Under this semiring, the default term value is FALSE. A term can become TRUE in one of only two ways:

1. A term is TRUE if it is an axiom. This is usually the case for grammar terms and items representing input words.
2. According to Equation 1, a term is TRUE if it is the consequent of some inference rule where all the antecedents are TRUE.

If neither of the above conditions holds, then the term retains its default FALSE value. Starting from the parser's initial state, we can run the parser under a Boolean semiring to determine the truth value of the item that spans the input and has the grammar's start symbol as its label. A TRUE value indicates that the grammar can generate that input.

If the grammar guiding the parser is probabilistic, then it's possible to use an inside-probability semiring, where \oplus is real addition and \otimes is real multiplication. Under this semiring, the grammar assigns probabilities to the grammar terms. We can run the parser under the inside-probability semiring to compute the total probability of any item. The probability of the item that spans the input and has the grammar's start symbol as its label is the probability of the grammar generating the input.

Goodman (1998) studied the above semirings and a variety of other semirings that are useful for parsing, including:

- the Viterbi semiring for computing the probability of the single most probable derivation;
- the Viterbi-derivation semiring for computing the single most probable derivation;⁴
- the Viterbi- n -best semiring for computing the n most probable derivations;
- the derivation-forest semiring for computing all possible derivations;
- the counting semiring for computing the number of possible derivations.

The probabilistic semirings can be straightforwardly extended to unnormalized weights. The expectation semiring (Eisner, 2002) can be used to compute expected probabilities, as well as expected feature counts for maximum entropy models and derivatives for gradient-based optimization methods. All of these parsing semirings apply equally well to all the classes of algorithms that we discuss in this article.

⁴Or the set of most probable derivations, if there are ties.

2.4 Termination Conditions

Different termination conditions are appropriate for different parsing applications. Most applications involve a goal item, such as an item that spans the input and is labeled with the start symbol of the grammar. Then the termination condition is that no further inference can change the value of the goal item. Some applications, such as those in Sections 7.2 and 8, involve multiple goal items. There the termination condition must hold conjunctively for all goal items.

In practice, termination conditions often cannot be expressed solely in terms of goal items and their values. For example, Earley parsing logic (Goodman, 1998, Section 2.1.1) might be used to compute the probability of a string under the inside semiring and a PCFG that is not in CNF. If the PCFG has cycles of unary productions (like $\{A \rightarrow B, B \rightarrow A\}$), then the parser will not terminate, because it will be computing an infinite sum. There are methods for computing such sums in closed form (Stolcke, 1995), and it is possible to augment the parser with those methods. However, most parsing applications resort to approximations, because such approximations are easier to implement. A typical implementation limits the computing resources that a run of the parser can expend. So, in addition to goal items, the termination condition might test the elapsed time, the size of allocated memory, or the number of inferences fired, possibly as a function of the input size.

2.5 Abstract Parsing Algorithm

Goodman (1998) presented an abstract parsing algorithm whose parameters are a logic, a grammar, and a semiring. His algorithm employs a search strategy that depends on *a priori* computation of dependencies among all possible terms, so that the terms can be topologically sorted into “buckets.” The parser’s inferences are then fired in the order of their consequents’ buckets. Goodman’s algorithm also assumes that the termination condition is based on a particular goal item. Table 2 presents a more detailed and more general abstract parsing algorithm, where the search strategy and termination condition are parameters, along with the logic, the grammar, the semiring, and the input text.

The parser initializes all possible terms with 0_R , the value of the additive identity element of the semiring.⁵ It then re-initializes axiom terms. It consults the grammar for the value $G(p)$ of each grammar term p' . The grammar must be compatible with the semiring so that $G(p)$ is always a semiring value (i.e. an element of the semiring’s set). Ordinarily, all other axioms are assigned the semiring’s multiplicative identity element 1_R . However, if the input is nondeterministic, then the input axioms can take other values. E.g., they might be weighted by the acoustic module of a speech recognizer.

After initialization, the parser enters its main loop. On each iteration of the main loop, the parser first calls the search strategy to select a set of antecedent terms. The parser places no restrictions on how the search strategy might do so. However, a typical search strategy would keep track of which sets of antecedents it selected previously, to avoid duplication of effort. It would then return antecedent sets that have either (a) never been selected before, or (b) have had one of their element’s values changed since the previous time they were selected. If the search strategy cannot find a set of antecedents with one of these properties, it would return the empty set, which might satisfy the termination condition.

When the parser receives the set of antecedents from the search strategy, it passes them to the logic. The logic compares the antecedents to the signatures of its inference rules. For every matching inference rule, the logic instantiates every possible consequent. It passes all the consequents from all matching inference rules back to the parser.

⁵A typical implementation would not store terms that have this value, so this step would do nothing.

Table 2
 Abstract Parsing Algorithm

Input:

- logic L ,
- grammar G ,
- semiring R ,
- search strategy S ,
- termination condition C ,
- text T

1: **for all** possible terms $x \in L$ **do**2: $V(x) = 0_R$ $\triangleright 0_R$ is the additive identity element of R .3: **for all** axioms $p' \in L$ corresponding to a production rule $p \in G$ **do**4: $V(p') = G(p)$ $\triangleright G(p)$ is the value that G assigns to p .5: **for all** axioms $w' \in L$ corresponding to word $w \in T$ **do**6: $V(w') = T(w)$ $\triangleright T(w) = 1_R$ if T is unambiguous.7: **for all other** axioms $a \in L$ **do**8: $V(a) = 1_R$ $\triangleright 1_R$ is the multiplicative identity element of R .9: **repeat**10: get a set of antecedents $X = \{x_1, \dots, x_k\}$ from S 11: **for all** inferences $I \in L$ such that X unifies with the antecedents of I **do**12: **for all** possible terms y that unify with the conseq. of " I unified with X " **do**

13:

$$SetAntSet(y) = SetAntSet(y) \cup \{X\} \quad (2)$$

14:

$$V(y) = \bigoplus_{X \in SetAntSet(y)} \bigotimes_{i=1}^{|X|} V(x_i) \quad (3)$$

15: **until** C satisfied

The parser then performs two updates for each consequent. Equation 2 updates the record of the consequent's set of antecedent sets (SetAntSets). Equation 3 uses the two operators of the semiring to recompute the consequent's value from the values of its SetAntSets. The SetAntSets data structure is the same as the set of "back-pointers" necessary to represent a packed derivation forest computed under the derivation-forest semiring. For some other semirings, this structure is partially or totally redundant, and more efficient updates are possible. For example, under the Viterbi-derivation semiring, it is necessary to keep track of only the highest-probability antecedent set. However, we don't know of any way to optimize Equation 2 that would be correct for *all* parsing semirings.

Under some semirings, Equation 3 can also be optimized to reuse previous computations, along the lines of (Goodman, 1998)'s "Item Value Formula." However, such optimizations can invalidate nonmonotonic parsing logics, such as those that involve pruning (see Section 5.4). Another possible optimization is to move Equation 3 outside the main loop, and compute $V(y)$ just once for each y . This optimization is impractical in the common scenario where the termination condition involves a time limit. Of all the abstract parsing algorithms that we are aware of, the algorithm in Table 2 is the only one that admits all known parsing logics, semirings, search strategies, and termination conditions.

3. Generalized Parsers

In an ordinary parser, the input is a single string, and the grammar ranges over strings. A convenient way for an SMT system to create and use tree-structured translation models is via generalizations of ordinary parsing algorithms that allow the input to consist of string tuples and/or the grammar to range over string tuples. The kind of string tuples that are most relevant here are texts that are translations of each other, also called **parallel texts** or **multitexts**. Each multitext consists of **component texts** or **components**. Borrowing from vector algebra, we shall use **dimension** as a synonym for **component**, so the number of components in a given multitext is its **dimensionality**.

Figure 2 shows some of the ways in which ordinary parsing can be generalized. A **multiparser**⁶ is an algorithm that can infer the tree structure of each component text in a multitext and simultaneously infer the correspondence relation between these structures.⁷ When a parser's input can have fewer dimensions than the parser's grammar, we call it a **translator**. When a parser's grammar can have fewer dimensions than the parser's input, we call it a **hierarchical aligner**, or just an **aligner** when the context is unambiguous.⁸ The corresponding processes are called **multiparsing**, **translation** and **hierarchical alignment**, respectively.

Many previously published algorithms can also be viewed as generalized parsers (Aho and Ullman, 1969; Wu, 1996; Alshawi, 1996; Hwa et al., 2002, e.g.). Some of these other parsers are fundamentally similar to our parsers and to each other. Others are superficially similar but subtly different. For example, some of the algorithms that have been put forth as generalizations of the CKY algorithm turn out to be more complicated

⁶An equivalent term is **synchronous parser** (Melamed, 2003).

⁷A suitable set of monolingual parsers can also infer the tree structure of each component, but it cannot infer the correspondence relation between these structures.

⁸This class of algorithms has many names in the literature, such as structural matching (Matsumoto et al., 1993), sub-sentential alignment (Groves, Hearne, and Way, 2004), and synchronization (Melamed, 2004b). There are also names for proper subclasses of algorithms, such as "tree alignment" (Meyers, Yangarber, and Grishman, 1996) and "biparsing alignment" (Wu, 2000). Although "alignment" traditionally referred to monotonic relations (i.e. without crossing correspondences), we follow what seems to have become standard nomenclature in computational linguistics.

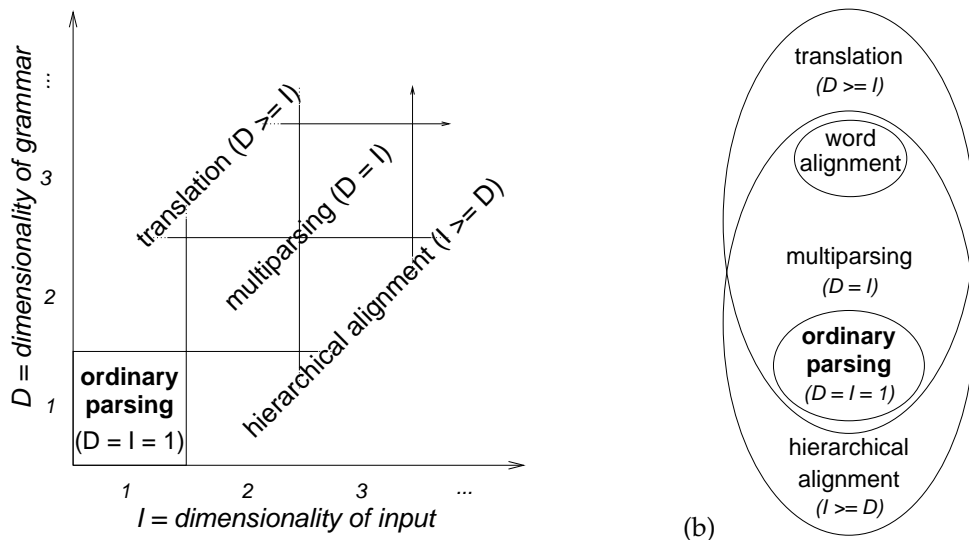

Figure 2
Two perspectives on the space of generalized parsers.

than our generalization (see Section 5.2), and therefore possibly more complicated than necessary. As we shall show, the similarities and differences are easier to see when the semiring, the search strategy, and the terminating conditions are abstracted away.

Taking advantage of the clarity provided by these abstractions, we shall elucidate the relationships between several classes of generalized parsers:

- The class of ordinary parsers is a proper subclass of the class of multiparsers, because the grammars and logics used for ordinary parsing are special cases of the grammars and logics used for multiparsing.
- The class of multiparsers is a proper subclass of the class of translators, because the logics of multiparsing are a subset of the logics of translation.
- The class of multiparsers is also a proper subclass of the class of hierarchical aligners, because the grammars used for multiparsing are a subset of the grammars used for hierarchical alignment.

These relationships could not have been spelled out as precisely without the abstractions in Section 2.

Most of the rest of this article is a guided tour of the generalized parsers that are useful for SMT by Parsing. The next section describes the kind of grammar that generalized parsers use, and presents a particular grammar formalism that will serve as a vehicle for our tour. The three sections after the next give detailed examples of multiparsers, translators, and hierarchical aligners. Then, Sections 7.2 and 8 present two additional generalized parsers that are necessary for a complete system. All of the algorithms on the tour are special cases of the abstract parsing algorithm in Table 2.

4. Grammars for Generalized Parsing

To parse string tuples, we need grammars that can evaluate structures over string tuples, rather than just structures over strings. Grammars that can evaluate structures

$$\begin{array}{l}
 S[\textit{went}] \\
 S[\textit{pashol}]
 \end{array}
 \Rightarrow
 \begin{array}{l}
 NP[\textit{Pat}]^1 V[\textit{went}]^2 Adv[\textit{home}]^3 Adv[\textit{early}]^4 \\
 Adv[\textit{damoy}]^3 NP[\textit{Pat}]^1 Adv[\textit{rano}]^4 V[\textit{pashol}]^2
 \end{array}$$

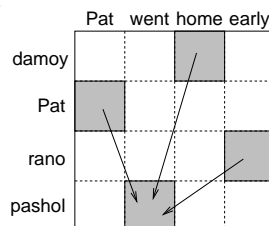

Figure 3

Discontinuous constituents are practically unavoidable in generalized parsing, for example when inferring this production rule in English and (transliterated) Russian. In the illustration on the right, arrows are 2D bilexical dependencies, and shaded squares are 2D constituents.

over string tuples are often called **synchronous grammars**.⁹ This article is not about grammar formalisms, but for expository purposes it is convenient to use one particular formalism as a running example. Our choice of synchronous grammar formalism is informed by certain properties of popular monolingual grammar formalisms and parsing algorithms. To minimize the conceptual leap from ordinary parsing to generalized parsing, we shall employ a grammar formalism that is similar to CFG, in that it uses production rules and is associated with a context-free derivation process.

Another consideration is that popular monolingual grammar formalisms, such as CFG, TAG, and CCG explicitly express subcategorization frames, and recognize that subcategorization frames often have more than two dependents. In formalisms that involve production rules, such subcategorization frames are expressed via production rules that have more than two nonterminals on the RHS. For inferring such productions, it is always more efficient to binarize the grammar (either explicitly or implicitly) than to allow a parser to compose more than two parts of the input at a time. However, in general, binarization of synchronous production rules can result in discontinuous nonterminals.

Early synchronous grammars, such as syntax-directed transduction schemata (SDTSs) (Aho and Ullman, 1969) and their subclass of inversion transduction grammars (ITGs) (Wu, 1997), were defined for contiguous constituents only. Therefore, these formalisms cannot generate certain important multitext correspondence patterns using binary derivation trees. For example, an SDTS that allows up to four symbols on the RHS of a production rule can generate the correspondence pattern in Figure 3, but no SDTS with a lower limit can generate it. The distinguishing characteristic of such patterns is that no two constituents are adjacent in more than one dimension. Each set of sibling constituents in such a pattern must be encapsulated in the RHS of a single nonterminating production rule, like the one shown in Figure 3.

If the grammar is bilexical, then even productions with only three nonterminals on the RHS can require discontinuous constituents for binarization. This case can arise, for example, when two prepositional phrases switch places in translation, as shown in Figure 4. Bilexical parsers typically compose dependents with the head-child, rather than with other dependents, because otherwise some items would need to keep track of multiple lexical heads, increasing computational complexity. Each of the dependents in Figure 4 is adjacent to the head-child in only one dimension. Regardless of which dependent is attached first, a discontinuous item will result.

⁹They were originally called **transduction grammars** (Aho and Ullman, 1969), but we follow the majority of the literature in avoiding this term so as to de-emphasize the input-output connotation of “transduction” (cf. Wu (1997, p. 378)).

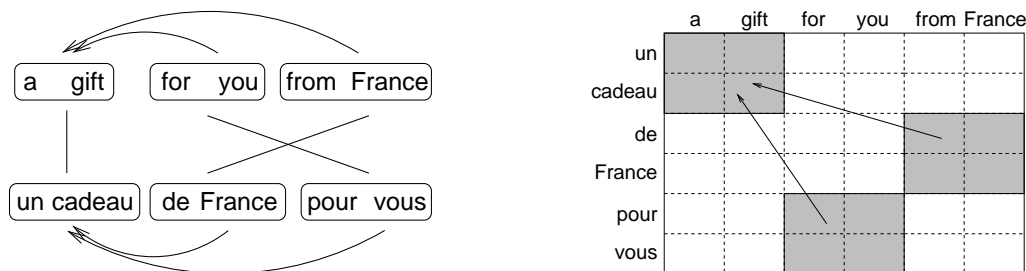
**Figure 4**

Discontinuous constituents are required for bilingual parsing, even for simple bitexts in English and French.

Synchronous grammar formalisms that do not allow discontinuous constituents are unlikely to have adequate coverage, even for multitexts involving languages that are syntactically similar (Zens and Ney, 2003). Simard et al. (2005) have presented empirical evidence that an SMT system can perform better if it can manipulate discontinuous constituents. To our knowledge, the simplest synchronous grammar formalism that deals in discontinuities is generalized multitext grammar (GMTG) (Melamed, Satta, and Wellington, 2004). GMTGs are a complete generalization of CFGs to the synchronous case: GMTGs can express arbitrary tree structures over arbitrarily many parallel texts. This article uses GMTG as a running example of a tree-structured translation model because GMTG is the simplest formalism that can be used to illustrate the concepts that we consider important. More sophisticated formalisms would be necessary to represent a variety of translational divergence patterns (Dorr, 1994), but our abstract parsing algorithm can accommodate them without modification. In a similar spirit, Goodman (1998, Section 2-B.2) presented a parsing logic for tree-adjoining grammars that can be used in his abstract parsing algorithm without modification.

Every GMTG is a D -GMTG for some integer constant $D > 0$, and it generates multitexts with D components. Thus, 1-GMTGs generate ordinary texts and 2-GMTGs generate bitexts. A GMTG has disjoint sets of terminals T and nonterminals N . We often group terminals and nonterminals into vectors that we call **links**. Links express the translational equivalence between their components. In GMTG applications, the different components of a link will often come from largely disjoint subsets of T or N , representing the vocabularies and linguistic categories of different languages. Every link generated by a D -GMTG has D components, some of which may be inactive¹⁰. An inactive link component indicates that the active components vanish in translation to the inactive component.

Each GMTG also has a set of **production rules** (or just **productions** for short). A production in 2-GMTG might look like this:

$$\begin{bmatrix} (X) \\ (Y) \end{bmatrix} \Rightarrow \begin{bmatrix} (A^1 e C^3) \\ (A^2 D^1) \end{bmatrix} \quad (4)$$

There is one row per production component, on both the left-hand side (LHS) and the right-hand side (RHS). Each symbol in parentheses on the LHS is a nonterminal. Each component of the RHS is a string of terminals and/or indexed nonterminals. The indexes are not part of the nonterminal labels; they exist only in production rules. The

¹⁰Inactive component are distinct from components that contain the empty string (Melamed, Satta, and Wellington, 2004). This distinction obviates the need to keep track of the positions of empty strings during parsing.

same nonterminal symbol may appear multiple times in the same component or in different components, either with the same index or with a different index (like A).

The indexes express translational equivalence: All the nonterminals with the same index constitute a link. The derivation process rewrites linked nonterminals as atomic units. Some nonterminals on the RHS might have no translation in some components, in which case there will be no co-indexed nonterminal in those components (as for A^2 and C^3). The derivation process rewrites such nonterminal links like any other link, generating parse subtrees that are inactive in some components. In the limit, a nonterminal symbol in one dimension might not be coindexed with any other nonterminal symbol in its production rule. Repeated rewriting of such degenerate nonterminal links can generate arbitrarily deep one-dimensional subtrees that correspond to other dimensions only at their root. A GMTG can generate tuples of such subtrees to represent translational equivalence among “phrases,” a concept that is currently popular in SMT (Koehn, Och, and Marcu, 2003, e.g.). Terminals never have indexes because they are never rewritten.

The production rule notation described above, which is the original notation of Melamed, Satta, and Wellington (2004), uses superscripts to superimpose information about translational equivalence on top of information about the linear order of constituents. This notation highlights the relationship between GMTG and the familiar CFG. Unfortunately, this notation is not conducive to describing the way that grammar terms interact with the inference rules in parsing logics. In order to specify inference rule signatures completely and compactly, we introduce an alternative notation for GMTG productions that have nonterminals on the RHS. The new notation separates information about translational equivalence from information about the linear order of constituents, enabling independent reference to each type of information.

Here is Production (4) rewritten in the new notation:

$$\begin{array}{l} X \\ Y \end{array} \Rightarrow \bowtie \begin{array}{l} [1, 2, 3] \\ [4, 1] \end{array} \begin{pmatrix} A & e & C & \emptyset \\ D & \emptyset & \emptyset & A \end{pmatrix}. \quad (5)$$

In this notation, nonterminal links are written in columns, and their linear order is indicated by a preceding vector of special data structures called **precedence arrays**, one array per component. E.g., the precedence array in the second component above is $[4, 1]$. The first index in this array is 4, referring to the fourth column in the link vector, and indicating that A comes first in that component. The special symbol \emptyset acts as a placeholder for inactive link components. The indexes in a precedence array never refer to links that are inactive in their component. If the LHS link is inactive in a given component, then all the links on the RHS must also be inactive, and vice versa. In that case, the component is called **inactive** and the precedence array must be empty. Precedence arrays are more informative than the role templates used by Melamed (2003), because role templates obscure link information. The \bowtie (“join”) operator rearranges the symbols in each component’s link vector according to that component’s precedence array to recover the original production rule notation. For example,

$$\bowtie \begin{array}{l} [1, 2, 3] \\ [4, 2, 1, 5] \\ [3, 2, 4] \end{array} \begin{pmatrix} A & B & C & \emptyset & \emptyset \\ Y & X & \emptyset & W & Z \\ \emptyset & U & V & T & \emptyset \end{pmatrix} = \begin{array}{l} A^1 B^2 C^3 \\ W^4 X^2 Y^1 Z^5 \\ V^3 U^2 T^4 \end{array} \quad (6)$$

All the precedence arrays in a given production rule constitute a **precedence array vector (PAV)**.

Precedence arrays can express discontinuities. They can also indicate how to arrange parts of discontinuous constituents. For example, suppose that the first com-

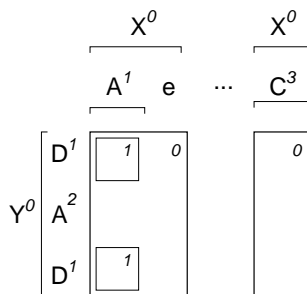

Figure 5
 Example of a GMTG production involving discontinuities on both the LHS and the RHS.
 Numbers indicate co-indexation.

ponent of Production (5) had a gap between the e and the C. Suppose further that the D in the second component contained a gap, and that the A in that component filled that gap. Then the production might be written like this:

$$\begin{matrix} X \\ Y \end{matrix} \Rightarrow_{\bowtie} \begin{bmatrix} [1, 2; 3] \\ [1, 4, 1] \end{bmatrix} \begin{pmatrix} A & e & C & \emptyset \\ D & \emptyset & \emptyset & A \end{pmatrix} \quad (7)$$

In the first component, the semicolon in the precedence array indicates the position of the gap. In the second component, the precedence array indicates that the two parts of D (the nonterminal in the first link) should wrap around the A (the nonterminal in the fourth link). The multitree fragment generated by this production rule is illustrated in Figure 5. Precedence arrays are more general than permutations, because precedence arrays can refer to the same position more than once, as for the D in the second component above.

For each production in the original CFG-style notation, there are many ways to re-express it in the new notation. The existence of multiple ways to express the same constraint is called spurious ambiguity, and it leads to wasted effort during parsing. To avoid spurious ambiguity, we stipulate a normal form for production rules in the new notation. The normal form requires that, if the arrays in the PAV are concatenated, then the first appearance of an index i must precede the first appearance of an index j for all $i < j$, except where the arrangement is incompatible with an earlier choice of indexes. We could, for example, obtain the same result in Equation 6 if we put $\emptyset Z \emptyset$ before $\emptyset W T$ and switch their indexes in the 2nd and 3rd precedence arrays. However, the normal form requires the 2nd precedence array to be $[4, 2, 1, 5]$, not $[5, 2, 1, 4]$, so $\emptyset Z \emptyset$ must be listed last in the link vector. There is a one-to-one correspondence between production rules in the new notation that are in normal form and production rules in the original notation.

For simplicity, we shall limit our attention to GMTGs in Generalized Chomsky Normal Form (GCNF) (Melamed, Satta, and Wellington, 2004). This normal form allows simpler algorithm descriptions than the normal forms used by Wu (1997) and Melamed (2003). In GCNF, every GMTG production is either a terminating production

or a nonterminating production. **Terminating productions** have the form

$$\begin{array}{ccc} \vdots & \vdots & \\ \emptyset & \emptyset & \\ X \Rightarrow t & & (8) \\ \emptyset & \emptyset & \\ \vdots & \vdots & \end{array}$$

All components except for one are inactive. The active component has a single nonterminal symbol on the LHS and a single terminal symbol on the RHS. **Nonterminating productions** have the form

$$\begin{array}{ccc} X_1 & \Rightarrow \times \left[\begin{array}{c} \pi_1 \\ \vdots \\ \pi_D \end{array} \right] \left(\begin{array}{cc} Y_1 & Z_1 \\ \vdots & \vdots \\ Y_D & Z_D \end{array} \right) & (9) \\ \vdots & & \\ X_D & & \end{array}$$

where every X , Y , and Z is either a nonterminal symbol or \emptyset and every π is a precedence array. In GCNF, every nonterminating production must have exactly two nonterminal links on the RHS. These two links may or may not have any active dimensions in common. However, whenever X_i is \emptyset , both Y_i and Z_i must also be \emptyset , and vice versa. Each link can have an arbitrary number of discontinuities, which means that the precedence arrays can be arbitrarily long. However, every index in those arrays is either 1 or 2.

The **fan-out of a constituent, a nonterminal symbol, or a precedence array** is the number of its contiguous elements. The **fan-out of a PAV** is the sum of the fan-outs of its component precedence arrays. E.g., the fan-out of the PAV in Production 7 is $2 + 1 = 3$. The **fan-out of a GMTG** is the maximum of the fan-outs of the PAVs in its production rules. A 1-GMTG with a fan-out of 1 is a CFG.

The GMTG derivation process can be represented by a derivation tree, just like the derivation process of CFGs. As for CFG, GMTG derivation trees are identical to the resulting parse trees. Several graphical representations are common for such trees, as illustrated in Figure 6. For example, consider a GMTG with the production rules in Table 3(a). That GMTG can derive the structure in Figure 6 as shown in Table 3(b). The multidimensional perspective in Figure 6(c) led us to refer to such trees as **multitrees**.

Due to the importance of lexical information in disambiguating linguistic structure, we shall have reason to discuss lexicalized GMTGs (LGMTGs) of the bilexical variety (L_2 GMTGs). In an L_2 GMTG, every nonterminal symbol has the form $L[t]$ for some terminal $t \in T$ and some label $L \in \Lambda$. Λ is a set of “delexicalized” nonterminal labels. Intuitively, Λ corresponds to the nonterminal set of an ordinary CFG. The terminal t is the **lexical head** of its constituent. One nonterminal in each component on the RHS of an L_2 GMTG production serves as the **head-child** of the nonterminal in the corresponding component on the LHS. The head-child inherits the lexical head of its parent nonterminal.

5. Logics for Generalized Parsing

5.1 Discontinuous Spans

We now introduce some notation for describing discontinuities in parse items, and some machinery for operating on them. Expanding on Johnson (1985), we define a **discontinuous span** (or **d-span**, for short) as a list of zero or more intervals $(b_1, e_1; \dots; b_m, e_m)$, where

(a) ordinary tree view

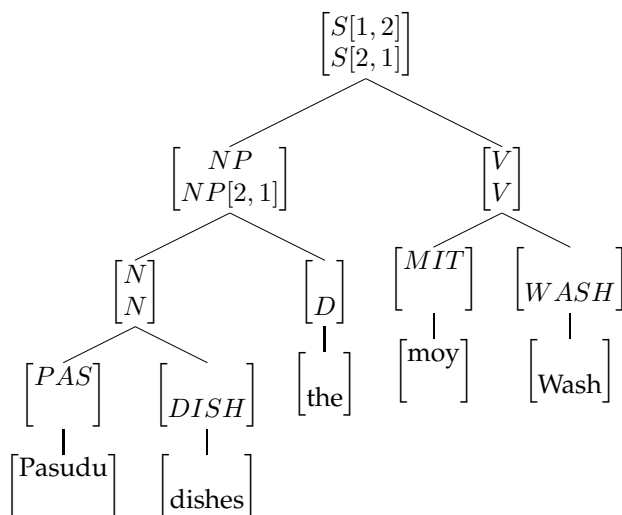

(b) parallel view

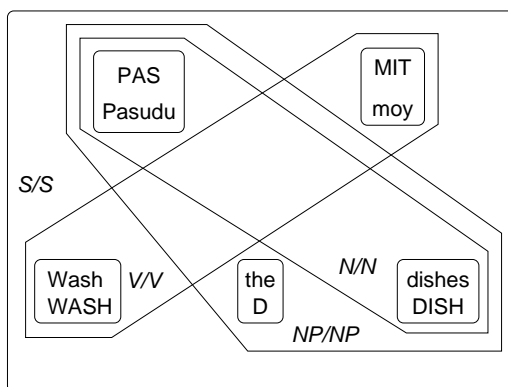

(c) 2D view

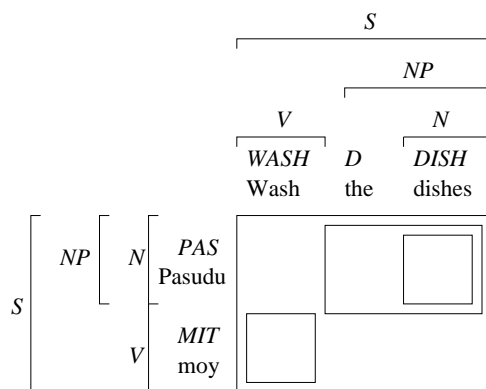

Figure 6
 A 2D multitree in English and transliterated Russian. The three representations are equivalent:
 (a) Every internal node is annotated with the linear order of its children, in every component where there are two children. (b,c) Polygons are constituents.

Table 3

A 2-GMTG with the production rules in (a) can derive the multitree in Figure 6 as shown in (b). Production (15) is not used in the derivation.

(a)

$$\begin{array}{l} S \\ S \end{array} \Rightarrow \times \begin{array}{l} [1, 2] \\ [2, 1] \end{array} \left(\begin{array}{l} NP \ V \\ NP \ V \end{array} \right) \quad (10)$$

$$\begin{array}{l} NP \\ NP \end{array} \Rightarrow \times \begin{array}{l} [1] \\ [2, 1] \end{array} \left(\begin{array}{l} N \\ N \ D \end{array} \right) \quad (11)$$

$$\begin{array}{l} V \\ V \end{array} \Rightarrow \times \begin{array}{l} [1] \\ [2] \end{array} \left(\begin{array}{l} MIT \\ WASH \end{array} \right) \quad (12)$$

$$\begin{array}{l} N \\ N \end{array} \Rightarrow \times \begin{array}{l} [1] \\ [2] \end{array} \left(\begin{array}{l} PAS \\ DISH \end{array} \right) \quad (13)$$

$$\begin{array}{l} \emptyset \\ WASH \end{array} \Rightarrow \begin{array}{l} \emptyset \\ Wash \end{array} \quad (14)$$

$$\begin{array}{l} \emptyset \\ WASH \end{array} \Rightarrow \begin{array}{l} \emptyset \\ clean \end{array} \quad (15)$$

$$\begin{array}{l} \emptyset \\ D \end{array} \Rightarrow \begin{array}{l} \emptyset \\ the \end{array} \quad (16)$$

$$\begin{array}{l} \emptyset \\ DISH \end{array} \Rightarrow \begin{array}{l} \emptyset \\ dishes \end{array} \quad (17)$$

$$\begin{array}{l} PAS \\ \emptyset \end{array} \Rightarrow \begin{array}{l} Pasudu \\ \emptyset \end{array} \quad (18)$$

$$\begin{array}{l} MIT \\ \emptyset \end{array} \Rightarrow \begin{array}{l} moy \\ \emptyset \end{array} \quad (19)$$

(b)

$$\begin{array}{l} S \\ S \end{array} \rightarrow \begin{array}{l} NP^1 \ V^2 \\ V^2 \ NP^1 \end{array} \\ \rightarrow \begin{array}{l} N^3 \ V^2 \\ V^2 \ D^4 \ N^3 \end{array} \\ \rightarrow \begin{array}{l} N^3 \ MIT^5 \\ WASH^6 \ D^4 \ N^3 \end{array} \\ \rightarrow \begin{array}{l} PAS^7 \ MIT^5 \\ WASH^6 \ D^4 \ DISH^8 \end{array} \\ \rightarrow \begin{array}{l} PAS^7 \ MIT^5 \\ WASH^6 \ the \ DISH^8 \end{array} \\ \rightarrow \begin{array}{l} PAS^7 \ moy \\ WASH^6 \ the \ DISH^8 \end{array} \\ \rightarrow \begin{array}{l} PAS^7 \ moy \\ Wash \ the \ DISH^8 \end{array} \\ \rightarrow \begin{array}{l} Pasudu \ moy \\ Wash \ the \ DISH^8 \end{array} \\ \rightarrow \begin{array}{l} Pasudu \ moy \\ Wash \ the \ dishes \end{array}$$

- the b_i are span beginning positions and the e_i are span ending positions, so that $b_i \leq e_i$;
- $e_i \leq b_{i+1}$, which means that the intervals do not overlap;
- a d-span is **proper** if all the above inequalities are strict; i.e., each span has non-zero width and there is a gap between each pair of consecutive intervals;
- an empty d-span is denoted by $()$.

As in ordinary spans, d-span boundaries range over positions between and around the words in a text. Parse items have one d-span per dimension. We shall denote vectors of d-spans by ν, σ and τ . A d-span that pertains to only one particular dimension d is denoted with a subscript, as in σ_d . When a label or a d-span variable has both a superscript and a subscript, it refers to a range of dimensions. E.g., σ_j^i is a vector of d-spans, one for each dimension from i to j .

We define two operators over d-spans.

- $+$ is the ordered concatenation operator. Given two d-spans, it outputs the union of their intervals. E.g., $(1, 3; 8, 9) + (7, 8) = (1, 3; 7, 9)$. Ordered concatenation is commutative: $\sigma + \tau = \tau + \sigma$.
- \wr is the relativization operator¹¹. Given a sequence of d-spans, it computes the precedence array that describes the contiguity and relative positions of their intervals. E.g., $(1, 3; 8, 9) \wr (7, 8) = [1; 2, 1]$, because if these two d-spans were concatenated, then the result would consist of the 1st interval of the 1st d-span, followed by a gap, followed by the 1st interval of the 2nd d-span, followed by the 2nd interval of the 1st d-span. Relativization is not commutative.

The inputs of $+$ and \wr must have no overlapping intervals, or else the output is undefined. Both operators apply componentwise to vectors of d-spans.

5.2 Logic C

Table 4 contains Logic C, which is a generalization of Logic D1C to arbitrary GMTGs in GCNF. Parser C is any parser based on Logic C. The input to Parser C is a tuple of D parallel texts, with lengths n_1, \dots, n_D .

The term types used by Logic C are direct generalizations of the term types used by Logic D1C. The grammar terms represent terminating and nonterminating production rules of a GMTG in GCNF, rather than a CFG in CNF. The terminal items of Logic C have the same variables as the terminal items of Logic D1C, plus an additional variable d to indicate the input component to which an item pertains. Logic C's nonterminal items consist of a D -dimensional label vector X_D^1 and a D -dimensional d-span vector σ_D^1 . The items need d-spans, rather than ordinary spans, because Parser C needs to know all the boundaries of each item, not just the outermost boundaries. Since GMTGs can generate multitexts with components of unequal length, a d-span in one component of an item might cover more words than a d-span in another component. In particular, some (but not all) dimensions of a nonterminal item can be inactive, having an empty d-span and no label. Such lower-dimensional items are necessary for representing multitree branches that are inactive in some components. A typical goal item used with Logic C would be a constituent covering the input multitext and labeled with the grammar's start link. An example of such a constituent is the outermost rectangle in Figure 6(c).

¹¹Melamed (2003) used the \otimes symbol for this operator, but we rename it here to avoid confusion with this symbol's traditional use in describing semirings.

Table 4

Logic C: D is the dimensionality of the grammar and d ranges over dimensions; n_d is the length of the input in dimension d ; i_d ranges over word positions in dimension d , $1 \leq i_d \leq n_d$; w_{d,i_d} are input words; X, Y and Z are nonterminal symbols; t is a terminal symbol; π is a PAV; σ and τ are d-spans.

Term Types	
terminal items	$\langle d, i, t \rangle$
nonterminal items	$[X_D^1; \sigma_D^1]$
terminating productions	$\emptyset_{d-1}^1 \Rightarrow \emptyset_{d-1}^1$ $X \Rightarrow t$ for $1 \leq d \leq D$ $\emptyset_D^{d+1} \Rightarrow \emptyset_D^{d+1}$
nonterminating productions	$X_D^1 \Rightarrow \bowtie [\pi_D^1](Y_D^1 Z_D^1)$
Axioms	
input words	$\langle d, i_d, w_{d,i_d} \rangle$ for $1 \leq d \leq D, 1 \leq i_d \leq n_d$
grammar terms	as given by the grammar
Inference Rule Types	
Scan component $d, 1 \leq d \leq D$	$\langle d, i, t \rangle, \frac{\emptyset_{d-1}^1 \quad \emptyset_{d-1}^1}{X \Rightarrow t}$ $\frac{\emptyset_D^{d+1} \quad \emptyset_D^{d+1}}{\left[\begin{array}{c} \emptyset_{d-1}^1 \quad ()_{d-1}^1 \\ X \quad ; \quad (i-1, i) \\ \emptyset_D^{d+1} \quad ()_D^{d+1} \end{array} \right]}$
Compose	$\frac{[Y_D^1; \tau_D^1], [Z_D^1; \sigma_D^1], X_D^1 \Rightarrow \bowtie [\tau_D^1 \wr \sigma_D^1](Y_D^1 Z_D^1)}{[X_D^1; \tau_D^1 + \sigma_D^1]}$

Parser C begins by firing *Scan* inferences, just like Parser D1C, but it can *Scan* from each of the D input components. A *Scan* inference can fire for the i th word $w_{d,i}$ in component d if that word appears in the d th component of the RHS of a terminating production in the grammar. *Scan* consequents have empty spans and no labels except in the active component.

The parser can also *Compose* pairs of items into larger items. The antecedents of a *Compose* inference can have the same number of active components or a different number. If both antecedents have inactive components, then their active components may or may not be the same. For example, to derive the parse tree in Figure 6, Logic C must make two inferences involving antecedents that have no active components in common. These are the inferences that compose two preterminals each¹². If the active components of one antecedent are a subset of the active components of the other, then the inference

¹²The preterminal nodes of a parse tree inferred under a GMTG in GCNF are always active in only one component.

asserts that some of the yield of the higher-dimensional antecedent vanishes in translation. An example of such an inference is the composition that would infer the NP/NP node in Figure 6.

Logic C’s conditions for item composition are the ID and LP constraints described in Section 2.1 generalized to possibly discontinuous items of arbitrary dimensionality. Both constraints now apply componentwise to every component of the antecedents. The LP constraint is now expressed using the d-span relativization operator defined in Section 5.1: Parser C can compose two items if the contiguity and relative order of their span intervals is consistent with the PAV of the antecedent production rule. Under our new notation for production rules, the LP constraint is completely independent of the nonterminal labels. Such independence of constraints is desirable for modular implementation, as well as for concise logic specification. A complete specification of Logic C using the original notation for production rules would require $O(4^D)$ different *Compose* inference rule signatures.

Logic C is simpler and more general than the parsing logics used by Wu (1997) and Melamed (2003). Both the *Link* inference rule in Melamed (2003)’s Parser R2D2A and Equation 1 in (Wu, 1997) compose terminal items, but neither logic permits monolingual nonterminal items to compose with each other. In contrast, Logic C never composes terminals, so it involves only two types of inference rules. However, its *Compose* inference rule is more general because it admits composition of two lower-dimensional items that are active in the same dimension, composition of two items that are active in different dimensions, and compositions of two items that are active in a different number of dimensions, in addition to the usual compositions of items that are active in all dimensions. Simplicity of description does not preclude computational complexity. However, conceptual complexity correlates with difficulty of engineering. To our knowledge, there have been no studies of the relative benefits of the two kinds of bottom-up logic. In the absence of evidence in support of more complicated logic, Occam’s razor supports Logic C.

5.3 Worst-Case Computational Complexity

The abstract parsing algorithm in Table 2 has several sources of computational complexity. If the simplest possible search strategy is used (such as CKY), then the dominant source of complexity is the logic. We shall analyze the space and time complexity of any parser based on Logic C, using an extension of the static analysis method of McAllester (2002).

The worst-case space complexity of a parser is within a constant factor of the maximum number of possible distinct term instances that it needs to keep track of. A term’s signature uniquely determines how the term can combine with other terms, so two terms that have the same values for the variables in the signature will never differ on whether they can participate in an inference rule. Therefore, we never need to store more than one term with the same variable values. The number of unique combinations of variable values is the product of the sizes of the variables’ ranges.

For a given GMTG G , let f be the fan-out of G , and let $|N|$ be the number of nonterminal symbols in G . Let n be the length of the longest component of the input multitext. We assume that n is always smaller than the size of G ’s terminal set. Then the number of possible distinct terminal items in Parser C will be negligible compared with the number of possible distinct nonterminal items. The free variables in a nonterminal item’s signature are its nonterminal symbol and span boundary in each dimension. The maximum number of required boundaries is exactly $2f$, and each of the boundaries can range over $O(n)$ possible positions. Thus, the space complexity of Parser C for a given D -GMTG

G is in $O(|N|^D n^{2f})$. If G is bilexical, then the number of possible nonterminals hides a factor of n^D , raising the space complexity of Parser C to $O(|\Lambda|^D n^{D+2f})$.

If the search strategy imposes an ordering of inferences that guarantees correctness and avoids duplication of effort,¹³ then the worst-case running time of the abstract parsing algorithm is a product of three factors: the number of possible unique inference rule instantiations, the computational effort required for each instantiation¹⁴, and an implementation-specific constant. The number of possible unique inference rule instantiations is the product of the sizes of the ranges of the free variables that appear in the inference rules. For Parser C, these variables are the nonterminals and the d-spans. The PAVs are not free variables because they are uniquely determined by the d-spans. Assuming a fixed maximum fan-out f for the given grammar, the number of different spans in each inference depends on how many boundaries are shared between the antecedent items. In the best case, all the boundaries are shared except the two outermost boundaries in each dimension, and the consequent is contiguous. In the worst case, no boundaries are shared, and the inferred item stores all the spans of the antecedent items. In any case, if y and z are the fan-out of the composed items, and x is the fan-out of the inferred item, then the number of free boundaries in a Compose inference is $x + y + z$. Thus, in the worst case, the number of free boundaries involved in a Compose inference is $3f$. Each of these boundaries can range over $O(n)$ possible values. Thus, there are $O(n^{3f})$ possible different d-span values. There are three nonterminals per dimension, which can have $O(|N|^{3D})$ possible different values. Finally, each inference rule instantiation requires the computation of the PAV in the antecedent grammar term and the computation of the d-span in the consequent, each at a cost in $O(f)$. The total time complexity of Parser C is in $O(f|N|^{3D} n^{3f})$. For a binarized L₂GMTG, which also needs to keep track of two lexical heads per dimension per inference, this complexity rises to $O(f|\Lambda|^{3D} n^{2D+3f})$.

We presented Logic C for its descriptive simplicity (only two inference rule types) and familiarity (from the CKY algorithm), not for its efficiency. Many other parsing logics are possible, and some of them offer lower worst-case time complexity with no loss of generality (Eisner and Satta, 1999; Melamed, 2003). Nevertheless, the worst-case computational complexity of generalized parsing will always be at least as high as that of ordinary parsing.

5.4 Efficiency Despite Complexity

For most practical applications, monolingual parsing in $O(n^3|N|^3)$ is infeasible. If generalized parsing is even more expensive, some would argue, then it will never be more than a theoretical curiosity. Yet, monolingual parsers are used daily in academia and in industry, because the average run times of well-engineered parsers are typically just a tiny fraction of the theoretical worst case. The same is true for WFST-based SMT, which involves inference algorithms with exponential computational complexity (Knight, 1999), and which is nevertheless the dominant approach in the field. Evidence is beginning to emerge that, as for these other classes of theoretically expensive algorithms, worst-case computational complexity should not prevent anyone from using generalized parsers (Chiang, 2005; Ding and Palmer, 2005).

One of the advantages of machine translation by generalized parsing is that its practitioners need only generalize the efficiency mechanisms that have already been developed for ordinary parsers. The two main techniques used to speed up parsers are pruning (also known as “thresholding”) and outside cost estimation (Goodman, 1998;

¹³In general, agenda-based search strategies offer no such guarantee.

¹⁴The analysis of Melamed (2003) omitted this factor.

Caraballo and Charniak, 1998; Klein and Manning, 2003, e.g.). The parsing logics of Goodman (1998, Chapter 5) use outside cost estimates for making decisions about pruning. However, it is also possible to prune without estimating outside costs. Let us consider how these techniques can speed up generalized parsing.

Goodman (1998) augmented his parsing logics with pruning by adding side-conditions to the inference rules. Side-conditions on inference rules are always boolean tests, even if the semiring involved is not boolean. Side-conditions used for pruning test whether the semiring values of certain terms in the inference rule are larger than certain other values, such as the values of certain axiom terms (constants), the values of other terms in the same inference rule, and/or other values recorded in the parse state. Candidate inferences are discarded without firing if their side-conditions are evaluated to be false.

Side conditions involving properties of the parse state that are neither constants nor local to the inference rule usually render the logic nonmonotonic, perhaps even able to remove elements from SetAntSets. If pruning functionality is added at a sufficiently high level of abstraction, then nonmonotonicity need not significantly increase the difficulty of correct implementation. The side-condition test can be added between lines 12 and 13 of the abstract parsing algorithm in Table 2. If the side-condition is false, the algorithm removes the antecedent set from the consequent’s SetAntSet instead of adding it there, and proceeds to line 14. Since the abstract parsing algorithm is independent of the dimensionality of the input or the grammar, it can apply side-conditions from logics for generalized parsing in exactly the same way as from logics for ordinary parsing.

The outside cost estimate of a term is an estimate of the difference between the cost of that term and the cost of a possible descendant goal term. A* estimates are a well-known special subclass of outside cost estimates used in parsers. Outside cost estimates can be used to guide the search strategy towards terms that are more likely than others to be on the path to the goal. Since search strategies are independent of the dimensionality of the input or the grammar, the necessary modifications to the search strategy in a generalized parser are the same as they are for the search strategy in an ordinary parser, so we refer the reader elsewhere for details (Klein and Manning, 2003, e.g.). The necessary modifications to the parsing logic can vary, depending on what additional information the search strategy needs about the state of the parse. For example, to compute outside costs for his monolingual bottom-up parsing logics, Goodman (1998) augmented them with new types of “summary” terms, which keep track of outside costs for equivalence classes of ordinary terms. These new term types are then used in side-conditions to make pruning decisions.

6. Translation

A D -GMTG can guide a multiparser to infer the hidden structure of a D -component multitext. Now suppose that we have a D -GMTG and an input multitext with only I components, where $I \leq D$. When some of the component texts are missing, we can ask the parser to infer a D -dimensional multitree that includes the missing components, which are supplied by the grammar. The resulting multitree will cover the I **input components/dimensions** among its D dimensions. It will also express the $D - I$ **output components/dimensions**, along with their tree structures. When a parser’s input can have fewer dimensions than the parser’s grammar, we call it a **translator**.

6.1 Translator CT

Table 5 shows Logic CT, which is a generalization of Logic C. The items of Logic CT have a D -dimensional label vector, as usual. However, their d-span vectors are only I -dimensional. Recall that the purpose of d-spans is to help the parser to enforce LP

Table 5

Logic CT: D is the dimensionality of the grammar, I is the dimensionality of the input, and d ranges over dimensions; n_d is the length of the input in dimension d ; i_d ranges over word positions in dimension d , $1 \leq i_d \leq n_d$; w_{d,i_d} are input words; X, Y and Z are nonterminal symbols; t is a terminal symbol; π is a PAV; σ and τ are d-spans.

<p>Term Types</p> <p>terminal items</p> <p>nonterminal items</p> <p>terminating productions</p> <p>nonterminating productions</p>	$\langle d, i, t \rangle$ $[X_D^1; \sigma_I^1]$ $\begin{array}{ccc} \emptyset_{d-1}^1 & \emptyset_{d-1}^1 & \\ X & \Rightarrow t & \text{for } 1 \leq d \leq D \\ \emptyset_D^{d+1} & \emptyset_D^{d+1} & \end{array}$ $X_D^1 \Rightarrow \bowtie [\pi_D^1](Y_D^1 Z_D^1)$
<p>Axioms</p> <p>input words</p> <p>grammar terms</p>	$\langle d, i_d, w_{d,i_d} \rangle \text{ for } 1 \leq d \leq I, 1 \leq i_d \leq n_d$ <p>as given by the grammar</p>
<p>Inference Rule Types</p> <p>Scan component $d, 1 \leq d \leq I$</p> <p>Load component $d, I < d \leq D$</p> <p>Compose</p>	$\begin{array}{ccc} \emptyset_{d-1}^1 & \emptyset_{d-1}^1 & \\ X & \Rightarrow t & \\ \emptyset_D^{d+1} & \emptyset_D^{d+1} & \end{array} \quad \langle d, i, t \rangle$ $\frac{\emptyset_{d-1}^1 \quad \emptyset_{d-1}^1}{\left[\begin{array}{cc} \emptyset_{d-1}^1 & \emptyset_{d-1}^1 \\ X & (i-1, i) \\ \emptyset_D^{d+1} & \emptyset_D^{d+1} \\ \emptyset_D^{I+1} & \emptyset_D^{I+1} \end{array} \right]}$ $\frac{\emptyset_{d-1}^1 \quad \emptyset_{d-1}^1}{\left[\begin{array}{cc} \emptyset_{d-1}^1 & \emptyset_{d-1}^1 \\ X & t \\ \emptyset_D^{d+1} & \emptyset_D^{d+1} \end{array} \right]}$ $\frac{[Y_D^1; \tau_I^1], [Z_D^1; \sigma_I^1], X_D^1 \Rightarrow \bowtie \left[\begin{array}{c} \tau_I^1 \wr \sigma_I^1 \\ \pi_D^{I+1} \end{array} \right] (Y_D^1 Z_D^1)}{[X_D^1; \tau_I^1 + \sigma_I^1]}$

constraints, so that the input is covered only once. It would be pointless to constrain the absolute positions of items on the output dimensions, because on those dimensions there is no input to cover. On the output dimensions, we need only constrain the relative order of items. Constraints on the relative order are specified by π_D^{I+1} in the *Compose* grammar term, which is the part of the PAV that pertains to the output dimensions.

Translator CT is any generalized parser based on Logic CT. Translator CT scans only the input components. Terminating productions with active output components are *Loaded*: Their LHSs are added to the chart without d-span information. Composition proceeds as before, except that there are no constraints on the precedence arrays in the output dimensions — the precedence arrays in π_D^{I+1} are free variables.

As in Parser C, the first few *Compose* inferences fired by Translator CT typically link items that have no active dimensions in common. If one of the items exists only in the input dimension(s), and the other only in the output dimension(s), then this inference is, de facto, translation. As for all inference rules, the possible translations are determined by consulting the grammar. Thus, in addition to its usual function of evaluating linguistic structures, the grammar simultaneously functions as a translation model.

In summary, Logic CT differs from Logic C as follows:

- Items store no absolute position information (d-spans) for the output components.
- For the output components, the *Scan* inferences are replaced by *Load* inferences, which are just like *Scans* except that they are not constrained by input.
- The *Compose* inference does not constrain the absolute positions of items on the output components, although the antecedent PAV still constrains their relative positions.

We have constructed a translator from a multiparser merely by relaxing some constraints on the output dimensions. Table 5 is so similar to Table 4 because Parser C is just Translator CT for the special case where $I = D$. The relationship between the two classes of algorithms is easier to see from their declarative logics than it would be from their procedural pseudocode or equations.

The relationship between translation and ordinary parsing was noted a long time ago (Aho and Ullman, 1969), but here we articulate it in more detail: Ordinary parsers are a proper subclass of multiparsers, which are a proper subclass of translators. That Logic C is a special case of Logic CT explains why we view multiparsers as a subclass of translators. It may be counterintuitive to think of algorithms that produce no new words as translators, but any analysis or optimization that is valid for translators is also valid for multiparsers. The subclass relationship is convenient for both theoretical investigation and practical implementation.

Logic CT can be used with any of the semirings listed in Section 2.3. For example, under a boolean semiring, this logic will succeed on an I -dimensional input if and only if it can infer a D -dimensional multitree, whose root is the goal item. Such a tree would contain a $(D - I)$ -dimensional translation of the input. Thus, under a boolean semiring, Translator CT can determine whether a translation of the input exists, according to the grammar.

With a probabilistic GMTG (PGMTG) and the inside semiring, Translator CT can compute the total probability of all D -dimensional multitrees containing the I -dimensional input. All these derivation trees, along with their probabilities, can be efficiently represented as a packed parse forest, rooted at the goal item. Unfortunately, finding the most probable output string still requires summing probabilities over an exponential

number of trees. This problem was shown to be NP-hard in the one-dimensional case (Sima'an, 1996). There is no reason to believe that it is any easier in multiple dimensions.

6.2 Practical Variations

6.2.1 Other Semirings and Search Strategies The Viterbi-derivation semiring would be used most frequently in practice. Given a D -PGMTG, Translator CT can use this semiring to find the single most probable D -dimensional multitree that covers the I -dimensional input. For example, suppose that

- all the productions in Table 3(a) have probability 1.0, except that Production (14) has probability 0.7 and Production (15) has probability 0.3;
- we employ a uniform cost search strategy, so that the translator makes inferences in order of decreasing probability of the consequent (ties are broken according to the lexicographic order of the consequent labels);
- the input is *Pasudu moy*.

The inferences that Translator CT would make under these conditions are shown in the proof tree in Figure 7. Each internal node represents an item. The children of each item are its antecedents. The nonterminal items are numbered to indicate the order of inference. For example, the consequents numbered 3 and 6 precede the one numbered 7, because the former all have probability 1.0, but the probability of the latter is lowered by the probability of its antecedent production rule. The 2nd item is inferred before the 3rd because the label “*PAS/∅*” of the 2nd consequent precedes the label “*∅/D*” of the 3rd consequent in the lexicographic order. Note that the information in the proof tree in Figure 7 is a superset of the information in in Figure 6.

One of the productions in Table 3 is absent from Figure 7. By replacing the usual CKY search strategy with a more sophisticated one, the translator avoids the expense of an inference involving Production (15). The benefits of alternative search strategies are easier to see when the grammar, the logic, the semiring, and the termination condition are abstracted away and held constant.

6.2.2 Other Logics A naive implementation of Logic CT would be rather inefficient in practice. It requires *Loading* an axiom for each word in the target vocabulary, regardless of whether a *Loaded* word is a possible translation of some input word. With a large grammar, most *Load* consequents would never be *Composed* with input items, so those *Load* inferences would be a waste of time. A straightforward optimization is to check whether a target word might be the translation of some input word before *Loading* it. To implement this optimization, replace the *Load* inference rule with the following inference rule, for $I < d \leq D$:

$$\frac{\begin{array}{c} \emptyset_I^1 \\ \emptyset_{d-1}^{I+1} \\ Z \\ \emptyset_D^{d+1} \end{array} \Rightarrow \begin{array}{c} \emptyset_I^1 \\ \emptyset_{d-1}^{I+1} \\ t \\ \emptyset_D^{d+1} \end{array}, [Y_D^1; \tau_I^1], X_D^1 \Rightarrow \left[\begin{array}{c} \tau_I^1 \wr \sigma_I^1 \\ \pi_D^{I+1} \end{array} \right] \left(\begin{array}{c} \emptyset_I^1 \\ \emptyset_{d-1}^{I+1} \\ Z \\ \emptyset_D^{d+1} \end{array} \right)}{[X_D^1; \tau_I^1 + \sigma_I^1]}$$

This inference rule is essentially a macro of two rules from Logic CT: a *Load* inference, and a *Compose* inference that could follow the *Load* when a suitable antecedent item $[Y_D^1; \tau_I^1]$ has been inferred from the input. The macro will fire once for every (input item, target word) pair, where the target word is a possible translation of the input item, according to the grammar. This macro admits a greater variety of inferences than the

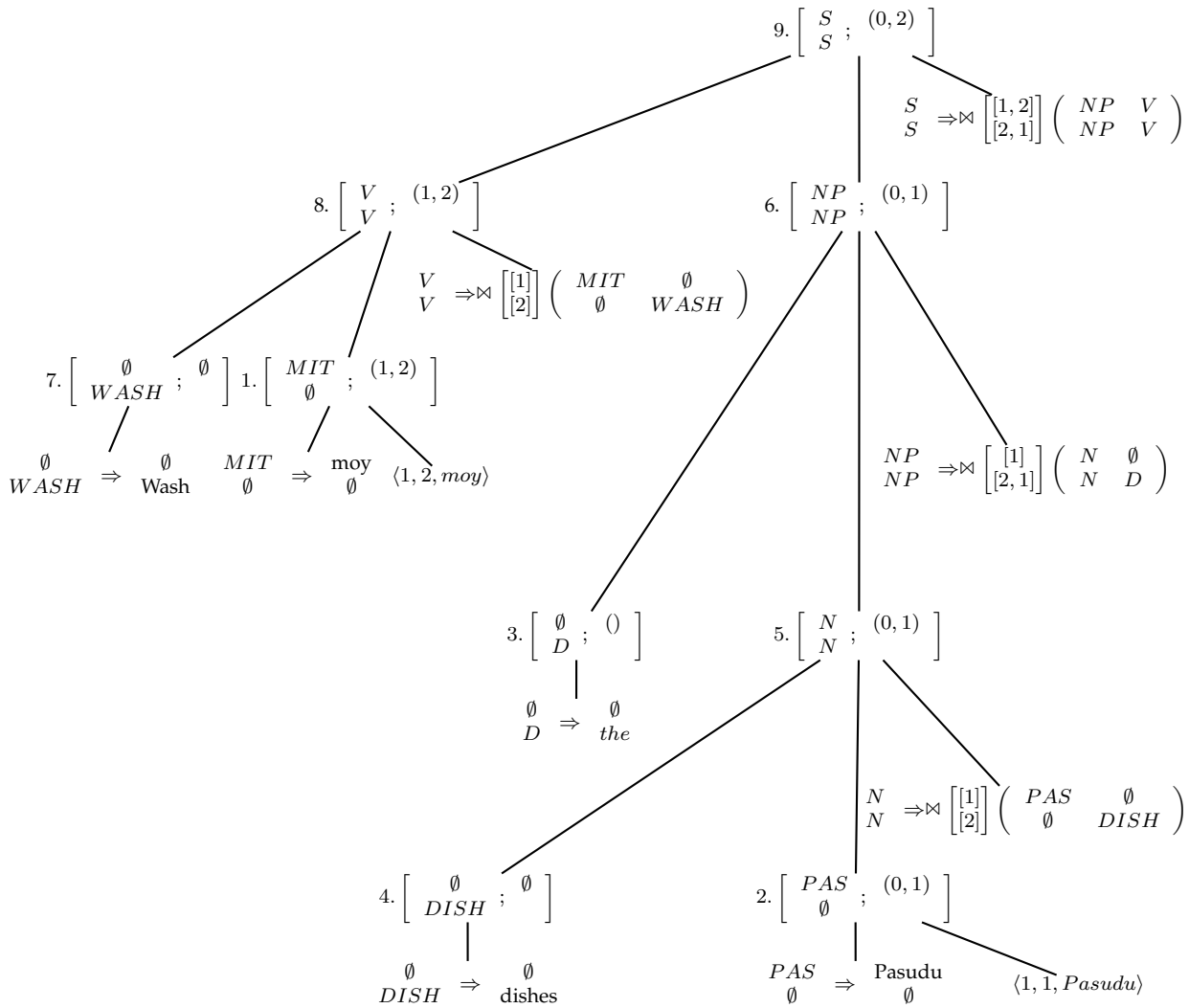

Figure 7

Proof tree for Translator CT's inference of the multitree in Figure 6, using the GMTG in Table 3(a) with a Viterbi-derivation semiring, on input *Pasudu moy*. The child nodes of each item contain its antecedents. The nonterminal items are numbered to indicate the order of their inference.

Link inference rule of Melamed (2003), because the antecedent input item $[Y_D^1; \tau_I^1]$ need not be a *Scan* consequent. It can represent an arbitrarily deep multitree over the input components. On the other hand, this macro does not allow *Load* consequents to *Compose* with each other before composing with items covering some part of the input. More sophisticated translation logics are necessary to achieve complete flexibility efficiently.

6.2.3 Other Grammars An SMT system can benefit from mixing the predictions of its translation model with those of a more reliable monolingual language model (Brown et al., 1993). The classic way to mix a translation model with a language model is the so-called noisy-channel framework. This framework applies to conditional models, but Melamed (2004a) shows that monolingual language models can also be mixed in a principled way with joint models such as probabilistic synchronous grammars. The key benefit of such a mixture is that it can help to evaluate every inference fired by a parsing logic. In this manner, the language model can greatly accelerate the translation process, in comparison to algorithms that apply a language model only after a complete multiforest has been inferred. For example, the decoder of Yamada and Knight (2002) first builds a forest of multitrees, and then searches for the single most probable output in the forest using a language model. If only a single translation is desired, then there is no need to compute a parse forest. Moreover, if only the single most probable translation is desired, then various pruning methods can be used to speed up the search. A PGMGTG mixed with a target language model can provide sharper term probability estimates, making the pruning methods more efficient.

6.3 Discussion

The multitree inferred by the translator will have the words of both the input and the output components in its leaves. In practice, we usually want the output as a string tuple, rather than as a multitree. Under the various derivation semirings (Goodman, 1998), Translator CT can store the output precedence arrays π_D^{I+1} in each internal node of the tree. The intended ordering of the terminals in each output dimension can be assembled from these arrays by a linear-time **linearization** post-process that traverses the finished multitree in postorder.

To the best of our knowledge, Translator CT is the first to be compatible with all of the semirings listed in Section 2.3, among others. It is also unique in being able to accommodate multiple input components and multiple output components simultaneously. When a source document is available in multiple languages, a translator can benefit from the disambiguating information in each. Translator CT can take advantage of such information without making the strong independence assumptions of Och and Ney (2001). When Translator CT is used to translate into multiple languages simultaneously, each translation is constrained not only by the input, but also by all the other translations. This approach might effect greater consistency across output components, which is one of the putative benefits of the interlingual approach to MT. Indeed, the language¹⁵ of multitrees can be viewed as an interlingua.

7. Hierarchical Alignment

In Section 6 we explored inference of I -dimensional multitrees under a D -dimensional grammar, where $D \geq I$. Now we generalize along the other axis of Figure 2(a). It is often useful to infer I -dimensional multitrees without the benefit of an I -dimensional grammar. One application is inducing a parser in one language from a parser in another

¹⁵Here we intend the formal language theory sense of “language.”

(Lü et al., 2002). The application that is most relevant to this article is bootstrapping an I -dimensional grammar.

In theory, it is possible to estimate a PGMTG from multitext in an unsupervised manner, starting with a random or uniform distribution over production rules. However, the quality of the parameter estimates is greatly affected by how they are initialized, so such a simple approach is unlikely to produce good results. A more reliable way to estimate PGMTG production probabilities is from a corpus of multitrees — a **multitreebank**.¹⁶ Despite some recent efforts to manually construct multitreebanks (Uchimoto et al., 2004), it is unlikely that they will become available for more than a handful of language pairs any time soon. The most straightforward way to create a multitreebank is to parse some multitext using a multiparser, such as Parser C. However, if the goal is to bootstrap an I -PGMTG, then there is no I -PGMTG that can evaluate the grammar terms in the parser’s logic.

Our solution is to orchestrate lower-dimensional knowledge sources to evaluate the grammar terms. Then, we can use our favorite multiparsing logic to align multitext into a multitreebank. If we have no PGMTG, then we can use other criteria to evaluate inferences. These other criteria can be based on various subsets of the information available in inference rules.

For example, given a tokenized set of tuples of parallel sentences, it is always possible to estimate a word-to-word translation model $\Pr(u_I^{D+1}|u_D^1)$ (Brown et al., 1993)¹⁷. Such a probability distribution ranges over parts of the nodes of multitrees. Even if we have no basis for choosing among different tree structures, we can prefer multitrees whose individual nodes have higher probability. Chiang (2005) generalized this idea to bootstrap a synchronous grammar from a pre-existing phrase-to-phrase translation model.

Research on hierarchical alignment has a rich history in the context of example-based machine translation. To our knowledge, all the algorithms presented in that context presume that parse trees are available for all multitext components, which is why that subclass of alignment algorithms is usually called **tree alignment** (Meyers, Yangarber, and Grishman, 1996) or **structural matching** (Matsumoto et al., 1993). The idea that alignment can be carried out under much more varied conditions was first put forth by Wu (1995), and further expounded by Wu (2000). In this section, we offer a more precise characterization of the relationship between multiparsing and hierarchical alignment, by showing that hierarchical alignment can be carried out using *exactly* the same logics, semirings, search strategies, and termination conditions as ordinary multiparsing algorithms. A generalization of what counts as a grammar is sufficient.

7.1 A Common Scenario

For an extended example, we consider the common alignment scenario where a lexicalized monolingual grammar is available for just one component. For example, many multitexts have at least one component in one of the languages for which treebanks have been built¹⁸. Given a treebank in the language of one of the input components, we can induce a lexicalized PCFG. Alternatively, if a non-probabilistic parser is available for one of the input components, then we can first parse that component, and then proceed as we would from a treebank. Regardless of how we obtain it, a monolingual lexicalized

¹⁶In contrast, a parallel treebank (Han, Han, and Ko, 2001) might contain no information about translational equivalence beyond sentence alignments.

¹⁷Although most of the literature discusses word translation models between only two languages, it is possible to use one language as a pivot to combine several 2D models into a higher-dimensional model (Mann and Yarowsky, 2001).

¹⁸At the time of writing, we are aware of treebanks for English, Spanish, French, German, Chinese, Czech, Arabic, and Korean.

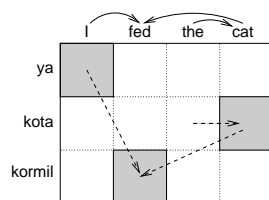

Figure 8

Example of constraints in hierarchical alignment. Only one synchronous dependency structure (dashed arcs) is compatible with the monolingual structure (solid arcs) and word alignment (shaded squares).

grammar can guide our search for the multitree with the most probable structure in the resource-rich component. More generally,¹⁹ we might have a lexicalized PGMTG in D dimensions, from which we want to align I -dimensional multitrees, $I \geq D$. Without loss of generality, we shall let the PGMTG range over the first D components. We shall then refer to the D structured components and the $I - D$ unstructured components.

Given a one-to-one matching between the words in a multitext, choosing the optimal structure for one component is tantamount to choosing the optimal synchronous structure for all components. For example, in Figure 8, a monolingual grammar has allowed only one synchronous dependency structure on the English side, and a word-to-word translation model has allowed only one word alignment. Ignoring the non-terminal labels, only one dependency structure is compatible with these constraints. Unmatched nodes in the structured component can be ignored. Unmatched nodes in the unstructured component can be heuristically attached either to the left or to the right (Wu, 1995), or even randomly. More generally, the given word matching need not be one-to-one and the structure given for the structured component need not be a single tree or a tree at all. Missing substructures and other ambiguities in these input constraints can be resolved during the alignment process.

To combine structural and translational constraints for alignment in this manner, it is convenient to suppose that we are inducing a *bilexical* PGMTG under the Viterbi-derivation semiring. Given a bilexical PCFG, or a functionally equivalent approximation thereof, we can search for a multitree that simultaneously has a high-probability tree structure and a high-probability correspondence among words in its nodes. Such an inference process is, by definition, a generalized parser. It can be based on any parsing logic, including Logic C. If we have no I -PGMTG, then we can evaluate the grammar terms in a way that does not rely on it. Let $G()$ be the function that the grammar uses to assign probabilities to production rules. Ordinarily, we have $G(LHS \Rightarrow RHS) = \Pr(RHS|LHS)$. A modified definition is necessary in the typical alignment scenario where the grammar has no estimates for $\Pr(RHS|LHS)$.

We begin with terminating productions. For the structured components, we retain the usual definition. I.e., $G(X_d[h_d] \Rightarrow h_d) = \Pr(h_d|X_d[h_d])$, where the latter probability can be looked up in a pre-existing D -PGMTG. For the unstructured components, there are no useful nonterminal labels. Therefore, we assume that the unstructured components use only one (dummy) nonterminal label λ , so that $G(X_d[h_d] \Rightarrow h_d) = 1$ if $X = \lambda$ and 0 otherwise.

Our treatment of nonterminating productions follows the standard approach of applying the chain rule for conditional probabilities and then making independence assumptions until all the terms are in a form that can be estimated from data. Readers

¹⁹Recall that PCFGs are a subclass of PGMTGs.

who are not interested in the details can skip ahead to Equation 29. According to the chain rule,²⁰

$$G(X_I^1[h_I^1] \Rightarrow \bowtie [\pi_I^1](Y_I^1[g_I^1] Z_I^1[h_I^1])) = \Pr(\pi_I^1, g_I^1, Y_I^1, Z_I^1 | X_I^1, h_I^1) \quad (20)$$

$$= \Pr(\pi_D^1, g_D^1, Y_D^1, Z_D^1 | X_I^1, h_I^1) \quad (21)$$

$$\times \Pr(Y_I^{D+1}, Z_I^{D+1} | \pi_D^1, g_D^1, Y_D^1, Z_D^1, X_I^1, h_I^1) \quad (22)$$

$$\times \Pr(g_I^{D+1} | \pi_D^1, g_D^1, Y_I^1, Z_I^1, X_I^1, h_I^1) \quad (23)$$

$$\times \Pr(\pi_I^{D+1} | \pi_D^1, g_I^1, Y_I^1, Z_I^1, X_I^1, h_I^1) \quad (24)$$

Our first independence assumption is that the structured components of the production's RHS are conditionally independent of the unstructured components of its LHS:

$$\Pr(\pi_D^1, g_D^1, Y_D^1, Z_D^1 | X_I^1, h_I^1) = \Pr(\pi_D^1, g_D^1, Y_D^1, Z_D^1 | X_D^1, h_D^1) \quad (25)$$

The above probability can be looked up in the pre-existing D -PGMTG. Second, since we have no useful nonterminals in the unstructured components, we let

$$\Pr(Y_I^{D+1}, Z_I^{D+1} | \pi_D^1, g_D^1, Y_D^1, Z_D^1, X_I^1, h_I^1) = \begin{cases} 1 & \text{if } Y_I^{D+1} = Z_I^{D+1} = \lambda_I^{D+1} \\ 0 & \text{otherwise} \end{cases} \quad (26)$$

Third, we assume that the word-to-word translation probabilities are independent of anything else:

$$\Pr(g_I^{D+1} | \pi_D^1, g_D^1, Y_I^1, Z_I^1, X_I^1, h_I^1) = \Pr(g_I^{D+1} | g_D^1) \quad (27)$$

In a typical alignment scenario, these probabilities would be obtained from a word-to-word translation model, which would be estimated under such an independence assumption. Finally, we assume that the output precedence arrays are independent of each other and uniformly distributed, up to some maximum fan-out f . Let $\mu(f)$ be the number of unique precedence arrays of fan-out f or less. Then

$$\Pr(\pi_I^{D+1} | \pi_D^1, g_I^1, Y_I^1, Z_I^1, X_I^1, h_I^1) = \Pr(\pi_I^{D+1}) = \prod_{d=D+1}^I \frac{1}{\mu(f)} = \frac{1}{\mu(f)^{I-D}}. \quad (28)$$

Under Assumptions 25–28,

$$G(X_I^1[h_I^1] \Rightarrow \bowtie [\pi_I^1](Y_I^1[g_I^1] Z_I^1[h_I^1])) = \frac{\Pr(\pi_D^1, g_D^1, Y_D^1, Z_D^1 | X_D^1, h_D^1) \cdot \Pr(g_I^{D+1} | g_D^1)}{\mu(f)^{I-D}} \quad (29)$$

if $Y_I^{D+1} = Z_I^{D+1} = \lambda_I^{D+1}$ and 0 otherwise. The first term in the numerator comes from a D -GMTG, and the second term from a conditional word-to-word translation model. The denominator is a normalization constant.

In the most common case that the multitext is just a bitext, and we have a structured language model for just one of its components, the above equation boils down to

$$G(X_2^1[h_2^1] \Rightarrow \bowtie [\pi_2^1](Y_2^1[g_2^1] Z_2^1[h_2^1])) = \frac{\Pr(\pi_1, g_1, Y_1, Z_1 | X_1, h_1) \cdot \Pr(g_2 | g_1)}{\mu(f)} \quad (30)$$

²⁰The procedure is analogous when the head-child is the first nonterminal link on the RHS, rather than the second. Information about which nonterminal link is the head-child can be encoded in the nonterminal labels.

if $Y_2 = Z_2 = \lambda$ and 0 otherwise. We can use these estimates in the inference rules of Logic C, under any probabilistic semiring.

More sophisticated methods of hierarchical alignment are certainly possible. For example, we could project a part-of-speech tagger (Yarowsky, Ngai, and Wicentowski, 2001) to improve our estimates in Equation 26. Or we could constrain each component with its own monolingual parse tree (Smith and Smith, 2004). Yet, despite their relative simplicity, the above methods for estimating production rule probabilities use all of the available information in a consistent manner, without double-counting. Bootstrapping a PGMTG from a lower-dimensional PGMTG and a word-to-word translation model is similar in spirit to the way that regular grammars can help to induce CFGs (Lari and Young, 1990), and the way that simple translation models can help to bootstrap more sophisticated ones (Brown et al., 1993).

7.2 Word Alignment

A degenerate subclass of hierarchical alignment algorithms is algorithms that produce flat structures, where every leaf is a child of the root. This subclass includes some algorithms for word alignment. A translation lexicon (weighted or not) can be viewed as a degenerate GMTG (not in GCNF) where every production has the form

$$\begin{array}{ccc} S & t_1 & \\ \vdots & \Rightarrow & \vdots \\ S & t_D & \end{array} \quad (31)$$

I.e., each production rewrites the start link into one terminal per component. Under such a GMTG, the logic of word alignment is the one in Melamed (2003)'s Parser A. However, instead of a single goal item, the goal of word alignment is any *set* of items that covers the input exactly once. Also, since nonterminals do not appear on the RHS of production rules, *Compose* inferences are impossible and unnecessary, so they can be removed from the logic if desired.

8. Parameter Estimation

As for other probabilistic grammar formalisms, different parameter estimation methods are possible for PGMTGs. The traditional method for PCFGs is the Inside-Outside algorithm (Baker, 1979), which performs unsupervised maximum likelihood estimation. Here we present a generalization of the logic behind this algorithm to PGMTGs in GCNF. Our generalization can also be used to compute some common approximations to maximum likelihood.

The Inside-Outside algorithm iterates over two stages. The first stage computes inside and outside item values. The second stage aggregates and normalizes these values to update the grammar. Goodman (1998) introduces the terms **forward value** and **reverse value** as generalizations of "inside value" and "outside value", respectively, for arbitrary semirings. The previous section described computation of forward values in terms of a parsing logic, which is a generalization of Goodman (1998)'s bottom-up logic for monolingual parsing. For computing reverse values, Goodman (1998) offers an equation, which we re-express here in terms of forward values $V()$ and reverse values $Z()$:

$$Z(Y_j) = \bigoplus_{\substack{X, Y_1, \dots, Y_k, 1 \leq j \leq k \\ \text{such that } \frac{Y_1, \dots, Y_k}{X}}} Z(X) \otimes \bigotimes_{1 \leq i \leq k, i \neq j} V(Y_i) \quad (32)$$

Goodman (1998, Section 5.1) stated that “we cannot compute the outside probability of a nonterminal until we are finished computing all of the inside probabilities.” However, Equation 32 shows that, in general, it is possible to compute reverse values before computing all forward values. The only values that are necessary for computing the reverse value of an item are the reverse value of the item’s parent and the forward values of the item’s siblings. Forward values of the item’s parent or descendants are not required. For example, it is possible to compute the reverse value of the NP in Figure 6 as soon as the forward value of the V is known, without having computed the forward value of the S, the D, or the N.

It is possible to elaborate the abstract parsing algorithm in Table 2 so that it computes reverse values using Equation 32. E.g., it could compute them after all forward values have been computed, as suggested by Goodman. It could also compute them opportunistically, as soon as it knows the reverse value of the consequent X and the forward values of all the antecedents $Y_1, \dots, Y_k, i \neq j$. However, the question of when to compute term values is a question of search strategy. In keeping with this article’s method of analysis, we abstract away the search strategy and specify only the computational dependencies between item values. Parsing logics are the natural way to express such dependencies. Table 6 shows Logic CR, which can compute both forward and reverse term values. In addition to admitting a variety of search strategies, this logic admits all the parsing semirings studied by Goodman. It can therefore work with the *unmodified* abstract parsing algorithm in Table 2.

The main novelty of Logic CR is its treatment of “reverse” items as a first-class term type. The reverse items and reverse inference rules of Logic CR are defined so that $Z(x) = V(x^R)$. Thus, instead of using Equation 32, the reverse value of an item is computed by Equation 3 as the forward value of the corresponding reverse item. The benefit of this treatment is that computations of reverse item values can be subject to the same kinds of optimization that are used to speed up computation of forward values, including pruning and logic transformations, such as the one proposed by Melamed (2003).

Let us consider how Logic CR extends Logic C. It has two new term types for recording the reverse values of terminal and nonterminal items. Reverse terminal items are useful for at least two purposes. First, if the input is nondeterministic, such as a word lattice coming from the acoustic module of a speech recognizer, then reverse values can be useful for pruning the lattice. Second, it is straightforward to generalize Logic CR into a logic for translation, the same way that Logic C was generalized to Logic CT. Then, reverse values of terminals in the output dimensions could be used to prune and reorder items on the agenda, the same way that a target language model is used in WFST-based SMT. Interestingly, a reverse terminal item can involve any terminal in the grammar, which may or may not correspond to any word in the input. It is perfectly valid to compute reverse values for partial parses whose forward value remains at its initial default (e.g. probability zero). If such values are unnecessary for the application at hand, then their computation can be avoided using logic optimizations analogous to the macro inference rule in Section 6.2.2.

Logic CR also introduces a new kind of axiom called a **pivot**, which declares the reverse value of the item that spans the whole input and has the grammar’s start symbol as its label. It is impossible to infer this value, because computation of an item’s reverse value requires knowing its parent’s reverse value, and an item spanning the whole input cannot have a parent. Fortunately, it is unnecessary to compute this value, because the reverse value of any item labeled with the grammar’s start symbol is always the multiplicative identity of the semiring.

Logic CR has new rules for inferring the new item types. Two *Reverse Compose* rules are required: one for the case where the consequent label comes first on the RHS

Table 6

Logic CR: D is the dimensionality of the grammar and d ranges over dimensions; n_d is the length of the input in dimension d ; i_d ranges over word positions in dimension d , $1 \leq i_d \leq n_d$; w_{d,i_d} are input words; X, Y and Z are nonterminal symbols; t is a terminal symbol; π is a PAV; ν, σ and τ are d-spans.

Term Types	
terminal items	$\langle d, i, t \rangle$ and $\langle d, i, t \rangle^R$
nonterminal items	$[X_D^1; \sigma_D^1]$ and $[X_D^1; \sigma_D^1]^R$
terminating productions	$\begin{array}{ccc} \emptyset_{d-1}^1 & \emptyset_{d-1}^1 & \\ X & \Rightarrow & t \\ \emptyset_D^{d+1} & \emptyset_D^{d+1} & \end{array} \text{ for } 1 \leq d \leq D$
nonterminating productions	$X_D^1 \Rightarrow \bowtie [\pi_D^1](Y_D^1 Z_D^1)$
Axioms	
input words	$\langle d, i_d, w_{d,i_d} \rangle$ for $1 \leq d \leq D, 1 \leq i_d \leq n_d$
grammar terms	as given by the grammar
pivot	$[S_D^1; (0, n_d)_D^1]^R$
Inference Rule Types	
Scan	$\frac{\langle d, i, t \rangle, \begin{array}{ccc} \emptyset_{d-1}^1 & \emptyset_{d-1}^1 & \\ X & \Rightarrow & t \\ \emptyset_D^{d+1} & \emptyset_D^{d+1} & \end{array}}{\left[\begin{array}{cc} \emptyset_{d-1}^1 & ()_{d-1}^1 \\ X & ; (i-1, i) \\ \emptyset_D^{d+1} & ()_D^{d+1} \end{array} \right]}$
Forward Compose	$\frac{[Y_D^1; \tau_D^1], [Z_D^1; \sigma_D^1], X_D^1 \Rightarrow \bowtie [\tau_D^1 \wr \sigma_D^1](Y_D^1 Z_D^1)}{[X_D^1; \tau_D^1 + \sigma_D^1]}$
Reverse Compose Right	$\frac{[Y_D^1; \tau_D^1], [X_D^1; \nu_D^1]^R, X_D^1 \Rightarrow \bowtie [\nu_D^1 \circ \tau_D^1](Y_D^1 Z_D^1)}{[Z_D^1; \nu_D^1 - \tau_D^1]^R}$
Reverse Compose Left	$\frac{[Z_D^1; \sigma_D^1], [X_D^1; \nu_D^1]^R, X_D^1 \Rightarrow \bowtie [\nu_D^1 \circ \sigma_D^1](Y_D^1 Z_D^1)}{[Y_D^1; \nu_D^1 - \sigma_D^1]^R}$
Reverse Scan	$\frac{\left[\begin{array}{cc} \emptyset_{d-1}^1 & ()_{d-1}^1 \\ X & ; (i-1, i) \\ \emptyset_D^{d+1} & ()_D^{d+1} \end{array} \right]^R, \begin{array}{ccc} \emptyset_{d-1}^1 & \emptyset_{d-1}^1 & \\ X & \Rightarrow & t \\ \emptyset_D^{d+1} & \emptyset_D^{d+1} & \end{array}}{\langle d, i, t \rangle^R}$

of the antecedent grammar term, and one for the case where it comes second. The computations of the PAV in the antecedent and the d-span in the consequent of the *Reverse Compose* rules involve two new operators, which perform the inverse operations of $+$ and \wr over d-spans:

- $-$ is the subtraction operator: Given an ordered pair of d-spans ν and τ , it outputs the d-span σ such that $\sigma + \tau = \nu$. The output is undefined if τ contains intervals not covered by ν .
- \oslash is the reverse relativization operator, defined by the equation $\nu \oslash \tau = (\nu - \tau) \wr \tau$.

Both operators apply componentwise to vectors of d-spans.

With an inside semiring, Logic CR can compute the inside and outside item values required for a multidimensional Inside-Outside algorithm. This algorithm can be used to re-estimate the parameters of a PGMTG in GCNF. Equations for aggregation and normalization are necessary to complete the specification of the algorithm. Let $V^q([l])$ be the value of item $[l]$ on iteration q . Let $G^q(P)$ be the value assigned by the grammar to production rule P on iteration q . Let T be the RHS of a terminating production rule. Let I be a vector of word positions and let $\underline{1}$ be a vector of 1's. Then the update equations are²¹:

$$G^{q+1}(X \Rightarrow T) = \frac{\sum_{I_s.t.w_I=T} V^q([X; (I - \underline{1}, I)]) \cdot V^q([X; (I - \underline{1}, I)]^R)}{\sum_I V^q([X; (I - \underline{1}, I)]) \cdot V^q([X; (I - \underline{1}, I)]^R)} \quad (33)$$

$$G^{q+1}(X \Rightarrow \bowtie [\tau \wr \sigma](Y Z)) = \frac{\sum_{\tau, \sigma} V^q([X; \tau + \sigma]^R) \cdot V^q([Y; \tau]) \cdot V^q([Z; \sigma]) \cdot G^q(X \Rightarrow \bowtie [\tau \wr \sigma](Y Z))}{\sum_{\tau, \sigma} V^q([X; \tau + \sigma]) \cdot V^q([X; \tau + \sigma]^R)} \quad (34)$$

To aggregate over multiple training sentence tuples, augment word positions and span boundaries to record the sentence tuple number.

Parsing under the inside semiring requires summing over all possible derivations of the training data, which precludes the efficiency mechanisms suggested in Section 5.4. Given the computational expense of exhaustive multiparsing, cheaper approximations are often desirable. Instead of computing over all possible derivations, we can use only the n best derivations for some fixed maximum n . This approach was also suggested by Brown et al. (1993) for the more sophisticated of their translation models. Logic CR can compute this approximation without modification if it is used with the Viterbi semiring or its n -best generalization. The above update equations are appropriate regardless of which of these semirings is used to compute the values $V(\cdot)$. It is also possible to use a variant of the above equations when $G(\cdot)$ ranges over values in an expectation semiring (Eisner, 2002). Such a variant, together with Logic CR, could compute the expected feature counts necessary to re-estimate a maximum entropy synchronous grammar of the kind used by Chiang (2005).

Our development of Logic CR was motivated by parameter estimation for PGMTGs. Goodman (1998, Section 2.4) suggests several other applications of reverse semiring values:

- pruning,
- defining non-standard criteria for parser performance, and then

²¹We omit the dimension indexes to reduce clutter.

- improving parser performance on those criteria, which can result in
- faster parsing, even without pruning.

In all these applications it is useful to know reverse item values before all the forward values are known.

In addition to the usual “root” goal item, the termination conditions for a typical application of Logic CR would involve the *set* of reverse terminal items that correspond to the input words. Loosely speaking, Logic CR would aim to reach the root goal bottom-up, and then return to the input that it started from top-down. We therefore refer to the class of logics that infer both forward and reverse values as *round-trip parsing logics*.

9. Translation Evaluation by generalized parsing

In recent years, it has become *de rigueur* to evaluate MT systems objectively, using automated comparison with reference translations (Thompson, 1991; Brew and Thompson, 1994). All the currently popular evaluation measures compute some form of string similarity. It is not difficult to imagine how such measures can miscalculate. For example, suppose that the reference translation is (R) below, and that two MT systems output the translations (T1) and (T2).

(R) Pat asked Sandy on Friday about the man from Oslo.

(T1) On Friday, Pat asked Sandy about the man from Oslo.

(T2) Pat from Oslo asked Sandy on Friday about the man.

The sentences in this example are neither long nor complicated. Yet all of the currently popular automatic evaluation methods would incorrectly assign a higher score to (T2) than to (T1), because (T2) has a longer matching n -gram with (R). The problem is that string similarity is only a crude approximation to conceptual similarity. Methods that measure the grammaticality of translations independently of a reference translation (e.g., (Rajman and Hartley, 2001)) are also incapable of making the desired distinctions — (T1) and (T2) are equally grammatical.

More sophisticated MT systems will require more sophisticated evaluation methods. In order to correctly evaluate examples like the one above, an evaluation method needs a catalogue of the syntactic alternations that preserve the meaning of an utterance. Synchronous grammars offer a perspicuous way to describe such alternations. For example, the production

$$\begin{array}{l} \text{NP} \\ \text{NP} \end{array} \Rightarrow \bowtie \begin{array}{l} [1, 2, 3] \\ [1, 3, 2] \end{array} \left(\begin{array}{l} \text{NN PP}_1 \text{ PP}_2 \\ \text{NN PP}_1 \text{ PP}_2 \end{array} \right) \quad (35)$$

could be included, to allow prepositional phrases modifying the same head to switch places. However, the relative order of determiners and adjectives in English noun phrases is strict, so the production

$$\begin{array}{l} \text{NP} \\ \text{NP} \end{array} \Rightarrow \bowtie \begin{array}{l} [1, 2, 3] \\ [2, 1, 3] \end{array} \left(\begin{array}{l} \text{Det Adj NN} \\ \text{Det Adj NN} \end{array} \right) \quad (36)$$

would not be included. The grammar would also include productions that have identical components in both dimensions.

Given such a grammar G , a reference translation R , and an MT system output T , a multiparser can attempt to find a multitree covering the bitext (R, T) under G . If

the parser succeeds, then, according to the grammar, T is a valid translation (actually, paraphrase) of R . If the parser fails, then T is not an acceptable paraphrase of R , either because it does not mean the same thing or because it is ungrammatical.

There are two practical problems with this approach. First, it is usually desirable to obtain a numerical grade of translation quality, rather than just a boolean indicator of acceptability. Second, it would probably be infeasible, or at least unreliable, to compile all the valid syntactic alternations manually. One possible solution to these problems was proposed by Leusch, Ueffing, and Ney (2003), who restricted themselves to a Bracketing Transduction Grammar (Wu, 1995) with just one dummy nonterminal, partitioned its possible production rules into seven classes, and manually assigned a cost for each class.

An alternative approach is to estimate the required grammar empirically. The Linguistic Data Consortium has recently published several “multiple-translations” corpora. These are corpora containing multiple independent translations of a set of source documents, aligned at the sentence level. Each set of independent translations can be viewed as mutual paraphrases (Pang, Knight, and Marcu, 2003). We can estimate a monolingual PGMTG²² from these sets of parallel sentences using exactly the same algorithms that we use to estimate multilingual PGMTG, as described in Sections 7 and 8. Using such a PGMTG, a *probabilistic* multiparser can return the *probability* that a translation is valid with respect to a reference. Different translations and the MT systems that output them can be compared on these scores.

MT evaluation by means of a monolingual PGMTG has two advantages over string-based methods (Melamed, 1995; Papineni et al., 2002; Melamed, Green, and Turian, 2003). First, this method can be sensitive to meaning-preserving syntactic alternations. To the extent that human judges use such information in evaluating MT outputs, an automatic evaluation method that uses such information might do a better job of predicting human judgments. Second, the method itself can be objectively evaluated in terms of its model’s ability to predict held-out data. Such meta-evaluation can be performed without expensive and unreliable human judgments.

A temporary disadvantage of this approach is that research on multitext modeling has not begun yet. The problem of inducing a PGMTG can be approached from the perspective of bilingual language modeling (Wu, 1997), with at least all the methods and challenges of monolingual language modeling. Estimation of a monolingual PGMTG would be hampered by the relatively small size of suitable training data. On the other hand, it is easier to estimate a translation model from a given language to itself than to other languages, if only because the identity relation provides an excellent word-to-word translation model as a starting point.

When good multitext models become available, generalized parsers will become the engine driving yet another important part of the standard SMT architecture.

10. Putting it all together

Figure 9 shows the data-flow diagram for a rudimentary SMT system that is driven by tree-structured translation models. All the generalized parsing algorithms involved can be implemented as different parameterizations of the abstract parsing algorithm in Section 2.5. Below is a sample recipe for running a system of this kind through training, application to new inputs, and evaluation. Unless stated otherwise, each generalized parser’s goal is an item that spans the input and is labeled with the start symbol of the grammar. At runtime, the abstract parser’s termination conditions would typically

²²I.e., a PGMTG that generates the same language in all components.

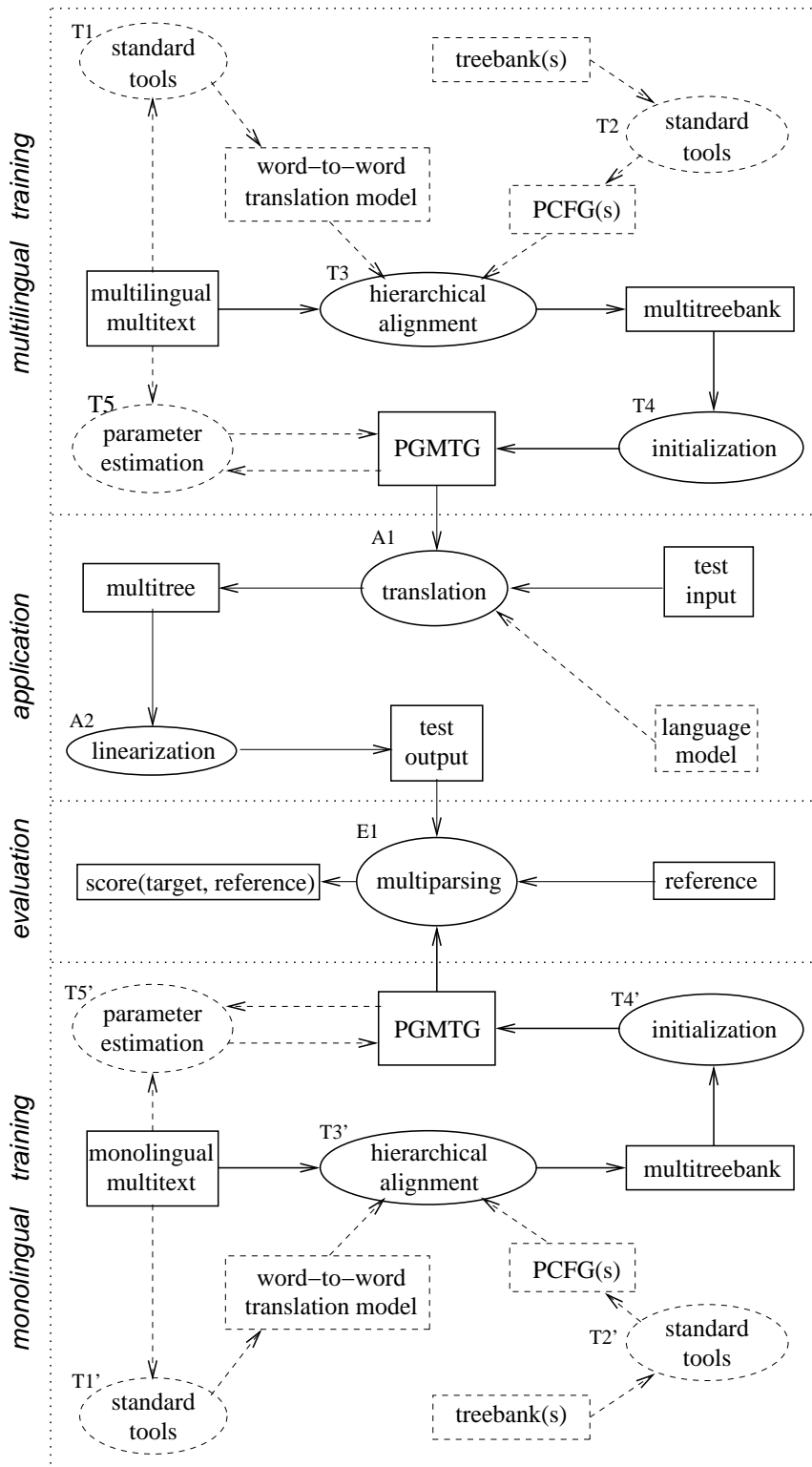

Figure 9
 Data-flow diagram for a rudimentary system for SMT by parsing. Boxes are data; ovals are processes; arcs are flows; dashed flows and data are recommended but optional.

involve goal items as well as limits on time and/or memory consumption. Any search strategy can be used, at least in theory. In practice, we must manage computational complexity, so best-first search is a common favorite.

- T1. Induce a word-to-word translation model. Use Logic A (Melamed, 2003) with enough goal items spanning one word from each component to cover the input. Alternatively, publicly available WFST-based tools can be used (Och and Ney, 2003).
- T2. Induce PCFG(s) from monolingual treebank(s), e.g. by computing the relative frequencies of productions.
- T3. Hierarchically align the training multitext, e.g. using Logic C and the derivation-forest semiring. Constraining PCFG(s) and a word-to-word translation model can be used to imitate a PGMGTG, as described in Section 7. Other approximations can be used if these knowledge sources are not available or if other relevant knowledge sources are available.
- T4. Induce an initial PGMGTG from the multitreebank, e.g. by computing the relative frequencies of productions.
- T5. Re-estimate the PGMGTG parameters using Logic CR, starting with the initial PGMGTG. Ideally, use the inside semiring, but if that's too expensive, then use Viterbi- n -best. In addition to the usual goal item, the termination condition involves the reverse item corresponding to each of the input axioms.
- T1'-T5' Same as T1-T5, but starting with monolingual multitext. The identity relation can be used for T1' as a short-cut.
- A1. Use the PGMGTG to infer the most probable multitree covering the input multitext. Use Logic CT under the Viterbi-derivation semiring. If a target language model is available, use Logic CTM (Melamed, 2004a).
- A2. Linearize the output yield of the multitree.
- E1. For each component of the test output, multiparse the bitext consisting of this component and the corresponding reference translation, using Logic C under the inside semiring and the monolingual PGMGTG.

A variety of algorithms have been proposed for Process T1 (Melamed, 2000; Och and Ney, 2003) and some of them are available as free software. Processes T2, T4, T2', T4', and A2 are trivial. Processes T3, T5, T3', T5', A1, and E1 are the generalizations of parsing and their applications presented in this article. The "Statistical Machine Translation by Parsing" team at the 2005 JHU Language Engineering Workshop used this recipe to build GenPar, the first publicly available system of this type (Burbank et al., 2005). GenPar revolves around a single abstract parser.

11. Summary and Outlook

This article has extended the theory of semiring parsing to present a new analysis of many common parsing algorithms, as well as other algorithms that are not usually considered parsing algorithms. The analysis revealed that all of these algorithms can be implemented by an abstract parsing algorithm with five functional parameters: a grammar, a logic, a semiring, a search strategy, and a termination condition. The article then varied two of these functional parameters — the logic and the grammar — to arrive at

the class of translators and the class of hierarchical aligners. In this manner, the article has elucidated the relationships between ordinary parsing and these other classes of algorithms more precisely than previously possible. The article then presented two new applications of generalized parsing, and showed how the various generalizations and their applications can be used to do all the heavy lifting in a rudimentary system for statistical machine translation by generalized parsing.

There are distinct advantages to building SMT systems in this manner. The software engineering advantage is that improvements invented for one of these algorithms can often be applied to all of them. For example, Melamed (2003) showed how to reduce the computational complexity of a multiparser by a factor of n^D , just by changing the logic. The same optimization can be applied to any generalized parser based on Logics C, CT, or CR. With good software design, such optimizations need never be implemented more than once. Researchers who adopt this approach can concentrate their talents on better models, without worrying about system-specific “decoders.”

A more important advantage in the long term is that this approach to building MT systems encourages MT research to be less specialized and more transparently related to the rest of computational linguistics. A well-understood connection between parsing and SMT algorithms can foster a stronger connection between research in SMT and research in the rest of computational linguistics, a connection that has been weakening in recent years to the detriment of both research communities. Research on SMT by Parsing can build on past and future research on ordinary parsing. Stronger connections between the two research communities would enable more researchers to contribute to MT research, accelerating progress. Conversely, we expect generalized parsers to be useful for other problems with a similar structure, such as sentence compression (Knight and Marcu, 2000) and structured generation (Langkilde, 2000).

The viability of statistical machine translation by generalized parsing will hinge on development of more powerful logics and grammar formalisms than the simplistic examples used in this article. Improved machine learning methods will also be critical. We conjecture that the best SMT systems of the near future will combine new learning algorithms with the expressive power of tree-structured translation models. However, inference is likely to remain the main source of complexity, both conceptual and computational, in these new learning algorithms. As better parameters are invented for the abstract parsing algorithm, we expect the abstractions presented in this article to become even more important in reducing the complexity of statistical machine translation systems.

Acknowledgments

This article greatly benefited from discussions with Giorgio Satta, Joseph Turian, and the “Statistical Machine Translation by Parsing” Workshop Team: Andrea Burbank, Marine Carpuat, Stephen Clark, Markus Dreyer, Pamela Fox, Declan Groves, Keith Hall, Mary Hearne, Yihai Shen, Andy Way, Ben Wellington, and Dekai Wu. Thanks also to the anonymous reviewers for helpful feedback. This research was supported by an NSF CAREER Award, by the DARPA TIDES program, and by an equipment gift from Sun Microsystems.

References

- [Aho and Ullman1969] Aho, A. and J. Ullman. 1969. Syntax directed translations and the pushdown assembler. *Journal of Computer and System Sciences*, 3:37–56, February.
- [Alshawi1996] Alshawi, Hiyun. 1996. Head automata and bilingual tiling: Translation with minimal representations. In *Proceedings of the 34th Annual Meeting of the Association for Computational Linguistics (ACL)*, pages 167–176, Santa Cruz, USA.
- [Baker1979] Baker, J. 1979. Trainable grammars for speech recognition. In *Proceedings of the Spring Conference of the Acoustical Society of America*, pages 547–550.
- [Brew and Thompson1994] Brew, Chris and Henry Thompson. 1994. Automatic evaluation of computer generated text: A progress report on the texteval project. In *ARPA HLT Workshop*.
- [Brown et al.1993] Brown, Peter F., Stephen A. Della Pietra, Vincent Della J. Pietra, and Robert L. Mercer. 1993. The mathematics of statistical machine translation: Parameter estimation. *Computational Linguistics*, 19(2):263–312, June.
- [Burbank et al.2005] Burbank, Andrea, Marine Carpuat, Stephen Clark, Markus Dreyer, Pamela Fox, Declan Groves, Keith Hall, Mary Hearne, I. Dan Melamed, Yihai Shen, Andy Way, Ben Wellington, and Dekai Wu. 2005. Final report on statistical machine translation by parsing. Technical report, Johns Hopkins University Center for Speech and Language Processing. <http://www.clsp.jhu.edu/ws2005/groups/statistical/report.html>.
- [Caraballo and Charniak1998] Caraballo, Sharon and Eugene Charniak. 1998. New figures of merit for best-first probabilistic chart parsing. *Computational Linguistics*.
- [Chiang2005] Chiang, David. 2005. A hierarchical phrase-based model for statistical machine translation. In *ACL05*.
- [Collins and Koo2005] Collins, Michael and Terry Koo. 2005. Discriminative reranking for natural language parsing. *Computational Linguistics*, 31(1):25–69.
- [Ding and Palmer2005] Ding, Yuan and Martha Palmer. 2005. Machine translation using probabilistic synchronous dependency insertion grammars. In *Proceedings of the 43rd Annual Meeting of the Association for Computational Linguistics (ACL)*, Ann Arbor, Michigan.
- [Dorr1994] Dorr, Bonnie. 1994. Machine translation divergences: A formal description and proposed solution. *Computational Linguistics* 20:4, pages 597–633.
- [Eisner and Satta1999] Eisner, J. and G. Satta. 1999. Efficient Parsing for Bilexical Context-Free Grammars and Head-Automaton Grammars. In *Proceedings of the 37th Annual Meeting of the Association for Computational Linguistics (ACL)*, pages 457–464, College Park, Maryland, June.
- [Eisner2002] Eisner, Jason. 2002. Parameter estimation for probabilistic finite-state transducers. In *Proceedings of*

the 40th Annual Meeting of the Association for Computational Linguistics (ACL), Philadelphia, July.

In *Proceedings of the 23rd Annual Meeting of the Association for Computational Linguistics (ACL)*, pages 127–132, Chicago, IL.

- [Eng et al.2003] Eng, Katherine, Alex Fraser, Daniel Gildea, Viren Jain, Zhen Jin, Shankar Kumar, Sanjeev Khudanpur, Franz Och, Dragomir Radev, Anoop Sarkar, Libin Shen, David Smith, and Kenji Yamada. 2003. Final report, syntax for statistical MT group, JHU workshop 2003. Technical report, The Center for Language and Speech Processing, The Johns Hopkins University.
- [Jurafsky and Martin2000] Jurafsky, Daniel and James H. Martin. 2000. *Speech and Language Processing*. Prentice-Hall.
- [Kasami1965] Kasami, Tadao. 1965. An efficient recognition and syntax algorithm for context-free languages. Technical Report AF-CRL-65-758, Air Force Cambridge Research Laboratory, Bedford, MA.
- [Gildea2003] Gildea, Daniel. 2003. Loosely tree-based alignment for machine translation. In *Proceedings of the 40th Annual Meeting of the Association for Computational Linguistics (ACL)*, Sapporo, Japan, July.
- [Klein and Manning2003] Klein, Dan and Christopher D. Manning. 2003. A* parsing: Fast exact viterbi parse selection. In *Proceedings of the Human Language Technology Conference and the North American Association for Computational Linguistics (HLT-NAACL)*, Edmonton, Canada.
- [Goodman1998] Goodman, Joshua. 1998. *Parsing Inside-Out*. Ph.D. thesis, Harvard University.
- [Knight1999] Knight, Kevin. 1999. Decoding complexity in word-replacement translation models. *Computational Linguistics, Squibs and Discussion*, 25(4).
- [Groves, Hearne, and Way2004] Groves, Declan, Mary Hearne, and Andy Way. 2004. Robust sub-sentential alignment of phrase-structure trees. In *Proceedings of the 20th International Conference on Computational Linguistics (COLING) 2004*, Switzerland, August.
- [Knight and Köhn2003] Knight, Kevin and Philipp Köhn. 2003. What's new in statistical machine translation. In *Tutorial presented at Human Language Technology Conference (HLT)*. Available at <http://www.isi.edu/~koehn/publications/tutorial2003.pdf>.
- [Han, Han, and Ko2001] Han, Chung-Hye, Ra-Rae Han, and Eon-Suk Ko. 2001. Bracketing guidelines for the penn korean treebank. Technical Report IRCS-01-010, IRCS, University of Pennsylvania.
- [Knight and Marcu2000] Knight, Kevin and Daniel Marcu. 2000. Statistics-based summarization — step one: Sentence compression. In *Proceedings of the American Association for Artificial Intelligence (AAAI)*.
- [Hwa et al.2002] Hwa, Rebecca, Philip Resnik, Amy Weinberg, and Okan Kolak. 2002. Evaluating translational correspondence using annotation projection. In *Proceedings of the 40th Annual Meeting of the Association for Computational Linguistics (ACL)*, Philadelphia, July.
- [Koehn, Och, and Marcu2003] Koehn, Philipp, Franz Josef Och, and Daniel Marcu. 2003. Statistical phrase-based translation. In *Proceedings of the Human Language Technology Conference and the North American Association*
- [Johnson1985] Johnson, Mark. 1985. Parsing with discontinuous constituents.

for *Computational Linguistics (HLT-NAACL)*, pages 127–133, Edmonton, Canada.

the *North American Chapter of the Association for Computational Linguistics (NAACL)*, Pittsburgh, June.

- [Kumar and Byrne2003] Kumar, Shankar and William Byrne. 2003. A weighted finite state transducer implementation of the alignment template model for statistical machine translation. In *Proceedings of the Human Language Technology Conference and the North American Association for Computational Linguistics (HLT-NAACL)*, pages 63–70, Edmonton, Canada.
- [Langkilde2000] Langkilde, Irene. 2000. Forest-based statistical sentence generation. In *Proceedings of the Human Language Technology Conference of the North American Chapter of the Association for Computational Linguistics*, Seattle, May.
- [Lari and Young1990] Lari, K. and S. Young. 1990. The estimation of stochastic context-free grammars using the inside-outside algorithm. *Computer Speech and Language*, pages 35–56.
- [Lü et al.2002] Lü, Y., S. Li, T. Zhao, and M. Yang. 2002. Learning Chinese bracketing knowledge based on a bilingual language model. In *Proceedings of the International Conference on Computational Linguistics (COLING) 2002*, Taipei, Taiwan, August.
- [Leusch, Ueffing, and Ney2003] Leusch, Gregor, Nicola Ueffing, and Hermann Ney. 2003. A novel string-to-string distance measure with applications to machine translation evaluation. In Elliott Macklovitch, editor, *Proceedings of MT Summit IX*, pages 33–40, New Orleans, September. International Association for Machine Translation.
- [Mann and Yarowsky2001] Mann, Gideon S. and David Yarowsky. 2001. Multipath translation lexicon induction via bridge languages. In *Proceedings of the 2nd Meeting of the North American Chapter of the Association for Computational Linguistics (NAACL)*, Pittsburgh, June.
- [Matsumoto et al.1993] Matsumoto, Y., H. Ishimoto, T. Utsuro, and M. Nagao. 1993. Structural Matching of Parallel Texts. In *Proceedings of the 31st Annual Meeting of the Association for Computational Linguistics (ACL)*, Columbus, Ohio, June.
- [McAllester2002] McAllester, David. 2002. On the complexity analysis of static analysis. *Journal of the ACM*, 49(4).
- [Melamed1995] Melamed, I. Dan. 1995. Automatic evaluation and uniform filter cascades for inducing n-best translation lexicons. In *Proceedings of the 3rd ACL Workshop on Very Large Corpora (WVLC)*, Cambridge, Massachusetts.
- [Melamed2000] Melamed, I. Dan. 2000. Models of translational equivalence among words. *Computational Linguistics*, 26(2):221–249, June.
- [Melamed2003] Melamed, I. Dan. 2003. Multitext grammars and synchronous parsers. In *Proceedings of the Human Language Technology Conference and the North American Association for Computational Linguistics (HLT-NAACL)*, pages 158–165, Edmonton, Canada.
- [Melamed2004a] Melamed, I. Dan. 2004a. Algorithms for syntax-aware statistical machine translation. In *Proceedings of the 10th Conference on Theoretical and Methodological Issues in Machine Translation (TMI)*, Baltimore, MD.
- [Melamed2004b] Melamed, I. Dan. 2004b. Statistical machine translation by parsing. In *Proceedings of the 42nd Annual Meeting of the Association for Computational Linguistics (ACL)*, Barcelona, Spain.
- [Melamed, Green, and Turian2003] Melamed, I. Dan, Ryan Green, and Joseph P. Turian. 2003. Precision

and recall of machine translation. Technical Report 03-004, NYU. A revised version of the paper presented at NAACL/HLT 2003.

- [Melamed, Satta, and Wellington2004] Melamed, I. Dan, Giorgio Satta, and Benjamin Wellington. 2004. Generalized multitext grammars. In *Proceedings of the 42nd Annual Meeting of the Association for Computational Linguistics (ACL)*, Barcelona, Spain.
- [Meyers, Yangarber, and Grishman1996] Meyers, Adam, Roman Yangarber, and Ralph Grishman. 1996. Alignment of shared forests for bilingual corpora. In *Proceedings of the 16th International Conference on Computational Linguistics*, Copenhagen, Denmark.
- [Och and Ney2001] Och, Franz Josef and Hermann Ney. 2001. Statistical multi-source translation. In *Proceedings of Machine Translation Summit VIII*, pages 253–258, Santiago de Compostela, Spain, September.
- [Och and Ney2002] Och, Franz Josef and Hermann Ney. 2002. Discriminative training and maximum entropy models for statistical machine translation. In *Proceedings of the 40th Annual Meeting of the Association for Computational Linguistics (ACL)*, Philadelphia, July.
- [Och and Ney2003] Och, Franz Josef and Hermann Ney. 2003. A systematic comparison of various statistical alignment models. *Computational Linguistics*, 29(1).
- [Och, Tillmann, and Ney1999] Och, Franz Josef, Christoph Tillmann, and Hermann Ney. 1999. Improved alignment models for statistical machine translation. In *Proceedings of the 4th Conference on Empirical Methods in Natural Language Processing (EMNLP)*, pages 20–28, College Park, Maryland.
- [Pang, Knight, and Marcu2003] Pang, Bo, Kevin Knight, and Daniel Marcu. 2003. Syntax-based alignment of multiple translations: Extracting paraphrases and generating new sentences. In *Proceedings of the Human Language Technology Conference and the North American Association for Computational Linguistics (HLT-NAACL)*, Edmonton, Canada.
- [Papineni et al.2002] Papineni, Kishore, Salim Roukos, Todd Ward, and Wei-Jing Zhu. 2002. Bleu: a method for automatic evaluation of machine translation. In *Proceedings of the 40th Annual Meeting of the Association for Computational Linguistics (ACL)*, Philadelphia, July.
- [Rajman and Hartley2001] Rajman, Martin and Tony Hartley. 2001. Automatically predicting MT systems rankings compatible with fluency, adequacy or informativeness scores. In *Proceedings of the Workshop on Machine Translation Evaluation: "Who Did What To Whom"*, pages 29–34, Santiago de Compostela, Spain.
- [Shieber, Schabes, and Pereira1995] Shieber, S., Y. Schabes, and F. Pereira. 1995. Principles and implementation of deductive parsing. *Journal of Logic Programming*, 24(1&2):3–36.
- [Sima'an1996] Sima'an, Khalil. 1996. Computational complexity of probabilistic disambiguation by means of tree-grammars. In *Proceedings of the 16th International Conference on Computational Linguistics*, Copenhagen, Denmark.
- [Simard et al.2005] Simard, Michel, Nicola Cancedda, Bruno Cavestro, Marc Dymetman, Eric Guassier, Cyril Goutte, and Kenji Yamada. 2005. Translating with non-contiguous phrases. In *Proceedings of the 10th Conference on Empirical Methods in Natural Language Processing (EMNLP)*, Vancouver, Canada.
- [Smith and Smith2004] Smith, David and Noah Smith. 2004. Bilingual parsing with factored estimation: Using

english to parse korean. In *Proceedings of the 9th Conference on Empirical Methods in Natural Language Processing (EMNLP)*, pages 49–56, Barcelona, Spain.

translation. In *Proceedings of the 34th Annual Meeting of the Association for Computational Linguistics (ACL)*, pages 152–158, Santa Cruz, USA.

- [Stolcke1995] Stolcke, Andreas. 1995. An efficient probabilistic context-free parsing algorithm that computes prefix probabilities. *Computational Linguistics*, 21(2):165–201, June.
- [Taskar et al.2004] Taskar, B., Dan Klein, Michael Collins, Daphne Koller, and Chris Manning. 2004. Max-margin parsing. In *Proceedings of the 9th Conference on Empirical Methods in Natural Language Processing (EMNLP)*, Barcelona, Spain.
- [Thompson1991] Thompson, Henry. 1991. Automatic evaluation of translation quality: Outline of methodology and report on pilot experiment. In *(ISSCO) Proceedings of the Evaluators' Forum*, pages 215–223, Geneva, Switzerland.
- [Turian and Melamed2005] Turian, Joseph P. and I. Dan Melamed. 2005. Constituent parsing by classification. In *Proceedings of the 9th International Workshop on Parsing Technologies (IWPT)*, Vancouver, Canada.
- [Uchimoto et al.2004] Uchimoto, Kiyotaka, Yujie Zhang, Kiyoshi Sudo, Masaki Murata, Satoshi Sekine, and Hitoshi Isahara. 2004. Multilingual aligned parallel treebank corpus reflecting contextual information and its applications. In *Proceedings of the Multilingual Language Resources (MLR2004)*, Geneva, Switzerland.
- [Wu1995] Wu, Dekai. 1995. Stochastic inversion transduction grammars, with application to segmentation, bracketing, and alignment of parallel corpora. In *Proceedings of the 14th International Joint Conference on Artificial Intelligence (IJCAI)*, Montreal, Canada.
- [Wu1996] Wu, Dekai. 1996. A polynomial-time algorithm for statistical machine translation. In *Proceedings of the 34th Annual Meeting of the Association for Computational Linguistics (ACL)*, pages 152–158, Santa Cruz, USA.
- [Wu1997] Wu, Dekai. 1997. Stochastic inversion transduction grammars and bilingual parsing of parallel corpora. *Computational Linguistics*, 23(3):377–404, September.
- [Wu2000] Wu, Dekai. 2000. Alignment. In Robert DALE, Hermann MOISL, and Harold SOMERS, editors, *Handbook of Natural Language Processing*. Marcel Dekker, pages 415–458.
- [Yamada and Knight2002] Yamada, Kenji and Kevin Knight. 2002. A decoder for syntax-based statistical MT. In *Proceedings of the 40th Annual Meeting of the Association for Computational Linguistics (ACL)*, pages 303–310, Philadelphia, July.
- [Yarowsky, Ngai, and Wicentowski2001] Yarowsky, David, Grace Ngai, and Richard Wicentowski. 2001. Inducing multilingual text analysis tools via robust projection across aligned corpora. In *Proceedings of the Human Language Technology Conference (HLT)*.
- [Younger1967] Younger, D. H. 1967. Recognition and parsing of context-free languages in time n^3 . *Information and Control*, 10(2):189–208, February.
- [Zens and Ney2003] Zens, Richard and Hermann Ney. 2003. A comparative study on reordering constraints in statistical machine translation. In *Proceedings of the 40th Annual Meeting of the Association for Computational Linguistics (ACL)*, Sapporo, Japan, July.