

Diffuse-Charge Dynamics in Electrochemical Systems

Martin Z. Bazant^{1,2}, Katsuyo Thornton³, and Armand Ajdari²

¹ *Department of Mathematics, Massachusetts Institute of Technology, Cambridge, MA 02139*

² *Laboratoire de Physico-Chimie Théorique, UMR ESPCI-CNRS 7083, 10 rue Vauquelin, F-75005 Paris, France*

³ *Department of Materials Science and Engineering, Northwestern University, Evanston, IL 60201*

(Dated: February 2, 2008)

The response of a model micro-electrochemical system to a time-dependent applied voltage is analyzed. The article begins with a fresh historical review including electrochemistry, colloidal science, and microfluidics. The model problem consists of a symmetric binary electrolyte between parallel-plate, blocking electrodes which suddenly apply a voltage. Compact Stern layers on the electrodes are also taken into account. The Nernst-Planck-Poisson equations are first linearized and solved by Laplace transforms for small voltages, and numerical solutions are obtained for large voltages. The “weakly nonlinear” limit of thin double layers is then analyzed by matched asymptotic expansions in the small parameter $\epsilon = \lambda_D/L$, where λ_D is the screening length and L the electrode separation. At leading order, the system initially behaves like an RC circuit with a response time of $\lambda_D L/D$ (not λ_D^2/D), where D is the ionic diffusivity, but nonlinearity violates this common picture and introduce multiple time scales. The charging process slows down, and neutral-salt adsorption by the diffuse part of the double layer couples to bulk diffusion at the time scale, L^2/D . In the “strongly nonlinear” regime (controlled by a dimensionless parameter resembling the Dukhin number), this effect produces bulk concentration gradients, and, at very large voltages, transient space charge. The article concludes with an overview of more general situations involving surface conduction, multi-component electrolytes, and Faradaic processes.

I. INTRODUCTION

There is rapidly growing interest in micro-electrochemical or biological systems subject to time-dependent applied voltages or currents. For example, AC voltages applied at microelectrodes can be used to pump liquid electrolytes [1, 2, 3, 4, 5, 6, 7, 8, 9, 10, 11], to separate or self-assemble colloidal particles [12, 13, 14, 15, 16, 17, 18], and to manipulate biological cells and vesicles [19, 20, 21]. Conversely, oscillating pressure-driven flows can be used to produce frequency-dependent streaming potentials to probe the structure of porous media [22, 23, 24].

A common feature of these diverse phenomena is the dynamics of diffuse charge in microscopic systems. Although the macroscopic theory of neutral electrolytes with quasi-equilibrium double layers is very well developed in electrochemistry [25, 26] and colloidal science [27, 28, 29], microscopic double-layer charging at subdiffusive time scales is not as well understood. Although much progress has been made in various disjoint communities, it is not so widely appreciated, and some open questions remain, especially regarding nonlinear effects. The goals of this paper are, therefore, (i) to review the relevant literature and (ii) to analyze a basic model problem in considerable depth, highlighting some new results and directions for further research.

To illustrate the physics of diffuse-charge dynamics, consider the simplest possible case sketched in Fig. 1: a dilute $z:z$ electrolyte suddenly subjected to a DC voltage, $2V$, by parallel-plate blocking electrodes separated by $2L$. Naively, one might assume a uniform bulk electric field, $E = V/L$, but the effect of the applied voltage is not so trivial. Ions migrate in the bulk field and eventually

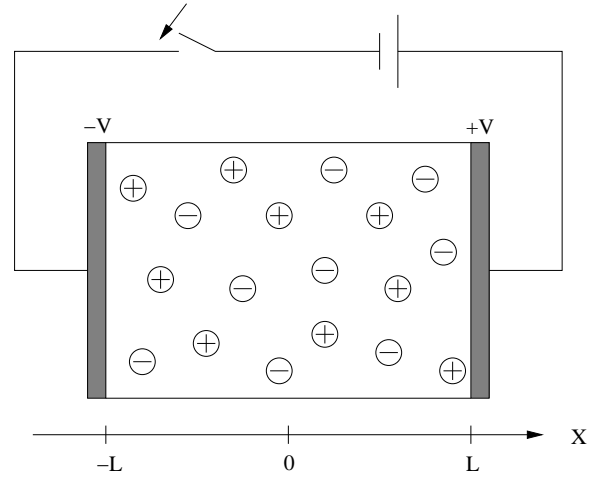

FIG. 1: Sketch of the model problem. A voltage $2V$ is suddenly applied to a dilute, symmetric, binary electrolyte between parallel-plate, blocking electrodes separated by $2L$.

screen it completely (since “blocking electrodes” do not support a Faradaic current).

What is the characteristic time scale of this response? For charge relaxation, one usually quotes the time, $\tau_D = \lambda_D^2/D$, for diffusion with a diffusivity D across one Debye screening length,

$$\lambda_D = \sqrt{\frac{\epsilon kT}{2z^2 e^2 C_b}}, \quad (1)$$

where C_b is the average solute concentration, k Boltzmann’s constant, T the temperature, e is the electronic charge, and ϵ the permittivity of the solvent [27, 28, 29]. The Debye time, τ_D , is a material property of the electrolyte, which for aqueous solutions ($\lambda_D \approx 1 - 100$ nm,

$D \approx 10^3 \mu\text{m}^2/\text{s}$) is rather small, in the range of ns to μs . More generally, when Faradaic reactions occur (for a non-blocking electrode), diffuse charge may also vary on the much slower, geometry-dependent scale for bulk diffusion given by $\tau_L = L^2/D$, proportional to the square of the electrode separation.

These two relaxation times, τ_D for the charge density and τ_L for the concentration, are usually presented as the only ones controlling the evolution of the system, e.g. as in the recent textbooks of Hunter [27] (Ch. 8) and Lyklema [29] (Chs. 4.6c). Dimensional analysis, however, allows for many other time scales obtained by combining these two, such as the harmonic mean,

$$\tau_c = \sqrt{\tau_D \tau_L} = \frac{\lambda_D L}{D}, \quad (2)$$

proportional to the electrode separation (not squared). Below, we will show that this is the primary time scale for diffuse-charge dynamics in electrochemical cells, although τ_D , τ_L , and other time scales involving surface properties also play important roles, especially at large voltages (even without Faradaic processes). The same applies to highly polarizable or conducting colloidal particles, where L is the particle size.

Although the basic charging time, τ_c , is familiar in several scientific communities [31, 32, 33, 34], it is not as widely known as it should be. Recently, it has been rediscovered as the (inverse) frequency of “AC pumping” at patterned-surface micro-electrodes [1, 6]. As in the past, its theoretical justification has sparked some controversy [35, 36] related to the applicability of classical circuit models [37, 38] in which τ_c arises as the “RC time” of a bulk resistor in series with a double-layer capacitor (see below).

Here, we attempt to unify and modestly extend a large body of prior work on diffuse-charge dynamics in the context of our model problem, paying special attention to effects which undermine the classical circuit approximation. Going beyond most previous mathematical studies, we allow for compact-layer capacitance, bulk concentration polarization, and large voltages outside the linear regime. For the nonlinear analysis, the method of matched asymptotic expansions [39, 40, 41] must be adapted for multiple time scales at different orders of the expansion, so the problem also presents an opportunity for mathematicians to develop time-dependent boundary-layer theory.

We begin in section II by reviewing some of the relevant literature on electrochemical relaxation. In section III we state the mathematical problem for a suddenly applied DC voltage, and in section IV we analyze the linear response using Laplace transforms. In section V we non-dimensionalize the problem and describe numerical solutions, used to test our analytical approximations. In section VI, we derive uniformly valid asymptotic expansions in the “weakly nonlinear” limit of thin double layers and discuss the connection with circuit models. Apparently for the first time (for this problem), in section VII we

analyze higher-order corrections, and in section VIII we briefly discuss the “strongly nonlinear” regime at large voltages, where the expansions are no longer valid. In section IX, we conclude by briefly discussing extensions to higher dimensions, general electrolytes, and Faradaic processes and posing some open questions.

II. HISTORICAL REVIEW

A. Electrical Circuit Models

In electrochemistry, the most common theoretical approach is to construct an equivalent electrical circuit, whose parameters are fit to experimental impedance spectra or pulsed-voltage responses, as recently reviewed by Macdonald [37] and Geddes [38]. The basic idea of an equivalent circuit is apparently due to Kohlrausch [42] in 1873, and the first mathematical theory of Kohlrausch’s “polarization capacitance” was given by Warburg at the end of the nineteenth century [46, 47]. Warburg argued that AC electrochemical response is dominated by pure diffusion of the active species and can be described a bulk resistance in series with a frequency-dependent capacitance, which combine to form the “Warburg impedance”.

Earlier, Helmholtz [43, 44] had suggested that the solid-electrolyte interface acts like a thin capacitor, for which he apparently coined the term, “double layer” [25]. In 1903 Krüger [48] unified Warburg’s bulk impedance with Helmholtz’ double-layer capacitor in the first complete AC circuit model for an electrochemical cell, which forms the basis for the modern “Randles circuit” [49]. In this context, the relaxation time for charging of the double layers has been known to depend on the electrode separation, via the bulk resistance, for at least a century.

The study of diffuse charge in the double layer was initiated in the same year by Gouy [45], who suggested that excess ionic charge in solution near the electrode could be viewed as a capacitance, $C_D = \varepsilon/\lambda_D$. He was also the first to derive Equation (1) for λ_D (obviously with different notation) in his original theory of the diffuse double layer in equilibrium [50, 51]. With the availability of Einstein’s relation [52] for the mobility, $\mu = D/kT$, at that time, the DC bulk resistance (per unit area) could have been calculated as

$$R_b = \frac{V}{J} = \frac{LE_0}{\sigma_b E_0} = \frac{\lambda_D^2 L}{\varepsilon D} \quad (3)$$

(for a symmetric binary electrolyte of equal mobilities), where J is the current density and

$$\sigma_b = \frac{\varepsilon D}{\lambda_D^2} = \frac{2(ze)^2 C_0 D}{kT} \quad (4)$$

is the bulk conductivity. Therefore, basic time scale in Eq. (2) has essentially been contained in circuit models since roughly 1910 as the relaxation time,

$$\tau_c = R_b C_D = \frac{\lambda_D L}{D} = \frac{C_D L}{\sigma_b} = \frac{\varepsilon L}{\lambda_D \sigma_b} \quad (5)$$

although τ_c was not stated explicitly as $\lambda_D L/D$ for perhaps another fifty years [31].

Today, Gouy’s screening length bears the name of Debye, who rederived it in 1923 as part of his seminal work with Hückel [53, 54] on charge screening in bulk electrolytes, using an equivalent formalism. Debye and Hückel solved for the spherical screening cloud around an ion, and, due to the low potentials involved, they linearized the transport equations, allowing them to handle general electrolytes. When Gouy [51] considered the identical problem of screening near a flat, blocking electrode more than a decade earlier, he obtained exact solutions to full nonlinear equations for the equilibrium potential profile in several cases of binary electrolytes, $z_+/z_- = 1, 2,$ and $\frac{1}{2}$, where z_+ and z_- are the cation and anion charge numbers, respectively.

A few years later, Chapman [55] independently derived Gouy’s solution for a univalent electrolyte, $z_+ = z_- = 1$, the special case of “Gouy-Chapman theory” for which they are both primarily remembered today. Chapman also gave a simple form for the charge-voltage relation of the diffuse-layer capacitor in this case, which, upon differentiation, yields a simple formula for the nonlinear differential capacitance of the diffuse layer,

$$C_D(\zeta) = \frac{\varepsilon}{\lambda_D} \cosh\left(\frac{ze\zeta}{kT}\right), \quad (6)$$

where ζ is the voltage across the diffuse layer in thermal equilibrium. (Here, we include the trivial extension to a general $z:z$ electrolyte.) Combining Eqs. (3) and (6), we also obtain the basic relaxation time, τ_c , in Eq. (2) multiplied by a potential-dependent factor in the usual case of nonzero equilibrium zeta potential (in the absence of an applied voltage). This factor may be neglected in the Debye-Hückel limit of small potentials, $\zeta \ll kT/ze$, but it becomes important at large potentials and generally slows down the final stages of double-layer charging.

More sophisticated models of the double layer were proposed by many subsequent authors [56, 57] and incorporated into AC circuit models for electrochemical cells [25, 58, 59]. Naturally, the original ideas of Helmholtz and Gouy were eventually combined into a coherent whole. In 1924, Stern [60] suggested decomposing the double layer into a “compact” (Helmholtz) part within a molecular distance of the surface and a “diffuse” (Gouy) part extending into the solution at the scale of the screening length. Physically, the compact layer is intended to describe ions (at the outer Helmholtz plane) whose solvation molecules are in contact with the surface, although specifically adsorbed ions (themselves in contact with the surface) may also be included [61]. Regardless of the precise microscopic picture, however, Stern introduced the compact layer as an intrinsic surface capacitance, which cuts off the divergent capacitance of the diffuse layer, Eq.(6), at large zeta potentials.

Using this model of two capacitors in series and neglecting specific adsorption, Grahame [62] applied Gouy-Chapman theory for the diffuse part and inferred the non-

linear differential capacitance of the compact part from his famous experiments on electrified liquid-mercury drops. Macdonald [63] then developed a mathematical model for double layers at metal electrodes by viewing the compact layer as a parallel-plate capacitor, as we do below, although he also allowed its thickness and capacitance to vary due to electrostriction and dielectric saturation [64]. The reader is referred to various recent reviews [37, 38, 59] to learn how other effects neglected below, such as specific adsorption and Faradaic processes for non-blocking electrodes, have been included empirically in modern circuit models.

In spite of a century of research, open questions remain about the applicability of circuit models [38], and even the most sophisticated fits to experimental data still suffer from ambiguities [37]. One problem is the somewhat arbitrary distinction between the diffuse layers and the bulk electrolyte, which in fact comprise a single, continuous region. Even accepting this partition, it is clear that the non-uniform evolution of ionic concentrations in both regions cannot be fully captured by homogeneous circuit elements [65]. Another problem is the further partitioning of the double layer into two (or more) poorly defined regions at atomic lengths scales, where macroscopic continuum theories (e.g. for dielectric response) are of questionable validity [66].

B. Microscopic Transport Models

An alternative theoretical approach, pursued below, is to solve the time-dependent Nernst-Planck equations [67, 68, 69] for ionic transport across the entire cell (outside any molecular-scale compact layers) without distinguishing between the diffuse-charge layers and the quasi-neutral bulk. Because this “phenomenological” [32] approach requires solving Poisson’s equation for the mean-field electrostatic potential (self-consistently generated by the continuum charge density) down to microscopic (and sometimes atomic) length scales, it lacks the thermodynamic justification of traditional macroscopic theories based on bulk electroneutrality and electrochemical potentials [26]. Nevertheless, it addresses time-dependent charge-relaxation phenomena, which do occur in real systems, with fewer *ad hoc* assumptions than circuit models and thus may be considered closer to first principles. The use of the Nernst-Planck equations at scales smaller than the screening length (but still larger than atomic dimensions) is also supported by the success of Gouy-Chapman theory in predicting the diffuse-layer capacitance in a number of experimental systems (e.g. Refs. [62, 63]), because the theory is based on the steady-state Nernst-Planck equations for thermal equilibrium. The main difficulty in working with the Nernst-Planck equations, aside from mathematical complexity, is perhaps in formulating appropriate boundary conditions at the electrode surface, just outside any compact layers.

Although the response to a suddenly applied DC volt-

age has been considered by a few authors in the linear [70, 71, 73] and nonlinear [32, 72] regimes, as we also do below, much more analysis has been reported for the case of weak AC forcing, where the equations are linearized and the time dependence is assumed to be sinusoidal. These simplifications are made mainly for analytical convenience, although they have direct relevance for the interpretation of impedance spectra. An early analysis of this type was due to Ferry [30], who considered the response of a semi-infinite electrolyte to an oscillating charge density applied at a electrode surface. Ferry’s treatment is formally equivalent to the classical theory of dielectric dispersion in bulk electrolytes [74, 75]. Naturally, in both cases the same time scale, $\tau_D = \lambda_D^2/D$, arises, and the relaxation of the double layer has no dependence on the macroscopic geometry.

Ferry’s analysis of a single electrode is consistent with the common intuition that double-layer charging should be a purely microscopic process, but one might wonder how the electrode could draw charge “from infinity” when an infinite electrolyte has infinite resistance. Indeed, as emphasized by Buck [73] and Macdonald [31] and confirmed by detailed comparisons with experimental impedance spectra, Ferry’s analysis is fundamentally flawed, starting from the boundary conditions: It is not possible to control the microscopic charge density at an electrode surface and neglect its coupling to bulk transport processes; instead, one imposes a voltage relative to another electrode and observes the resulting current (or vice versa), while the surface charge density evolves self-consistently.

Buck [73] eventually corrected Ferry’s analysis to account for the missing “IR drop” across two electrodes which imposes the initial surface charge density (or, alternatively, voltage). Nevertheless, the physical picture of a double-layer responding locally to “charge injection”, independent of bulk transport processes, persists to the present day. For example, recent textbooks on colloidal science (Hunter [27], p. 408; Lyklema [29], p. 4.78) present a slightly different version of Ferry’s analysis (attributed to O’Brien) as the canonical problem of “double-layer relaxation”: the response of a semi-infinite electrolyte to a suddenly imposed, constant surface charge density. This gives some insight into high frequency dielectric dispersion of non-polarizable colloids (the usual case), but it is not relevant for polarizable particles and electrodes. Three decades after Buck and Macdonald, it is worth re-emphasizing the fundamental coupling of double-layer charging of bulk transport in finite, polarizable systems.

The mathematical theory of AC response for a finite, two-electrode system began with Jaffé’s analysis for semiconductors [76, 77] and was extended to liquid electrolytes by Chang and Jaffé [78]. A number of restrictive assumptions in these studies, such as a uniform electric field, were relaxed by Macdonald [79] for semiconductors and electrolytes and independently by Friauf [80] for ionic crystals. These authors, who gave perhaps the

first complete mathematical solutions, also allowed for bulk generation/recombination reactions, which are crucial for electrons and holes in semiconductors. Subsequent authors mostly neglected bulk reactions in studies of liquid [31, 73, 81, 82, 83] and solid [71, 84] electrolytes, while focusing on other effects, such as arbitrary ionic valences and the compact layer.

Although it is implicit in earlier work, Macdonald [31] first clearly identified the geometry-dependent time scale, $\tau_c = \lambda_D L/D$, (in this form) as governing the relaxation of an electrochemical cell. It was also derived independently by Kornyshev and Vorontyntsev [71, 72] in the Russian literature on solid electrolytes with one mobile ionic species [32]. With Itskovich [85], these authors also modeled the compact-layer capacitance via a mixed Dirichlet-Neumann condition on the Nernst-Planck equations. This classical boundary condition [25], also used below, introduces another length scale, λ_S , the effective width of the Stern layer, which also affects the time scales for electrochemical relaxation.

Other important surface properties have also been included in mathematical analyses of AC response. For example, several recent studies of blocking electrodes have included the effect of a nonzero equilibrium zeta potential (away from the point of zero charge) [65, 86, 87, 88], building on the work of Delacey and White [89]. A greater complication is to include Faradaic processes at non-blocking electrodes through boundary conditions of the Butler-Volmer type [26, 56, 57], as suggested by Levich [90] and Frumkin [91]. This approach has been followed in various analyses of AC response around base states of zero [32, 72, 85, 92, 93, 94] and nonzero [95, 96] steady Faradaic current. Numerical solutions of the time-dependent Nernst-Planck equations have also been developed for AC response and more general situations [89, 97, 98], following the original work of Cohen and Cooley [99].

C. Colloids and Microfluidic Systems

Diffuse-charge dynamics occurs not only near electrodes, but also around colloidal particles and in microfluidic systems, where the coupling with fluid flow results in time-dependent, nonlinear electrokinetic phenomena. This review may be the first to unify some of the fairly disjoint literatures on diffuse-charge dynamics in these areas with the older literature in electrochemistry discussed above. Compared to the latter, more sophisticated mathematical analyses are often done in colloidal science and electro-microfluidics, starting from the Nernst-Planck equations for ion transport and the Navier-Stokes equations for fluid mechanics in two or three dimensions. On the other hand, with the notable exception of the Ukrainian school [29, 34, 100, 101], less attention is paid to surface properties, and simple boundary conditions are usually assumed (constant zeta potential and complete blocking of ions) which exclude diffuse-

charge dynamics.

This might explain why the material time scale, τ_D , is emphasized as the primary one for double-layer relaxation around colloidal particles [27, 28, 29], although the mixed time scale, $\tau_c = (L/\lambda_D)\tau_D$, has come to be recognized as controlling bulk-field screening by electrodes [65, 86, 87, 88]. This thinking can be traced back to the seminal work of Debye and Falkenhagen [74, 75] on dielectric dispersion in bulk electrolytes, mentioned above. In that context, when a background field E_b is applied to an electrolyte, the relevant geometrical length is the size of the screening cloud around an ion, $L = \lambda_D$, over which a voltage, $E_b\lambda_D$, is effectively applied. The relevant RC time for the polarization of the screening cloud is then, $\tau_c = \lambda_D\lambda_D/D = \tau_D$. The possible role of geometry is masked by the presence of only one relevant length scale, λ_D .

For colloidal particles, which are usually much larger than the double-layer thickness, the second time scale, $\tau_a = a^2/D$, for bulk diffusion around a particle of radius, a , becomes important, especially in strong fields. If there is significant surface conduction or the particle is conducting, the ‘‘RC’’ time scale, $\tau_c = \lambda_D a/D$, can also become important. In general, double-layer relaxation is thus sensitive to the size and shape of the particle. Although it is largely unknown (and rarely cited) in the West, many effects involving non-uniform double-layer polarization around colloidal particles have been studied under the name, ‘‘non-equilibrium electric surface phenomena’’ [33], as recently reviewed by S. S. Dukhin [34, 101].

The colloidal analog of our model problem involving a blocking electrochemical cell is that of an ideally polarizable, metal particle in a suddenly applied background electric field. This situation has received much less attention than the usual case of non-conducting particles of fixed surface charge density, but it has an interesting history. The non-uniform polarization of the double layer for a metal particle was perhaps first described by Levich [102], using Helmholtz’ capacitor model. Simonov and Shilov [103, 104] later considered diffuse charge and showed that the metal particle acquires an induced dipole moment opposite to the field over the time scale, $\tau_c = \lambda_D a/D$, as bulk conduction transfers charge from the part of the double-layer facing away from the field to the part facing toward the field. The two hemispheres may be viewed as capacitors coupled through a continuous bulk resistor [104], as in the RC circuit model of DC electrochemical cells described above. The charging process continues until the redistribution of diffuse-charge completely eliminates the normal component of the electric field, responsible for charging the double layer.

Diffuse-charge dynamics is important in the context of colloids because it affects electrokinetic phenomena. In the metal-sphere example, the remaining tangential component of the field interacts with the non-uniform induced diffuse charge (and zeta potential) to cause nonlinear electro-osmotic flows [100, 105], which causes hy-

drodynamic interactions between colloidal particles. Although these flows have little effect on the electrophoresis of charged polarizable particles in uniform DC fields [106, 107], they significantly affect dielectrophoresis in nonuniform AC fields [108, 109], where the time-dependence of double-layer relaxation also plays an important role.

These developments followed from pioneering studies of S. S. Dukhin, B. V. Deryagin, and collaborators [33, 34, 110, 111] on the effects of surface conduction and concentration gradients on electrical polarization and electro-osmotic flows around highly charged non-conducting particles, which was also extended to polarizable particles [100]. (Similar ideas were also pursued later in the Western literature, with some new results [27, 112, 113, 114, 115].) Earlier still, Bikerman [116, 117, 118] presented the original theory of surface conduction in the double layer, and Overbeek [119] first calculated in detail the effect of non-equilibrium double-layer polarization on electrophoresis.

Diffuse-charge dynamics has begun to be exploited in microfluidic devices, albeit without the benefit of the prior literature in electrochemistry and colloidal science discussed above. In a series of recent papers, Ramos and collaborators have predicted and observed ‘‘AC electro-osmosis’’ at a pair of blocking micro-electrodes [1, 2, 3, 4, 5]. Their simple explanation of double-layer dynamics [1, 2], supported by a mathematical analysis of AC response in two dimensions [4], is similar to that of Simonov and Shilov for a metal particle in an AC field [104], and the resulting electro-osmotic flow is of the type described by Gamanov et al. for metal particles [105]. An important difference, however, is that AC electro-osmosis occurs at fixed micro-electrodes, whose potentials are controlled externally, as opposed to free colloidal particles. Ajdari [6] has proposed a similar means of pumping liquids using AC voltages applied at an array of micro-electrodes, where broken symmetries in surface geometry or chemistry generally lead to net pumping past the array, as observed in subsequent experiments [7, 8, 9, 10]. These are all examples of the general principle of ‘‘induced-charge electro-osmosis’’ [120, 121], where diffuse-charge dynamics at polarizable surfaces (not necessarily electrodes) is used to drive micro-flows with AC or DC forcing. Clearly, the full range of possible microfluidic applications of time-dependent nonlinear electrokinetics has yet to be explored.

D. The Limit of Thin Double Layers

All of the analytical studies cited above that go beyond linear response (and most that do not) are based on the thin-double-layer approximation, $\lambda_D \ll L$. In this limit, the bulk electrolyte remains quasi-neutral, and the double layer remains in thermal quasi-equilibrium, even with time dependent forcing (slower than τ_D) [26, 27, 28, 29, 34]. The same limit also justifies the general notion of circuit models for the diffuse part of the double

layer and, in the absence of concentration gradients, the neutral bulk region.

As first shown by Grafov and Chernenko [122, 123] in the Soviet Union and by Newman [124] and Macgillivray [125] in the United States, the thin double-layer approximation for electrochemical cells can be given “firm” (but not necessarily “rigorous”) mathematical justification by the method of matched asymptotic expansions [39, 40, 41] in the small parameter, $\epsilon = \lambda_D/L$. For steady Faradaic conduction, the usual leading-order approximation involves a neutral bulk with charged boundary layers of $O(\epsilon)$ dimensionless width, which has since been established rigorously in a number of studies by mathematicians [126, 127, 128, 129, 130, 131]. The standard asymptotic approximation breaks down, however, near Nernst’s diffusion-limited current, where the concentration at the cathode vanishes. At the limiting current [132], the boundary layer expands to $O(\epsilon^{2/3})$ width, while at still larger currents [133], a layer of “space charge” extends out to $O(1)$ distances into the bulk region, although the effect of realistic boundary conditions (Faradaic processes, compact layer, etc.) remains to be studied in these exotic regimes. Matched asymptotic expansions are also beginning to be used for time-dependent electrochemical problems with Faradaic processes [95, 96] below the limiting current.

Perhaps because it originated in fluid mechanics [41], the method of matched asymptotic expansions has been used extensively in colloidal science and microfluidics [4, 34, 111, 112, 113, 114, 115, 134, 135], albeit with varying degrees of mathematical rigor. In any case, the advantages of the technique are (i) to justify the assumption of equilibrium structure for the double layers (at leading order), regardless of transport processes in the neutral bulk, and (ii) to view the double layers as infinitely thin at the bulk length scale, which is particularly useful in multidimensional problems. For statics or dynamics at the bulk diffusion time, it is usually possible to construct uniformly valid approximations by adding the inner and outer solutions and subtracting the overlap.

The thin double layer approximation is “asymptotic” as $\epsilon \rightarrow 0$, which means that the ratio of the approximation to the exact solution approaches unity for sufficiently small ϵ , with all other parameters held fixed. For any fixed $\epsilon > 0$ (no matter how small), however, the approximation breaks down at sufficiently large voltages. The general criterion

$$\frac{\lambda_D}{a} \cosh\left(\frac{ze\zeta}{2kT}\right) \ll 1 \quad (7)$$

is often quoted for the validity of Smoluchowski’s formula for the electrophoretic mobility of a thin-double-layer particle [27], as justified by numerical calculations [136]. This is related to S. S. Dukhin’s seminal work on double-layer distortion around a spherical particle [34, 111, 135]: In the case of highly charged particles, $\zeta \gg kT/ze$, the “Dukhin number” Du (which he called “*Rel*”) controls corrections to the thin-double-layer limit, $Du = 0$.

The Dukhin number is defined as the ratio of the double-layer surface conductivity, σ_s , to the bulk conductivity, σ_b , in Eq. (4) per geometrical length, a : $Du = \sigma_s/\sigma_b a$. Although its effect on electrophoresis was first explored in detail by Dukhin, the same dimensionless group was defined a few decades earlier by Bikerman [118], who also realized that it would play a fundamental role in electrokinetic phenomena. In a symmetric binary electrolyte with equal diffusivities, the Dukhin number can be put in the simple form,

$$\begin{aligned} Du &= \frac{2\lambda_D(1+m)}{a} \left[\cosh\left(\frac{ze\zeta}{2kT}\right) - 1 \right] \\ &= \frac{4\lambda_D(1+m)}{a} \sinh^2\left(\frac{ze\zeta}{4kT}\right). \end{aligned} \quad (8)$$

where

$$m = \left(\frac{kT}{ze}\right)^2 \frac{2\epsilon}{\eta D} \quad (9)$$

is a dimensionless number giving the relative importance of electro-osmosis compared with electro-migration and diffusion in surface conduction, and η is the viscosity. This form is due to Deryagin and Dukhin [137], who generalized Bikerman’s original results [116, 117] to account for electro-osmotic surface conductance ($m > 0$). For $Du \ll 1$ the double-layer remains in its equilibrium state at constant zeta potential, but for $Du \gg 1$ it becomes distorted as surface conduction draws current lines into the double layer. For a detailed pedagogical discussion, we refer to Lyklema [29].

It is interesting to note that (at least at large zeta potentials) the Dukhin number is similar to the ratio of the effective RC time, $\tau_c(\zeta)$, away from the point of zero charge ($\zeta \neq 0$) to the bulk diffusion time, τ_a :

$$\frac{\tau_c(\zeta)}{\tau_a} = \frac{\lambda_D}{a} \cosh\left(\frac{ze\zeta}{kT}\right) \quad (10)$$

where we have used Eqs. (3)–(6). Moreover, the usual condition (7) for the validity of the thin double-layer approximation in quasi-steady electrokinetic problems is also a statement about time scales: $\tau_c(\zeta) \ll \tau_L$. When this condition is violated, the usual RC charging dynamics is slowed down so much by nonlinearity that bulk diffusion may complicate the picture. Whether this does in fact occur depends on if the nonlinearity is strong enough to cause significant concentration depletion in the bulk for a given geometry and forcing. Understanding this issue requires going beyond leading order in asymptotic analysis, which is not trivial.

In spite of extensive work on the asymptotic theory of diffuse-charge dynamics, difficult open questions remain. The leading-order thin-double-layer approximation is well understood in many cases, but higher-order corrections have been calculated in only a few heroic instances, such as the asymptotic analysis of diffusiophoresis by Prieve et al. [114]. Moreover, such detailed analysis

has mostly (if not exclusively) been done for quasi-steady problems. For time-dependent problems of double-layer charging, it seems that higher-order terms in uniformly-valid matched asymptotic expansions have never been calculated.

Even the leading-order behavior is poorly understood when the *induced* zeta potential is large enough to violate the condition (7). In that case, the effective Dukhin number varies with time, as the total zeta potential evolves in time and space. On the other hand, the Russian literature on non-equilibrium electro-surface phenomena at large Du mostly pertains to highly charged particles in weak fields, where the constant *equilibrium* zeta potential is large, but the time-dependent induced zeta potential is small.

Below, we begin to explore these issues in the much simpler context of a one-dimensional problem involving parallel-plate electrodes, which excludes surface conduction and electro-osmotic flow. We shall see that this requires extending standard boundary-layer theory, which deals with multiple length scales, to account for simultaneous multiple time scales. Before examining the nonlinear theory, however, we state the mathematical model and study its exact solution in the linear limit of small potentials.

III. THE BASIC MATHEMATICAL PROBLEM

As the simplest problem retaining the essential features of diffuse-charge dynamics, we consider a dilute, completely dissociated $z : z$ electrolyte, limited by two parallel, planar, blocking electrodes at $X = \pm L$. We describe the concentrations of the charged ions by continuum fields, $C_{\pm}(X, \tau)$, which satisfy the Nernst-Planck equations,

$$\frac{\partial C_{\pm}}{\partial \tau} = -\frac{\partial}{\partial X} \left[-D \frac{\partial C_{\pm}}{\partial X} \mp \mu z e C_{\pm} \frac{\partial \Phi}{\partial X} \right] \quad (11)$$

(without generation/recombination reactions), where Φ is the electrostatic potential, which describes the Coulomb interaction in a mean-field approximation. For simplicity we assume that the diffusion coefficients of the two ionic species are equal to the same constant, D , and obtain the mobility, μ , from the Einstein relation, $\mu = D/kT$. The total ionic charge density, ρ_e , controls the spatial variation of the potential, Φ , through Poisson's equation,

$$-\varepsilon \frac{\partial^2 \Phi}{\partial X^2} = \rho_e = ze(C_+ - C_-) \quad (12)$$

where ε is the dielectric permittivity of the solvent, assumed to be a constant.

As described above, we focus on “ideally polarizable” or “completely blocking” electrodes without Faradaic processes, so the ionic fluxes have to vanish there:

$$F_{\pm} = -D \frac{\partial C_{\pm}}{\partial X} \mp \frac{zeD}{k_B T} C_{\pm} \frac{\partial \Phi}{\partial X} = 0, \quad \text{for } X = \pm L. \quad (13)$$

The Faradaic current density, $J = ze(F_+ - F_-)$, also vanishes at the electrodes, although it can be nonzero elsewhere as diffuse charge moves around inside the cell. We also take into account the intrinsic capacitance of the electrode surface through a mixed boundary condition for the potential [25, 85, 95]. The surface capacitance may represent a Stern layer of polarized solvent molecules [60] and/or a dielectric coating on the electrode [63]. If $V_{\pm}(t)$ is the external potential imposed by the external circuit on the electrode at $X = \pm L$, then we assume

$$\Phi = V_{\pm} \mp \lambda_S \frac{\partial \Phi}{\partial X}, \quad \text{at } X = \pm L, \quad (14)$$

where λ_S is an effective thickness for the compact part of the double layer. For a simple dielectric layer, this is equal to its actual thickness times the ratio, $\varepsilon/\varepsilon_S$, of dielectric constants of the solvent and the Stern layer, ε_S .

In order to study nonlinear effects and avoid imposing a time scale, we consider the response to a step in voltage (a suddenly applied DC voltage), rather than the usual case of weak AC forcing. For times $\tau < 0$, no voltage is applied, and we assume no spontaneous charge accumulation at the electrodes. The initial ionic concentrations are uniform, $C_{\pm}(X, \tau < 0) = C_0$. For $\tau > 0$, a voltage difference $2V$ is applied between the two electrodes, $V_{\pm}(\tau > 0) = \pm V$, and we solve for the evolution of the concentrations and the potential. As $\tau \rightarrow \infty$, the bulk electric field at the center, $|E(0, \tau)| = \partial \Phi / \partial X$, decays from its initial value, V/L , to zero, due to screening by diffuse charge which is transferred from the right side of the cell ($0 < X < 1$) to the left ($-1 < X < 0$). The relaxation is complete when the Faradaic current decays to zero in steady state, from its initial uniform value, $J(X, 0) = J_0 = -\sigma_b V/L = -2(ze)^2 C_0 DV/kTL$.

IV. LINEAR DYNAMICS

A. Transform Solution for Arbitrary λ_D, λ_S, L

For applied potentials much smaller than the thermal voltage, $V \ll k_B T/ze$, the equations can be linearized, $C_{\pm} = C_0 + \delta C_{\pm}$, so that the ionic charge density, $\rho_e = ze(C_+ - C_-) = ze(\delta C_+ - \delta C_-)$, obeys the Debye-Falkenhagen equation [74],

$$\frac{1}{D} \frac{\partial \rho_e}{\partial \tau} \approx \frac{\partial^2 \rho_e}{\partial X^2} - \kappa^2 \rho_e \quad (15)$$

where $\kappa = \lambda_D^{-1}$ is the inverse screening length. This equation can also be written as a conservation law,

$$\frac{\partial \rho_e}{\partial \tau} = -\frac{\partial J_e}{\partial X} \quad (16)$$

in terms of the linearized total ionic electrical current,

$$J_e \approx -D \frac{\partial \rho_e}{\partial X} - D \kappa^2 \varepsilon \frac{\partial \Phi}{\partial X} \quad (17)$$

which vanishes at the blocking electrodes, $X = \pm L$.

To solve the model problem, which involves a step-potential in time, it is convenient to use Laplace transforms, defined by

$$\hat{f}(S) = \int_0^\infty d\tau e^{-S\tau} f(\tau). \quad (18)$$

As $\rho_e(X) = 0$ for $\tau < 0$, the Laplace transforms of Eqs. (12) and (15) are

$$\frac{\partial^2 \hat{\rho}_e}{\partial X^2} = k^2 \hat{\rho}_e \quad (19)$$

$$-\varepsilon \frac{\partial^2 \hat{\Phi}}{\partial X^2} = \hat{\rho}_e \quad (20)$$

where

$$k(S)^2 = \frac{S}{D} + \kappa^2. \quad (21)$$

The general antisymmetric solution to Eq. (19) is,

$$\hat{\rho}_e(X, S) = A \sinh(kX) \quad (22)$$

for some constant $A(S)$, which, substituting into Eq. (20) and integrating, yields,

$$-\varepsilon_w \frac{\partial \hat{\Phi}}{\partial X}(X, S) = \frac{A}{k} \cosh(kX) + B, \quad (23)$$

where the constant $B(S)$, determined by $\hat{J}_e(\pm L, S) = 0$, is given by

$$B = Ak \cosh(\kappa_S L) (\kappa^{-2} - k^{-2}). \quad (24)$$

Integrating Eq. (23) again and enforcing antisymmetry yields the Laplace transform of the potential,

$$\hat{\Phi}(X, S) = -A \frac{\cosh(kL)}{\varepsilon k^2} \left(\frac{\sinh(kX)}{\cosh(kL)} + \frac{kSX}{\kappa^2 D} \right) \quad (25)$$

The remaining constant,

$$A = \frac{-k^2 \varepsilon V S^{-1} \operatorname{sech}(kL)}{\tanh(kL) + \lambda_S k + \frac{kSL}{\kappa^2 D} \left(1 + \frac{\lambda_S}{L}\right)} \quad (26)$$

is determined by the Stern-layer boundary condition, Eq. (14).

B. Long-time Exponential Relaxation

There is a great deal of information about transients in the Laplace transform of exact solution to the linear problem. For times much smaller than the Debye time, $\tau \ll \tau_D = \lambda_D^2/D$ (or $S \gg \kappa^2 D$), there is no significant response, so we are mainly interested in the response at longer times, $\tau \gg \tau_D$ (or $S \ll \kappa^2 D$). There are many ways to see that this is generally an exponential relaxation dominated by the mixed time scale discussed above, $\tau_c = \lambda_D L/D$, although several other time scales allowed by dimensional analysis also play a role.

1. Diffuse Charge Density at a Surface

Let us focus on one quantity, for example, the Laplace transform of the charge density at the anode, $\hat{\rho}_e(X = L, S)$. The exact formula is

$$\hat{\rho}_e(L, S) = A \sinh(kL), \quad (27)$$

which is difficult to invert analytically. (Keep in mind that k depends on S .) For times much longer than the Debye time, we consider the limit, $S \ll \kappa^2 D$, in which the Laplace transform takes the much simpler asymptotic form,

$$\hat{\rho}_e(L, S) \sim \frac{K_\rho S^{-1}}{1 + \tau_\rho S} \quad (28)$$

where

$$K_\rho = -\frac{\varepsilon V \kappa^2}{1 + \kappa \lambda_S \coth(\kappa L)} \quad (29)$$

and

$$\tau_\rho = \frac{L}{\kappa D} \left[\frac{\coth(\kappa L) \left(1 + \frac{3\lambda_S}{2L}\right) - \frac{1}{2} \kappa \lambda_S \operatorname{csch}^2(\kappa L) - \frac{1}{\kappa L}}{1 + \kappa \lambda_S \coth(\kappa L)} \right] \quad (30)$$

Since the Laplace transform of $1 - \exp(-\tau/\tau_o)$ is $S^{-1}/(1 + S\tau_o)$, this result clearly shows that the buildup of the charged screening layer occurs exponentially over a characteristic response time given by Eq. (30), which is of order, $L/\kappa D = \lambda_D L/D = \tau_c$, for both thin and thick double layers. Corrections introduce other mixed scales involving the Stern length, such as $\lambda_S L/D$ and $\lambda_S \lambda_D/D$, as well as the Debye time, λ_D^2/D .

Note that the same time scale can also be seen in the linear response to a weak oscillatory potential, $V_\pm = \pm V \operatorname{Re}(e^{i\omega\tau})$, which naturally leads to

$$\rho_e(L, \tau) \sim K_\rho \operatorname{Re} \left(\frac{e^{i\omega\tau}}{1 + i\omega\tau_\rho} \right) \quad (31)$$

for frequencies well below the Debye frequency, $\omega \ll \omega_D = D/\lambda_D^2$. Similar results for AC response near the point of zero charge have been obtained by many authors, as cited above. The characteristic frequency, $\omega_c = 1/\tau_c \approx D/\lambda_D L$, also arises the context of AC electro-osmotic fluid pumping near micro-electrodes [1, 6], because diffuse-layer charging controls the time-dependence of the effect.

2. Total Diffuse Charge in an Interface

We now show that the same form of long-time exponential relaxation, with a somewhat *different* characteristic time, also holds for other quantities, such as the total diffuse charge near the cathode,

$$Q(t) = \int_{-L}^0 \rho(X, t) dX, \quad (32)$$

which plays a central role in the nonlinear analysis below. In the limit of thin double layers, this is simply the total interfacial charge (per unit area) of the diffuse part of the double layer. Here we consider the total diffuse charge near a surface more generally, even when the Debye screening length is much larger than the electrode separation. In the latter case, the concept of an “interface” is not well defined, since the two sides of the cell interact very strongly, but we can still study the overall separation of diffuse charge caused by the applied voltage.

Using Eqs. (20) and (23), the Laplace transform of the total cathodic charge is,

$$\hat{Q}(S) = Ak^{-1} [1 - \cosh(kL)]. \quad (33)$$

Once again, this is difficult to invert analytically, so we focus on the long-time limit,

$$\hat{Q}(S) \sim \frac{K_Q S^{-1}}{1 + \tau_Q S}, \quad (34)$$

for $S \ll \kappa^2 D$, where

$$K_Q = \frac{\varepsilon V \kappa [1 - \operatorname{sech}(\kappa L)]}{\tanh(\kappa L) + \kappa \lambda_S} \quad (35)$$

and

$$\tau_Q = \frac{L}{\kappa D} \left\{ \frac{1 + \frac{1}{2} \operatorname{sech}^2(\kappa L) + \frac{3\lambda_S}{2L}}{\tanh(\kappa L) + \kappa \lambda_S} - \frac{\operatorname{sech}(\kappa L) \tanh(\kappa L)}{2 [1 - \operatorname{sech}(\kappa L)]} - \frac{1}{2\kappa L} \right\} \quad (36)$$

In the limit of thin double layers, the same basic time scale, $\tau_c = L/\kappa D = \lambda_D L/D$, arises as in the case of the surface charge density. A subtle observation is that the relaxation of the total interfacial charge, although still exponential, has a somewhat different time scale as a function of $\epsilon = \lambda_D/L$ and $\delta = \lambda_S/\lambda_D$. (See Fig. 2 below.) This apparently new result shows that charging dynamics has a nontrivial dependence on time and space, even for very weak potentials.

V. DIMENSIONLESS FORMULATION AND NUMERICAL SOLUTION

A. Basic Equations

In preparation for analysis of the full, nonlinear problem, we cast it in a dimensionless form using L as the reference length scale and $\tau_c = \lambda_D L/D$ as the reference time scale, as motivated by the linear theory. Time and space are then represented by $t = \tau D/\lambda_D L$ and $x = X/L$, and the problem is reformulated through reduced variables: $c = (C_+ + C_-)/2C_0$ for the local salt concentration, $\rho = (C_+ - C_-)/2C_0 = \rho_e/(2C_0 z e)$ for the charge density, and $\phi = ze\Phi/k_B T$ for the electrostatic potential.

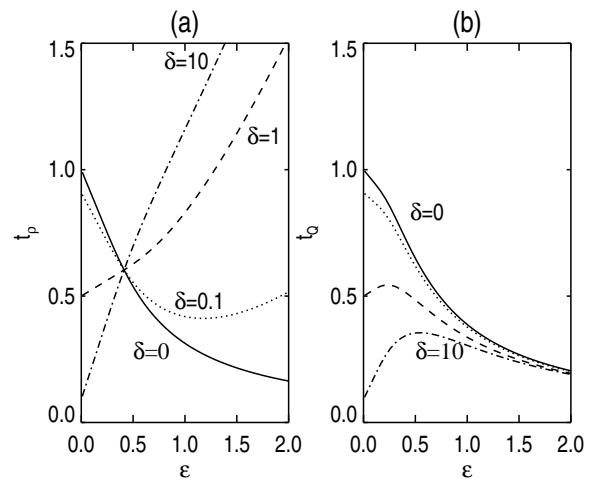

FIG. 2: Analytical results for the exponential relaxation time from the linear theory for weak applied potentials, ($V \ll kT/ze$). The time scale for relaxation of the surface diffuse-charge density, t_ρ , from Eq. (45) is shown in (a) and that of the total interfacial (half-cell) diffuse charge, t_Q , from Eq. (50) in (b). In each case, the charging time, scaled to $\tau_c = L/\kappa D = \lambda_D L/D$, is plotted versus the dimensionless diffuse-layer thickness, $\epsilon = \lambda_D/L$, for different dimensionless Stern-layer thicknesses, $\delta = \lambda_S/\lambda_D = 0, 0.1, 1, 10$ (solid, dot, dash, and dot-dash lines, respectively).

The solution is determined by only three dimensionless parameters: $v = zeV/k_B T$, the ratio of the applied voltage to the thermal voltage, $\epsilon = \lambda_D/L$, the ratio of the Debye length to the system size, and $\delta = \lambda_S/\lambda_D$, the ratio of the Stern length to the Debye length [95].

With these definitions, the dimensionless equations for $-1 < x < 1$ and $t > 0$ are

$$\frac{\partial c}{\partial t} = \epsilon \frac{\partial}{\partial x} \left(\frac{\partial c}{\partial x} + \rho \frac{\partial \phi}{\partial x} \right) \quad (37)$$

$$\frac{\partial \rho}{\partial t} = \epsilon \frac{\partial}{\partial x} \left(\frac{\partial \rho}{\partial x} + c \frac{\partial \phi}{\partial x} \right) \quad (38)$$

$$-\epsilon^2 \frac{\partial^2 \phi}{\partial x^2} = \rho \quad (39)$$

with boundary conditions at $x = \pm 1$,

$$\frac{\partial c}{\partial x} + \rho \frac{\partial \phi}{\partial x} = 0 \quad (40)$$

$$\frac{\partial \rho}{\partial x} + c \frac{\partial \phi}{\partial x} = 0 \quad (41)$$

$$v - \delta \epsilon \frac{\partial \phi}{\partial x} = \pm \phi \quad (42)$$

and initial conditions, $c(x, 0) = 1$, $\rho(x, 0) = 0$, and $\phi(x, 0) = vx$. Note that the limit of a negligible screening length, $\epsilon \rightarrow 0$, is *singular* because it is impossible to satisfy all the boundary conditions when $\epsilon = 0$. Physically, this corresponds to the limit of exact charge neutrality, $\rho = 0$, which is always violated to some degree at electrochemical interfaces.

The total diffuse charge near the cathode is

$$q(t) = \int_{-1}^0 \rho(x, t) dx, \quad (43)$$

scaled to $2zeC_0L$. The dimensionless Faradaic current density is,

$$j_F = \frac{\partial \rho}{\partial x} + c \frac{\partial \phi}{\partial x}, \quad (44)$$

scaled to $2zeC_0D/L$ (Nernst's diffusion-limited current [95]).

B. Time Scales for Linear Response

The time scale for exponential relaxation of the surface charge density in the linear theory above, Eq. (30), has the dimensionless form,

$$t_\rho = \frac{(1 + 3\delta\epsilon/2) \coth(\epsilon^{-1}) - \delta \operatorname{csch}^2(\epsilon^{-1})/2 - \epsilon}{1 + \delta \coth(\epsilon^{-1})}. \quad (45)$$

As shown in Fig. 2(a), this formula shows that for a wide range of diffuse and Stern layer thicknesses, the basic time scale is always roughly of order, $\lambda_D L/D$, since t_c is of order 1. In the limit of a thin diffuse double layer, the dimensionless time scale has the form,

$$t_\rho = \frac{1}{1 + \delta} + \left(\frac{3\delta - 2}{2(1 + \delta)} \right) \epsilon + O(e^{-\epsilon^{-1}}). \quad (46)$$

with exponentially small errors. In the limit of a thin Stern layer, the time scale becomes

$$t_\rho = \coth(\epsilon^{-1}) - \epsilon + \left[5\epsilon \coth(\epsilon^{-1}) - 2 \coth(\epsilon^{-1}) - \operatorname{csch}^2(\epsilon^{-1}) \right] \frac{\delta}{2} + O(\delta^2). \quad (47)$$

For simultaneously thin Stern and diffuse layers, we obtain the simple result,

$$t_\rho \sim 1 - \epsilon - \delta \quad (48)$$

which, as in Fig. 2(a), shows that increasing either $\epsilon = \lambda_D/L$ or $\delta = \lambda_S/\lambda_D$ tends to reduce the charging time in this limit, compared to the leading-order value, $\lambda_D L/D$. Putting the units back, this expression can be written as,

$$\tau_\rho \sim \frac{\lambda_D L}{D} - \frac{\lambda_D^2}{D} - \frac{\lambda_S L}{D} \quad (49)$$

for $\lambda_S \ll \lambda_D \ll L$, which clearly shows the Debye time, λ_D^2/D , appearing only as a small perturbation of the intermediate time scale, $\lambda_D L/D$, for the relaxation of the cell.

Similar results hold for the relaxation time for the total half-cell charge, Eq. (36), which has the dimensionless form,

$$t_Q = \frac{1 + \frac{1}{2} \operatorname{sech}^2(\epsilon^{-1}) + \frac{3\delta\epsilon}{2}}{\tanh(\epsilon^{-1}) + \delta} - \frac{\epsilon}{2} - \frac{\operatorname{sech}(\epsilon^{-1}) \tanh(\epsilon^{-1})}{2 [1 - \operatorname{sech}(\epsilon^{-1})]} \quad (50)$$

For thin double layers, we obtain the same leading-order behavior,

$$t_Q \sim \frac{1}{1 + \delta} - \left[\frac{1 - 2\delta}{2(1 + \delta)} \right] \epsilon + O(e^{-\epsilon^{-1}}) \quad (51)$$

although the correction term is somewhat different for thick diffuse layers. For simultaneously thin diffuse and Stern layers, the dimensionless relaxation time for the total charge becomes,

$$t_Q \sim 1 - \frac{\epsilon}{2} - \delta. \quad (52)$$

For a detailed summary of how the two time scales, t_ρ and t_Q , depend on the parameters, ϵ and δ , see Figure 2 (a) and (b), respectively.

C. Numerical Solution

Our dimensionless model problem, stated in Section V A, is straightforward to solve numerically using finite differences, at least if ϵ is not too small. (Ironically, as shown below, analytical progress is much easier in this singular limit.) To resolve the boundary layer where the gradient is large, a variable size mesh is used, along with second-order-accurate differencing that accounts for the variable grid sizes. The third-order Adams-Bashforth method is used in time. The number of the grid points and the ratio of the smallest to largest grid size are varied depending on the values of ϵ and v . The numerical convergence is verified through multiple runs of different resolutions, and as a result, up to 1024 points are used in calculations for higher v .

To maximize the importance of diffuse charge, we first consider a rather larger value of ϵ , even for a micro-electrochemical system, $\epsilon = 0.05$, say for $\lambda_D = 5$ nm and $L = 0.1 \mu\text{m}$. The Stern length is always of molecular dimensions, so we choose $\lambda_S = 5$ Å, and thus $\delta = 0.1$. The time evolutions of the charge and potential are shown in Fig. 3 for $v = 0.1$ and $v = 1$. At room temperature (and $z = 1$), these voltages correspond to $V = 2.5$ mV and $V = 25$ mV, respectively, which, when transferred to the diffuse layer after screening give maximum electric fields of order 10 V/ μm .

The current, j , and the total cathodic diffuse charge, q , are plotted versus time, t , in Fig. 4 for applied voltages, $v = 1, 2, 3$, and 4. In all cases, the linearization is accurate at early times ($t < 1$) since the dimensionless voltage across the diffuse layer remains small (< 1). For $v = 1$, the linear approximation is reasonable for all times, but

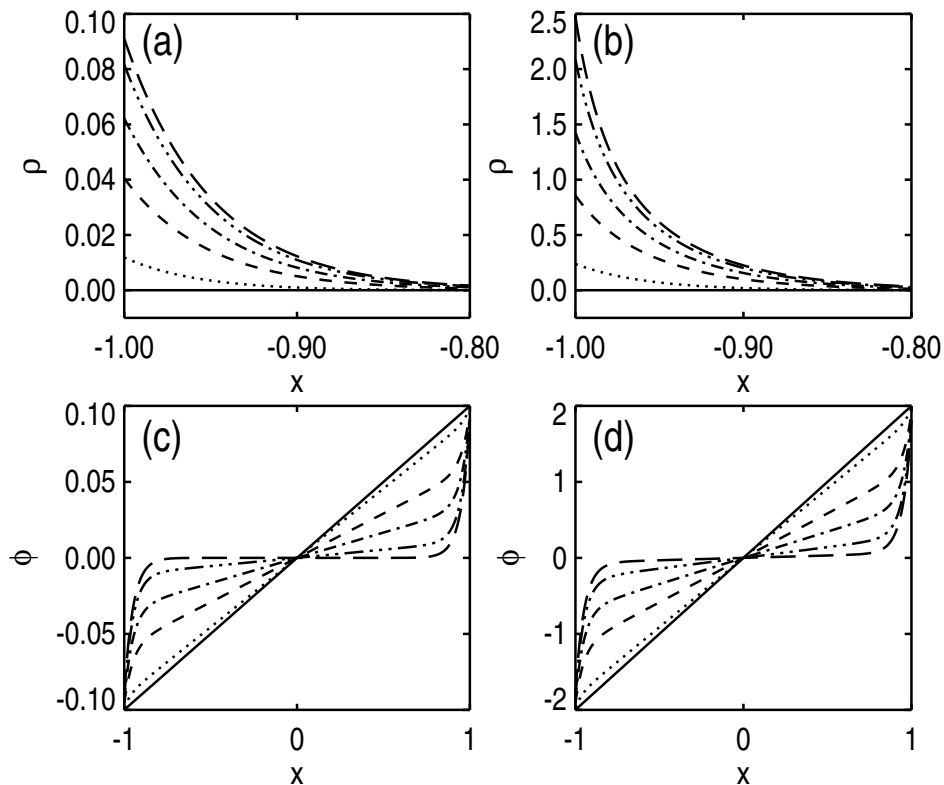

FIG. 3: Profiles for $t = 0$ (solid), 0.1 (dot), 0.5 (dash), 1 (dot-dash), 2 (dot-dot-dot-dash), ∞ (long dash) of the dimensionless charge density, $\rho(x, t)$, for dimensionless voltages (a) $v = 0.1$ and (b) $v = 1$, and of the dimensionless potential, ϕ , for (c) $v = 0.1$ and (d) $v = 1$ ($\epsilon = 0.05$, $\delta = 0.1$).

for somewhat larger voltages, $v = 2, 3$, and 4, the relative error becomes unacceptable at long times, $t > 1$. Not only is the limiting value of the total charge significantly underestimated, but the dynamics also continues for a longer time, with a qualitatively different charging profile. The largest applied voltage, $v = 4$, shows this effect most clearly, as there is a secondary relaxation at a much larger time scale of order $t = 1/\epsilon = 20$. Unlike the other cases, which display the expected steady increase in charge of an RC circuit, for $v \geq 4$ the total charge quickly reaches a maximum value, after the initial RC charging process, and then slowly decays toward its limiting value.

We are not aware of any previous theoretical prediction of such a non-monotonic charging profile, so it is a major focus of this work (in sections VII and VIII). It is reminiscent of the Warburg impedance due to bulk diffusion of current-carrying ions at the time scale, $\tau_L = L^2/D$, or $1/\epsilon$ in our units, in (linear) response to Faradaic processes, which consume or produce them at an electrode. Here, however, there are no Faradaic processes, so any such bulk diffusion must be related to the adsorption or desorption of ions in the diffuse part of the double layer. Moreover, the over-relaxation of the charge density is part of the *non-linear* response to a large applied voltage, so it will require more sophisticated analytical

methods.

VI. WEAKLY NONLINEAR DYNAMICS

A. Asymptotic Analysis for Thin Double Layers

The remarkable robustness of the charging time well into the nonlinear regime (at least for the primary relaxation phase) can be predicted analytically using matched asymptotic expansions in the singular limit of thin double layers, $\epsilon = \lambda_D/L \ll 1$. Most (if not all) previous studies of time-dependent problems using asymptotic analysis have scaled time to the diffusion time, $\tau_L = L^2/D$. In this section, we will see how the correct charging time scale, $\tau_c = \lambda_D L/D$, arises systematically from asymptotic matching at leading order. We also consider, apparently for the first time, the general case of arbitrary voltage, $v = zeV/k_B T$, and Stern-layer thickness, $\delta = \lambda_S/\lambda_D$, with a time-dependent zeta-potential (i.e. potential drop over the diffuse layer). We also study higher-order corrections, which involve some bulk diffusion at the time scale, τ_L .

As usual, matched asymptotic expansions only produce a series of “asymptotic” approximations to the solution, in the sense that higher terms in the expansions

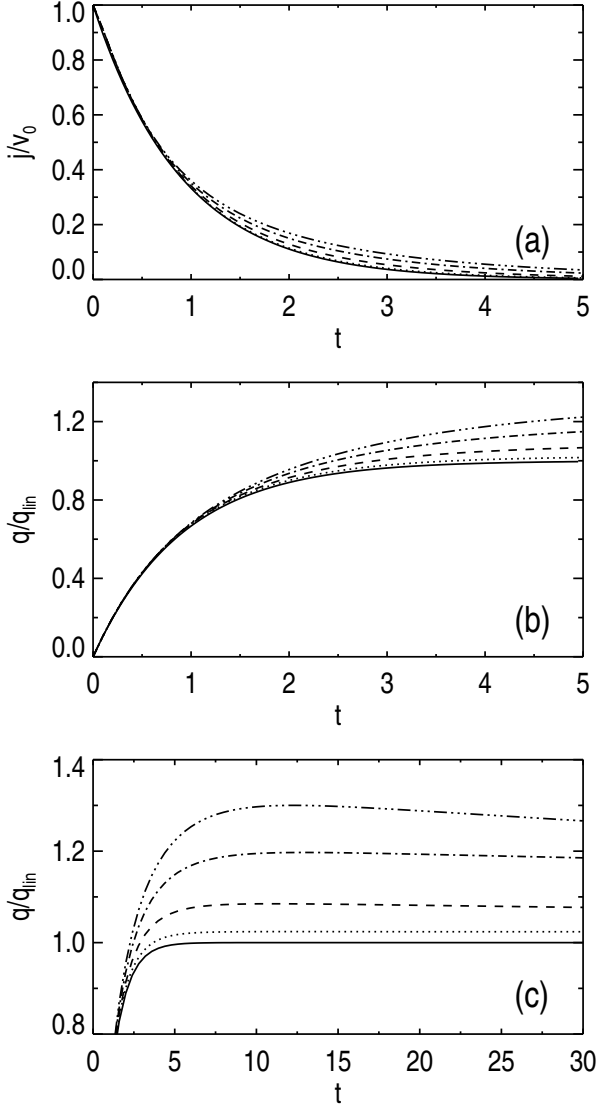

FIG. 4: (a) The dimensionless current density, $j(t)$ (in units of $2zeC_0D/L$), and (b) the dimensionless total diffuse charge on the cathodic side of the cell, $q(t)$ (in units of $2zeC_0L$), scaled to $q_o = v/(1+\delta)$, versus dimensionless time, t (in units of $\tau_c = \lambda_D L/D$). Numerical results for dimensionless voltages, $v = 1$ (dot), 2 (dash), 3 (dot-dash), and 4 (dot-dot-dot-dash) are compared with linear dynamics in the thin double-layer limit: $q(t)/q_o \sim 1 - e^{-(1+\delta)t}$ and $j(t)/v \sim e^{-(1+\delta)t}$ (solid lines) as $v, \epsilon \rightarrow 0$. The breakdown of linear theory for $v \geq 1$ is highlighted in (c), where the data in (b) is replotted for longer times.

vanish more quickly than the leading terms as $\epsilon \rightarrow 0$, with the other parameters, v and δ , held fixed at arbitrary values. For any fixed $\epsilon > 0$ (no matter how small), there could be ϵ -dependent restrictions on v and δ for various truncated expansions to produce accurate approximations. We refer to the regime where such conditions hold as “weakly nonlinear”, as opposed to the “strongly nonlinear” regime where the asymptotic expan-

sions break down (described below in section VIII).

B. Outer and Inner Expansions

We begin by seeking regular asymptotic expansions (denoted by a bar accent) in the bulk “outer” region, e.g.

$$c(x, t) \sim \bar{c}(x, t) = \bar{c}_0 + \epsilon \bar{c}_1 + \epsilon^2 \bar{c}_2 + \dots \quad (53)$$

Substituting such expansions into Eqs. (37)–(39) and equating terms order by order yields a hierarchy of partial-differential equations. At leading order in ϵ , we find that the bulk concentration does not vary in time, $\bar{c}_0 = 1$, simply because the charging time scale, τ_c , is much *smaller* than the bulk diffusion time scale, τ_L . The leading-order potential is linear,

$$\bar{\phi}_0 = \bar{j}_0(t) x, \quad (54)$$

where $\bar{j}_0(0) = v$. Since the leading-order bulk concentration is uniform, $\bar{j}_0(t)$ is the leading-order current density. The leading-order charge density,

$$\bar{\rho}_2 = -\frac{\partial^2 \bar{\phi}_0}{\partial x^2} \quad (55)$$

vanishes because the leading-order potential, Eq. (54), is harmonic, although at next order, $O(\epsilon^3)$, a nonzero bulk charge density, $\bar{\rho}_3$, arises due to concentration polarization. (See below.) These arguments justify the usual assumption of bulk electroneutrality to high accuracy, even during interfacial charging, as long as the dynamics are “weakly nonlinear”.

The regular outer approximations must be matched with singular “inner” approximations in the boundary layers. The problem has the following symmetries about the origin,

$$\begin{aligned} c(-x, t) &= c(x, t) \\ \rho(-x, t) &= -\rho(x, t) \\ \phi(-x, t) &= -\phi(x, t) \end{aligned} \quad (56)$$

so we consider only the boundary layer at the cathode, $x = -1$, by transforming the equations to the inner coordinate, $y = (x + 1)/\epsilon$:

$$\epsilon \frac{\partial \tilde{c}}{\partial t} = \frac{\partial}{\partial y} \left(\frac{\partial \tilde{c}}{\partial y} + \tilde{\rho} \frac{\partial \tilde{\phi}}{\partial y} \right) \quad (57)$$

$$\epsilon \frac{\partial \tilde{\rho}}{\partial t} = \frac{\partial}{\partial y} \left(\frac{\partial \tilde{\rho}}{\partial y} + \tilde{c} \frac{\partial \tilde{\phi}}{\partial y} \right) \quad (58)$$

$$-\frac{\partial^2 \tilde{\phi}}{\partial y^2} = \tilde{\rho} \quad (59)$$

This scaling removes the singular perturbation in Poisson’s equation, so we can seek regular asymptotic expansions for the inner approximations (denoted by tilde accents), e.g.

$$c(x, t) \sim \tilde{c}(y, t) = \tilde{c}_0 + \epsilon \tilde{c}_1 + \epsilon^2 \tilde{c}_2 + \dots \quad (60)$$

Matching with the bulk approximations *in space* involves the usual van Dyke conditions, e.g.

$$\lim_{y \rightarrow \infty} \tilde{c}(y, t) \sim \lim_{x \rightarrow -1} \bar{c}(x, t), \quad (61)$$

which implies $\tilde{c}_0(\infty, t) = \bar{c}_0(-1, t)$, $\tilde{c}_1(\infty, t) = \bar{c}_1(-1, t)$, etc., but we will also have to make sure that the expansions are properly synchronized *in time*. In particular, we will have to worry about the appearance of multiple time scales at different orders.

Substituting the inner expansions into the rescaled equations (57)–(59) causes the time-dependent terms to drop out at leading order. Physically, this quasi-equilibrium occurs because the charging time, τ_c , is much larger than the Debye time, τ_D , characteristic of local dynamics in the boundary layer (at the scale of the Debye length, λ_D). As a result, we systematically arrive at classical Gouy-Chapman profiles for the equilibrium diffuse layer at leading order,

$$\tilde{c}_{\pm} \sim e^{\mp \tilde{\psi}}, \quad \tilde{c}_0 = \cosh \tilde{\psi}_0, \quad \tilde{\rho}_0 = -\sinh \tilde{\psi}_0 \quad (62)$$

where the excess voltage relative to the bulk,

$$\tilde{\psi}(y, t) = \tilde{\phi}(y, t) - \tilde{\phi}(-1, t) \sim \tilde{\psi}_0 + \epsilon \tilde{\psi}_1 + \dots, \quad (63)$$

satisfies the Poisson-Boltzmann equation at leading order,

$$\frac{\partial^2 \tilde{\psi}_0}{\partial y^2} = \sinh \tilde{\psi}_0. \quad (64)$$

Note that matching implies $\tilde{\psi}_0(\infty, t) = \tilde{\psi}_1(\infty, t) = \dots = 0$. The dimensionless zeta potential, $\tilde{\zeta}(t) = \tilde{\psi}(0, t)$, varies as the diffuse layer charges.

After the first integration we apply matching to the electric field,

$$\frac{\partial \tilde{\phi}}{\partial y}(\infty, t) \sim \epsilon \frac{\partial \bar{\phi}}{\partial x}(-1, t) \longrightarrow \frac{\partial \tilde{\phi}_0}{\partial y}(\infty, t) = 0, \quad (65)$$

to obtain

$$\frac{\partial \tilde{\psi}_0}{\partial y} = -2 \sinh(\tilde{\psi}_0/2). \quad (66)$$

After the second integration,

$$\tilde{\psi}_0(y, t) = -4 \tanh^{-1}(e^{-(y+K(t))}), \quad (67)$$

we are left with a constant,

$$K(t) = \log \coth(-\tilde{\zeta}_0(t)/4), \quad (68)$$

to be determined from $\tilde{\zeta}_0(t)$ (below) by the Stern boundary condition at the cathode surface, $y = 0$, and the coupling to the bulk region. The offset parameter, $K(t)$, which also appears in the concentration and charge density,

$$\tilde{c}_0(y, t) = 1 + 2 \operatorname{csch}^2(y + K(t)) \quad (69)$$

$$\tilde{\rho}_0(y, t) = 2 \operatorname{csch}(y + K(t)) \coth(y + K(t)) \quad (70)$$

is quite sensitive to Faradaic reactions [95], but here we focus only on the effect of compact-layer capacitance.

C. Time-dependent Matching

It seems we have reached a paradox: Both the bulk and the boundary layers are in quasi-equilibrium at leading order, and yet there must be some dynamics, if we have chosen the proper time scale. The resolution lies in taking a closer look at asymptotic matching. Physically, we are motivated to consider the dynamics of the total diffuse charge, which has the scaling, $q(t) \sim \epsilon \tilde{q}(t)$, where

$$\tilde{q} = \int_0^{\infty} \tilde{\rho}(y, t) dy \sim \tilde{q}_0 + \epsilon \tilde{q}_1 + \epsilon^2 \tilde{q}_2 + \dots \quad (71)$$

Taking a time derivative using Eq. (58) and applying the no-flux boundary condition (41), we find

$$\frac{d\tilde{q}}{dt} = \lim_{y \rightarrow \infty} \frac{1}{\epsilon} \left(\frac{\partial \tilde{\rho}}{\partial y} + \tilde{c} \frac{\partial \tilde{\phi}}{\partial y} \right) \sim \lim_{x \rightarrow -1} \left(\frac{\partial \bar{\rho}}{\partial x} + \bar{c} \frac{\partial \bar{\phi}}{\partial x} \right) \quad (72)$$

where we have applied matching to the *derivatives* (flux densities). Substituting the inner and outer expansions yields a hierarchy of matching conditions. At leading order, we have

$$\frac{d\tilde{q}_0}{dt}(t) = \bar{j}_0(t), \quad (73)$$

which shows that we have chosen the right time scale because this is a balance of $O(1)$ quantities. Moreover, it can be shown that any other choice of scaling would lead to a breakdown of asymptotic matching in the limit $\epsilon \rightarrow 0$. (For example, in the analogous Equations (42)–(43) of Ref. [4] for small AC potentials, the time-dependent term vanishes in this limit, showing that the proper scaling was not used.) Therefore, the correct charging time scale, Eq. (2), in the weakly nonlinear regime follows systematically from time-dependent asymptotic matching at leading order.

The physical interpretation of Equation (73) is clear: At leading order, the boundary layer acts like a capacitor, whose total charge (per unit area), \tilde{q} , changes in response to the transient Faradaic current density, $\tilde{j}(t)$, from the bulk. The matching condition can also be understood physically as a statement of current continuity across the diffuse layer. Substituting Poisson's equation (59) into Eq. (71), integrating, and matching the electric field using Eq. (65), we see that the left hand side of Eq. (73) is simply the leading-order (dimensionless) *displacement current density* [95, 96, 97, 99] at the cathode surface,

$$\frac{d\tilde{q}_0}{dt} = \frac{\partial}{\partial t} \frac{\partial \tilde{\phi}_0}{\partial y}(0, t) = \tilde{j}_0(t), \quad (74)$$

so the matching condition simply reads, $\tilde{j}_0(t) = \bar{j}_0(t)$. This transient displacement current exists in the external circuit, even if there is no Faradaic current.

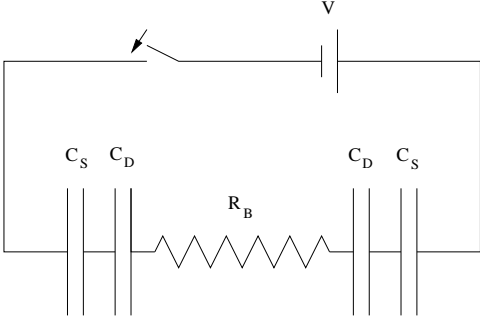

FIG. 5: Sketch of the equivalent RC circuit for the leading-order weakly nonlinear approximation: compact-layer and diffuse-layer capacitors in series with a bulk resistor. Although remarkably robust, the circuit approximation is violated by higher-order corrections, especially at large voltages.

D. Leading-order Dynamics

Using Eqs. (59), (65) and (66), the integral in Eq. (71) can be performed at leading order to obtain the Chapman's formula for the total diffuse charge,

$$\tilde{q}_0 = -2 \sinh(\tilde{\zeta}_0/2). \quad (75)$$

The Stern boundary condition, Eq. (42), then yields,

$$\tilde{\zeta}_0 + 2\delta \sinh(\tilde{\zeta}_0/2) = \bar{j}_0(t) - v = \tilde{\Psi}_0, \quad (76)$$

where $\tilde{\Psi}(t) = -v - \bar{\phi}(-1, t) \sim \tilde{\Psi}_0 + \epsilon \tilde{\Psi}_1 + \dots$ is the total voltage across the compact and diffuse layers. Substituting into the matching condition, Eq. (73), we obtain an ordinary, initial-value problem, either for the leading-order double-layer voltage

$$-\tilde{C}_0(\tilde{\Psi}_0) \frac{d\tilde{\Psi}_0}{dt} = \tilde{\Psi}_0 + v, \quad \tilde{\Psi}_0(0) = 0, \quad (77)$$

or for the leading-order current density

$$\tilde{C}_0(\bar{j}_0 - v) \frac{d\bar{j}_0}{dt} = -\bar{j}_0, \quad \bar{j}_0(0) = v, \quad (78)$$

where $\tilde{C}_0(\tilde{\Psi}_0) = d\tilde{q}_0/d\tilde{\Psi}_0$ is the differential capacitance for the double layer as a function of its total voltage, relative to the potential of zero charge.

The effective double-layer capacitance is given by

$$\tilde{C}_0 = \frac{1}{\text{sech}(\tilde{\zeta}_0/2) + \delta} \quad (79)$$

where $\tilde{\zeta}_0$ is related to $\tilde{\Psi}_0$ by Eq. (76). A similar formula arises in the classical circuit model of Macdonald [63]. Indeed, the leading-order charging dynamics from asymptotic analysis corresponds exactly to the nonlinear RC circuit shown in Fig. 5. We expect, however, that the *ad hoc* circuit approximation cannot describe higher-order asymptotic approximations, where the finite thickness of the double layer becomes important.

Linearizing for small voltages, $\tilde{C}_0 \sim 1/(1 + \delta)$, we obtain the same results as before in the limit $\epsilon \rightarrow 0$, now by a completely different method,

$$\bar{j}_0(t) \sim v e^{-(1+\delta)t} = v + \tilde{\Psi}_0(t) \quad (80)$$

$$\tilde{q}_0(t) \sim \frac{v(1 - e^{-(1+\delta)t})}{1 + \delta} \quad (81)$$

As shown in Fig. 4 for $\delta = 0.1$, the linearization describes the charging dynamics fairly accurately, even for somewhat large voltages ($v \approx 1$), as long as δ is not too small. One way to understand this is that the total differential capacitance satisfies the uniform bounds,

$$\frac{1}{1 + \delta} = \tilde{C}_0(0) \leq \tilde{C}_0(\tilde{\Psi}_0) < \tilde{C}_0(\infty) = \frac{1}{\delta}, \quad (82)$$

in the linear and nonlinear regimes. Moreover, the linearization is always accurate at early times (up to $t \approx 1$ or $\tau \approx \tau_c$) for any applied voltage, as long as the initial zeta potential (or diffuse charge) is small. This is also clearly seen in Fig. 4.

The dynamical equation (77) or (78) is first-order and separable, so its exact solution is easily expressed in integral form,

$$\tilde{\Psi}_0(t) = \bar{j}_0(t) - v = -F^{-1}(t) \quad (83)$$

where

$$F(z) = \int_0^z \frac{\tilde{C}_0(u) du}{u + v} \quad (84)$$

The integral can be evaluated numerically and the total charge recovered from the Eqs. (75) and (76). The results in Fig. 6 show that the leading-order dynamics compares fairly well with the numerical solution to the full nonlinear problem for $\epsilon = 0.05$ and $\delta = 0.1$, at least for the decay of the current density, especially at early times ($t \approx 1$). The limiting value of the total diffuse charge is also approximated much better than in the linear theory (Fig. 4), due to the nonlinear differential capacitance, Eq. (79). For large voltages ($v > 1$), however, total charge shows some secondary dynamics at longer time scales ($t \gg 1$), which is not fully captured by the leading-order asymptotic approximation (or the corresponding circuit model). As we shall see below, this can only be understood by considering higher-order terms which violate the circuit approximation.

For moderately large voltages ($v \approx 1$), we can expand around $u = v$ in the integrand of Eq. (84) and obtain a long-time exponential decay,

$$\bar{j}_0(t) = v + \tilde{\Psi}_0(t) \propto e^{-t/\tilde{C}_0(v)} \quad (85)$$

as $t \rightarrow \infty$. This reveals a (dimensionless) characteristic time, $t_c = \tilde{C}_0(v)$, which is larger than that of the linear regime, $t_c = \tilde{C}_0(0) = 1/(1 + \delta)$, by at most a factor of $1 + 1/\delta$ ($= 11$ in our numerical examples). Although this factor is non-negligible, the characteristic time, τ_c , is still

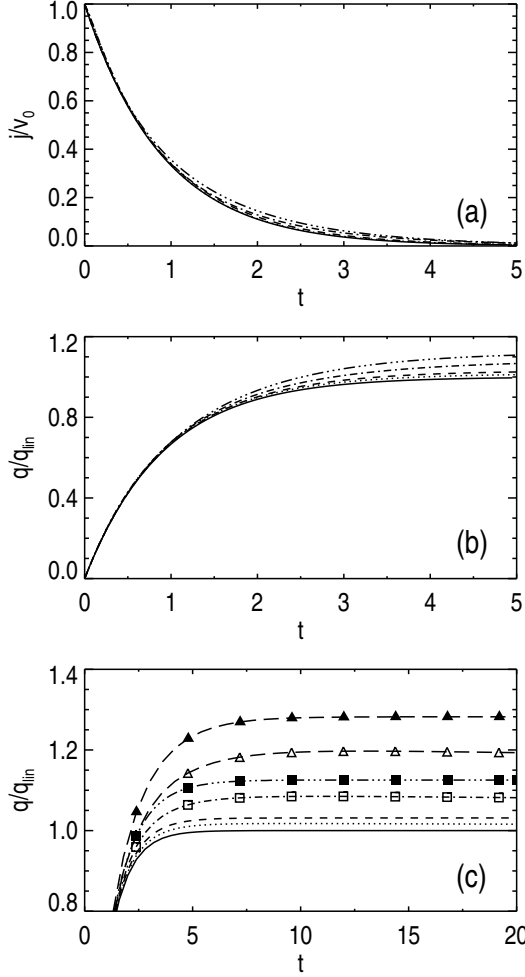

FIG. 6: The comparison of the full numerical solution with the leading-order asymptotic results: (a) j/v , (b) q/q_{lin} (early evolution), and (c) q/q_{lin} (long time evolution). The full numerical solution is shown with dot ($v = 1$), dot-dash (with open squares in (c)) ($v = 2$) and long dash with open triangles ($v = 3$). The leading-order asymptotic results are plotted with dash ($v = 1$), dot-dot-dot-dash (with filled squares in (c)) ($v = 2$) and long dash with filled triangles ($v = 3$). The curves for $v = 3$ are omitted in (a) and (b) for clarity. The solid lines show the linear dynamics in the thin double-layer limit.

the basic time scale, rather than τ_L and τ_D which differ from τ_c by factors of ϵ , i.e. usually two or more orders of magnitude. As the voltage is increased, however, nonlinearity always becomes important, and one of its generic effects is to slow down the relaxation process.

In order to simplify the response function, $F(z)$, and other quantities, it is useful to consider the regular limit of thin Stern layers, $\delta \rightarrow 0$ (taken after the singular limit of thin diffuse layers, $\epsilon \rightarrow 0$). In this common physical regime, where $\lambda_S \ll \lambda_D \ll L$, the following asymptotic expansions can be derived by iteration [40] from

Eqs. (75), (76), and (79):

$$\tilde{\zeta}_0 \sim \tilde{\Psi}_0 - 2\delta \sinh \frac{\tilde{\Psi}_0}{2} + \delta^2 \sinh \tilde{\Psi}_0 + \dots \quad (86)$$

$$\tilde{q}_0 \sim -2 \sinh \frac{\tilde{\Psi}_0}{2} + \delta \sinh \tilde{\Psi}_0 - \delta^2 \left(\sinh \tilde{\Psi}_0 \cosh \frac{\tilde{\Psi}_0}{2} + \sinh^3 \frac{\tilde{\Psi}_0}{2} \right) \quad (87)$$

$$\tilde{C}_0 \sim \cosh \frac{\tilde{\Psi}_0}{2} - \delta \cosh \tilde{\Psi}_0 + \delta^2 \left(\cosh \tilde{\Psi}_0 \cosh \frac{\tilde{\Psi}_0}{2} + \frac{1}{2} \sinh \tilde{\Psi}_0 \sinh \frac{\tilde{\Psi}_0}{2} + \frac{3}{2} \sinh^2 \frac{\tilde{\Psi}_0}{2} \cosh \frac{\tilde{\Psi}_0}{2} \right) \quad (88)$$

The response function can then be expanded in somewhat simpler (but still nontrivial) integrals,

$$F(z) \sim \int_0^z \frac{\cosh(u/2) du}{u+v} - \delta \int_0^z \frac{\cosh(u) dx}{u+v} + \dots \quad (89)$$

in the limit $\delta \rightarrow 0$.

E. Uniformly Valid Approximations

Asymptotic analysis tells us not only the behavior of integrated quantities like total charge and voltage, but also the complete spatio-temporal profiles of the charge density and potential. As usual, uniformly valid approximations (in space) are constructed by adding the outer and inner approximations and subtracting the overlaps. Taking advantage of the symmetries in Eq. (56), we obtain the following leading-order approximations:

$$\phi(x, t) \sim \bar{j}(t) x + \tilde{\psi}_0 \left(\frac{1+x}{\epsilon}, t \right) - \tilde{\psi}_0 \left(\frac{1-x}{\epsilon}, t \right) \quad (90)$$

$$c(x, t) \sim \tilde{c}_0 \left(\frac{1+x}{\epsilon}, t \right) + \tilde{c}_0 \left(\frac{1-x}{\epsilon}, t \right) - 1 \quad (91)$$

$$\rho(x, t) \sim \tilde{\rho}_0 \left(\frac{1+x}{\epsilon}, t \right) - \tilde{\rho}_0 \left(\frac{1-x}{\epsilon}, t \right) \quad (92)$$

where the boundary-layer contributions are given by Eqs. (67)–(70) and Eq. (76), which express the effect of the compact layer. The time dependence of the leading-order approximations is entirely determined by the bulk current density, $\bar{j}_0(t)$, or the double-layer voltage, $\tilde{\Psi}_0(t)$, via Eqs. (83) and (84).

As shown in Fig. 7, the time-dependent approximations for ϕ and ρ are in excellent agreement with our numerical results well into the nonlinear regime ($v = 1$), even for a fairly large boundary-layer thickness, $\epsilon = 0.05$. The charge density clearly shows the expected separation into three regions: a neutral bulk with two charged boundary layers of $O(\epsilon)$ width. On the other hand, for

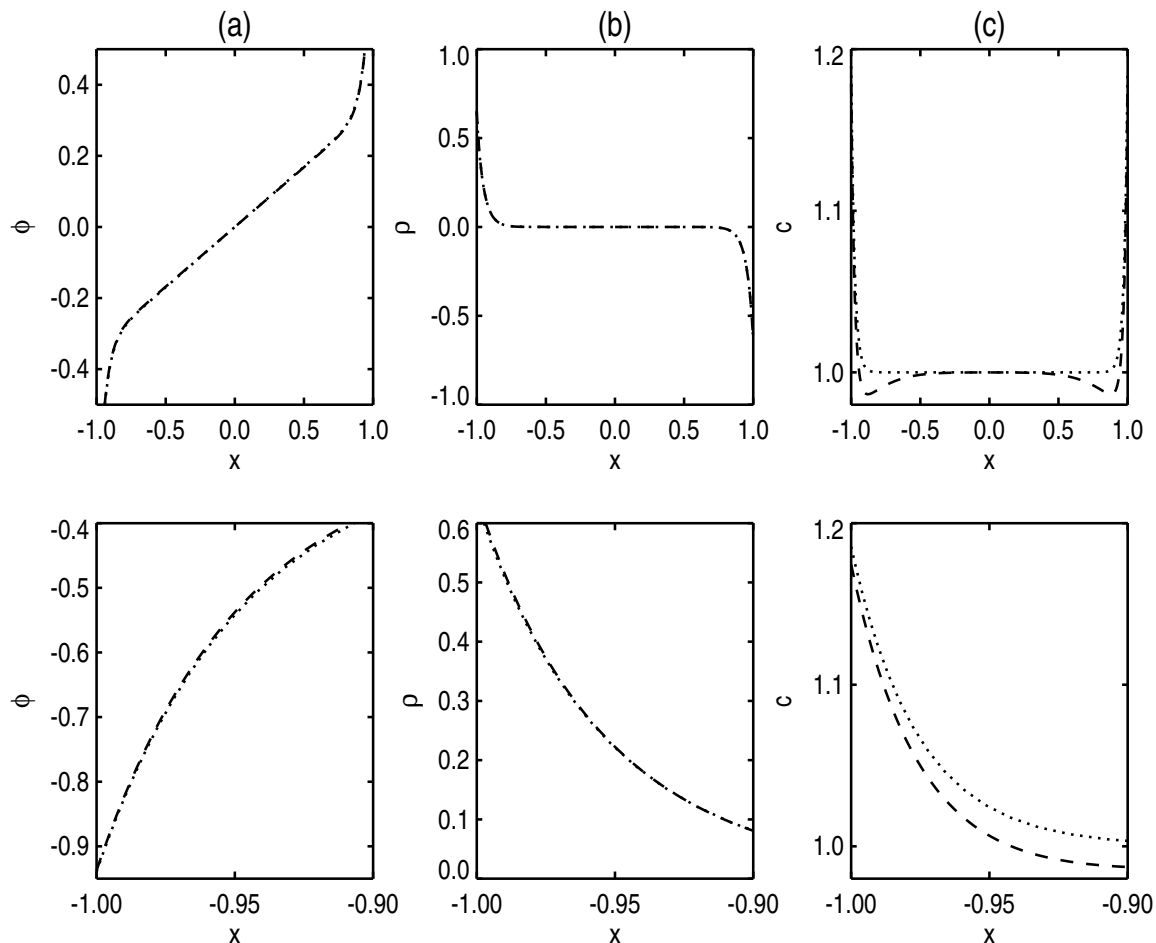

FIG. 7: The potential (a), charge density (b) and concentration (c) at $t = 1$ for a large dimensionless voltage, $v = 1$, with $\epsilon = 0.05$ and $\delta = 0.1$. The full numerical solution (dashed lines) is compared with the leading-order uniformly valid approximation (dotted lines), Eqs. (90)–(92). The analytical approximations are almost indistinguishable from the numerical solutions for ϕ and ρ , but not for c , which shows errors of a few percent ($< \epsilon$) just outside the double layers.

the same parameters, the leading-order approximation of c is not nearly as good. As expected, the concentration exhibits a homogeneous bulk region and two inhomogeneous boundary layers of $O(\epsilon)$ width, which are fairly well described, but there are also intermediate regions of depleted concentration extending far into the bulk, which are not captured at leading order.

VII. HIGHER-ORDER EFFECTS

A. Neutral-Salt Adsorption by the Double Layer

We have seen that each diffuse-charge layer acquires an excess salt concentration relative to the outer region. At leading order, however, there is no sign of how the extra ions got there. This paradox, which also applies to circuit models, is apparent from symmetry alone, Eq. (56) — Diffuse charge near the cathode grows by bulk elec-

tr migration, which creates equal and opposite diffuse charge near the anode. In contrast, the excess concentration is the same in both double layers, so it can only arrive there by *diffusion* of neutral electrolyte from the bulk, which is excluded at leading order.

The key to understanding higher-order terms, therefore, is the total excess concentration per unit surface area in (say) the cathodic diffuse layer, $w(t) = \epsilon \tilde{w}(t)$, where

$$\tilde{w}(t) = \int_0^\infty [\tilde{c}(y, t) - \bar{c}_0(-1, t)] dy = \tilde{w}_0(t) + \epsilon \tilde{w}_1(t) + \dots \quad (93)$$

is analogous to the scaled total diffuse charge, $\tilde{q}(t)$. (Note that $\bar{c}_0(-1, t) = 1$ in our model problem, but Equation (93) is more general.) We proceed with matching in the same manner as above. Taking a time derivative using Eq. (57) and applying the no-flux boundary condition

(40), we find

$$\frac{d\tilde{w}}{dt} = \lim_{y \rightarrow \infty} \frac{1}{\epsilon} \left(\frac{\partial \tilde{c}}{\partial y} + \tilde{\rho} \frac{\partial \tilde{\phi}}{\partial y} \right) \sim \lim_{x \rightarrow -1} \left(\frac{\partial \tilde{c}}{\partial x} + \tilde{\rho} \frac{\partial \tilde{\phi}}{\partial x} \right) \quad (94)$$

Substituting the inner and outer expansions yields another hierarchy of matching conditions. At leading order, we have

$$\frac{d\tilde{w}_0}{d\tilde{t}}(t) = \frac{1}{\epsilon} \frac{d\tilde{w}_0}{dt}(t) = \frac{\partial \tilde{c}_1}{\partial x}(-1, t), \quad (95)$$

which, unlike Eq. (73), involves a *new time variable*,

$$\tilde{t} = \epsilon t = \frac{\epsilon \tau}{\tau_c} = \frac{\tau}{\tau_L}, \quad (96)$$

scaled to the bulk diffusion time, $\tau_L = L^2/D$. Physically, this matching condition simply expresses mass conservation: The (zeroth order) excess concentration in the diffuse layer varies in response to the (first order) diffusive flux from the bulk.

In Eq. (93), the left-hand side is given by the leading-order inner approximation calculated above. Substituting Eq. (69) into Eq. (93), integrating, and using Eq. (68) yields,

$$\begin{aligned} \frac{d\tilde{w}_0}{dt}(t) &= 2 \frac{d}{dt} \coth K(t) \\ &= 2 \frac{d}{dt} \cosh \frac{\tilde{\zeta}_0(t)}{2} \\ &= -\frac{\tilde{q}_0(t)}{2} \frac{d\tilde{\zeta}_0(t)}{dt} \end{aligned} \quad (97)$$

where we have used the identity, $\cosh 2z = -\coth \log \tanh z$. Recall that the leading-order zeta potential, $\tilde{\zeta}_0(t)$, is related via Eq. (76) to the leading-order bulk current density, $\tilde{j}_0(t)$, or interfacial voltage, $\tilde{\Psi}_0(t)$, given by Eqs. (83) and (84). Integrating Eq. (97) and requiring $\tilde{w}_0 = 0$ for $\tilde{\zeta}_0 = 0$, we also obtain a simple expression for the excess concentration,

$$\tilde{w}_0 = 4 \sinh^2 \frac{\tilde{\zeta}_0}{4}, \quad (98)$$

which also holds for the static Gouy-Chapman solution. Of course, this is another sign that (at leading order) a thin double layer stays in quasi-equilibrium, even while charging.

B. The Sign of the Donnan Effect

Before proceeding to calculate the bulk dynamics, we comment on the sign of the excess concentration in the diffuse part of the double layer, which corresponds to a *positive* adsorption of neutral salt. In contrast, it is commonly believed that double-layer salt adsorption is always negative, resulting in an excess neutral concentration in the nearby bulk electrolyte. Lyklema calls this

the ‘‘Donnan effect’’ with reference to Donnan’s general papers on membrane equilibria [138, 139, 140] and describes how it is used to infer surface areas from experimental measurements of concentration variations upon charging (‘‘salt sieving’’) [29, 141]. In the present case of diffuse-layer adsorption, the following argument is given: Since the equilibrium co-ion concentration in the double layer near a charged surface is reduced compared to the bulk, there must be an excess of co-ions, and hence an excess of neutral concentration (and counter-ions) in the nearby bulk.

How can this belief be reconciled with our analytical and numerical results, which clearly demonstrate the opposite effect in a model problem? The difference is that we consider a *finite* system with global ion conservation, while Lyklema considers an open system into which ions are apparently injected. We also explicitly calculate the time-dependent response to interfacial charging, while he describes the steady state after new ions somehow arrive ‘‘from infinity’’.

Our conclusion is therefore the opposite: Since the equilibrium counter-ion concentration is enhanced in the double layer, there must be a depletion of counter-ions, and hence a reduction in neutral concentration (and co-ions) in the nearby bulk. Gouy’s nonlinear theory shows that at large voltages the excess of counter ions exceeds the reduction in co-ions in the diffuse layer, so this result is quite intuitive.

In real systems, it may be that compact-layer effects, such as the specific adsorption of ions on the surface, can lead to overall negative adsorption by the double layer. According to the Nernst-Planck-Poisson equations, however, the average concentration of all ions (regardless of species) is always increased in the diffuse part of the double layer relative to the bulk in any finite system. The associated local depletion of neutral salt has important implications for time-dependent electrokinetic phenomena at polarizable surfaces (section II C) since bulk concentration gradients alter electric fields and produce diffusio-osmotic slip.

C. Bulk Diffusion at Two Time Scales

We now proceed to calculate how the bulk concentration is depleted in time and space during double-layer charging in our model problem. The matching condition, Eq. (95), seems to contradict the analysis above, since it introduces a new time variable, \tilde{t} . However, this is the same time scale for the first-order (diffusive) dynamics in the bulk,

$$\frac{\partial \tilde{c}_1}{\partial \tilde{t}} = \frac{1}{\epsilon} \frac{\partial \tilde{c}_1}{\partial t} = \frac{\partial^2 \tilde{c}_1}{\partial x^2}. \quad (99)$$

We must solve this equation starting from $\tilde{c}_1(x, 0) = 0$ with a time-dependent prescribed flux at $x = -1$ given by Eqs. (95) and (97). We also enforce symmetry about the origin, Eq. (56).

The Laplace transform of the solution is:

$$\begin{aligned}\hat{c}_1(x, s) &= -\frac{\sqrt{s} \cosh(x\sqrt{s})}{\sinh(\sqrt{s})} \int_0^\infty e^{-s\bar{t}} \tilde{w}_0(\bar{t}/\epsilon) d\bar{t} \\ &= \int_0^\infty e^{-s\bar{t}} \bar{c}_1(x, \bar{t}) d\bar{t}\end{aligned}\quad (100)$$

where $\tilde{w}_0(t)$ is determined by $\tilde{\zeta}_0(t)$ from Eq. (98). The prefactor,

$$\hat{G}(s) = \frac{\cosh(x\sqrt{s})}{\sqrt{s} \sinh(\sqrt{s})}, \quad (101)$$

is the Laplace transform of $G(\bar{t})$, the Green function for the diffusion equation, Eq. (99), for a sudden unit flux of ions at time $\bar{t} = 0^+$ injected at the boundary:

$$G(x, 0) = 0, \quad \frac{\partial G}{\partial x}(-1, \bar{t}) = \delta^+(\bar{t}). \quad (102)$$

The same Green function also arises in the equivalent problem of an initial unit source adjacent to a reflecting wall,

$$G(x, 0) = \delta(x + 1^+), \quad \frac{\partial G}{\partial x}(-1, \bar{t}) = 0. \quad (103)$$

In this form, the Green function can be obtained by inspection,

$$G(x, \bar{t}) = \frac{1}{\sqrt{\pi\bar{t}}} \sum_{m=-\infty}^{\infty} e^{-(x-2m+1)^2/4\bar{t}}, \quad (104)$$

using the method of images.

Since $\hat{c}_1(x, s)$ is expressed as a product of two Laplace transforms, Eq. (100), the inverse is equal to the convolution of the two original functions:

$$\bar{c}_1(x, \bar{t}) = -\int_0^{\bar{t}} d\bar{t}' G(x, \bar{t}' - \bar{t}) \frac{\partial \tilde{w}_0}{\partial \bar{t}'} \left(\frac{\bar{t}'}{\epsilon} \right). \quad (105)$$

This form clearly demonstrates that the boundary forcing occurs over the fast, charging time, $t = \bar{t}/\epsilon$, while the response described by the Green-function kernel occurs over the slow, diffusion time, \bar{t} . The separation of time scales is apparent in the equivalent expression,

$$\bar{c}_1(x, t) = -\int_0^t dt' G(x, \epsilon(t' - t)) \tanh\left(\frac{\tilde{\zeta}_0(t')}{2}\right) \bar{j}_0(t') \quad (106)$$

which can be derived from Eq. (105) using Eq. (97). This form shows explicitly how solution for the current at leading order, Eq. (83), fully determines the bulk concentration at first order.

Before further analysis of the exact solution for $c_1(x, t)$, we describe its physical significance. The bulk concentration at first-order exhibits diffusive relaxation at two different time scales, $t = O(1)$ and $\bar{t} = O(1)$, or with units, $\tau = O(\lambda_D L/D)$ and $\tau = O(L^2/D)$, respectively. For

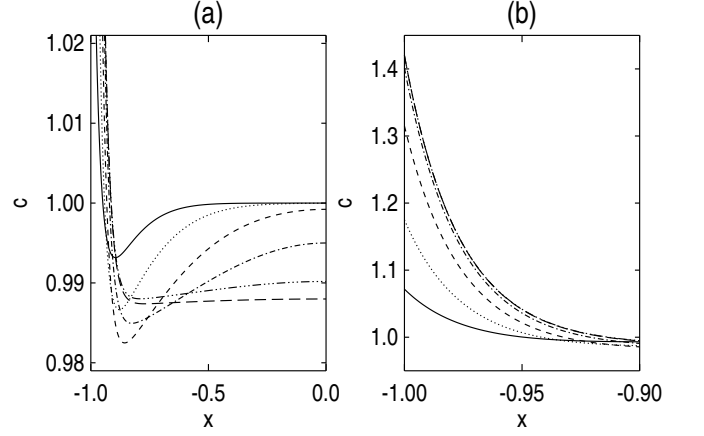

FIG. 8: Weakly nonlinear dynamics for $v = 1$, $\epsilon = 0.05$, $\delta = 0.1$, showing the effect of bulk diffusion. The concentration from the full numerical solution is shown in the half cell (a) and in the diffuse layer (b) for $t = 0.5$ (solid), $t = 1$ (dot), 2 (dash), 4 (dot-dash), 8 (dot-dot-dot-dash), and 20 (long dash).

$t = O(1)$ and $\bar{t} = O(\epsilon)$, the initial double-layer charging process proceeds without any significant changes in concentration at the bulk length scale, $x = O(1)$. During this phase, each diffuse-charge layer acquires an $O(\epsilon)$ amount of excess concentration, given by Eq. (109). This excess concentration has been acquired by a diffusive process, which at this time scale corresponds to a bulk diffusion layer of $O(\sqrt{\epsilon})$ width near each electrode. This implies an $O(\sqrt{\epsilon})$ depletion of the neutral salt concentration in the bulk diffusion layers. These scaling arguments are confirmed by Fig. 7(c) for $v = 1$ and $\epsilon = 0.05$, where at time $t = 1$ (or $\bar{t} = \epsilon$) the diffusion layers are roughly of width $\sqrt{2t} = \sqrt{2\epsilon} \approx 0.3$. The formation and spreading of the diffusion layers is also shown in more detail in Fig. 8.

D. Evolution of the Diffusion Layers

In the previous section, we derived the time-dependent outer approximation, Eq. (53), to first order,

$$\bar{c}(x, t) \sim 1 + \epsilon \bar{c}_1(x, t), \quad (107)$$

which displays dynamics at both the RC time and the bulk diffusion time. The result, Eqs. (104)–(106), is fairly complicated, so in this section we try to gain some simple analytical insight. In the limit $\epsilon \rightarrow 0$, the initial charging process at the time scale $\bar{t} = O(\epsilon)$ is instantaneous, and we are left with only the slow relaxation of the bulk diffusion layers. Explicitly taking this limit in Eq. (100) with $\bar{t} = \epsilon t$ fixed,

$$\lim_{\epsilon \rightarrow 0} \bar{c}_1(x, \bar{t}) = -\tilde{w}_0(\infty) G(x, \bar{t}), \quad (108)$$

we see that the slow-scale evolution of the diffusion layers is given by the Green function, $G(x, \bar{t})$, with a source

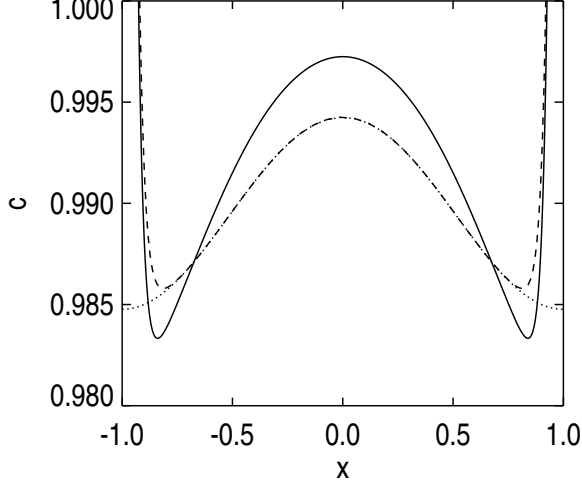

FIG. 9: Simple approximations of the bulk diffusion layers for weakly nonlinear charging dynamics with $v = 1$, $\epsilon = 0.05$, $\delta = 0.1$. The full numerical solution (solid) is compared with the approximate first-order expansion at the diffusion time scale, given by Eqs. (108), (104), and (107). Also, shown is the latter plus the zeroth-order inner approximation, Eq. (69), for the diffuse layers (dashed).

of strength, $-\tilde{w}_0(\infty)$, equal to the leading-order total salt adsorption. According to Eqs.(76) and (98) with $\bar{j}_0(\infty) = 0$, this is given by

$$\tilde{w}_0(\infty) = 4 \sinh^2 \frac{f^{-1}(v)}{4}, \quad (109)$$

where

$$f(\zeta) = \zeta + 2\delta \sinh(\zeta/2) \quad (110)$$

which reduces to

$$\tilde{w}_0(\infty) = 4 \sinh^2 \frac{v}{4}, \quad (111)$$

in the absence of any compact layers ($\delta = 0$).

This simple approximation describes two diffusion layers created at the electrodes slowly invading the entire cell. At first, they have simple Gaussian profiles,

$$\bar{c}(x, \bar{t}) \sim 1 - \frac{\epsilon \tilde{w}_0(\infty)}{\sqrt{\pi \bar{t}}} \left[e^{-(x+1)^2/4\bar{t}} + e^{-(x-1)^2/4\bar{t}} \right] \quad (112)$$

for $\bar{t} \ll 1$, which is qualitatively consistent with the numerical results in Fig. 7(c). To attempt a quantitative comparison, we also need $t \gg 1$ to use Eqs. (108) and (104). As shown in Fig. (9), the approximation is reasonable for $t = 3$ with an error of roughly $\epsilon^2 = 0.0025$. The two diffusion layers eventually collide, and the concentration slowly approaches a (reduced) constant value,

$$\bar{c}(x, \bar{t}) \sim 1 - \epsilon \tilde{w}_0(\infty) \quad (113)$$

for $\bar{t} \gg 1$, as expected from the steady-state excess concentration in the double layers. (This result may be checked by replacing the sum in Eq. (104) with an integral in the limit $\bar{t} \rightarrow \infty$.)

E. Bulk Concentration Polarization

As mentioned above, the bulk charge density remains very small, $\bar{\rho} = O(\epsilon^3)$, even during double-layer relaxation, but changes in neutral bulk concentration affect the potential at first order. Substituting the outer expansions into Eq. (38) and collecting terms at $O(\epsilon)$, we have

$$0 = \frac{\partial}{\partial x} \left[\bar{c}_0 \frac{\partial \bar{\phi}_1}{\partial x} + \bar{c}_1 \frac{\partial \bar{\phi}_0}{\partial x} \right]. \quad (114)$$

This is easily integrated using $\bar{c}_0 = 1$ to obtain the first-order contribution to the bulk electric field,

$$\frac{\partial \bar{\phi}_1}{\partial x} = \bar{j}_1(t) - \bar{j}_0(t) \bar{c}_1(x, t), \quad (115)$$

where the second term describes concentration polarization, i.e. the departure from a harmonic potential, which would be predicted by Ohm's law. The first term is a uniform bulk field (or current) determined by first-order perturbation in double-layer charge. This follows from the matching condition, Eq. (72), at first order:

$$\frac{d\tilde{q}_1}{dt} = \bar{j}_1(t). \quad (116)$$

where $\tilde{q}_1(t)$ is obtained by solving the inner problem at first order.

F. Perturbations in Double-layer Structure

Unfortunately, the first-order inner problem is difficult to solve analytically because the perturbed concentration profiles are no longer in thermal equilibrium during the initial charging phase. To see this, note that the time derivatives in Eqs. (57) and (58) contribute nonzero (but known) terms at first order,

$$\frac{\partial \tilde{c}_0}{\partial t} = \frac{\partial}{\partial y} \left(\frac{\partial \tilde{c}_1}{\partial y} + \tilde{\rho}_0 \frac{\partial \tilde{\phi}_1}{\partial y} + \tilde{\rho}_1 \frac{\partial \tilde{\phi}_0}{\partial y} \right) \quad (117)$$

$$\frac{\partial \tilde{\rho}_0}{\partial t} = \frac{\partial}{\partial y} \left(\frac{\partial \tilde{\rho}_1}{\partial y} + \tilde{c}_0 \frac{\partial \tilde{\phi}_1}{\partial y} + \tilde{c}_1 \frac{\partial \tilde{\phi}_0}{\partial y} \right) \quad (118)$$

$$-\frac{\partial^2 \tilde{\phi}_1}{\partial y^2} = \tilde{\rho}_1 \quad (119)$$

although one still solves a system of linear ordinary differential equations in y at each t , since $\tilde{c}_0(y, t)$, $\tilde{\rho}_0(y, t)$, and $\tilde{\phi}_0(y, t)$ are known.

The general problem seems daunting, but some progress can be made at the scale of bulk diffusion, $\bar{t} = O(1)$ or $t = O(\epsilon^{-1})$, where the leading-order concentration profiles remain in thermal equilibrium, without any explicit time dependence. This will give us some insight into secondary charge relaxation at the time scale of bulk diffusion. In this limit, the Equations (117) and (118) can be integrated to obtain:

$$-\frac{\partial \tilde{c}_1}{\partial y} \sim \tilde{\rho}_0(y, \infty) \frac{\partial \tilde{\phi}_1}{\partial y} + \tilde{\rho}_1 \frac{\partial \tilde{\phi}_0}{\partial y}(y, \infty) \quad (120)$$

$$-\frac{\partial \tilde{\rho}_1}{\partial y} \sim \tilde{c}_0(y, \infty) \frac{\partial \tilde{\phi}_1}{\partial y} + \tilde{c}_1 \frac{\partial \tilde{\phi}_0}{\partial y}(y, \infty) \quad (121)$$

after applying the usual van Dyke matching conditions. Substituting from Poisson's equation, $\tilde{\rho}_n = -\partial^2 \tilde{\phi}_n / \partial y^2$, at orders $n = 0, 1$ into Eq. (120), integrating, and applying matching again, we obtain:

$$\tilde{c}_1(y, \bar{t}) \sim \frac{\partial \tilde{\phi}_0}{\partial y}(y, \infty) \frac{\partial \tilde{\phi}_1}{\partial y}(y, \bar{t}) + \tilde{c}_1(-1, \bar{t}) \quad (122)$$

for $\bar{t} > 0$ and $t = \bar{t}/\epsilon \gg 1$. From the previous section, we also have the leading-order inner concentration,

$$\tilde{c}_0(y, \infty) = \tilde{c}_0(-1, \bar{t}) + \frac{1}{2} \tilde{E}_0(y, \infty), \quad (123)$$

where $\tilde{c}_0(-1, \bar{t}) = 1$ is the leading-order outer concentration, and

$$\tilde{E}_0(y, \infty) = -\frac{\partial \tilde{\phi}_0}{\partial y}(y, \infty) = 2 \sinh \frac{\tilde{\psi}_0(y, \infty)}{2}, \quad (124)$$

is the leading-order inner electric field in steady-state. Finally, we substitute these expressions into Eq. (121) and use Eq. (118) to obtain a master equation for the first-order inner electric field, $\tilde{E}_1(y, \bar{t}) = -\frac{\partial \tilde{\phi}_1}{\partial y}(y, \bar{t})$, at the bulk-diffusion time scale:

$$\frac{\partial^2 \tilde{E}_1}{\partial y^2} = \left(1 + \frac{3}{2} \tilde{E}_0^2\right) \tilde{E}_1 + \tilde{c}_1 \tilde{E}_0. \quad (125)$$

This linear equation with a non-constant coefficient must be solved subject to the boundary conditions, $\tilde{E}_1(\infty, \bar{t}) = 0$ and $\tilde{E}_1(0, \bar{t}) = -\tilde{q}_1(\bar{t})$. The perturbation of the total charge, $\tilde{q}_1(\bar{t})$ is obtained by another integration of the field to get the first-order inner potential, while applying the Stern boundary condition.

For our purposes here, it suffices to point out that the spatial profile of the first-order inner electric field in Eq. (125) varies with the outer concentration, $\tilde{c}_1(-1, \bar{t})$, at the slow time scale of bulk diffusion. Notably, this can lead to a secondary relaxation of the total diffuse charge, in response to the evolution of the diffusion layers. We observe this slow relaxation phase in our numerical solutions of the full equations, especially at large voltages. In particular, it is presumably associated with the non-monotonic charging profile for $v = 4$ shown in Fig. 4(c). A detailed analysis of this interesting effect from the setup above would require solving the first-order inner problem numerically, so we leave it for future work.

VIII. STRONGLY NONLINEAR DYNAMICS

A. Steady State and the Dukhin Number

We stress again that the asymptotic expansions derived above are valid in the limit of thin double layers, $\epsilon \rightarrow 0$, with the other two dimensionless parameters, v (applied voltage) and δ (relative compact-layer capacitance), held constant. For any fixed $\epsilon > 0$, there is no guarantee that the approximation remains accurate as the other parameters are varied. Having just calculated the bulk concentration to first order in the regular expansion, Eq. (53), we can now check *a posteriori* under what conditions it remains a good approximation.

A simple check involves the constant bulk concentration, Eq. (113), after the charging process is completed. The assumption that the first correction is much smaller than the leading term requires, $\alpha_s \equiv \epsilon \tilde{w}(\infty) \ll 1$. Linearizing Eq. (110) for $\delta \ll 1$, we can write this condition in a closed form:

$$4\epsilon \sinh^2 \left(\frac{v}{4(1+\delta)} \right) \ll 1 \quad (126)$$

Putting the units back, we have

$$\alpha_s(\zeta_0) = \frac{4\lambda_D}{L} \sinh^2 \left(\frac{ze\zeta_0}{4kT} \right) \ll 1 \quad (127)$$

where $\zeta_0 \approx V/(1+\delta)$ is the steady-state zeta potential, long after the DC voltage is applied.

The condition, $\alpha_s(\zeta_0) \ll 1$, for the validity of the *steady-state* asymptotic expansion is identical to that of small Dukhin number, $\text{Du}(\zeta_0) \ll 1$, from Eq. (8) in the limit of no electro-osmosis ($m = 0$), which may seem surprising since there is no surface conduction in our one-dimensional model problem. (Hence, we use the symbol α_s rather than Du .) The reason is that in both cases — Dukhin's problem of electrophoresis of highly charged particles in weak applied fields and ours of electrode screening in strong applied fields — the double layer absorbs a significant amount of neutral salt from the bulk (reverse Donnan effect).

Net charge adsorption relative to the point of zero charge is measured by the *total* zeta potential,

$$\zeta_{tot} = \zeta_{eq} + \zeta_{ind} \quad (128)$$

where ζ_{eq} is the uniform equilibrium zeta potential (reflecting the initial surface charge) and ζ_{ind} is the non-uniform induced zeta potential (resulting from diffuse-charge dynamics). In Dukhin's problem, the former may be large, $\text{Du}(\zeta_{eq}) > 1$, but the latter is always small, $\zeta_{ind} \ll kT/ze$, so that the charging dynamics is linearized (or ignored). In our model problem, the situation is reversed: We assume $\zeta_{eq} = 0$ (for simplicity), but we allow for a large applied voltage, $\zeta_{ind} \approx v/(1+\delta) > kT/ze$, in which case the dynamics is nonlinear. In both cases, the steady state is well described by weakly nonlinear asymptotics as long as $\alpha_s(\zeta_{tot}) = \text{Du}(\zeta_{tot}) \ll 1$. When this

condition is violated, double-layer charging and surface conduction may cause significant changes in the steady-state bulk concentration.

B. Breakdown of Weakly Nonlinear Asymptotics

In general, weakly nonlinear *dynamics* breaks down at somewhat smaller voltages, where $\zeta_{tot} > kT/e$ but $\alpha_s(\zeta_{tot}) = \text{Du}(\zeta_{tot}) \ll 1$, because neutral-salt adsorption causes a *temporary, local depletion* of bulk concentration exceeding that of the steady state, after diffusional relaxation. In our model problem, the maximum change in bulk concentration occurs just outside the diffuse layers at $x = \pm 1$, just after the initial charging process finishes at time scale, $t = 1$ or $\bar{t} = \epsilon$. From Eq. (112), we have the first two terms of the weakly nonlinear asymptotic expansion there:

$$\bar{c}(\pm 1, \epsilon) \sim 1 - \sqrt{\frac{\epsilon}{\pi}} \tilde{w}_0(\infty). \quad (129)$$

At that time, the newly created diffusion layers have spread to $O(\sqrt{\epsilon})$ width, so the concentration is depleted locally by $O(\epsilon/\sqrt{\epsilon}) = O(\sqrt{\epsilon})$, which is much more than the uniform $O(\epsilon)$ depletion remaining after bulk diffusion.

Therefore, in order for the time-dependent correction term to be uniformly smaller than the leading term, we need

$$\alpha_d \equiv \sqrt{\frac{\epsilon}{\pi}} \tilde{w}_0(\infty) = \frac{\alpha_s}{\sqrt{\pi\epsilon}} \ll 1. \quad (130)$$

The relevant dimensionless parameter,

$$\alpha_d(\zeta_{tot}) = 4\sqrt{\frac{\lambda_D}{\pi L}} \sinh^2\left(\frac{ze\zeta_{tot}}{4kT}\right) \quad (131)$$

is larger than $\alpha_s(\zeta_{tot})$ (and the Dukhin number) by a factor of $\sqrt{L/\pi\lambda_D}$ in the limit of thin double layers. For weakly nonlinear dynamics to hold, the applied voltage cannot greatly exceed the thermal voltage,

$$\zeta_{tot} \approx \frac{V}{1+\delta} < \frac{kT}{ze} \log \frac{L}{\lambda_D}, \quad (132)$$

even for very thin double layers, $\lambda_D \ll L$, due to the logarithm. In comparison, the applied voltage can be twice as large before the steady-state bulk concentration is significantly affected (and surface conduction becomes important in higher dimensions). This could have interesting consequences for induced-charge electrokinetic phenomena [120] at moderate applied voltages where $\alpha_d > 1$ but $\alpha_s = \text{Du} < 1$.

C. Strongly Nonlinear Asymptotics

When condition (132) is violated, electrochemical relaxation becomes much more complicated because

double-layer charging is coupled to bulk diffusion. As long as $\alpha_d < 1$, however, the bulk remains quasi-neutral at all times. This regime of strongly nonlinear dynamics is demonstrated by the numerical solution in Fig. 10, for $v = 4$, $\epsilon = 0.05$, and $\delta = 0.1$, in which case $\alpha_d = 0.545$. In spite of the substantial $O(1)$ amount of charge transferred from one diffuse layer to the other, each retains almost exactly the same $O(\epsilon)$ width as at lower voltages, and bulk electro-neutrality remains an excellent approximation for all times. The initial charging process up to $t \approx 1$ creates a diffusion layer of neutral salt which relaxes into the bulk at the scale $\bar{t} \approx 1$ (or $t = \bar{t}/\epsilon \approx 20$).

In the strongly nonlinear regime, if α_s is not too small, double-layer charging is slowed down so much by nonlinearity that it continues to occur as the bulk diffusion layers evolve. One way to see this is that the effective RC time for the late stages of charging in Eq.(85) is

$$t_c(v) = C_i(v) \approx \cosh \frac{v}{2} \approx 2 \sinh^2 \frac{v}{4} \approx \frac{\alpha_s}{2\epsilon} \quad (133)$$

where we use the leading-order approximation of the differential capacitance, Eq. (88), for $\delta \ll 1$. In units of the bulk diffusion time, the nonlinear relaxation time is $\bar{t}_c = \epsilon t_c = \alpha_s/2$.

To make analytical progress, one would consider the joint limits

$$\epsilon \rightarrow 0 \quad \text{and} \quad v \rightarrow \infty \quad \text{with} \quad \alpha_d(v) > 0 \quad \text{fixed} \quad (134)$$

and expect the approximations to remain acceptable at somewhat larger voltages, as long $\alpha_s(v) < 1$. Such analysis is beyond the scope of this article, but at least we indicate how the leading order approximation would be calculated. (Going beyond leading order seems highly nontrivial.)

At leading order in the bulk, we have the usual equations for a neutral binary electrolyte (with equal ionic diffusivities),

$$\frac{\partial \bar{c}_0}{\partial \bar{t}} = \frac{\partial^2 \bar{c}_0}{\partial x^2} \quad \text{and} \quad \frac{\partial}{\partial x} \left(\bar{c}_0 \frac{\partial \bar{\phi}_0}{\partial x} \right) = 0 \quad (135)$$

with $\bar{\rho} = O(\epsilon^2)$. Integrating the second equation, we obtain a constant, uniform current density, $\bar{j}_0(t)$, as before, but the electric field is modified by concentration polarization,

$$\frac{\partial \bar{\phi}_0}{\partial x} = \frac{\bar{j}_0(t)}{\bar{c}_0(x, \bar{t})}. \quad (136)$$

The effective boundary conditions come from asymptotic matching with the diffuse layers as before,

$$\epsilon \frac{d\bar{q}_0}{d\bar{t}} = \bar{j}_0(t) \quad \text{and} \quad \epsilon \frac{d\bar{w}_0}{d\bar{t}} = \frac{\partial \bar{c}_0}{\partial x}(-1, \bar{t}) \quad (137)$$

only now the diffusive flux entering the diffuse layers (second equation) appears at leading order. The ionic

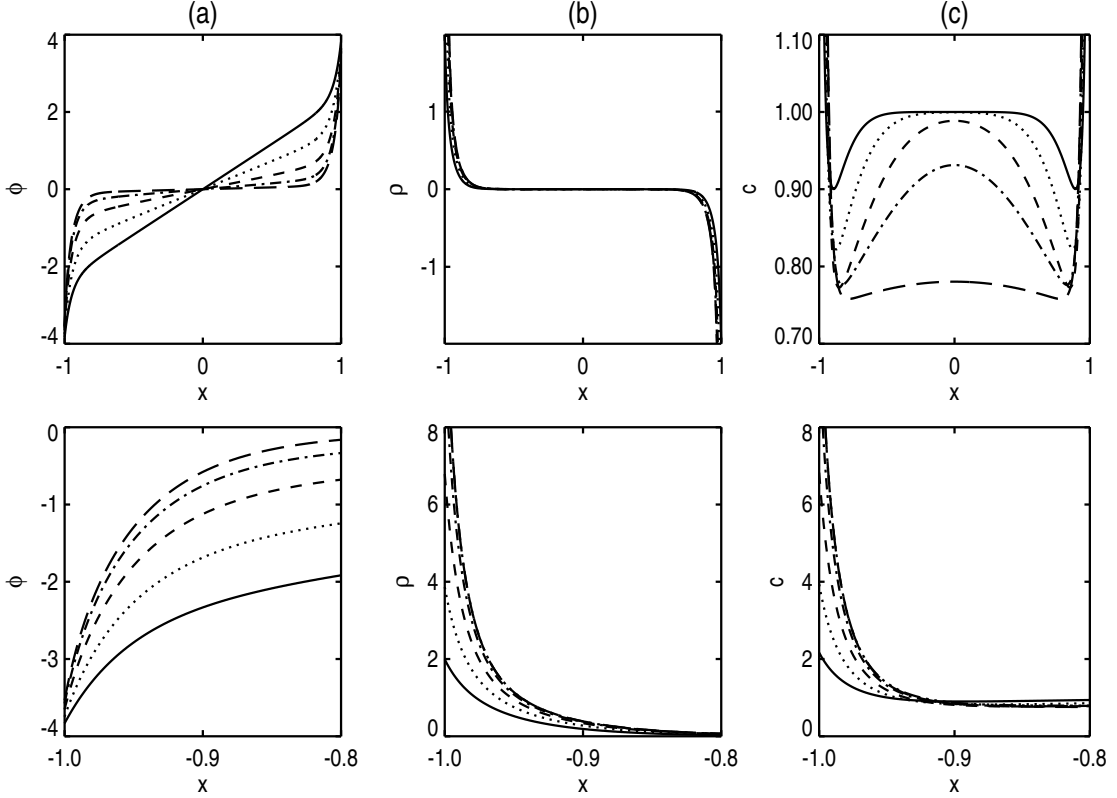

FIG. 10: Strongly nonlinear charging dynamics for $v = 4$ with $\epsilon = 0.05$ and $\delta = 0.1$. The potential (a), charge density (b), and concentration are shown in the half cell (top) and in the diffuse layer (bottom) for $t = 0.5$ (solid), 1 (dot), 2 (dash), 4 (dot-dash), 8 (dot-dot-dot-dash), and 20 (long dash).

concentrations retain Gouy-Chapman equilibrium profiles modified quasi-statically by the evolving nearby bulk concentration:

$$\tilde{q}_0(\bar{t}) = -2\sqrt{\bar{c}_0(-1, \bar{t})} \sinh\left(\frac{\tilde{\zeta}_0(\bar{t})}{2}\right) \quad (138)$$

$$\tilde{w}_0(\bar{t}) = 4\sqrt{\bar{c}_0(-1, \bar{t})} \sinh^2\left(\frac{\tilde{\zeta}_0(\bar{t})}{4}\right) \quad (139)$$

where

$$\tilde{\zeta}_0(\bar{t}) - \tilde{q}_0(\bar{t})\delta = \tilde{\Psi}_0(\bar{t}) = -v - \tilde{\psi}_0(-1, \bar{t}). \quad (140)$$

It seems exact solutions are not possible in terms of elementary functions. The equations are “stiff”, since they involve a short time scale, $\bar{t} = \epsilon$, for the initial phases of charging, but at least the spatial boundary layers have been “integrated out”, which is convenient for numerical solutions.

D. Space Charge at Very Large Voltages

We close this section by noting some intriguing, new possibilities, further into the strongly nonlinear regime.

At large voltages, such that $\alpha_d > 1$, it seems a *transient space charge layer* should form since the bulk concentration would be depleted almost completely near the diffuse layers by the initial charging process. In steady-state problems of Faradaic conduction, it is well known that double-layer structure is altered from its Gouy-Chapman equilibrium profile at a limiting current [132] and may turn into an extended space charge layer above a limiting current [133], but here we see that similar effects may also occur temporarily with large time-dependent voltages, in the absence of any Faradaic processes (at blocking electrodes). At still larger voltages, such that $\alpha_s > 1$, double layer charging consumes most of the bulk concentration, presumably leaving the entire bulk region in a state of “space charge”.

Such situations may seem quite exotic in macroscopic systems, where $\epsilon = \lambda_D/L$ is extremely small, but in microsystems perhaps they could occur. The mathematical model neglects bulk reactions (e.g. leading to hydrogen bubble formation), nonlinear dielectric properties, electro-convection, or other effects which may hinder the formation of space charge in real systems. Nevertheless, the rich nonlinear behavior of the model merits further mathematical study, as a challenging problem in time-dependent boundary-layer theory.

IX. BEYOND THE MODEL PROBLEM

We conclude by discussing more general situations, which contain some new physics, absent in our simple model problem. For thin double layers, the same methods of asymptotic analysis could be applied to derive effective equations in which the double layers are incorporated into boundary conditions, better suited for analytical or numerical work. Here, we simply sketch the results and suggest some other model problems for further study.

A. Two or More Dimensions

In the weakly nonlinear regime, where $\alpha_d < 1$ for all times over all double layers, our analysis extends trivially to higher dimensions, as long as the surface curvature does not introduce another length scale much smaller than L . In that case, the double layers are locally “flat”, and the boundary-layer calculations remain unchanged. Following the same procedure, we find that the bulk concentration is uniform at leading order, $\bar{c}_0 = 1$, and the bulk potential, $\bar{\phi}(\mathbf{r}, t)$, is a harmonic function,

$$\nabla^2 \bar{\phi} = 0, \quad (141)$$

subject to a (dimensionless) RC boundary condition at each electrode surface,

$$\frac{\partial \tilde{q}_0}{\partial t} = \tilde{C}(\bar{\phi}_0 - \phi_e) \frac{\partial(\bar{\phi}_0 - \phi_e)}{\partial t} = \mathbf{n} \cdot \nabla \bar{\phi}_0, \quad (142)$$

where \mathbf{n} is the unit normal pointing into the electrolyte and $\phi_e(\mathbf{r}, t)$ is the local electrode potential relative to the solution. The latter is equal to the local applied voltage plus the equilibrium zeta potential:

$$\phi_e(\mathbf{r}, t) = V(\mathbf{r}, t) + \zeta_{eq}(\mathbf{r}) \quad (143)$$

which accounts for any pre-existing double-layer charge (neglected in our calculations above). A Neumann boundary condition, $\mathbf{n} \cdot \nabla \bar{\phi}_0$, is imposed at any inert, non-polarizable surface, such as a channel side wall.

Another complication in two or more dimensions is the possibility of electro-osmotic flow. The fluid velocity in the bulk usually satisfies the Stokes equations, which may be unsteady for high-frequency forcing. In the weakly nonlinear regime, the classical Helmholtz-Smoluchowski formula gives the fluid slip in terms of the local zeta potential and tangential bulk electric field [27, 28, 29].

Equations (141) and (142) model the electrolyte as a bulk Ohmic resistor with a capacitor skin at electrode interfaces. The linearized version of these equations (with $\tilde{C} = \text{constant}$) has been studied extensively, e.g. in the context of metallic colloids [100, 104], AC electro-osmosis [2, 3, 4], AC pumping [6], and other phenomena of induced-charge electro-osmosis [120, 121]. The nonlinear version, however, has apparently not been analyzed, even though it may have relevance for experiments, in

which the condition, $v \ll 1$ ($V \ll kT/ze$), is routinely violated.

More significant modifications arise at leading order in the strongly nonlinear regime (or at higher order in the weakly nonlinear regime). Ohm’s law breaks down due to concentration gradients, as the double layers absorb a significant amount of neutral salt from the bulk. In two or more dimensions, the dimensionless leading-order equations for $\bar{c}_0(\mathbf{r}, t)$ and $\bar{\phi}_0(\mathbf{r}, t)$ in section VIII take the form,

$$\frac{\partial \bar{c}_0}{\partial t} = \nabla^2 \bar{c}_0, \quad \nabla \cdot (\bar{c}_0 \nabla \bar{\phi}) = 0, \quad (144)$$

where we scale time to the bulk diffusion time. This assumes $\alpha_d < 1$ so that no transient space charge layers form.

The effective boundary conditions still involve the small parameter, ϵ , as in one dimension, since the natural scale is the RC charging time, but there are some new terms in higher dimensions:

$$\epsilon \frac{\partial \tilde{q}_0}{\partial t} = \mathbf{n} \cdot (\bar{c}_0 \nabla \bar{\phi}_0) - \text{Du} \nabla_s \cdot \tilde{J}_s \quad (145)$$

$$\epsilon \frac{\partial \tilde{w}_0}{\partial t} = \mathbf{n} \cdot \nabla \bar{c}_0 - \text{Du} \nabla_s \cdot (\tilde{D}_s \nabla_s \tilde{w}_0) \quad (146)$$

The last term in Eq. (145) is the surface divergence of the (leading-order) dimensionless tangential current, \tilde{J}_s , in the diffuse layer; the size of this term compared to the normal current is governed by a Dukhin number, based on the largest expected total zeta potential. Similarly, the last term in Eq. (146) is the surface divergence of the tangential diffusive flux in the diffuse layer, where \tilde{D}_s is a dimensionless surface diffusivity; again, this term is of order Du smaller than the normal diffusive flux.

Formulae for \tilde{J}_s and \tilde{D}_s can be derived systematically using the matched asymptotic expansions, which is beyond the scope of this paper. The classical results of Bikerman [116, 117] and Deryagin and Dukhin [137] are available for the case of weak applied voltages ($\zeta_{ind} \ll kT/e$) and large equilibrium surface charges ($\zeta_{eq} > kT/e$, $\text{Du}(\zeta_{eq}) \approx 1$), and many Russian authors have studied electrokinetic phenomena in this regime [33, 34]. The case of strongly nonlinear dynamics ($\zeta_{ind} > kT/e$, $\alpha_d(\zeta_{ind}) \approx 1$), however, should be revisited in more detail to see if any changes arise for strong, time-dependent applied voltages. We suggest as a basic open question analyzing the electrochemical response of a metal cylinder or sphere in a strong, suddenly applied, uniform background DC field.

Another interesting issue is the stability of our one-dimensional solution. One should consider small space-dependent perturbations of the solution at various large voltages, in both the weakly nonlinear and strongly nonlinear regimes. The general transient analysis in two or more dimensions with the same equations and boundary conditions presents an interesting challenge.

B. General Electrolytes and Faradaic Reactions

Even in one dimension, it would be interesting to extend our analysis to more general situations involving asymmetric or multicomponent electrolytes, which undergo Faradaic processes at electrode surfaces. Restoring dimensions, the bulk electrolyte is described by the N ionic concentrations, C_i , $i = 1, 2, \dots, N$, satisfying mass conservation,

$$\frac{\partial C_i}{\partial \tau} = -\nabla \cdot \mathbf{F}_i \quad (147)$$

where \mathbf{F}_i is the flux density due to diffusion and electro-migration,

$$\mathbf{F}_i = -D_i \nabla C_i - \mu_i z_i e C_i \nabla \Phi \quad (148)$$

as in Eq. (11). For thin double layers, at leading order the bulk remains neutral (as long as $\alpha_d < 1$ to avoid space charge formation), so the potential is determined implicitly by the condition of electroneutrality,

$$\rho_e = \sum_{i=1}^N z_i e C_i = 0. \quad (149)$$

These are the standard equations of bulk electrochemistry [26], but interesting physical effects are contained in the effective boundary conditions.

Generalizing the total surface charge density q and excess surface concentration w , we define Γ_i to be the surface concentration of species i absorbed in the diffuse layer. To be precise, it is the integral of the leading-order excess concentration relative to the bulk over the inner coordinate, as in Eqs. (71) and (93). For example, $q = ze(\Gamma_+ - \Gamma_-)/2$ and $w = (\Gamma_+ + \Gamma_-)/2$ for a symmetric binary electrolyte.

Following the procedure above, the boundary conditions on the leading-order bulk approximation are of the

form:

$$-\frac{\partial \Gamma_i}{\partial \tau} = \mathbf{n} \cdot \mathbf{F}_i + \nabla_s \cdot \mathbf{F}_{si} + R_i \quad (150)$$

where $\mathbf{F}_{si}(C_i, \Phi)$ is the surface flux density of species i in the double layer [137] and $R_i(\{C_i\}, \Phi)$ is the reaction-rate density for any Faradaic processes consuming (or producing) species i at the surface. The usual assumption for R_i involves Arrhenius kinetics, as in the Butler-Volmer equation, but the Frumkin correction for concentration variations across the diffuse layer must be taken into account [25, 26].

The general system of nonlinear equations is challenging to solve, even numerically, due to multiple length and time scales. Boundary-layer theory provides only a partial simplification by integrating out the smallest length scale. As described in section II, various special cases of the effective equations have been considered in the literature, but much remains to be done, especially for strongly nonlinear dynamics in large applied voltages. In micro-electrochemical or biological systems, this regime is easily reached, so it merits additional mathematical study and comparison with experimental data, in part to test the applicability of the Nernst-Planck equations in micro-systems. Another interesting aspect is the coupling of electrochemical dynamics to fluid flow, which is finding new applications in microfluidic devices.

Acknowledgments

This work was supported in part by the MRSEC Program of the National Science Foundation under award number DMR 02-13282 (MZB), by ESPCI through the Paris Sciences Chair (MZB), and by an ACI from the Ministère de la Recherche (AA). We are grateful to K. Chu and the MIT librarians for help in obtaining articles from the ‘‘ancient’’ and Russian literatures.

-
- [1] A. Ramos, H. Morgan, N. G. Green, and A. Castellanos, *J. Phys. D: Appl. Phys.* **31**, 2338(1998).
 - [2] A. Ramos, H. Morgan, N. G. Green, A. Castellanos, *J. Colloid Interface Sci.* **217**, 420(1999).
 - [3] N. G. Green, A. Ramos, A. González, H. Morgan, and A. Castellanos, *Phys. Rev. E* **61**, 4011 (2000).
 - [4] A. González, A. Ramos, N. G. Green, A. Castellanos, and H. Morgan, *Phys. Rev. E* **61**, 4019(2000).
 - [5] N. G. Green, A. Ramos, A. González, H. Morgan, and A. Castellanos, *Phys. Rev. E* **66**, 026305 (2002).
 - [6] A. Ajdari, *Phys. Rev. E* **61**, R45(2000).
 - [7] A.B.D. Brown, C.G. Smith, A.R. Rennie, *Phys.Rev.E*, **63**, 016305 (2001).
 - [8] V. Studer, A. Pépin, Y. Chen, and A. Ajdari, *Microelectronic Eng.* **61**, 915 (2002).
 - [9] M. Mpholo, C.G. Smith, and A.B.D. Brown, *Sensors and Actuators B* **92**, 262 (2003).
 - [10] A. Ramos, A. González, A. Castellanos, N. G. Green, and H. Morgan, *Phys. Rev. E* **67**, 056302 (2003).
 - [11] F. Nadal, F. Argoul, P. Kestener, B. Pouligny, C. Ybert, and A. Ajdari, *Eur. Phys. J. E* **9**, 387 (2002).
 - [12] S. Yeh, M. Seul, and B. Shraiman, *Nature* **386**, 57 (1997).
 - [13] M. Trau, D. A. Saville, and I. A. Aksay, *Langmuir* **13**, 6375 (1997).
 - [14] C. Faure, N. Decoster, and F. Argoul, *Eur. Phys. J. B* **5**, 87 (1998).
 - [15] N. G. Green, A. Ramos, and H. Morgan, *J. Phys. D.: Appl. Phys.* **33**, 632 (2000).
 - [16] F. Nadal, F. Argoul, P. Hanusse, B. Pouligny, and A. Ajdari, *Phys. Rev. E* **65**, 061409 (2002).
 - [17] C. Marquet, A. Buguin, L. Talini, and P. Silberzan, *Phys. Rev. Lett.* **88**, 168301 (2002).
 - [18] W. D. Ristenpart, I. A. Aksay, and D. A. Saville, *Phys.*

- Rev. Lett. **90**, 12803 (2003).
- [19] W. Helfrich, Z. Naturforsch C **29**, 182 (1974).
- [20] M. D. Mitov, P. Méleard, M. Winterhalter, M. I. Angelova, and P. Bothorel, Phys. Rev. E **48**, 628 (1993).
- [21] R. Pethig, Critical Rev. Biotechnol. **16**, 331(1996).
- [22] L. Journiaux and J. P. Pozzi, J. Geophys. Res. **102**, 15335 (1997).
- [23] P. Reppert, F. D. Morgan, D. P. Lesmes, and L. Journiaux, J. Colloid Interface Sci. **234**, 194 (2001).
- [24] P. M. Reppert and F. D. Morgan, J. Colloid Interface Sci. **254**, 373 (2002).
- [25] A. J. Bard and L. R. Faulkner, *Electrochemical Methods: Fundamentals and Applications* (Wiley, New York, 1980).
- [26] J. Newman, *Electrochemical Systems* (Prentice-Hall, Englewood Cliffs, NJ, 1991).
- [27] R. J. Hunter, *Foundations of Colloidal Science* (Oxford, second edition, 2000).
- [28] W. B. Russel, D. Saville, and W. R. Schowalter, *Colloidal dispersions* (Cambridge University Press, 1989).
- [29] J. Lyklema, *Fundamentals of Interface and Colloid Science*, Vol. 2 (Academic Press, New York, 1995).
- [30] J. D. Ferry, J. Chem. Phys. **16**, 737 (1948).
- [31] J. R. Macdonald, Trans. Faraday Soc. **67**, 943 (1970).
- [32] A. A. Kornyshev, and M. A. Vorotyntsev, Electrochimica Acta **26**, 303 (1981).
- [33] S. S. Dukhin and V. N. Shilov, Adv. Colloid Inteface Sci. **13**, 153 (1980).
- [34] S. S. Dukhin, Adv. Colloid Interface Sci. **44**, 1 (1993).
- [35] M. Scott, K. V. I. S. Kaler, and R. Paul, J. Colloid Interface Sci. **238**, 449 (2001).
- [36] A. Ramos, A. González, N. G. Green, H. Morgan, and A.Castellanos, J. Colloid Interface Sci. **243**, 265 (2001).
- [37] J. R. Macdonald, Electrochim. Acta **35**, 1483 (1990).
- [38] L. A. Geddes, Ann. Biomedical Eng. **25**, 1 (1997).
- [39] C. M. Bender and S. A. Orszag, *Advanced Mathematical Methods for Scientists and Engineers: Asymptotic Methods and Perturbation Theory* (Springer, 1999).
- [40] E. J. Hinch, *Perturbation Methods* (Cambridge University Press, 1991).
- [41] J. Kevorkian and J. D. Cole, *Multiple Scale and Singular Perturbation Methods* (Springer, New York, 1996).
- [42] F. Kohlrausch, Pogg. Ann. **148**, 143 (1873).
- [43] H. L. F. von Helmholtz, Ann. Physik **89**, 211 (1853).
- [44] H. L. F. von Helmholtz, Ann. Phys. Chem. **7**, 337 (1879).
- [45] G. Gouy, Ann. Chim. Phys. **29**, 145 (1903).
- [46] E. Warburg, Ann. Phys. Chim. **67**, 493 (1899).
- [47] E. Warburg, Ann. Phys. **6**, 125 (1901).
- [48] F. Krüger, Z. Phys. Chem. **45**, 1 (1903).
- [49] J. E. B. Randles, Disc. Faraday Soc. **1**, 11 (1947).
- [50] G. Gouy, Compt. Rend. **149**, 654 (1909).
- [51] G. Gouy, J. Phys. (4) **9**, 45 (1910).
- [52] A. Einstein, Ann. Physik **19**, 371 (1905).
- [53] P. Debye and E. Hückel, Physik. Z. **24**, 185 (1923).
- [54] P. Debye and E. Hückel, Physik. Z. **24**, 305 (1923).
- [55] D. L. Chapman, Phil. Mag. **25**, 475 (1913).
- [56] P. Delahay, *Double Layer and Electrode Kinetics* (John Wiley, New York, 1965).
- [57] J. O'M. Bockris and A. K. N. Reddy, *Modern Electrochemistry* (Plenum, New York, 1970).
- [58] M. Sluyters-Rehbach and J. H. Sluyters, in *Electroanalytical Chemistry* **4**, 1–128, ed. by A. J. Bard (Marcel Dekker, New York, 1970).
- [59] R. Parsons, Chem. Rev. **90**, 813 (1990).
- [60] O. Stern, Z. Electrochem. **30**, 508 (1924).
- [61] M. A. Vorsina and A. N. Frumkin, Compt. Rend. Acad. Sci. U. R. S. S. **24**, 918 (1939).
- [62] D. C. Grahame, Chem. Rev. **41**, 441 (1947).
- [63] J. R. Macdonald, J. Chem. Phys. **22**, 1857 (1954).
- [64] D. C. Grahame, J. Chem. Phys. **18**, 903 (1950).
- [65] A. D. Hollingsworth and D. A. Saville, J. Colloid and Interface Sci. **257**, 65 (2003).
- [66] I. L. Cooper and J. A. Harrison, J. Electroanal. Chem. **86**, 425 (1978).
- [67] W. Nernst, Z. Physik. Chem. **2**, 613 (1888).
- [68] W. Nernst, Z. Physik. Chem. **4**, 129 (1889).
- [69] M. Planck, Ann. Phys. Chem. **39**, 161 (1890).
- [70] G. Jaffé and C. Z. LeMay, J. Chem. Phys. **21**, 920 (1953).
- [71] A. A. Kornyshev, and M. A. Vorotyntsev, Phys. Stat. Sol. (a) **39**, 573 (1977).
- [72] A. A. Kornyshev, and M. A. Vorotyntsev, Electrochimica Acta **23**, 267 (1978).
- [73] R. P. Buck, J. Electroanal. Chem. **23**, 219 (1969).
- [74] P. Debye and H. Falkenhagen, Physik. Z. **29**, 121 (1928).
- [75] H. Falkenhagen, *Electrolytes* (Oxford University Press, 1934).
- [76] G. Jaffé, Ann. Physik **16**, 249 (1933).
- [77] G. Jaffé, Phys. Rev. **85**, 354 (1952).
- [78] H.-C. Chang and G. Jaffé, J. Chem. Phys. **20**, 1071 (1952).
- [79] J. R. Macdonald, Phys. Rev. **92**, 4 (1953).
- [80] R. Friauf, J. Chem. Phys. **22**, 1329 (1954).
- [81] C. G. J. Baker and E. R. Buckle, Trans. Faraday Soc. **64**, 469 (1968).
- [82] J. R. Macdonald, J. Chem. Phys. **61**, 3977 (1974).
- [83] J. R. Macdonald, J. Electroanal. Chem. **53**, 1 (1974).
- [84] J. H. Beaumont and P. W. M. Jacobs, J. Phys. Chem. Solids **28**, 657 (1967).
- [85] E. M. Itskovich, A. A. Kornyshev, and M. A. Vorotyntsev, Phys. Stat. Sol. (a) **39**, 229 (1977).
- [86] J. Gunning, D. Y. C. Chan, and L. R. White, J. Colloid interface Sci. **170**, 522 (1995).
- [87] M. Scott, R. Paul, and K. V. I. S. Kaler, J. Colloid Interface Sci. **320**, 377 (2000).
- [88] M. Scott, R. Paul, and K. V. I. S. Kaler, J. Colloid Interface Sci. **320**, 388 (2000).
- [89] E. H. B. DeLacey and L. R. White, J. Chem. Soc. Faraday Trans. 2 **78**, 457 (1982).
- [90] V. G. Levich, Doklady Akad. Nauk SSSR **67**, 309 (1949).
- [91] A. Frumkin, Z. Electrochem. **59**, 807 (1955).
- [92] J. R. Macdonald, J. Electroanal. Chem. **70**, 17 (1976).
- [93] J. R. Macdonald and P. W. M. Jacobs, J. Phys. Chem. Solids **37**, 1117 (1976).
- [94] D. R. Franceschetti and J. R. Macdonald, J. Electroanal. Chem. **82**, 271 (1977).
- [95] A. Bonnefont, F. Argoul, and M. Z. Bazant, J. Electroanal. Chem. **500**, 52 (2001). For a preprint with more results from Ref. [96], see cond-mat/0006104.
- [96] A. Bonnefont, *Local methods of characterizing the dynamics of transport and reactivity of an interface*, Ph.D. thesis, Université de Bordeaux (2000).
- [97] T. Brumleve and R. Buck, J. Electroanal. Chem **90**, 1 (1978).
- [98] W. D. Murphy, J. A. Manzanares, S. Mafé, and H. Reiss, J. Phys. Chem. **96**, 9983 (1992).
- [99] H. Cohen and J. W. Cooley, Biophys. J. **5**, 145 (1965).
- [100] V. A. Murtsovkin, Kolloidn. Zh. **58**, 358 (1996).
- [101] S. Dukhin, in *Encyclopedia of Surface and Colloid Science*, ed. by M. Dekker, 3677 (2002).

- [102] V. G. Levich, *Physicochemical Hydrodynamics* (Prentice-Hall, Englewood Cliffs, NJ, 1962).
- [103] I. N. Simonov and V. N. Shilov, *Kolloidn. Zh.* **35**, 381 (1973).
- [104] I. N. Simonov and V. N. Shilov, *Kolloidn. Zh.* **39**, 878 (1977).
- [105] N. I. Gamayunov, V. A. Murtsovkin, and A. S. Dukhin, *Kolloidn. Zh.* **48**, 233 (1986).
- [106] I. N. Simonov and S. S. Dukhin, *Kolloidn. Zh.* **35**, 191 (1973).
- [107] T. S. Simonova and S. S. Dukhin, *Kolloidn. Zh.* **38**, 86 (1976).
- [108] V. N. Shilov and T. S. Simonova, *Kolloidn. Zh.* **43**, 114 (1981).
- [109] T. S. Simonova, V. N. Shilov, and O. A. Shramko, *Kolloidn. Zh.* **63**, 114 (2001).
- [110] B. V. Deryagin, S. S. Dukhin, and V. N. Shilov, *Adv. Colloid. Interface Sci.* **13**, 141 (1980).
- [111] S. S. Dukhin and B. V. Derjaguin, in *Surface and Colloidal Science*, ed. by E. Matijevic and F. R. Eirich, Vol. 7 (Wiley, New York, 1974).
- [112] R. W. O'Brien, *J. Colloid Interface Sci.* **92**, 204 (1983).
- [113] E. J. Hinch, J. D. Sherwood, W. C. Chew, and P. N. Sen, *J. Chem. Soc., Faraday Trans 2* **80**, 535 (1984).
- [114] D. C. Prieve, J. L. Anderson, J. P. Ebel, and M. E. Lowell, *J. Fluid Mech.* **148**, 247 (1984).
- [115] J. L. Anderson, *Ann. Rev. Fluid Mech.* (1989).
- [116] J. J. Bikerman, *Z. Physik. Chem.* **A163**, 378 (1933).
- [117] J. J. Bikerman, *Kolloid Zeitschrift* **72**, 100 (1935).
- [118] J. J. Bikerman, *Trans. Faraday Soc.* **36**, 154 (1940).
- [119] J. T. G. Overbeek, *Kolloidchem. Beih.* **59**, 287 (1943).
- [120] M. Z. Bazant and T. M. Squires, preprint, <http://arXiv.org/abs/physics/0306100>.
- [121] T. M. Squires and M. Z. Bazant, preprint, <http://arXiv.org/abs/physics/0304090>.
- [122] B. M. Grafov and A. A. Chernenko, *Dokl. Akad. Nauk S.S.S.R.* **146**, 135 (1962).
- [123] A. A. Chernenko, *Dokl. Akad. Nauk SSSR*, **153**(5), 1129 (1963).
- [124] J. Newman, *Trans. Faraday Soc.* **61**, 2229 (1966).
- [125] A. D. Macgillivray, *J. Chem. Phys.* **48**, 2903 (1968).
- [126] I. Rubinstein, *Electro-Diffusion of Ions* (SIAM, Philadelphia, 1990).
- [127] J. Henry and B. Louro, *Nonlinear Anal.* **13**, 787 (1989).
- [128] B. Louro, *Portugaliae Mathematica* **48**, 179 (1991).
- [129] J. Henry and B. Louro, *Asymptotic Anal.* **10**, 297 (1995).
- [130] J.-H. Park and J. W. Jerome, *SIAM J. Appl. Math.* **57**, 609 (1997).
- [131] V. Barcion, D.-P. Chen, R. S. Eisenberg, and J. W. Jerome, *SIAM J. Appl. Math.* **57**, 631 (1997).
- [132] W. Smyrl and J. Newman, *Trans. Faraday Soc.* **63**, 207 (1967).
- [133] I. Rubinstein and L. Shtilman, *J. Chem. Soc. Faraday Trans. II* **75**, 231 (1979).
- [134] S. S. Dukhin and V. N. Shilov, *Kolloidn. Zh.* **31**, 706 (1969).
- [135] S. S. Dukhin and N. M. Semenikhin, *Kolloidn. Zh.* **32**, 360 (1970).
- [136] R. W. O'Brien and L. R. White, *J. Chem. Soc. Faraday Trans. II* **74**, 1607 (1978).
- [137] B. V. Deryagin and S. S. Dukhin, *Kolloidn. Zh.* **31**, 350 (1969).
- [138] F. G. Donnan and A. B. Harris, *J. Chem. Soc.* **99**, 1554 (1911).
- [139] F. G. Donnan, *Z. Elektrochem.* **17**, 572 (1911).
- [140] F. G. Donnan, *Chem. Rev.* **1**, 73 (1924).
- [141] J. Lyklema, *Fundamentals of Interface and Colloid Science*, Vol. 1 (Academic Press, New York, 1995).