

A Framework for Curriculum Transformation in Quantum Information Science and Technology Education

Simon Goorney^{1,2,†}, Jonas Bley^{3,†}, Stefan Heusler⁴, Jacob Sherson^{1,2,*}

¹ Department of Management, School of Business and Social Science, Aarhus University

² Niels Bohr Institute, University of Copenhagen, Denmark

³ Department of Physics and Research Center OPTIMAS, RPTU Kaiserslautern-Landau, 67663 Kaiserslautern, Germany

⁴ Institute for Didactics of Physics, Münster university, Wilhelm-Klemm-Str. 10, D-48149 Münster, Germany

[†] These authors contributed equally to this work and share first authorship

* Correspondence: sherson@mgmt.au.dk

History: Received: 21st August 2023, Revised: 6th December 2023

Keywords: Quantum Education, Interdisciplinarity, Didactical Framework, Quantum Teleportation, Curriculum Development

Abstract. The field of Quantum Information Science & Technology (QIST) is booming. Due to this, many new educational courses and university programs are needed in order to prepare a workforce for the developing industry. Owing to its specialist nature, teaching approaches in this field can suffer with being disconnected from the substantial degree of science education research which aims to support the best approaches to teaching in Science, Technology, Engineering & Mathematics (STEM) fields. In order to connect these two communities with a pragmatic and repeatable methodology, we have synthesised this educational research into a decision-tree based theoretical model for the transformation of QIST curricula, intended to provide a didactical perspective for practitioners. The Quantum Curriculum Transformation Framework (QCTF) consists of four steps: 1. choose a topic, 2. choose one or more targeted skills, 3. choose a learning goal and 4. choose a teaching approach that achieves this goal. We show how this can be done using an example curriculum and more specifically quantum teleportation as a basic concept of quantum communication within this curriculum. By approaching curriculum creation and transformation in this way, educational goals and outcomes are more clearly defined which is in the interest of the individual and the industry alike. The framework is intended to structure the narrative of QIST teaching, and with future testing and refinement it will form a basis for further research in the didactics of QIST.

1. Introduction

The field of Quantum Information Science & Technology (QIST), although originating in physics, is gaining increasing interdisciplinary popularity [1]. This is presently inducing a significant rise in the number of degree programs and courses in this field [2, 3], which requires a didactical perspective which is currently significantly lacking, due to its rapid development and specialist nature. As a result, it is of

great importance that the results of didactical research are incorporated into quantum curriculum creation and transformation at the present time. There are also several immense challenges that the field presents: Its interdisciplinarity and complexity makes content preparation difficult as many concepts require perspectives from different fields. Additionally, many current teaching methods are suited to learners of particular academic backgrounds, stemming from disciplines such as Physics and Computer science. However, learners come to the QIST classroom from many fields which means that these approaches must be adapted. [4].

Given the importance of widespread, progressive education and training in QIST, the European Quantum Technology Education community (QTEdu) have developed practical guidelines for educators in non-formal contexts, and in the high school environment [5, 6]. However, the most urgent need for quality education is in the university context, where graduates of Bachelor and Master programs in STEM fields will make up the emerging quantum workforce [3]. More advanced topics in QIST are particularly challenging to teach, due to the specialist knowledge required [7]. As a result, the majority of teaching faculty are based in Physics, Information Sciences, or Engineering, without access to significant pedagogical support [4].

Many of these practitioners are not grounded in knowledge of those core educational principles which may be background for high school teachers. For this reason, and in order to promote dialogue between didactics and educators, there needs to exist advice that is easy to follow. Additionally, this should be industry-needs oriented as preparing the quantum workforce for work in the industry is a major intent of many quantum courses [8–10]. For this purpose, in this work we present a didactical teaching framework, the Quantum Curriculum Transformation Framework (QCTF), based on a decision tree which can be used to guide practitioners through teaching design, from topic selection to the specific teaching approach based on existing didactical theory. It should be emphasised that subsections of the framework may also be used in order to support specific aspects of pedagogical preparation, even if the complete framework is not applicable in every case. In addition, it may be extended and modified when presented with new research results. The framework is summarised in Fig. 1.

In the level of school education, there exists a storied tradition of research on the use of pedagogical content mapping, [11, 12], as a means of aligning learning material with teaching methods which are most optimal for promoting different kinds of learning outcomes. However, this approach is rarely taken at the university level, and never in the field of QIST. There are many differences between higher education and secondary school in the complexity and the interdisciplinarity of content, in the time scopes and time available to study specific subjects and, perhaps most importantly, in the learners. Although at the university level, QIST has attracted attention toward research into student understanding [13], and development of novel teaching methods [14], there is little research available into how best to build up curricula from these components. This article, and the QCTF we propose, aims to address this.

The paper is structured as follows: In Sect. 2, we summarise the basis for choosing educational content (the “what”), which makes use of the European Competence Framework (CF) for Quantum Technologies [15]. Then, three targeted skills areas are introduced in Sect. 3, as both a motivation and a means of communicating the content chosen to teach. In Sect. 4, a modified Bloom’s taxonomy is described for use in defining learning goals. In Sect. 5, Ainsworth’s Designs, Functions, Tasks (DeFT) framework is summarised and applied to the QIST context in Sect. 6. Lastly, we

show a possible explicit teaching approach to quantum teleportation based on our framework in Sect. 7. Throughout this work, we will stick to examples to ground the QCTF and convey the meaning of the didactical theory in the QIST context. Quantum teleportation is chosen as a topic specifically because it makes use of various concepts central to QIST: entanglement, measurements and unitary operations in three-qubit systems and has many applications [16]. In order to make the ordering of the framework’s sections more explicit and intuitive for practitioners, we roughly structure it into a “what” - “why” - “how” format, in which we first choose content to be taught, then formulate specific teaching goals for the interaction, and then consider the specific teaching approaches which best address these goals while also respecting the diversity of student backgrounds. As such, our approach is akin to a backwards design process [17].

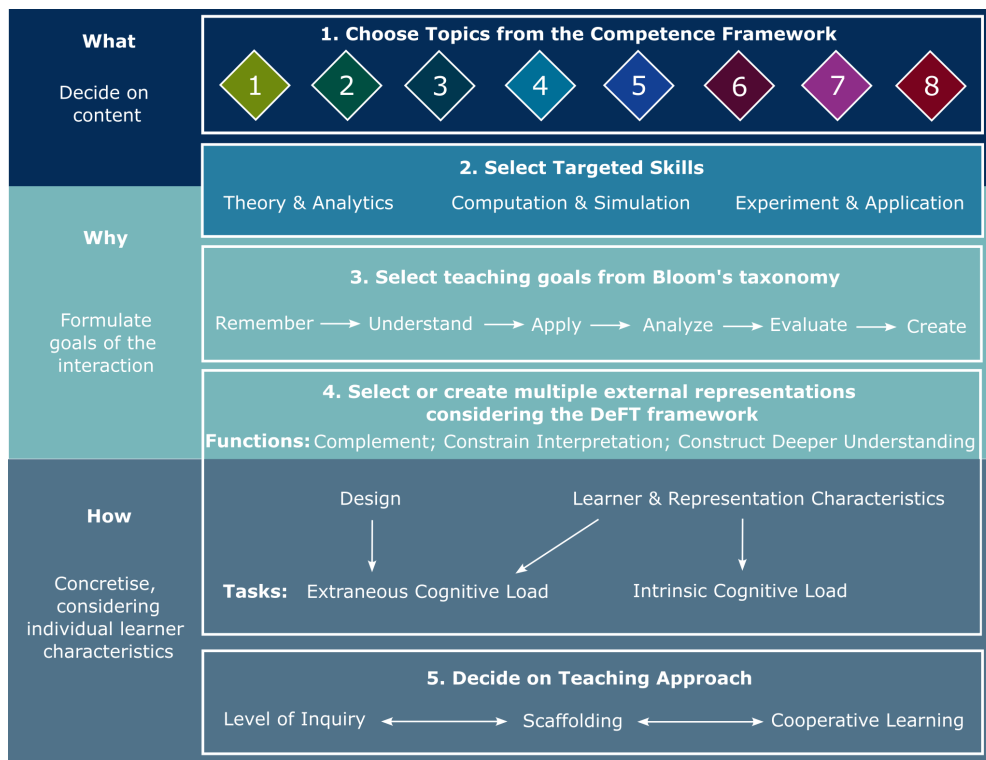

Figure 1. The Quantum Curriculum Transformation Framework (QCTF), a decision-tree based methodology for designing and transforming educational material and methods in QIST. It is based on a What - Why - How - approach, starting with the European Competence Framework for Quantum Technologies [15] and concretising towards specific teaching approaches that are based on didactical research.

2. Competence Framework

The European Competence Framework (CF) for Quantum Technologies is a tool designed by the Quantum Flagship, the EU funding program for QIST, intended as a

common language for communicating skills in the field. The framework has utilised a Delphi method to identify key content according to industry needs [10], and is presently available in version 2.0 [18], providing a structured overview of the field. It may be used to describe skills required for jobs, learning outcomes from courses, and content of entire degree programs. The QCTF builds on the CF as a backbone, providing a means to determine content selection when designing educational initiatives. Each topical domain is assigned a number 1-8, covering Quantum Background (domains 1 and 2), Core Device Technologies (domains 3 and 4), and QT systems and applications (domains 5-8). Within each domain, topics are assigned numbers such that a complete map can be generated of knowledge in QIST. An overview of the CF domains is shown in Fig. 2.

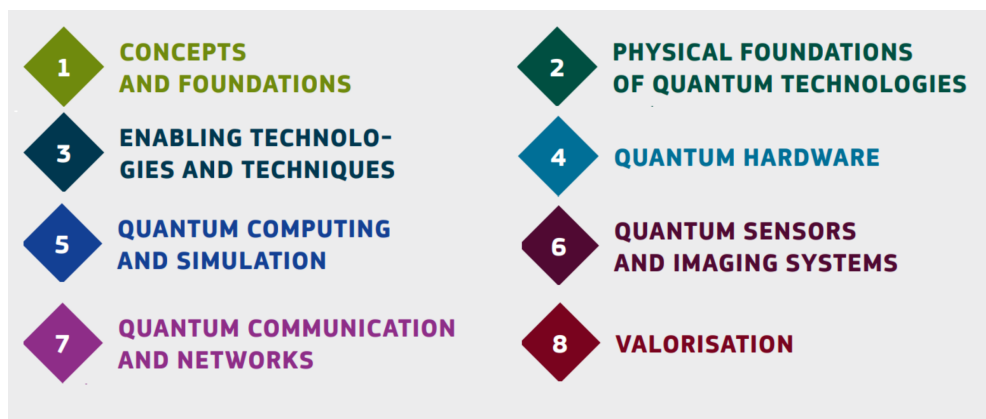

Figure 2. The 8 domains of the European Competence Framework for Quantum Technologies, covering Quantum Background (domains 1 and 2), Core Device Technologies (domains 3 and 4), and QT systems and applications (domains 5-8). Adapted from [15].

For use in designing curricula, we present an application-oriented example of a small curriculum with topics chosen from the CF, focusing on the basics of quantum technologies and quantum communication, in Fig. 3.

That plain knowledge transfer, e.g. in the form of purely a traditional lecture is not effective is well known [19,20]. Therefore, planning courses should not stop after it has been decided which concepts to teach but rather should go further, considering first the skills that the learners should achieve in the context of the chosen concepts. We classify these skills in the following.

3. Targeted Skills

In the context of higher education on quantum technology, we see possible targeted skills in three main areas: Theory & Analytics, Computation & Simulation and Experiment & Real World. We emphasise that these targeted skills are those engaged in different approaches to teaching topics in all eight domains of the CF. We do not present these as a classification scheme for concepts, which is in fact the role of the CF itself [10]. Rather it is possible for many concepts to engage several or all of the “targeted skills”. Quantum Teleportation, for example, is a rich topic which can be

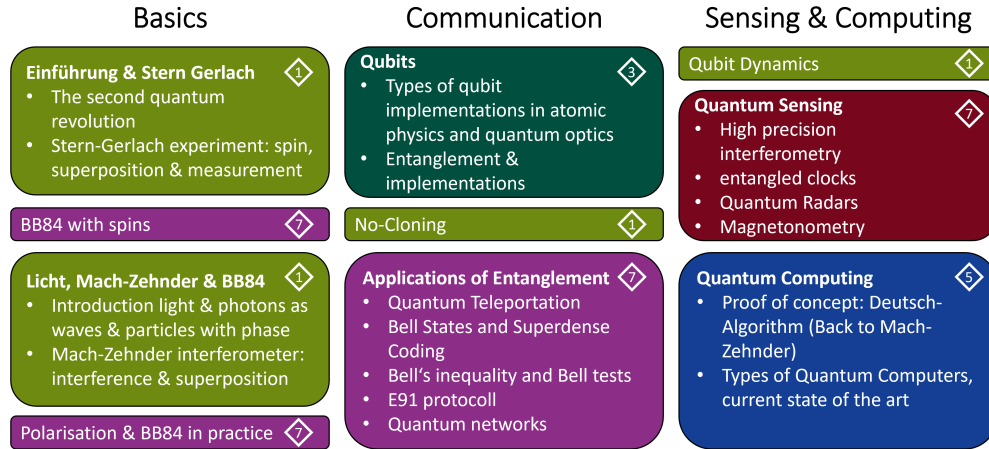

Figure 3. Application oriented example curriculum coloured using the Competence Framework [15]. These three modules could be part of, e.g. a one- or two-week workshop covering the basics of QIST, quantum communication and giving an outlook into quantum sensing and computing.

approached with a view to developing each of these three targeted skills, while other topics may be limited to developing a subset of these skills.

QIST, in many cases, allows or even necessitates an interdisciplinary view. For example, quantum computing algorithms are significantly restricted by the hardware that they run on. Gate times and fidelities limit circuit depth and general complexity of possible algorithms, which can be summarised by performance benchmarks [21]. This leads to the practical problems of finding the right quantum computer for a specific algorithm [22] and, in addition, determining which algorithms work well on a given hardware architecture [23, 24]. This means that expertise in both areas is required to make justified decisions. As is also pointed out in [10], generally one would address industry needs by having skills in all three of these skill areas.

3.1. Theory & Analytics

When targeting theoretical skills, one targets the skill of derivation and proof of theoretical ideas within QIST like the no-cloning-theorem or the no-communication theorem. Instead of just being able to recite these theorems, learners ideally should understand the process of arriving at them. By doing so, they gain skills required to expand the given set of ideas, the theoretical framework of QIST, built up on complex euclidean spaces or so-called Hilbert spaces [25, 26], to generate new knowledge. In Sect. 4, we concretise this using Bloom's taxonomy.

Analytical skills refer to calculations involving numbers or variables. In QIST, e.g. the Dirac ket notation is popular to represent vectors and linear transformations in these complex vector spaces. As an example, the skill of calculating the effects of various quantum logic gates (linear transformations) within this notation or the equivalent vector notation can be targeted. We refer to, e.g. the textbooks [25–27] for more details on QIST from this perspective.

3.2. Computation & Simulation

When targeting computational skills, a focus lies on programming within QIST. This can be done in various different languages and libraries, e.g. in Python using a library like Qiskit [28] or PennyLane [29], in C++, e.g. with the Intel Quantum Software Development Kit (QSDK) [30] or in the standalone languages Open Quantum Assembly Language (OpenQASM) [31], Q# [32] or Silq [33], but there are also many more that are reviewed in, e.g. [34]. These languages can be deployed on real quantum hardware or simulators. Real quantum hardware tends to be noisy, especially for large systems of qubits and simulating them is exponentially difficult in the number of qubits [35,36]. Gate errors can also be simulated and analysed within these simulations [37] as these are and will be much more relevant than in classical computing. This is where the field of quantum error correction starts [38].

We refer to textbooks such as [39,40] for more detail on QIST from this perspective.

3.3. Experiment & Real World

Last but not least, QIST can be approached from an experimental perspective. Skills in this area can cover a vast array of planning and preparation of experimental setups, a deep understanding of the functioning of the devices that are used, practical skills like calibration and adjustment of these devices and data acquisition and analysis [41]. In the context of quantum information science and technology, qubit platforms and types are of special interest for transport of quantum information (quantum communication), precise measurement of real world quantities like temperature or magnetic fields (quantum sensing) or universal and analogue quantum computing. Knowledge and skills required to get into one of these fields in these areas can be targeted with textbooks like [42,43] and in practical lab courses. Typical challenges that are discussed in more detail in [41] include evoking excitement and making quantum effects “visible” with these challenges being tied to another. How to achieve the latter and further benefits, like gaining intuition and familiarity of quantum mechanics, gaining conceptual understanding and getting a sense for possible applications in the field of quantum technologies, are discussed in [44].

All of these three categories are vast in that they each define multiple fields of research. The sheer endless amount of content to choose from and skills that could be acquired is a challenge for educators in the field of QIST education. Due to this complexity, theoretical frameworks like the CF are needed to aid in the selection process. With our framework, we aim to go beyond the level of pure content towards a practical guideline that is applied to curriculum transformation and creation by educators. This is shown further in the following sections.

4. Learning Objectives & Bloom’s taxonomy

The more specific question of which cognitive learning goals within these areas of expertise should be accomplished can be asked next. A classification of these learning goals can help for various reasons. First of all, it encourages aiming for learning goals beyond just remembering and understanding concepts. Secondly, the structure can help align the educator’s purposes with that of the learners, aligning the teaching process with valid performance tests [45]. In [46], the authors discuss this alignment

for the purpose of designing empirical studies, arguing that if learning goals beyond memorisation should be achieved, ways to test this also have to be found. In QIST education specifically, there is a lack of standardisation of teaching material and measurement of learning outcomes [4].

Bloom's taxonomy is a classification scheme of such learning goals widely used in high school education. It comes in variations, but often six levels are defined based on increasing cognitive demand which represent lower order thinking skills to higher order thinking skills [47,48]. In the traditional taxonomy, higher order skills can only be reached if the previous skill is attained, defining a theoretical progression. This formulation of Bloom's taxonomy is displayed in Fig. 4.

Bloom's taxonomy is used, e.g. in computer science education [49] and is also explored in physics education [50,51]. Its wide use may be attributed to its simplicity and practicality, particularly in the High school setting where the hierarchical nature of the 6 levels can be used to set clear learning objectives for students with a variety of backgrounds and interests. Despite this, the taxonomy in its traditional form may come with some limitations, particularly when applied to the context of higher education. In [52], Bhaw and Kriek point out that while cognitive demand associated with the six levels may indeed be hierarchical, learning situations in science education rarely involve only individual levels. Rather, they are inherently connected, for example when applied to problem-solving. In an evaluation problem for example, comparing two different approaches to address a problem requires understanding them both.

Similarly, in the context of QIST, we further re-interpret the taxonomy, for the following reason. The foundational concepts in QIST are well known to be abstract and disconnected from everyday life, far more so than many other areas of science [52]. As a result, the lower-order skills: understanding, and even basic knowledge, of concepts in QIST actually demand application of the higher-order skills. It is impossible to understand ideas such as superposition and entanglement, off which quantum technologies are based, without creative thought and imagination, as any possible realistic representation of these concepts are inherently non-everyday objects. This abstract nature also demands an inherent comparison to the classical world, and associated evaluative and analytical thinking. Our re-interpretation of Bloom's taxonomy, as applicable in fields such as QIST in which the relationship between the cognitive skills involved is not purely hierarchical, is shown in Fig. 4.

In the following, we provide example tasks in each of the three targeted skill areas for every level of the original Bloom's taxonomy in the context of quantum teleportation. These don't constitute an exhaustive list of such questions. Nevertheless, one can assume that the concept of quantum teleportation and its connection to QIST is thoroughly understood if all these tasks are accomplished by a learner.

4.1. Bloom's taxonomy applied to Quantum Teleportation

In the following, we show example tasks in the context of quantum teleportation for each of the three targeted skill areas (Sect. 3 and for every level of Bloom's taxonomy) and cite references that can be consulted to approach these tasks. In this way, Bloom's taxonomy enables the creation of tasks for topics within QIST and structuring of the educator's intentions for student's learning outcomes. Bloom's taxonomy is often implemented using verb lists, where task-defining verbs are mapped to a corresponding

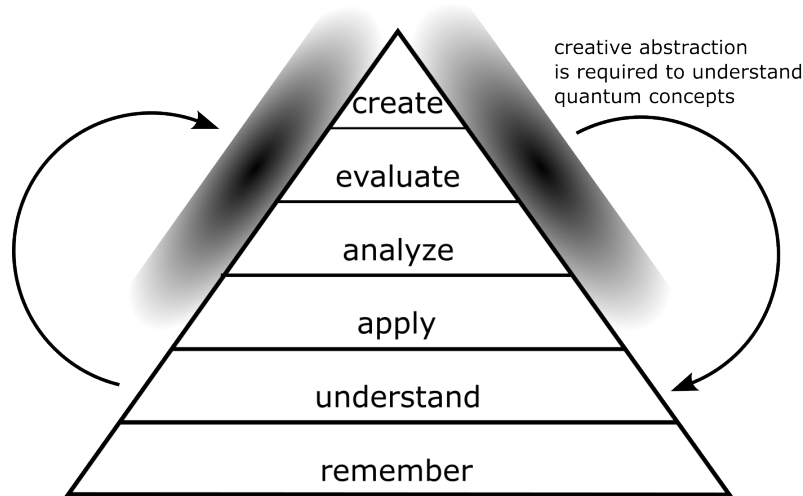

Figure 4. Revised Classical Bloom's Taxonomy appropriate for use in describing learning outcomes in QIST, adapted from [47]. Since creative abstraction is required in order to understand basic quantum concepts, the relationship between Bloom's thinking skills is non-hierarchical.

level in Bloom's taxonomy, see, e.g. [53, 54], with some overlap of verbs into multiple levels, which is discussed in [55]. In the following, we use selected verbs from these lists.

Theory & Analytics

Remember

Name the quantum gates used in the quantum teleportation algorithm. [27]

Understand

Describe the process of quantum teleportation abstractly (independent of the implementation) [27]. Describe why the no-cloning-theorem is not violated [56]. Discuss why no faster than light communication is happening. [56]

Apply

Use the Bell basis to describe the quantum teleportation algorithm mathematically. [57]

Analyse

Examine the effect of decoherence on the resulting state in the quantum teleportation algorithm. [58, 59]

Examine the effect of quantum teleportation if it is applied to a qubit that is itself entangled in a multi-qubit system. [60]

Evaluate

Argue whether Quantum Teleportation is an inherent advantage of quantum physics in respect to classical physics or if it is more of a workaround necessary due to no-cloning. [61]

Create

Design a quantum teleportation algorithm for states of two qubits. [62, 63] Design

a quantum teleportation algorithm such that three parties can exchange quantum information with each other. [64]

Computation & Simulation

Remember

List the functions in the Qiskit library that are used in the quantum teleportation algorithm. [30]

Understand

Add comments to explain each line of code in the quantum teleportation algorithm. [65]

Apply

Translate the Qiskit code to another Python library, like PennyLane. [66]

Analyse

Compare the resulting fidelities of teleported states in various quantum computers for different qubit choices. [59, 65]

Evaluate

Select the best hardware to perform quantum teleportation on (being restricted, e.g. to the free IBM hardware). [30, 67]

Create

Program a python notebook with the Qiskit library, implementing a quantum network using a starting node, two middle nodes and an end node, where quantum information is teleported from one qubit to the last using three auxiliary qubits and a stationary qubit at every node [68]. Modify the teleportation algorithm using quantum error correcting code and/or substituting quantum gates for gate combinations with smaller errors. [69] Improve error correction using quantum teleportation. [70]

Experiment & Real World

Remember

List the necessary optical components used in all-optical quantum teleportation. [71]

Understand

Describe the function of the optical components within the quantum teleportation algorithm. [71]

Apply

Sketch an experimental design of quantum teleportation incorporated into a quantum cryptography protocol to extend the range of this protocol. [72]

Analyse

Differentiate Quantum Teleportation from other quantum optical algorithms shown in, e.g. [73]. What are the differences and similarities in experimental setups?

Evaluate

Summarize the advantages and challenges of different areas of application (urban areas, ground-satellite, ...) to weigh these areas against each other in the context of quantum communication. [74–79]

Create

Design an experiment to teleport photon states to atomic particles. [80] Given an algorithm for teleportation of two-qubit states, extend the single qubit experimental design to teleport two-qubit states. [81]

Having decided on tasks that should be covered according to Bloom’s taxonomy, now is the time to answer *how* exactly this is to be done, a question that can be answered by the educator and given as requirement to the students or by the students themselves. For example, the task “Describe the process of quantum teleportation abstractly” can be answered descriptively (using words) symbolically (using mathematics), using graphical illustrations or any combination of these. Alternatively, students could be asked to “translate” between these representations, for example to explain a schematic of the teleportation protocol. This is discussed in the following section.

In addition, some of these tasks may seem to difficult to answer straight away, especially some of the tasks in the *Create* category. In these cases, proper support should be given to students (a practice commonly referred to as scaffolding [82] that we also briefly discuss in Sect. 7.3). With this support and given enough time, it is possible that students find satisfying solutions for these tasks.

5. Representations

An important part of the question of why and how to teach is why and how to represent the chosen concepts. By representation, here we mean anything external (as opposed to internal or mental), visual or auditory that is used to convey a concept [83]. Most of the time, multiple external representations (MERs) will be used in science education as, for example, text will be combined with equations or figures. In the QIST context, MERs are used in order to convey scientific ideas and concepts, like the Dirac bra-ket notation, vector and matrix notations, circuit diagrams or diagrams of experimental set ups. Understanding and working with these representations is part of the scientific workflow and necessary to be able to communicate concepts within the QIST community and can therefore be seen as an essential learning goal of QIST curricula.

The Designs, Functions, Tasks (DeFT) Framework [84] is a theoretical framework for the use of MERs that will be summarised here for our purpose. It consists of three layers to consider when combining representations: Designs, functions and tasks. While designs and tasks consider the how of representing information, the function layer constitutes the why. Therefore, in this work, we will firstly cover the function layer in order to line up the DeFT framework with the taxonomy presented here. The DeFT framework is visualized in 5.

5.1. Functions

The *Function* layer within this framework describes three main roles that MERs can play: Firstly, to *complement*, which means to provide various perspectives and information on the same concept so that learners can benefit from the specific advantages of each representation and to support different processes, i.e. strategies and individual differences of learners. For example, the Bloch sphere provides learners with an additional strategy of reasoning about the effect of quantum gates geometrically, as rotations on the sphere [87], complementing calculating in the computational basis typical Dirac notation. Another possible function MERs is to *constrain interpretation*

| | | | | |
|------------------|---|---------------------------------------|---|----------|
| Functions | complement by... | constrain interpretation by... | construct deeper understanding by... | |
| | Different Processes Different Information | Familiarity Inherent Properties | Abstraction Relation Extension | |
| Designs | Design Aspects of Offering Multiple External Representations | | | |
| | Number | Distribution | Form | Sequence |
| Tasks | Design MERs to reduce effects on extraneous cognitive load considering learner & representational characteristics Aptitude-Treatment-Interaction (e.g. Expertise-Reversal Effect) Representational Competence Modality Principle Redundancy Effect Element Interactivity Effect | | | |

Figure 5. The DeFT framework [85] adapted for the purpose of this work for the use of MERs. Firstly, the functions describe various reasons for *why* to use MERs. Then, the MERs should be designed (utilising the five design aspects) such that ECL is reduced, considering learner characteristics and the listed effects [86]. How this is best done in practice in various QIST contexts is mostly an open research question.

i.e. to specify ambiguous or complex information, e.g. coming from text, for example with symbols or mathematical formulas. This can be an inherent property of the representation, or can be by familiarity of the learner with the representation that is used. And lastly to *construct deeper understanding*, i.e. to support learners in achieving new insights on a concept which would be difficult with only one representation [84]. The Bloch sphere would be another example of this as it visualises two complex numbers, utilising the redundancy of the global phase, to enable new visual insights on single-qubit quantum systems, sometimes even leading to scientific advances, e.g. in the context of Rabi oscillations [88, 89]. In these various ways, different MERs should be chosen carefully and given as tools to support learners in achieving the levels in Bloom’s taxonomy that the educators want them to achieve. For example, in order to select the best hardware for a given quantum algorithm, one could analyse coupling maps with gate errors like the one in [90, Fig. 5], while, on the other hand, this representation is not suitable to describe the mathematics of any quantum algorithm.

5.2. Designs

The *Design* layer constitutes the *how* of the use of MERs. It describes the number of representations used, the way the information is distributed, the form of the MERs (i.e. pictures, text, animations, sound, equations or graphs), the sequence (i.e. the order in which the representations are shown), and the translation (i.e. indications of relations between the representations, for example visual cues using colouring or spatial proximity). MERs should be designed to reduce unnecessary cognitive tasks as described in the following.

5.3. Tasks

Last but not least, the *Task* layer describes the cognitive tasks that learners need to overcome in order to benefit from the MERs used. Cognitive tasks depend on characteristics of the representations (e.g. addressed sensory channel, modality, level of abstraction, type or dimensionality [85]) and on characteristics of the learners. For example, learners should gain representational competence, i.e. they need to understand the various Design aspects of the depicted MERs, in order to benefit from them [91]. Cognitive tasks are analysed within the Cognitive Load Theory (CLT) [86, 92]. The core idea is that “Learning, reflected by performance change, requires working-memory capacity” [92]. Psychology research has uncovered that the human brain works on a limited amount of such temporary working memory, a short term storage, that is used to store information acutely necessary to perform a task [93,94]. The working memory is often seen as consisting of two channels: a channel for visual and spatial information and a channel for audio information [95,96]. Further, it was shown that it is beneficial for learning to make use of both these memory channels by giving visual and audio information at the same time, for example in a typical presentation, as opposed to giving information in written words and pictures, i.e. using the same working memory channel for different information [97]. This is referred to as the modality principle.

Another known effect of CLT is the redundancy effect suggesting that redundant material can hinder learning rather than having positive effects [98]. The redundancy effect, e.g. suggests that experts, i.e. learners with high previous knowledge, could be hindered by the use of MERs when the different representations don’t provide them with additional information or processes. This is referred to as the expertise-reversal effect [99] as one form of the more general aptitude treatment interaction [100]. The split attention effect [101] suggests that MERs should be integrated to one single source of information rather than split either spatially or temporally. Another point to consider when using MERs is that learners need to translate between these representations. This translation will be harder the more the representations differ in format and operators like various levels of abstraction or supported strategies [84]. In QIST, a typical example is that of the use of vector notation and Dirac notation in course content design. If learners aren’t good at translating between these representations, even if they are somewhat familiar with both, the use of both at the same time may lead to increased cognitive load and may therefore worsen learning outcomes [85].

All of these effects have an influence on Extraneous cognitive load (ECL) which is the cognitive load imposed on the learner by the way the information is provided, i.e. the *Design*, and not the complexity of the information itself which is referred to as Intrinsic cognitive load (ICL) [102]. When ECL is reduced, learners can focus more on learning the content itself. Especially if the ICL of a given task is high, the negative effects of high ECL can become stronger (element-interactivity effect [103]). Even though ECL is usually seen as not desirable, some representations might be necessary to learn even though they are not the most efficient ECL-wise, because they are widely accepted by the academic community and broadly used for communicating scientific concepts. An example of this is the Dirac notation that should be taught in QIST courses regardless of the (possible) ECL that it brings along vs., e.g. the vector notation. In the following, the DeFT framework is applied to the QIST context in more detail.

6. Applying the DeFT-framework to QIST by the example of quantum teleportation

Quantum information science and technology is a field with a rich variety of forms of representations. To show this and how to apply the DeFT framework to this space, we again refer to quantum teleportation and show examples of descriptive (i.e. with text), symbolic (i.e. mathematical) and graphical (i.e. with pictures and diagrams) visual representations of the process within the three different approaches. This is chosen as a practical classification of visual external representations, rather than a comprehensive one. As pointed out in, e.g. [104], creating a comprehensive classification of representations is a non-trivial endeavour that has been approached in, e.g. [105], a philosophical approach to models in language and maths, and [106], where a general differentiation is made between verbal, mathematical and diagrammatic/pictorial models, similar to what we do in this paper. However, the work by Gilbert goes into much more detail.

Models and representations are often defined using the other [107,108] and further exploring the semantic differences is beyond the scope of this paper. Rather than doing so or giving a comprehensive characterisation of such representations, this application of the DeFT framework serves to show how possible representations can be categorised into the three targeted skill areas and point towards the thought processes that come with choice or creation of multiple suitable external representations using the DeFT framework. As is laid out in [109], learners need to understand all the representations that they work with, all the given support on the syntactic and/or semantic level and how these representations connect to each other in order to gain deep understanding of the content. Some typical representations used in QIST are also discussed in [110,111] in the context of problem solving in Quantum Computing.

6.1. Visual Representations of the Theory & Analytics of Quantum Teleportation

Descriptive We provide a text/descriptive representation of the *Theory & Analytics* of quantum teleportation in Appendix A. This is an abstract text describing the quantum teleportation protocol as a transfer of quantum information made possible due to the transitivity of entanglement. This description leaves some room for interpretation. For example, it describes a connection between entanglement and measurement that is not necessarily immediately visible. Therefore, it could benefit learners to constrain interpretation by providing symbolic and/or graphical representations to complement the description.

Symbolic There are different ways to represent quantum teleportation symbolically. It is often represented in Dirac ket notation [27]. Within this notation, one can use the computational basis $|0\rangle$ and $|1\rangle$. A more abstract formulation uses Bell states and Bell measurements, i.e. measurements in the Bell basis [112]. Both are also shown in Appendix A. There is a more general formulation with density matrices that can be suitable for a formal mathematical approach to the topic and can also be used for generalisations like the teleportation of mixed states and quantum gates [113]. Within the DeFT framework, the mathematical representation serves the function of *complementing*, i.e. offering multiple perspectives on the same concept and providing learners with more strategies to explain these concepts to themselves or others by calculation. In addition, the mathematical language can *constrain interpretation* by

being less ambiguous than the text. Lastly, the formulation using Bell states and Bell measurements could *construct deeper understanding* by abstraction which, e.g. could also be used in other contexts that benefit from a Bell state formulation like the investigation of Bell's inequality. On the other hand, learners could benefit from pre-existing familiarity with Bell states. Thus, it can be hypothesised that the text supported by mathematical representations helps learners understanding and problem solving in this context and that the abstraction in particular can help learners by enabling connections to other related contexts. Symbolic descriptions of quantum teleportation using the Dirac ket notation can be found in Appendix A.

Graphical The theory of quantum teleportation can be visualised in abstract schematics (Fig. 6) [114,115]. Abstract representations like this allow for re-design and generalisation of processes like quantum teleportation and could provide benefits even for experts in that regard by supporting higher levels in Bloom's taxonomy. A graphical representation providing an example for the creative abstraction needed to illustrate Bell-state measurements is provided by Fig. 4/5 in [57]. The typical ket notation can pose problems to students [4]. To aid in understanding, the explicit analytics can, e.g. be graphically visualised using circle notation [113] (see Fig. A2) which complements the mathematical notation by providing the information of complex numbers in a graphical form. This is done with circles representing the basis states, inner circles of which the radius represents the absolute value of the corresponding coefficient and a line which represents the phase. Another possibility is introducing dimensionality, assigning every qubit an axis in space and attaching the amplitudes visually [116].

The SpinDrops program [117] offers an alternative representation to the ones above, visualizing quantum states of up to three qubits in a different basis (akin to generalises Wigner functions [118]) than the usual computational basis, putting a larger focus on quantum correlations, i.e. entanglement. An alternative way of visualizing entanglement properties in the computational basis is shown in [119], utilising the circle notation combined with dimensionality.

6.2. Visual Representations of the Computation & Simulation of Quantum Teleportation

Descriptive We provide computer code of Quantum Teleportation using the python library Qiskit as a supplementary file. The code is annotated with description of what the functions do (complementing the Python code/providing support on the syntactic level [104]), which step of quantum teleportation is being executed (providing support on the semantic level [109]) and some other important notes like the impossibility to "read out" the quantum information of a qubit in the real world (providing deeper understanding).

Symbolic As the gate-based language is often used in contexts describing the mathematical procedure, the same can be used for the purpose of supporting the computer code. Various functions and variables used within the code can be seen as the symbolic representation of the computation/simulation of quantum teleportation. This is a concise representation, albeit not easily understandable for someone not as familiar with the Python functions and the Qiskit library. Therefore, comments within the computer code are usually used to support the more concise formulation,

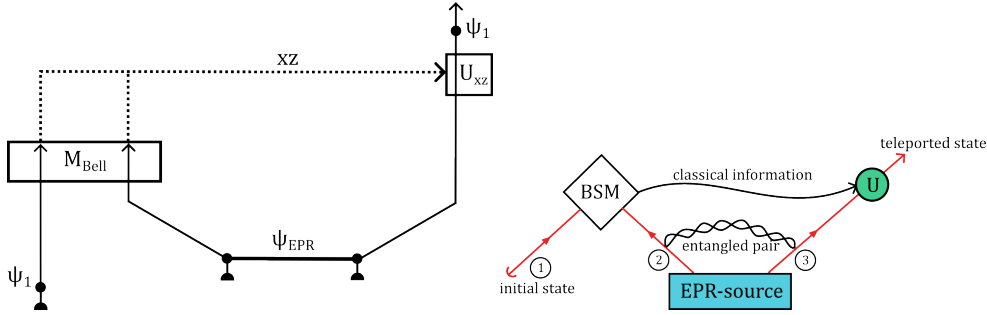

Figure 6. Schematic representations of Quantum Teleportation. These illustrations support a high level explanation of quantum teleportation and describe the flow of information, whether that information is quantum or classical as well as the role of the qubits in the protocol. To the left, the description leans more towards the mathematical perspective with states and classical information written as variables. The illustration to the right might be more suitable for learners that are more reluctant towards the mathematical symbols. Both combine multiple representations as both are arrow schematics supported by text or symbolic representations. The schematic to the left is adapted from [115] while the schematic to the right is adapted from [71].

improving readability. In addition, educators should make sure that learners have the necessary representational competence or know how to gain it using, e.g. the Qiskit documentation.

Graphical A common visual representation of the code of quantum teleportation is the corresponding quantum circuit showing a line for every qubit and “boxes” for different gates. This picture can be annotated with the creation of the Bell state, Bell state measurement and final unitary operations (a question of design within the DeFT framework). It is a more concise representation of the computer code and can therefore serve to constrain interpretation. In addition, the Bloch sphere can be used to describe the state $|\psi_1\rangle$ of the qubit to be teleported and compare it to the state $|\psi_3\rangle$ of the qubit that the state is teleported onto in order to visualise whether the algorithm has worked. It can be used to more easily check whether the code works or not, giving access to the otherwise hidden information to provide learners with another strategy of bug fixing (in practice, this information is, ofcourse, actually hidden and can not be accessed by any means in a single measurement), complementing the Dirac ket notation output. On the Bloch sphere, it can be seen for example whether the X and Z gates are assigned to the wrong classical registers which could be more difficult when comparing the Dirac ket state output. An example of a Jupyter notebook that incorporates the quantum circuit representation and the Bloch sphere is shown in Fig. B1. This could also be designed in the form of a computational essay, combining descriptive Educators need to make sure that learners have the necessary representational competence to use these tools.

6.3. Visual Representations of Experimental Implementation & Real World Application of Quantum Teleportation

Descriptive We provide a text representation of experiment and real world application of quantum teleportation in Appendix C. It is described how Bell states

between photons are created and how quantum teleportation can be verified in a proof-of-concept experiment by measuring correlations. This is a surface-level description with the aim of introducing quantum teleportation broadly while leaving open questions, for example how exactly spontaneous parametric down conversion [120] or Hong-Ou-Mandel interference [121] function. Explanations of these could be referenced, providing semantic support for the learners, but possibly increasing cognitive load significantly.

Symbolic The underlying theory can be represented with polarisation letters $|H\rangle$ and $|V\rangle$ or arrows $|\leftrightarrow\rangle$ and $|\updownarrow\rangle$ as is done in, e.g. [71]. This means that the representation is designed such that the Dirac ket notation is related to the representation of horizontal and vertical polarisation, providing a connection between the two different representations and possibly benefiting learners in understanding of how the qubit is implemented optically.

Graphical To describe real world quantum teleportation graphically, one can use a diagram including Alice and Bob to illustrate the process more abstractly, or show the more explicit optical experimental setup, both of which are commonly done, e.g. [27, 52]. The more abstract representation can complement the information provided in a corresponding text on the overall process while the graphic of the optical experimental setup (see Fig. C1) is more suitable to support a text describing the optical components and experimental setup and procedure.

7. Teaching Approach

Much of modern pedagogy is underpinned by Vygotsky’s constructivist theory of learning [122]. While in this article we will not dig into its development, which arose from the field of psychology, we will instead consider its implications for designing Quantum Physics curricula. Put most simply, the chief implication of constructivism for the educator is that learners construct their own understanding, knowledge, and skills, through interaction with their environment. Crucially, this includes the social surroundings [123] the core tenet of *social constructivism*.

We argue that teaching must take into account this nature of learning, and thus propose three key considerations for educators which we call “teaching approaches”. These influence the environment in which learning is constructed. These are the chosen level of inquiry, and the degree of cooperative learning, and the degree of scaffolding included. These are heavily intertwined as will become clear in this section.

Furthermore, all three pedagogical approaches are tunable factors which may be used by educators to adapt their teaching for QIST courses, which can be difficult to teach due to the diversity of student’s disciplinary backgrounds. This includes different levels of prior competences in Mathematics and various MERs, programming, and many other areas. We describe the three approaches below.

7.1. Level of Inquiry

Inquiry based education is a pedagogical approach in which learning is driven interactively [124]: by asking, and attempting to answer, questions. Inquiry is deeply embedded in science education because it is the nature of scientific study itself. There are many models of Inquiry-based learning (IBL) [125, 126], all sharing a cyclical and

phasic nature. For example, the 5E's cycle [125] labels phases with Engagement, Exploration, Explanation, Elaboration, and Evaluation. These can be mapped onto the phases of the scientific inquiry cycle, as shown in Fig 7. For this reason, IBL may be not only beneficial, but in fact necessary for students to gain the skills needed for scientific thought. It should be noted that there exist other models of scientific inquiry, such as *modelling-based inquiry* [127] which describes the process by which a complex phenomena can be understood through constructing a scientific model. Regardless of the specific inquiry model referred to, the core process of attempting to uncover an answer to a question, in a cyclical manner, is the same. This gives rise to a class of inquiry based learning approaches.

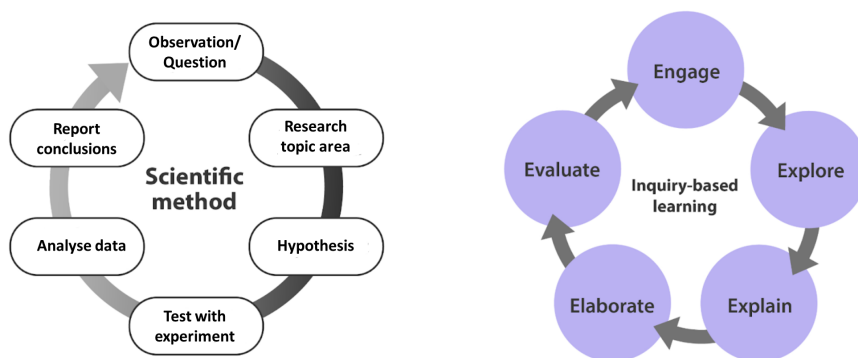

Figure 7. The scientific method (left) and the inquiry-based learning cycle (right). Both are cyclical processes, with a common structure (exploration, hypothesis-generation, testing/evaluation, and refinement.) As a result IBL is a powerful means of teaching QIST concepts whilst also engaging scientific thinking skills.

A core benefit of IBL is that, as engaging the very process of inquiry is the goal of any interaction, it respects diversity of student backgrounds and prior learning to a greater extent than more teacher-led teaching methods. We thus advocate that in the interdisciplinary QIST environment, some degree of IBL is essential. One may then ask what strategies can be taken to implement it in a teaching scenario. Pragmatism dictates a distinction between different “levels of inquiry”, the most frequently used model of which is Bell and Banchi’s (Confirmation, Structured, Guided, Open) [128].

Research suggests that conceptual understanding and subject knowledge are best fostered in more closed, structured inquiry based tasks [124], whilst scientific thinking and inquiry skills are best fostered with more open, unstructured tasks [126]. This may be explained by the greater cognitive load associated with the more open levels of inquiry [126,129], leaving less cognitive ability to develop conceptual understanding or commit ideas to long-term memory. For this reason, educators must choose carefully the level of inquiry in order to match their learning goals. In the field of QIST, there have been many recent examples of interactive tools which create possibilities for teaching approaches which span the four levels of inquiry [130]. For example, the visual and gamified simulation tool for Quantum Computing, Quantum Odyssey [131], is designed with a coherent structure of stand-alone scenarios addressing individual concepts, such as particular gate operations and communication protocols. These can be used to create more structured and confirmatory inquiry scenarios in which participants are both introduced to concepts and walked through them towards

attaining particular targeted knowledge and understanding around the concepts. On the other hand, the Quantum Composer tool is suited to truly open inquiry as it provides a blank slate interface in which staff and students may construct any one-dimensional quantum system and investigate its properties. In fact the tool has been used to support research in real problems in QIST [132, 133], which demonstrates how this form of inquiry can support scientific thinking as a learning outcome. Both of these tools provide a means of visual representation of concepts in QIST, but it should be noted that IBL models need not only use visualisation, but other forms of representation as described in Sect. 5.

7.2. Cooperative Learning

Cooperative learning is an educational practice where learners work in small groups in order to achieve learning goals under the instruction of an educator. There is a large amount of empirical evidence that cooperation is more effective than competition and individualistic efforts in enabling higher achievement and productivity and that therefore, cooperative learning improves learning outcomes [134–136]. This is only true, however, if cooperative learning is implemented correctly. In [135], five basic elements of effective cooperative learning are identified: (1) positive interdependence, i.e. everyone is needed and contributes to the group’s goal, (2) face-to-face promotive interaction, i.e. enabling constructive help and criticism within the group, (3) individual accountability and personal responsibility (e.g. to reduce diffusion of responsibility), (4) frequent use of interpersonal and small group social skills that should be promoted and rewarded and (5) frequent, regular group processing of current function, i.e. conjoint reflection on the group work. Findings also suggest that this depends on the level of inquiry, because more open ended questions are an effective tool to promote group discussion [137]. Therefore, the decision of how to incorporate cooperative learning into teaching is intertwined with the decision on the level of inquiry discussed previously.

There are findings that suggest that cooperative learning has advantages especially in an interdisciplinary context for tasks requiring input from multiple perspectives [138]. Therefore, cooperative or team-working skills should be fostered as they are especially needed not only in general, but also more specifically in the interdisciplinary context of QIST [2, 139, 140]. Findings suggest that diverse teams perform better than homogeneous teams under the right conditions [141, 142]. One such condition is psychological safety, reducing dysfunctional social barriers within the group. However, the exact impact of cognitive diversity on team performance, i.e. the differences of the way people think which is supposedly influenced by academic background, is still an open research question [143, 144]. Part of promoting functional team work is improving student’s understanding that their individual previous knowledge and skills and also that of others are relevant to the group and the common goals that the group wants to achieve [145, 146] and therefore a “diversity mindset” [147]. Diversity in academic background is one dimension of diversity such that one can argue that cooperative learning might be especially beneficial in the field of QIST with its diverse range of students’ academic backgrounds [4].

In practice, more open tasks that require multiple perspectives are often tasks reaching into higher levels of Bloom’s taxonomy. These tasks might benefit more from cooperative learning methods than tasks on the lower levels of Bloom’s taxonomy, because they allow cognitive diversity to be utilised more effectively. However, there

is no clear evidence of this and it is very dependent on the specific context [68]. Further, there exists evidence that teaching techniques like peer-to-peer instruction are beneficial also when trying to achieve lower levels of Bloom's taxonomy [68, 148] and when applying Bloom's taxonomy in general [149]. Nevertheless, making sure teams are diverse in academic background helps foster cooperative skills and improve group performance and learning when solving tasks with high interdependence [150]. Examining this effect is a possible direction of future empirical research in QIST education.

7.3. Scaffolding

Scaffolding is a well known teaching practice that can be defined as interactive, temporary support given to learners for tasks that they otherwise would not be able to complete [151, 152]. Here, the *contingency*, i.e. interactivity or responsiveness, is what differentiates it from non-scaffolding support [151]. Scaffolding techniques include promoting student interest, controlling frustration, providing feedback, helping with task/subtask prioritisation, offering models of expert processes and questioning/encouragement of reflection [151, 152]. Scaffolding can be seen as essential to IBL as a transfer of responsibility from educator to student is a key characteristic [151, 153]. Examples of how scaffolding can be applied in IBL in various STEM context include [154–158] and there exists extensive theory on how to do so [159–161]. Scaffolding can be offered one-to-one, by peers; it can be computer-based or AI generated [82, 162]. In many different contexts, it was shown that students perform better when scaffolding techniques were applied [163–166], also when applying cooperative learning techniques and in the context of quantum physics [167]. In addition, scaffolding techniques were shown to reduce anxiety and to have beneficial effects on motivation and reading comprehension [168].

Especially in the QIST context, we argue that various scaffolding techniques could be beneficial, because they consider individual academic backgrounds by definition. In addition, the concepts in QIST are quite abstract while the methods to deal with these concepts are often new to students, with possibly discouraging effect. Lastly, the field of QIST is new and therefore, knowledge acquisition often requires students to do their own research, reading scientific research articles that are not designed with them as a target audience in mind. Scaffolding could, e.g. be provided in the form of providing on demand suitable visualisations, encouraging peer-to-peer instruction and cooperativity (as covered in the previous section), providing help with representations and how to perform calculations, concept maps (e.g. connecting content with content from different targeted skill areas or different areas of the CF) aiding in research tasks by providing strategies and foundational material for understanding or close interactions with researchers (e.g. interviews).

7.4. Teaching Approach to Quantum Teleportation

In order to show how to put the framework to use, we present an example lesson on quantum teleportation using our framework. It is structured using the what - why - how approach and the corresponding steps in the framework.

What This example teaching unit could be part of the example curriculum presented in Fig. 3. The goal of this curriculum is to introduce learners to the basics of

quantum technologies, targeting primarily applications in the real world. Previous to the lesson, learners have been introduced to single-photon states and optical equipment like beam splitters and wave plates. They know how to use single photons to decrypt messages using the BB84 key distribution protocol. Then, they were introduced to the creation of entangled photon pairs via spontaneous parametric down conversion and a possible use of entanglement for efficient transport of classical information using superdense coding. During the latter, they learned the concepts of Bell states and Bell state measurements. Learners understand both the experimental implementation and description of these concepts using qubits and Dirac ket notation. During this example teaching unit, learners are introduced to quantum teleportation. To start the lesson, quantum teleportation can be introduced as a quantum protocol where – in contrast to superdense coding that is designed to send classical information – quantum information is transported over arbitrary distances.

Why After this teaching unit, learners should understand the theory behind quantum teleportation and its experimental realisation in quantum optics. They are able to apply quantum teleportation in quantum networks in practice and can discuss applications, e.g. in quantum key distribution, comparing it to classical networks and classical key distribution in these networks. Learners can also evaluate the challenges that quantum networks pose and discuss possible ways of coping with these challenges. In terms of Bloom's taxonomy, this means that the learners should reach the level of *Understanding* in the *Theory & Analytics* area of expertise and reach the *Evaluate* level in the *Experiment & Real world* area of expertise. This should enable them to understand practical problems within quantum communication and make justified decisions regarding various aspects of implementation of the quantum teleportation algorithm.

How There are infinitely many possible ways to teach quantum teleportation with these prerequisites and goals in mind. However, the process of first deciding on learning goals and then thinking about how to achieve them, also called a backwards design process, is still much more constrained than an upwards design process, where you start with textbook contents or activities and figure out the learning goals from there [17]. We will discuss only one possibility that incorporates the ideas laid out in this paper. For this, we propose five steps in which the following inquiry is to be investigated: What is quantum teleportation and what role could it play in quantum networks? What are the advantages and challenges of such quantum networks in comparison to classical networks? The teaching steps, the corresponding targeted skill areas, levels of Bloom's taxonomy and activities are summarised in Tab. 1 and described in more detail in the following, including proposals for possible scaffolding techniques.

- (i) Learners are introduced to the quantum teleportation protocol with a description and a schematic like the one in Fig. 6 via presentation. The general idea of a transfer of quantum information by transfer of entanglement is introduced. The presenter should keep principles and effects of cognitive load theory summarised in Sect. 5 in mind. The learners are asked why the protocol does not utilise faster than light communication and why it does not contradict the no-cloning theorem in group discussion. To end the presentation, possible applications in quantum computing (entanglement swapping) and quantum communication (quantum repeaters) are touched on. The educator-student interaction can be

Table 1. The five steps of our example teaching approach to quantum teleportation summarised: In various skill areas, learners achieve the corresponding levels in Bloom’s taxonomy (and the levels before) in the activities while supported by (optional) scaffolding techniques.

| Step | Skill Area | Up to this level in Bloom’s taxonomy | Activity |
|-------|--|--------------------------------------|---|
| (i) | Theory | Understand | Listening to short, conceptual presentation on quantum teleportation and discussion |
| (ii) | Analytics | Apply | Calculate necessary gates, choose proper representations |
| (iii) | Experiment | Apply | Plan an experiment and sketch an experimental setup |
| (iv) | Real World Application | Evaluate | Discuss real world application of quantum teleportation in quantum networks in a presentation |
| (v) | Computation & Simulation or Experiment | Remember | Carry out experiments or outlook on further use cases of quantum teleportation in quantum computing & programming the algorithm |

scaffolded by the educator, including giving appropriate hints and direction and giving substantive feedback [169].

- (ii) Learners are instructed to find out the explicit quantum gates that are needed for the quantum teleportation protocol (see Appendix A). For this, they know that a Bell pair $|EPR\rangle$ has to be created, and $|1\rangle$ is part of a Bell state measurement by Alice with one of the two qubits in the Bell pair. The aim is to find the right unitary operations that Bob has to apply to the third qubit. For this, e.g. circle notation or dimensional circle notation could be used or just the Dirac ket notation. The choice of representation can be left to the learners (which representation is the most helpful for this purpose is an open didactical research question). Examples of possible graphical representations are shown in Fig. A2. This task is probably not suitable for cooperative approaches, because it is very closed inquiry-wise. Here, further scaffolding can be deployed by providing suitable representations and possibly giving advice on how to utilise them.
- (iii) The third task is to plan an optical experiment to test whether quantum teleportation actually works in reality. For this, a schematic like in Fig. C1, a list of necessary optical components and a descriptive text should be created, as well as a methodology and a prediction for the experiment. The learners

are told to use the ideas of how to create an entangled photon pair and how to perform a Bell measurement. Therefore, they need to have or develop skills in the *Apply* level of Bloom's taxonomy regarding the previous topics of Bell state creation and measurements. They need to figure out how to make sure that it is clear that an entangled photon pair is created and how to prepare different initial states. The learners can try and predict Bob's measurement outcome probabilities depending on Alice's measurement outcomes. A problem in this experiment is that Bob has little time to adjust his experimental setup. To solve this, one could use ways of prolonging the path of Bob's photon and finding ways to apply conditional optical gates as in, e.g. [78] or, as in [71], only consider the Bell state ψ^- (coincidences of Alice's two detectors) and discard all other cases. In that case, Bob's measurement outcome is certain and he can check whether that is the case, referring to measurements at detector p . This task can be done in groups as its openness and the possibility to incorporate many technical details into the experiment can promote group discussion. Possible scaffolding techniques include promoting positive interdependence within these group discussions, providing a list of optical components that can be used with descriptions and providing feedback and hints in case of problems.

- (iv) Preparing and holding a presentation of the finished work as is usually done also in science and industry is a considerable final task. In this presentation that is again prepared and done in a group, learners discuss how to implement quantum teleportation into quantum networks, how these networks could look like and what these networks could be used for. They are tasked with discussing quantum key distribution over large distances where multiple network nodes are necessary. In addition, learners discuss the challenges of building such networks, especially decoherence, quantify these errors from the literature and explain what could be possible measures to cope with these challenges. They then evaluate the advantages and disadvantages in comparison to classical networks that are secured with classical key distribution. Groups should make a plan and split up, completing subtasks individually or in pairs and staying in contact. For example, one person could learn about classical networks and inform the others about how they function while another person learns about the details of spontaneous parametric down conversion, such that this information can be incorporated into the final presentation. This procedure makes sure that the group members are positively interdependent. Communication and social interaction should play a role in the working process and regular group meetings and discussions about the current status should be encouraged [135]. Learners are also tasked to find or create suitable representations for conveying their thoughts and ideas. Scaffolding techniques that can be used here are, again, promoting positive interdependence by providing instruction on effective group work, propose possible structures and inquiries to deal with in the presentation (e.g. how would quantum networks function, what would they look like abstractly, or what challenges do they face), recommend literature and provide reading aid and encouraging the use of suitable representations.
- (v) Outlook and possible next steps: If sufficient lab equipment is available, preparing this protocol and testing it in a real lab could be a possible next step. The amount of time this would take, however, can only be estimated by the educators. It could be a difficult and time consuming experiment to make work, depending on the

available equipment and preparation done. Alternatively, the learners could be tasked with programming quantum teleportation in a programming language of their/the educators choice. An example of such a program is shown in Fig. B1, using a Python notebook provided in the supplementary files. Different levels of fill-in code could be prepared for the students such that the different backgrounds in coding Python and Qiskit are considered (a form of scaffolding [152]). The code could be in the form of computational essays [170, 171] which can be combined with scaffolding [172]. Then, learners would have reached at least the level of *Understanding* in Bloom's taxonomy from each of the three different perspectives that QIST offers.

8. Outlook and Discussion

Given the substantial expansion in the number of courses and degree programs attempting to educate a workforce in the specialist field of QIST, it is crucial that careful attention is paid to how to do this most effectively. The development of the QCTF approach described in this article is intended as a guiding tool to be used for educators, in a pragmatic and digestible manner, to reduce an overwhelming library of educational research down to a single framework which may be used when designing educational material and classroom approaches.

The framework is structured in the manner of “what” - “why” - “how”, and thus breaks down curriculum construction into individual elements, which may be addressed with the support of didactical theory and tools. The first - which content to include - may be addressed using the Competence Framework, designed as a common language for content in QIST, and a major EU policy initiative which will become widespread in years to come. One must also select which skills are intended to be targeted in their education: be they theoretical, computational, or experimental. These skills are part of both the “what” and the “why”, as they are in themselves a learning outcome as skills to be developed through the education, but equally they are skills used akin to the knowledge used in addressing the areas of the CF representing field-specific content.

Educators must then select the learning-outcome specific thinking skills they wish to address. Foundational to this approach is Bloom's Taxonomy, which we argue in the field of QIST requires re-interpretation due to the strongly counter-intuitive nature of quantum concepts, but is still a useful guiding principle, albeit with less hierarchy in skill development. Given the content and targeted skills, educators designing material must next decide on the kind of representation they use to present concepts or explain to students such that they can represent concepts themselves. The DeFT framework is the tool intended to support this, and we emphasise that the framework is a support structure which may be used to several degrees of depth. In the most pragmatic and simple application, one may choose tasks based on the representational competences they wish learners to acquire, for example using Dirac's bra-ket notation when intending a mathematical approach, or using a simulation tool for a visualisation approach.

The final aspect of how the framework is applied is in choosing the teaching approach applied in the classroom. Here we consider the level of inquiry, ranging from more open and exploratory approaches, addressing more scientific thinking skills, to more guided ones appropriate for more directly targeting acquisition of field-specific knowledge. One must also consider how students interact with others in their

environment, and cooperation in learning can be a key factor in determining the exact activities used for teaching, beyond traditional “chalk and talk” approaches which lack the benefit of a social underpinning.

We emphasise that the framework is a guiding structure, intended to distil the results of educational research into a pragmatic approach for educators. Whilst most effectively applied in full, educators may also pick aspects from the framework to address individually - for example refining primarily their level of inquiry, or choosing topics using the CF. The framework is also open to refinement and iteration based on community feedback, as more and more educational material is developed in this field, and in particular with an eye to a didactically-sound approach. One particular refinement which may be beneficial in the future is the inclusion of proficiency levels in the “what” stage, while choosing content. Suggested proficiency levels are currently included in the Competence Framework [18], providing a rough equivalency between content difficulty and qualification level. However, as yet they are not based on educational literature and thus were not included in the framework in this iteration. The refinement of the proficiency levels, as the framework itself, we recommend for future work in the course of the flagship European Quantum Technology education projects, DigiQ [173] and QTIndu [174].

Acknowledgements

J.B. acknowledges support by the project QuanTUK at the RPTU in Kaiserslautern, supported by the Federal Ministry of Education and Research (FKZ13N15995).

Appendix A. Visual Representations of the Theory & Analytics of Quantum Teleportation

Here, we categorise typical representations in QIST in three categories, but point out that this is neither a comprehensive categorisation of representations [104] nor a comprehensive list of possible representations of quantum teleportation. These representations are suitable for introductory QIST courses targeting different skills in the three skill areas (Sect. 3).

Appendix A.1. Descriptive

Quantum teleportation can be seen as a transfer of quantum information made possible by a transfer of entanglement [27]. Qubit #1 is in an arbitrary state that is to be teleported to qubit #3. For this, qubit #3 is entangled with qubit #2 in a Bell state. Upon performing a Bell measurement on qubit #1 and qubit #2, one will get one of four possible results with equal probability. By doing so, quantum information of the qubit #1 is transferred to qubit #3. However, by definition of entanglement, the exact state of qubit #3 after measurement depends on the measurement result. This way, quantum information is transported over arbitrary distances, but can only be retrieved after the classical information has been transmitted. This information is not copied, because the quantum information contained in qubit #1 collapsed due to the measurement.

Appendix A.2. Symbolic

The quantum teleportation algorithm can be seen as a gate-based computing algorithm and is explained similarly to here in many textbooks. The system starts in the state $|\psi_i\rangle$ that consists of a Bell state $|\psi_{23}\rangle$ and the state $|\psi_1\rangle$ of qubit #1 to be teleported:

$$|\psi_i\rangle = |\psi_1\rangle \otimes |\psi_{23}\rangle \quad (\text{A.1})$$

$$= (\alpha |0\rangle + \beta |1\rangle) \otimes \left(\frac{1}{\sqrt{2}} |00\rangle + \frac{1}{\sqrt{2}} |11\rangle \right) \quad (\text{A.2})$$

$$= \frac{\alpha}{\sqrt{2}} |000\rangle + \frac{\beta}{\sqrt{2}} |001\rangle + \frac{\alpha}{\sqrt{2}} |011\rangle + \frac{\beta}{\sqrt{2}} |111\rangle. \quad (\text{A.3})$$

Alice entangles qubit #1 and #2 using a CNOT-gate and applies a Hadamard gate on qubit #1 to prepare a Bell state measurement of qubit #1 and #2 to obtain the final state $|\psi_f\rangle$ before measuring:

$$|\psi_f\rangle = H_1 CNOT_{12} |\psi_i\rangle \quad (\text{A.4})$$

$$= H_1 \left(\frac{\alpha}{\sqrt{2}} |000\rangle + \frac{\alpha}{\sqrt{2}} |011\rangle + \frac{\beta}{\sqrt{2}} |110\rangle + \frac{\beta}{\sqrt{2}} |101\rangle \right) \quad (\text{A.5})$$

$$= \frac{1}{2} (\alpha(|000\rangle + |100\rangle) + \alpha(|011\rangle + |111\rangle) + \beta(|010\rangle - |110\rangle) + \beta(|001\rangle - |101\rangle)). \quad (\text{A.6})$$

To show what happens upon measuring qubit #1 and #2, the state can be rewritten as

$$|\psi_f\rangle = |00\rangle \otimes (\alpha |0\rangle + \beta |1\rangle) \quad (\text{A.7})$$

$$+ |01\rangle \otimes (\beta |0\rangle + \alpha |1\rangle) \quad (\text{A.8})$$

$$+ |10\rangle \otimes (\alpha |0\rangle - \beta |1\rangle) \quad (\text{A.9})$$

$$+ |11\rangle \otimes (\beta |0\rangle - \alpha |1\rangle). \quad (\text{A.10})$$

Upon measuring, Bobs qubit #3 will be in one of these four possible states and Bob needs to apply gates depending on the measurement result in order to obtain the initial state of qubit #1:

$$00 : \alpha |0\rangle + \beta |1\rangle \quad (\text{A.11})$$

$$01 : \beta |0\rangle + \alpha |1\rangle \xrightarrow{X} \alpha |0\rangle + \beta |1\rangle \quad (\text{A.12})$$

$$10 : \alpha |0\rangle - \beta |1\rangle \xrightarrow{Z} \alpha |0\rangle + \beta |1\rangle \quad (\text{A.13})$$

$$11 : \beta |0\rangle - \alpha |1\rangle \xrightarrow{XZ} \alpha |0\rangle + \beta |1\rangle. \quad (\text{A.14})$$

One can alternatively represent the initial state of quantum teleportation using the Bell basis:

$$|\psi\rangle_1 |\phi^+\rangle_{23} = \frac{1}{\sqrt{2}}(\alpha |000\rangle + \alpha |011\rangle + \beta |100\rangle + \beta |111\rangle) \quad (\text{A.15})$$

$$= [|\phi^+\rangle_{12} (\alpha |0\rangle + \beta |1\rangle)_3] \quad (\text{A.16})$$

$$= |\phi^-\rangle_{12} (\alpha |0\rangle - \beta |1\rangle)_3 \quad (\text{A.17})$$

$$= |\psi^+\rangle_{12} (\beta |0\rangle + \alpha |1\rangle)_3 \quad (\text{A.18})$$

$$= |\psi^-\rangle_{12} (\beta |0\rangle - \alpha |1\rangle)_3 \quad (\text{A.19})$$

Then, a Bell measurement is performed by Alice to achieve the desired result. This representation supports the more abstract explanation of quantum teleportation using the Bell basis [57, 114] (see also Fig. A1). Another alternative is the use of the vector and matrix representation [27], but, considering these three-qubit vectors would have eight entries, this seems like an impractical solution.

Appendix A.3. Graphical

Here we provide graphical representations of the application of Alice's gates in the quantum teleportation algorithm. In the more abstract Fig. A1, Alice's shift to the Bell basis ("looking" at the system differently) transforms the system such that Bob can receive the appropriate information, while the representations in Fig. A2 are more explicit and only represent the step in the computational basis.

Appendix B. Visual Representations of the Computation & Simulation of Quantum Teleportation

In this section, we provide examples of descriptive, symbolic and graphical representations of the quantum teleportation algorithm or parts of the algorithm that can be used to target the *Computation & Simulation* area of expertise.

Appendix B.1. Descriptive

Considering the *Computation & Simulation* area of expertise, one can describe the algorithm in terms of the quantum gates that are used, which is also done, e.g. in [27]. The first and second qubit are initialised in the state $|0\rangle$, while the third qubit is in an arbitrary state to be teleported. Then, the first and second qubit are entangled via a Hadamard gate on the first qubit and a CNOT gate with the first as control and the second as target. The same is done to entangle the second with the third qubit. Then, the first and second qubit are measured to a classical register. In order for the first qubit to be in the original state of the third qubit, quantum gates have to be applied depending on the measurement result, using classical if-operations. If the measurement result of the second qubit is 1, a Z -gate has to be applied. If the measurement result of the first qubit is 1, an X -gate has to be applied. The order matters only by a global phase.

Appendix B.2. Symbolic

As symbolic representation, the same as in Appendix A can be chosen.

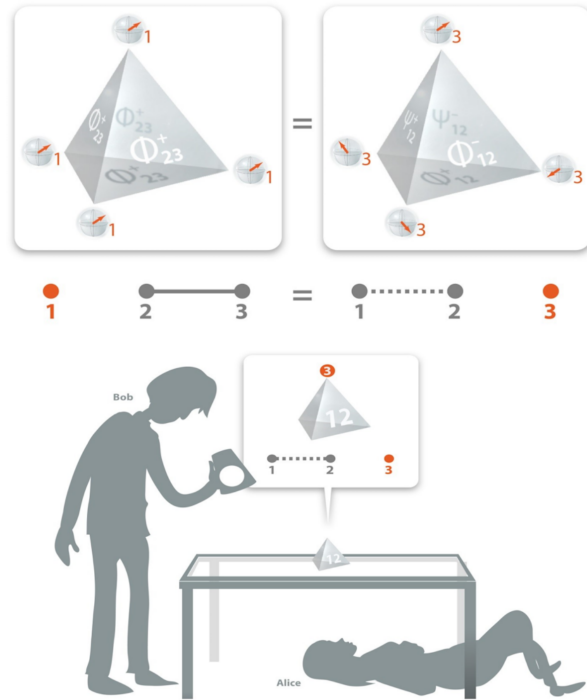

Figure A1. Creative abstraction of the mathematical relations relevant for quantum teleportation: There are two equivalent manners to represent the three-photon state $|\psi_1\rangle|\phi_{23}^+\rangle$ (see Appendix B). In this visualisation of this abstract relation, Bob throws a pyramodial “dice” with four possible outcomes, corresponding to four possible Bell-states at Alice site, at the corresponding four possible teleported photon states at his side [57]. Once Alice informs Bob about her result, he knows which local unitary transformation he has to perform at his photon to teleport Alice original state $|\psi_1\rangle$ to his side. This approach is more abstract than the one in Fig. 8, focussing on the basis transformation from computational basis to the Bell basis that the explicit circle and dimensional circle notations don’t represent.

Appendix B.3. Graphical

Computer code is also a form of using Multiple External Representations. Python functions can be called symbolic, while comments and pictures are supportive representations useful for understanding the code and bug fixing. Some excerpts from a Python notebook for quantum teleportation are depicted in Fig. B1.

Appendix C. Visual Representations of Experimental Implementation & Real World Application of Quantum Teleportation

In this section, we provide examples of descriptive, symbolic and graphical representations of the quantum teleportation algorithm or parts of the algorithm that can be used to target the *Experiment & Real World* area of expertise.

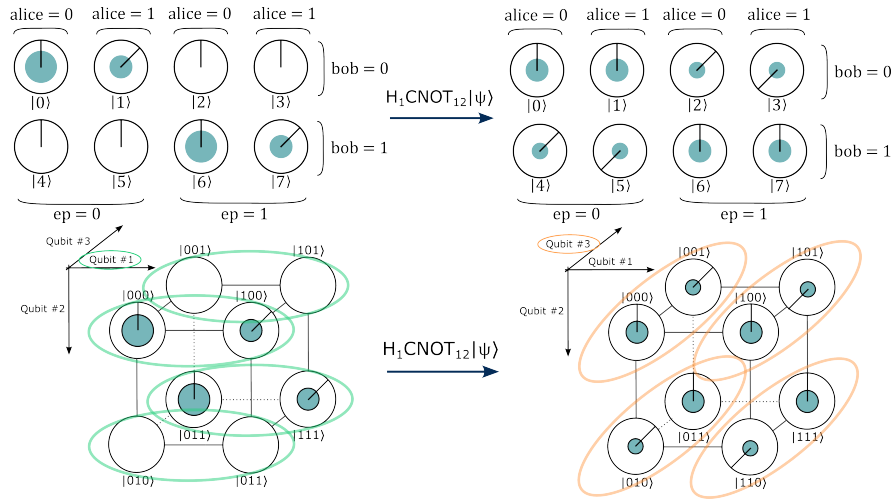

Figure A2. Graphical representations of an explicit mathematical example of the application of Alice’s gates within the quantum teleportation algorithms (see Appendix B), adapted from [113, 116, 119]. This step is laid out more explicitly in all of these works. The illustrations could help learners gain understanding of the theory behind the protocol, provided they have the necessary representational competence. This can be done by visually laying focus on the information transfer between qubit #1 and that of qubit #3 or, in the case of the representation on the bottom, the information transfer from one axis to the other represented by the green and yellow ellipses [119].

Appendix C.1. Descriptive

One possible experimental approach to quantum teleportation is described in [71] in the context of quantum optics, i.e. photons. Initiated by a light pulse in the ultraviolet (UV) range, a pair of entangled photons is created via a process called spontaneous parametric down conversion (SPDC) [120] in a non-linear crystal in such a way that the polarisations are anti-correlated. When the pair now passes through a polarising beam splitter (PBS), they are spatially separated. One can be sent to Bob (photon 3), the other to Alice (photon 2). The initial UV pulse is sent back through the crystal to create a second pair of entangled photons, one of which will be the photon 1 to be teleported for the sake of the experiment, the other of which will serve as an idler photon, indicating that the others are on the way. Alice superposes photon 1 and photon 2 on another beam splitter. If they constructively interfere at that beam splitter, the result will be that each of two detectors will trigger, showing that they were in an anti-correlated state (due to a phenomenon called Hong-Ou-Mandel interference [121]). As Photon 1 and 2 were anti-correlated as well as photon 2 and 3, we know (apart from a phase) that photon 3 is now in the original state of photon 1. This phase is detected by Bob using another PBS.

Appendix C.2. Symbolic

The same symbolic representation as in Appendix A can be chosen, but $|0\rangle$ and $|1\rangle$ can be represented as $|\leftrightarrow\rangle$, $|\updownarrow\rangle$ to represent the experimental implementation of qubits as done in, e.g. [71].

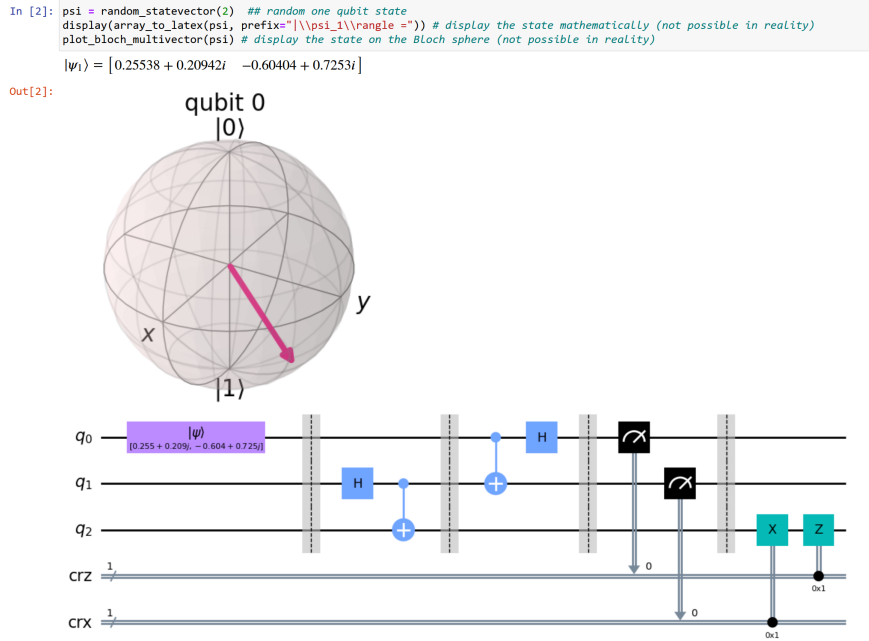

```
In [4]: teleportation_circuit.save_statevector() # save final statevector
sim = Aer.get_backend('aer_simulator') # get simulator of a quantum computer from the qiskit backend
out_vector = sim.run(teleportation_circuit).result().get_statevector() # run the simulation
plot_bloch_multivector(out_vector) # plot final state of the system (only works for disentangled systems)
```

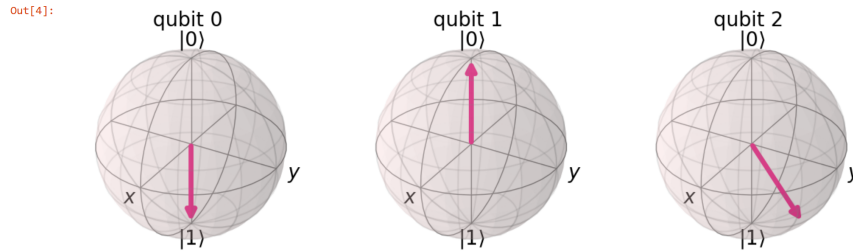

Figure B1. Excerpts from a Python notebook for quantum teleportation in Qiskit. It utilises the circuit representation and the Bloch sphere for visualisation of the computer code and the underlying processes. The first Bloch sphere can be compared to the Bloch sphere of qubit 2 below the code to show that the computer code has functioned properly. Note that this depiction of a quantum state is not possible in reality. Many measurements have to show that a quantum teleportation has worked successfully. Comments are used to make the code more readable. The whole notebook can be found in the supplementary files. Comments in Python code as shown in Fig. 10 are also a form of a descriptive representation of the underlying processes that supports the rather symbolic representation of Python functions.

Appendix C.3. Graphical

Fig. C1 shows the explicit experimental setup of quantum teleportation and refers to some process and components that can be used for optical quantum teleportation, namely a nonlinear crystal for SPDC, mirrors, polarisers, (polarising) beam splitters and detectors.

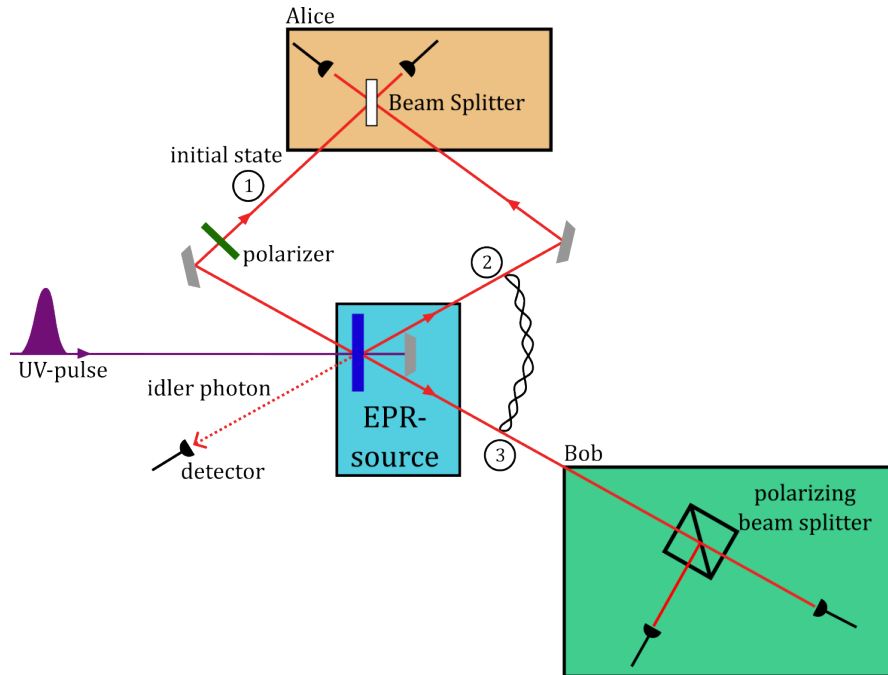

Figure C1. Illustration of experimental quantum teleportation as introduced in [71]. An ultraviolet pulse is shot at a nonlinear crystal (blue) and back through the crystal to create four photons labelled 1, 2 and 3 and an idler photon that is used to indicate that the photons were created. Photon 2 and 3 are entangled. Photon 1's state is manipulated using a polarisor and Alice interferes photon 1 and 2 at a beam splitter. Upon detection of photon 1 and 2 at different detectors, Photon 3 has, apart from a phase, the same polarisation as photon 1 initially had which Bob can confirm using detectors and a polarising beam splitter.

References

- [1] Abraham Asfaw, Alexandre Blais, Kenneth R. Brown, Jonathan Candelaria, Christopher Cantwell, Lincoln D. Carr, Joshua Combes, Dripto M. Debroy, John M. Donohue, Sophia E. Economou, Emily Edwards, Michael F. J. Fox, Steven M. Girvin, Alan Ho, Hilary M. Hurst, Zubin Jacob, Blake R. Johnson, Ezekiel Johnston-Halperin, Robert Joynt, Eliot Kapit, Judith Klein-Seetharaman, Martin Laforest, H. J. Lewandowski, Theresa W. Lynn, Corey Rae H. McRae, Celia Merzbacher, Spyridon Michalakis, Prineha Narang, William D. Oliver, Jens Palsberg, David P. Pappas, Michael G. Raymer, David J. Reilly, Mark Saffman, Thomas A. Searles, Jeffrey H. Shapiro, and Chandralekha Singh. Building a quantum engineering undergraduate program. *IEEE Transactions on Education*, 65(2):220–242, may 2022.
- [2] Clarice D Aiello, D D Awschalom, Hannes Bernien, Tina Brower, Kenneth R Brown, Todd A Brun, Justin R Caram, Eric Chitambar, Rosa Di Felice, Karina Montilla Edmonds, Michael F J Fox, Stephan Haas, Alexander W Holleitner, Eric R Hudson, Jeffrey H Hunt, Robert Joynt, Scott Koziol, M Larsen, H J Lewandowski, Doug T McClure, Jen Palsberg, Gina Passante, Kristen L Pudenz, Christopher J K Richardson, Jessica L Rosenberg, R S Ross, Mark Saffman, M Singh, David W Steuerman, Chad Stark, Jos Thijssen, A Nick Vamivakas,

- James D Whitfield, and Benjamin M Zwickl. Achieving a quantum smart workforce. *Quantum Sci. Technol.*, 6(3):030501, July 2021.
- [3] Maninder Kaur and Araceli Venegas-Gomez. Defining the quantum workforce landscape: a review of global quantum education initiatives. *Opt. Eng.*, 61(08), May 2022.
- [4] Josephine C. Meyer, Gina Passante, Steven J. Pollock, and Bethany R. Wilcox. Today's interdisciplinary quantum information classroom: Themes from a survey of quantum information science instructors. *Phys. Rev. Phys. Educ. Res.*, 18:010150, Jun 2022.
- [5] Simon Goorney, Caterina Foti, Lorenzo Santi, Jacob Sherson, Jorge Yago Malo, and Maria Luisa Chiofalo. Culturo-scientific storytelling. *Educ. Sci. (Basel)*, 12(7):474, July 2022.
- [6] Erica Andreotti, Lise Verbraeken, Renaat Frans, Maria Bondani, Bart Folkers, Leon Jurčić, Massimiliano Malgieri, Filippo Pallotta, and Henk J. Pol. Quantum technology pck for teachers. In *GIREP 2022*, pages 26–27, July 2022. GIREP Conference 2022 : Effective learning in physics from contemporary physics to remote settings ; Conference date: 04-07-2022 Through 08-07-2022.
- [7] Mo Hasanovic, Chrys A. Panayiotou, Donn M. Silberman, Paul Stimers, and Celia I. Merzbacher. Quantum technician skills and competencies for the emerging Quantum 2.0 industry. *Optical Engineering*, 61(8):081803, 2022.
- [8] Ciaran Hughes, Doug Finke, Dan-Adrian German, Celia Merzbacher, Patrick M. Vora, and H. J. Lewandowski. Assessing the needs of the quantum industry. *IEEE Transactions on Education*, 65(4):592–601, 2022.
- [9] F Gerke, R Müller, P Bitzenbauer, M Ubben, and K-A Weber. Requirements for future quantum workforce – a delphi study. *Journal of Physics: Conference Series*, 2297(1):012017, jun 2022.
- [10] Franziska Greinert, Rainer Müller, Philipp Bitzenbauer, Malte S. Ubben, and Kim-Alessandro Weber. Future quantum workforce: Competences, requirements, and forecasts. *Phys. Rev. Phys. Educ. Res.*, 19:010137, Jun 2023.
- [11] Charoula Angeli and Nicos Valanides. Technology mapping: An approach for developing technological pedagogical content knowledge. *J. Educ. Comput. Res.*, 48(2):199–221, March 2013.
- [12] J A Baxter and N G Lederman. *Assessment and measurement of pedagogical content knowledge. In Examining pedagogical content knowledge: The construct and its implications for science education.* Springer, Dordrecht; Netherlands, 1999.
- [13] Manuel Meyer, Katharina Isleif, Friederike Januschek, Axel Lindner, Gulden Othman, José Alejandro Rubiera Gimeno, Christina Schwemmbauer, Matthias Schott, and Rikhav Shah. A first application of machine and deep learning for background rejection in the alps ii tes detector. *Annalen der Physik*, May 2023.
- [14] Sara Satanassi, Elisa Ercolessi, and Olivia Levrini. Designing and implementing materials on quantum computing for secondary school students: The case of teleportation. *Phys. Rev. Phys. Educ. Res.*, 18:010122, Mar 2022.
- [15] Franziska Greinert and Rainer Müller. European competence framework for quantum technologies, 2023.
- [16] Xiao-Min Hu, Yu Guo, Bi-Heng Liu, Chuan-Feng Li, and Guang-Can Guo. Progress in quantum teleportation. *Nat. Rev. Phys.*, 5(6):339–353, May 2023.
- [17] Grant P Wiggins and Jay McTighe. *Understanding by Design.* Association for Supervision & Curriculum Development, Alexandria, VA, 2 edition, 2005.
- [18] Franziska Greinert, Rainer Müller, Simon Goorney, Jacob Sherson, and Malte S Ubben. Towards a quantum ready workforce: the updated european competence framework for quantum technologies. *Front. Quantum Sci. Technol.*, 2, July 2023.
- [19] Louis Deslauriers, Ellen Schelew, and Carl Wieman. Improved learning in a large-enrollment physics class. *Science*, 332(6031):862–864, May 2011.
- [20] Scott Freeman, Sarah L Eddy, Miles McDonough, Michelle K Smith, Nnadozie Okoroafor, Hannah Jordt, and Mary Pat Wenderoth. Active learning increases student performance in science, engineering, and mathematics. *Proc. Natl. Acad. Sci. U. S. A.*, 111(23):8410–8415, June 2014.
- [21] Thomas Lubinski, Sonika Johri, Paul Varosy, Jeremiah Coleman, Luning Zhao, Jason Necaise, Charles H Baldwin, Karl Mayer, and Timothy Proctor. Application-oriented performance benchmarks for quantum computing. *IEEE Trans. Quantum Eng.*, 4:1–32, 2023.
- [22] M Salm, J Barzen, F Breitenbucher, B Weder, and K Wild. The NISQ analyzer: Automating the selection of QuantumComputers for quantum algorithms. In *Proceedings of the 14th Symposium and Summer School onService-Oriented Computing*, pages 66–85. Springer

- International Publishing, 2020.
- [23] Dolev Bluvstein, Harry Levine, Giulia Semeghini, Tout T Wang, Sepehr Ebadi, Marcin Kalinowski, Alexander Keesling, Nishad Maskara, Hannes Pichler, Markus Greiner, Vladan Vuletić, and Mikhail D Lukin. A quantum processor based on coherent transport of entangled atom arrays. *Nature*, 604(7906):451–456, April 2022.
- [24] Juncheng Harry Zhang and Srinivasan S Iyengar. Graph-QC, a graph-based quantum/classical algorithm for efficient electronic structure on hybrid quantum/classical hardware systems: Improved quantum circuit depth performance. *J. Chem. Theory Comput.*, 18(5):2885–2899, May 2022.
- [25] John Watrous. *The theory of quantum information*. Cambridge University Press, Cambridge, England, April 2018.
- [26] I Bengtsson and K Życzkowski. *Geometry of Quantum States: An Introduction to Quantum Entanglement*. Cambridge University Press, Cambridge, 2006.
- [27] M A Nielsen and I L Chuang. *Quantum Computation and Quantum Information: 10th Anniversary Edition*. Cambridge University Press, 2011.
- [28] Qiskit: An open source framework for quantum computing. <https://qiskit.org/>. Accessed: 2023-8-8.
- [29] Ville Bergholm, Josh Izaac, Maria Schuld, Christian Gogolin, Shah Nawaz Ahmed, Vishnu Ajith, M. Sohaib Alam, Guillermo Alonso-Linaje, B. Akash Narayanan, Ali Asadi, Juan Miguel Arrazola, Utkarsh Azad, Sam Banning, Carsten Blank, Thomas R Bromley, Benjamin A. Cordier, Jack Ceroni, Alain Delgado, Olivia Di Matteo, Amintor Dusko, Tanya Garg, Diego Guala, Anthony Hayes, Ryan Hill, Aroosa Ijaz, Theodor Isaacsson, David Ittah, Soran Jahangiri, Prateek Jain, Edward Jiang, Ankit Khandelwal, Korbinian Kottmann, Robert A. Lang, Christina Lee, Thomas Loke, Angus Lowe, Keri McKiernan, Johannes Jakob Meyer, J. A. Montañez-Barrera, Romain Moyard, Zeyue Niu, Lee James O’Riordan, Steven Oud, Ashish Panigrahi, Chae-Yeun Park, Daniel Polatajko, Nicolás Quesada, Chase Roberts, Nahum Sá, Isidor Schoch, Borun Shi, Shuli Shu, Sukin Sim, Arshpreet Singh, Ingrid Strandberg, Jay Soni, Antal Száva, Slimane Thabet, Rodrigo A. Vargas-Hernández, Trevor Vincent, Nicola Vitucci, Maurice Weber, David Wierichs, Roeland Wiersema, Moritz Willmann, Vincent Wong, Shaoming Zhang, and Nathan Killoran. PennyLane: Automatic differentiation of hybrid quantum-classical computations, 2022.
- [30] Gian Giacomo Guerreschi, Justin Hogaboam, Fabio Baruffa, and Nicolas P D Sawaya. Intel quantum simulator: a cloud-ready high-performance simulator of quantum circuits. *Quantum Sci. Technol.*, 5(3):034007, May 2020.
- [31] Andrew Cross, Ali Javadi-Abhari, Thomas Alexander, Niel De Beaudrap, Lev S Bishop, Steven Heidel, Colm A Ryan, Prasahnt Sivarajah, John Smolin, Jay M Gambetta, and Blake R Johnson. OpenQASM 3: A broader and deeper quantum assembly language. *ACM Transactions on Quantum Computing*, 3(3):1–50, September 2017.
- [32] Johnny Hooyberghs. Q# language overview and the quantum simulator. In *Introducing Microsoft Quantum Computing for Developers*, pages 121–167. Apress, Berkeley, CA, 2022.
- [33] The first intuitive programming language for quantum computers. www.sciencedaily.com/releases/2020/06/200615115820.htm (accessed 2023-08-17), 2020.
- [34] Bettina Heim, Mathias Soeken, Sarah Marshall, Chris Granade, Martin Roetteler, Alan Geller, Matthias Troyer, and Krysta Svore. Quantum programming languages. *Nat. Rev. Phys.*, 2(12):709–722, November 2020.
- [35] Yiqing Zhou, E. Miles Stoudenmire, and Xavier Waintal. What limits the simulation of quantum computers? *Phys. Rev. X*, 10:041038, Nov 2020.
- [36] Xiaosi Xu, Simon Benjamin, Jinzhao Sun, Xiao Yuan, and Pan Zhang. A herculean task: Classical simulation of quantum computers, 2023.
- [37] D. Willsch, M. Nocon, F. Jin, H. De Raedt, and K. Michielsen. Gate-error analysis in simulations of quantum computers with transmon qubits. *Phys. Rev. A*, 96:062302, Dec 2017.
- [38] Robert Raussendorf. Key ideas in quantum error correction. *Philos. Trans. A Math. Phys. Eng. Sci.*, 370(1975):4541–4565, September 2012.
- [39] Thomas G Wong. *Introduction to Classical and Quantum Computing*. Rooted Grove, Omaha, Nebraska, 2022.
- [40] Venkateswaran Kasirajan. *Fundamentals of Quantum Computing*. Springer, 2021.
- [41] Victoria Borish and H. J. Lewandowski. Implementation and goals of quantum optics experiments in undergraduate instructional labs. *Phys. Rev. Phys. Educ. Res.*, 19:010117, Mar 2023.
- [42] Manijeh Razeghi. *Technology of Quantum Devices*. Springer, 2010.

- [43] Olivier Ezratty. Understanding quantum technologies 2022, 2022.
- [44] Victoria Borish and H. J. Lewandowski. Seeing quantum effects in experiments. *Phys. Rev. Phys. Educ. Res.*, 19:020144, Oct 2023.
- [45] Rhett Mcdaniel. Bloom’s taxonomy. <https://cft.vanderbilt.edu/guides-sub-pages/blooms-taxonomy/>, June 2010. Accessed: 2023-8-17.
- [46] Melanie M Cooper. Evidence-based reform of teaching and learning. *Anal. Bioanal. Chem.*, 406(1):1–4, January 2014.
- [47] Mary Forehand. *Bloom’s Taxonomy: Original and Revised*. In M. Orey (Ed.), *Emerging Perspectives on Learning, Teaching, and Technology (E-Book)*, chapter 3. textbookequity.org, 2005. accessed 2023-8-17.
- [48] Nancy E Adams. Bloom’s taxonomy of cognitive learning objectives. *J. Med. Libr. Assoc.*, 103(3):152–153, July 2015.
- [49] Susana Masapanta-Carrión and J Ángel Velázquez-Iturbide. A systematic review of the use of bloom’s taxonomy in computer science education. In *Proceedings of the 49th ACM Technical Symposium on Computer Science Education*, New York, NY, USA, February 2018. ACM.
- [50] N Bhaw and J Kriek. A review of the final and supplementary grade 12 physics examinations from 2014 to 2018 based on a modified bloom’s taxonomy. *J. Phys. Conf. Ser.*, 1512(1):012008, April 2020.
- [51] J. M. Buick. Physics assessment and the development of a taxonomy. *European Journal of Physics Education*, 2(1):5–10, 2011.
- [52] T Bouchée, L de Putter Smits, M Thurlings, and B Pepin. Towards a better understanding of conceptual difficulties in introductory quantum physics courses. *Stud. Sci. Educ.*, 58(2):183–202, July 2022.
- [53] Jessica Shabatara. Bloom’s taxonomy verb chart, Sep 2014.
- [54] Philip M. Newton, Ana Da Silva, and Lee George Peters. A pragmatic master list of action verbs for bloom’s taxonomy. *Frontiers in Education*, 5, July 2020.
- [55] Syaamantak Das, Shyamal Kumar Das Mandal, and Anupam Basu. Classification of action verbs of bloom’s taxonomy cognitive domain: An empirical study. *Journal of Education*, 202(4):554–566, 2022.
- [56] Philip Ball. Quantum teleportation is even weirder than you think. *Nature*, July 2017.
- [57] Wolfgang Dür, Raphael Lamprecht, and Stefan Heusler. Towards a quantum internet. *Eur. J. Phys.*, 38(4):043001, July 2017.
- [58] Zhao-Di Liu, Olli Siltanen, Tom Kuusela, Rui-Heng Miao, Chen-Xi Ning, Chuan-Feng Li, Guang-Can Guo, and Jyrki Piilo. Efficient quantum teleportation under noise with hybrid entanglement and reverse decoherence, 2022.
- [59] Jeongho Bang, Junghee Ryu, and Dagomir Kaszlikowski. Fidelity deviation in quantum teleportation. *Journal of Physics A: Mathematical and Theoretical*, 51(13):135302, feb 2018.
- [60] Matthäus Halder, Alexios Beveratos, Nicolas Gisin, Valerio Scarani, Christoph Simon, and Hugo Zbinden. Entangling independent photons by time measurement. *Nature Physics*, 3(10):692–695, aug 2007.
- [61] Tao Liu. The applications and challenges of quantum teleportation. *J. Phys. Conf. Ser.*, 1634(1):012089, September 2020.
- [62] Gustavo Rigolin. Quantum teleportation of an arbitrary two-qubit state and its relation to multipartite entanglement. *Phys. Rev. A*, 71(3), March 2005.
- [63] Ritik Ritik, Charchit Sethi, Nitish Gupta, Bikash Behera, and Prasanta Panigrahi. Comparison of advantages in quantum teleportation using cluster state and coined quantum walks, 02 2020.
- [64] C. Seida, A. El Allati, N. Metwally, and Y. Hassouni. Multi-party bidirectional teleportation. *Optik*, 247:167784, 2021.
- [65] Qiskit textbook: Quantum teleportation. <https://learn.qiskit.org/course/ch-algorithms/quantum-teleportation>. Accessed: 2023-8-17.
- [66] Matthew Silverman. Quantum teleportation. https://pennylane.ai/qml/demos/tutorial_teleportation/ (accessed 11-16-2023), Oct 2023.
- [67] Scott Johnstun and Jean-François Van Huele. Understanding and compensating for noise on IBM quantum computers. *Am. J. Phys.*, 89(10):935–942, October 2021.
- [68] Ni-Ni Huang, Wei-Hao Huang, and Che-Ming Li. Identification of networking quantum teleportation on 14-qubit ibm universal quantum computer. *Scientific Reports*, 10(1):3093, Feb 2020.
- [69] W. Carlisle Thacker and Aakash Gupta. Quantum controlled error-correction teleportation (qcect) scheme for satellite control and communication. *arXiv: Quantum Physics*, 2015.
- [70] K. M. Anandu, Muhammad Shaharukh, Bikash K. Behera, and Prasanta K. Panigrahi.

- Demonstration of teleportation-based error correction in the ibm quantum computer, 2019.
- [71] Dik Bouwmeester, Jian-Wei Pan, Klaus Mattle, Manfred Eibl, Harald Weinfurter, and Anton Zeilinger. Experimental quantum teleportation. *Nature*, 390(6660):575–579, December 1997.
- [72] Juan Yin, Yu-Huai Li, Sheng-Kai Liao, Meng Yang, Yuan Cao, Liang Zhang, Ji-Gang Ren, Wen-Qi Cai, Wei-Yue Liu, Shuang-Lin Li, Rong Shu, Yong-Mei Huang, Lei Deng, Li Li, Qiang Zhang, Nai-Le Liu, Yu-Ao Chen, Chao-Yang Lu, Xiang-Bin Wang, Feihu Xu, Jian-Yu Wang, Cheng-Zhi Peng, Artur K Ekert, and Jian-Wei Pan. Entanglement-based secure quantum cryptography over 1,120 kilometres. *Nature*, 582(7813):501–505, June 2020.
- [73] M. Suhail Zubairy, Marlan O. Scully, and Goong Chen. Quantum optical implementation of quantum computing algorithms. In *Optical Fiber Communication Conference and International Conference on Quantum Information*, page PB14. Optica Publishing Group, 2001.
- [74] Ji-Gang Ren, Ping Xu, Hai-Lin Yong, Liang Zhang, Sheng-Kai Liao, Juan Yin, Wei-Yue Liu, Wen-Qi Cai, Meng Yang, Li Li, Kui-Xing Yang, Xuan Han, Yong-Qiang Yao, Ji Li, Hai-Yan Wu, Song Wan, Lei Liu, Ding-Quan Liu, Yao-Wu Kuang, Zhi-Ping He, Peng Shang, Cheng Guo, Ru-Hua Zheng, Kai Tian, Zhen-Cai Zhu, Nai-Le Liu, Chao-Yang Lu, Rong Shu, Yu-Ao Chen, Cheng-Zhi Peng, Jian-Yu Wang, and Jian-Wei Pan. Ground-to-satellite quantum teleportation. *Nature*, 549(7670):70–73, September 2017.
- [75] Raju Valivarthi, Marcel li Grimau Puigibert, Qiang Zhou, Gabriel H Aguilar, Varun B Verma, Francesco Marsili, Matthew D Shaw, Sae Woo Nam, Daniel Oblak, and Wolfgang Tittel. Quantum teleportation across a metropolitan fibre network. *Nat. Photonics*, 10(10):676–680, October 2016.
- [76] Tao Liu. The applications and challenges of quantum teleportation. *J. Phys. Conf. Ser.*, 1634(1):012089, September 2020.
- [77] Ji-Gang Ren, Ping Xu, Hai-Lin Yong, Liang Zhang, Sheng-Kai Liao, Juan Yin, Wei-Yue Liu, Wen-Qi Cai, Meng Yang, Li Li, Kui-Xing Yang, Xuan Han, Yong-Qiang Yao, Ji Li, Hai-Yan Wu, Song Wan, Lei Liu, Ding-Quan Liu, Yao-Wu Kuang, Zhi-Ping He, Peng Shang, Cheng Guo, Ru-Hua Zheng, Kai Tian, Zhen-Cai Zhu, Nai-Le Liu, Chao-Yang Lu, Rong Shu, Yu-Ao Chen, Cheng-Zhi Peng, Jian-Yu Wang, and Jian-Wei Pan. Ground-to-satellite quantum teleportation. *Nature*, 549(7670):70–73, September 2017.
- [78] Raju Valivarthi, Marcel li Grimau Puigibert, Qiang Zhou, Gabriel H Aguilar, Varun B Verma, Francesco Marsili, Matthew D Shaw, Sae Woo Nam, Daniel Oblak, and Wolfgang Tittel. Quantum teleportation across a metropolitan fibre network. *Nature Photon*, 10(10):676–680, October 2016.
- [79] Siddarth Koduru Joshi, Djeylan Aktas, Sören Wengerowsky, Martin Lončarić, Sebastian Philipp Neumann, Bo Liu, Thomas Scheidl, Guillermo Currás Lorenzo, Željko Samec, Laurent Kling, Alex Qiu, Mohsen Razavi, Mario Stipčević, John G Rarity, and Rupert Ursin. A trusted node-free eight-user metropolitan quantum communication network. *Sci. Adv.*, 6(36), September 2020.
- [80] Jacob F. Sherson, Hanna Krauter, Rasmus K. Olsson, Brian Julsgaard, Klemens Hammerer, Ignacio Cirac, and Eugene S. Polzik. Quantum teleportation between light and matter. *Nature*, 443(7111):557–560, Oct 2006.
- [81] Qiang Zhang, Alexander Goebel, Claudia Wagenknecht, Yu-Ao Chen, Bo Zhao, Tao Yang, Alois Mair, Jörg Schmiedmayer, and Jian-Wei Pan. Experimental quantum teleportation of a two-qubit composite system. *Nature Phys*, 2(10):678–682, October 2006.
- [82] Brian R. Belland. *Instructional Scaffolding in STEM Education*. Springer International Publishing, 2017.
- [83] Saeed Salimpour, Russell Tytler, Urban Eriksson, and Michael Fitzgerald. Cosmos visualized: Development of a qualitative framework for analyzing representations in cosmology education. *Phys. Rev. Phys. Educ. Res.*, 17(1), May 2021.
- [84] Shaaron Ainsworth. The functions of multiple representations. *Computers & Education*, 33(2-3):131–152, September 1999.
- [85] Shaaron Ainsworth. Deft: A conceptual framework for considering learning with multiple representations. *Learning and Instruction*, 16(3):183–198, 2006.
- [86] J Plass, R Moreno, and R Brünken. *Cognitive Load Theory*. Cambridge University Press, 2010.
- [87] Yu-Ping Liao, Yi-Lin Cheng, You-Ting Zhang, Hong-Xin Wu, and Ruei-Chang Lu. The interactive system of bloch sphere for quantum computing education. In *2022 IEEE International Conference on Quantum Computing and Engineering (QCE)*, pages 718–723, 2022.

- [88] Thomas K. Bracht, Michael Cosacchi, Tim Seidelmann, Moritz Cygorek, Alexei Vagov, V. Martin Axt, Tobias Heindel, and Doris E. Reiter. Swing-up of quantum emitter population using detuned pulses. *PRX Quantum*, 2:040354, Dec 2021.
- [89] Yusuf Karli, Florian Kappe, Vikas Remesh, Thomas K. Bracht, Julian Münzberg, Saimon Covre da Silva, Tim Seidelmann, Vollrath Martin Axt, Armando Rastelli, Doris E. Reiter, and Gregor Weihs. Super scheme in action: Experimental demonstration of red-detuned excitation of a quantum emitter. *Nano Letters*, 22(16):6567–6572, Aug 2022.
- [90] Sasan Moradi, C. Brandner, Clemens Spielvogel, Denis Krajnc, Stefan Hillmich, Robert Wille, Wolfgang Drexler, and Laszlo Papp. Clinical data classification with noisy intermediate scale quantum computers. *Scientific Reports*, 12, 02 2022.
- [91] Jochen Scheid, Andreas Müller, Rosa Hettmannsperger, and Wolfgang Schnotz. Representational competence in science education: From theory to assessment. In *Models and Modeling in Science Education*, pages 263–277. Springer International Publishing, 2018.
- [92] Paul A Kirschner. Cognitive load theory: implications of cognitive load theory on the design of learning. *Learn. Instr.*, 12(1):1–10, February 2002.
- [93] Alan D. Baddeley and Graham Hitch. Working memory. In Gordon H. Bower, editor, *The Psychology of Learning and Motivation*, volume 8 of *Psychology of Learning and Motivation*, pages 47–89. Academic Press, 1974.
- [94] J.T.E. Richardson, R.W. Engle, L. Hasher, R.H. Logie, E.R. Stoltzfus, and R.T. Zacks. *Working Memory and Human Cognition*. Counterpoints: Cognition, Memory, and Language. Oxford University Press, 1996.
- [95] Robert H. Logie and Clelia Marchetti. Chapter 7 visuo-spatial working memory: Visual, spatial or central executive? In Robert H. Logie and Michel Denis, editors, *Mental Images in Human Cognition*, volume 80 of *Advances in Psychology*, pages 105–115. North-Holland, 1991.
- [96] Günther Lehnert and Hubert D. Zimmer. Auditory and visual spatial working memory. *Memory & Cognition*, 34(5):1080–1090, Jul 2006.
- [97] Richard E Mayer and Roxana Moreno. Nine ways to reduce cognitive load in multimedia learning. *Educ. Psychol.*, 38(1):43–52, January 2003.
- [98] Slava Kalyuga and John Sweller. The redundancy principle in multimedia learning. In Richard Mayer, editor, *The Cambridge Handbook of Multimedia Learning*, pages 247–262. Cambridge University Press, Cambridge, July 2014.
- [99] Slava Kalyuga, Paul Ayres, Paul Chandler, and John Sweller. The expertise reversal effect. *Educational Psychologist*, 38(1):23–31, 2003.
- [100] Mary Lou Koran and John J. Koran Jr. Aptitude-treatment interaction research in science education. *Journal of Research in Science Teaching*, 21(8):793–808, 1984.
- [101] PAUL CHANDLER and JOHN SWELLER. The split-attention effect as a factor in the design of instruction. *British Journal of Educational Psychology*, 62(2):233–246, 1992.
- [102] R E Mayer. *The Cambridge Handbook of Multimedia Learning*. Cambridge University Press, Cambridge, 2005.
- [103] John Sweller, Paul Ayres, and Slava Kalyuga. *The Element Interactivity Effect*, pages 193–201. Springer New York, New York, NY, 2011.
- [104] Nicole D LaDue, Julie C Libarkin, and Stephen R Thomas. Visual representations on high school biology, chemistry, earth science, and physics assessments. *J. Sci. Educ. Technol.*, 24(6):818–834, December 2015.
- [105] Max Black. *Models and metaphors - Studies in Language and Philosophy*. Cornell University Press, Ithaca, NY, January 1962.
- [106] Steven W. Gilbert. *Models-based Science Teaching*. NSTA Press, Arlington, Virginia, 2011.
- [107] Douglas A Schenck and Peter R Wilson. 12Models and representations. In *Information Modeling: The EXPRESS Way*. Oxford University Press, 04 1994.
- [108] Brian Hand, Mark McDermott, and Vaughan Prain, editors. *Using Multimodal Representations to Support Learning in the Science Classroom*. Springer International Publishing, 2016.
- [109] Tina Seufert and Roland Brünken. Supporting coherence formation in multimedia learning a theoretical framework and first experimental results. *Instructional Design for Effective and Enjoyable Computer- Supported Learning*, 01 2004.
- [110] Stefan Seegerer, Tilman Michaeli, and Ralf Romeike. Quantum computing as a topic in computer science education. In *Proceedings of the 16th Workshop in Primary and Secondary Computing Education*, WiPSCE '21, New York, NY, USA, 2021. Association for Computing Machinery.
- [111] Tunde Kushimo and Beth Thacker. Investigating students' strengths and difficulties in quantum computing, 2023.

- [112] V Vedral. The role of relative entropy in quantum information theory. *Rev. Mod. Phys.*, 74(1):197–234, March 2002.
- [113] E R Johnston, N Harrigan, and M Gimeno-Segovia. *Programming Quantum Computers: Essential algorithms and code samples*. O’Reilly Media, Incorporated, 2019.
- [114] Bob Coecke. The logic of entanglement, 2004.
- [115] S. Abramsky and B. Coecke. A categorical semantics of quantum protocols. In *Proceedings of the 19th Annual IEEE Symposium on Logic in Computer Science, 2004.*, pages 415–425, 2004.
- [116] Bettina Just. *Quantum computing compact*. Springer, Berlin, Germany, 1 edition, January 2023.
- [117] Stefan Glaser, Michael Tesch, and Niklas Glaser. Spindrops.
- [118] Ariane Garon, Robert Zeier, and Steffen J. Glaser. Visualizing operators of coupled spin systems. *Phys. Rev. A*, 91:042122, Apr 2015.
- [119] Jonas Bley, Eva Rexigel, Alda Arias, Nikolas Longen, Lars Krupp, Maximilian Kiefer-Emmanouilidis, Paul Lukowicz, Anna Donhauser, Stefan Küchemann, Jochen Kuhn, and Artur Widera. Visualizing entanglement in multi-qubit systems, May 2023.
- [120] Morton H. Rubin. Transverse correlation in optical spontaneous parametric down-conversion. *Phys. Rev. A*, 54:5349–5360, Dec 1996.
- [121] Frédéric Bouchard, Alicia Sit, Yingwen Zhang, Robert Fickler, Filippo M Miatto, Yuan Yao, Fabio Sciarrino, and Ebrahim Karimi. Two-photon interference: the hong–ou–mandel effect. *Reports on Progress in Physics*, 84(1):012402, dec 2020.
- [122] Thinking and speech. In Robert W. Rieber and Aaron S. Carton, editors, *The Collected Works of L. S. Vygotsky*. Springer US, 1988. Original work published in 1934.
- [123] Ernst von Glasersfeld. Cognition, construction of knowledge, and teaching. *Synthese*, 80(1):121–140, Jul 1989.
- [124] Heather Banchi and Randy Bell. The many levels of inquiry. *Sci. Child.*, 46, 01 2008.
- [125] R W Bybee, J A Taylor, A Gardner, P Van Scotter, J C Powell, A Westbrook, and N Landes. The BSCS 5E instructional model: Origins and effectiveness. *Colorado Springs, Co: BSCS*, 5:88–98, 2006.
- [126] Barbara Y White and John R Frederiksen. Inquiry, modeling, and metacognition: Making science accessible to all students. *Cogn. Instr.*, 16(1):3–118, 03 1998.
- [127] Ron Gray and Todd Campbell. Model-based inquiry - what is mbi? <https://sites.google.com/view/modelbasedinquiry/what-is-mpi> (accessed 05th December 2023), 2023.
- [128] H Banchi and R Bell. The many levels of inquiry. *Children*, 46(2):26–29, 2008.
- [129] Nicolas Tanchuk. Is inquiry learning unjust? cognitive load theory and the democratic ends of education. *J. Philos. Educ.*, 54(5):1167–1185, October 2020.
- [130] Zeki C Seskir, Piotr Migdal, Carrie Weidner, Aditya Anupam, Nicky Case, Noah Davis, Chiara Decaroli, İlke Ercan, Caterina Foti, Pawel Gora, Klementyna Jankiewicz, Brian R La Cour, Jorge Yago Malo, Sabrina Maniscalco, Azad Naeemi, Laurentiu Nita, Nassim Parvin, Fabio Scaffrimuto, Jacob F Sherson, Elif Surer, James Wootton, Lia Yeh, Olga Zabello, and Marilù Chiofalo. Quantum games and interactive tools for quantum technologies outreach and education. *Opt. Eng.*, 61(08), July 2022.
- [131] Laurentiu Nita, Nicholas Chancellor, Laura Mazzoli Smith, Helen Cramman, and Gulsah Dost. Inclusive learning for quantum computing: supporting the aims of quantum literacy using the puzzle game quantum odyssey, 2021.
- [132] J J Sørensen, J H M Jensen, T Heinzl, and J F Sherson. QEngine: A c++ library for quantum optimal control of ultracold atoms. *Comput. Phys. Commun.*, 243:135–150, October 2019.
- [133] Jesper Hasseriis Mohr Jensen, Jens Jakob Sørensen, Klaus Mølmer, and Jacob Friis Sherson. Time-optimal control of collisional $\sqrt{\text{swap}}$ gates in ultracold atomic systems. *Phys. Rev. A*, 100:052314, Nov 2019.
- [134] David W Johnson, Geoffrey Maruyama, Roger Johnson, Deborah Nelson, and Linda Skon. Effects of cooperative, competitive, and individualistic goal structures on achievement: A meta-analysis. *Psychol. Bull.*, 89(1):47–62, January 1981.
- [135] D W Johnson, R T Johnson, and K A Smith. *Cooperative Learning: Increasing College Faculty Instructional Productivity*. Association for the Study of Higher Education.; ERIC Clearinghouse on Higher Education, Washington, DC.; George Washington Univ., Washington, DC. School of Education and Human Development., Washington DC, 1991.
- [136] D W Johnson, R T Johnson, and M B Stanne. *Cooperative learning methods: A meta-analysis*. Minneapolis: University of Minnesota, 2000.
- [137] Anna G Cavinato, Rebecca A Hunter, Lisa S Ott, and Jill K Robinson. Promoting student interaction, engagement, and success in an online environment. *Anal. Bioanal. Chem.*,

- 413(6):1513–1520, March 2021.
- [138] B. Corchuelo-Martínez Azúa and M.A. Blanco-Sandía. Interdisciplinary cooperative learning (icl): A practical application in the subjects mathematics and microeconomics. In *INTED2014 Proceedings*, 8th International Technology, Education and Development Conference, pages 5976–5984. IATED, 10-12 March, 2014 2014.
- [139] Michael F. J. Fox, Benjamin M. Zwickl, and H. J. Lewandowski. Preparing for the quantum revolution: What is the role of higher education? *Phys. Rev. Phys. Educ. Res.*, 16:020131, Oct 2020.
- [140] Araceli Venegas-Gomez. The quantum ecosystem and its future workforce. *PhotonicsViews*, 17(6):34–38, December 2020.
- [141] Lurdes Patrício and Mário Franco. A systematic literature review about team diversity and team performance: Future lines of investigation. *Adm. Sci.*, 12(1):31, February 2022.
- [142] Joseph Wilck and Paul C. Lynch. Diverse teams build better forecasts. In *2018 ASEE Annual Conference & Exposition*, Salt Lake City, Utah, June 2018. ASEE Conferences. <https://peer.asee.org/30339>.
- [143] Abby L Mello and Joan R Rentsch. Cognitive diversity in teams. *Small Group Res.*, 46(6):623–658, December 2015.
- [144] Zhongju Liao and Siying Long. Cognitive diversity, alertness, and team performance. *Soc. Behav. Pers.*, 44(2):209–220, March 2016.
- [145] Katherine L Nafukho and M Fredrick. Developing diverse teams to improve performance in the organizational setting yeager. *European Journal of Training and Development*, 36:388–408, 2012.
- [146] Vidhi Agrawal. Managing the diversified team: challenges and strategies for improving performance. *Team Perform. Manag.*, 18(7/8):384–400, October 2012.
- [147] Daan van Knippenberg, Wendy P van Ginkel, and Astrid C Homan. Diversity mindsets and the performance of diverse teams. *Organ. Behav. Hum. Decis. Process.*, 121(2):183–193, July 2013.
- [148] Bareerah Hafeez Hoorani. Impact of cooperative learning in developing students’ cognitive abilities for academic achievement. *Journal of Education and Educational Development*, 2014.
- [149] Sebastián Gómez Jaramillo and Julián Moreno Cadavid. Selection of collaborative learning techniques using bloom’s taxonomy. In Fernando Koch, Andrew Koster, and Tiago Primo, editors, *Social Computing in Digital Education*, pages 1–11, Cham, 2016. Springer International Publishing.
- [150] Michaéla C. Schippers, Deanne N. Den Hartog, Paul L. Koopman, and Janique A. Wienk. Diversity and team outcomes: the moderating effects of outcome interdependence and group longevity and the mediating effect of reflexivity. *Journal of Organizational Behavior*, 24(6):779–802, 2003.
- [151] Janneke van de Pol, Monique Volman, and Jos Beishuizen. Scaffolding in teacher–student interaction: A decade of research. *Educational Psychology Review*, 22(3):271–296, Sep 2010.
- [152] Brian R. Belland. Scaffolding: Definition, current debates, and future directions. In J. Michael Spector, M. David Merrill, Jan Elen, and M. J. Bishop, editors, *Handbook of Research on Educational Communications and Technology*, pages 505–518. Springer New York, New York, NY, 2014.
- [153] Ravit Golan Duncan Cindy E. Hmelo-Silver and Clark A. Chinn. Scaffolding and achievement in problem-based and inquiry learning: A response to kirschner, sweller, and clark (2006). *Educational Psychologist*, 42(2):99–107, 2007.
- [154] Elizabeth A. Davis. Scaffolding students’ knowledge integration: prompts for reflection in kie. *International Journal of Science Education*, 22(8):819–837, 2000.
- [155] Eva Erdosne Toth, Daniel D. Suthers, and Alan M. Lesgold. “mapping to know”: The effects of representational guidance and reflective assessment on scientific inquiry. *Science Education*, 86(2):264–286, 2002.
- [156] Md Abdullah Al Mamun, Gwendolyn Lawrie, and Tony Wright. Instructional design of scaffolded online learning modules for self-directed and inquiry-based learning environments. *Computers & Education*, 144:103695, 2020.
- [157] Syafira Tiaradipa, Intan Lestari, M Rusdi, and Muhammad Haris Effendi-Hasibuan. The development of scaffolding in inquiry-based learning to improve students’ science process skills in the concept of acid and base solution. *JKPK (Jurnal Kimia dan Pendidikan Kimia)*, 5:211–221, 09 2020.
- [158] Stefan Gross and Christal D. Sohl. Readyng students for careers in industry: A guided inquiry activity to prepare students for success in biotechnology and pharmaceutical industry

- positions. *Biochemistry and Molecular Biology Education*, 49(3):407–415, February 2021.
- [159] Virtual reflection: What teachers say (and don't say) online about their practice. In Gijbert Erkens Angela M. O'Donnell, Cindy E. Hmelo-Silver, editor, *Collaborative Learning, Reasoning, and Technology*, pages 113–140. Routledge, September 2005.
- [160] Chris Quintana, Brian J. Reiser, Elizabeth A. Davis, Joseph Krajcik, Eric Fretz, Ravit Golan Duncan, Eleni Kyza, Daniel Edelson, and Elliot Soloway. A scaffolding design framework for software to support science inquiry. *The Journal of the Learning Sciences*, 13(3):337–386, 2004.
- [161] Ying-Shao Hsu, Ting-Ling Lai, and Wei-Hsiu Hsu. A design model of distributed scaffolding for inquiry-based learning. *Research in Science Education*, 45(2):241–273, Apr 2015.
- [162] Duygu Umutlu and M. Emre Gursoy. Leveraging artificial intelligence techniques for effective scaffolding of personalized learning in workplaces. In Dirk Ifenthaler and Sabine Seufert, editors, *Artificial Intelligence Education in the Context of Work*, pages 59–76. Springer International Publishing, Cham, 2022.
- [163] Kai Halttunen. Scaffolding performance in ir instruction: Exploring learning experiences and performance in two learning environments. *Journal of Information Science*, 29(5):375–390, 2003.
- [164] KURT VanLEHN. The relative effectiveness of human tutoring, intelligent tutoring systems, and other tutoring systems. *Educational Psychologist*, 46(4):197–221, 2011.
- [165] Ching-Huei Chen and Victor Law. Scaffolding individual and collaborative game-based learning in learning performance and intrinsic motivation. *Computers in Human Behavior*, 55:1201–1212, 2016.
- [166] Haiying Li, Janice Gobert, Rachel Dickler, and Raha Moussavi. The impact of multiple real-time scaffolding experiences on science inquiry practices. In Roger Nkambou, Roger Azevedo, and Julita Vassileva, editors, *Intelligent Tutoring Systems*, pages 99–109, Cham, 2018. Springer International Publishing.
- [167] KT Onah. Effect of scaffolding teaching approach on students' academic achievement in quantum physics in enugu education zone. *Greener Journal of Educational Research*, 12(1):13–21, 2022.
- [168] Khaled Ahmed Abdel-Al Ibrahim, Nestor Cuba Carbajal, Manuel Enrique Chenet Zuta, and Sania Bayat. Collaborative learning, scaffolding-based instruction, and self-assessment: impacts on intermediate efl learners' reading comprehension, motivation, and anxiety. *Language Testing in Asia*, 13(1):16, Mar 2023.
- [169] Beth Maloch. Scaffolding student talk: One teacher's role in literature discussion groups. *Reading Research Quarterly*, 37(1):94–112, 2002.
- [170] Tor Ole B. Odden, Elise Lockwood, and Marcos D. Caballero. Physics computational literacy: An exploratory case study using computational essays. *Phys. Rev. Phys. Educ. Res.*, 15:020152, Dec 2019.
- [171] Tor Ole B. Odden and John Burk. Computational essays in the physics classroom. *The Physics Teacher*, 58(4):252–255, apr 2020.
- [172] Tor Ole B Odden and Anders Malthe-Sørenssen. Using computational essays to scaffold professional physics practice. *European Journal of Physics*, 42(1):015701, nov 2020.
- [173] DigiQ. <https://digiq.eu>. Accessed: 2023-8-17.
- [174] QTIndu project. <https://qtindu.eu>. Accessed: 2023-8-17.
- [175] John Sweller, Paul Ayres, and Slava Kalyuga. *Intrinsic and Extrinsic Cognitive Load*, pages 57–69. Springer New York, New York, NY, 2011.
- [176] Marjan Laal. Positive interdependence in collaborative learning. *Procedia - Social and Behavioral Sciences*, 93:1433–1437, 2013. 3rd World Conference on Learning, Teaching and Educational Leadership.