

Decentralized Parametric Stability Certificates for Grid-Forming Converter Control

Verena Häberle, *Graduate Student Member, IEEE*, Xiuqiang He, *Member, IEEE*,
Linbin Huang, *Member, IEEE*, Florian Dörfler, *Senior Member, IEEE*, and Steven Low, *Fellow, IEEE*

Abstract—We propose a decentralized framework for guaranteeing the small-signal stability of future power systems with grid-forming converters. Our approach leverages dynamic loop-shifting techniques to compensate for the lack of passivity in the network dynamics and establishes decentralized parametric stability certificates, depending on the local device-level controls and incorporating the effects of the network dynamics. By following practical tuning rules, we are able to ensure plug-and-play operation without centralized coordination. Unlike prior works, our approach accommodates coupled frequency and voltage dynamics, incorporates network dynamics, and does not rely on specific network configurations or operating points, offering a general and scalable solution for the integration of power-electronics-based devices into future power systems. We validate our theoretical stability results through numerical case studies in a high-fidelity simulation model.

Index Terms—power system stability, grid-forming converter, passivity, decentralized stability conditions

I. INTRODUCTION

THE transition to future power systems is characterized by a substantial increase in the share of power electronics (PE)-based generation devices. This shift introduces significant changes in system dynamics, where the interactions between PE-based generation and the remainder of the power network are not fully understood yet [1]. In particular, the fast and complex dynamics of PE-based devices can lead to unexpected effects (e.g., overvoltages [2], subsynchronous oscillations [3], etc.), posing considerable challenges for maintaining system stability. Consequently, there is a pressing need for a deeper understanding of how PE-based devices interact with one another or with the grid and for the development of robust stability frameworks to ensure stable operation.

One of the key aspects of future power systems involves the integration of PE-based devices with either grid-following or grid-forming control. Grid-forming (GFM) control is particularly promising as it enhances stability by establishing a well-defined ac voltage at the grid connection [1], [4]. However, at

the same time, it has been observed that network dynamics can significantly influence the stability of PE-dominated systems [5], [6], unlike traditional synchronous generator-dominated grids, which exhibit relatively slow dynamics compared to the fast network dynamics. This creates a need for analysis methods that account for the interplay between network dynamics and the control characteristics of PE-based devices.

In this paper, we address the destabilizing effects of network dynamics on the small-signal stability of heterogeneous inter-connected GFM converters. Our approach seeks to compensate for these effects by proposing *parametric* decentralized stability certificates to ensure system-wide stability. Specifically, we introduce a decentralized framework for quantitatively certifying stability at the individual device level through *local tuning rules* for each GFM controller. This enables plug-and-play operation without centralized coordination. Our approach leverages dynamic loop-shifting techniques to compensate for the lack of passivity in the network dynamics. By formulating device-level specifications that are sufficiently passive, we ensure overall system stability in a flexible and scalable way.

Our contribution improves significantly over prior works on stability certification in GFM converter systems. Unlike [7], [8], which are limited to single-input single-output (SISO) dynamics, our approach accommodates multiple-input multiple-output (MIMO) dynamics coupling frequency and voltage, thus providing a more comprehensive analysis of the system behavior. Additionally, we incorporate the network dynamics, extending beyond the quasi-stationary or zero-power flow approximations in [7], [9], [10]. Our decentralized stability conditions enable the use of heterogeneous GFM models, improving over the homogeneity assumptions in [8], [11]. Moreover, unlike [12], our approach does not require detailed knowledge of the network configuration. Finally, our stability conditions are independent of the operating point, provided small bus angle differences, unlike [9], where the stability conditions depend on specific operating points. Collectively, these attributes allow our framework to provide, to the best of our knowledge, the most general, explicitly parametric, and practically applicable small-signal stability certificates for interconnected GFM devices in the literature. Since our stability conditions are readily actionable for control tuning and grid-code design, they can ensure a stable and scalable integration of PE-based generation in future power systems.

The paper is structured as follows. Section II introduces preliminary concepts of feedback stability and passivity for linear time-invariant (LTI) systems. In Section III, we describe

This work was supported by the EU Horizon 2023 research and innovation program (Grant Agreement Number 101096197). Verena Häberle and Florian Dörfler are with the Automatic Control Laboratory, ETH Zurich, 8092 Zurich, Switzerland. Email: {verenhae,dorfler}@ethz.ch. Xiuqiang He is with the Department of Automation, Tsinghua University, Beijing 100084, China. Email: hxq19@tsinghua.org.cn. Linbin Huang is with the College of Electrical Engineering, Zhejiang University, Hangzhou 310027, China. Email: hlinbin@zju.edu.cn. Steven Low is with the Department of Computing and Mathematical Sciences and the Department of Electrical Engineering, Caltech, Pasadena, CA 91125 USA. Email: slow@caltech.edu.

the dynamic power system model utilized for stability analysis. Section IV presents our main results: decentralized parametric stability certificates for GFM converters that account for network dynamics. The results are validated through numerical case studies in Section V. Section VI concludes the paper.

II. FOUNDATIONS OF INTERCONNECTED SYSTEMS

A. Preliminaries

Let \mathbb{R} denote the set of real numbers, \mathbb{N} the set of positive integers, and \mathbb{C} the set of complex numbers with imaginary unit j . We use I_n to denote the n -by- n identity matrix (abbreviated as I when the dimensions can be inferred from the context). We use \otimes to denote the Kronecker product. We use $A = \text{diag}(A_1, A_2, \dots, A_k)$, $k \in \mathbb{Z}$ to denote the block-diagonal matrix with blocks A_1, A_2, \dots, A_k . The Euclidean norm of a matrix A is defined as $\|A\|_F = \sqrt{\sum_{i,j} |a_{ij}|^2}$, where a_{ij} is the entry in the i th row and j th column of A .

For a complex matrix $A \in \mathbb{C}^{n \times n}$, we use A^* to denote its conjugate transpose. A matrix $A \in \mathbb{C}^{n \times n}$ satisfying $A = A^*$ is called *Hermitian*. A Hermitian matrix $A \in \mathbb{C}^{n \times n}$ is said to be *positive definite (semi-definite)*, denoted by $A \succ 0$ ($\succeq 0$), if $x^*Ax > 0$ (≥ 0) for all $x \neq 0$. A matrix $A \in \mathbb{C}^{n \times n}$ is called *diagonally dominant*, if $|a_{ii}| \geq \sum_{j \neq i} |a_{ij}|$, $\forall i$.

To establish our main stability results in Section IV, we require the following lemma which follows from the Gershgorin's Circle Theorem [13, Thm. 6.1.10]:

Lemma 1. *A Hermitian diagonally dominant matrix with real non-negative diagonal entries is positive semi-definite.*

Further, we review the recent concept of phases of complex matrices based on the matrix's numerical range [14]. Namely, the *numerical range* of a complex matrix $A \in \mathbb{C}^{n \times n}$ is defined as $W(A) = \{x^*Ax : x \in \mathbb{C}^n, \|x\| = 1\}$. If $0 \notin W(A)$, then A is said to be a *sectorial matrix*. For a sectorial A , there exists a nonsingular matrix T and a diagonal unitary matrix D such that $A = T^*DT$ [14]. The diagonal elements of D are distributed in an arc on the unit circle with length smaller than π . Then, the *phases* of A , denoted by

$$\overline{\phi}(A) = \phi_1(A) \geq \dots \geq \phi_n(A) = \underline{\phi}(A), \quad (1)$$

are defined as the phases of the diagonal entries of D so that $\overline{\phi}(A) - \underline{\phi}(A) < \pi$. The definition of phases can be generalized to so-called *semi-sectorial* matrices whose numerical ranges contain the origin on their boundaries and $\overline{\phi}(A) - \underline{\phi}(A) \leq \pi$.

B. Transfer Functions & Stability

Let $u(t) \in \mathbb{R}^n$ be the input and $y(t) \in \mathbb{R}^n$ the output signal of a MIMO LTI system. The transfer matrix $H(s) \in \mathbb{C}^{n \times n}$ describes the input-output system response in the frequency domain as $y(s) = H(s)u(s)$, where $y(s)$ and $u(s)$ are the Laplace transformations of the output and input, respectively.

We denote the space of n -by- n real rational proper transfer matrices of stable LTI systems by $\mathcal{RH}_\infty^{n \times n}$. An LTI system is called *stable* if all poles are in the open left half plane (LHP). It is called *semi-stable* if it may have poles on the imaginary axis but no poles in the open right half plane (RHP).

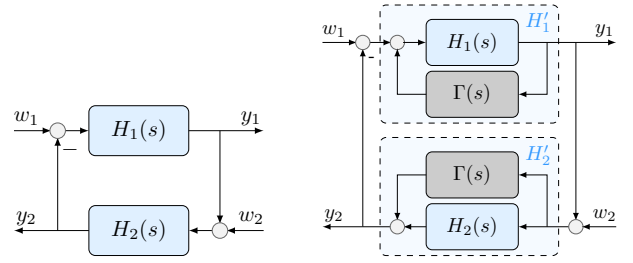

(a) Original feedback system.

(b) Loop shifting with $\Gamma(s)$.

Fig. 1: Closed-loop feedback interconnection of two LTI systems.

Definition 1 (Internal Feedback Stability [15]). *Let $H_1(s)$ and $H_2(s)$ be $n \times n$ real rational proper transfer matrices. The feedback system in Fig. 1a is internally feedback stable if and only if the following four closed-loop transfer matrices*

$$\begin{bmatrix} y_1 \\ y_2 \end{bmatrix} = \underbrace{\begin{bmatrix} (I + H_1 H_2)^{-1} H_1 & -(I + H_1 H_2)^{-1} H_1 H_2 \\ H_2 (I + H_1 H_2)^{-1} H_1 & H_2 (I + H_1 H_2)^{-1} \end{bmatrix}}_{=: H_1 \# H_2(s)} \begin{bmatrix} w_1 \\ w_2 \end{bmatrix} \quad (2)$$

are stable, compactly referred to as $H_1 \# H_2 \in \mathcal{RH}_\infty^{2n \times 2n}$.

If there are no RHP pole-zero cancellations between $H_1(s)$ and $H_2(s)$, then stability of one closed-loop transfer matrix implies stability of the others [15, Thm 4.5]:

Lemma 2. *Assume there are no RHP pole-zero cancellations between $H_1(s)$ and $H_2(s)$, i.e., all RHP poles in $H_1(s)$ and $H_2(s)$ are contained in the minimal realization of $H_1(s)H_2(s)$ and $H_2(s)H_1(s)$. Then, the feedback system in Fig. 1a is internally feedback stable if and only if one of the four closed-loop transfer matrices in (2) is stable.*

C. Small-Phase & Passivity Theory

For LTI systems, the property of passivity is equivalent to the property of positive realness [16]–[18].

Definition 2 (Passive Transfer Matrices [18]). *A $n \times n$ real rational proper transfer matrix $H(s)$ is passive if*

- (i) poles of all elements of $H(s)$ are in $\text{Re}(s) \leq 0$,
- (ii) $H(j\omega) + H^*(j\omega) \succeq 0$ for any ω for which $j\omega$ is not a pole of any element of $H(s)$,
- (iii) any purely imaginary pole $j\omega$ of any element of $H(s)$ is a simple pole and $\lim_{s \rightarrow j\omega} (s - j\omega)H(s)$ is positive semi-definite Hermitian.

Definition 3 (Strictly Passive Transfer Matrices [18]). *A $n \times n$ real rational proper transfer matrix $H(s)$ is strictly passive if*

- (i) poles of all elements of $H(s)$ are in $\text{Re}(s) < 0$,
- (ii) $H(j\omega) + H^*(j\omega) \succ 0$ for any $\omega \in [-\infty, \infty]$.

We now present a generalization of the passivity theorem [17], [18] for the special case of LTI systems as follows:

Theorem 1 (Passivity Theorem). *Consider two LTI systems $H_1(s)$ and $H_2(s)$ in negative feedback configuration, as shown in Fig. 1a. The feedback system is internally feedback stable if $H_1(s)$ is strictly passive and $H_2(s)$ is passive.*

The above theorem is widely known in the SISO case [17], but we could not locate a proof in this general MIMO setting. We thus provide a self-contained proof below, relying on the Generalized Small-Phase Theorem [14, Thm 7.1]:

Lemma 3 (Generalized Small-Phase Theorem). *Let $H_1(s) \in \mathcal{RH}_\infty^{n \times n}$ be frequency-wise sectorial and $H_2(s)$ be semi-stable frequency-wise semi-sectorial with $j\Omega$ being the set of poles on the imaginary axis. Then, $H_1 \# H_2$ in Fig. 1a is internally feedback stable if*

$$\begin{aligned} \sup_{\omega \in [0, \infty] \setminus \Omega} [\overline{\phi}(H_1(j\omega)) + \overline{\phi}(H_2(j\omega))] < \pi \quad \text{and} \\ \inf_{\omega \in [0, \infty] \setminus \Omega} [\underline{\phi}(H_1(j\omega)) + \underline{\phi}(H_2(j\omega))] > -\pi. \end{aligned} \quad (3)$$

Proof of Theorem 1. We prove Theorem 1 by applying Lemma 3 as follows: Since $H_1(s)$ is strictly passive, it follows that $H_1(s) \in \mathcal{RH}_\infty^{n \times n}$ is frequency-wise sectorial with phases $[\phi(H_1(j\omega)), \overline{\phi}(H_1(j\omega))] \subset (-\frac{\pi}{2}, \frac{\pi}{2}), \forall \omega \in [0, \infty]$ (see [14] for a detailed derivation). Likewise, since $H_2(s)$ is passive, it follows that $H_2(s)$ is semi-stable with poles at $j\omega$ on the imaginary axis and frequency-wise semi-sectorial with phases $[\phi(H_2(j\omega)), \overline{\phi}(H_2(j\omega))] \subset [-\frac{\pi}{2}, \frac{\pi}{2}), \forall \omega \in [0, \infty] \setminus \Omega$ (see [14] for a detailed derivation). Therefore, the conditions in (3) are satisfied which implies $H_1 \# H_2 \in \mathcal{RH}_\infty^{2n \times 2n}$. \square

To extend the passivity-based stability conditions to more general feedback interconnections with both passive and non-passive systems, we employ the concepts of excess and shortage of passivity [17], [18]. The basic idea is that the excess of passivity of one subsystem can compensate for the passivity deficit in the other subsystem, such that their feedback interconnection remains stable. This can be achieved by performing loop-shifting techniques as shown in Fig. 1, where a transfer matrix $\Gamma(s) \in \mathbb{C}^{n \times n}$ is added as a positive feedforward to $H_2(s)$, and as a positive feedback to $H_1(s)$. Now the idea is that if the original subsystems $H_1(s)$ and $H_2(s)$ in Fig. 1a are not satisfying the passivity conditions in Theorem 1, the two subsystems $H'_2(s)$ and $H'_1(s)$ in Fig. 1b might do so for a suitable $\Gamma(s)$, thus resulting in a stable feedback interconnection $H'_1 \# H'_2$ (for details see literature on frequency-dependent passivity indices, e.g., [17], [18]).

Among the four closed-loop transfer matrices in (2) relevant to internal feedback stability, it is immediately evident that only the upper-left transfer matrix mapping from w_1 to y_1 remains equivalent between the original system in Fig. 1a and the loop-shifted system in Fig. 1b. Specifically, $(I + H'_1 H'_2)^{-1} H'_1 = (I + H_1 H_2)^{-1} H_1$. Consequently, stability of $H'_1 \# H'_2$ directly implies stability of $(I + H_1 H_2)^{-1} H_1$. If there are no RHP pole-zero cancellations between $H_1(s)$ and $H_2(s)$, by Lemma 2, stability of the upper-left transfer matrix $(I + H_1 H_2)^{-1} H_1$ also guarantees stability of $H_1 \# H_2$.

Remark 1. *By swapping the feedforward and feedback of $\Gamma(s)$ in Fig. 1b and comparing the closed-loop transfer function from w_2 to y_2 , similar stability conclusions can be made.*

III. POWER SYSTEM MODEL

A. Small-Signal Network Dynamics

We study the stabilization of multiple three-phase GFM voltage source converters (VSCs) connected through a dynamic transmission network modeled by resistive-inductive lines (Fig. 2). We consider a Kron-reduced [19], balanced network with $n \in \mathbb{N}$ converter nodes, denoted by $\{1, \dots, n\}$, where the dynamic *small-signal* model (in the global per

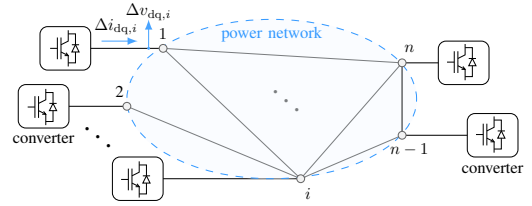

Fig. 2: Illustration of the multi-converter transmission system.

unit system) of the line between node i and node j ($i, j \in \{1, \dots, n\}$) is given in the frequency domain as

$$\begin{bmatrix} \Delta i_{d,ij}(s) \\ \Delta i_{q,ij}(s) \end{bmatrix} = y_{ij}(s) \left(\begin{bmatrix} \Delta v_{d,i}(s) \\ \Delta v_{q,i}(s) \end{bmatrix} - \begin{bmatrix} \Delta v_{d,j}(s) \\ \Delta v_{q,j}(s) \end{bmatrix} \right), \quad (4)$$

where $\Delta i_{dq,ij} = [\Delta i_{d,ij} \ \Delta i_{q,ij}]^\top$ is the current vector from node i to node j in the global dq coordinates with a constant nominal rotating frequency ω_0 , $\Delta v_{dq,i} = [\Delta v_{d,i} \ \Delta v_{q,i}]^\top$ is the voltage vector of node i , and $y_{ij}(s)$ is a 2×2 transfer matrix encoding the small-signal dynamics of the line, i.e.,

$$y_{ij}(s) = b_{ij} \underbrace{\begin{bmatrix} \rho + \frac{s}{\omega_0} & 1 \\ -1 & \rho + \frac{s}{\omega_0} \end{bmatrix} \frac{1}{1 + \left(\rho + \frac{s}{\omega_0}\right)^2}}_{=: f_\rho(s)}, \quad (5)$$

where $b_{ij} = \frac{1}{l_{ij}}$ is the line susceptance, and $\rho_{ij} = \frac{r_{ij}}{l_{ij}}$ is the resistance-inductance ratio of the line ij which is assumed to be *small* and *uniform* (i.e., $\rho_{ij} = \rho, \forall i, j \in \{1, \dots, n\}$) throughout the dominantly inductive transmission network. Notice that $b_{ij} = 0$ and $\rho_{ij} = 0$ if there is no line.

The bus current injection of each node i is defined as $\Delta i_{dq,i}(s) := \sum_{j \neq i}^n \Delta i_{dq,ij}(s)$, based on which we can construct the network dynamics for all nodes in the form of the $2n \times 2n$ Laplacian transfer matrix $Y(s)$, i.e.,

$$\begin{bmatrix} \Delta i_{d,1}(s) \\ \Delta i_{q,1}(s) \\ \vdots \\ \Delta i_{d,n}(s) \\ \Delta i_{q,n}(s) \end{bmatrix} = \underbrace{B_r \otimes f_\rho(s)}_{=: Y(s)} \begin{bmatrix} \Delta v_{d,1}(s) \\ \Delta v_{q,1}(s) \\ \vdots \\ \Delta v_{d,n}(s) \\ \Delta v_{q,n}(s) \end{bmatrix}, \quad (6)$$

where $Y_{ij}(s) = -y_{ij}(s), i \neq j, Y_{ii}(s) = \sum_{j \neq i}^n y_{ij}(s)$ and $B \in \mathbb{R}^{n \times n}$ is a Laplacian matrix

$$B = \begin{bmatrix} \sum_{j \neq 1}^n b_{1j} & \cdots & -b_{1n} \\ \vdots & \ddots & \vdots \\ -b_{n1} & \cdots & \sum_{j \neq n}^n b_{nj} \end{bmatrix}, \quad (7)$$

that encodes the network topology and line susceptances, where $B_{ij} = -b_{ij}$ if $i \neq j$, and $B_{ii} = \sum_{j \neq i}^n b_{ij}$.

The time-domain bus voltages are modeled in polar coordinates as $v_{d,i}(t) := |v|_i(t) \cos \delta_i(t)$ and $v_{q,i}(t) := |v|_i(t) \sin \delta_i(t)$ with magnitude $|v|_i(t)$ and relative angle $\delta_i(t) = \theta_i(t) - \theta_0(t)$ in SI units, where $\theta_i(t)$ is the voltage angle at bus $i \in \{1, \dots, n\}$, and $\theta_0(t)$ the Park transformation angle of the global dq coordinates, which can be expressed as

$$|v|_i(t) = \sqrt{v_{d,i}(t)^2 + v_{q,i}(t)^2}, \quad \delta_i(t) = \arctan\left(\frac{v_{q,i}(t)}{v_{d,i}(t)}\right). \quad (8)$$

We consider the active and reactive branch powers

$$\begin{aligned} p_{ij}(t) &= v_{d,i}(t) i_{d,ij}(t) + v_{q,i}(t) i_{q,ij}(t) \\ q_{ij}(t) &= -v_{d,i}(t) i_{q,ij}(t) + v_{q,i}(t) i_{d,ij}(t), \end{aligned} \quad (9)$$

and define the associated bus power injections $p_i(t) := \sum_{j \neq i}^n p_{ij}(t)$ and $q_i(t) := \sum_{j \neq i}^n q_{ij}(t)$, which are obtained as

$$\begin{aligned} p_i(t) &= v_{d,i}(t)i_{d,i}(t) + v_{q,i}(t)i_{q,i}(t) \\ q_i(t) &= -v_{d,i}(t)i_{q,i}(t) + v_{q,i}(t)i_{d,i}(t). \end{aligned} \quad (10)$$

By linearizing (8) and (10), transforming them into the frequency domain, and performing some analytical computations (see Appendix I for details), we obtain

$$\begin{aligned} \begin{bmatrix} \Delta p_1(s) \\ \Delta q_1(s) \\ \vdots \\ \Delta p_n(s) \\ \Delta q_n(s) \end{bmatrix} &= \underbrace{\begin{bmatrix} N_{11}(s) & \cdots & N_{1n}(s) \\ \vdots & \ddots & \vdots \\ N_{n1}(s) & \cdots & N_{nn}(s) \end{bmatrix}}_{=: N(s)} \begin{bmatrix} \Delta \delta_1(s) \\ \Delta |v|_{n,1}(s) \\ \vdots \\ \Delta \delta_n(s) \\ \Delta |v|_{n,n}(s) \end{bmatrix} \\ &=: \begin{bmatrix} \Delta p(s) \\ \Delta q(s) \end{bmatrix} \quad =: \begin{bmatrix} \Delta \delta(s) \\ \Delta |v|_{n,n}(s) \end{bmatrix} \end{aligned} \quad (11)$$

with the 2×2 transfer matrix blocks $N_{ii}(s)$ and $N_{ij}(s)$

$$\begin{aligned} N_{ii}(s) &= \sum_{j \neq i}^n b_{ij} \frac{|v|_{0,i}^2}{1+(\rho+\frac{s}{\omega_0})^2} \begin{bmatrix} 1 & \rho + \frac{s}{\omega_0} \\ -(\rho + \frac{s}{\omega_0}) & 1 \end{bmatrix} \\ &\quad + \sum_{j \neq i}^n b_{ij} \frac{|v|_{0,i}^2 - |v|_{0,i}|v|_{0,j}}{1+\rho^2} \begin{bmatrix} -1 & \rho \\ \rho & 1 \end{bmatrix} \\ N_{ij}(s) &= b_{ij} \frac{|v|_{0,i}|v|_{0,j}}{1+(\rho+\frac{s}{\omega_0})^2} \begin{bmatrix} -1 & -(\rho + \frac{s}{\omega_0}) \\ (\rho + \frac{s}{\omega_0}) & -1 \end{bmatrix}, \end{aligned} \quad (12)$$

where $\Delta |v|_{n,i}(s) := \frac{\Delta |v|_i(s)}{|v|_{0,i}}$ is the voltage magnitude at bus i normalized at the steady-state $|v|_{0,i}$. Moreover to derive (12) as in any power system small-signal model, we have assumed a small steady-state angle difference $\delta_{0,i} \approx \delta_{0,j}$, which is standard and justified since thermal limitations for transmission lines preclude large angle differences [20].

For a dominantly inductive transmission network with $\rho \ll 1$, the standard approximation of the line dynamics matrix

$$M(s) = \frac{1}{1+(\rho+\frac{s}{\omega_0})^2} \begin{bmatrix} 1 & \rho + \frac{s}{\omega_0} \\ -(\rho + \frac{s}{\omega_0}) & 1 \end{bmatrix} \quad (13)$$

appearing in $N_{ii}(s)$ and $N_{ij}(s)$ in (12) is

$$M_1(s) = \frac{1}{1+\frac{s^2}{\omega_0^2}} \begin{bmatrix} 1 & \frac{s}{\omega_0} \\ -\frac{s}{\omega_0} & 1 \end{bmatrix}, \quad (14)$$

i.e., losses are entirely neglected ($\rho = 0$). Here we put forward a novel and more accurate approximation for $M(s)$, namely

$$M_2(s) = \frac{1}{1+(\rho+\frac{s}{\omega_0})^2} \begin{bmatrix} 1 & \frac{s}{\omega_0} \\ -\frac{s}{\omega_0} & 1 \end{bmatrix}. \quad (15)$$

Indeed, a straightforward calculation comparing the Euclidean norms of the matrix distances for $s = j\omega$ reveals that $\forall \omega \geq 0$

$$\frac{\|M(j\omega) - M_2(j\omega)\|_F}{\|M(j\omega) - M_1(j\omega)\|_F} = \sqrt{\frac{1 + \frac{\omega^4}{\omega_0^4} - 2\frac{\omega^2}{\omega_0^2}}{1 + \frac{\omega^4}{\omega_0^4} + 6\frac{\omega^2}{\omega_0^2} + \rho^2(1 + \frac{\omega^2}{\omega_0^2)}}} < 1, \quad (16)$$

that is, both approximations are consistent for $\rho \rightarrow 0$ in terms of recovering M asymptotically, but for $\rho > 0$, M_2 is a strictly better approximation. Using the approximation in (15), we can therefore eliminate the less dominant terms of the off-diagonal matrix elements in (12) as stated below.

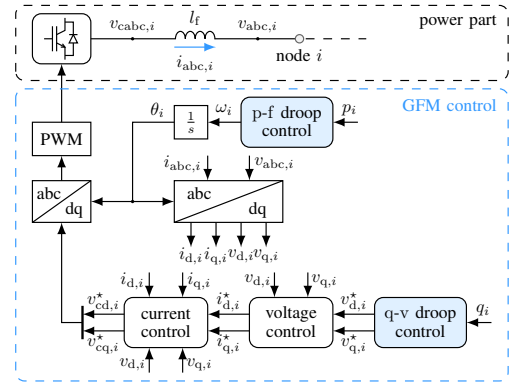

Fig. 3: Basic implementation of a three-phase GFM VSC.

Definition 4 (Dynamic Small-Signal Network Model). *The transfer matrix blocks for the dynamic (i.e., $s \neq 0$, $|v|_{0,i} \neq |v|_{0,j}$) small-signal network model in (11) used to derive the stability certificates in Section IV are given by:*

$$\begin{aligned} N_{ii}(s) &= \sum_{j \neq i}^n b_{ij} \frac{|v|_{0,i}^2}{1+(\rho+\frac{s}{\omega_0})^2} \begin{bmatrix} 1 & \frac{s}{\omega_0} \\ -\frac{s}{\omega_0} & 1 \end{bmatrix} \\ &\quad + \sum_{j \neq i}^n b_{ij} \frac{|v|_{0,i}^2 - |v|_{0,i}|v|_{0,j}}{1+\rho^2} \begin{bmatrix} -1 & 0 \\ 0 & 1 \end{bmatrix} \\ N_{ij}(s) &= b_{ij} \frac{|v|_{0,i}|v|_{0,j}}{1+(\rho+\frac{s}{\omega_0})^2} \begin{bmatrix} -1 & -\frac{s}{\omega_0} \\ \frac{s}{\omega_0} & -1 \end{bmatrix}. \end{aligned} \quad (17)$$

By setting $s = 0$ in (17), we derive the quasi-stationary network model, which is employed in a similar form in [9]:

Definition 5 (Network-Simplification Level 1). *The transfer matrix blocks for the quasi-stationary (i.e., $s = 0$, $|v|_{0,i} \neq |v|_{0,j}$) small-signal network model in (11) are given by:*

$$\begin{aligned} N_{ii}(s) &= \sum_{j \neq i}^n b_{ij} \frac{1}{1+\rho^2} \begin{bmatrix} |v|_{0,i}|v|_{0,j} & 0 \\ 0 & 2|v|_{0,i}^2 - |v|_{0,i}|v|_{0,j} \end{bmatrix} \\ N_{ij}(s) &= b_{ij} \frac{|v|_{0,i}|v|_{0,j}}{1+\rho^2} \begin{bmatrix} -1 & 0 \\ 0 & -1 \end{bmatrix}. \end{aligned} \quad (18)$$

To further simplify (18), we set $|v|_{0,i} = |v|_{0,j} = |v|_0$, yielding the zero-power flow network model similar to [10]:

Definition 6 (Network-Simplification Level 2). *The transfer matrix blocks for the zero-power flow (i.e., $s = 0$, $|v|_{0,i} = |v|_{0,j} = |v|_0$) small-signal network model in (11) are given by:*

$$\begin{aligned} N_{ii}(s) &= \sum_{j \neq i}^n b_{ij} \frac{|v|_0^2}{1+\rho^2} \begin{bmatrix} 1 & 0 \\ 0 & 1 \end{bmatrix} \\ N_{ij}(s) &= b_{ij} \frac{|v|_0^2}{1+\rho^2} \begin{bmatrix} -1 & 0 \\ 0 & -1 \end{bmatrix}. \end{aligned} \quad (19)$$

Remark 2. *For $\rho = 0$, the network model in [9] corresponds to (18) in Definition 5, while the model in [10] aligns with (19) in Definition 6. Moreover, other works [7], [8] focus solely on SISO frequency dynamics. Hence, our dynamic network model in (17) offers the most detailed representation in literature which is compatible with theoretical stability certificates.*

B. Grid-Forming Converter Dynamics

Fig. 3 shows the basic implementation of a GFM three-phase VSC connected to the power network in Fig. 2. The linearized small-signal dynamics (in the global per unit system)

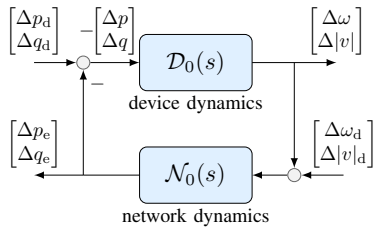

Fig. 4: Closed-loop power system dynamics where Δp_d and Δq_d are the active and reactive power disturbances, $\Delta\omega_d$ is the frequency disturbance, and $\Delta|v|_d$ is the voltage magnitude disturbance.

of the i -th VSC ($i \in \{1, \dots, n\}$) can be represented by the 2×2 transfer matrix $D_i(s)$, mapping from the active and reactive power injections $\Delta p_i(s)$ and $\Delta q_i(s)$ to the imposed frequency and voltage magnitude $\Delta\omega_i(s) = \Delta\delta_i(s)s$ and $\Delta|v|_i(s)$, i.e.,

$$-\begin{bmatrix} \Delta\omega_i(s) \\ \Delta|v|_i(s) \end{bmatrix} = D_i(s) \begin{bmatrix} \Delta p_i(s) \\ \Delta q_i(s) \end{bmatrix}. \quad (20)$$

The most prevalent GFM control strategy is filtered droop control [21]. Assuming time-scale separation, we can neglect the internal dynamics of the VSC (see Appendix II for a detailed derivation). Of course, all our developments will be evaluated on the full VSC model in Section V. We consider $D_i(s)$ as follows.

Definition 7 (Dynamic Small-Signal Converter Model). *The small-signal converter dynamics (20) used to derive the stability certificates in Section IV are given by the droop controller*

$$D_i(s) = \begin{bmatrix} \frac{d_{p,i}}{\tau_{p,i}s+1} & 0 \\ 0 & \frac{d_{q,i}}{\tau_{q,i}s+1} \end{bmatrix}, \quad (21)$$

where $d_{p,i} \in \mathbb{R}_{>0}$ and $d_{q,i} \in \mathbb{R}_{>0}$ are the active and reactive power droop gains, and $\tau_{p,i} \in \mathbb{R}_{\geq 0}$ and $\tau_{q,i} \in \mathbb{R}_{\geq 0}$ are the active and reactive power low-pass filter time constants.

Finally, if we extend (20) to include the dynamics of all n converters, we obtain the following $2n \times 2n$ transfer matrix

$$-\begin{bmatrix} \Delta\omega_1(s) \\ \Delta|v|_1(s) \\ \vdots \\ \Delta\omega_n(s) \\ \Delta|v|_n(s) \end{bmatrix} = \underbrace{\begin{bmatrix} D_1(s) & 0_{2 \times 2} & \dots & 0_{2 \times 2} \\ 0_{2 \times 2} & D_2(s) & \dots & 0_{2 \times 2} \\ \vdots & \vdots & \ddots & \vdots \\ 0_{2 \times 2} & 0_{2 \times 2} & \dots & D_n(s) \end{bmatrix}}_{=: D(s)} \underbrace{\begin{bmatrix} \Delta p_1(s) \\ \Delta q_1(s) \\ \vdots \\ \Delta p_n(s) \\ \Delta q_n(s) \end{bmatrix}}_{=: \begin{bmatrix} \Delta p(s) \\ \Delta q(s) \end{bmatrix}}. \quad (22)$$

C. Dynamic Power System Model

The closed-loop power system dynamics are modeled as the feedback interconnection of the converter device dynamics in (22) and the network dynamics in (11) as illustrated in Fig. 4. We focus on the stability of the bus frequency and voltage magnitudes, given by $\Delta\omega_i(s) = \Delta\delta_i(s)s$ and $\Delta|v|_i(s)$ for $i \in \{1, \dots, n\}$ and consider these quantities as interconnection signals between the device and network dynamics in Fig. 4. Accordingly, the interconnected subsystems are defined as:

$$\begin{aligned} D_0(s) &:= D(s) \\ \mathcal{N}_0(s) &:= N(s) \cdot \text{diag}\left(\frac{1}{s}, \frac{1}{|v|_{0,1}}, \dots, \frac{1}{s}, \frac{1}{|v|_{0,n}}\right). \end{aligned} \quad (23)$$

In the next section, we establish internal feedback stability of $D_0 \# \mathcal{N}_0$ under certain decentralized parametric conditions.

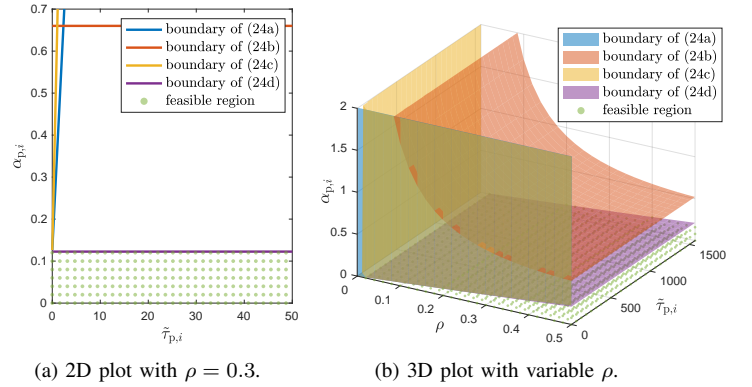

Fig. 5: Graphical illustration of the stability conditions in (24).

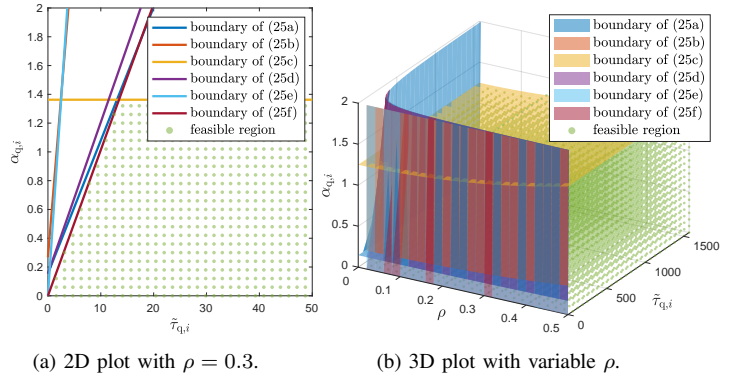

Fig. 6: Graphical illustration of the stability conditions in (25).

IV. DECENTRALIZED STABILITY CONDITIONS

By applying dynamic loop-shifting techniques and passivity theory (see Section IV-B for details), we derive parametric *decentralized stability conditions* that serve as *local tuning rules* for the dynamic droop control (21) of each VSC $i \in \{1, \dots, n\}$, ensuring the internal feedback stability of $D_0 \# \mathcal{N}_0$ in Fig. 4. The stability conditions for each VSC i depend on

- its own tunable local droop control parameters, namely, the droop gains $d_{p,i}$, $d_{q,i}$ and the time constants $\tau_{p,i}$, $\tau_{q,i}$,
- certain network parameters, including the susceptances of the neighboring lines b_{ij} , the resistance-to-inductance ratio ρ , and the maximum steady-state bus voltage magnitude $|v|_{\max}$. These parameters are either locally accessible or globally agreed upon, e.g., in grid codes.

Crucially, the conditions are local and entirely independent of the control parameters of other VSCs, making them directly applicable for scalable and decentralized stability assessment, as well as for local control tuning and grid-code design.

The decentralized stability conditions for each VSC i can be categorized into decoupled constraints on the active power-frequency droop control and the reactive power-voltage droop control. For each control scheme, these conditions can be visualized in either a two-dimensional (for fixed ρ) or a three-dimensional (for variable ρ) coordinate system, as shown in Figures 5 and 6. In these visualizations, the coordinate axes represent scaled versions of the tunable local droop gains and time constants (in 2D) and the global network parameter ρ (in 3D), with typical value ranges. The resulting feasible parameter sets are indicated by green dots. As illustrated in Fig. 5, for small values of the resistance-to-inductance ratio ρ , closed-loop stability is ensured when both the droop gain

$c_{l,\rho}$	Definition	$c_{l,\rho}$	Definition
$c_{1,\rho}$	$(1 + \rho^2)/(5 + 2\rho^2)$	$c_{8,\rho}$	$2\rho\omega_0(15 v _{\max}^2 + 4)(10\rho^2 v _{\max}^2 + 25 v _{\max}^2 + 4)$
$c_{2,\rho}$	$(1 + \rho^2)^2/(6\rho)$	$c_{9,\rho}$	$10\omega_0\rho^4 v _{\max}^2 + 95\omega_0\rho^2 v _{\max}^2 + 16\omega_0\rho^2 + 25\omega_0 v _{\max}^2$
$c_{3,\rho}$	$2\rho(1 + \rho^2)$	$c_{10,\rho}$	$5\omega_0(1 + \rho^2)(20\rho^3 v _{\max}^2 + 80\rho v _{\max}^2 + 16\rho)$
$c_{4,\rho}$	$((2\rho^2 - 5) + \sqrt{(5 - 2\rho^2)^2 + 16\rho^2})/4\rho$	$c_{11,\rho}$	$50\rho\omega_0(1 + \rho^2)^2$
$c_{5,\rho}$	$(1 + \rho^2)/(10\rho^2 v _{\max}^2 + 25 v _{\max}^2 + 4)$	$c_{12,\rho}$	$(\rho^2 + 1)^2/(6\rho v _{\max}^2)$
$c_{6,\rho}$	$5(1 + \rho^2)^2/(30\rho v _{\max}^2 + 8\rho)$	$c_{13,\rho}$	$-2\rho v _{\max}^4$
$c_{7,\rho}$	$5(1 + \rho^2)/4$	$c_{14,\rho}$	$ v _{\max}^2(2\rho^2 - 5)$

TABLE I: Definition of the quantities $c_{l,\rho}$ for $l = 1, \dots, 14$ in the conditions (24) and (25) depending on the parameter ρ .

$d_{p,i}$ and the self-susceptance $\sum_{j \neq i}^n b_{ij}$ are sufficiently small, irrespective of the time constant $\tau_{p,i}$. Notably, this suggests potential instability issues in future transmission systems with a *high* density of devices interconnected by *short lines*, which correspond to large values of $\sum_{j \neq i}^n b_{ij}$. Further, interpreting the filter time constant $\tau_{p,i}$ as virtual inertia reveals that increasing virtual inertia (i.e., larger $\tau_{p,i}$) does not necessarily enhance system stability. These findings align with the small-signal stability conditions derived for active power droop control in conjunction with SISO frequency dynamics in [8].

Similarly, Fig. 6 shows that closed-loop stability is guaranteed when both the droop gain $d_{q,i}$ and the self-susceptance $\sum_{j \neq i}^n b_{ij}$ are sufficiently small, provided that $\tau_{q,i}$ is nonzero. In particular, in contrast to $\tau_{p,i}$, a larger $\tau_{q,i}$ can be stabilizing.

Finally, from the 3D plots in Figures 5 and 6, it becomes apparent how an increasing resistance-inductance ratio ρ allows for larger local droop gains of both the active and reactive power droop control while maintaining stability.

In what follows, we provide an algebraic parametrization of the conditions in Figures 5 and 6 (a detailed derivation is provided in Section IV-B). Namely, for the active power-frequency droop control, we require

$$\alpha_{p,i} < c_{1\rho}(2\rho + \tilde{\tau}_{p,i}(1 + \rho^2)) \quad (24a)$$

$$\alpha_{p,i} < c_{2\rho} \quad (24b)$$

$$\alpha_{p,i} < c_{3\rho} \frac{\tilde{\tau}_{p,i}(\tilde{\tau}_{p,i}(1 + \rho^2) + 2\rho) + 1}{4\tilde{\tau}_{p,i}\rho(1 + \rho^2) + 2\rho^2 + 5} \quad (24c)$$

$$\alpha_{p,i} < c_{4\rho}, \quad (24d)$$

where $\alpha_{p,i} = d_{p,i}|v|_{\max}^2 \sum_{j \neq i}^n \frac{b_{ij}}{\omega_0}$, $\tilde{\tau}_{p,i} = \tau_{p,i}\omega_0$, and $c_{l\rho}$ for $l = \{1, 2, 3, 4\}$ are quantities depending on ρ as defined in Table I. For the reactive power-voltage droop control, we require

$$\alpha_{q,i} < c_{5,\rho}(5 + 10\rho\tilde{\tau}_{q,i}) \quad (25a)$$

$$\alpha_{q,i} < c_{6,\rho}(2\rho + \tilde{\tau}_{q,i}) \quad (25b)$$

$$\alpha_{q,i} < c_{7,\rho} \quad (25c)$$

$$0 < \alpha_{q,i}^2 c_{8\rho} - \alpha_{q,i}(5\tilde{\tau}_{q,i}(1 + \rho^2)c_{9,\rho} + c_{10,\rho}) + c_{11,\rho}(\tilde{\tau}_{q,i}^2(1 + \rho^2) + 2\rho\tilde{\tau}_{q,i} + 1) \quad (25d)$$

$$\alpha_{q,i} < c_{12,\rho}\tilde{\tau}_{q,i} \quad (25e)$$

$$0 < \alpha_{q,i}^2 c_{13,\rho} + \alpha_{q,i}\tilde{\tau}_{q,i}c_{14,\rho} + 2\tilde{\tau}_{q,i}^2\rho \quad (25f)$$

where $\alpha_{q,i} = d_{q,i} \sum_{j \neq i}^n b_{ij}$, $\tilde{\tau}_{q,i} = \tau_{q,i}\omega_0$, and $c_{l\rho}$ for $l = \{5, \dots, 14\}$ are quantities depending on ρ as defined in Table I.

Remark 3 (Plug-and-Play Operation). *The conditions in (24) and (25) are designed for the scenario where all n converter nodes are populated, ensuring system-level stability during disconnection and re-connection of VSCs. Specifically, removing any VSC decreases the self susceptance $\sum_{j \neq i}^n b_{ij}$ for each connected VSC i after Kron reduction and reindexing, thereby guaranteeing that (24) and (25) remain locally satisfied.*

A. Main Result

The conditions (24) and (25) are derived in Section IV-B, which proves our main result stated in the theorem below:

Theorem 2 (Internal Feedback Stability of the Closed-Loop System). *Consider the device and network dynamics $\mathcal{D}_0(s)$ and $\mathcal{N}_0(s)$ in (23), where the network model is given by (17). Let the conditions in (24) and (25) hold for each VSC $i \in \{1, \dots, n\}$. Then, the closed-loop system $\mathcal{D}_0 \# \mathcal{N}_0$ in Fig. 4 is internally feedback stable, i.e., $\mathcal{D}_0 \# \mathcal{N}_0 \in \mathcal{RH}_{\infty}^{4n \times 4n}$.*

Corollary 1 (Simplified Network Models). *For the quasi-stationary network dynamics $\mathcal{N}_0(s)$ with the network model in (18), where $s = 0$ and $|v|_{0,i} \neq |v|_{0,j}$, the stability result of Theorem 2 holds under the relaxed algebraic conditions¹*

$$\alpha_{q,i} < \frac{5(1 + \rho^2)}{4} = c_{7,\rho} \quad \text{and} \quad 0 < \tau_{p,i} \quad (26)$$

for each VSC $i \in \{1, \dots, n\}$. Further, for the zero-power-flow network dynamics $\mathcal{N}_0(s)$ with the network model in (19), where $s = 0$ and $|v|_{0,i} = |v|_{0,j}$, internal feedback stability is guaranteed without imposing any additional VSC conditions.

The proof of Corollary 1 is provided in Appendix III and follows a similar reasoning as the proof of Theorem 2 in Section IV-B, but applies the simplified network models in (18) and (19), respectively. It becomes apparent how the conditions in (24) and (25) are a subset of the conditions in (26).

B. Proof of Theorem 2

A structural overview of the proof of Theorem 2 is presented in the flowchart in Fig. 7 and consists of four main steps:

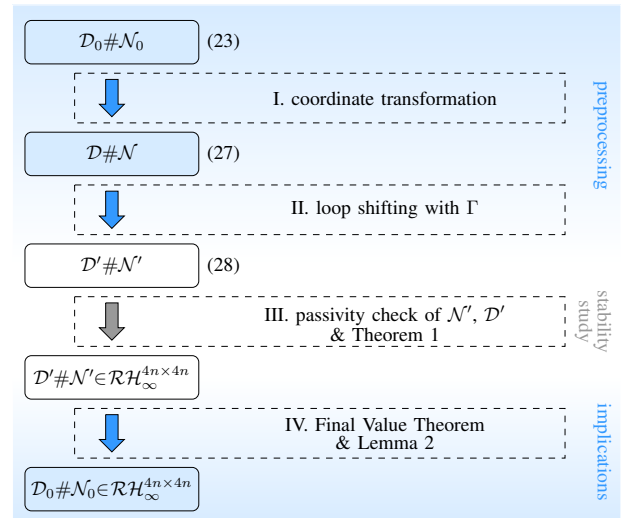

Fig. 7: Structural overview of the proof of Theorem 2.

¹These conditions structurally align with the conditions derived in [9].

1. Coordinate Transformation: To preserve the symmetry of the network, we use the angle and normalized voltage derivatives, defined as $\Delta\omega_i(s) := \Delta\delta_i(s)s$ and $\Delta|\tilde{v}|_{n,i}(s) := \Delta|v|_{n,i}(s)s$, as interconnection signals. We then analyze the stability of the closed-loop system as in Fig. 8a, where

$$\begin{aligned} \mathcal{D}(s) &:= D(s) \cdot \text{diag}\left(1, \frac{s}{|v|_{0,1}}, \dots, 1, \frac{s}{|v|_{0,n}}\right) \\ \mathcal{N}(s) &:= N(s) \cdot \text{diag}\left(\frac{1}{s}, \frac{1}{s}, \dots, \frac{1}{s}, \frac{1}{s}\right). \end{aligned} \quad (27)$$

II. Loop Shifting: Given that $\mathcal{D}(s)$ and $\mathcal{N}(s)$ in Fig. 8a do not satisfy the passivity conditions in Theorem 1 (i.e., it can be shown that $\mathcal{N}(s)$ is not passive), we resort to dynamic loop-shifting techniques as presented in Section II-C. More specifically, we consider the loop-shifted system $\mathcal{D}'\#\mathcal{N}'$ in Fig. 8b with the subsystems $\mathcal{D}'(s)$ and $\mathcal{N}'(s)$ given as

$$\begin{aligned} \mathcal{D}'(s) &:= \mathcal{D}(s)(I - \Gamma(s)\mathcal{D}(s))^{-1} \\ \mathcal{N}'(s) &:= \mathcal{N}(s) + \Gamma(s). \end{aligned} \quad (28)$$

We choose $\Gamma(s) = \text{diag}(\Gamma_1(s), \dots, \Gamma_n(s))$ as a block-diagonal semi-stable transfer matrix with the 2×2 matrix elements

$$\Gamma_i(s) = \begin{bmatrix} \Gamma_i^p(s) & 0 \\ 0 & \Gamma_i^q(s) \end{bmatrix}, \quad (29)$$

which are selected to ensure passivity of $\mathcal{N}'(s)$. Specifically,

$$\begin{aligned} \Gamma_i^p(s) &= \frac{1}{s} \left(\frac{\gamma_{1,i}^p \omega_0^2 s^2}{\omega_0^2 + (\rho\omega_0 + s)^2} + \frac{\gamma_{2,i}^p \omega_0^2}{\omega_0^2 + (\rho\omega_0 + s)^2} + \gamma_{3,i}^p \right) \\ \Gamma_i^q(s) &= \frac{1}{s} \left(\frac{\gamma_{1,i}^q \omega_0^2 s^2}{\omega_0^2 + (\rho\omega_0 + s)^2} + \frac{\gamma_{2,i}^q \omega_0^2}{\omega_0^2 + (\rho\omega_0 + s)^2} + \gamma_{3,i}^q \right) \end{aligned} \quad (30)$$

with the parameters

$$\begin{aligned} \gamma_{1,i}^p &= \gamma_{1,i}^q = \frac{2|v|_{\max}^2}{\omega_0^2} \sum_{j \neq i}^n b_{ij} \\ \gamma_{2,i}^p &= \gamma_{2,i}^q = -3|v|_{\max}^2 \sum_{j \neq i}^n b_{ij} \\ \gamma_{3,i}^p &= 3\frac{1}{1+\rho^2} \sum_{j \neq i}^n b_{ij} |v|_{\max}^2 \\ \gamma_{3,i}^q &= \frac{1}{1+\rho^2} \sum_{j \neq i}^n b_{ij} (3|v|_{\max}^2 + 0.8), \end{aligned} \quad (31)$$

whose structure loosely resembles the network model in (17).

III. Passivity Checks & Theorem 1: For $\Gamma(s)$ selected as in (29) to (31), we can show that $\mathcal{N}'(s)$ is passive², i.e., it satisfies the conditions (i) to (iii) in Definition 2:

(i) *Poles:* The poles of all elements of $\mathcal{N}'(s)$ are $p_1 = j0$ and $p_{2,3} = -\rho\omega_0 \pm j\omega_0$, i.e., $\text{Re}(p_k) \leq 0$ for $k \in \{1, 2, 3\}$.

(ii) *Positive semi-definiteness:* We can express the Hermitian matrix $\mathcal{S}_{\mathcal{N}'}(j\omega) := \mathcal{N}'(j\omega) + \mathcal{N}'^*(j\omega)$ as

$$\mathcal{S}_{\mathcal{N}'}(j\omega) = \begin{bmatrix} \mathcal{S}_{\mathcal{N}',11}(j\omega) & \dots & \mathcal{S}_{\mathcal{N}',1n}(j\omega) \\ \vdots & \ddots & \vdots \\ \mathcal{S}_{\mathcal{N}',n1}(j\omega) & \dots & \mathcal{S}_{\mathcal{N}',nn}(j\omega) \end{bmatrix}, \quad (32)$$

where each $\mathcal{S}_{\mathcal{N}',ij}$ represents a 2×2 transfer matrix block. The diagonal and off-diagonal elements are given by

$$\begin{aligned} \mathcal{S}_{\mathcal{N}',ii}(j\omega) &= h_\rho(\omega) \left(\sum_{j \neq i}^n |v|_{0,i}^2 b_{ij} \begin{bmatrix} -1 & -j\omega/\omega_0 \\ j\omega/\omega_0 & -1 \end{bmatrix} + \begin{bmatrix} \omega^2 \gamma_{1,i}^p - \gamma_{2,i}^p & 0 \\ 0 & \omega^2 \gamma_{1,i}^q - \gamma_{2,i}^q \end{bmatrix} \right) \\ \mathcal{S}_{\mathcal{N}',ij}(j\omega) &= h_\rho(\omega) |v|_{0,i} |v|_{0,j} b_{ij} \begin{bmatrix} 1 & j\omega/\omega_0 \\ -j\omega/\omega_0 & 1 \end{bmatrix}. \end{aligned} \quad (33)$$

²Notice that we can show passivity of $\mathcal{N}'(s)$ for the lossless case $\rho = 0$ by evaluating (29) to (31) at $\rho = 0$ accordingly.

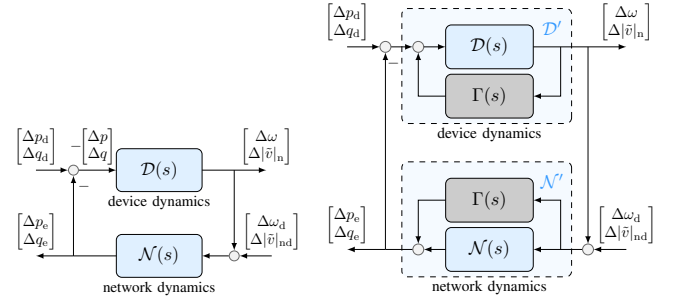

(a) Original feedback system.

(b) Loop-shifting with Γ .

Fig. 8: Closed-loop feedback interconnection for stability analysis.

Here, $h_\rho(\omega)$ is a positive function $\forall \omega \geq 0$ defined as

$$h_\rho(\omega) = 4\rho\omega_0^3 / ((\omega_0^2 + \rho^2\omega_0^2 - \omega^2)^2 + 4\rho^2\omega_0^2\omega^2) \geq 0. \quad (34)$$

We can observe that (32) is a Hermitian diagonally dominant matrix with real non-negative diagonal entries, i.e., the magnitude of the diagonal entry in a row is greater or equal to the sum of the magnitudes of the off-diagonal entries in that row. Namely, for the odd rows and $\forall \omega \geq 0$, we get

$$\begin{aligned} & \left| \sum_{j \neq i}^n -|v|_{0,i}^2 b_{ij} + \omega^2 \gamma_{1,i}^p - \gamma_{2,i}^p \right| \geq \\ & \left| \sum_{j \neq i}^n |v|_{0,i}^2 b_{ij} \frac{-j\omega}{\omega_0} + \sum_{j \neq i}^n \|v\|_{0,i} \|v\|_{0,j} b_{ij} + \sum_{j \neq i}^n \|v\|_{0,i} |v|_{0,j} b_{ij} \frac{j\omega}{\omega_0} \right| \\ \Leftrightarrow & \left| \sum_{j \neq i}^n -|v|_{\max}^2 b_{ij} + \omega^2 \gamma_{1,i}^p - \gamma_{2,i}^p \right| \geq \\ & 2 \sum_{j \neq i}^n |v|_{\max}^2 b_{ij} \frac{\omega}{\omega_0} + \sum_{j \neq i}^n |v|_{\max}^2 b_{ij} \\ \Leftrightarrow & \sum_{j \neq i}^n |v|_{\max}^2 b_{ij} \left(2 + \frac{2\omega^2}{\omega_0^2} \right) \geq \sum_{j \neq i}^n |v|_{\max}^2 b_{ij} \left(1 + \frac{2\omega}{\omega_0} \right), \end{aligned}$$

and similarly, for each even row and $\forall \omega \geq 0$, we have

$$\begin{aligned} & \left| \sum_{j \neq i}^n -|v|_{0,i}^2 b_{ij} + \omega^2 \gamma_{1,i}^q - \gamma_{2,i}^q \right| \geq \\ & \left| \sum_{j \neq i}^n |v|_{0,i}^2 b_{ij} \frac{j\omega}{\omega_0} + \sum_{j \neq i}^n \|v\|_{0,i} \|v\|_{0,j} b_{ij} \frac{-j\omega}{\omega_0} + \sum_{j \neq i}^n \|v\|_{0,i} |v|_{0,j} b_{ij} \right| \\ \Leftrightarrow & \left| \sum_{j \neq i}^n -|v|_{\max}^2 b_{ij} + \omega^2 \gamma_{1,i}^q - \gamma_{2,i}^q \right| \geq \\ & 2 \sum_{j \neq i}^n |v|_{\max}^2 b_{ij} \frac{\omega}{\omega_0} + \sum_{j \neq i}^n |v|_{\max}^2 b_{ij} \\ \Leftrightarrow & \sum_{j \neq i}^n |v|_{\max}^2 b_{ij} \left(2 + \frac{2\omega^2}{\omega_0^2} \right) \geq \sum_{j \neq i}^n |v|_{\max}^2 b_{ij} \left(1 + \frac{2\omega}{\omega_0} \right). \end{aligned}$$

By Lemma 1, we can conclude $\mathcal{N}'(j\omega) + \mathcal{N}'^*(j\omega) \succeq 0$.

(iii) *Imaginary poles:* For $\rho \neq 0$, $\mathcal{N}'(s)$ has one imaginary pole, i.e., $p_1 = j0$, which is a simple pole. We therefore compute the limit $\mathcal{R}_{j0}^{\mathcal{N}'} := \lim_{s \rightarrow j0} (s - j0)\mathcal{N}'(s)$, where each $\mathcal{R}_{j0,ij}^{\mathcal{N}'}$ represents a 2×2 transfer matrix block. The diagonal and off-diagonal elements are given by

$$\begin{aligned} \mathcal{R}_{j0,ii}^{\mathcal{N}'} &= \sum_{j \neq i}^n b_{ij} \begin{bmatrix} \frac{|v|_{0,i} |v|_{0,j}}{1+\rho^2} & 0 \\ 0 & \frac{2|v|_{0,i}^2 - |v|_{0,i} |v|_{0,j}}{1+\rho^2} \end{bmatrix} + \\ & \begin{bmatrix} \frac{\gamma_{2,i}^p}{1+\rho^2} + \gamma_{3,i}^p & 0 \\ 0 & \frac{\gamma_{2,i}^q}{1+\rho^2} + \gamma_{3,i}^q \end{bmatrix} \\ \mathcal{R}_{j0,ij}^{\mathcal{N}'} &= -b_{ij} \frac{|v|_{0,i} |v|_{0,j}}{1+\rho^2} \begin{bmatrix} 1 & 0 \\ 0 & 1 \end{bmatrix}. \end{aligned} \quad (35)$$

Again, (35) is a Hermitian diagonally dominant matrix with real non-negative diagonal entries. For the odd rows, we get

$$\begin{aligned} & \left| \sum_{j \neq i}^n b_{ij} \frac{|v|_{0,i} |v|_{0,j}}{1+\rho^2} + \frac{\gamma_{2,i}^p}{1+\rho^2} + \gamma_{3,i}^p \right| \geq \sum_{j \neq i}^n | -b_{ij} \frac{|v|_{0,i} |v|_{0,j}}{1+\rho^2} | \\ \Leftrightarrow & \sum_{j \neq i}^n b_{ij} \frac{|v|_{0,i} |v|_{0,j}}{1+\rho^2} \geq \sum_{j \neq i}^n b_{ij} \frac{|v|_{0,i} |v|_{0,j}}{1+\rho^2}. \end{aligned}$$

For the even rows we get (with $|v|_{\max} = 1.1$ and $|v|_{\min} = 0.9$):

$$\begin{aligned} & \left| \sum_{j \neq i}^n \frac{(2|v_{0,i}^2 - |v_{0,i}|v_{0,j}|)b_{ij}}{(1+\rho^2)} + \frac{\gamma_{2,i}^q}{1+\rho^2} + \gamma_{3,i}^q \right| \geq \sum_{j \neq i}^n |b_{ij}| \frac{|v_{0,i}|v_{0,j}|}{1+\rho^2} \\ & \Leftrightarrow \left| \sum_{j \neq i}^n \frac{(2|v_{0,i}^2 - |v_{0,i}|v_{0,j}| + 0.8)b_{ij}}{(1+\rho^2)} \right| \geq \sum_{j \neq i}^n |b_{ij}| \frac{|v_{0,i}|v_{0,j}|}{1+\rho^2} \\ & \Leftrightarrow \sum_{j \neq i}^n |b_{ij}| \frac{2|v_{0,i}^2 - |v_{0,i}|v_{0,j}|_{\max} + 0.8}{1+\rho^2} \geq \sum_{j \neq i}^n |b_{ij}| \frac{|v_{0,i}|v_{0,j}|_{\max}}{1+\rho^2} \end{aligned}$$

By Lemma 1, we conclude $\mathcal{R}_{j_0}^{\mathcal{N}'} \geq 0$.

Next, we derive the decentralized stability conditions in (24) and (25) under which $\mathcal{D}'(s)$ is strictly passive. We consider $\mathcal{D}'(s) = \text{diag}(\mathcal{D}'_1(s), \dots, \mathcal{D}'_n(s))$ with the matrix elements

$$\mathcal{D}'_i(s) = \mathcal{D}_i(s)(I - \Gamma_i(s)\mathcal{D}_i(s))^{-1} = \begin{bmatrix} \mathcal{D}'_{p,i}(s) & 0 \\ 0 & \mathcal{D}'_{q,i}(s) \end{bmatrix}, \quad (36)$$

where the diagonal transfer function elements are given as

$$\mathcal{D}'_{p,i}(s) = \frac{d_{p,i}}{\tau_{p,i}s + 1 - \Gamma_i^p(s)d_{p,i}} \quad (37a)$$

$$\mathcal{D}'_{q,i}(s) = \frac{d_{q,i}s}{\tau_{q,i}s + 1 - \Gamma_i^q(s)d_{q,i}s}, \quad (37b)$$

for each of which we check the strict passivity conditions (i) and (ii) in Definition 3 independently. We start with $\mathcal{D}'_{p,i}(s)$:

(i) *Poles*: To show that the poles of all elements of $\mathcal{D}'_{p,i}(s)$ are in $\text{Re}(s) < 0$, we start by inserting the expression for $\Gamma_i^p(s)$ in (30) into (37a) and obtain

$$\mathcal{D}'_{p,i}(s) = d_{p,i} \frac{s^2 b_{2,i} + s b_{1,i} + b_{0,i}}{s^3 a_{3,i} + s^2 a_{2,i} + s a_{1,i} + a_{0,i}}, \quad (38)$$

where the transfer function coefficients are given by

$$\begin{aligned} a_{0,i} &= \omega_0^2(\rho^4 + 2\rho^2 - 6\rho\alpha_{p,i} + 1) \\ a_{1,i} &= \omega_0(\tilde{\tau}_{p,i}\rho^4 + 2\rho^3 + 2\rho^2\tilde{\tau}_{p,i}) & b_{0,i} &= \omega_0^2(1 + \rho^2)^2 \\ & - 2\rho^2\alpha_{p,i} + 2\rho - 5\alpha_{p,i} + \tilde{\tau}_{p,i}) & b_{1,i} &= 2\rho\omega_0(1 + \rho^2) \\ a_{2,i} &= (1 + \rho^2)(2\tilde{\tau}_{p,i}\rho + 1) & b_{2,i} &= 1 + \rho^2 \\ a_{3,i} &= \tau_{p,i}(1 + \rho^2) \end{aligned} \quad (39)$$

By checking the Hurwitz criterion for a 3rd order polynomial, we can conclude that $a_{3,i} > 0$ and $a_{2,i} > 0$ are always satisfied, while $a_{1,i} > 0$ is ensured by condition (24a), $a_{0,i} > 0$ by condition (24b), and $a_{2,i}a_{1,i} > a_{0,i}a_{3,i}$ by condition (24c).

(ii) *Positive definiteness*: To ensure $\mathcal{D}'_{p,i}(j\omega) + \mathcal{D}'_{p,i}^*(j\omega) \succ 0$, we require the additional condition (24d).

Following the same reasoning, we derive the decentralized stability conditions³ for the reactive power-voltage droop control presented in (25) by checking strict passivity of $\mathcal{D}'_{q,i}(s)$.

Finally, since $\mathcal{N}'(s)$ is passive and $\mathcal{D}'(s)$ is strictly passive, we can apply Theorem 1 and conclude $\mathcal{D}' \# \mathcal{N}' \in \mathcal{RH}_{\infty}^{4n \times 4n}$.

IV. Final Value Theorem & Lemma 2: The internal feedback stability of the original system $\mathcal{D}_0 \# \mathcal{N}_0$ follows directly from the internal feedback stability of the loop-shifted system $\mathcal{D}' \# \mathcal{N}'$, as stated in the following lemma.

Lemma 4. Consider the device and network dynamics $\mathcal{D}'(s)$ and $\mathcal{N}'(s)$ in (28), as well as $\mathcal{D}_0(s)$ and $\mathcal{N}_0(s)$ in (23) with the network model (17). Then, internal feedback stability of $\mathcal{D}' \# \mathcal{N}'$ implies internal feedback stability of $\mathcal{D}_0 \# \mathcal{N}_0$.

Proof. We first conclude that $\mathcal{D}' \# \mathcal{N}' \in \mathcal{RH}_{\infty}^{4n \times 4n}$ implies $(I + \mathcal{D}'\mathcal{N}')^{-1}\mathcal{D}' = (I + \mathcal{D}\mathcal{N})^{-1}\mathcal{D} \in \mathcal{RH}_{\infty}^{4n \times 4n}$. Further, since

$$\begin{aligned} \mathcal{D}(s) &= \mathcal{D}_0(s) \cdot \text{diag}\left(1, \frac{s}{|v_{0,1}|}, \dots, 1, \frac{s}{|v_{0,n}|}\right) \\ \mathcal{N}(s) &= \mathcal{N}_0(s) \cdot \text{diag}\left(1, \frac{|v_{0,1}|}{s}, \dots, 1, \frac{|v_{0,n}|}{s}\right), \end{aligned} \quad (40)$$

³The requirement $\tau_{q,i} \neq 0$ in (25) ensures properness of $\mathcal{D}'_{q,i}(s)$.

$(I + \mathcal{D}\mathcal{N})^{-1}\mathcal{D} = \text{diag}\left(1, \frac{s}{|v_{0,1}|}, \dots, 1, \frac{s}{|v_{0,n}|}\right)(I + \mathcal{D}_0\mathcal{N}_0)^{-1}\mathcal{D}_0$, and we can thus conclude stability of $(I + \mathcal{D}_0\mathcal{N}_0)^{-1}\mathcal{D}_0$ if the step response of the voltage derivatives converges to zero, i.e.,

$$\lim_{s \rightarrow 0} s \frac{1}{s} (I + \mathcal{D}(s)\mathcal{N}(s))^{-1}\mathcal{D}(s) = I \otimes \begin{bmatrix} \star & 0 \\ 0 & 0 \end{bmatrix}. \quad (41)$$

To show that (41) holds, we first rewrite the transfer matrix $(I + \mathcal{D}\mathcal{N})^{-1}\mathcal{D} = (I + \mathcal{D}\mathcal{N}\frac{1}{s})^{-1}\mathcal{D}$, and then use the row permutation matrix $\mathcal{P} \in \mathbb{R}^{2n \times 2n}$ with elements

$$\mathcal{P}_{ij} = \begin{cases} 1 & i = k, j = 2k - 1, 1 \leq k \leq n \\ 1 & i = k + n, j = 2k, 1 \leq k \leq n \\ 0 & \text{else,} \end{cases} \quad (42)$$

to study the decoupled frequency and voltage dynamics, i.e., $\mathcal{P}(I + \mathcal{D}\mathcal{N}\frac{1}{s})^{-1}\mathcal{D}\mathcal{P}^{-1} = (I + \mathcal{D}^{\mathcal{P}}\mathcal{N}^{\mathcal{P}}\frac{1}{s})^{-1}\mathcal{D}^{\mathcal{P}}$. The row-permuted matrices $\mathcal{D}^{\mathcal{P}}(s)$ and $\mathcal{N}^{\mathcal{P}}(s)$ are given as

$$\mathcal{D}^{\mathcal{P}}(s) = \begin{bmatrix} \mathcal{D}_p^{\mathcal{P}}(s) & 0_{n \times n} \\ 0_{n \times n} & \mathcal{D}_q^{\mathcal{P}}(s) \end{bmatrix}, \quad \mathcal{N}^{\mathcal{P}}(s) = \begin{bmatrix} N_1^{\mathcal{P}}(s) & N_2^{\mathcal{P}}(s) \\ -N_2^{\mathcal{P}}(s) & N_3^{\mathcal{P}}(s) \end{bmatrix} \quad (43)$$

where $\mathcal{D}_p^{\mathcal{P}}(s) = \text{diag}(\mathcal{D}_{p,1}(s), \dots, \mathcal{D}_{p,n}(s))$ and $\mathcal{D}_q^{\mathcal{P}}(s) = \text{diag}(\mathcal{D}_{q,1}(s), \dots, \mathcal{D}_{q,n}(s))$ with elements

$$\mathcal{D}_{p,i}(s) = \frac{d_{p,i}}{\tau_{p,i}s + 1} \quad \text{and} \quad \mathcal{D}_{q,i}(s) = \frac{d_{q,i}s}{\tau_{q,i}s + 1} \frac{1}{|v_{0,i}|}. \quad (44)$$

Moreover, we have

$$\begin{aligned} N_{1,ii}^{\mathcal{P}}(s) &= \sum_{j \neq i}^n |b_{ij}| \frac{|v_{0,i}^2|}{1 + (\rho + \frac{s}{\omega_0})^2} - \sum_{j \neq i}^n |b_{ij}| \frac{|v_{0,i}^2 - |v_{0,i}|v_{0,j}|}{1 + \rho^2} \\ N_{1,ij}^{\mathcal{P}}(s) &= -|b_{ij}| \frac{|v_{0,i}|v_{0,j}|}{1 + (\rho + \frac{s}{\omega_0})^2} \\ N_{2,ii}^{\mathcal{P}}(s) &= \sum_{j \neq i}^n |b_{ij}| \frac{|v_{0,i}^2|}{1 + (\rho + \frac{s}{\omega_0})^2} \frac{s}{\omega_0} \\ N_{2,ij}^{\mathcal{P}}(s) &= -|b_{ij}| \frac{|v_{0,i}|v_{0,j}|}{1 + (\rho + \frac{s}{\omega_0})^2} \frac{s}{\omega_0} \\ N_{3,ii}^{\mathcal{P}}(s) &= \sum_{j \neq i}^n |b_{ij}| \frac{|v_{0,i}^2|}{1 + (\rho + \frac{s}{\omega_0})^2} + \sum_{j \neq i}^n |b_{ij}| \frac{|v_{0,i}^2 - |v_{0,i}|v_{0,j}|}{1 + \rho^2} \\ N_{3,ij}^{\mathcal{P}}(s) &= -|b_{ij}| \frac{|v_{0,i}|v_{0,j}|}{1 + (\rho + \frac{s}{\omega_0})^2}. \end{aligned} \quad (45)$$

Recalling that $(I + \mathcal{D}\mathcal{N})^{-1}\mathcal{D}$ is stable, and thus its permuted version, we can apply the Final Value Theorem (FVT):

$$\begin{aligned} & \lim_{s \rightarrow 0} (I + \mathcal{D}^{\mathcal{P}}(s)\mathcal{N}^{\mathcal{P}}(s)\frac{1}{s})^{-1}\mathcal{D}^{\mathcal{P}}(s) \\ &= \lim_{s \rightarrow 0} (sI + \mathcal{D}^{\mathcal{P}}(s)\mathcal{N}^{\mathcal{P}}(s))^{-1}\mathcal{D}^{\mathcal{P}}(s)s \\ &= \lim_{s \rightarrow 0} \begin{bmatrix} (sI + \mathcal{D}_p^{\mathcal{P}}(s)N_1^{\mathcal{P}}(s))^{-1}\mathcal{D}_p^{\mathcal{P}}(s)s & \\ & 0_{n \times n} \\ & & (sI + \mathcal{D}_q^{\mathcal{P}}(s)N_4^{\mathcal{P}}(s))^{-1}\mathcal{D}_q^{\mathcal{P}}(s)s \end{bmatrix} \\ &= \begin{bmatrix} \star_{n \times n} & 0_{n \times n} \\ 0_{n \times n} & 0_{n \times n} \end{bmatrix}, \end{aligned} \quad (46)$$

where for the second equality we have used $N_2^{\mathcal{P}}(0) = 0$. The last equality follows from the fact that $N_1^{\mathcal{P}}(0)$ is a Laplacian matrix with zero eigenvalue [22], while $N_4^{\mathcal{P}}(0)$ is a regular matrix which does not have a zero eigenvalue. Given (46), (41) follows, and thus $(I + \mathcal{D}_0\mathcal{N}_0)^{-1}\mathcal{D}_0 \in \mathcal{RH}_{\infty}^{2n \times 2n}$.

Finally, since $\mathcal{D}_0(s)$ does not include a RHP pole or zero, there are no RHP pole-zero cancellations between $\mathcal{D}_0(s)$ and $\mathcal{N}_0(s)$. By Lemma 2, we conclude $\mathcal{D}_0 \# \mathcal{N}_0 \in \mathcal{RH}_{\infty}^{4n \times 4n}$. \square

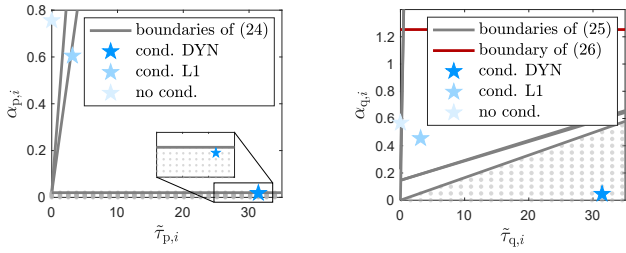

(a) Stability conditions in (24).

(b) Stability conditions in (25).

Fig. 9: 2D plot of the stability conditions for the three-node system with $\rho = 0.05$. The stars indicate the feasibility of the GFM 3 control parameters.

V. NUMERICAL CASE STUDIES

A. Case Study I: Linearized & reduced models

We numerically validate Theorem 2 and Corollary 1 with MATLAB/Simulink using linearized small-signal models of a three-node system with three GFM VSCs. We consider a network with uniform resistance-inductance ratio $\rho = 0.05$, a maximum steady-state voltage magnitude $|v|_{\max} = 1.1$ pu, and identical self susceptances $\sum_{i \neq j}^3 b_{ij} = 5$ pu of all VSC nodes $i \in \{1, 2, 3\}$. The simulations follow the ideal (i.e., linearized and reduced) block diagram dynamics in Fig. 4. The nodes GFM 1 and GFM 2 employ fixed controllers that always satisfy the conditions in (24) and (25), while for node GFM 3 we are exploring varying control parameters.

We begin by modeling the network dynamics $\mathcal{N}_0(s)$ using Network-Simplification Level 2 in (19), without imposing additional conditions on the controller of GFM 3 (see “no cond.” in Fig. 9). A small-signal load disturbance at node 1 reveals that the closed-loop system remains stable (Fig. 10), confirming the validity of Corollary 1. Likewise, when modeling $\mathcal{N}_0(s)$ with Network-Simplification Level 1 in (18) and ensuring that the controller of GFM 3 satisfies the stability conditions in (26) (see “cond. L1” in Fig. 9), we again observe closed-loop stability (Fig. 11). This further confirms Corollary 1. Our main result, Theorem 2, is validated in Fig. 12, where we model $\mathcal{N}_0(s)$ dynamically as in (17), and equip GFM 3 with a controller that meets the stability conditions in (24) and (25) (see “cond. DYN” in Fig. 9). Stability is immediately evident. In contrast, using a GFM 3 controller that satisfies only (26) (“cond. L1”) or no conditions at all (“no cond.”) leads to instability in the dynamic network model. This underscores the importance of accurate network modeling in control design, which is overlooked in the overly optimistic stability assessment of [7], [9], [10].

B. Case Study II: Nonlinear circuit model

For the same 3-node system as in Section V-A, we now use Simscape Electrical in MATLAB/Simulink to perform a detailed electromagnetic transients (EMT) simulation based on a nonlinear circuit model of the three-phase network. Additionally, for each GFM VSC, we incorporate the full nonlinear converter models as shown in Fig. 3. Compared to Case Study I, this increases complexity in two key aspects: first, by considering nonlinear models, and second, by accounting for the full network dynamics without the simplifying assumptions introduced in Section III-A. The simulation results in Fig. 13 demonstrate that a GFM 3 controller satisfying the decentralized stability conditions in (24) and (25) ensures stability even

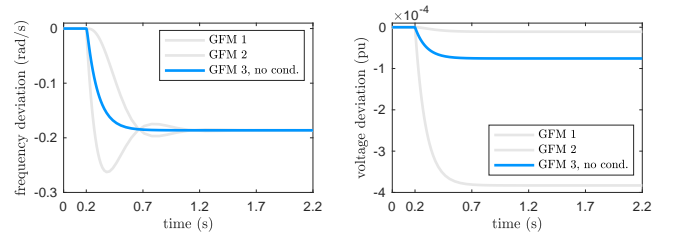

Fig. 10: Stable system response of the block diagram in Fig. 4 with three GFM devices and the simplified network model (19), where the controller of GFM 3 does not satisfy any of the conditions (24) to (26) (no cond.).

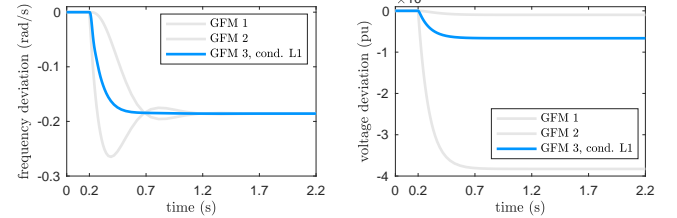

Fig. 11: Stable system response of the block diagram in Fig. 4 with three GFM devices and the simplified network model (18), where the GFM 3 controller satisfies the conditions in (26) (cond. L1).

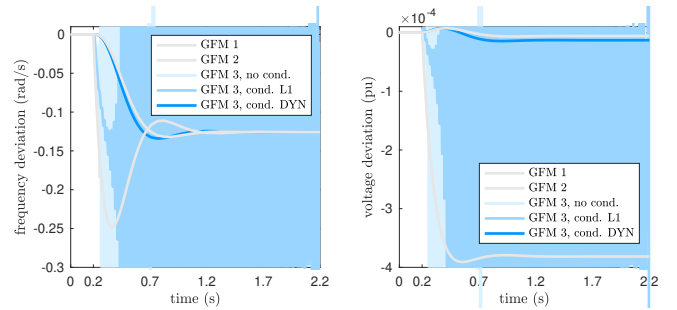

Fig. 12: Stable system response of the block diagram in Fig. 4 with three GFM devices and the dynamic network model (17), where all GFM controllers are satisfying the conditions in (24) and (25) (cond. DYN). We also display the unstable dynamics of GFM 3 when the controller is satisfying no conditions (no cond.), and when it is satisfying the conditions in (26) (cond. L1).

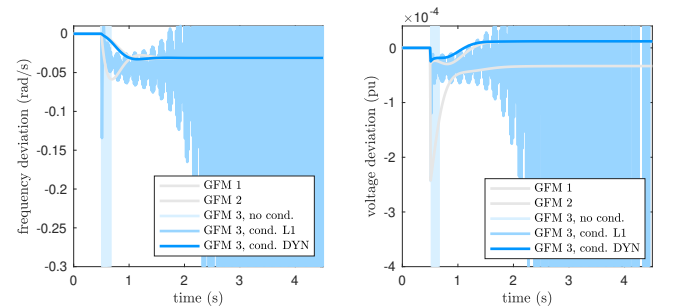

Fig. 13: Stable system response of the three-node converter system with nonlinear circuit and device models, in case all GFM controllers are satisfying the conditions in (24) and (25) (cond. DYN). Additionally, we indicate the unstable dynamics of GFM 3 when the controller is satisfying no conditions (no cond.), and when it is satisfying the conditions in (26) (cond. L1).

in the presence of nonlinear network and device models. In contrast, when the GFM 3 controller satisfies only (26) or does not meet any stability conditions, interactions with the network dynamics can lead to instability. Overall, we conclude that our stability conditions in (24) and (25), which explicitly account for network dynamics, remain effective in a nonlinear circuit scenario, provided the system operates near the nominal point where linearization errors are sufficiently small. However, the stability conditions, designed for a simplified static network, may fail when network dynamics are taken into account.

VI. CONCLUSION

We proposed a decentralized small-signal stability certification framework to mitigate the destabilizing effects of network dynamics on grid-forming converters. Using dynamic loop-shifting techniques and passivity theory, we derived parametric stability conditions that can serve as local tuning rules for device-level controllers, eliminating the need for centralized coordination. Our numerical case studies validated our theoretical results even for non-linear circuit and device models.

Future work includes the extension of our dynamic loop-shifting framework to a non-diagonal structure of the matrix blocks $\Gamma_i(s)$ with cross-coupling between active and reactive power, thereby eventually reducing conservatism by requesting coupled device controllers. Beyond that, from an application point of view, we envision our stability framework to support the formulation of new grid codes for future power systems.

REFERENCES

- [1] F. Milano, F. Dörfler, G. Hug, D. J. Hill, and G. Verbič, "Foundations and challenges of low-inertia systems," in *2018 power systems computation conference (PSCC)*. IEEE, 2018, pp. 1–25.
- [2] "900 MW fault induced solar photovoltaic resource interruption disturbance report: Southern california event: Oct. 9, 2017," NERC Joint and WECC Staff, Tech. Rep., 2018.
- [3] Y. Cheng, L. Fan, J. Rose, S.-H. Huang, J. Schmall, X. Wang, X. Xie, J. Shair, J. R. Ramamurthy, N. Modi *et al.*, "Real-world subsynchronous oscillation events in power grids with high penetrations of inverter-based resources," *IEEE Trans. Power Syst.*, vol. 38, no. 1, pp. 316–330, 2022.
- [4] J. Matevosyan, B. Badrzadeh, T. Prevost, E. Quitmann, D. Ramasubramanian, H. Urdal, S. Achilles, J. MacDowell, S. H. Huang, V. Vital *et al.*, "Grid-forming inverters: Are they the key for high renewable penetration?" *IEEE Power and Energy magazine*, vol. 17, no. 6, pp. 89–98, 2019.
- [5] D. Groß, M. Colombino, J.-S. Brouillon, and F. Dörfler, "The effect of transmission-line dynamics on grid-forming dVOC," *IEEE Trans. Control Netw. Syst.*, vol. 6, no. 3, pp. 1148–1160, 2019.
- [6] U. Markovic, O. Stanojevic, P. Aristidou, E. Vrettos, D. Callaway, and G. Hug, "Understanding small-signal stability of low-inertia systems," *IEEE Trans. Power Syst.*, vol. 36, no. 5, pp. 3997–4017, 2021.
- [7] R. Pates and E. Mallada, "Robust scale-free synthesis for frequency control in power systems," *IEEE Trans. Control Netw. Syst.*, vol. 6, no. 3, pp. 1174–1184, 2019.
- [8] D. Groß, "Compensating network dynamics in grid-forming control," in *2022 58th Annual Allerton Conference on Communication, Control, and Computing (Allerton)*, 2022, pp. 1–8.
- [9] Z. Siahhaan, E. Mallada, and S. Geng, "Decentralized stability criteria for grid-forming control in inverter-based power systems," in *2024 IEEE Power & Energy Society General Meeting*. IEEE, 2024, pp. 1–5.
- [10] J. D. Watson and I. Lestas, "Control of interlinking converters in hybrid ac/dc grids: Network stability and scalability," *IEEE Trans. Power Syst.*, vol. 36, no. 1, pp. 769–780, 2020.
- [11] I. Subotić, D. Groß, M. Colombino, and F. Dörfler, "A Lyapunov framework for nested dynamical systems on multiple time scales with application to converter-based power systems," *IEEE Trans. Autom. Control*, vol. 66, no. 12, pp. 5909–5924, 2021.
- [12] L. Huang, D. Wang, X. Wang, H. Xin, P. Ju, K. H. Johansson, and F. Dörfler, "Gain and phase: Decentralized stability conditions for power electronics-dominated power systems," *IEEE Trans. Power Syst.*, 2024.
- [13] R. A. Horn and C. R. Johnson, *Matrix analysis*. Cambridge university press, 2012.
- [14] W. Chen, D. Wang, S. Z. Khong, and L. Qiu, "A phase theory of MIMO LTI systems," *arXiv:2105.03630*, 2021.
- [15] S. Skogestad and I. Postlethwaite, *Multivariable feedback control: analysis and design*. John Wiley & sons, 2005.
- [16] J. C. Willems, "Dissipative dynamical systems part ii: Linear systems with quadratic supply rates," *Archive for rational mechanics and analysis*, vol. 45, pp. 352–393, 1972.
- [17] J. Bao and P. L. Lee, *Process control: the passive systems approach*. Springer Science & Business Media, 2007.
- [18] K. K. Hassan *et al.*, "Nonlinear systems," *Department of Electrical and computer Engineering, Michigan State University*, 2002.
- [19] F. Dörfler and F. Bullo, "Kron reduction of graphs with applications to electrical networks," *IEEE Trans. Circuits Syst. I*, vol. 60, no. 1, pp. 150–163, 2012.
- [20] P. Kundur, *Power System Stability and Control*. McGraw-Hill, 1994.
- [21] J. Rocabert, A. Luna, F. Blaabjerg, and P. Rodriguez, "Control of power converters in ac microgrids," *IEEE Trans. Power Electron.*, vol. 27, no. 11, pp. 4734–4749, 2012.
- [22] F. Paganini and E. Mallada, "Global analysis of synchronization performance for power systems: Bridging the theory-practice gap," *IEEE Trans. Autom. Control*, vol. 65, no. 7, pp. 3007–3022, 2019.



Verena Häberle is a Ph.D. student with the Automatic Control Laboratory at ETH Zurich, Switzerland, working under the supervision of Professor Florian Dörfler since June 2020. She received the B.Sc. and M.Sc. degree in electrical engineering and information technology from ETH Zurich, in 2018 and 2020, respectively. In fall 2024, she has been a visiting student researcher at the California Institute of Technology supervised by Professor Steven Low. Her research focuses on dynamic ancillary services provision, dynamic virtual power plant control, and data-driven converter control.



Xiuqiang He received his B.S. degree and Ph.D. degree in control science and engineering from Tsinghua University, China, in 2016 and 2021, respectively. Since 2021, he has been a Postdoctoral Researcher and was later promoted to a Senior Scientist at ETH Zürich, Switzerland. His current research interests include power system dynamics, stability, and control. Dr. He was the recipient of the Beijing Outstanding Graduates Award and the Outstanding Doctoral Dissertation Award from Tsinghua University.



Linbin Huang received the B.Eng. and Ph.D. degrees from Zhejiang University, Hangzhou, China, in 2015 and 2020, respectively. Currently, he is a ZJU100 Young Professor at Zhejiang University, Hangzhou, China. From 2020 to 2024, he was a Postdoctoral Researcher with promotion to a Senior Scientist at ETH Zürich, Switzerland. His research interests include power system stability as well as optimal and data-driven control of power electronics.



Florian Dörfler is a Full Professor at the Automatic Control Laboratory at ETH Zürich. He received his Ph.D. degree in Mechanical Engineering from the University of California at Santa Barbara in 2013, and a Diplom degree in Engineering Cybernetics from the University of Stuttgart in 2008. From 2013 to 2014 he was an Assistant Professor at the University of California Los Angeles. His primary research interests are centered around control, optimization, and system theory with applications in network systems, in particular electric power grids. He is a recipient of the distinguished young research awards by IFAC (Manfred Thoma Medal 2020) and EUCA (European Control Award 2020).

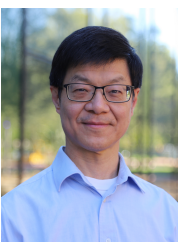

Steven Low is the Gilloon Professor of the Computing & Mathematical Sciences Department and Electrical Engineering Department at Caltech. Before that, he was with AT&T Bell Laboratories, Murray Hill, NJ, and the University of Melbourne, Australia. He has held honorary/chaired professorship in Australia, China and Taiwan. He was a co-recipient of IEEE best paper awards, an awardee of the IEEE Koji Kobayashi Computers and Communications Award, the IEEE INFOCOM Achievement Award and the ACM SIGMETRICS Test of Time Award, and is a Fellow of IEEE, ACM, and CSEE. He is known for work on Internet congestion control and semidefinite relaxation of optimal power flow problems in smart grid. He received his B.S. from Cornell and PhD from Berkeley, both in EE.

APPENDIX I DYNAMIC SMALL-SIGNAL NETWORK MODEL

To derive the dynamic network model $N(s)$ in (11), we linearize (8) and (10) around the equilibrium $v_{d0,i}$, $v_{q0,i}$, $i_{d0,i}$, $i_{q0,i}$ and transform them into the frequency domain, i.e.,

$$\begin{aligned}\Delta|v|_i(s) &\approx \frac{v_{d0,i}}{|v|_{0,i}} \Delta v_{d,i}(s) + \frac{v_{q0,i}}{|v|_{0,i}} \Delta v_{q,i}(s) \\ \Delta\delta_i(s) &\approx -\frac{v_{q0,i}}{|v|_{0,i}^2} \Delta v_{d,i}(s) + \frac{v_{d0,i}}{|v|_{0,i}^2} \Delta v_{q,i}(s) \\ \Delta p_i(s) &\approx v_{d0,i} \Delta i_{d,i}(s) + i_{d0,i} \Delta v_{d,i}(s) \\ &\quad + v_{q0,i} \Delta i_{q,i}(s) + i_{q0,i} \Delta v_{q,i}(s) \\ \Delta q_i(s) &\approx -v_{d0,i} \Delta i_{q,i}(s) - i_{q0,i} \Delta v_{d,i}(s) \\ &\quad + v_{q0,i} \Delta i_{d,i}(s) + i_{d0,i} \Delta v_{q,i}(s)\end{aligned}\quad (47)$$

By using (6), and inserting the steady-state expressions

$$\begin{aligned}i_{d0,i} &= \sum_{i \neq j}^n b_{ij} \frac{1}{1+\rho^2} [\rho(v_{d0,i} - v_{d0,j}) + (v_{q0,i} - v_{q0,j})] \\ i_{q0,i} &= \sum_{i \neq j}^n b_{ij} \frac{1}{1+\rho^2} [-(v_{d0,i} - v_{d0,j}) + \rho(v_{q0,i} - v_{q0,j})]\end{aligned}\quad (48)$$

and the steady-state bus voltages

$$\begin{aligned}v_{d0,i} &= |v|_{0,i} \cos \delta_{0,i}, & v_{d0,j} &= |v|_{0,j} \cos \delta_{0,j} \\ v_{q0,i} &= |v|_{0,i} \sin \delta_{0,i}, & v_{q0,j} &= |v|_{0,j} \sin \delta_{0,j}\end{aligned}\quad (49)$$

into (47), we can derive the small-signal dynamics $N(s)$ of the power network in polar coordinates as in (11) and (12).

APPENDIX II DYNAMIC SMALL-SIGNAL CONVERTER MODEL

To derive the transfer matrix $D_i(s)$, we start by considering the small-signal dynamics of the filter's equations

$$\begin{aligned}\Delta v_{cd,i}(s) &= \frac{l_{f,i}}{\omega_0} s \Delta i_{d,i}(s) - l_{f,i} \Delta i_{q,i}(s) + \Delta v_{d,i}(s) \\ \Delta v_{cq,i}(s) &= l_{f,i} \Delta i_{d,i}(s) + \frac{l_{f,i}}{\omega_0} s \Delta i_{q,i}(s) + \Delta v_{q,i}(s),\end{aligned}\quad (50)$$

where the converter's local dq frame is given by the active power-frequency droop control with small-signal dynamics

$$\Delta\delta_i(s) = \frac{\Delta\omega_i(s)}{s} = -\frac{1}{s} \frac{d_{p,i}}{\tau_{p,i}s+1} \Delta p_i(s),\quad (51)$$

where $d_{p,i} \in \mathbb{R}$ is the active power droop gain and $\tau_{p,i} \in \mathbb{R}$ the low-pass filter time constant. The small-signal dynamic equations of the current control loop are given by

$$\begin{aligned}\Delta v_{cd,i}^*(s) &= \text{PI}_{cc,i}(s) (\Delta i_{d,i}^*(s) - \Delta i_{d,i}(s)) \\ &\quad + \Delta v_{d,i}(s) - l_{f,i} \Delta i_{q,i}(s) \\ \Delta v_{cq,i}^*(s) &= \text{PI}_{cc,i}(s) (\Delta i_{q,i}^*(s) - \Delta i_{q,i}(s)) \\ &\quad + \Delta v_{q,i}(s) + l_{f,i} \Delta i_{d,i}(s),\end{aligned}\quad (52)$$

where $\text{PI}_{cc,i}(s)$ is the transfer function of the PI regulator. The current reference $\Delta i_{dq,i}^*(s)$ in (52) comes from the voltage control loop with small-signal dynamics

$$\begin{aligned}\Delta i_{d,i}^*(s) &= \text{PI}_{vc,i}(s) (\Delta v_{d,i}^*(s) - \Delta v_{d,i}(s)) \\ \Delta i_{q,i}^*(s) &= \text{PI}_{vc,i}(s) (\Delta v_{q,i}^*(s) - \Delta v_{q,i}(s)).\end{aligned}\quad (53)$$

The voltage reference in (53) is given by the reactive power-voltage droop control with the small-signal dynamics

$$\Delta v_{d,i}^*(s) = -\frac{d_{q,i}}{\tau_{q,i}s+1} \Delta q_i(s), \quad \Delta v_{q,i}^*(s) = 0,\quad (54)$$

where $d_{q,i} \in \mathbb{R}$ is the reactive power droop gain and $\tau_{q,i} \in \mathbb{R}$ the low-pass filter time constant. Finally, we insert the expressions in (50) to (54) into the small-signal power injections

$$\begin{aligned}\Delta p_i(s) &\approx v_{d0,i} \Delta i_{d,i}(s) + i_{d0,i} \Delta v_{d,i}(s) + i_{q0,i} \Delta v_{q,i}(s) \\ \Delta q_i(s) &\approx -v_{d0,i} \Delta i_{q,i}(s) - i_{q0,i} \Delta v_{d,i}(s) + i_{d0,i} \Delta v_{q,i}(s),\end{aligned}\quad (55)$$

linearized around the equilibrium $v_{d0,i}$, $v_{q0,i} = 0$, $i_{d0,i}$, $i_{q0,i}$, such that the transfer matrix $D_i(s)$ in (20) can be obtained as

$$D_i(s) = \begin{bmatrix} D_{11,i}(s) & D_{12,i}(s) \\ D_{21,i}(s) & D_{22,i}(s) \end{bmatrix},\quad (56)$$

with the matrix elements are given as

$$\begin{aligned}D_{11}(s) &= \frac{d_{p,i}}{\tau_{p,i}s+1} \\ D_{12}(s) &= 0 \\ D_{21}(s) &= -\frac{i_{d0,i} + v_{d0,i} G_{cc,i}(s) \text{PI}_{vc,i}(s)}{i_{d0,i}^2 + i_{q0,i}^2 - v_{d0,i}^2 G_{cc,i}(s)^2 \text{PI}_{vc,i}(s)^2} \\ D_{22}(s) &= \frac{i_{q0,i} + i_{d0,i} v_{d0,i} G_{cc,i}(s) \text{PI}_{vc,i}(s)}{v_{d0,i}^2 G_{cc,i}(s)^2 \text{PI}_{vc,i}(s)^2 - i_{d0,i}^2 - i_{q0,i}^2} \frac{d_{p,i}}{\tau_{p,i}s+1} \\ &\quad + \frac{v_{d0,i}^2 G_{cc,i}(s)^2 \text{PI}_{vc,i}(s)^2}{v_{d0,i}^2 G_{cc,i}(s)^2 \text{PI}_{vc,i}(s)^2 - i_{d0,i}^2 - i_{q0,i}^2} \frac{d_{p,i}}{\tau_{p,i}s+1},\end{aligned}\quad (57)$$

where we have used the linearized expression for the voltage magnitude deviation $\Delta|v|_i(s) \approx \Delta v_{d,i}(s)$, and

$$G_{cc,i}(s) = \frac{\text{PI}_{cc,i}(s)}{\frac{s l_{f,i}}{\omega_0} + \text{PI}_{cc,i}(s)}.\quad (58)$$

We assume that the timescales of the inner current and voltage control loops in (52) and (53) are faster than the outer droop controls in (51) and (54) and the network dynamics in (17) [8]. We can thus neglect the inner VSC dynamics and thus approximate $\text{PI}_{cc,i}(s) \rightarrow \infty$ and $\text{PI}_{vc,i}(s) \rightarrow \infty$ for small s , such that (57) can be reduced as in (21).

APPENDIX III PROOF OF COROLLARY 1

Quasistationary Network Model: For the quasistationary network model (18) in Definition 6 ($s = 0$ and $|v|_{0,i} \neq |v|_{0,j}$) we consider the same coordinate transformation as in (27), followed by the loop-shifting in (28). Since $s = 0$ in (18), we use a quasistationary version of the $\Gamma(s)$ with the diagonal elements

$$\begin{aligned}\Gamma_i^p(s) &= 0 \\ \Gamma_i^q(s) &= \frac{1}{s} \left(\sum_{j \neq i}^n b_{ij} \frac{0.8}{1+\rho^2} \right).\end{aligned}\quad (59)$$

With this choice, $\mathcal{N}'(s)$ is passive, i.e., it satisfies the conditions (i) to (iii) in Definition 2:

Poles: The transfer matrix $\mathcal{N}'(s)$ has one pole at $p = j0$, i.e., $\text{Re}(p) \leq 0$.

Positive semi-definiteness: We can show that the Hermitian matrix $\mathcal{S}_{\mathcal{N}'}(j\omega) := \mathcal{N}'(j\omega) + \mathcal{N}'^*(j\omega)$ is zero, i.e.,

$$\mathcal{S}_{\mathcal{N}'}(j\omega) = \begin{bmatrix} \mathcal{S}_{\mathcal{N}',11}(j\omega) & \dots & \mathcal{S}_{\mathcal{N}',1n}(j\omega) \\ \vdots & \ddots & \vdots \\ \mathcal{S}_{\mathcal{N}',n1}(j\omega) & \dots & \mathcal{S}_{\mathcal{N}',nn}(j\omega) \end{bmatrix} = 0_{2n \times 2n}\quad (60)$$

and therefore positive semi-definite.

Imaginary Poles: $\mathcal{N}'(s)$ has one imaginary pole, i.e., $p_1 = j0$, which is a simple pole. We compute $\mathcal{R}_{j0}^{\mathcal{N}'} := \lim_{s \rightarrow j0} (s - j0) \mathcal{N}'(s)$, where each $\mathcal{R}_{j0,i,j}^{\mathcal{N}'}$ represents a 2×2 transfer matrix block. The diagonal and off-diagonal elements are given by

$$\mathcal{R}_{j0,ii}^{\mathcal{N}'} = \sum_{j \neq i}^n b_{ij} \begin{bmatrix} \frac{|v|_{0,i}|v|_{0,j}}{1+\rho^2} & 0 \\ 0 & \frac{2|v|_{0,i}^2 - |v|_{0,i}|v|_{0,j} + 0.8}{1+\rho^2} \end{bmatrix} \quad (61)$$

$$\mathcal{R}_{j0,ij}^{\mathcal{N}'} = -b_{ij} \frac{|v|_{0,i}|v|_{0,j}}{1+\rho^2} \begin{bmatrix} 1 & 0 \\ 0 & 1 \end{bmatrix},$$

i.e., $\mathcal{R}_{j0}^{\mathcal{N}'}$ is a Hermitian diagonally dominant matrix with real non-negative diagonal entries. For the odd rows, we get

$$|\sum_{j \neq i}^n b_{ij} \frac{|v|_{0,i}|v|_{0,j}}{1+\rho^2}| \geq \sum_{j \neq i}^n | -b_{ij} \frac{|v|_{0,i}|v|_{0,j}}{1+\rho^2} |.$$

For the even rows we get (with $|v|_{\max} = 1.1$ and $|v|_{\min} = 0.9$):

$$\begin{aligned} |\sum_{j \neq i}^n \frac{(2|v|_{0,i}^2 - |v|_{0,i}|v|_{0,j} + 0.8)b_{ij}}{(1+\rho^2)}| &\geq \sum_{j \neq i}^n | -b_{ij} \frac{|v|_{0,i}|v|_{0,j}}{1+\rho^2} | \\ \Leftrightarrow \sum_{j \neq i}^n b_{ij} \frac{2|v|_{\min}^2 - |v|_{\max}^2 + 0.8}{1+\rho^2} &\geq \sum_{j \neq i}^n b_{ij} \frac{|v|_{\max}^2}{1+\rho^2}. \end{aligned}$$

By Lemma 1, we conclude $\mathcal{R}_{j0}^{\mathcal{N}'} \succeq 0$.

Next, we derive conditions under which $\mathcal{D}'(s)$ is strictly passive by verifying conditions (i) and (ii) in Definition 3.

(i) *Poles*: To ensure that the poles of all elements of $\mathcal{D}'_{p,i}(s)$ are in $\text{Re}(s) < 0$, we require

$$\alpha_{q,i} < \frac{5(1+\rho^2)}{4} = c_{\tau,\rho}, \quad (62)$$

which is equivalent to the condition in (25c).

(ii) *Positive definiteness*: We compute

$$\mathcal{D}'(j\omega) + \mathcal{D}'^*(j\omega) = \begin{bmatrix} \frac{2d_{p,i}}{1+\omega^2\tau_{p,i}^2} & 0 \\ 0 & \frac{2d_{q,i}\omega^2\tau_{q,i}}{\left(1 - \frac{0.8\alpha_{q,i}}{1+\rho^2}\right)^2 + (\omega\tau_{q,i})^2} \end{bmatrix} \succ 0, \quad (63)$$

which holds if $\tau_{q,i} > 0$.

Given internal feedback stability of $\mathcal{D}' \# \mathcal{N}'$ by Theorem 1, we conclude internal feedback stability of $\mathcal{D}_0 \# \mathcal{N}_0$ by following the same arguments as in Section IV-B-IV, while using the network dynamics $N(s)$ in (18).

Zero-Power Flow Network Model: For the zero-power flow network model (19) in Definition 6 ($s = 0$ and $|v|_{0,i} = |v|_{0,j} = |v|_0$), we can directly apply Theorem 1 by showing passivity of $\mathcal{N}_0(s)$ and deriving conditions for $\mathcal{D}_0(s)$ to be strictly passive. In particular, $\mathcal{N}_0(s)$ is passive, i.e., it satisfies the conditions (i) to (iii) in Definition 2:

(i) *Poles*: The transfer matrix $\mathcal{N}_0(s)$ has one pole at $p = j0$, i.e., $\text{Re}(p) \leq 0$.

(ii) *Positive semi-definiteness*: We can express the Hermitian matrix $\mathcal{S}_{\mathcal{N}_0}(j\omega) := \mathcal{N}_0(j\omega) + \mathcal{N}_0^*(j\omega)$ as

$$\mathcal{S}_{\mathcal{N}_0}(j\omega) = \begin{bmatrix} \mathcal{S}_{\mathcal{N}_0,11}(j\omega) & \dots & \mathcal{S}_{\mathcal{N}_0,1n}(j\omega) \\ \vdots & \ddots & \vdots \\ \mathcal{S}_{\mathcal{N}_0,n1}(j\omega) & \dots & \mathcal{S}_{\mathcal{N}_0,nn}(j\omega) \end{bmatrix}, \quad (64)$$

where each $\mathcal{S}_{\mathcal{N}_0,ij}$ represents a 2×2 transfer matrix block. The diagonal and off-diagonal elements are given by

$$\begin{aligned} \mathcal{S}_{\mathcal{N}_0,ii}(j\omega) &= \sum_{j \neq i}^n b_{ij} \frac{|v|_0^2}{1+\rho^2} \begin{bmatrix} 0 & 0 \\ 0 & 2 \end{bmatrix} \\ \mathcal{S}_{\mathcal{N}_0,ij}(j\omega) &= b_{ij} \frac{|v|_0^2}{1+\rho^2} \begin{bmatrix} 0 & 0 \\ 0 & -2 \end{bmatrix}, \end{aligned} \quad (65)$$

which is a Laplacian matrix, i.e., $\mathcal{N}_0(j\omega) + \mathcal{N}_0^*(j\omega) \succeq 0$.

(iii) *Imaginary poles*: $\mathcal{N}_0(s)$ has one imaginary pole, i.e., $p = j0$, which is a simple pole. We therefore compute the limit

$\mathcal{R}_{j0}^{\mathcal{N}_0} := \lim_{s \rightarrow j0} (s - j0)\mathcal{N}_0(s)$, where each $\mathcal{R}_{j0,ij}^{\mathcal{N}_0}$ represents a 2×2 transfer matrix block. The diagonal and off-diagonal elements are given by

$$\begin{aligned} \mathcal{R}_{j0,ii}^{\mathcal{N}_0} &= \sum_{j \neq i}^n b_{ij} \frac{|v|_0^2}{1+\rho^2} \begin{bmatrix} 1 & 0 \\ 0 & 0 \end{bmatrix} \\ \mathcal{R}_{j0,ij}^{\mathcal{N}_0} &= b_{ij} \frac{|v|_0^2}{1+\rho^2} \begin{bmatrix} -1 & 0 \\ 0 & 0 \end{bmatrix}, \end{aligned} \quad (66)$$

which is a Laplacian matrix, i.e., $\mathcal{R}_{j0}^{\mathcal{N}_0} \succeq 0$.

Next, we derive conditions under which $\mathcal{D}_0(s)$ is strictly passive by verifying conditions (i) and (ii) in Definition 3.

(i) *Poles*: The poles of all elements of $\mathcal{D}_0(s)$ are in $\text{Re}(s) < 0$.

(ii) *Positive-definiteness*: We compute

$$\mathcal{D}_0(j\omega) + \mathcal{D}_0^*(j\omega) = \begin{bmatrix} \frac{2d_{p,i}}{1+\omega^2\tau_{p,i}^2} & 0 \\ 0 & \frac{2d_{q,i}}{1+\omega^2\tau_{q,i}^2} \end{bmatrix} \succ 0, \quad (67)$$

which is always true.

In total, we conclude stability of $\mathcal{D}_0 \# \mathcal{N}_0$ for all tunable local droop control parameters $d_{p,i}, d_{q,i} \in \mathbb{R}_{>0}$ and $\tau_{p,i}, \tau_{q,i} \in \mathbb{R}_{\geq 0}$ without any additional conditions.