

MultiverSeg: Scalable Interactive Segmentation of Biomedical Imaging Datasets with In-Context Guidance

Hallee E. Wong
MIT CSAIL & MGH
hallee@mit.edu

Jose Javier Gonzalez Ortiz
Databricks
josejg@mit.edu

John Guttag
MIT CSAIL
guttag@mit.edu

Adrian V. Dalca
MIT CSAIL & MGH,HMS
adalca@mit.edu

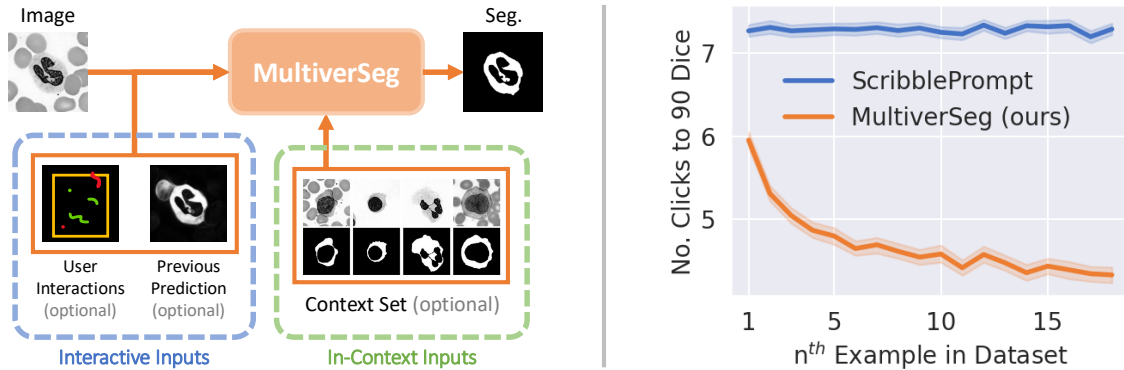

Figure 1. **MultiverSeg enables users to rapidly segment new datasets.** The MultiverSeg network takes as input an image to segment and user interactions, along with a context set of previously segmented image-segmentation pairs (**left**). As the user completes more segmentations, those images and segmentations become additional inputs to the model, populating the context set. As the context set of labeled images grows, the number of interactions required to achieve an accurate segmentation decreases (**right**).

Abstract

Medical researchers and clinicians often need to perform novel segmentation tasks on a set of related images. Existing methods for segmenting a new dataset are either interactive, requiring substantial human effort for each image, or require an existing set of manually labeled images.

We introduce a system, **MultiverSeg**, that enables practitioners to rapidly segment an entire new dataset without requiring access to any existing labeled data from that task or domain. Along with the image to segment, the model takes user interactions such as clicks, bounding boxes or scribbles as input, and predicts a segmentation. As the user segments more images, those images and segmentations become additional inputs to the model, providing context. As the context set of labeled images grows, the number of interactions required to segment each new image decreases.

We demonstrate that **MultiverSeg** enables users to interactively segment new datasets efficiently, by amortizing the number of interactions per image to achieve an accurate segmentation. Compared to using a state-of-the-art interactive segmentation method, using **MultiverSeg**

reduced the total number of scribble steps by 53% and clicks by 36% to achieve 90% Dice on sets of images from unseen tasks. We release code and model weights at <https://multiverseg.csail.mit.edu>.

1. Introduction

Segmentation is an important step in biomedical image analysis pipelines for both biomedical research and clinical care. Biomedical researchers and clinical researchers often acquire novel image types or identify new regions of interest, and need to perform new segmentation tasks. Typically, scientists want to segment the same region of interest in many similar images from a new dataset.

Manually segmenting images is labor-intensive and requires domain expertise. *Interactive* segmentation systems, in which a user provides a few clicks or scribbles on an image to produce a predicted segmentation, help to speed up the annotation of individual images. But with existing interactive segmentation systems, the user must independently repeat the same process for each image [59, 82, 85, 126, 133]. It would be impactful if the segmentation system became more accurate as the user completed more segmenta-

tions from the same task, learning from experience.

We propose MultiverSeg, a new interactive system that progressively reduces the number of user interactions needed to predict accurate segmentations, as more images are segmented in a particular task (Fig. 1). MultiverSeg takes as input user interactions for a new image, along with a *context set*, of example (previously segmented) image-segmentation pairs. To segment a new dataset, the user begins by interactively segmenting the first image. Once completed, the example becomes an input to MultiverSeg, providing context for the segmentation of subsequent examples. The user interactively segments the next image with MultiverSeg using bounding boxes, clicks or scribbles. As the user labels more images, the context set grows and the number of interactions required to achieve the desired segmentation of the subsequent image decreases, often to zero. Unlike existing interactive segmentations systems [59, 76, 77, 82, 85, 107, 122, 123, 126, 131, 136] where the work required to segment a dataset is linear in the number of images, MultiverSeg enables users to rapidly segment entire datasets.

This paper

- Presents MultiverSeg, a new interactive segmentation framework that progressively reduces the amount of user interaction needed to predict accurate segmentations, as more images are segmented in a particular task.
- Introduces a model that segments an image given user prompts (bounding boxes, clicks and/or scribbles) and a variably-sized context set of previously labeled example images and segmentations. This network enables scalable segmentation of datasets by performing *interactive segmentation in context*.
- Demonstrates that MultiverSeg can dramatically reduce the total number of user interactions needed to segment a collection of medical images.

2. Related Work

Interactive Segmentation. Recent interactive segmentation models can generalize to new segmentation tasks in medical [126] and natural images [59, 103]. While these methods are effective for segmenting single images, they require prohibitively extensive human interaction when segmenting large datasets. To incorporate new information, they must be retrained or fine-tuned. In contrast, at inference time MultiverSeg can be conditioned on example segmentations from the new task, dramatically reducing the human effort required for accurate segmentation.

In-Context Learning. Recent *in-context learning* approaches to segmentation [16, 20, 45, 101, 124, 128] enable users to perform new tasks by providing a set of labeled examples to the model at inference time. These methods often need existing large context sets to achieve adequate perfor-

mance, and provide no mechanism for correcting predicted segmentations.

A few works have explored in-context segmentation using a context set of example images with user annotations on those example images. OnePrompt [128] segments a medical image given exactly one context example with click, scribble, bounding box or mask annotation. In contrast, MultiverSeg has mechanisms to facilitate a variable number of context set entries and enables users to incorporate interactions on the target image even when given the context of previous segmentations, enabling substantially richer use cases. LabelAnything [23] is a few-shot framework that enables multi-label segmentation of a target natural image with a small variable size context set of example images with click, box, or mask annotations. In contrast, MultiverSeg can leverage *large* context sets, and enables users to provide interactions on the target image and make corrections to refine the prediction to get the desired segmentation.

Continual Learning. One approach to segmenting a new dataset involves manually labeling a large number of images, and then training an automatic task-specific model [51] to segment the rest. For example, MonaiLabel [26] is an open-source tool that packages this process. In contrast, MultiverSeg can be adapted *at inference time* using new labels (collected manually or interactively) without the need to re-train.

Many works have sought to improve task-specific interactive segmentation performance by fine-tuning foundation models, either through full fine-tuning [56] or more efficient adaption techniques [46, 73, 95, 102, 120, 129, 134]. The fine-tuning must be repeated for each new task or group of tasks. It requires many relevant annotated images and the substantial computational resources needed to train a large model.

Annotation-Efficient Learning. Another approach to segmenting a new dataset is to collect sparse annotations on many images and train an automatic segmentation model using these annotations for supervision. The annotations may be bounding boxes [65, 117], clicks [75, 78, 106] or scribbles [35, 70, 71, 83, 135]. These methods require the manual annotation of many training images and retraining for each new task. Other methods use annotations to perform online learning, using user corrections as a source of supervision to update the model weights at test time [4, 5, 60, 113, 121, 140]. In contrast, MultiverSeg is trained only once on a large corpus of datasets once, and then can be used to segment new datasets at inference time without any retraining, using graphical interactions and previous segmentations as *input*.

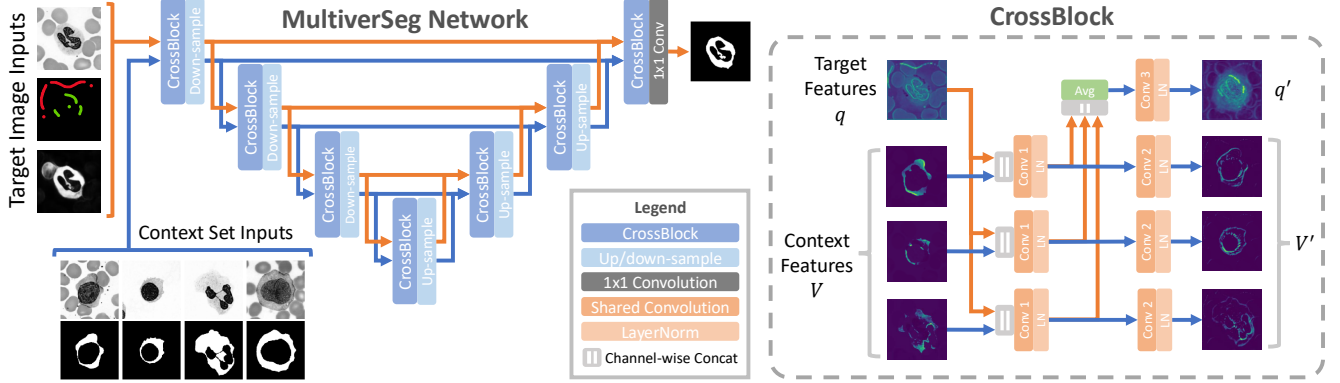

Figure 2. **MultiverSeg Architecture.** The MultiverSeg network (**left**) takes as input a stack of target image inputs q_i and a context set of image-segmentation pairs $\{(x_l, y_l)\}_{l=1}^m$. The target image inputs include a target image x_i , optional user interactions $u_{i,j}$, and a previous predicted segmentation $\hat{y}_{i,j-1}$ if available. The architecture is comprised of an encoder-decoder structure similar to a UNet [105]. We use a CrossBlock [16] (**right**) with additional normalization layers [6] to interact the features of the target image inputs q_i with the features of the context set inputs $V = \{v_l\}_{l=1}^m$ throughout the network.

3. Methods

3.1. Problem Setup

For a new task t , we aim to segment a set of images $\{x_i^t\}_{i=1}^N$ into their corresponding segmentations $\{y_i^t\}_{i=1}^N$.

We assume a user provides manual interactions for one image at a time, to indicate the desired segmentation. These interactions may be iterative even for a single image, sometimes indicating corrections based on a previous prediction $\hat{y}_{i,j-1}^t$. We let $u_{i,j}^t$ be the interactions provided for image x_i at step j , and \hat{y}_{i,k_i}^t be the final predicted segmentation for image x_i after k_i steps of interaction.

We want to maximize the quality of predicted segmentations $\{\hat{y}_{i,k_i}^t\}_{i=1}^N$ for an entire dataset,

$$\min \sum_{i=1}^N \mathcal{L}_{seg}(y_i^t, \hat{y}_{i,k_i}^t) \quad (1)$$

while minimizing the *total* number of user interactions

$$\sum_{i=1}^N \sum_{j=1}^{k_i} u_{i,j}^t, \quad (2)$$

where \mathcal{L}_{seg} is a segmentation distance metric, $\{y_i^t\}_{i=1}^N$ are the ground truth segmentation maps, and k_i is the number of steps of interaction for image i .

3.2. MultiverSeg

We introduce a framework that enables rapid progressive segmentation of an entire dataset. The key component is a method that segments image x_i^t based on user interactions $u_{i,j}$ and a set of image-segmentation maps $S_i^t = \{(x_l^t, \hat{y}_{l,k_l}^t)\}_{l=1}^{i-1}$ for previous segmented images.

First image. When segmenting the first image x_0^t of a new task t , the context set S_0^t is empty. We build on learning-based interactive segmentation approaches [59, 126], to learn a function $g_\phi(x_i^t; u_i, \hat{y}_{i,j-1}^t)$ that at step j produces a segmentation $\hat{y}_{i,j}^t$ of image x_i^t , given a set of user interactions $u_{i,j}$ and a previously predicted segmentation $\hat{y}_{i,j-1}^t$. The interactions u_i , which may include positive or negative scribbles, positive or negative clicks, and bounding boxes, are provided by a user who has access to the image x_i^t and previous prediction \hat{y}_{i-1}^t . For $g_\phi(\cdot)$, we use the pre-trained ScribblePrompt-UNet [126].

Subsequent images. For subsequent images x_i^t , the context set $S_i^t = \{(x_l^t, \hat{y}_{l,k_l}^t)\}_{l=0}^{i-1}$ encompass the previously segmented images and the resulting segmentation maps. We learn a function $f_\theta(x_i^t; u_i, \hat{y}_{i-1}^t; S_i^t)$ with parameters θ that leverages the set of user interactions u_i , previous prediction \hat{y}_{i-1}^t , and context set S_i^t to produce a segmentation \hat{y}_i . As more images are segmented, the context set S_i^t grows, leading to fewer interactions u_i necessary for accurate segmentation of each subsequent image.

3.2.1. Architecture

We employ a convolutional architecture (Fig. 2) for f_θ with an encoder-decoder structure, building on recent in-context learning strategies [16]. The architecture uses a *CrossBlock* mechanism to mix information between the context set, which can be of variable size, and the inputs corresponding to the user interactions, which pertain to the target image.

Target image inputs. The target image inputs consist of the target image x_i and graphical user interactions $u_{i,j}$, and a previous prediction $\hat{y}_{i,j-1}$ if available. The interactions may include bounding boxes, positive clicks and scribbles, and negative clicks and scribbles, represented as three intensity-based masks [126]. We stack the target inputs

leading to five channels, where the first channel contains the input image, and the other channels contain the optional interactions and an optional previous prediction. When there are no interactions or there is no previous prediction, these channels are set to zero.

Context set inputs. For each of the N examples in the context set, we stack the image and segmentation.

CrossBlock. We use a modified CrossBlock mechanism to interact intermediate target features q with intermediate features of the context set inputs v [16].

We first use a *cross-convolution* layer to interact a target feature map q with a set of context feature maps $V = \{v_i\}_{i=1}^n$:

$$\begin{aligned} \text{CrossConv}(q, V; \theta_z) &= \{z_i\}_{i=1}^n, \\ \text{for } z_i &= \text{Conv}(q \| v_i; \theta_z). \end{aligned} \quad (3)$$

This layer is used within the Crossblock to produce features of target representation q and context set V at each step in the network:

$$\begin{aligned} \text{CrossBlock}(q, V; \theta_{z,q,v}) &= (q', V'), \text{ where:} \\ z_i &= \text{LN}(A(\text{CrossConv}(q, v_i; \theta_z))) \text{ for } i = 1, 2, \dots, n \\ q' &= \text{LN}(A(\text{Conv}(1/n \sum_{i=1}^n z_i; \theta_q))) \\ v'_i &= \text{LN}(A(\text{Conv}(z_i; \theta_v))) \text{ for } i = 1, 2, \dots, n, \end{aligned} \quad (4)$$

where $A(x)$ is a non-linear activation function and $\text{LN}(\cdot)$ is LayerNorm [6].

Network. We employ a UNet-like encoder-decoder architecture, where each convolutional block is replaced by a CrossBlock, enabling the target-related inputs to interact with the previously segmented images at every image scale [16, 105].

3.3. Training

We summarize the training process in Algorithm 1. During training, we first sample a random task t , and then sample a training example (x_i^t, y_i^t) and context set $S_i^t = \{(x_l^t, y_l^t)\}_{l=0}^n$ of random size $n \in [0, N]$. We use ground truth segmentation labels in the context set.

We minimize the difference between the true segmentation y^t and each of the k iterative predictions $\hat{y}_{i,0}, \dots, \hat{y}_{i,k}$ given a context set S^t ,

$$\mathcal{L}(\theta; \mathcal{T}) = \mathbb{E}_{t \in \mathcal{T}} \left[\mathbb{E}_{(x_i^t, y_i^t; S^t) \in t} \left[\sum_{j=1}^k \mathcal{L}_{\text{seg}}(y_i^t, \hat{y}_{i,j}^t) \right] \right], \quad (5)$$

where $\hat{y}_{i,j}^t = f_\theta(x_i^t, u_{i,j}^t, \hat{y}_{i,j-1}^t; S_i^t)$, \mathcal{L}_{seg} is a supervised segmentation loss, $x_t \notin S^t$ and $\hat{y}_0^t = \mathbf{0}$.

Prompt Simulation. We simulate random combinations of scribbles, clicks and bounding boxes during training following prompt simulations procedures described in [126]. We

Algorithm 1 MultiverSeg Training Loop using SGD with learning rate η over tasks \mathcal{T} with independently sampled context set, main architecture f_θ , in-task augmentations Aug_t and task augmentations Aug_T

```

for  $k = 1, \dots, \text{NumTrainSteps}$  do
   $t \sim \mathcal{T}$  ▷ Sample Task
   $(x_i^t, y_i^t) \sim t$  ▷ Sample Target
   $n \sim U[0, N]$  ▷ Sample Context Size
   $S^t \leftarrow \{(x_l^t, y_l^t)\}_{l \neq i}^n$  ▷ Sample Context
   $x_i^t, y_i^t \leftarrow \text{Aug}_t(x_i^t, y_i^t)$  ▷ Augment Target
   $S^t \leftarrow \{\text{Aug}_t(x_l^t, y_l^t)\}_l^n$  ▷ Augment Context
   $x_i^t, y_i^t, S^t \leftarrow \text{Aug}_T(x_i^t, y_i^t, S^t)$  ▷ Task Aug
   $\hat{y}_{i,0} \leftarrow \mathbf{0}$ 
  for  $j = 1, \dots, \text{NumInteractionSteps}$  do
     $u_{i,j}^t \leftarrow h_\psi(y_i^t, \hat{y}_{j-1}^t)$  ▷ Simulate Interactions
     $\hat{y}_{i,j}^t \leftarrow f_\theta(x_i^t, u_{i,j}^t, \hat{y}_{i,j-1}^t; S^t)$  ▷ Predict Seg.
     $\ell_j \leftarrow \mathcal{L}_{\text{seg}}(y_i^t, \hat{y}_{i,j}^t)$  ▷ Compute Loss
  end for
   $\theta \leftarrow \theta - \eta \nabla_\theta \sum_j \ell$  ▷ Gradient Step
end for

```

simulate k steps of interactive segmentation for each example during training. For the first step ($i = 1$), we sample the combination of interactions (bounding box, clicks, scribbles) and the number of initial positive and negative interactions $n_{\text{pos}}, n_{\text{neg}} \sim U[n_{\text{min}}, n_{\text{max}}]$. The initial interactions u_1 are simulated using the ground truth label y^t . In subsequent steps, we sample correction scribbles or clicks from the error region ε_{i-1}^t between the last prediction \hat{y}_{i-1}^t and the ground truth y^t . Since a user can make multiple corrections in each step, we sample $n_{\text{cor}} \sim U[n_{\text{min}}, n_{\text{max}}]$ corrections (scribbles or clicks) per step.

4. Data

Task Diversity. We use a collection of 78 biomedical imaging datasets (Appendix B) and synthetically generated images and tasks [16, 101, 126]. The collection includes a diverse array of biomedical domains, such as eyes [44, 69, 86, 99, 116], thorax [100, 108, 109, 111, 112], spine [80, 109, 141], cells [17, 18, 30, 32, 38, 79, 142], skin [19], abdominal [12, 14, 41, 52, 55, 64, 66, 68, 74, 81, 87, 100, 104, 112, 115], neck [61, 94, 97, 98], brain [2, 7, 33, 42, 62, 63, 88, 89, 91, 112], bones [40, 109, 118], teeth [1, 50] and lesions [3, 112, 137, 139].

Task Definition. We define a 2D segmentation task as a combination of dataset, modality, axis (for 3D modalities), and binary label. For datasets with multiple segmentation labels, we consider each label separately as a binary segmentation task and for 3D modalities we use the slice with maximum label area and the middle slice from each volume.

Data Augmentation. We perform both task augmentation and within-task data augmentation to increase the diversity of segmentation tasks [16]. For task augmentation, the same augmentation is applied to the target example and the entries of the context set to change the segmentation task. For within-task augmentation, we apply data augmentation where the parameters are randomly sampled for each target example and context set entry, to vary the examples within a task. Augmentations are applied prior to simulating the user interactions. We detail the augmentations in Appendix B.3.

Synthetic Data. Synthetic data can help improve generalization [13, 16, 34, 126]. We use some fully synthetic data (images and labels) similar to strategies used for in-context learning [16].

Synthetic Tasks. We introduce a new approach for constructing synthetic tasks from real images. Given a single image x_0 we construct a set of images $\{x'_i, y'_i\}_{i=1}^{m+1}$ representing a synthetic task. We then partition this set into a target example and context set of size m for training.

Given an image x_0 , we first generate a synthetic label y_{synth} by applying a superpixel algorithm [28] with scale parameter $\lambda \sim U[1, \lambda_{max}]$ to partition the image into a multi-label mask of k superpixels $z \in \{1, \dots, k\}^{n \times n}$. We then randomly select a superpixel $y_{synth} = \mathbb{1}(z = c)$ as a synthetic label.

To generate a set of $m + 1$ images representing the same task, we duplicate (x_0, y_{synth}) , $m + 1$ times and apply aggressive augmentations to vary the images and segmentation labels [16, 138]. We detail these augmentations and provide examples in Appendix B.2.

During training, we replace a randomly sampled target example (x_0^t, y_0^t) and context set S^t with synthetic ones with probability p_{synth} . We use $p_{synth} = 0.5$.

5. Experimental Setup

We evaluate MultiverSeg and baselines in segmenting a set of images, representing a segmentation task unseen during training. We simulate the process of interactively segmenting each image in a dataset, and adding segmentations to the context set as they are completed.

5.1. Training MultiverSeg

To learn $f_\theta(\cdot)$, we minimize eq. (5) where \mathcal{L}_{seg} is the sum of soft Dice Loss [27] and Focal Loss [72] with $\gamma = 20$ [59]. We minimize the loss using the Adam optimizer [57]. We simulate 3 steps of interactive segmentation for each example during training. We simulate 1-3 positive and 0-3 negative interactions in the first step, and 1-3 corrections per subsequent step. We randomly sample a context set of size $m \sim U[0, 64]$ for each sample, and train with a batch size of 2 and learning rate of $\eta = 10^{-4}$.

5.2. Data

We partition our collection of 78 datasets into 67 datasets for training and 11 datasets for evaluation. We report results on 11 held-out datasets that were unseen by the model during training. These datasets cover 83 tasks and 8 modalities, including unseen image types, anatomies, and labels. The evaluation datasets cover a variety of modalities (MRI, CT, ultrasound, fundus photography, microscopy) and anatomical regions of interest (brain, teeth, bones, abdominal organs, muscles, heart, thorax, cells), including both healthy anatomy and lesions [2, 3, 11, 40, 44, 66, 66, 100, 118, 141, 142].

5.3. Prompt Simulation

Throughout our experiments, we consider two inference-time interaction protocols:

- **Center Clicks:** One positive click in the center of the largest component to start (step 1), followed by one (positive or negative) correction click per step in the center of the largest component of the error region.
- **Centerline Scribbles:** One positive and one negative centerline scribble to start (step 1), followed by one correction centerline scribble per step.

We selected these protocols because center clicks are commonly used for evaluation [10, 47, 59, 76, 77, 114, 130] and centerline scribbles were the most effective scribble type in previous work [126]. We simulate the interactions following ScribblePrompt [126].

5.4. Baselines

Interactive Segmentation Baselines. We compare to ScribblePrompt [126] a state-of-the-art interactive segmentation method for medical imaging that uses bounding boxes, clicks and scribbles. ScribblePrompt produces more accurate segmentations on unseen biomedical imaging datasets and works with more types of interactions compared to SAM [59] and medical imaging variants [85, 132].

In-Context Segmentation Baselines. We compare to UniverSeg [16], a general state-of-the-art in-context segmentation model that was developed and evaluated on a diverse collection of biomedical images.

Interactive Segmentation in Context Baselines. We construct a new baseline, *SP+UVS*, by combining UniverSeg [16] and ScribblePrompt [126]. We use the publicly available pre-trained weights for each model. When the context set is empty, we use ScribblePrompt. When provided with a context set, we first make a prediction using UniverSeg, and then refine the prediction with ScribblePrompt.

Consistent with the original published results, we find that UniverSeg has poor performance for small context sets

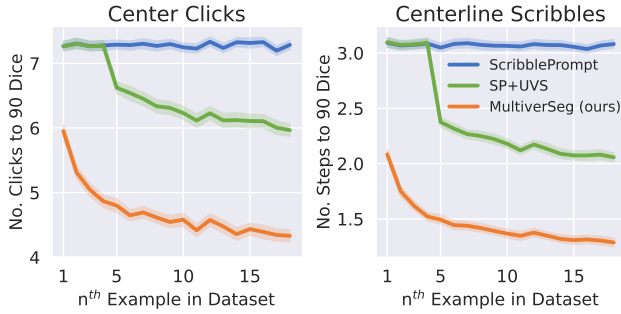

Figure 3. **Interactions to target Dice on unseen tasks.** Number of interactions needed to reach a 90% Dice as a function of the example number being segmented. For the n^{th} image being segmented, the context set has n examples. MultiverSeg requires substantially fewer number of interactions to achieve 90% Dice than the baselines, and as more images are segmented, the average number of interactions required decreases dramatically. Shaded regions show 95% CI from bootstrapping.

and initializing ScribblePrompt using the UniverSeg prediction hurts performance when the context set is small (Fig. 14). Thus, for context sets with fewer than 5 examples, we ignore the context and only use ScribblePrompt to make predictions.

We did not compare to OnePrompt [128] and LabelAnything [23] because the pre-trained weights were not publicly available and reproducing the training datasets and training pipelines is beyond the scope of this work. Additionally, these models are not designed to perform interactive segmentation in context. We provide more discussion in Appendix C.1.

Supervised Benchmarks (upper bound). We also train task-specific models using the popular nnUNet pipeline [51], which automatically configures the model architecture and training based on the data properties. We train a separate nnUNet model for each held-out 2D task, and report results from the collection of models. These models act as upper bounds on segmentation accuracy, because they are fully-supervised and have access to ground truth training data not available to the other algorithms.

5.5. Metrics

We primarily evaluate segmentation quality using Dice score [27], and show 95th percentile Hausdorff distance [49] in Appendix D.2.

6. Experiment 1: Evaluation

In this experiment, we evaluate different approaches to segmenting an entire new biomedical dataset. We compare MultiverSeg to ScribblePrompt, which performs interactive segmentation of each image independently, and

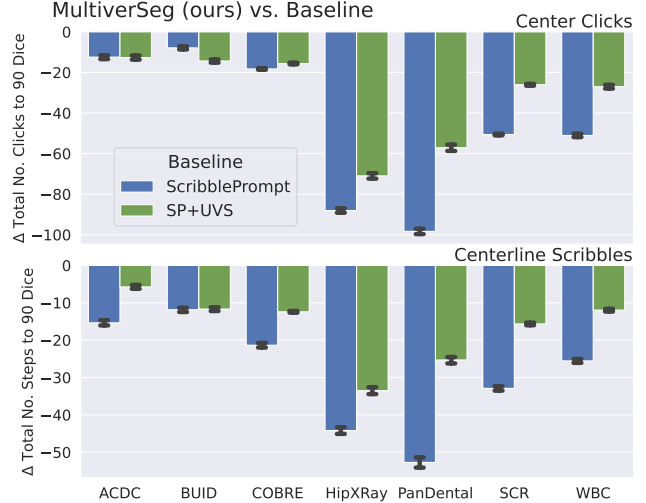

Figure 4. **Change in total interactions per task.** We show average change per task in total number of clicks and scribble steps to segment 18 images to $\geq 90\%$ Dice, comparing MultiverSeg to each baseline method. In all scenarios, MultiverSeg required fewer interactions than both baselines. Error bars show 95% CI from bootstrapping.

to SP+UVS, which combines ScribblePrompt with an in-context segmentation model (UniverSeg). We show that MultiverSeg outperforms both techniques.

6.1. Setup

We evaluate the number of interactions required to achieve a target Dice score on each image using different methods, or a maximum number of interactions if the score was not reached. We use 90% as a target Dice score, because our collection of fully-supervised task-specific nnUNet models achieves an average Dice of 90.15 ± 0.54 on the same test data. We set 20 center clicks or 10 steps of centerline scribbles as the maximum number of interactions.

For each method and task, we begin by interactively segmenting one randomly sampled image from the training split to $\geq 90\%$ Dice using ScribblePrompt [126]. This example is used to seed the context set. We then randomly sample (without replacement) 18 images from the test split, and simulate sequentially segmenting each image.

Data. We report results averaged across 200 simulations for each held-out segmentation task. We exclude tasks with fewer than 18 test examples, leaving 161 tasks from 8 evaluation datasets [1–3, 11, 40, 118, 125, 142]. We further discuss the choice of this cutoff in Appendix D.1.

6.2. Results

Interactions per image as a function of dataset size. As more examples are segmented and the context set grows, the number of interactions required to get to 90% Dice (NoI90)

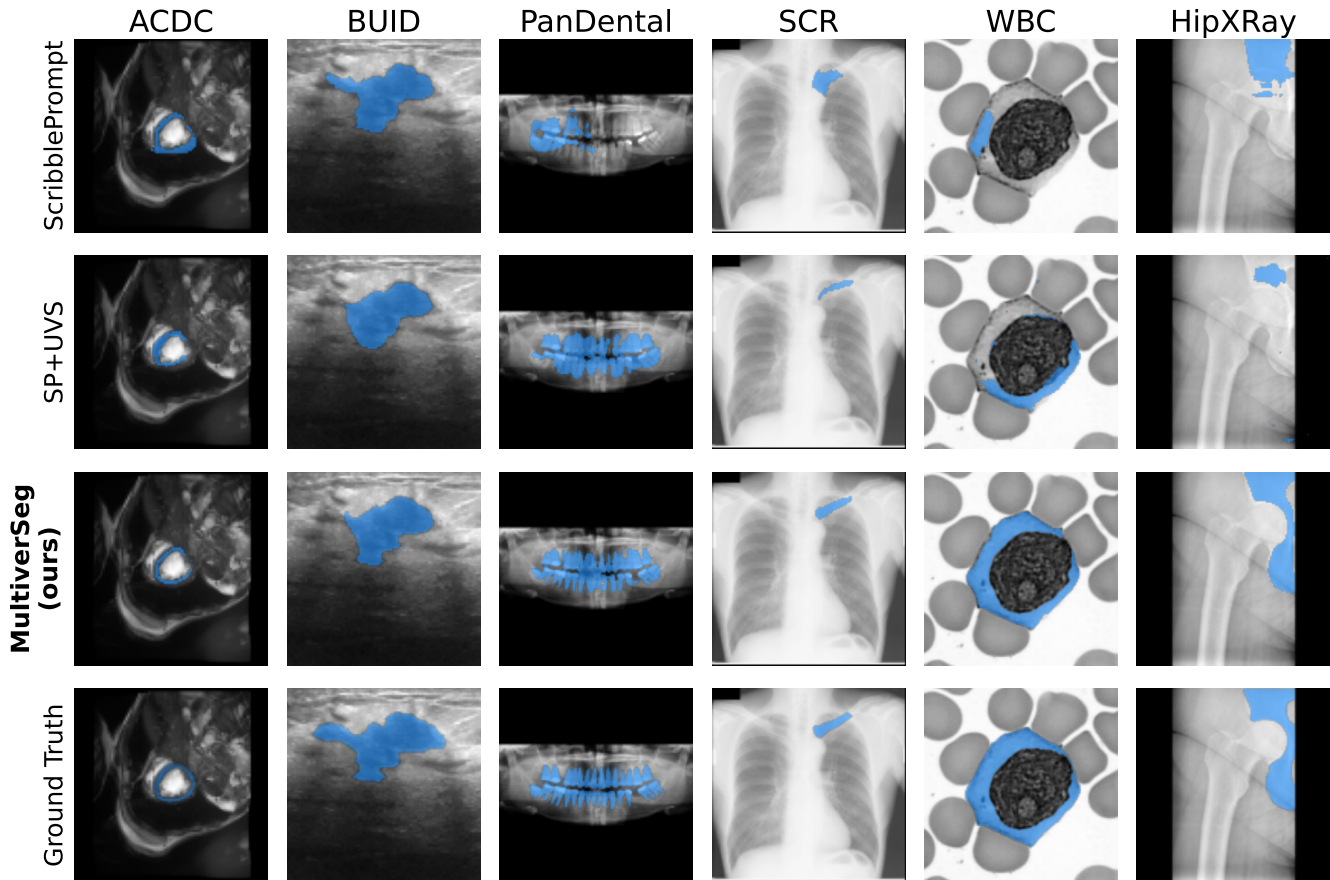

Figure 5. **Example predictions after 1 interaction step.** We show predictions for MultiverSeg and baselines for a random example with a context of 10 examples that were previously segmented to $\geq 90\%$ Dice from each held-out task. For each method, we show the prediction after 1 step of interaction: 1 step of centerline scribbles for ACDC [11], BUID [3], and PanDental [1], and 1 center click for SCR [118], WBC [142] and HipXRray [40].

on the n^{th} example using MultiverSeg decreases substantially (Fig. 3). For ScribblePrompt, NoI90 is approximately constant, because it is not designed to learn from previous examples. With SP+UVS, the number of interactions decreases as more examples are segmented, but it requires more interactions than MultiverSeg. Results by task in Appendix D.2 illustrate a similar trend. Fig. 5 shows predictions for the 10^{th} example after 1 step of interaction.

Total interactions. On average, using MultiverSeg reduced the number of scribble steps required to segment each dataset by $(52.70 \pm 3.60)\%$ and the number of clicks required by $(35.61 \pm 1.95)\%$ (Fig. 4). For larger sets of images, using MultiverSeg results in even greater reductions in the total number of user interactions (Appendix D.2).

Context Set Quality. MultiverSeg was trained with ground truth context set labels. However, at inference time, the context set only includes previously predicted segmentations.

For both MultiverSeg and SP+UVS, thresholding the predictions at 0.5 before adding them to the context set im-

proved the accuracy of predictions for subsequent images. We show results in Appendix D.2 with and without this modification.

As an upper bound on performance, we also evaluated using ground truth labels in the context set instead of predicted segmentations (Appendix D.2). Using ground truth context labels decreases the number of interactions to achieve 90% Dice for both MultiverSeg and SP+UVS, but MultiverSeg still requires fewer interactions.

Bootstrapping In-Context Segmentation. Another approach to segmenting a new dataset is to manually segment an image and then use an in-context segmentation model to segment the rest of the images. We experimented with bootstrapping UniverSeg: starting from a single labeled example as the context set, we sequentially segment each image with UniverSeg and then add it to the context set for the next example. This approach did not produce accurate results (51.02 ± 0.07 Dice), likely because UniverSeg has poor performance for small context sets (Fig. 6) and/or con-

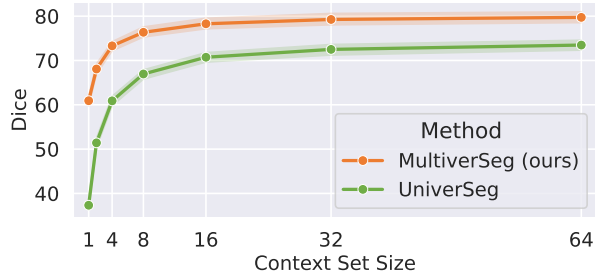

Figure 6. **In-context segmentation performance across context set sizes.** We compare MultiverSeg to an in-context segmentation method [16] given ground truth context labels. Shading shows 95% CI from bootstrapping.

text sets with imperfect labels. Because UniverSeg does not have a mechanism to incorporate corrections, it was not possible to achieve 90% Dice for most images. We show results experimenting with this approach in Appendix D.2.2.

7. Experiment 2: Analysis

When segmenting images sequentially, as in the previous experiment, the performance on the n^{th} image is correlated with the predictions on the previous images. However, in some realistic instances, a few ground truth segmentations might already be available from other previous segmentation efforts. In the following experiments, we analyze MultiverSeg using randomly sampled context sets with *ground truth* labels. We report results on the test split of 11 evaluation datasets not used during training.

7.1. In-Context Segmentation

Setup. We compare the predictions of MultiverSeg to a generalizable in-context learning baseline, UniverSeg [16], given different context set sizes. For each test example, we make 10 predictions with context sets randomly sampled with replacement from the training split of the same dataset.

Results. MultiverSeg produces higher Dice score segmentations than UniverSeg across all context set sizes (Fig. 6). In the previous experiment, MultiverSeg required fewer interactions than SP+UVS, in part because its initial in-context predictions were more accurate than those of UniverSeg. This is likely due to MultiverSeg being trained on a larger collection of data (67 vs. 53 datasets) with more features per CrossBlock (256 vs. 64) and normalization layers.

7.2. Interactive Segmentation in Context

Setup. We evaluate the interactive segmentation performance of MultiverSeg given context sets of different sizes. Using MultiverSeg, we first make a prediction based only on the context set (without interactions). We then simulate corrections using either center clicks or centerline scribbles,

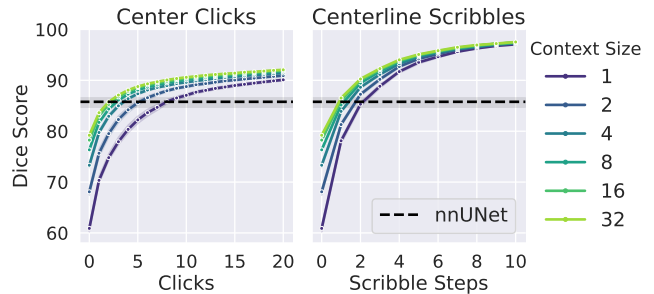

Figure 7. **Interactive segmentation in context.** MultiverSeg’s interactive segmentation performance improves as the context set size grows. We first make an initial prediction based on the context set (step 0), and then simulate corrections (clicks or scribbles). Shading shows 95% CI from bootstrapping.

and make additional predictions. For each example, we simulate interactive segmentation with 10 different random seeds and randomly sampled context sets of ground truth segmentation maps.

Results. Interactive segmentation performance improves as the size of the context set increases, demonstrating MultiverSeg is able to use information from the context set to improve its predictions (Fig. 7). There are diminishing returns to increasing the context set size. For example, performing another step of scribbles typically leads to a larger increase in Dice score, compared to doubling the context set size.

8. Conclusion

We presented MultiverSeg, an interactive framework that enables rapid segmentation of an entire dataset of images, even for new tasks. MultiverSeg leads to a substantial reduction of user interactions as more images are segmented.

To enable MultiverSeg, we introduce the first model that can perform *interactive* segmentation of biomedical images *in context*. The network segments an image given user interactions and a context set of previously labeled examples. Compared to ScribblePrompt, a state-of-the-art interactive segmentation model, MultiverSeg reduces the number of interactions required to accurately segment a set of images, by as much as 50% on the first 18 images of a dataset.

MultiverSeg opens up new opportunities for research into how best to prioritize sequentially segmenting images from a new dataset. Future research works could improve upon MultiverSeg by investigating better context selection techniques [31, 48, 127] to prioritize labeling images whose labels would be most informative for the segmentation task at hand.

MultiverSeg has the potential to dramatically reduce the manual burden involved in segmenting datasets of biomedical images.

Acknowledgements

This work was supported in part by Quanta Computer Inc. and the National Institute of Biomedical Imaging and Bioengineering of the National Institutes of Health under award number R01EB033773. Much of the computation required for this research was performed on computational hardware generously provided by the Massachusetts Life Sciences Center.

References

- [1] Amir Hossein Abdi, Shohreh Kasaei, and Mojdeh Mehdizadeh. Automatic segmentation of mandible in panoramic x-ray. *Journal of Medical Imaging*, 2(4):044003, 2015. [4](#), [6](#), [7](#), [17](#), [20](#)
- [2] C. J. Aine, H. J. Bockholt, J. R. Bustillo, J. M. Cañive, A. Caprihan, C. Gasparovic, F. M. Hanlon, J. M. Houck, R. E. Jung, J. Lauriello, J. Liu, A. R. Mayer, N. I. Perrone-Bizzozero, S. Posse, J. M. Stephen, J. A. Turner, V. P. Clark, and Vince D. Calhoun. Multimodal Neuroimaging in Schizophrenia: Description and Dissemination. *Neuroinformatics*, 15(4):343–364, 2017. [4](#), [5](#), [16](#), [17](#)
- [3] Walid Al-Dhabyani, Mohammed Gomaa, Hussien Khaled, and Aly Fahmy. Dataset of breast ultrasound images. *Data in Brief*, 28:104863, 2020. [4](#), [5](#), [6](#), [7](#), [17](#), [20](#), [24](#)
- [4] Muhammad Asad, Lucas Fidon, and Tom Vercauteren. ECONet: Efficient Convolutional Online Likelihood Network for Scribble-based Interactive Segmentation. In *International Conference on Medical Imaging with Deep Learning*, pages 35–47. PMLR, 2022. [arXiv:2201.04584](#) [cs, eess]. [2](#)
- [5] Muhammad Asad, Helena Williams, Indrajeet Mandal, Sarim Ather, Jan Deprest, Jan D’hooge, and Tom Vercauteren. Adaptive Multi-scale Online Likelihood Network for AI-assisted Interactive Segmentation. In *International Conference on Medical Image Computing and Computer-Assisted Intervention*, pages 564–574, 2023. [arXiv:2303.13696](#) [cs, eess]. [2](#)
- [6] Jimmy Lei Ba, Jamie Ryan Kiros, and Geoffrey E Hinton. Layer normalization. *arXiv preprint arXiv:1607.06450*, 2016. [3](#), [4](#)
- [7] Ujjwal Baid, Satyam Ghodasara, Suyash Mohan, Michel Bilello, Evan Calabrese, Errol Colak, Keyvan Farahani, Jayashree Kalpathy-Cramer, Felipe C Kitamura, Sarthak Pati, et al. The rsna-asnr-miccai brats 2021 benchmark on brain tumor segmentation and radiogenomic classification. *arXiv preprint arXiv:2107.02314*, 2021. [4](#), [18](#)
- [8] Spyridon Bakas, Hamed Akbari, Aristeidis Sotiras, Michel Bilello, Martin Rozycki, Justin S Kirby, John B Freymann, Keyvan Farahani, and Christos Davatzikos. Advancing the cancer genome atlas glioma mri collections with expert segmentation labels and radiomic features. *Scientific data*, 4(1):1–13, 2017. [18](#)
- [9] Sophia Bano, Francisco Vasconcelos, Luke M Shepherd, Emmanuel Vander Poorten, Tom Vercauteren, Sebastien Ourselin, Anna L David, Jan Deprest, and Danail Stoyanov. Deep placental vessel segmentation for fetoscopic mosaicking. In *Medical Image Computing and Computer Assisted Intervention—MICCAI 2020: 23rd International Conference, Lima, Peru, October 4–8, 2020, Proceedings, Part III 23*, pages 763–773. Springer, 2020. [18](#)
- [10] Rodrigo Benenson, Stefan Popov, and Vittorio Ferrari. Large-scale interactive object segmentation with human annotators. In *Proceedings of the IEEE/CVF conference on computer vision and pattern recognition*, pages 11700–11709, 2019. [5](#)
- [11] Olivier Bernard, Alain Lalande, Clement Zotti, Frederick Cervenansky, Xin Yang, Pheng-Ann Heng, Irem Cetin, Karim Lekadir, Oscar Camara, Miguel Angel Gonzalez Ballester, et al. Deep learning techniques for automatic mri cardiac multi-structures segmentation and diagnosis: is the problem solved? *IEEE transactions on medical imaging*, 37(11):2514–2525, 2018. [5](#), [6](#), [7](#), [16](#), [17](#), [20](#)
- [12] Patrick Bilic, Patrick Ferdinand Christ, Eugene Vorontsov, Grzegorz Chlebus, Hao Chen, Qi Dou, Chi-Wing Fu, Xiao Han, Pheng-Ann Heng, Jürgen Hesser, et al. The liver tumor segmentation benchmark (lits). *arXiv preprint arXiv:1901.04056*, 2019. [4](#), [18](#)
- [13] Benjamin Billot, Douglas N Greve, Oula Puonti, Axel Thielscher, Koen Van Leemput, Bruce Fischl, Adrian V Dalca, Juan Eugenio Iglesias, et al. Synthseg: Segmentation of brain mri scans of any contrast and resolution without retraining. *Medical image analysis*, 86:102789, 2023. [5](#)
- [14] Nicholas Bloch, Anant Madabhushi, Henkjan Huisman, John Freymann, Justin Kirby, Michael Grauer, Andinet Enquobahrie, Carl Jaffe, Larry Clarke, and Keyvan Farahani. Nci-isbi 2013 challenge: automated segmentation of prostate structures. *The Cancer Imaging Archive*, 370(6):5, 2015. [4](#), [18](#)
- [15] Mateusz Buda, Ashirbani Saha, and Maciej A Mazurowski. Association of genomic subtypes of lower-grade gliomas with shape features automatically extracted by a deep learning algorithm. *Computers in biology and medicine*, 109:218–225, 2019. [18](#)
- [16] Victor Ion Butoi*, Jose Javier Gonzalez Ortiz*, Tianyu Ma, Mert R. Sabuncu, John Guttag, and Adrian V. Dalca. Universeg: Universal medical image segmentation. In *ICCV*, 2023. [2](#), [3](#), [4](#), [5](#), [8](#), [16](#), [17](#), [21](#)
- [17] Juan C. Caicedo, Allen Goodman, Kyle W. Karhohs, Beth A. Cimini, Jeanelle Ackerman, Marzieh Haghighi, CherKeng Heng, Tim Becker, Minh Doan, Claire McQuin, Mohammad Rohban, Shantanu Singh, and Anne E. Carpenter. Nucleus segmentation across imaging experiments: the 2018 Data Science Bowl. *Nature Methods*, 16(12):1247–1253, 2019. [4](#), [18](#)
- [18] Albert Cardona, Stephan Saalfeld, Stephan Preibisch, Benjamin Schmid, Anchi Cheng, Jim Pulokas, Pavel Tomanek, and Volker Hartenstein. An integrated micro-and macroarchitectural analysis of the drosophila brain by computer-assisted serial section electron microscopy. *PLoS biology*, 8(10):e1000502, 2010. [4](#), [18](#)
- [19] Noel C. F. Codella, David A. Gutman, M. Emre Celebi, Brian Helba, Michael A. Marchetti, Stephen W. Dusza,

- Aadi Kallou, Konstantinos Liopyris, Nabin K. Mishra, Harald Kittler, and Allan Halpern. Skin lesion analysis toward melanoma detection: A challenge at the 2017 international symposium on biomedical imaging (isbi), hosted by the international skin imaging collaboration (ISIC). *CoRR*, abs/1710.05006, 2017. 4, 18
- [20] Steffen Czolbe and Adrian V Dalca. Neuralizer: General neuroimage analysis without re-training. In *Proceedings of the IEEE/CVF Conference on Computer Vision and Pattern Recognition*, pages 6217–6230, 2023. 2
- [21] Adrian V Dalca, John Guttag, and Mert R Sabuncu. Anatomical priors in convolutional networks for unsupervised biomedical segmentation. In *Proceedings of the IEEE Conference on Computer Vision and Pattern Recognition*, pages 9290–9299, 2018. 18
- [22] Adrian V Dalca, John Guttag, and Mert R Sabuncu. Anatomical priors in convolutional networks for unsupervised biomedical segmentation. In *Proceedings of the IEEE Conference on Computer Vision and Pattern Recognition*, pages 9290–9299, 2018. 17
- [23] Pasquale De Marinis, Nicola Fanelli, Raffaele Scaringi, Emanuele Colonna, Giuseppe Fiameni, Gennaro Vessio, and Giovanna Castellano. Label anything: Multi-class few-shot semantic segmentation with visual prompts. *arXiv preprint arXiv:2407.02075*, 2024. 2, 6, 19, 21
- [24] Etienne Decenciere, Guy Cazuguel, Xiwei Zhang, Guillaume Thibault, J-C Klein, Fernand Meyer, Beatriz Marcotegui, Gwénoél Quéllec, Mathieu Lamard, Ronan Danno, et al. Teleophtha: Machine learning and image processing methods for teleophthalmology. *Irbm*, 34(2):196–203, 2013. 18
- [25] Aysen Degerli, Morteza Zabihi, Serkan Kiranyaz, Tahir Hamid, Rashid Mazhar, Ridha Hamila, and Moncef Gabbouj. Early detection of myocardial infarction in low-quality echocardiography. *IEEE Access*, 9:34442–34453, 2021. 18
- [26] Andres Diaz-Pinto, Sachidanand Alle, Vishwesh Nath, Yucheng Tang, Alvin Ihsani, Muhammad Asad, Fernando Pérez-García, Pritesh Mehta, Wenqi Li, Mona Flores, et al. Monai label: A framework for ai-assisted interactive labeling of 3d medical images. *Medical Image Analysis*, 95: 103207, 2024. 2
- [27] Lee R Dice. Measures of the amount of ecologic association between species. *Ecology*, 26(3):297–302, 1945. 5, 6
- [28] Pedro F Felzenszwalb and Daniel P Huttenlocher. Efficient graph-based image segmentation. *International journal of computer vision*, 59:167–181, 2004. 5, 17
- [29] Bruce Fischl. Freesurfer. *Neuroimage*, 62(2):774–781, 2012. 17
- [30] J Gamper, NA Koohbanani, K Benes, S Graham, M Jahanifar, SA Khurram, A Azam, K Hewitt, and N Rajpoot. Pan-nuke dataset extension, insights and baselines. arxiv. 2020 doi: 10.48550. ARXIV, 2003. 4, 18
- [31] Jun Gao, Qicheng Lao, Qingbo Kang, Paul Liu, Chenlin Du, Kang Li, and Le Zhang. Boosting your context by dual similarity checkup for in-context learning medical image segmentation. *IEEE Transactions on Medical Imaging*, 2024. 8
- [32] Stephan Gerhard, Jan Funke, Julien Martel, Albert Cardona, and Richard Fetter. Segmented anisotropic ssTEM dataset of neural tissue. 2013. 4, 18
- [33] Randy L Gollub, Jody M Shoemaker, Margaret D King, Tonya White, Stefan Ehrlich, Scott R Sponheim, Vincent P Clark, Jessica A Turner, Bryon A Mueller, Vince Magnotta, et al. The mcic collection: a shared repository of multimodal, multi-site brain image data from a clinical investigation of schizophrenia. *Neuroinformatics*, 11:367–388, 2013. 4, 18
- [34] Karthik Gopinath, Andrew Hoopes, Daniel C Alexander, Steven E Arnold, Yael Balbastre, Benjamin Billot, Adrià Casamitjana, You Cheng, Russ Yue Zhi Chua, Brian L Edlow, et al. Synthetic data in generalizable, learning-based neuroimaging. *Imaging Neuroscience*, 2:1–22, 2024. 5
- [35] Karol Gotkowski, Carsten Lüth, Paul F Jäger, Sebastian Ziegler, Lars Krämer, Stefan Denner, Shuhan Xiao, Nico Disch, Klaus H Maier-Hein, and Fabian Isensee. Embarassingly simple scribble supervision for 3d medical segmentation. *arXiv preprint arXiv:2403.12834*, 2024. 2
- [36] Ioannis S Gousias, Daniel Rueckert, Rolf A Heckemann, Leigh E Dyet, James P Boardman, A David Edwards, and Alexander Hammers. Automatic segmentation of brain mris of 2-year-olds into 83 regions of interest. *Neuroimage*, 40(2):672–684, 2008. 18
- [37] Ioannis S Gousias, A David Edwards, Mary A Rutherford, Serena J Counsell, Jo V Hajnal, Daniel Rueckert, and Alexander Hammers. Magnetic resonance imaging of the newborn brain: manual segmentation of labelled atlases in term-born and preterm infants. *Neuroimage*, 62(3):1499–1509, 2012. 18
- [38] Simon Graham, Quoc Dang Vu, Shan E Ahmed Raza, Ayesha Azam, Yee Wah Tsang, Jin Tae Kwak, and Nasir Rajpoot. Hover-net: Simultaneous segmentation and classification of nuclei in multi-tissue histology images. *Medical Image Analysis*, 58:101563, 2019. 4
- [39] Endre Grøvik, Darwin Yi, Michael Iv, Elizabeth Tong, Daniel Rubin, and Greg Zaharchuk. Deep learning enables automatic detection and segmentation of brain metastases on multisequence mri. *Journal of Magnetic Resonance Imaging*, 51(1):175–182, 2020. 18
- [40] Daniel Gut. X-ray images of the hip joints. 1, 2021. Publisher: Mendeley Data. 4, 5, 6, 7, 17, 20, 24
- [41] Nicholas Heller, Fabian Isensee, Klaus H Maier-Hein, Xiaoshuai Hou, Chunmei Xie, Fengyi Li, Yang Nan, Guangrui Mu, Zhiyong Lin, Miofei Han, et al. The state of the art in kidney and kidney tumor segmentation in contrast-enhanced ct imaging: Results of the kits19 challenge. *Medical Image Analysis*, page 101821, 2020. 4, 18
- [42] Moritz R Hernandez Petzsche, Ezequiel de la Rosa, Uta Hanning, Roland Wiest, Waldo Valenzuela, Mauricio Reyes, Maria Meyer, Sook-Lei Liew, Florian Kofler, Ivan Ezhov, et al. Isles 2022: A multi-center magnetic resonance imaging stroke lesion segmentation dataset. *Scientific data*, 9(1):762, 2022. 4, 18
- [43] Andrew Hoopes, Malte Hoffmann, Douglas N. Greve, Bruce Fischl, John Guttag, and Adrian V. Dalca. Learning

- the effect of registration hyperparameters with hypermorph. *Machine Learning for Biomedical Imaging*, 1:1–30, 2022. [18](#)
- [44] AD Hoover, Valentina Kouznetsova, and Michael Goldbaum. Locating blood vessels in retinal images by piecewise threshold probing of a matched filter response. *IEEE Transactions on Medical Imaging*, 19(3):203–210, 2000. [4](#), [5](#), [18](#)
- [45] Jiesi Hu, Yang Shang, Yanwu Yang, Guo Xutao, Hanyang Peng, and Ting Ma. Icl-sam: Synergizing in-context learning model and sam in medical image segmentation. In *Medical Imaging with Deep Learning*, 2024. [2](#)
- [46] Xinrong Hu, Xiaowei Xu, and Yiyu Shi. How to efficiently adapt large segmentation model(sam) to medical images, 2023. [2](#)
- [47] You Huang, Hao Yang, Ke Sun, Shengchuan Zhang, Lijuan Cao, Guannan Jiang, and Rongrong Ji. Interformer: Real-time interactive image segmentation. In *Proceedings of the IEEE/CVF International Conference on Computer Vision*, pages 22301–22311, 2023. [5](#)
- [48] Jiayu Huo, Ruiqiang Xiao, Haotian Zheng, Yang Liu, Sebastien Ourselin, and Rachel Sparks. Matchseg: Towards better segmentation via reference image matching. *arXiv preprint arXiv:2403.15901*, 2024. [8](#)
- [49] Daniel P Huttenlocher, Gregory A. Klanderman, and William J Rucklidge. Comparing images using the hausdorff distance. *IEEE Transactions on pattern analysis and machine intelligence*, 15(9):850–863, 1993. [6](#)
- [50] Humans in the Loop. Teeth segmentation dataset. [4](#), [18](#)
- [51] Fabian Isensee, Paul F. Jaeger, Simon A. A. Kohl, Jens Petersen, and Klaus H. Maier-Hein. nnU-Net: a self-configuring method for deep learning-based biomedical image segmentation. *Nature Methods*, 18(2):203–211, 2021. [2](#), [6](#)
- [52] Yuanfeng Ji, Haotian Bai, Jie Yang, Chongjian Ge, Ye Zhu, Ruimao Zhang, Zhen Li, Lingyan Zhang, Wanling Ma, Xiang Wan, et al. Amos: A large-scale abdominal multi-organ benchmark for versatile medical image segmentation. *arXiv preprint arXiv:2206.08023*, 2022. [4](#), [18](#)
- [53] Rashed Karim, R James Housden, Mayuragoban Balasubramaniam, Zhong Chen, Daniel Perry, Ayesha Uddin, Yosra Al-Beyatti, Ebrahim Palkhi, Prince Acheampong, Samantha Obom, et al. Evaluation of current algorithms for segmentation of scar tissue from late gadolinium enhancement cardiovascular magnetic resonance of the left atrium: an open-access grand challenge. *Journal of Cardiovascular Magnetic Resonance*, 15(1):1–17, 2013. [18](#)
- [54] Ali Emre Kavur, M. Alper Selver, Oğuz Dicle, Mustafa Barış, and N. Sinem Gezer. CHAOS - Combined (CT-MR) Healthy Abdominal Organ Segmentation Challenge Data, 2019. [18](#)
- [55] A. Emre Kavur, N. Sinem Gezer, Mustafa Barış, Sinem Aslan, Pierre-Henri Conze, Vladimir Groza, Duc Duy Pham, Soumick Chatterjee, Philipp Ernst, Savaş Özkan, Bora Baydar, Dmitry Lachinov, Shuo Han, Josef Pauli, Fabian Isensee, Matthias Perkonigg, Rachana Sathish, Ronnie Rajan, Debodoot Sheet, Gurbandurdy Dovletov, Oliver Speck, Andreas Nürnberger, Klaus H. Maier-Hein, Gözde Bozdağı Akar, Gözde Ünal, Oğuz Dicle, and M. Alper Selver. CHAOS Challenge - combined (CT-MR) healthy abdominal organ segmentation. *Medical Image Analysis*, 69:101950, 2021. [4](#), [18](#)
- [56] SeungKyu Kim, Hyun-Jic Oh, Seonghui Min, and Won-Ki Jeong. Evaluation and improvement of segment anything model for interactive histopathology image segmentation, 2023. [2](#)
- [57] Diederik P Kingma and Jimmy Ba. Adam: A method for stochastic optimization. *arXiv preprint arXiv:1412.6980*, 2014. [5](#)
- [58] Serkan Kiranyaz, Aysen Degerli, Tahir Hamid, Rashid Mazhar, Rayyan El Fadil Ahmed, Rayaana Abouhasera, Morteza Zabihi, Junaid Malik, Ridha Hamila, and Moncef Gabbouj. Left ventricular wall motion estimation by active polynomials for acute myocardial infarction detection. *IEEE Access*, 8:210301–210317, 2020. [18](#)
- [59] Alexander Kirillov, Eric Mintun, Nikhila Ravi, Hanzi Mao, Chloe Rolland, Laura Gustafson, Tete Xiao, Spencer Whitehead, Alexander C. Berg, Wan-Yen Lo, Piotr Dollár, and Ross Girshick. Segment anything. In *ICCV*, 2023. [1](#), [2](#), [3](#), [5](#)
- [60] Theodora Kontogianni, Michael Gygli, Jasper Uijlings, and Vittorio Ferrari. Continuous adaptation for interactive object segmentation by learning from corrections. In *Computer Vision—ECCV 2020: 16th European Conference, Glasgow, UK, August 23–28, 2020, Proceedings, Part XVI 16*, pages 579–596. Springer, 2020. [2](#)
- [61] Markus Krönke, Christine Eilers, Desislava Dimova, Melanie Köhler, Gabriel Buschner, Lilit Schweiger, Lemoonia Konstantinidou, Marcus Makowski, James Nagarajah, Nassir Navab, et al. Tracked 3d ultrasound and deep neural network-based thyroid segmentation reduce interobserver variability in thyroid volumetry. *Plos one*, 17(7):e0268550, 2022. [4](#), [18](#)
- [62] Hugo J Kuijff, J Matthijs Biesbroek, Jeroen De Bresser, Rutger Heinen, Simon Andermatt, Mariana Bento, Matt Berseth, Mikhail Belyaev, M Jorge Cardoso, Adria Casamitjana, et al. Standardized assessment of automatic segmentation of white matter hyperintensities and results of the wmh segmentation challenge. *IEEE transactions on medical imaging*, 38(11):2556–2568, 2019. [4](#), [18](#)
- [63] Maria Kuklisova-Murgasova, Paul Aljabar, Latha Srinivasan, Serena J Counsell, Valentina Doria, Ahmed Serag, Ioannis S Gousias, James P Boardman, Mary A Rutherford, A David Edwards, et al. A dynamic 4d probabilistic atlas of the developing brain. *NeuroImage*, 54(4):2750–2763, 2011. [4](#), [18](#)
- [64] Zoé Lambert, Caroline Petitjean, Bernard Dubray, and Su Kuan. Segthor: segmentation of thoracic organs at risk in ct images. In *2020 Tenth International Conference on Image Processing Theory, Tools and Applications (IPTA)*, pages 1–6. IEEE, 2020. [4](#), [18](#)
- [65] Shiyi Lan, Zhiding Yu, Christopher Choy, Subhashree Radhakrishnan, Guilin Liu, Yuke Zhu, Larry S Davis, and Anima Anandkumar. Discobox: Weakly supervised instance

- segmentation and semantic correspondence from box supervision. In *Proceedings of the IEEE/CVF International Conference on Computer Vision*, pages 3406–3416, 2021. 2
- [66] Bennett Landman, Zhoubing Xu, J Igelsias, Martin Styner, T Langerak, and Arno Klein. Miccai multi-atlas labeling beyond the cranial vault—workshop and challenge. In *Proc. MICCAI Multi-Atlas Labeling Beyond Cranial Vault Workshop Challenge*, page 12, 2015. 4, 5, 16, 17, 18
- [67] Sarah Leclerc, Erik Smistad, Joao Pedrosa, Andreas Østvik, Frederic Cervenansky, Florian Espinosa, Torvald Espeland, Erik Andreas Rye Berg, Pierre-Marc Jodoin, Thomas Grenier, et al. Deep learning for segmentation using an open large-scale dataset in 2d echocardiography. *IEEE transactions on medical imaging*, 38(9):2198–2210, 2019. 18
- [68] Guillaume Lemaître, Robert Martí, Jordi Freixenet, Joan C Vilanova, Paul M Walker, and Fabrice Meriaudeau. Computer-aided detection and diagnosis for prostate cancer based on mono and multi-parametric mri: a review. *Computers in biology and medicine*, 60:8–31, 2015. 4, 18
- [69] Mingchao Li, Yuhan Zhang, Zexuan Ji, Keren Xie, Songtao Yuan, Qinghuai Liu, and Qiang Chen. Ipn-v2 and octa-500: Methodology and dataset for retinal image segmentation. *arXiv preprint arXiv:2012.07261*, 2020. 4, 18
- [70] Zihan Li, Yuan Zheng, Xiangde Luo, Dandan Shan, and Qingqi Hong. Scribblevc: Scribble-supervised medical image segmentation with vision-class embedding. In *Proceedings of the 31st ACM International Conference on Multimedia*, pages 3384–3393, 2023. 2
- [71] Di Lin, Jifeng Dai, Jiaya Jia, Kaiming He, and Jian Sun. Scribblesup: Scribble-supervised convolutional networks for semantic segmentation. In *Proceedings of the IEEE conference on computer vision and pattern recognition*, pages 3159–3167, 2016. 2
- [72] Tsung-Yi Lin, Priya Goyal, Ross Girshick, Kaiming He, and Piotr Dollár. Focal loss for dense object detection. In *Proceedings of the IEEE international conference on computer vision*, pages 2980–2988, 2017. 5
- [73] Xian Lin, Yangyang Xiang, Li Zhang, Xin Yang, Zengqiang Yan, and Li Yu. Samus: Adapting segment anything model for clinically-friendly and generalizable ultrasound image segmentation, 2023. 2
- [74] Geert Litjens, Robert Toth, Wendy van de Ven, Caroline Hoeks, Sjoerd Kerkstra, Bram van Ginneken, Graham Vincent, Gwenaél Guillard, Neil Birbeck, Jindang Zhang, et al. Evaluation of prostate segmentation algorithms for mri: the promise12 challenge. *Medical image analysis*, 18(2):359–373, 2014. 4, 18
- [75] Leyao Liu, Tao Kong, Minzhao Zhu, Jiashuo Fan, and Lu Fang. Clickseg: 3d instance segmentation with click-level weak annotations. *arXiv preprint arXiv:2307.09732*, 2023. 2
- [76] Qin Liu, Zhenlin Xu, Gedas Bertasius, and Marc Niethammer. Simpleclick: Interactive image segmentation with simple vision transformers. In *Proceedings of the IEEE/CVF International Conference on Computer Vision*, pages 22290–22300, 2023. 2, 5
- [77] Qin Liu, Jaemin Cho, Mohit Bansal, and Marc Niethammer. Rethinking interactive image segmentation with low latency high quality and diverse prompts. In *Proceedings of the IEEE/CVF Conference on Computer Vision and Pattern Recognition*, pages 3773–3782, 2024. 2, 5
- [78] Zhengzhe Liu, Xiaojuan Qi, and Chi-Wing Fu. One thing one click: A self-training approach for weakly supervised 3d semantic segmentation. In *Proceedings of the IEEE/CVF conference on computer vision and pattern recognition*, pages 1726–1736, 2021. 2
- [79] Vebjorn Ljosa, Katherine L Sokolnicki, and Anne E Carpenter. Annotated high-throughput microscopy image sets for validation. *Nature methods*, 9(7):637–637, 2012. 4, 18
- [80] Maximilian T Löffler, Anjany Sekuboyina, Alina Jacob, Anna-Lena Grau, Andreas Scharr, Malek El Husseini, Mareike Kallweit, Claus Zimmer, Thomas Baum, and Jan S Kirschke. A vertebral segmentation dataset with fracture grading. *Radiology: Artificial Intelligence*, 2(4):e190138, 2020. 4, 18
- [81] Xiangde Luo, Wenjun Liao, Jianghong Xiao, Tao Song, Xiaofan Zhang, Kang Li, Guotai Wang, and Shaoting Zhang. Word: Revisiting organs segmentation in the whole abdominal region. *arXiv preprint arXiv:2111.02403*, 2021. 4, 18
- [82] Xiangde Luo, Guotai Wang, Tao Song, Jingyang Zhang, Michael Aertsen, Jan Deprest, Sebastien Ourselin, Tom Vercauteren, and Shaoting Zhang. Mideepseg: Minimally interactive segmentation of unseen objects from medical images using deep learning. *Medical image analysis*, 72: 102102, 2021. 1, 2
- [83] Xiangde Luo, Minhao Hu, Wenjun Liao, Shuwei Zhai, Tao Song, Guotai Wang, and Shaoting Zhang. Scribble-supervised medical image segmentation via dual-branch network and dynamically mixed pseudo labels supervision. In *International Conference on Medical Image Computing and Computer-Assisted Intervention*, pages 528–538. Springer, 2022. 2
- [84] Jun Ma, Yao Zhang, Song Gu, Xingle An, Zhihe Wang, Cheng Ge, Congcong Wang, Fan Zhang, Yu Wang, Yinan Xu, et al. Fast and low-gpu-memory abdomen ct organ segmentation: the flare challenge. *Medical Image Analysis*, 82: 102616, 2022. 18
- [85] Jun Ma, Yuting He, Feifei Li, Lin Han, Chenyu You, and Bo Wang. Segment anything in medical images. *Nature Communications*, 15:1–9, 2024. 1, 2, 5
- [86] Yuhui Ma, Huaying Hao, Jianyang Xie, Huazhu Fu, Jiong Zhang, Jianlong Yang, Zhen Wang, Jiang Liu, Yalin Zheng, and Yitian Zhao. Rose: a retinal oct-angiography vessel segmentation dataset and new model. *IEEE Transactions on Medical Imaging*, 40(3):928–939, 2021. 4, 18
- [87] Jacob A. Macdonald, Zhe Zhu, Brandon Konkel, Maciej Mazurowski, Walter Wiggins, and Mustafa Bashir. Duke liver dataset (MRI) v2, 2023. 4, 18
- [88] Daniel S Marcus, Tracy H Wang, Jamie Parker, John G Csernansky, John C Morris, and Randy L Buckner. Open access series of imaging studies (oasis): cross-sectional mri data in young, middle aged, nondemented, and demented older adults. *Journal of cognitive neuroscience*, 19(9): 1498–1507, 2007. 4, 18

- [89] Kenneth Marek, Danna Jennings, Shirley Lasch, Andrew Siderowf, Caroline Tanner, Tanya Simuni, Chris Coffey, Karl Kieburtz, Emily Flagg, Sohini Chowdhury, et al. The parkinson progression marker initiative (ppmi). *Progress in neurobiology*, 95(4):629–635, 2011. 4, 18
- [90] Francesco Marzola, Nens Van Alfen, Jonne Doorduyn, and Kristen M. Meiburger. Deep learning segmentation of transverse musculoskeletal ultrasound images for neuromuscular disease assessment. *Computers in Biology and Medicine*, 135:104623, 2021. 18
- [91] Maciej A Mazurowski, Kal Clark, Nicholas M Czarnek, Parisa Shamsesfandabadi, Katherine B Peters, and Ashirbani Saha. Radiogenomics of lower-grade glioma: algorithmically-assessed tumor shape is associated with tumor genomic subtypes and patient outcomes in a multi-institutional study with the cancer genome atlas data. *Journal of neuro-oncology*, 133:27–35, 2017. 4, 18
- [92] Bjoern Menze, Leo Joskowicz, Spyridon Bakas, Andras Jakab, Ender Konukoglu, Anton Becker, Amber Simpson, and Richard D. Quantification of uncertainties in biomedical image quantification 2021. *4th International Conference on Medical Image Computing and Computer Assisted Intervention (MICCAI 2021)*, 2021. 18
- [93] Bjoern H Menze, Andras Jakab, Stefan Bauer, Jayashree Kalpathy-Cramer, Keyvan Farahani, Justin Kirby, Yuliya Burren, Nicole Porz, Johannes Slotboom, Roland Wiest, et al. The multimodal brain tumor image segmentation benchmark (brats). *IEEE transactions on medical imaging*, 34(10):1993–2024, 2014. 18
- [94] Anna Montoya, Hasnin, kaggle446, shirzad, Will Cukierski, and yffud. Ultrasound nerve segmentation, 2016. 4, 18
- [95] Jay N Paranjape, Nithin Gopalakrishnan Nair, Shameema Sikder, S Swaroop Vedula, and Vishal M Patel. Adaptesam: Towards efficient tuning of sam for surgical scene segmentation. *arXiv preprint arXiv:2308.03726*, 2023. 2
- [96] Kelly Payette, Priscille de Dumast, Hamza Kebiri, Ivan Ezhov, Johannes C Paetzold, Suprosanna Shit, Asim Iqbal, Romesa Khan, Raimund Kottke, Patrice Grehten, et al. An automatic multi-tissue human fetal brain segmentation benchmark using the fetal tissue annotation dataset. *Scientific Data*, 8(1):1–14, 2021. 18
- [97] Lina Pedraza, Carlos Vargas, Fabián Narváez, Oscar Durán, Emma Muñoz, and Eduardo Romero. An open access thyroid ultrasound image database. In *10th international symposium on medical information processing and analysis*, page 92870W. SPIE / International Society for Optics and Photonics, 2015. 4, 18
- [98] Gašper Podobnik, Primož Strojjan, Primož Peterlin, Bulat Ibragimov, and Tomaz Vrtovec. HaN-Seg: The head and neck organ-at-risk CT and MR segmentation dataset. *Medical Physics*, 50(3):1917–1927, 2023. <https://aapm.onlinelibrary.wiley.com/doi/pdf/10.1002/mp.16197>. [110] 4, 18
- [99] Prasanna Porwal, Samiksha Pachade, Ravi Kamble, Manesh Kokare, Girish Deshmukh, Vivek Sahasrabudde, and Fabrice Meriaudeau. Indian diabetic retinopathy image dataset (idrid), 2018. 4, 18
- [100] Perry Radau, Yingli Lu, Kim Connelly, Gideon Paul, AJWG Dick, and Graham Wright. Evaluation framework for algorithms segmenting short axis cardiac mri. *The MIDAS Journal-Cardiac MR Left Ventricle Segmentation Challenge*, 49, 2009. 4, 5, 16, 17
- [101] Marianne Rakic, Hallee E. Wong, Jose Javier Gonzalez Ortiz, Beth Cimmini, John V. Guttag, and Adrian V. Dalca. Tyche: Stochastic in-context learning for medical image segmentation. *Computer Vision and Pattern Recognition (CVPR)*, 2024. 2, 4, 16, 17
- [102] Amin Ranem, Mohamed Afham Mohamed Aflal, Moritz Fuchs, and Anirban Mukhopadhyay. Uncle sam: Unleashing sam’s potential for continual prostate mri segmentation. In *Medical Imaging with Deep Learning*, 2024. 2
- [103] Nikhila Ravi, Valentin Gabeur, Yuan-Ting Hu, Ronghang Hu, Chaitanya Ryali, Tengyu Ma, Haitham Khedr, Roman Rädle, Chloe Rolland, Laura Gustafson, et al. Sam 2: Segment anything in images and videos. *arXiv preprint arXiv:2408.00714*, 2024. 2
- [104] Blaine Rister, Darvin Yi, Kaushik Shivakumar, Tomomi Nobashi, and Daniel L. Rubin. CT-ORG, a new dataset for multiple organ segmentation in computed tomography. *Scientific Data*, 7(1):381, 2020. 4, 18
- [105] Olaf Ronneberger, Philipp Fischer, and Thomas Brox. U-net: Convolutional networks for biomedical image segmentation. In *Medical Image Computing and Computer-Assisted Intervention—MICCAI 2015: 18th International Conference, Munich, Germany, October 5-9, 2015, Proceedings, Part III 18*, pages 234–241. Springer, 2015. 3, 4
- [106] Holger R. Roth, Dong Yang, Ziyue Xu, Xiaosong Wang, and Daguang Xu. Going to Extremes: Weakly Supervised Medical Image Segmentation. *Machine Learning and Knowledge Extraction*, 3(2):507–524, 2021. 2
- [107] Tomas Sakinis, Fausto Milletari, Holger Roth, Panagiotis Korfiatis, Petro Kostandy, Kenneth Philbrick, Zeynettin Akkus, Ziyue Xu, Daguang Xu, and Bradley J. Erickson. Interactive segmentation of medical images through fully convolutional neural networks, 2019. [arXiv:1903.08205](https://arxiv.org/abs/1903.08205). 2
- [108] Adriel Saporta, Xiaotong Gui, Ashwin Agrawal, Anuj Pareek, SQ Truong, CD Nguyen, Van-Doan Ngo, Jayne Seekins, Francis G Blankenberg, AY Ng, et al. Deep learning saliency maps do not accurately highlight diagnostically relevant regions for medical image interpretation. *MedRxiv*, 2021. 4, 18
- [109] Constantin Seibold, Simon Reiß, Saquib Sarfraz, Matthias A. Fink, Victoria Mayer, Jan Sellner, Moon Sung Kim, Klaus H. Maier-Hein, Jens Kleesiek, and Rainer Stiefelhagen. Detailed annotations of chest x-rays via ct projection for report understanding. In *Proceedings of the 33th British Machine Vision Conference (BMVC)*, 2022. 4, 18
- [110] Ahmed Serag, Paul Aljabar, Gareth Ball, Serena J Counsell, James P Boardman, Mary A Rutherford, A David Edwards, Joseph V Hajnal, and Daniel Rueckert. Construction of a consistent high-definition spatio-temporal atlas of the developing brain using adaptive kernel regression. *Neuroimage*, 59(3):2255–2265, 2012. 18

- [111] Arnaud Arindra Adiyoso Setio, Alberto Traverso, Thomas De Bel, Moira SN Berens, Cas Van Den Bogaard, Piergiorgio Cerello, Hao Chen, Qi Dou, Maria Evelina Fantacci, Bram Geurts, et al. Validation, comparison, and combination of algorithms for automatic detection of pulmonary nodules in computed tomography images: the luna16 challenge. *Medical image analysis*, 42:1–13, 2017. 4, 18
- [112] Amber L Simpson, Michela Antonelli, Spyridon Bakas, Michel Bilello, Keyvan Farahani, Bram Van Ginneken, Annette Kopp-Schneider, Bennett A Landman, Geert Litjens, Bjoern Menze, et al. A large annotated medical image dataset for the development and evaluation of segmentation algorithms. *arXiv preprint arXiv:1902.09063*, 2019. 4, 18
- [113] Konstantin Sofiiuk, Iliia Petrov, Olga Barinova, and Anton Konushin. F-BRS: Rethinking Backpropagating Refinement for Interactive Segmentation. In *2020 IEEE/CVF Conference on Computer Vision and Pattern Recognition (CVPR)*, pages 8620–8629, Seattle, WA, USA, 2020. IEEE. 2
- [114] Konstantin Sofiiuk, Iliia A. Petrov, and Anton Konushin. Reviving Iterative Training with Mask Guidance for Interactive Segmentation, 2021. arXiv:2102.06583 [cs]. 5
- [115] Yuxin Song, Jing Zheng, Long Lei, Zhipeng Ni, Baoliang Zhao, and Ying Hu. CT2US: Cross-modal transfer learning for kidney segmentation in ultrasound images with synthesized data. *Ultrasonics*, 122:106706, 2022. 4, 18
- [116] Joes Staal, Michael D Abràmoff, Meindert Niemeijer, Max A Viergever, and Bram Van Ginneken. Ridge-based vessel segmentation in color images of the retina. *IEEE transactions on medical imaging*, 23(4):501–509, 2004. 4, 17
- [117] Zhi Tian, Chunhua Shen, Xinlong Wang, and Hao Chen. Boxinst: High-performance instance segmentation with box annotations. In *Proceedings of the IEEE/CVF Conference on Computer Vision and Pattern Recognition*, pages 5443–5452, 2021. 2
- [118] Bram van Ginneken, Mikkel B. Stegmann, and Marco Loog. Segmentation of anatomical structures in chest radiographs using supervised methods: a comparative study on a public database. *Medical Image Analysis*, 10(1):19–40, 2006. 4, 5, 6, 7, 17, 20
- [119] Santiago Vitale, José Ignacio Orlando, Emmanuel Iarussi, and Ignacio Larrabide. Improving realism in patient-specific abdominal ultrasound simulation using cyclegans. *International journal of computer assisted radiology and surgery*, 15(2):183–192, 2020. 18
- [120] Chengliang Wang, Xinrun Chen, Haojian Ning, and Shiyang Li. Sam-octa: A fine-tuning strategy for applying foundation model to octa image segmentation tasks, 2023. 2
- [121] Guotai Wang, Maria A Zuluaga, Rosalind Pratt, Michael Aertsen, Tom Doel, Maria Klusmann, Anna L David, Jan Deprest, Tom Vercauteren, and Sebastien Ourselin. Dynamically Balanced Online Random Forests for Interactive Scribble-Based Segmentation. In *Medical Image Computing and Computer-Assisted Intervention*, 2016. 2
- [122] Guotai Wang, Wenqi Li, Maria A. Zuluaga, Rosalind Pratt, Premal A. Patel, Michael Aertsen, Tom Doel, Anna L. David, Jan Deprest, Sebastien Ourselin, and Tom Vercauteren. Interactive Medical Image Segmentation Using Deep Learning With Image-Specific Fine Tuning. *IEEE Transactions on Medical Imaging*, 37(7):1562–1573, 2018. 2
- [123] Guotai Wang, Maria A Zuluaga, Wenqi Li, Rosalind Pratt, Premal A Patel, Michael Aertsen, Tom Doel, Anna L David, Jan Deprest, Sébastien Ourselin, et al. Deepigeos: a deep interactive geodesic framework for medical image segmentation. *IEEE transactions on pattern analysis and machine intelligence*, 41(7):1559–1572, 2018. 2
- [124] Xinlong Wang, Xiaosong Zhang, Yue Cao, Wen Wang, Chunhua Shen, and Tiejun Huang. Seggpt: Towards segmenting everything in context. In *Proceedings of the IEEE/CVF International Conference on Computer Vision*, pages 1130–1140, 2023. 2
- [125] Jakob Wasserthal, Hanns-Christian Breit, Manfred T Meyer, Maurice Pradella, Daniel Hinck, Alexander W Sauter, Tobias Heye, Daniel T Boll, Joshy Cyriac, Shan Yang, et al. Totalsegmentator: Robust segmentation of 104 anatomic structures in ct images. *Radiology: Artificial Intelligence*, 5(5), 2023. 6
- [126] Hallee E. Wong, Marianne Rakic, John Gutttag, and Adrian V. Dalca. Scribbleprompt: Fast and flexible interactive segmentation for any medical image. *European Conference on Computer Vision (ECCV)*, 2024. 1, 2, 3, 4, 5, 6, 16, 21
- [127] Chenwei Wu, David Restrepo, Zitao Shuai, Zhongming Liu, and Liyue Shen. Efficient in-context medical segmentation with meta-driven visual prompt selection. In *International Conference on Medical Image Computing and Computer-Assisted Intervention*, pages 255–265. Springer, 2024. 8
- [128] Junde Wu and Min Xu. One-prompt to segment all medical images. In *Computer Vision and Pattern Recognition (CVPR)*, pages 11302–11312, 2024. 2, 6, 16, 17, 19, 21
- [129] Junde Wu, Wei Ji, Yuanpei Liu, Huazhu Fu, Min Xu, Yanwu Xu, and Yueming Jin. Medical sam adapter: Adapting segment anything model for medical image segmentation. *arXiv preprint arXiv:2304.12620*, 2023. 2
- [130] Ning Xu, Brian Price, Scott Cohen, Jimei Yang, and Thomas Huang. Deep Interactive Object Selection. In *2016 IEEE Conference on Computer Vision and Pattern Recognition (CVPR)*, pages 373–381, Las Vegas, NV, USA, 2016. IEEE. 5
- [131] Ning Xu, Brian Price, Scott Cohen, Jimei Yang, and Thomas Huang. Deep GrabCut for Object Selection. arXiv, 2017. arXiv:1707.00243 [cs]. 2
- [132] Jin Ye, Junlong Cheng, Jianpin Chen, Zhongying Deng, Tianbin Li, Haoyu Wang, Yanzhou Su, Ziyang Huang, Jilong Chen, Lei Jiang, et al. Sa-med2d-20m dataset: Segment anything in 2d medical imaging with 20 million masks. *arXiv preprint arXiv:2311.11969*, 2023. 5
- [133] Paul A Yushkevich, Joseph Piven, Heather Cody Hazlett, Rachel Gimpel Smith, Sean Ho, James C Gee, and Guido Gerig. User-guided 3d active contour segmentation of anatomical structures: significantly improved efficiency and reliability. *Neuroimage*, 31(3):1116–1128, 2006. 1

- [134] Kaidong Zhang and Dong Liu. Customized segment anything model for medical image segmentation, 2023. [2](#)
- [135] Ke Zhang and Xiahai Zhuang. Cyclemix: A holistic strategy for medical image segmentation from scribble supervision. In *Proceedings of the IEEE/CVF Conference on Computer Vision and Pattern Recognition*, pages 11656–11665, 2022. [2](#)
- [136] Shiyin Zhang, Jun Hao Liew, Yunchao Wei, Shikui Wei, and Yao Zhao. Interactive Object Segmentation With Inside-Outside Guidance. In *2020 IEEE/CVF Conference on Computer Vision and Pattern Recognition (CVPR)*, pages 12231–12241. IEEE, 2020. [2](#)
- [137] Yingtao Zhang, Min Xian, Heng-Da Cheng, Bryar Shareef, Jianrui Ding, Fei Xu, Kuan Huang, Boyu Zhang, Chunping Ning, and Ying Wang. Busis: A benchmark for breast ultrasound image segmentation. In *Healthcare*, page 729. MDPI, 2022. [4](#), [18](#)
- [138] Amy Zhao, Guha Balakrishnan, Fredo Durand, John V. Guttag, and Adrian V. Dalca. Data augmentation using learned transformations for one-shot medical image segmentation. In *Proceedings of the IEEE/CVF Conference on Computer Vision and Pattern Recognition (CVPR)*, 2019. [5](#), [17](#)
- [139] Qi Zhao, Shuchang Lyu, Wenpei Bai, Linghan Cai, Binghao Liu, Meijing Wu, Xiubo Sang, Min Yang, and Lijiang Chen. A multi-modality ovarian tumor ultrasound image dataset for unsupervised cross-domain semantic segmentation. *CoRR*, abs/2207.06799, 2022. [4](#), [18](#)
- [140] Ervine Zheng, Qi Yu, Rui Li, Pengcheng Shi, and Anne Haake. A continual learning framework for uncertainty-aware interactive image segmentation. In *Proceedings of the AAAI Conference on Artificial Intelligence*, pages 6030–6038, 2021. [2](#)
- [141] Guoyan Zheng, Chengwen Chu, Daniel L Belavý, Bulat Ibragimov, Robert Korez, Tomáš Vrtovec, Hugo Hutt, Richard Everson, Judith Meakin, Isabel López Andrade, et al. Evaluation and comparison of 3d intervertebral disc localization and segmentation methods for 3d t2 mr data: A grand challenge. *Medical image analysis*, 35:327–344, 2017. [4](#), [5](#), [16](#), [17](#)
- [142] Xin Zheng, Yong Wang, Guoyou Wang, and Jianguo Liu. Fast and robust segmentation of white blood cell images by self-supervised learning. *Micron*, 107:55–71, 2018. [4](#), [5](#), [6](#), [7](#), [17](#), [20](#)

MultiverSeg: Scalable Interactive Segmentation of Biomedical Imaging Datasets with In-Context Guidance

Supplementary Material

A. MultiverSeg Method

A.1. Architecture

CrossConv. We implement the CrossConvolutional layer slightly differently from [16]. To avoid duplicate convolutions on the context features v_i in Eq. (4), we partition weights θ_z channel-wise into $\{\theta_{z_1}, \theta_{z_2}\}$ and implement $z_i = LN(A(\text{Conv}(q, \theta_{z_1}) + \text{Conv}(v_i, \theta_{z_2})))$ where q is the target feature map and v_i is the feature map corresponding to context set entry i . We zero out the bias terms in $\text{Conv}(\cdot, \theta_{z_2})$ such that the computation is equivalent to $z_i = LN(A(\text{Conv}(q || v_i; \theta_z)))$.

Network. We implement $f_\theta(\cdot)$ using an encoder with 5 encoder CrossBlock stages and a decoder with 4 CrossBlock stages. Each stage has 256 output features and LeakyReLU non-linearities after each convolution. We use bilinear interpolation for upsampling and downsampling.

The CrossBlock mechanism requires at least one context set entry. If the context set is empty, we use a dummy context set entry consisting of an image and segmentation with uniform value of 0.5.

B. Data

B.1. Datasets

We build on large dataset gathering efforts like MegaMedical [16, 101, 126] to compile a collection of 78 open-access biomedical imaging datasets for training and evaluation, covering over 54k scans, 16 image types, and 713 labels.

Division of Datasets. The division of datasets and subjects for training, model selection, and evaluation is summarized in Tab. 1. The 78 datasets were divided into 67 training datasets (Tab. 3 and 11 evaluation datasets (Tab. 2). Data from 9 (out of 11) of the evaluation datasets were used for model selection and final evaluation. The other 2 evaluation datasets were completely held-out from model selection and only used in the final evaluation.

Division of Subjects. We split each dataset into 60% train, 20% validation, and 20% test by subject. We used the “train” splits from the 67 training datasets to train MultiverSeg models. We use the “validation” splits from the 67 training datasets and 9 validation datasets to select the best model checkpoint. We report final evaluation results across 11 held-out “test” splits of the 11 evaluation datasets to maximize the diversity of tasks and modalities in our evaluation set (Tab. 2). No data from the 9 validation datasets or

2 test datasets were seen by MultiverSeg during training.

Task Definition. We define a 2D segmentation task as a combination of (sub)dataset, axis (for 3D modalities), and label. For datasets with multiple segmentation labels, we consider each label separately as a binary segmentation task. For datasets with sub-datasets (e.g., malignant vs. benign lesions) we consider each cohort as a separate task. For multi-annotator datasets, we treat each annotator as a separate label. For instance segmentation datasets, we considered all instances as a single label.

3D Datasets. For 3D modalities, we use the slice with maximum label area (“maxslice”) and the middle slice (“midslice”) for each volume for training of MultiverSeg. For the 3D evaluation datasets (BTCV Cervix [66], ACDC [11], SCD [100], SpineWeb [141], COBRE [2]) we evaluated the slice with the maximum label area for each subject, as in [126]. We also considered evaluating on the middle slice, as in [16, 101, 128] and saw similar trends on the validation data. However, we opted for evaluation on maxslices because for our 3D test dataset (COBRE) some labels do not appear in the midslices. Due to the large number of tasks in COBRE, we only consider coronal slices from COBRE for evaluation.

Data Processing. We rescale image intensities to [0,1] and resize images to 128x128.

Data Sampling. During training, we sample image, segmentation pairs hierarchically – by dataset and modality, axis, and then label – to balance training on datasets of different sizes.

B.2. Synthetic Task Generation

We introduce a new approach for constructing synthetic tasks from real images. Given a single image x_0 , we construct a set of images $\{x'_i, y'_i\}_{i=1}^{m+1}$ representing a synthetic task. We then partition this set into a target example and context set of size m for training.

Related Work. Although previous work found that training on a mix of real and synthetic segmentation labels based on image superpixels is useful for improving generalization in interactive segmentation [126], we do not use such data here. That approach cannot be directly applied to MultiverSeg because it does not produce semantically consistent labels across multiple images.

Method. To build a synthetic task from an image, we first generate a synthetic label and then perform aggressive aug-

Table 1. **Dataset split overview.** Each dataset was split into 60% train, 20% validation and 20% test by subject. Data from the “train” splits of the 67 training datasets were used to train the models. The MultiverSeg models did not see any data from the validation datasets or test datasets during training. Data from the “validation” split of the 9 validation datasets was used for MultiverSeg (MVS) model selection and experimenting with different evaluation methods of baselines. We report final results on the held-out test splits of 11 evaluation datasets: data from the “test” splits of the 9 validation datasets and the “test” splits of the 2 test datasets. To train the fully-supervised nnUNet baselines, we used the training and validation splits of the 11 evaluation datasets.

Dataset Group	No. Datasets	Split within each dataset by subject		
		Training Split (60%)	Validation Split (20%)	Test Split (20%)
Training Datasets	67	MVS training	MVS model selection	Not used
Validation Datasets	9	nnUNet training	MVS and baselines model selection, nnUNet training	Final evaluation
Test Datasets	2	nnUNet training	nnUNet training	Final evaluation

Table 2. **Evaluation datasets.** We assembled the following set of datasets to evaluate MultiverSeg and baseline methods. For the relative size of datasets, we include the number of unique scans (subject and modality pairs) and labels that each dataset has. These datasets were unseen by MultiverSeg during training. Three datasets were completely held-out from model selection. The validation splits of the other 9 datasets were used for selecting the best model checkpoint. We report final results on the test splits of these 11 datasets.

Dataset Name	Description	Scans	Labels	Modalities
ACDC [11]	Left and right ventricular endocardium	99	3	cine-MRI
BTCV Cervix [66]	Bladder, uterus, rectum, small bowel	30	4	CT
BUID [3]	Breast tumors	647	2	Ultrasound
COBRE [2, 22, 29]	Brain anatomy	258	45	T1-weighted MRI
DRIVE [116]	Blood vessels in retinal images	20	1	Optical camera
HipXRray [40]	Ilium and femur	140	2	X-Ray
PanDental [1]	Mandible and teeth	215	2	X-Ray
SCD [100]	Sunnybrook Cardiac Multi-Dataset Collection	100	1	cine-MRI
SCR [118]	Lungs, heart, and clavicles	247	5	X-Ray
SpineWeb [141]	Vertebrae	15	1	T2-weighted MRI
WBC [142]	White blood cell cytoplasm and nucleus	400	2	Microscopy

mentations to create a set of images corresponding to the same synthetic task (Fig. 8).

Given an image x_0 , we first generate a synthetic label y_{synth} by applying a superpixel algorithm [28] with scale parameter $\lambda \sim U[1, \lambda_{max}]$ to partition the image into a multi-label mask of k superpixels $z \in \{1, \dots, k\}^{n \times n}$. We then randomly select a superpixel $y_{synth} = \mathbb{1}(z = c)$ as a synthetic label.

To generate a set of $m + 1$ images representing the same task, we duplicate (x_0, y_{synth}) , $m + 1$ times and apply aggressive augmentations to vary the images and segmentation labels [16, 138].

Implementation. MultiverSeg was trained with $p_{synth} = 0.5$. We use a superpixel algorithm [28] with $\lambda \sim [1, 500]$. Tab. 4 lists the data augmentations.

B.3. Data Augmentation

Tab. 5 shows the within-task augmentations and task-augmentations used to train MultiverSeg [16, 101].

C. Experimental Setup

C.1. Baselines

We provide additional details on the baselines. We summarize the capabilities of our method and baselines in Tab. 6.

UniverSeg. Previous work found that ensembling UniverSeg predictions across multiple randomly sampled context sets improved Dice score [16]. We report results *without* ensembling to accurately reflect the mean Dice of predictions given a fixed size context set.

OnePrompt. OnePrompt [128] is a medical image segmentation model that can perform in-context segmentation of a target image given a single context example with scrib-

Table 3. **Train datasets.** We train MultiverSeg on the following datasets. For the relative size of datasets, we have included the number of unique scans (subject and modality pairs) that each dataset has.

Dataset Name	Description	Scans	Modalities
AbdominalUS [119]	Abdominal organ segmentation	1,543	Ultrasound
AMOS [52]	Abdominal organ segmentation	240	CT, MRI
BBBC003 [79]	Mouse embryos	15	Microscopy
BBBC038 [17]	Nuclei instance segmentation	670	Microscopy
BrainDev [36, 37, 63, 110]	Adult and neonatal brain atlases	53	Multimodal MRI
BrainMetShare[39]	Brain tumors	420	Multimodal MRI
BRATS [7, 8, 93]	Brain tumors	6,096	Multimodal MRI
BTCV Abdominal [66]	13 abdominal organs	30	CT
BUSIS [137]	Breast tumors	163	Ultrasound
CAMUS [67]	Four-chamber and Apical two-chamber heart	500	Ultrasound
CDemris [53]	Human left atrial wall	60	CMR
CHAOS [54, 55]	Abdominal organs (liver, kidneys, spleen)	40	CT, T2-weighted MRI
CheXplanation [108]	Chest X-Ray observations	170	X-Ray
CoNSEP	Histopathology Nuclei	27	Microscopy
CT2US [115]	Liver segmentation in synthetic ultrasound	4,586	Ultrasound
CT-ORG[104]	Abdominal organ segmentation (overlap with LiTS)	140	CT
DDTI [97]	Thyroid segmentation	472	Ultrasound
DukeLiver [87]	Liver segmentation in abdominal MRI	310	MRI
EOPhtha [24]	Eye microaneurysms and diabetic retinopathy	102	Optical camera
FeTA [96]	Fetal brain structures	80	Fetal MRI
FetoPlac [9]	Placenta vessel	6	Fetosopic optical camera
FLARE [84]	Abdominal organs (liver, kidney, spleen, pancreas)	361	CT
HaN-Seg [98]	Head and neck organs at risk	84	CT, T1-weighted MRI
HMC-QU [25, 58]	4-chamber (A4C) and apical 2-chamber (A2C) left wall	292	Ultrasound
I2CVB [68]	Prostate (peripheral zone, central gland)	19	T2-weighted MRI
IDRID [99]	Diabetic retinopathy	54	Optical camera
ISBI-EM [18]	Neuronal structures in electron microscopy	30	Microscopy
ISIC [19]	Dermoscopic lesions	2,000	Dermatology
ISLES [42]	Ischemic stroke lesion	180	Multimodal MRI
KiTS [41]	Kidney and kidney tumor	210	CT
LGGFlair [15, 91]	TCIA lower-grade glioma brain tumor	110	MRI
LiTS [12]	Liver tumor	131	CT
LUNA [111]	Lungs	888	CT
MCIC [33]	Multi-site brain regions of schizophrenic patients	390	T1-weighted MRI
MMOTU [139]	Ovarian tumors	1,140	Ultrasound
MSD [112]	Large-scale collection of 10 medical segmentation datasets	3,225	CT, Multimodal MRI
MuscleUS [90]	Muscle segmentation (biceps and lower leg)	8,169	Ultrasound
NCI-ISBI [14]	Prostate	30	T2-weighted MRI
NerveUS [94]	Nerve segmentation	5,635	Ultrasound
OASIS [43, 88]	Brain anatomy	414	T1-weighted MRI
OCTA500 [69]	Retinal vascular	500	OCT/OCTA
PanNuke [30]	Nuclei instance segmentation	7,901	Microscopy
PAXRay [109]	92 labels covering lungs, mediastinum, bones, and sub-diaphragm in Chest X-Ray	852	X-Ray
PROMISE12 [74]	Prostate	37	T2-weighted MRI
PPMI [21, 89]	Brain regions of Parkinson patients	1,130	T1-weighted MRI
QUBIQ [92]	Collection of 4 multi-annotator datasets (brain, kidney, pancreas and prostate)	209	T1-weighted MRI, Multimodal MRI, CT
ROSE [86]	Retinal vessel	117	OCT/OCTA
SegTHOR [64]	Thoracic organs (heart, trachea, esophagus)	40	CT
SegThy [61]	Thyroid and neck segmentation	532	MRI, Ultrasound
ssTEM [32]	Neuron membranes, mitochondria, synapses and extracellular space	20	Microscopy
STARE [44]	Blood vessels in retinal images	20	Optical camera
ToothSeg [50]	Individual teeth	598	X-Ray
VerSe [80]	Individual vertebrae	55	CT
WMH [62]	White matter hyper-intensities	60	Multimodal MRI
WORD [81]	Abdominal organ segmentation	120	CT

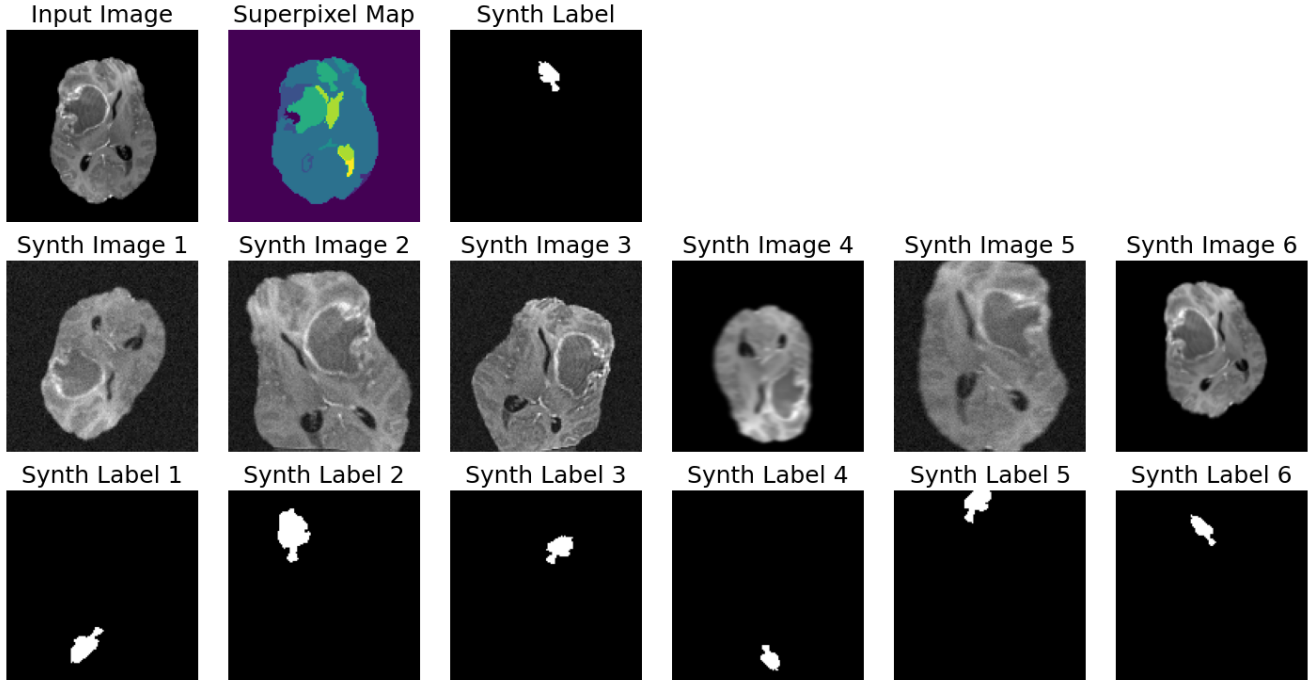

Figure 8. **Synthetic task generation example.** Given an input image, we apply a superpixel algorithm to generate a superpixel map of potential synthetic labels. We randomly sample one of the superpixels to serve as a synthetic label. Next, we duplicate the input image and synthetic label $m + 1$ times and apply data augmentations (Tab. 4) to vary the examples within the synthetic task. We use the first synthetic example as the target and the remaining m synthetic examples as the context set during training.

Augmentations	p	Parameters
Random Affine	0.8	degrees $\in [-25, 25]$ translation $\in [0, 0.2]$ scale $\in [0.9, 1.5]$
Brightness Contrast	0.5	brightness $\in [-0.1, 0.1]$ contrast $\in [0.5, 1.5]$
Elastic Transform	0.8	$\alpha \in [1, 10]$ $\sigma \in [8, 15]$
Sharpness	0.5	sharpness = 5
Gaussian Blur	0.5	$\sigma \in [0.1, 1.5]$ $k = 5$
Gaussian Noise	0.5	$\mu \in [0, 0.05]$ $\sigma \in [0, 0.05]$
Horizontal Flip	0.5	None
Vertical Flip	0.5	None

Table 4. **Data augmentations for generating synthetic tasks.** Given a set of $m + 1$ copies of the same example, we randomly sampled data augmentations for each instance to increase the diversity of examples within the task. Each augmentation is sampled with probability p .

ble, click, bounding box or mask annotation on the context image. OnePrompt can also be used for interactive

segmentation by using the same image as both the context image and the target image. We do not compare to OnePrompt because the pre-trained model weights are not publicly available. Recreating the data processing and re-training the model was beyond our computational capacity. For reference, the OnePrompt model required 64 NVIDIA A100 GPUs to train [128].

LabelAnything. LabelAnything [23] is an in-context segmentation model designed for few-shot multi-label segmentation of natural images. LabelAnything takes as input a target image to segment and a context set of images with multi-label mask, click, or bounding box annotations. We do not compare to LabelAnything because the pre-trained model weights are not publicly available. As with OnePrompt, recreating the data handling and retraining the model from scratch was beyond our computational capacity.

C.2. Metrics

Averaging. When reporting average performance for a dataset or across multiple datasets, we averaged metrics hierarchically by subject, label, axis, modality, subdataset, and then dataset.

Confidence Intervals. We show 95% confidence intervals from bootstrapping. For experiment 1, we bootstrap over

Augmentations	p	Parameters
Random Affine	0.25	degrees $\in [-25, 25]$ translation $\in [0, 0.1]$ scale $\in [0.9, 1.1]$
Brightness Contrast	0.25	brightness $\in [-0.1, 0.1]$ contrast $\in [0.5, 1.5]$
Elastic Transform	0.8	$\alpha \in [1, 2.5]$ $\sigma \in [7, 9]$
Sharpness	0.25	sharpness = 5
Gaussian Blur	0.25	$\sigma \in [0.1, 1.0]$ $k = 5$
Gaussian Noise	0.25	$\mu \in [0, 0.05]$ $\sigma \in [0, 0.05]$

(a) Within-Task Augmentations

Augmentations	p	Parameters
Random Affine	0.5	degrees $\in [0, 360]$ translates $\in [0, 0.2]$ scale $\in [0.8, 1.1]$
Brightness Contrast	0.5	brightness $\in [-0.1, 0.1]$ contrast $\in [0.8, 1.2]$
Gaussian Blur	0.5	$\sigma \in [0.1, 1.1]$ $k = 5$
Gaussian Noise	0.5	$\mu \in [0, 0.05]$ $\sigma \in [0, 0.05]$
Elastic Transform	0.5	$\alpha \in [1, 2]$ $\sigma \in [6, 8]$
Sharpness	0.5	sharpness = 5
Horizontal Flip	0.5	None
Vertical Flip	0.5	None
Sobel Edges Label	0.5	None
Flip Intensities	0.5	None

(b) Task Augmentations

Table 5. **Augmentations used to train MultiverSeg.** Within-task data augmentations (**top**) are randomly sampled for each example within a task to increase the diversity within a task. Task augmentations (**bottom**) are randomly sampled for each task and then applied to all examples in a task to increase the diversity of tasks. Each augmentation is randomly sampled with probability p . We apply augmentations after (optional) synthetic task generation and before simulating user interactions.

results from 200 simulations with different random seeds. For experiment 2, we bootstrap over subjects with 100 runs.

D. Experiment 1: Evaluation

D.1. Setup

We illustrate the process of segmenting a set of images using MultiverSeg in Fig. 10

Procedure. For all methods, we interactively segment a

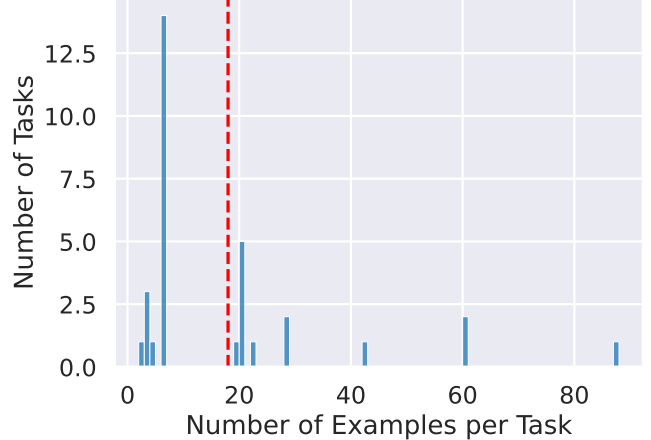

Figure 9. **Examples per task.** We visualize the distribution of examples per task in our validation data. We only consider tasks with at least 18 examples in Experiment 1.

seed image to 90% Dice using ScribblePrompt. This first image was randomly sampled (for each simulation round) from the training split. Since the number of interactions and the prediction for this seed image is the same for all methods, we exclude it from the reported results.

We report the number of interactions to achieve 90% Dice for each of the *next* 18 images from the held-out test split of our evaluation tasks. We conduct 200 rounds of simulations, randomly sampling 18 test images (without replacement) from each task and sequentially segmenting them using each method. We use the same random seeds for each method, so the sampled examples are the same across methods for each simulation round.

Tasks. We exclude tasks with fewer than 18 test examples, leaving 59 tasks from 7 evaluation datasets [1–3, 11, 40, 118, 142]. We selected this cutoff based on the distribution of task sizes in our validation data (Fig. 9) to focus on scenarios where a user wants to segment many similar images.

D.2. Results

D.2.1. Interactions per image as a function of dataset size

Results by dataset. As more examples are segmented and the context set grows, the number of clicks and scribbles required to get to 90% Dice on the n^{th} example using MultiverSeg decreases substantially. Fig. 11 shows results averaged by dataset. MultiverSeg and SP+UVS are less effective at reducing the number of clicks for tasks from BUID, a breast ultrasound lesion segmentation dataset, perhaps due to the heterogeneity of examples in that dataset.

Tasks with more examples. We show results by task for two datasets with more than 18 test examples per task (Fig. 12 and Fig. 13). For larger sets of images, using Multi-

Method	Interactive	In-Context	Interactive In-Context
ScribblePrompt [126]	✓		
UniverSeg [16]		✓	
LabelAnything [23]		✓	
OnePrompt [128]	✓	✓ (context size = 1)	
SP+UVS	✓	✓	✓
MultiverSeg (ours)	✓	✓	✓

Table 6. Summary of segmentation methods.

verSeg results in even greater reductions in the total number of user interactions.

Context Set Quality. For MultiverSeg and SP+UVS, thresholding the predictions before adding them to the context set improved performance (Fig. 14). We use the validation split of our validation data to select the best approach (soft or binary predictions in the context set) for each method.

MultiverSeg does not perform well when the context set contains *soft* predictions from previous examples, likely because it was trained with ground truth context labels. The number of interactions to 90% Dice is lowest when the context set contains ground truth labels, however this is not realistic in practice.

SP+UVS. Consistent with the original published results, we find that UniverSeg has poor performance for small context sets and initializing ScribblePrompt using the UniverSeg prediction hurts performance when the context set is small. In our final evaluation of SP+UVS, we set the minimum context set size to be 5 examples: when the context sets contains fewer than 5 examples, we ignore the context and only use ScribblePrompt to make predictions. Fig. 15 shows variations of SP+UVS with different minimum context set sizes.

Total Interactions. Fig. 16 shows the total number of interaction steps per set of 18 images by dataset. Tab. 7 shows the total number of interactions, average Dice score, and average 95th percentile Hausdorff distance across all tasks.

D.2.2. Bootstrapping In-Context Segmentation

Setup. For UniverSeg [16], a non-interactive in-context segmentation method, we segment the dataset by bootstrapping from a single context example with ground truth segmentation. For each image in the dataset, we make an in-context prediction and then add the prediction to the context set for the next image until all images in the dataset have been segmented. As an upper bound on performance, we also evaluated using ground truth labels in the context set instead of previously predicted segmentations (“UniverSeg (oracle)”).

Results. This approach did not produce accurate results, likely because UniverSeg has poor performance for small context sets and/or context sets with imperfect labels (Fig. 17a). Because UniverSeg does not have a mechanism to incorporate corrections, it was not possible to achieve 90% Dice for most images (Fig. 17b). Fig. 18 shows results by individual dataset.

Context Set Quality. As with other methods (MultiverSeg and SP+UVS), we experimented with thresholding the predictions at 0.5 before adding them to the context set. For UniverSeg, thresholding the predictions did not improve Dice scores compared to using the soft predictions in the context set.

E. Experiment 2: Analysis

E.1. In-Context Segmentation

Results. Fig. 19 show results by dataset with different context set sizes.

E.2. Interactive Segmentation In Context

Results. Fig. 20 and Fig. 21 show results by dataset using center clicks and centerline scribbles, respectively.

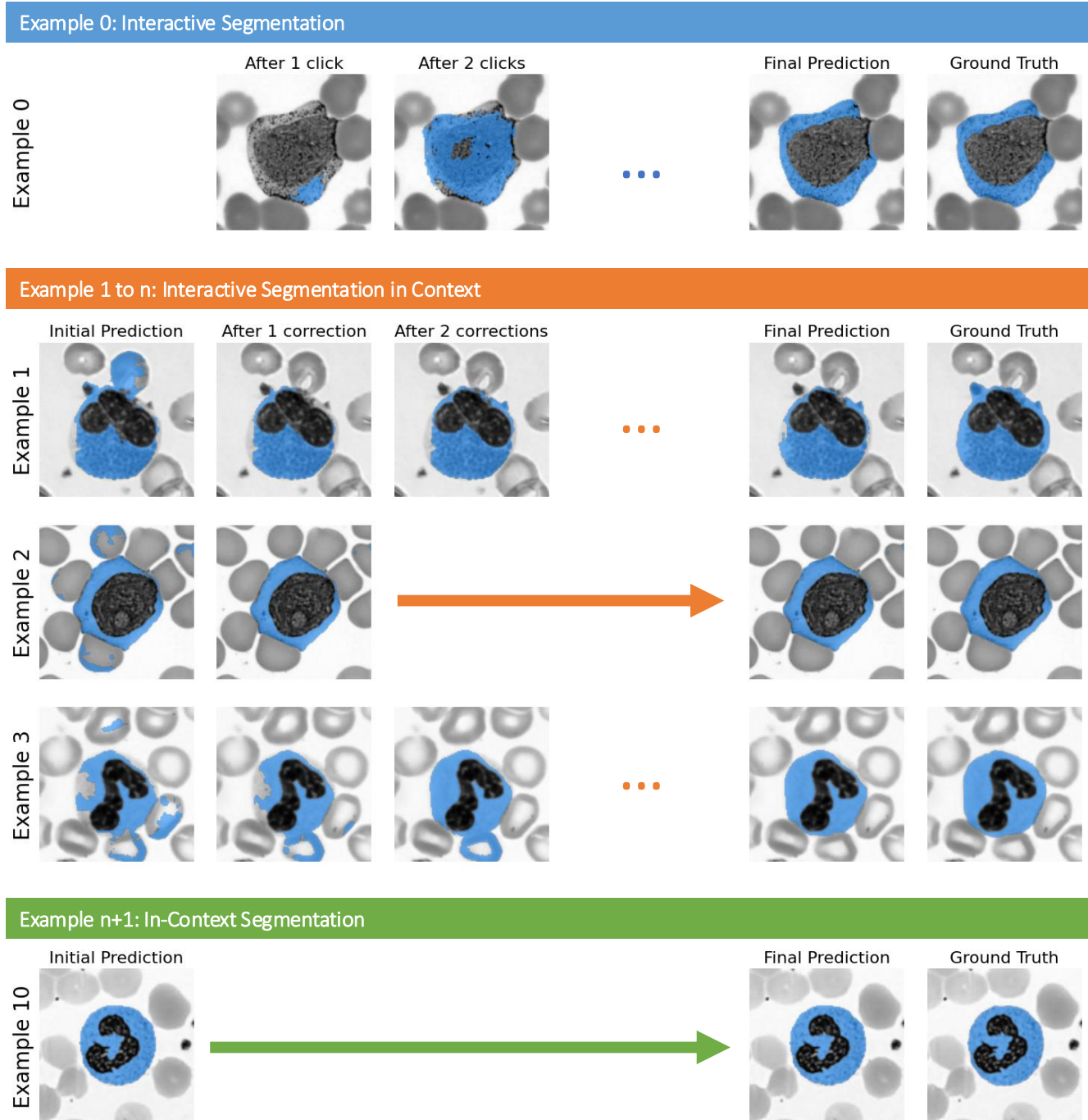
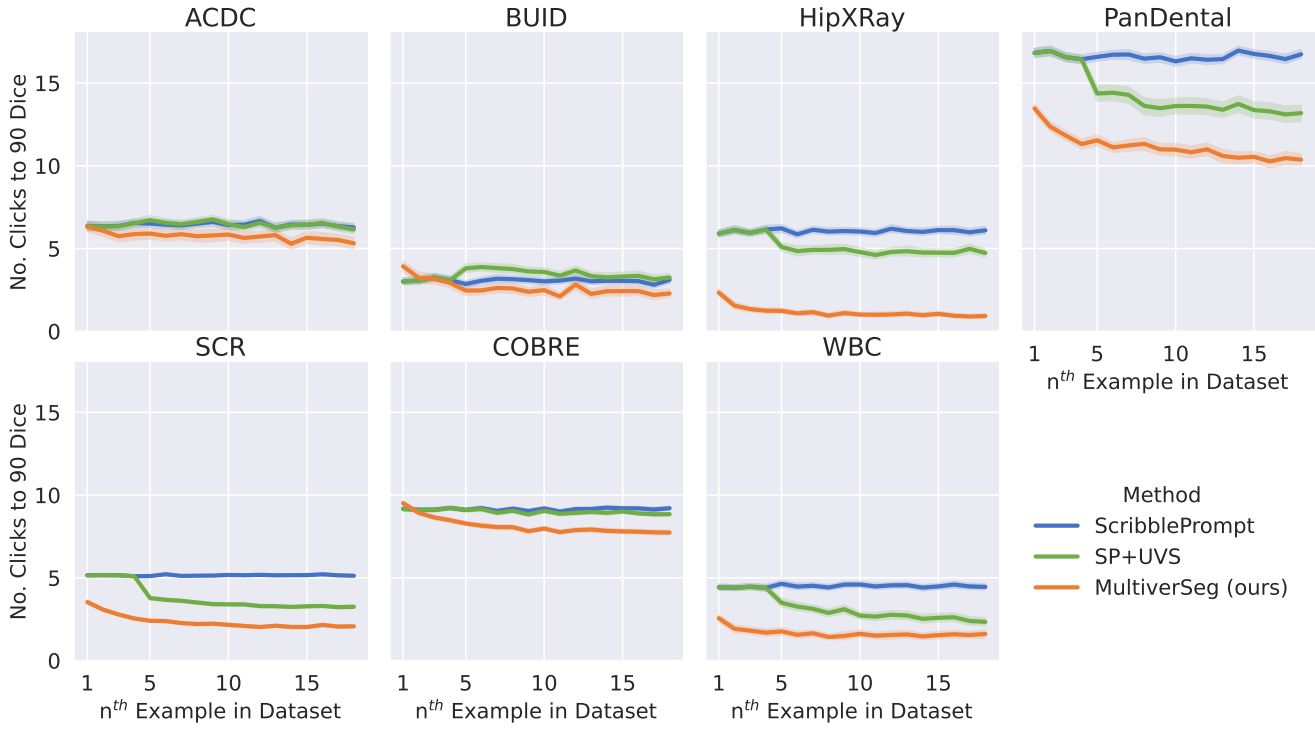
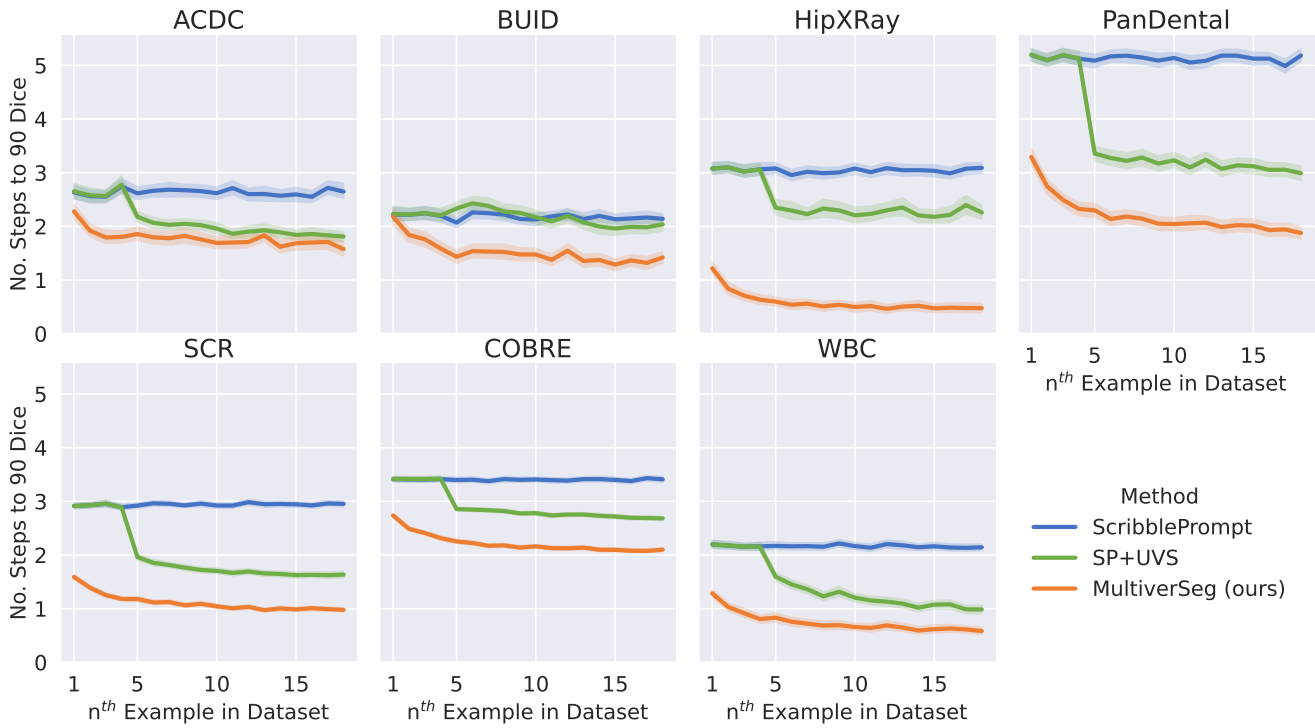

Figure 10. **Example segmentation process with MultiverSeg.** We begin by interactively segmenting a seed image (**Example 0**) to 90% Dice. The Example 0 image and final prediction are added to the context set for subsequent examples. For each subsequent example, we first make an initial in-context segmentation prediction using a context set containing all the previous examples and previously predicted segmentations. Then, we simulate center correction clicks until the predicted segmentation achieves $\geq 90\%$ Dice or we have accrued 20 clicks. For **Example 2**, we only simulated 1 correction because the prediction reached 90% Dice after 1 correction click. For **Example 1** and **Example 3**, additional correction clicks were needed. When the context set is large enough ($>n$), the in-context prediction from MultiverSeg may be accurate enough that no corrections are needed. For **Example 10**, the Dice score of the predicted in-context segmentation is greater than 90% so we do not need to simulate any corrections. In practice, n varies by task.



(a) Center Clicks



(b) Centerline Scribbles

Figure 11. **Interactions to target Dice on unseen datasets.** Number of interactions needed to reach 90% Dice as a function of the example number being segmented. For the n^{th} image being segmented, the context set has n examples. MultiverSeg requires substantially fewer interactions to achieve 90 Dice than the baselines, and as more images are segmented, the average number of interactions required decreases dramatically. Shaded regions show 95% CI from bootstrapping.

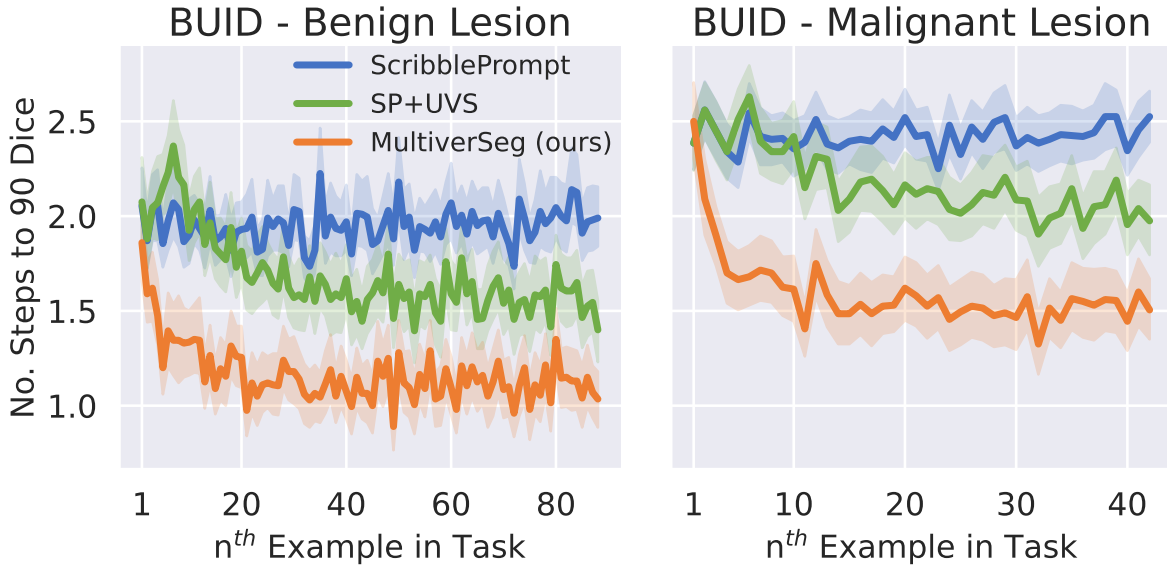

Figure 12. **Scribble steps to target Dice by task for BUID.** Number of interactions needed to reach a 90% Dice as a function of the example number being segmented. For the n^{th} image being segmented, the context set has n examples. Shading shows 95% CI from bootstrapping. BUID [3] is a breast ultrasound dataset containing segmentation tasks for benign and malignant lesions. As the context set of completed segmentations grows, the number of interactions required to segment each additional image with MultiverSeg declines.

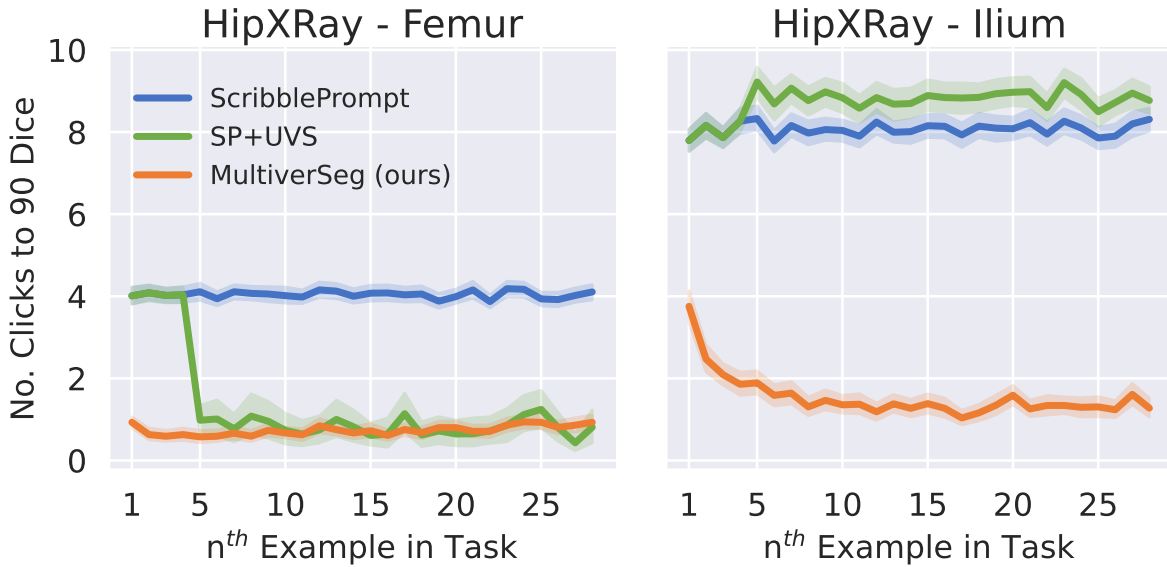

Figure 13. **Center clicks to target Dice by task for HipXRray.** Number of interactions needed to reach 90% Dice as a function of the example number being segmented. For the n^{th} image being segmented, the context set has n examples. Shading shows 95% CI from bootstrapping. HipXRray [40] is an X-Ray dataset with segmentation tasks for the femur and ilium bones. After segmenting a few images from the femur task with MultiverSeg, the rest of the images in the task can be segmented (to $\geq 90\%$ Dice) with minimal additional interactions.

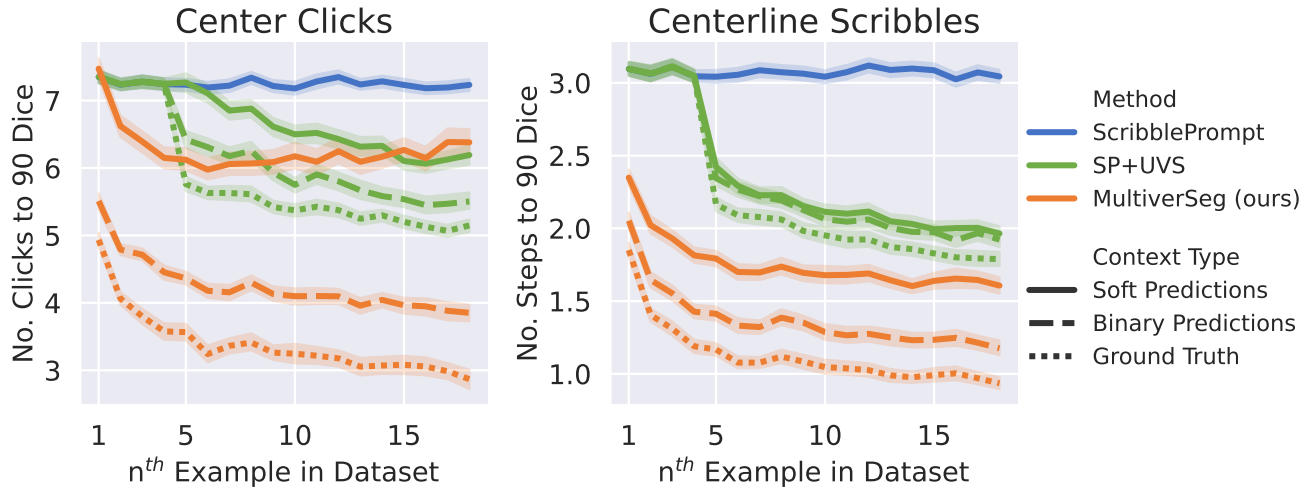

Figure 14. **Interactions to target dice on unseen datasets with different types of context sets.** Number of interactions needed to reach a 90% Dice as a function of the example number being segmented. For the n^{th} image being segmented, the context set has n examples. We show results with and without thresholding the predictions (“Binary Predictions” vs. “Soft Predictions”). We expect the number of interactions with “Ground Truth” context to be a lower bound on the number of interactions to reach 90% Dice. We show results averaged across validation tasks.

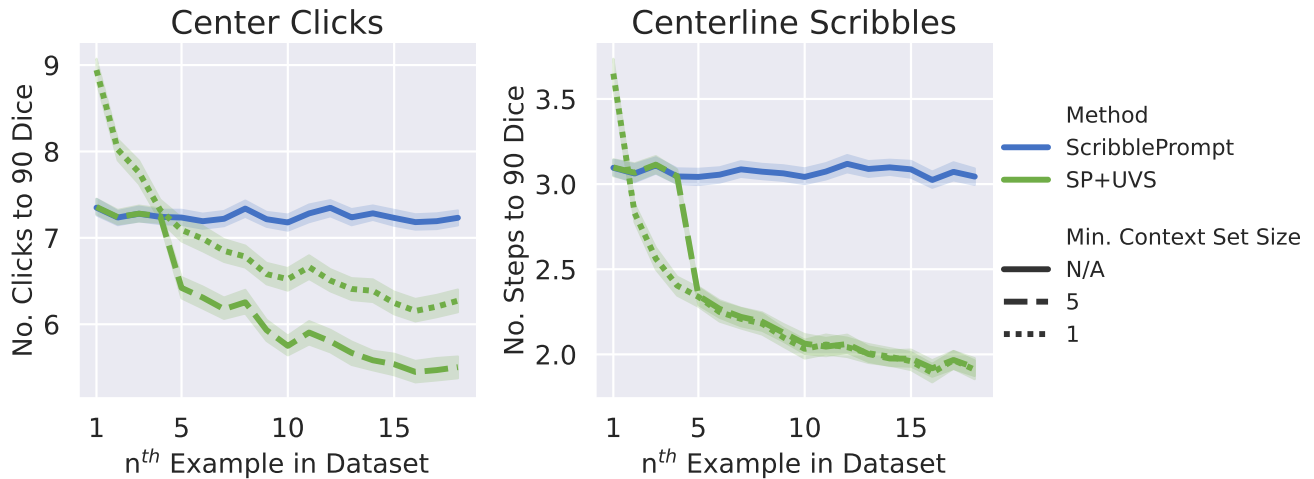

Figure 15. **Variations of SP+UVS.** Number of interactions needed to reach a 90% Dice as a function of the example number being segmented. For the n^{th} image being segmented, the context set has n examples. We show results for SP+UVS with different minimum context set size cutoffs, along with ScribblePrompt for reference. SP+UVS with a minimum context set size of k , means that when the context set has fewer than k examples, we perform interactive segmentation with ScribblePrompt (ignoring the context examples). When the context set is larger than the minimum size, we first make an in-context segmentation prediction using UniverSeg and then correct that prediction with ScribblePrompt. For small context set sizes, UniverSeg does not make accurate predictions, and initializing ScribblePrompt with UniverSeg’s prediction increases the number of interactions required to reach 90% Dice. We show results averaged across validation tasks.

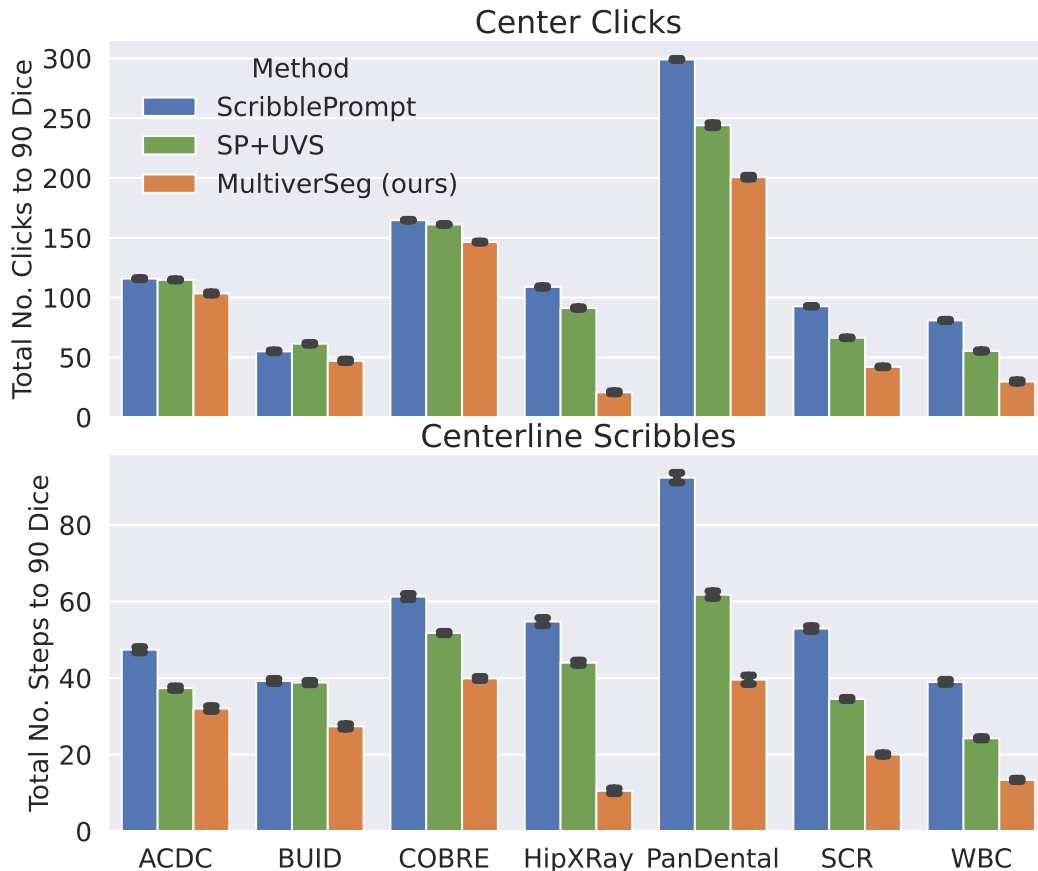
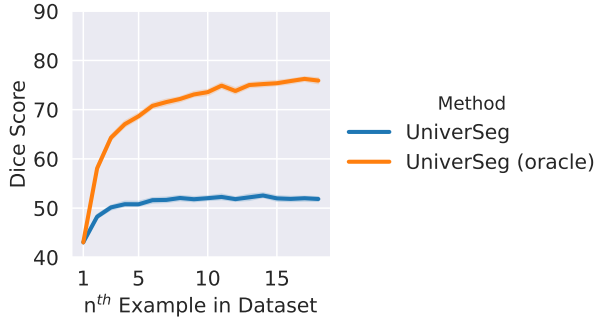

Figure 16. **Total interactions per unseen task.** We show total number of clicks and scribble steps to segment 18 images to $\geq 90\%$ Dice for each method. In all scenarios, MultiverSeg required fewer interactions than both baselines. Error bars show 95% CI from bootstrapping.

Interaction Protocol	Method	Dice Score \uparrow	HD95 \downarrow	Total Steps \downarrow
Center Clicks	ScribblePrompt	91.23 ± 0.08	1.04 ± 0.02	131.03 ± 1.32
	SP+UVS	91.14 ± 0.11	1.07 ± 0.03	115.30 ± 2.34
	MultiverSeg (ours)	91.35 ± 0.21	1.00 ± 0.04	84.39 ± 2.58
Centerline Scribbles	ScribblePrompt	93.23 ± 0.21	0.90 ± 0.10	55.27 ± 3.28
	SP+UVS	93.22 ± 0.20	0.90 ± 0.12	42.77 ± 2.75
	MultiverSeg (ours)	93.23 ± 0.21	0.86 ± 0.10	26.13 ± 2.39

Table 7. **Average segmentation quality and total interactions per unseen task.** We measure average segmentation quality across a set of 18 test images using Dice score and 95th percentile Hausdorff distance (HD95). For each metric, we show mean and standard deviation from bootstrapping. Dice and HD95 are similar across methods because we simulate interactions until the predicted segmentation has $\geq 90\%$ Dice or the maximum number of interaction steps is reached. MultiverSeg requires the fewest interaction steps per task on average.



(a) **Dice score by example number.** We show average Dice Score across unseen test data by example number. We exclude the initial seed example, such that for the n^{th} image being segmented, the context set has n examples.

Method	Dice Score \uparrow	No. Failures \downarrow
UniverSeg	51.02 ± 0.07	16.60 ± 0.44
UniverSeg (oracle)	70.24 ± 0.13	13.28 ± 0.28

(b) **Average performance on unseen tasks.** We report average Dice score per task of 18 images and the average number of examples where the Dice score was less than 90%. We report standard deviation across 200 simulations.

Figure 17. **Bootstrapping UniverSeg.** We use UniverSeg to sequentially segment images starting from a single example with a ground truth segmentation. After segmenting each image, the image and predicted segmentation are added to the context set for the next example. For the “oracle” version, we use ground truth labels in the context set instead of previously predicted segmentations. Even when using ground truth labels in the context set, which we expect to be an upper bound on performance, it was not possible to achieve 90% Dice for most images.

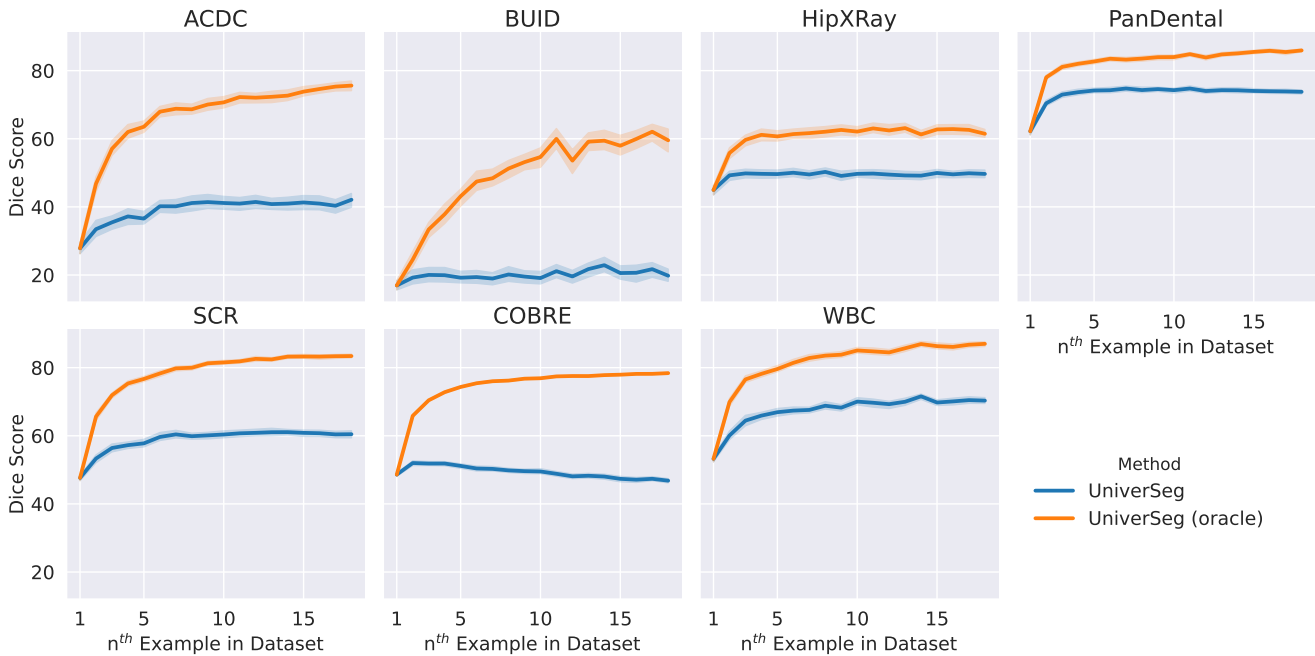

Figure 18. **Bootstrapping UniverSeg results by dataset.** We show Dice score vs. example number for unseen tasks averaged by dataset. After segmenting each image, the image and predicted segmentation are added to the context set for the next example. For the “oracle” version, we use ground truth labels in the context set instead of previously predicted segmentations. We exclude the initial seed example, such that for the n^{th} image being segmented, the context set has n examples. Shaded regions show 95% CI from bootstrapping.

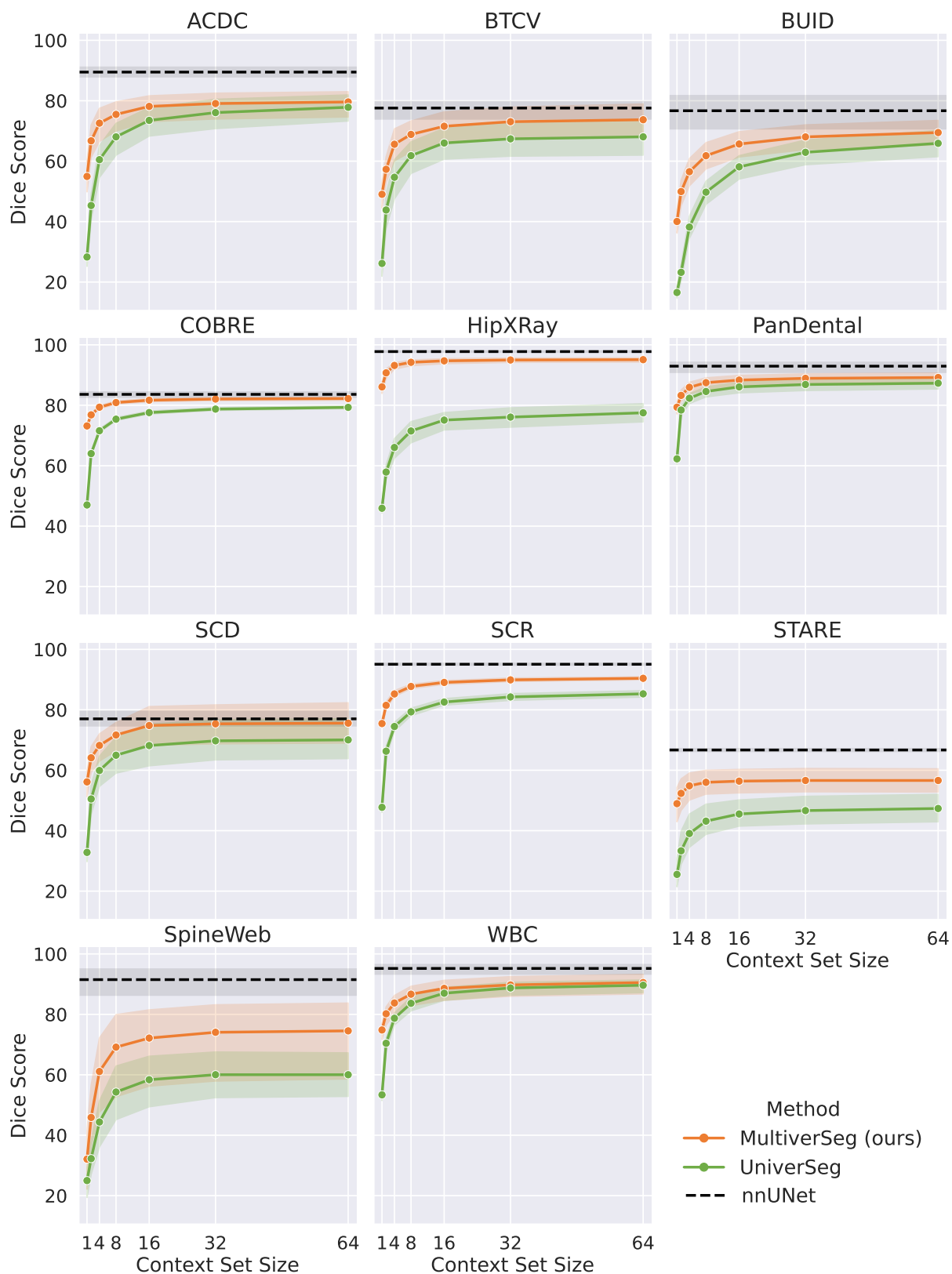

Figure 19. **In-context segmentation performance across context set sizes on unseen datasets.** We compare MultiverSeg to UniverSeg, an in-context segmentation method, given ground truth context labels. Shading shows 95% CI from bootstrapping.

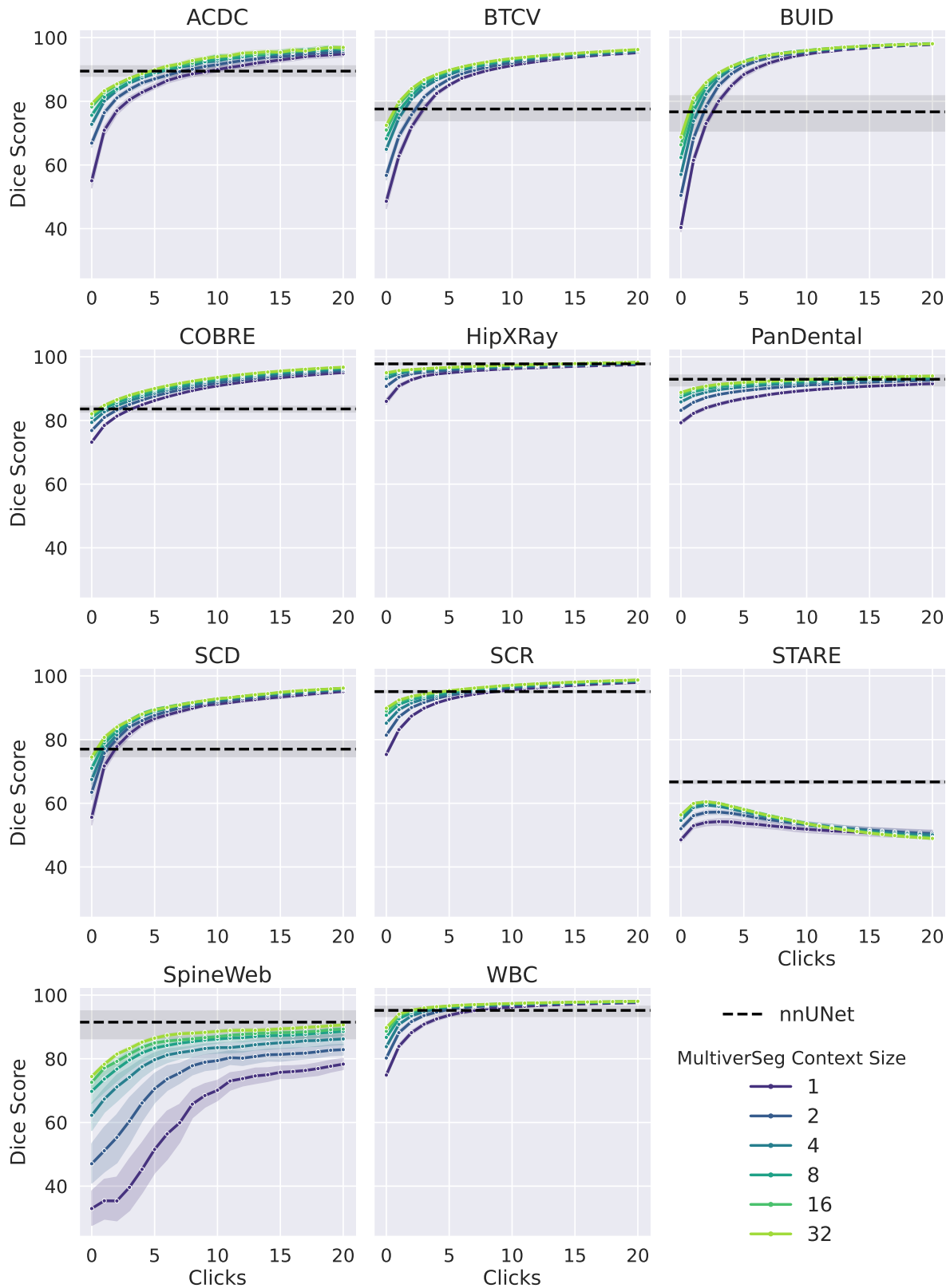

Figure 20. **Interactive segmentation in context with center clicks on unseen datasets.** MultiverSeg’s interactive segmentation performance with the same number of interactions improves as the context set size grows. We first make an initial prediction based on the context set (step 0), and then simulate corrections with one center click at a time. Shading shows 95% CI from bootstrapping.

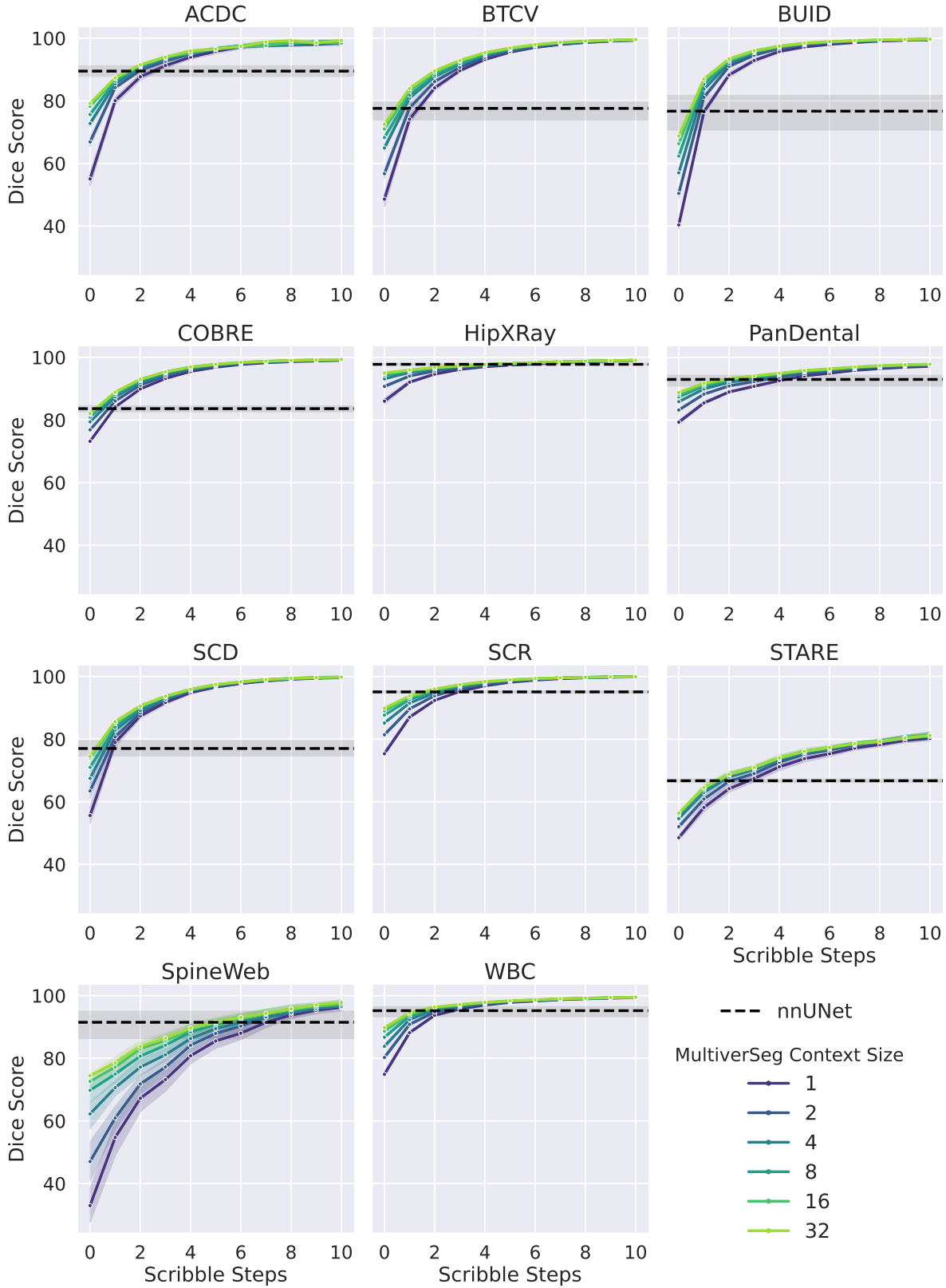

Figure 21. **Interactive segmentation in context with centerline scribbles on unseen datasets.** MultiverSeg’s interactive segmentation performance with the same number of interactions improves as the context set size grows. We first make an initial prediction based on the context set (step 0), and then simulate centerline scribble corrections. Shading shows 95% CI from bootstrapping.