

Overview of AI and Communication for 6G Network: Fundamentals, Challenges, and Future Research Opportunities

Qimei Cui^{1 2}, Xiaohu You^{3*}, Ni Wei⁴, Guoshun Nan^{1*}, Xuefei Zhang¹, Jianhua Zhang⁵,
Xinchen Lyu^{1 2}, Ming Ai⁶, Xiaofeng Tao^{1 2}, Zhiyong Feng⁵, Ping Zhang⁵, Qingqing Wu⁷,
Meixia Tao⁸, Yongming Huang³, Chongwen Huang⁹, Guangyi Liu¹⁰, Chenghui Peng¹¹,
Zhiwen Pan³, Tao Sun¹⁰, Dusit Niyato¹², Tao Chen¹³, Muhammad Khurram Khan¹⁴,
Abbas Jamalipour¹⁵, Mohsen Guizani¹⁶ & Chau Yuen¹⁷

¹National Engineering Research Center of Mobile Network Technologies,
Beijing University of Posts and Telecommunications, Beijing 100876, China;

²Department of Broadband Communication, Peng Cheng Laboratory, Shenzhen 518055, China;

³National Mobile Communications Research Laboratory, Southeast University, Nanjing 210096, China;

⁴Fudan University, Shanghai 200433, China;

⁵School of Information and Communication Engineering, Beijing University of Posts and Telecommunications,
Beijing 100876, China;

⁶CICT Mobile Communication Technology Co., Ltd., Beijing 100020, China ;

⁷Department of Electronic Engineering, Shanghai Jiao Tong University, Shanghai 200240, China;

⁸Department of Electronic Engineering and the Cooperative Medianet Innovation Center (CMIC),
Shanghai Jiao Tong University, Shanghai 200240, China;

⁹College of Information Science and Electronic Engineering, Zhejiang University, Hangzhou 310058, China;

¹⁰China Mobile Research Institute, Beijing 100053, China;

¹¹Huawei Technologies, Shanghai 201206, China;

¹²College of Computing and Data Science, Nanyang Technological University, Singapore 117583 ;

¹³VTT Technical Research Centre of Finland Ltd., Espoo FI-02044 VTT, Finland;

¹⁴Center of Excellence in Information Assurance, King Saud University, Riyadh 11362, Saudi Arabia;

¹⁵School of Electrical and Information Engineering, University of Sydney, NSW 2006, Australia;

¹⁶Mohamed bin Zayed University of Artificial Intelligence (MBZUAI), Abu Dhabi UAE;

¹⁷School of Electrical and Electronics Engineering, Nanyang Technological University, Singapore 639798

Abstract With the increasing demand for seamless connectivity and intelligent communication, the integration of artificial intelligence (AI) and communication for sixth-generation (6G) network is emerging as a revolutionary architecture. This synergy deeply embeds AI into various layers of the communication network, optimizing resource allocation, enhancing network efficiency, and providing reliable performance in complex and dynamic environments. This paper presents a comprehensive overview of AI and communication for 6G networks, emphasizing their foundational principles, inherent challenges, and future research opportunities. We commence with a retrospective analysis of AI and the evolution of large-scale AI models, underscoring their pivotal roles in shaping contemporary communication technologies. The discourse then transitions to a detailed exposition of the envisioned integration of AI within 6G networks, delineated across three progressive developmental stages. The initial stage, *AI for Network*, focuses on employing AI to augment network performance, optimize efficiency, and enhance user service experiences. The subsequent stage, *Network for AI*, highlights the role of the network in facilitating and buttressing AI operations and presents key enabling technologies, including digital twins for AI and semantic communication. In the final stage, *AI as a Service*, it is anticipated that future 6G networks will innately provide AI functions as services and support application scenarios like immersive communication and intelligent industrial robots. Specifically, we have defined the quality of AI service, which refers to the measurement framework system of AI services within the network. In addition to these developmental stages, we thoroughly examine the standardization processes pertinent to AI in network contexts, highlighting key milestones and ongoing efforts. Finally, we outline promising future research opportunities that could drive the evolution and refinement of AI and communication for 6G, positioning them as a cornerstone of next-generation communication infrastructure.

Keywords 6G, AI, AI for network, AI as a service, large-scale AI models, network for AI, overview

1 Introduction

In recent years, the rapid development of wireless communication technology has profoundly reshaped various aspects of our society, driving unprecedented connectivity and enabling innovative applications. Following the widespread deployment and success of the fifth-generation (5G) networks, attention has shifted towards the sixth-generation (6G) wireless communication systems. With its enhanced capabilities, it is anticipated that 6G will bring transformative changes, including ultra-low latency, significantly higher data transmission rates, increased reliability, and ubiquitous connectivity. Among these advancements, integrating artificial intelligence (AI) into 6G networks is expected to be a game-changer, providing new paradigms and opportunities across multiple fields.

AI technology has advanced rapidly over the past decade, particularly in machine learning, deep learning, and natural language processing. These advancements have enabled AI to play a crucial role across various industries. In the 5G era, AI has been successfully applied in aspects of wireless networks, such as network optimization, traffic prediction, and fault detection, significantly enhancing network performance and user experience. However, to truly achieve AI-native support in 6G networks, many unresolved issues still need to be addressed.

The introduction of AI can enhance coding efficiency by utilizing compressed semantic information to transmit more data with less bandwidth, which helps alleviate network congestion and improve data transmission rates [1]. However, AI algorithms generate additional data that needs to be transmitted, such as model parameters, training data, and real-time feedback. This raises the question of whether the overall data volume in future networks will decrease or increase. This change in data volume will directly impact network design and architecture. Moreover, both base stations and user devices will employ AI algorithms for resource allocation to reduce energy consumption and improve resource utilization. However, the operation of AI itself may increase power consumption, leading to another question: Will energy consumption in future networks increase or decrease? In the pursuit of high efficiency, it is crucial to consider optimizing energy efficiency in AI applications to ensure the sustainable development of networks. Additionally, while networks can leverage AI algorithms to enhance transmission reliability and better respond to changing network conditions and user demands, the inherent uncertainty of AI algorithms—especially in complex and dynamic network environments—raises concerns about whether future networks will operate more reliably. These uncertainties may lead to decision-making errors, affecting user experience and overall network performance.

It is essential to consider integrating AI into the architecture, network elements, and functional processes of the new 6G system from a closer and deeper perspective to address these issues. Specifically, we need to re-examine the network's design philosophy to ensure a genuine synergy is formed between AI and the 6G network.

This comprehensive review explores the intricate relationship between 6G and AI, delving into the fundamental principles, key technologies, and potential applications this integration brings forth. We discuss the critical technical enablers of 6G, including advanced wireless communication techniques, spectrum management, and network architectures. Additionally, we examine the role of AI in optimizing network operations, enhancing security, and enabling intelligent decision-making processes. The review also highlights the open challenges to fully realizing the potential of 6G and AI integration. These challenges include data privacy, algorithmic transparency, energy efficiency, and the need for standardized frameworks to ensure interoperability and scalability. This review can be a valuable resource for researchers, practitioners, and policymakers involved in developing and deploying 6G and AI technologies by providing a holistic overview of the state-of-the-art and future directions. Through this collaborative effort, we can harness the full potential of these cutting-edge technologies to build a brighter, more connected, and more sustainable future.

The organization of this paper is illustrated in Figure 1, and we summarize the main abbreviations used throughout this work in Table 1.

1.1 Requirements and Challenges in the Post-5G Era

1.1.1 *More Efficient Resource Utilization*

The rapid development of information technology and networks has led to a new round of business innovation and upgrading of service demand. The networks face the dual challenges of explosive growth in

* Corresponding author (email: xhyou@seu.edu.cn, nanguo2021@bupt.edu.cn)

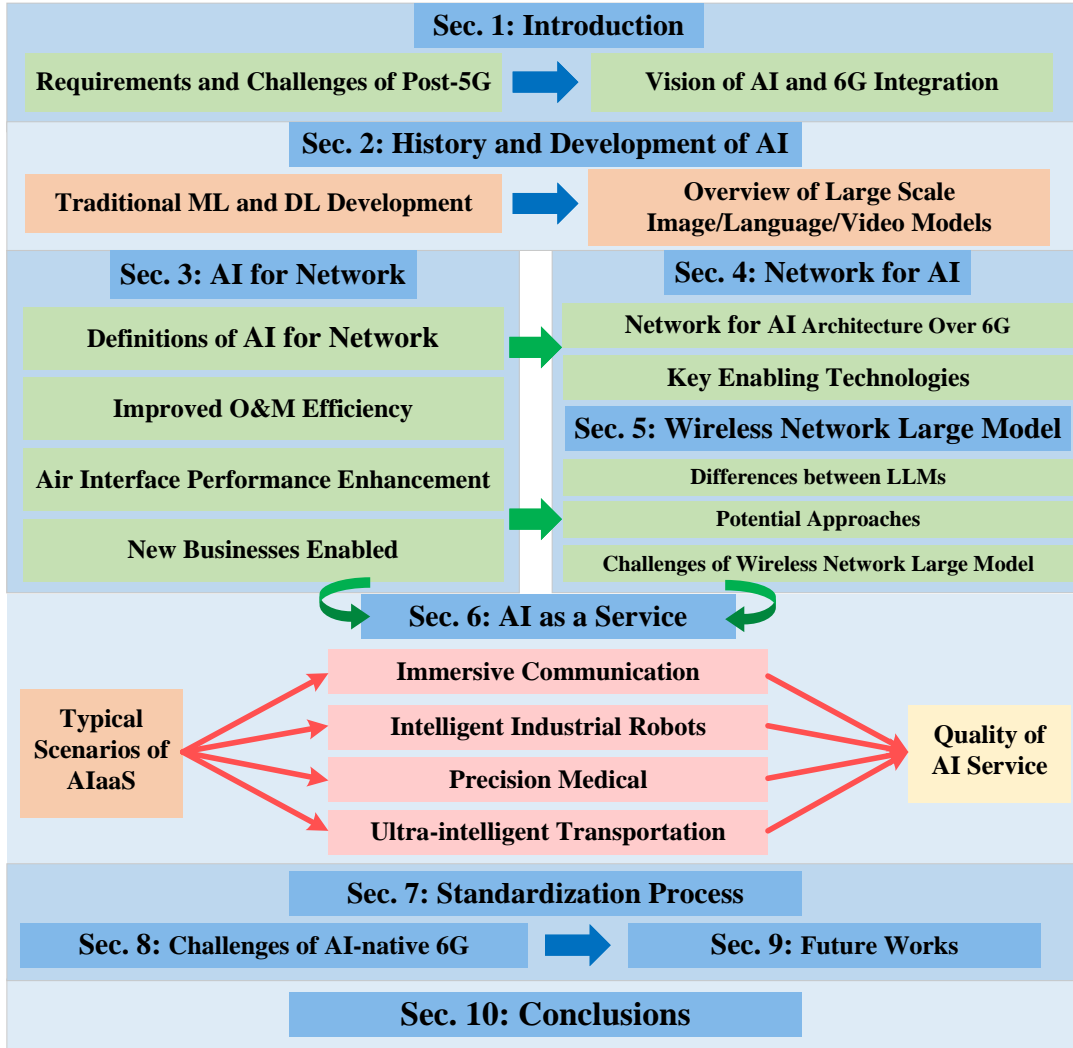

Figure 1 Organization of this article.

data traffic and the demand for massive devices to connect everything. According to Cisco statistics [2], global mobile data traffic grew more than tenfold from 2014 to 2019, and the number of connected devices worldwide had reached approximately 29.3 billion by the end of 2023. In the face of such an enormous traffic demand, it is of particular significance to explore how to utilize the limited network resources as fully as possible [3]. However, existing wireless communication systems still adopt a static spectrum management model, where authorized users have exclusive access. This model struggles to flexibly adapt to the significant spatiotemporal variations in traffic and the mobility characteristics of users, resulting in low spectrum resource utilization, as well as a huge power consumption of the base stations. Consequently, in the event that the network is capable of, by virtue of the intelligent prediction and dynamic adjustment capabilities furnished by AI, allocating network resources such as spectrum and power in a flexible manner in accordance with the real-time demands of various services, it will be feasible to curtail resource wastage or the scarcity of resources for specific services, thereby enhancing network performance and user experience.

1.1.2 More Intelligent Network Operation, Maintenance, and Management

Currently, the operation and maintenance management of mobile communication networks primarily rely on manual on-site troubleshooting, resulting in low levels of automation and high maintenance costs. This approach imposes high demands on the workload and expertise of maintenance personnel. The work mode is predominantly reactive, addressing issues as they arise rather than proactively preventing them. Consequently, providing rapid response reports and swift emergency handling capabilities is challenging.

Table 1 List of Abbreviations

AI	Artificial Intelligence	MEC	Multi-access Edge Computing
AI4NET	AI for Network	MARL	Multi-agent Reinforcement Learning
AIaaS	AI as a Service	NLP	Natural Language Processing
BS	Base Station	NTN	Non-Terrestrial Networks
CNN	Convolutional Neural Network	NET4AI	Network for AI
CP	Control Plane	NWDAF	Network Data Analytics Function
DRL	Deep Reinforcement Learning	PFL	Personalized Federated Learning
eMBB	Enhanced Mobile Broadband	PLMs	Pre-trained Language Models
ENI	Experiential Networked Intelligence	QoAIS	Quality of AI Service
FL	Federated Learning	QoS	Quality of Service
GRU	Gated Recurrent Unit	RNN	Recurrent Neural Networks
GAN	Generative Adversarial Networks	RF	Random Forest
GPU	Graphics Processing Units	ResNet	Residual Network
HARQ	Hybrid Automatic Repeat Quest	RSS	Received Signal Strength
IoT	Internet of Things	SMPC	Secure Multi-Party Computation
ITU	International Telecommunication Union	SLA	Service Level Agreement
IMT	International Mobile Telecommunications	SA	Service and Aspects
INC	In-network Computing	SNR	Signal-to-Noise Ratio
KPI	Key Performance Indicator	UPF	User Plane Function
LLMs	Large Language Models	ML	Machine Learning
LSTM	Long Short-Term Memory	WG	Working Group
uRLLC	Ultra-Reliable Low Latency Communica- tions	mMTC	Massive Machine Type Communications

At the same time, 5G networks introduce new technologies, such as virtualization and mobile edge computing [4]. Edge sites are rapidly expanding, characterized by their large number, wide distribution, and heterogeneity. As the number of edge sites increases, maintenance teams must expand accordingly, leading to uncontrolled labor costs [5].

Compared to traditional core network equipment's typical millisecond-level fault detection efficiency, network resource virtualization introduces new potential fault points. Moreover, it is difficult for operators to delineate the responsibility boundaries among suppliers when faults occur. Using software mechanisms for fault detection, the virtual network function at the edge site typically experiences longer response times, which complicates timely network maintenance and management. Furthermore, the continuous emergence of new applications and services demands higher bandwidth, lower latency, more excellent reliability, and enhanced security from the network. Traditional network operation and maintenance management methods will find it increasingly difficult to adapt to the future's more complex and dynamic network environments. The integration of AI and wireless networks can support the in-depth analysis and mining of a large amount of network data, achieve accurate fault prediction and rapid diagnosis, significantly reduce the relatively long network fault recovery time, and enhance network availability.

1.1.3 More Diverse and Heterogeneous Networks

The frequency bands for 6G networks will expand from the current 700 MHz to 2.6 GHz range, including millimeter waves, terahertz, and visible light frequencies. Coverage will extend from ground-based to three-dimensional, achieving integrated networking across air, space, and terrestrial domains. However, due to the dynamic changes in the network topology and different operating environments of non-terrestrial networks, the networking technologies used for terrestrial networks cannot be directly applied to non-terrestrial scenarios. It is necessary to research new networking technologies for integrated air-space-ground networks and consider new three-dimensional networking models [6]. On the other hand, with the extensive deployment of distributed edge computing and intelligent network nodes, resources

such as computing and storage are being down to the edge nodes. For 6G to support the diverse business needs of various scenarios and meet the differentiated demands of users, it will require both centralized management of cellular networks and distributed collaborative cloud-edge integrated networking.

1.1.4 *More Secure and Reliable Transmissions*

From 2G to 5G, the design goal of mobile communication networks in terms of security and reliability has been to ensure the authenticity of user and network identities, prevent data interception and tampering during transmission, and primarily employ security mechanisms, such as network authentication, data encryption, and integrity checks, to safeguard communications. Moreover, these security measures have undergone several “add-on” enhancements and refinements. Establishing security measures is “post-hoc,” meaning that security mechanisms are added to the system after the design of the network communication functions is complete. Furthermore, some security vulnerabilities are only addressed in subsequent generations of mobile communication networks—for example, 5G remedied the capture attacks on user identity tags in 4G [7,8]. The defense systems are deployed primarily based on a perimeter-centric defense architecture, most often erected on the premise of “known risks”. Protective devices, such as firewalls and intrusion detection systems, are positioned at the physical boundaries of mobile communication networks. Internally, these systems adopt a trusting stance, while externally, they use a “patching” approach to ward off security risks.

Additionally, the currently released 5G network security protocol standards target primarily the Enhanced Mobile Broadband (eMBB) scenario. The standardization progress of security protocols for two other typical cases—Massive Machine Type Communications (mMTC) and Ultra-Reliable Low Latency Communications (uRLLC)—lags. In the post-5G era, mobile communication networks will increasingly focus on empowering vertical industry services. They will do so by opening up specific network capabilities to third parties through upper-layer interfaces or by providing customized security services tailored to the differentiated needs of various industries [9]. This approach is intended to effectively adapt to the new characteristics of mobile communication networks, which are more open, feature heterogeneous integration, include many terminals, and exhibit diverse connection types.

1.2 6G Vision

1.2.1 *Ground Vision*

As new-generation information and communication technologies and applications such as big data, cloud computing, the Internet of Things (IoT), and AI develop, and as these intertwine deeply with information, communication, data and technology (ICDT), the technology landscape transitions into an era of “digital twins (DT) and ubiquitous intelligence” in the 6G era [10]. 6G networks will build a closely interconnected network space by providing communication services that integrate the physical and virtual worlds, enabling seamless interaction between the human society, physical world, and virtual world. This integration will create new value through the digital world, realizing the promising vision of “6G changing the world.”

In 2030 and beyond, mobile communication application scenarios will exhibit entirely new characteristics within the context of the DT world and pervasive intelligence. These scenarios will support ubiquitous wireless connectivity, big data, and new technologies such as AI, giving rise to three major application areas: intelligent living, intelligent production, and intelligent society. These areas will encompass integrated air-space-ground networks, communication and sensing interconnection, and intelligent interaction. 6G networks will not be confined to providing communication functions alone. Following the major trend of integrating sensing, communication, computing, AI, and security, 6G will expand from traditional single-function capabilities to new network capabilities such as sensing, computing, AI, and security.

1.2.2 *Usage Scenarios of 6G*

In June 2023, the International Telecommunication Union Radio Sector (ITU-R) approved the “Framework and Overall Objectives Recommendation for the Development of IMT for 2030 and Beyond” (referred to as “Recommendation”) at the 44th ITU-R WP 5D meeting. This document outlines the development goals, typical scenarios, and capability indicators for 6G, providing essential guidance for subsequent 6G technology and standards research. IMT-2030 (6G) has defined six significant scenarios.

As shown in Figure 2, building on the “iron triangle” of IMT-2020 (5G), IMT-2030 (6G) extends outward to form a hexagon. On the outermost circle of the hexagon, four design principles applicable to all scenarios are listed: sustainability, ubiquitous intelligence, security/privacy/resilience, and connecting the unconnected.

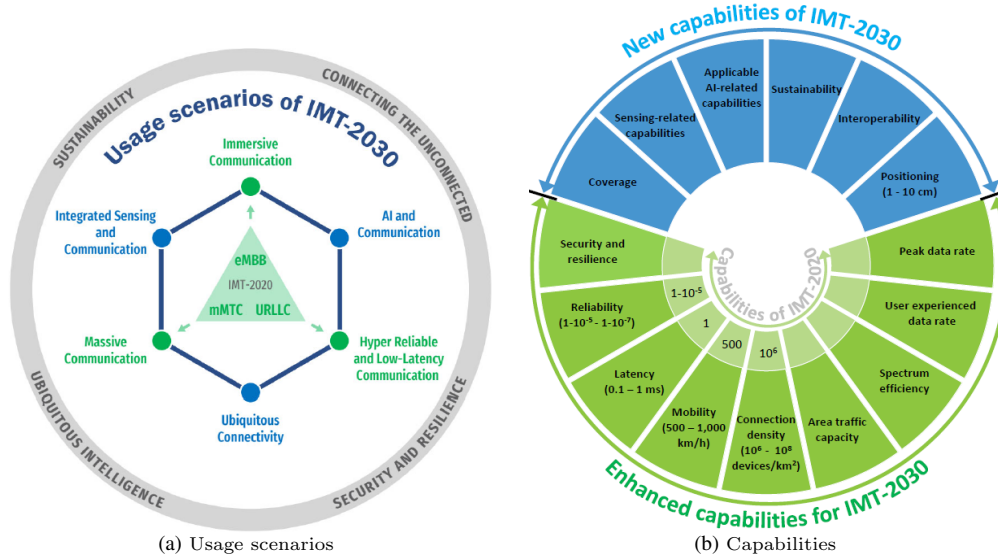

Figure 2 Usage scenarios and new capabilities of 6G proposed by IMT-2030

Immersive Communication: The immersive communication scenario extends the eMBB of 5G. It includes use cases that provide users with rich interactive video (immersive) experiences, including interactions with machine interfaces. Typical use cases in this scenario include immersive extensive reality (XR) communication, remote multi-sensory presentation, and holographic communication. In immersive communication, supporting time-synchronized mixed traffic of video, audio, and other environmental data is essential, including independent support for voice. Moreover, the ability to improve spectrum efficiency, provide a consistent service experience, and balance higher data rates and enhanced mobility in various environments is crucial. Some immersive communication use cases may also require high reliability and low latency support to enable responsive and accurate interactions with real and virtual objects and greater system capacity to connect numerous devices simultaneously.

Hyper-Reliable and Low-Latency Communication: The hyper-reliable and low-latency communication scenario extends the uRLLC capabilities of 5G, covering specialized use cases that are expected to have more stringent requirements for reliability and latency. Typical use cases include communications for comprehensive automation, control, and operations in industrial environments, such as robotic interactions, emergency services, remote medical care, and power transmission and distribution monitoring.

Massive Communication: The massive communication scenario expands upon the mMTC capabilities of 5G, focusing on connecting many devices or sensors. Typical use cases include smart cities, transportation, logistics, healthcare, energy, environmental monitoring, agriculture, and many other fields with expanded and new applications. This scenario involves various IoT devices that may not have batteries or have long-life batteries. This scenario requires support for high connection density. Depending on the use case, the scenario requires different data rates, low power consumption, mobility, extended coverage range, and high security and reliability.

Ubiquitous Connectivity: The ubiquitous connectivity scenario aims to enhance connectivity to bridge the digital division. One of the critical focuses of this use case is to address areas that currently lack coverage or have minimal coverage, especially in rural, remote, and sparsely populated areas [11, 12]. Typical use cases include, but are not limited to, IoT and mobile broadband communication in these underserved regions.

AI and Communication: The AI and communication integration scenario will support distributed computing and AI-driven applications. It will enable unprecedented use cases by leveraging data collection, local or distributed computation offloading, and distributed training and inference of AI models

across intelligent nodes. Typical use cases in this scenario include assisted autonomous driving, autonomous collaboration between medical devices, offloading intensive computations across devices and networks, creating and predicting DT, and assisting collaborative robots. This scenario requires support for high regional traffic capacity, user experience data rates, low latency, and high reliability tailored to specific use cases. In addition to communication aspects, this use scenario is expected to include a range of new functionalities integrating AI and computing capabilities into IMT-2030. These include data collection, preparation, and processing from diverse sources, distributed AI model training, model sharing, and distributed inference across IMT systems, as well as coordination and linking of computing resources.

Integrated Sensing and Communication: This scenario contributes to new applications and services that require sensing capabilities. It leverages IMT-2030 to provide wide-area multidimensional sensing, offering spatial information about unconnected devices and spatial information about connected devices, movement, and the surrounding environment. Typical use cases in this scenario include IMT-2030 assisted navigation, activity detection, and motion tracking (e.g., posture/gesture recognition, fall detection, vehicle/pedestrian detection), environmental monitoring (e.g., rainwater/pollution detection), and providing sensory data/information about the surrounding environment for AI, XR, and DT applications. Besides the provided communication functions, this scenario also requires support for high-precision positioning and related sensing capabilities, including distance/velocity/angle estimation, object and presence detection, localization, imaging, and mapping.

1.2.3 Capabilities of 6G

Regarding development goals, 6G aims to achieve seven significant objectives: inclusivity, ubiquitous connectivity, sustainability, innovation, security/privacy/resilience, standardization and interoperability, and accessibility. It may become a new digital infrastructure that better connects the physical and virtual worlds, supports new users, and empowers new applications. Regarding performance indicators, the Recommendation specifies 15 key capability metrics for 6G, divided into two categories. The first category focuses on enhanced capabilities for IMT-2020, including peak rate, user experience rate, spectrum efficiency, regional traffic density, connection density, mobility, latency, reliability, and security/privacy/resilience performance—totaling nine indicators. The second category supports new functionalities for extending IMT-2030 use cases, encompassing coverage, perception, AI, sustainability, interoperability, and positioning—totaling six indicators. Each capability may exhibit varying relevance and applicability across different usage scenarios. The ITU’s vision for 6G encompasses a range of services and scenarios to advance communication capabilities far beyond what the current 5G technology can achieve.

1.3 Overview of AI and communication for 6G

1.3.1 Drivers of Integrating AI into Wireless Communication

Future wireless network systems will evolve into integrated wireless infrastructure platforms deeply integrating “communication,” “perception,” “computing,” “intelligence,” and “storage.” These platforms will be capable of providing customized or personalized services on demand, surpassing the capabilities of traditional communication systems that rely on fixed architectures and predefined rules. However, such systems will need to leverage AI technologies. They will utilize big data and knowledge bases for inference and decision-making, employing models’ generalization abilities to adapt to various environments and scenarios and providing optimal resource allocation and management solutions. AI-enabled wireless communication networks will primarily enhance the following capabilities:

Big data processing capabilities: Mobile communication networks generate vast and diverse data every moment [13–15]. The International Data Corporation has predicted that by 2025, the global daily data generation will reach 491 exabytes (EB). This data typically includes terminal, wireless air interface, network, and service data in various formats, such as text, images, XML, HTML, graphics, and audio/video information, as shown in Table 2. Network operators can use AI technologies to train and make inference decisions on different types of mobile big data, enhancing network performance and optimizing across various dimensions and objectives.

The essential advantage of AI lies in its ability to extract information from unstructured mobile data, obtain abstract correlations, achieve effective organization of complex data, and reduce preprocessing

work. This process does not require manual operations, thereby lowering labor costs.

Table 2 Direction of mobile communication network data and application

Data Type	Data Name	Application Direction
Wireless air interface data	Channel state information, intra/inter-cell interference, multipath delay	Channel state information prediction, wireless channel modeling, power control, interference cancellation
Terminal data	Measurement reports, minimization of drive tests, block error rate, port flow	Network traffic detection and congestion control, traffic prediction and scheduling optimization, personalized service
Network data	Key performance indicator, extended detection and response, running log	Dynamic load balancing and interference avoidance in wireless networks, network energy conservation, intelligent routing
Business data	Internet protocol information, uniform resource locator information, subscriber tariff data, internet access time	Business identification and awareness, business anomaly detection, traffic management

Breaking performance limitations of hierarchical modules: These models optimize source and channel independently. This is based on infinite data packet length assumptions and static channel conditions. In practical systems, coding is often finite, and channels are time-varying. Therefore, in dynamic and complex real-world application scenarios, even if each module operates optimally, the overall information transmission performance of the communication system may not be optimal. The advent of AI provides a new approach to improving the optimization design methods of traditional model-driven wireless communication systems, enhancing system performance and adaptability.

AI can theoretically learn hidden structures and parameters to fit arbitrarily complex functions. This provides a more effective way to sense the complex and variable wireless environment and characterize the network state space. On the other hand, the designs of different communication system modules might have conflicting goals, and there might be performance constraints between modules. There are trade-offs between performance metrics, such as channel capacity and interference, transmission reliability, and system energy consumption. Optimizing each module individually often fails to achieve overall optimal performance. In such cases, AI can facilitate joint optimization design among modules. By leveraging advanced AI technologies like deep learning, different modules can learn and optimize together, thus achieving a more optimized overall system performance.

International communication standard organizations, such as ITU, 3GPP, and IMT-2030, have initiated the standardization of AI applications in communication systems, and significant progress has been made. In the future, AI will further empower the infrastructure within networks, network management and operation systems, and service systems, fully unleashing the potential of integrating wireless communication and AI in the communication ecosystem and applications.

1.3.2 Vision of AI and 6G Integration

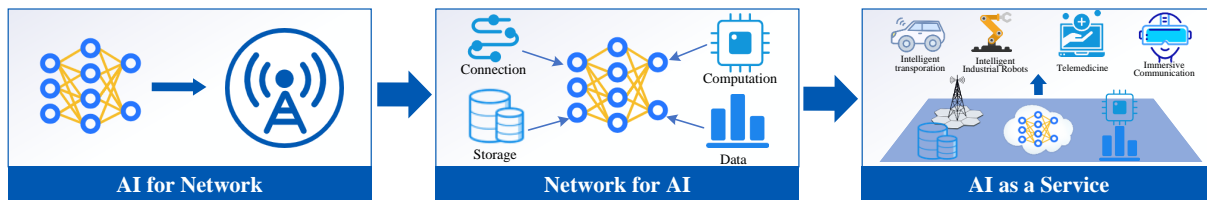

Figure 3 The extent of 6G and AI integration: AI for Network, Network for AI, and AI as a Service.

The advancement of AI technology has significantly empowered the development of wireless networks. The application of AI to enhance wireless networks is generally referred to as AI for Network (AI4NET). Its essence lies in using AI to improve wireless networks' performance, efficiency, and user experience. Research in AI4NET primarily focuses on utilizing AI to optimize traditional algorithms, enhance network functionalities, and improve network operations and management. Figure 3 illustrates the degree of

integration between 6G and AI from three perspectives: AI for Network, Network for AI, and AI as a Service. AI4NET's application in 5G networks has significantly facilitated the intelligent development of mobile communication networks and vertical industries. Its role primarily manifests in operational and maintenance intelligence and network element intelligence [16].

The former emphasizes utilizing AI to optimize traditional algorithms and automate and intellectualize tasks across network layers and operations. For instance, AI empowers wireless air interface transmission to achieve adaptive CSI feedback, beam management, and other enhancements to transmission performance. The latter focuses on proposing AI-driven intelligence for individual network elements and functional entities, breaking down proactive network responses into predictions of multiple performance metrics. This approach ultimately aims to optimize network resource allocation and reduce network latency. Examples include AI-based traffic forecasting, mobility management, and anomaly detection applications. However, in 5G networks, AI4NET mainly operates in an "add-on" mode, introducing additional latency and data processing bottlenecks. This approach somewhat hinders AI applications' effectiveness and can raise concerns regarding data privacy and security issues.

AI's evolution and developmental needs in wireless networks point towards 6G networks no longer serving as communication networks. Instead, they will transform into integrated information networks that combine communication, perception, and computing into intelligent services. 6G networks will further deepen the integration of AI with wireless networks. While AI empowers 6G networks, 6G networks will also empower AI, achieving Network for AI (NET4AI), which provides comprehensive support for the deployment and application of AI in wireless environments [17]. The essence of NET4AI is to provide various support capabilities through the network for AI, enabling more efficient and real-time AI training/inference and enhancing data security and privacy protection. An illustration of AI-native 6G has been shown in [18], which presents a vision of a new programmable network device architecture for the NET4AI phase. The authors of [19] proposed a novel network architecture for providing native support for AI, called an AI-oriented network, which is represented as a network management framework with distributed AI computational capabilities and multi-party participation built in 6G networks. The authors of [20] combined two emerging key technologies, DT and generative AI, to provide a new way of thinking about the intelligence of 6G networks. The authors of [17] briefly described the two phases of AI4NET and NET4AI at the link and network levels and argued that NET4AI will be the backbone of 6G and future wireless networks.

Moreover, 6G networks are expected to incorporate an AI plane from its inception and other newly added logical planes such as computing, data, and security. These will be interfaced in the architecture design to support functionalities like AI plane connectivity, AI plane data operations, AI plane computing capabilities, and AI plane security features. This expansion moves beyond traditional network scopes of connectivity services to encompass capabilities in computing power, data handling, algorithms, and more. The goal is to fully embed the intelligence provided by AI into the interconnection functionality of 6G networks. Additionally, through the data flow capabilities provided by 6G networks and various vertical tasks, constructing and training new AI models' architecture NET4AI aims to achieve native AI (Native AI).

Furthermore, to effectively support "inherent intelligence" and achieve ubiquitous "Native AI," 6G networks will treat AI as a service for provision and processing. This concept gives rise to the idea of 6G AI as a Service (AIaaS). Specifically, 6G AIaaS utilizes resources and functionalities within the network (including 6G core networks, wireless access networks, and terminals), such as connectivity, computing, data, and models. It aims to construct a distributed, efficient, energy-efficient, and secure AI service ecosystem. This ecosystem includes AI model training, inference, deployment, and other functionalities in a low-carbon open environment. The transition from network-oriented AI in 5G to AI-oriented 6G networks aims to provide network experiences that surpass data-centric approaches and directly cater to user needs [21]. Not only can it redefine the ecosystem of edge cloud, but it can also build new business models through 6G mobile networks, transitioning from past connectivity-oriented networks to service-oriented networks, ultimately achieving ubiquitous intelligence [22, 23].

AIaaS's typical scenarios include but are not limited to, smart cities, smart agriculture, universal education, and smart industry. Typical applications include unmanned taxi services, smart grid inspections, home health monitoring, and virtual classrooms. The specific AI services involved can be categorized from different perspectives. On the one hand, from the perspective of object orientation, they can be divided into two main categories. One category provides AI services for 6G networks, which are used to optimize network performance, corresponding to AI4NET mentioned earlier. Examples include using end-to-end

AI for customized air interface and network optimization and automated maintenance, leveraging AI trained on historical user data to predict traffic and optimize network resources. The other category provides AI services for end-users and third-party users (e.g., hospitals, autonomous vehicles, factories), corresponding to NET4AI, as previously discussed. For example, in industrial internet scenarios, wireless networks provide AIaaS to automatically identify industrial product quality using AI image-related technologies and trigger timely actions by industrial robots using reinforcement learning technologies. Each industrial detection scenario may require fine-tuning machine learning algorithms with a long deployment cycle. 6G networks enable rapidly deploying targeted AI services through large-scale distributed training, integration, and inference. On the other hand, AI services come in various types. According to the different stages of the AI model’s lifecycle, they can typically be classified into data-oriented AI services, training-oriented AI services, inference-oriented AI services, and validation-oriented AI services. These AI services vary in emphasis, quality assessment metrics, and key performance indicators.

The Quality of AI Service (QoAIS) is a multidimensional evaluation and assurance framework within AIaaS, quantifying and grading user demands for AI service quality at the user level. QoAIS integrates into the intelligent native network of 6G to guide the provision of corresponding AIaaS and ensure user requirements are met. However, QoAIS cannot directly adopt traditional QoS metrics from communication networks, which primarily focus on performance aspects of connectivity services such as transmission rates and latency. With the evolution of 6G networks, alongside traditional communication resources, multidimensional resources will be integrated, including storage, distributed heterogeneous computing capabilities, data, and AI algorithms. Therefore, assessing the quality of native AI services within the network requires consideration across multiple dimensions, including connectivity, computing capabilities, algorithms, and data. As concerns over data privacy protection and network autonomy grow within the industry, the design of the QoAIS metric system should also incorporate dimensions such as security, privacy protection, and autonomous management [24].

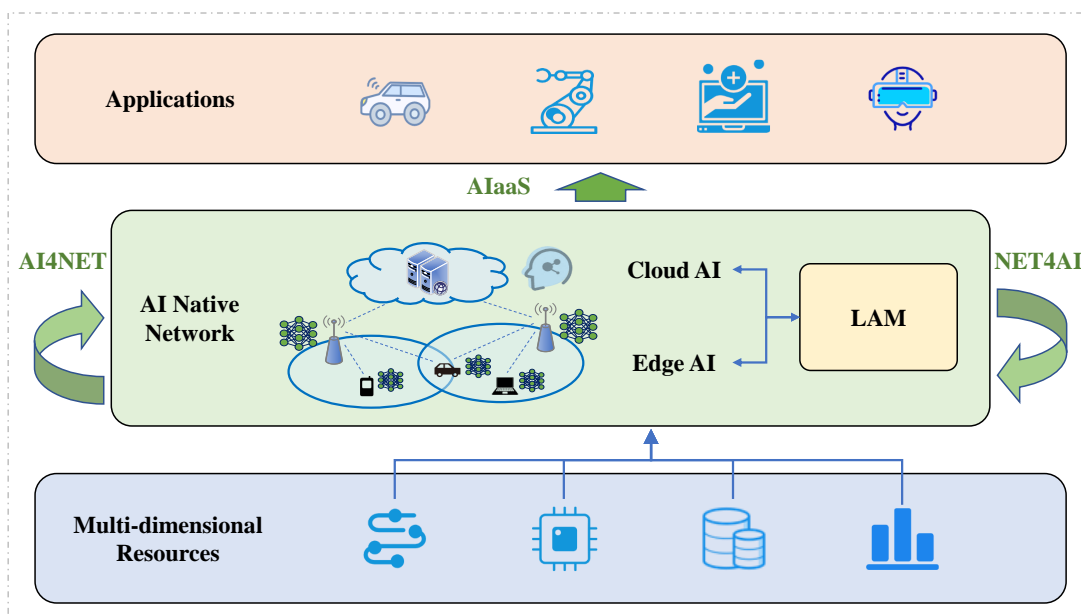

Figure 4 The design of 6G AI integration.

Moreover, with the continuous advancement of AI technology, Large Language Models (LLMs) represent a significant breakthrough in the field of NLP, contributing to the development of 6G AI. Compared to traditional small-parameter models, LLMs demonstrate robust contextual understanding, coherent text generation, logical reasoning, and generalization capabilities. Existing universal large models, such as GPT, can handle various domain-specific problems, demonstrating competence in addressing knowledge and issues within the communication domain as well [25]. The emergence of LLMs can bring a new paradigm to integrating 6G and AI. The intrinsic AI architecture in 6G can provide linkage, computation, model decomposition, and model distribution services for the training and inference of LLMs. LLMs can empower various domains of 6G networks (e.g., air interface, network side, network security, network

operation and maintenance, etc.), enabling intelligent services and closed-loop control. In 6G networks, customized specialized large models can be deployed across different network layers. These specialized large models can collaboratively address network issues through task decomposition and composition, cross-layer collaboration, cloud-edge collaboration, and other modes, thereby enhancing the intelligence level of the network.

In addition to using customized AI models tailored for specific functionalities and tasks, large models demonstrate superior generalization performance across multiple tasks and breakthrough capabilities on complex tasks that small models cannot achieve. The functionalities of large models increasingly align with the multi-scenario, multi-task characteristics of 6G, effectively alleviating the workload in model perception and performance metric setting within 6G networks and showing broad application prospects. A possible form of integrating 6G with AI is illustrated in Figure 4. By leveraging data from diverse heterogeneous networks within 6G, these large models can synthesize different 6G scenarios and services, laying a crucial foundation for AI empowerment in 6G networks. For example, the proposal of 6GANA in the 6GNETGPT white paper has built an LLM similar to ChatGPT, which provides a new paradigm for advanced operations and management of 6G networks [23].

2 History and Development of AI

2.1 Traditional AI Techniques

In 1950, Alan Turing introduced the historically influential Turing test in the paper [26], establishing a theoretical framework and foundational ideas of AI. This test is a benchmark for evaluating machine intelligence. The convening of the Dartmouth Conference in 1956 marked a watershed moment in the history of AI, and researchers reached a landmark consensus: all forms of learning behavior and intellectual characteristics can be thoroughly understood and analyzed in theory. These studies advanced AI in the 1950s and 1960s [27]. Firstly, game theory emerged as a cornerstone for studying intelligent strategies, highlighting AI's prowess in strategic planning and handling complex scenarios. Computer scientists utilized advanced programming techniques to enable computers to compete against humans in strategy games, enhancing public awareness of AI's potential and driving further algorithm design and decision theory developments. Secondly, early explorations into NLP made notable strides. Despite its infancy, initial machine translation systems began employing rule-based matching and simple statistical models to achieve automatic translation between different languages, showing AI's vast potential in language understanding and semantic analysis. Additionally, AI has made remarkable achievements in logic and mathematics. Particularly in automated theorem proving, computers demonstrated formidable capabilities in automated reasoning and theorem verification through intricate symbolic logic systems and intelligent inference algorithms.

In the 1980s and 1990s, the emergence of expert systems [28] once again sparked a surge of research in AI. These systems emulated the decision-making processes of human experts in domains such as chemical analysis, medical diagnosis, and logical reasoning, thereby demonstrating the practical value and diverse applications of AI. These early expert systems achieved breakthroughs in their respective specialized domains and accumulated rich experience for subsequent AI research. Since 2006, deep learning technology [29] opened up new directions for the development of intelligent applications. In 2012, in the ImageNet Large Scale Visual Recognition Challenge, the AlexNet model [30] achieved remarkable performance and won the championship. AlexNet showed the enormous potential of CNNs in handling complex image data.

2.1.1 *Machine Learning*

Machine learning [31] empowers computers to learn and improve from data without explicit programming of detailed instructions, understanding the underlying patterns and regularities within data. As shown in Figure 5, machine learning can be primarily categorized into supervised, unsupervised, and reinforcement learning. Typical algorithms are summarized in Table 3. Supervised learning [32] relies on labeled data to guide the learning process. Unsupervised learning [33] learns the knowledge from datasets without labels. Reinforcement learning [34], as an advanced computational paradigm, draws inspiration from the learning processes of biological organisms in natural environments.

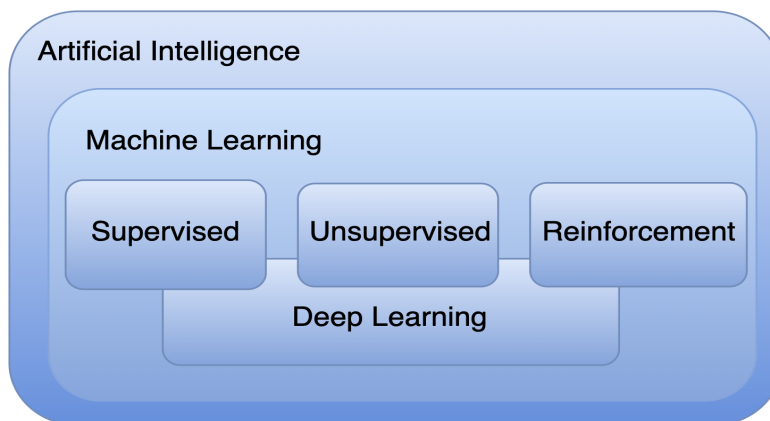

Figure 5 Relationship between AI and algorithms

Table 3 Typical algorithms of machine learning

Category	Algorithm	Description
Supervised Learning	Linear Regression	Predict the linear relationship
	Decision Trees	Tree based decision-making
	Random Forest	Integrate multiple decision trees
	K-Nearest Neighbors	Classify samples based on distance
	Support Vector Machine	Segmenting data through hyperplanes
Unsupervised Learning	Cluster Analysis	Grouping data based on similarity
	Association Rule Learning	Discover the dependencies in data
	Auto-Encoder	Learn the feature expression
	Principal Component Analysis	Extract the features of data
Reinforcement Learning	Q-learning	Optimize strategy by Q-table
	Sarsa	Optimize strategy by current strategy
	Actor-Critic	Combine gradient and value function

2.1.2 Deep Learning

The principle of deep learning technology is to emulate the human brain [35], constructing artificial neural networks to learn knowledge from data. The neural layers can automatically learn and extract complex feature patterns from large-scale datasets, using gradient descent to update parameter errors. Table 4 summarizes some popular deep learning algorithms, and detailed descriptions are given as follows. Convolutional neural network (CCN) are widely used for image and video understanding [36]. Inspired by the functioning principles of the biological visual system, CNNs efficiently extract local features from image data via convolution operations and reduce computational complexity through pooling layers. Recurrent Neural Networks (RNN) represent a class of neural networks designed explicitly for sequential data within deep learning. Leveraging a recursive network structure [37], RNNs excel at capturing latent dependencies in sequential data. Generative adversarial networks (GANs) are a class of neural networks widely used for unsupervised learning. They comprise two neural networks, a discriminator and a generator, and use adversarial training to produce artificial data identical to actual data [38]. Deep Reinforcement Learning (DRL) is a convergence of deep learning and reinforcement learning [34], employing deep neural networks to approximate value functions or policy functions in reinforcement learning problems. This approach enables agents to autonomously learn and optimize decision-making processes to maximize long-term rewards in complex and dynamic environments [39, 40].

Table 4 Typical algorithms of deep learning

Category	Typical Algorithm	Description
CNN	LeNet-5	Early convolutional neural network
	AlexNet	Introduce ReLU and GPU acceleration
	ResNet	Introduce residual connections
RNN	LSTM	Introduce gate mechanism
	GRU	Simplified version of LSTM
	Seq2Seq	Translation and Abstract Model
GAN	WGAN	Introducing Wasserstein distance
	CycleGAN	Image to image without paired data
	StyleGAN	Generate high-quality images
DRL	DQN	Solve high-dimensional state problems
	DDPG	RL for continuous action spaces
	PPO	Improvement of Policy Gradient

2.2 Overview of Large Language Models

2.2.1 Generative Models

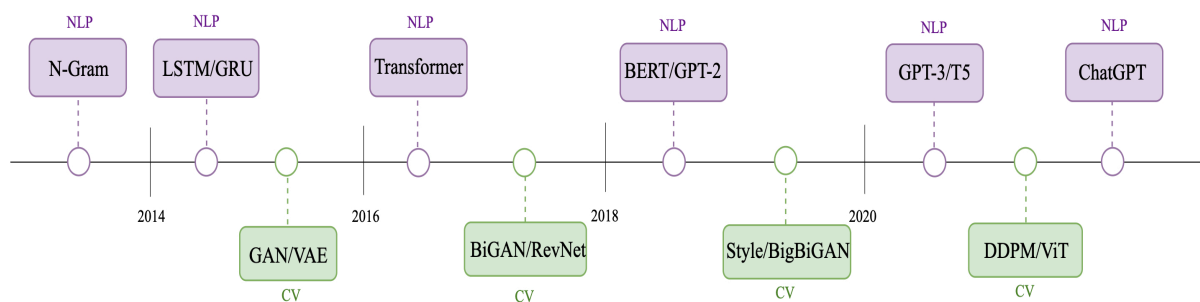
**Figure 6** History of generative neural models

Generative models [41] learn the distribution of data models to generate new data. Figure 6 outlines the history of generative models. Hidden Markov models [42] and Gaussian mixture models [43] were proposed in the 1950s for continuous data like speech and sequences. However, the advent of deep learning significantly enhanced the performance of generative models. In NLP, traditional N-gram models [44] struggled with long sentences, leading to the adoption of RNN [45] for modeling longer dependencies. The development of LSTM [46] and GRU [47] further enhanced performance by controlling memory during training.

Generative adversarial networks (GANs) [48] were proposed in 2014. Besides GANs, other methods like Variational Autoencoders [49], and diffusion models have been developed to provide finer control over the image generation process and produce high-quality images. The development paths of generative models for NLP tasks and images differ across fields but eventually converge on the Transformer model architecture. Introduced by Vaswani et al. in 2017, the Transformer model revolutionized NLP tasks and was subsequently applied to computer vision, becoming the dominant architecture for many generative models [50], [51]. Prominent large language models such as BERT and GPT use the Transformer architecture as their primary building block, outperforming traditional models like LSTM and GRU. In computer vision, models like the Vision Transformer [52] and Swin Transformer [53] advanced this concept by integrating Transformer models with visual components for image-based tasks. This cross-domain convergence facilitated the development of multimodal models like CLIP [54], integrating transformer architecture with visual components for image encoding and multimodal prompt generation.

Large language models such as GPT-3 achieved state-of-the-art performance on various natural language processing tasks. Many large models were also introduced, including Stable Diffusion [55] and the Sora.

2.2.2 *Datasets of Large Language Models*

Datasets play a pivotal role in the training of LLMs. The selection and construction of datasets are critical factors in ensuring that models can learn and generalize effectively. Some popular datasets are outlined as follows.

In early studies, ImageNet [56] is a prominent large-scale image database from Stanford University. It contains over 14 million images spanning diverse categories, including animals and plants. ImageNet serves as a benchmark dataset for evaluating the performance of image classification. COCO dataset [57] is built by Microsoft. It includes over 330,000 carefully curated images, with detailed annotations for 220,000 of these images, covering 80 different object categories. COCO is treated as an essential benchmark for evaluating image processing algorithms. BookCorpus [58] is a widely used multilingual book corpus that systematically collects and formats publicly available e-book resources, providing a large-scale text database that is accessible and easy to manipulate for both academia and industry. Pile dataset [59] is a comprehensive open-text resource library that integrates over 20 different types of subsets, including literary works, news articles, online encyclopedias, programming code, academic papers, and dialogue transcripts. Audio Set [60], meticulously constructed by Google's research, is a vast audio recognition dataset that has become an essential resource for advancing sound recognition, classification, and event detection. HowTo100M [61] dataset aggregates one million instructional videos from YouTube, covering various topics, including cooking, crafts, and personal care.

2.2.3 *Large Language Models*

The development of large language models (LLMs) has been astonishingly rapid. Early models like T5 [62] had only around a billion parameters, but with the application of scaling laws, recent models such as PaLM have grown to hundreds of billions of parameters. This highlights the rapid expansion in the scale of LLMs. Regarding performance, early-stage LLMs have already dominated conventional NLP tasks, outperforming other models. Notably, the recent GPT-4 model [63] can match or even surpass human performance in various exams, such as the US Bar Exam [64].

In 2020, OpenAI introduced GPT-3, trained on over 45TB of text data with an astounding 175 billion parameters. In early 2022, InstructGPT and GPT-3.5 were released, both large language models based on GPT-3. InstructGPT was designed to execute specific instructions, while GPT-3.5 aimed to align more closely with human values. Then, in November 2022, OpenAI launched ChatGPT, a conversational model that builds upon the GPT series. Besides the GPT series, other notable open-source large models include Llama-2-70B [65] and Zephyr-7B [66]. Llama-2-70B, trained on a vast dataset of 20 trillion tokens, excels in general benchmarks, with its variant Llama-2-chat-70B achieving a remarkable 92.66% win rate in AlpacaEval [67], surpassing GPT-3.5-turbo, though GPT-4 leads with 95.28%. Zephyr-7B, using distilled preference optimization, scores 90.6% on AlpacaEval and outperforms Llama-2-chat-70B on MT-Bench [68]. Additionally, WizardLM-70B [69] scores 7.71 on MT-Bench, slightly below GPT-3.5-turbo and GPT-4. Despite Zephyr-7B's strong MT-Bench performance, it ranks poorly at 52.15% on the open-source LLM Leaderboard. In contrast, GodziLLa2-70B combines Maya Philippines datasets with Llama-2-70B, achieving a competitive 67.01%, akin to GPT-3.5-turbo but below GPT-4's 85.36%. UltraLlama matches GPT-3.5-turbo's performance and excels in specialized domains. While not matching proprietary counterparts, these open-source models provide robust tools and resources for advancing natural language processing, driven by community efforts and expanding AI technology applications.

A line of large vision models has been proposed for images. DALL-E 2 [70] is a powerful image generation model developed by OpenAI, incorporating multiple advanced technologies, including the CLIP model's text-to-image alignment capabilities, diffusion model's generation mechanism, and the Transformer architecture's deep learning capabilities. Google's Parti [71] is a text-to-image generation model. It decomposes images into multiple image tokens and employs ViT-VQGAN technology for efficient encoding. This process involves a sizeable encoder-decoder network with 20 billion parameters. Google's Muse [62] is a text-to-image generation Transformer model and utilizes a masked transformer architecture to perform efficient masking tasks in a discrete token space.

We also witnessed a series of video models. OpenAI's SORA [72] is a revolutionary text-to-video generation tool that has opened new frontiers in the creative industry. This model rapidly transforms textual

descriptions into visual stories, providing an unprecedented creative tool for professionals with agility, intelligence, and adaptability across various fields. Luma AI’s Dream Machine is an advanced video generation tool that employs a flexible and efficient multi-modal Transformer architecture trained directly on video data. This model can produce high-quality, realistic video content and simulate physical phenomena such as gravity, collisions, and light variations, ensuring visual and physical coherence. Google’s Veo is a large-scale video generation model that integrates several state-of-the-art technologies, including GQN, DVD-GAN, Imagen-Video, and Phenaki, and advanced models such as Transformer and Gemini. Veo can generate high-quality video content from various input modalities, including text, images, and videos.

3 AI for Network

3.1 Definitions of AI4Network

AI for Network is the notation of using AI to improve the performance, efficiency and user service experience of the network itself. The primary research of AI for NET includes using AI to optimize traditional algorithms, optimize network functions, optimize network operation and maintenance management, etc., to improve the transmission efficiency and wireless performance of the wireless air interface and network sides. Figure 7 illustrates a schematic of AI’s capabilities for the network.

AI enables wireless networks through operation and maintenance efficiency improvement, network performance enhancement, and new business enabled. AI can allow wireless networks based on AI’s capabilities, including feature extraction, Forecast, Self-adaptation, Optimization, Real-time, correlation, Scene clustering and other capabilities. These capabilities are the basis for AI to enable wireless networks. In the user’s environment, AI optimizes traditional methods to improve network performance on various terminal devices. AI leverages its ability to assist in optimizing the network, and different cases reflect AI’s capabilities. AI can optimize network element functions and central management in the upper-layer network to improve network operation and maintenance efficiency. At the same time, the generation of AI has also spawned a series of new services to improve and better serve users.

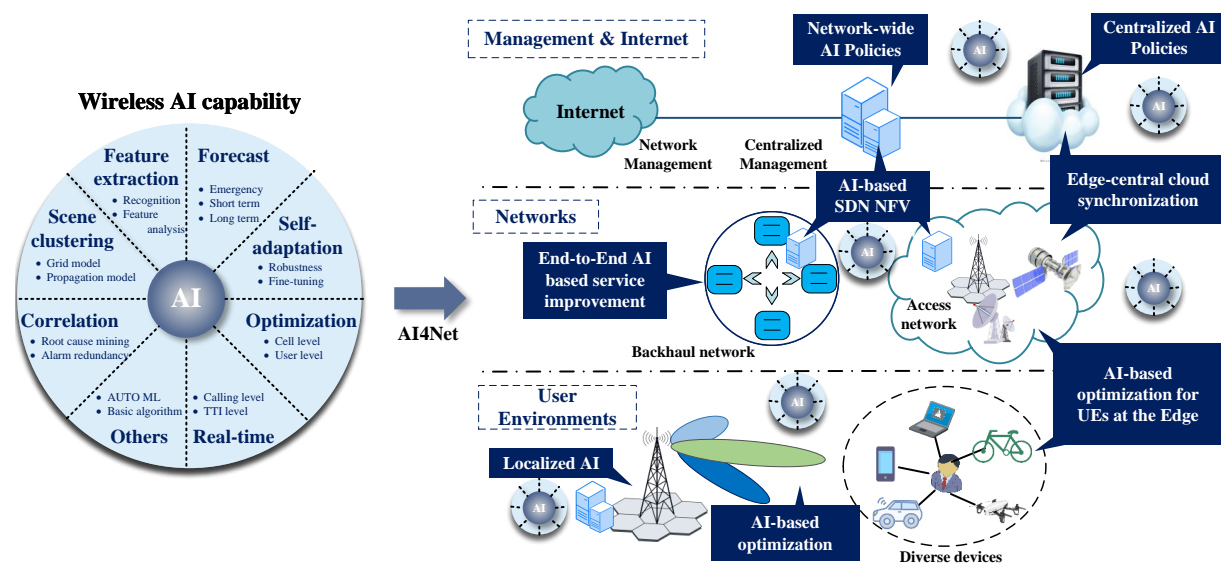

Figure 7 Schematic of AI’s capabilities for Network

3.2 Improved O&M Efficiency

AI can analyze large amounts of data and make decisions in real time [73]. This can be particularly useful in wireless networks, where many variables and parameters must be constantly monitored and adjusted to optimize the system’s performance. Table 5 lists the wireless use cases of AI.

AI algorithms can analyze data from the wireless network to predict when maintenance is needed, allowing maintenance to be performed proactively and timely. It can dynamically allocate resources,

such as bandwidth and power, in the wireless network to optimize the system’s performance.

The air interface data is affected by the environment and has significant time variability, and the data quality is easily affected by many factors. Such sparse, high-dimensional data is very suitable for building a mapping relationship between the input and output of AI models, and the wireless data generated at all times ensures the number of samples for model training.

Comparing AI technology with traditional air interface technology, we show the unique advantages of AI itself and point out the development direction of the deep integration of wireless air interface technology and AI in the future. It also signifies the beginning of the communication network’s evolution toward increased intelligence and autonomy.

Table 5 Wireless use cases of AI.

Classification	Use Cases & AI capability
Improved O&M Efficiency	Traffic Prediction Algorithm & Forecast
	Network Parameter Optimization & Optimization
	Digital Twin
Air Interface Performance Enhancement	CSI Feedback & Feature extraction
	OFDM Receiver & Self-adaptation
	Beam Management Algorithm & Feature extraction
	BS Energy Conservation & Forecast
New Business Enablement	Mobility Management & Forecast
	Network Slicing & Optimization
	Wireless Localization Algorithm & Real-time Environment Awareness & Real-time

3.2.1 AI-Based Traffic Prediction

With the wide application of 5G communication, users’ demand for data traffic continues to increase, and traffic prediction is also paid more attention in communication, as shown in Figure 8. Considering the increasing network load, analysis data based on network traffic can effectively reconfigure the structure of multi-provider networks. Traffic prediction is a means [74] for various networks to realize intelligent network operations such as resource management and predictive control. A forecasting method based on historical averages can be used in traditional traffic forecasting. This approach is based on the assumption that network traffic has a cyclical nature. By averaging the historical data, it is possible to predict the traffic at the next moment.

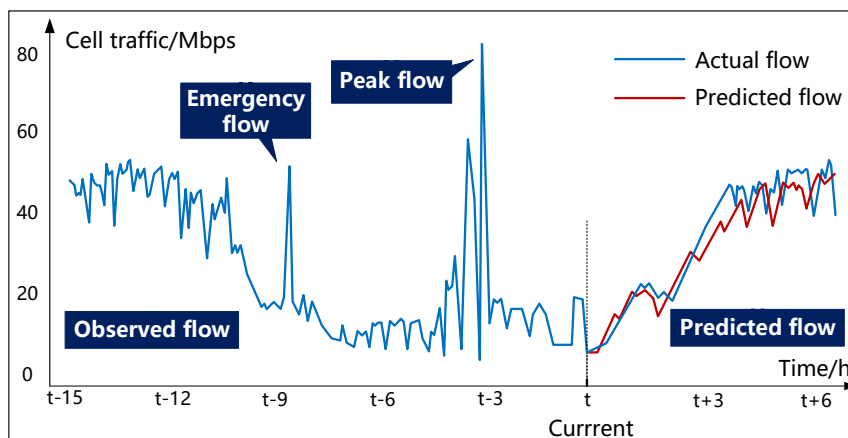

Figure 8 The structure of traffic prediction

However, traffic forecasting methods based on historical averages have specific bottlenecks. Although the model of this method is simple, it lacks the use of geographic location, data change trend and other information, resulting in obvious errors. The traditional traffic prediction method makes fitting the complex time-varying communication traffic model challenging. In this case, introducing AI technology has become a new direction to solve this problem. At present, AI algorithms have been widely used in the field of mobile communication traffic prediction. For example, algorithm models based on machine learning include Random Forest (RF), Multiple Linear Regression, Gaussian Process Regression, and Prophet time series prediction algorithm. These machine learning algorithms perform better than traditional statistical models but still struggle to capture the spatio-temporal characteristics of the data. Deep learning can effectively extract intrinsic features, such as continuity and timing of traffic information. Compared with traditional statistical models, deep learning models have strong adaptability when dealing with massive and complex communication traffic data. They can extract multi-level features and adjust themselves in time.

Examples such as Residual Networks (ResNet), 3D Convolutional Networks (3D-CNN), GAN and other deep learning models can be used. These models can analyze user behavior patterns and device characteristics, learn the internal relationship between user data to accurately predict user demand for different services and applications, and optimize the resource allocation of the network based on this. At the same time, these models can also analyze network traffic data, identify factors that may lead to network failures, and predict the occurrence and recovery of failures, helping operators diagnose and solve problems faster and accurately and improve network reliability and stability.

In [75], random forest and linear regression are combined to solve the traffic prediction problem in backbone optical networks. In [76], a network traffic prediction model based on synchronous Periodic LSTM (DSP-LSTM) was proposed, which can comprehensively consider the good fitting ability of a linear model to periodic characteristic data and the nonlinear prediction characteristics of neural networks. [77] The internal mechanism of network traffic outburst is explained by extracting the time series of the newly generated number of network flows. The number of network flow-based traffic prediction models shows noticeable performance improvement over the original LSTM and TCN models. In [78], a hybrid prediction model for passive optical network traffic was proposed, which combines fully integrated empirical mode decomposition with adaptive noise with particle swarm optimization support vector regression and LSTM neural networks, showing high prediction accuracy. In [79], a network traffic prediction method based on time representation and spatial convolution was proposed. Graph convolution network was used to explore the topological features of network nodes, and LSTM was used to characterize the time features of the network to help the network learn daily and weekly long-term time features.

3.2.2 *AI-Based BS Energy Conservation*

The traditional network energy-saving algorithm usually considers the current load of the BS to control the opening and closing of the BS [80,81]. Traditional energy-saving strategies mainly involve device-level and site-level energy conservation [82]. At the device level, hardware energy-saving schemes are primarily studied from device and hardware design, and some RF power amplifiers are turned off when the BS load is low. At the site level, software energy-saving schemes are mainly studied from a symbol (subframe), carrier, channel turn-off, deep hibernation, etc. By changing the BS mode at a low load, the effect of energy conservation is achieved.

Nowadays, mobile communication networks are large and complex, requiring high-precision real-time data processing and system-level coordination and optimization capabilities. The traditional BS energy-saving algorithm has obvious defects in data processing, operations optimization and system comprehensive optimization. Therefore, the current energy conservation of BSs includes not only equipment level and site level energy conservation but also network level energy conservation. Figure 9 illustrates the structure of BS energy conservation. The blue line indicates the traffic required by the base station, and the thick black line indicates the actual traffic consumption. It can be seen that the actual traffic consumption far exceeds the exact needs of the base station, and the thin black line makes the traffic consumption we want to see. From the perspective of multi-network coordination, intelligent energy conservation scheme research is carried out, and AI strategy deployment plays a crucial role in network-level energy conservation [83].

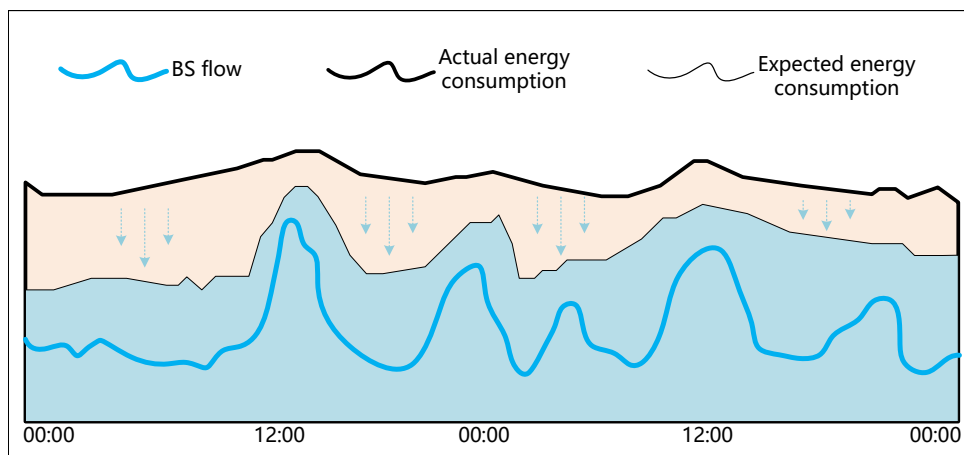

Figure 9 The blue line indicates the actual flow of the BS, and the bold black line indicates the actual flow of the base station, which shows that the actual flow is much higher than the needs of the BS, so we hope to meet the traffic demand and reduce the energy consumption of the BS like the thin black line.

AI strategy can quickly analyze large-scale energy consumption data and discover hidden rules and correlations [84]. Therefore, network traffic can be accurately predicted according to dynamic data analysis results to reasonably plan parameters such as BS power and hibernation state and achieve accurate energy consumption control and resource optimization. The AI method can also systematically consider many factors, such as network coverage, capacity, and signal quality, to dynamically adjust the energy-saving strategy in the network and realize the global optimization decision. In addition, primary data such as the configuration and performance statistics of the live network can also be used to optimize the 5G device-level energy-saving function parameters based on feature clustering and neural network algorithms. Under the premise of ensuring service quality, the problem of 4G/5G overlapping coverage can be fully considered for the cell's cooperative shutdown to maximize the effect of the device-level energy conservation function [85].

3.2.3 AI-Based Network Parameter Optimization

In wireless communication systems, parameter configuration profoundly impacts network performance. One of the most important aspects is the appropriate setup of the network parameters, as these determine the design, energy consumption, and performance of the 5G network and need to be aligned with the real-time user distribution and electromagnetic environments. According to the characteristics of wireless networks, network parameters can be divided into two categories: BS and threshold. Specifically, the BS parameters involve switching essential functions, such as VONR, paging, and slicing. The threshold parameters configure thresholds for cell reselect, event decision, and neighborhood switching. Table 6 summarizes various parameters in the current network.

The traditional parameter optimization mainly relies on road test collection and expert experience judgment. The current network parameter optimization methods are as follows: The particular network operator drives a radio monitoring vehicle to gather and report network performance indicators, such as network throughput and audio and video transmission delay, when the network operator determines that there are evident flaws in the communication service quality provided. After that, the operator creates a scatter plot to characterize the network performance further, and lastly, using expert experience, analyzes and optimizes the network parameters [86]. With the network structure's complexity, traditional parameter optimization's efficiency is inefficient. The channel is no longer a straightforward one-dimensional circuit loss structure due to the significant increase in 5G antennas; instead, it now extends to the N -dimensional angular power spectrum, producing an extremely large-scale parameter combination. Expert experience-based parameter tuning efficiency is low, making modifying hundreds of millions of 5G network parameters challenging. In addition, traditional empirical tuning methods often rely on inherent rules and cannot fully capture and adapt to complex relationships in the network [87].

However, AI models' non-linear fitting and large-scale real-time tuning capabilities show unprecedented advantages [84]. First, AI models are better suited for large-scale parameter adjustment. As the number of 5G antennas and network complexity rise, there are an increasing number of possible combinations for

Table 6 Various parameters in the current network

Data Type	Data Name	Application Area
Terminal data	Block error rate	Scheduling optimization
	Traffic information	Traffic monitoring
	Measurement report	Adaptive Coding
Air interface data	Multi-path time delay	Channel modeling
	Inter-cell interference	Interference cancellation
	Channel state information	Channel state prediction
Core network data	Operation log	Fault handling
	Network topology	Load balancing
	Network energy consumption	Energy saving
Service data	Online duration	Personalized service
	Transport protocol	Transmission control
	Consumption history	Service monitoring

network parameters. AI can quickly search and optimize these combinations. Secondly, AI models can better deal with complex nonlinear problems: 5G networks have a highly complex architecture and nonlinear characteristics [88]. By learning and analyzing a large amount of network data, AI technology can better understand the non-linear characteristics of the network to find better parameter configurations. Finally, the AI models align with the real-time requirements of network parameters: in 5G networks, the dynamic changes of user needs and network environment are fast, and network parameters must be adjusted in real time to meet the needs of different scenarios. AI technology can promptly optimize network parameters according to real-time data and scene requirements for better performance.

To optimize network parameters, deep reinforcement learning can be applied [89]. First, each performance indicator of the current communication networks is regarded as a different reinforcement learning state. The model's network parameter adjustment is viewed as performing various actions. By constantly adjusting the behavior of the reinforcement learning model in other states, the model gets feedback from the environment to know how good or bad each action is. Reinforcement learning models tend to reinforce actions with high rewards. As the rewards overhead is stabilized, deep reinforcement learning gradually converges, thus determining the optimal configuration of the wireless network parameters.

3.2.4 AI-Based Mobility Management

Mobility management is a critical component in modern wireless communication networks. Mobility management includes mobility in the idle state and mobility in the connected state. Due to the increasing number of mobile users and the increasing complexity of services, how to effectively manage mobility to improve network performance and user experience has become a critical issue.

Traditional mobility management relies heavily on preset policies and rules. In the idle state, mobility management involves cell selection and switching. Cell selection is usually based on signal strength, network load, and priority. In the connected state, the device must decide whether to switch cells based on network conditions, such as network coverage, quality, and load. In addition, the device may also undergo same-frequency switching or cross-frequency switching. Frequency switching refers to the equipment at the same frequency switching between two villages; different frequency switching equipment is involved in switching between the different frequencies of the villages.

However, there are some bottlenecks in the traditional mobility management approach. One is that these techniques might not manage user interactions fast enough when the number of mobile users spikes, leading to excessive network traffic and poor performance. The second is that typical mobility management techniques may be challenging in complex network situations, such as big public spaces or events, which could cause network congestion. Furthermore, users traveling at fast speeds—like those in cars—may have unreliable network connections due to frequent switching.

Over the past few decades, many schemes have been proposed to optimize mobility management [90],

[91], [92], [93]. They all have a reactive nature; adjustments are often made after rather than pre-planning when dealing with mobility issues. This design can lead to delays and inefficiencies in mobility management and some unnecessary waste of resources.

To address these problems, AI has been introduced into mobility management. The advantage of AI is that it can process large amounts of data, learn automatically from data, and optimize strategies without human intervention. This allows AI to manage mobility more effectively, which improves network performance and user experience. Starting as early as 2015, 3GPP began to study how AI technology could be integrated into 5G networks. For example, the 3GPP SA2 and SA5 working groups' "Enablers of Network Automation" and "Enhancement of Managed Data Analytics Services" projects made impressive progress of [94].

AI has shown significant advantages in mobility management with its superior fitting capabilities. On the one hand, using techniques such as deep learning, AI can predict user behavior, such as movement speed and direction, so that cell selection and switching can be done in advance to reduce signaling overhead. For example, in ultra-dense networks, AI can predict the next moment location of vehicles and select BSs according to the predicted location, thereby reducing the switching frequency and switching failure rate and saving the switching signaling overhead [95]. On the other hand, using techniques such as reinforcement learning, AI can dynamically optimize mobility management strategies based on the network environment and user behavior to better cope with complex network environments. Take D2D communication as an example. Traditional cellular networks require BSs to relay user communications, which helps management but adds to transmission latency. The introduction of D2D communication allows direct communication between users within a short distance, improving communication quality and reducing delays. The reuse of cell user resources can improve spectrum utilization [96]. However, this will also interfere with cellular users and increase the management burden of BSs. By utilizing deep reinforcement learning technology, a D2D user terminal functions as an agent capable of autonomously determining the best spectrum access plan without prior knowledge. This can lessen the load on the BS and enhance system efficiency.

3.3 Air Interface Performance Enhancement

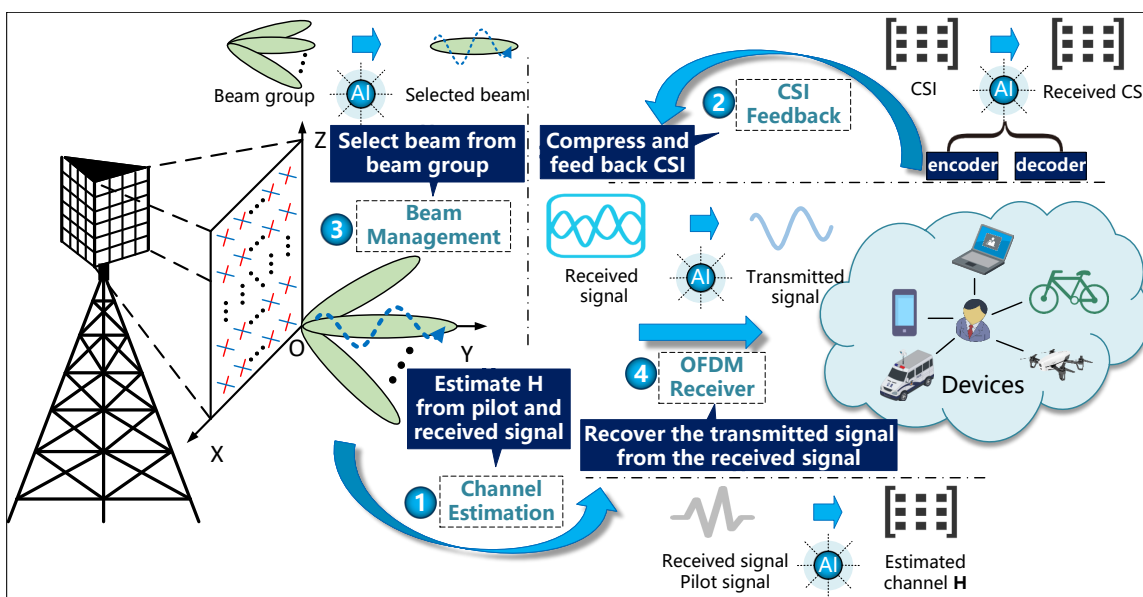

Figure 10 Different AI use cases on the air interface. The user will first estimate the downlink channel through the pilot signal, which assists the BS in selecting a good beam to target the user through the feedback channel. Then, communicate with the corresponding user using the selected beam information.

In [97], a white box countermeasure attack evaluation method for the physical layer of semantic communication was proposed for the first time, which generates a high-concealed, data-independent and controllable physical layer attack generation method, solves the problem of 6G semantic communication air interface disturbance generation in a substantial interference wireless environment, and develops a

hybrid countermeasure training method. The attack evolution method can counter a variety of typical adversarial interferences and can effectively assist wireless networks in detecting abnormal situations.

The performance of the wireless air interface will directly affect the user's communication experience. Finding a better air interface algorithm to optimize air interface performance has always been the goal of industry insiders, as shown in Figure 10. However, user demands are increasing with the continuous increase of communication services. Traditional algorithms incur complexity through complex matrix operations and reach the performance bottleneck.

The booming development of AI has provided a new direction for air interface transmission in communication. AI can fit complex and nonlinear mapping relationships. Compared with traditional methods, AI is more suitable for applications in complex time-varying wireless environments. Thus, AI can replace conventional communication methods to improve wireless network performance significantly. In this section, we show how AI technology can improve the transmission performance in OFDM receivers, CSI feedback and beam management.

3.3.1 *AI-Based Channel Estimation*

Channel estimation [98], [99] is one of the most critical components of wireless communication systems. The wireless environment is complex and time-variant [100] [101]; the signals are subjected to a variety of interference in the propagation process; when the signals reach the receiver, the amplitude, phase and frequency of the signals change. The role of channel estimation and channel equalization is to recover the signal as much as possible. In this sense, a good analysis and equalization algorithm is crucial to the receiver's performance, which determines the final resolution rate of the signal.

Channel estimation algorithms based on training data sequences such as "least square method" [100], [102] and "least mean square error" [103], [104], are widely used in channel estimation. The scene of the wireless channel is complex, and the state changes in real time. When estimating the channel in real systems, the parameters in the channel estimation algorithm or the assumed model are prone to deviate from the actual channel states. As a result, the accuracy of the estimated channel can be different from the actual result. AI can remedy the mismatch between mathematical models and real scenarios in this communication [101, 105–107]. Principle: AI can learn any hidden structure and parameter to fit any complex function. Using AI to perceive wireless scenes and characterize network state space provides a new means of communication. The channel estimation process of actual scenes can be constructed into a neural network, and the algorithm's performance can be optimized by adjusting the structure and parameters of the neural network.

Considering the sparse mmWave channel matrix as a natural image, the authors of [105] propose a practical and accurate channel estimation framework based on the fast and flexible denoising CNN. Simulation results validate that the training speed of a quick and flexible denoising CNN is more rapid than that of other channel estimators without sacrificing normalized mean square error performance. [106] considered the time-frequency response of a fast-fading communication channel as a 2D image. This scheme considers the pilot values as low-resolution images and uses an SR network cascaded with a denoising IR network to estimate the channel. The results confirm that this pipeline can be used efficiently in channel estimation. To address channel distortion, the model developed in [101] is first trained offline using the data generated from simulation based on channel statistics and then used for recovering the online transmitted data directly. [101] is more robust than conventional methods when fewer training pilots are used, the cyclic prefix is omitted, and nonlinear clipping noise exists. The authors of [107] exploited a learned denoising-based approximate message passing network, which can learn channel structure and estimate channels from many training data. Simulation results show that this neural network significantly outperforms state-of-the-art compressed sensing-based algorithms even when the receiver is equipped with a small number of RF chains.

It can be seen that AI-based channel estimation can combat signal distortion caused by hardware imperfection and wireless channel fading, which narrows the gap between theory and practice. The application of AI to channel estimation has a wide range of application prospects and development potential, and improving the stability and generalization of AI models is also the main research direction in the future.

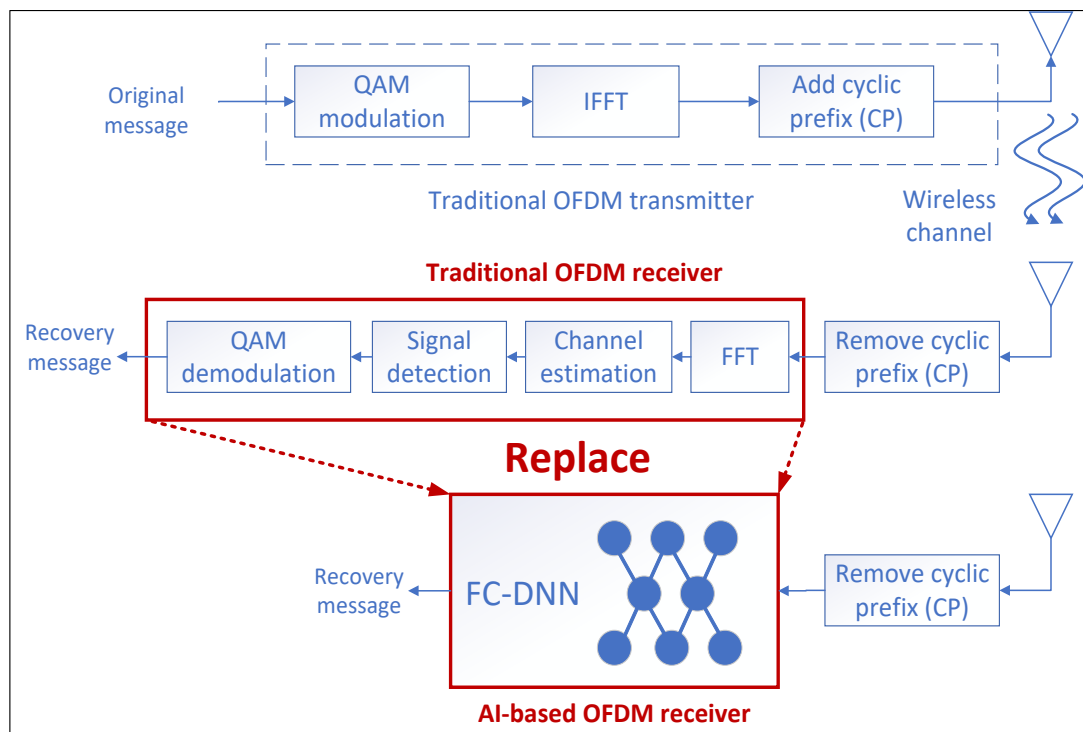

Figure 11 This is the difference between traditional OFDM and AI-based OFDM receivers. Using AI modules to replace traditional physical layer processing, AI's capabilities can compensate for signal distortion.

3.3.2 AI-Based OFDM Receiver

The wireless communication transmitter and receiver are divided into multiple processing mods in OFDM. Each module is responsible for specific sub-tasks, such as Quadrature amplitude modulation, an IFFT, channel estimation, signal detection, etc. The advantage of this design is that each module can be analyzed and optimized individually, resulting in a very efficient and stable system.

However, the performance of the traditional modular OFDM receiver depends on the accuracy of the acquired channel information. Generally speaking, the more specific the channel considered in the algorithm design of each module, the better the receiver's performance. However, the actual system obtains the channel state information, and the parameters in the channel estimation algorithms or the models are prone to deviate from the actual channel state, resulting in the receiver's performance being much different from the results obtained.

Channel estimation is one of the most critical technologies in the physical layer. The performance of channel estimation directly affects the quality of communication. Because the performance of the air interface is affected by many environmental factors, the channel estimated by traditional channel estimation methods often has a big gap with the actual channel. AI method can extract essential information in sparse and time-varying pilot frequencies. The complex mapping relationship between the pilot signal and the exact channel is effectively constructed, significantly improving channel estimation accuracy.

The mismatch between the mathematical model and the reality can be made up using AI as shown in Figure 11. In theory, AI can learn any hidden structure and parameter to fit any complex function. Using AI to perceive wireless scenes and characterize network state space provides a new means of communication. It can encode the information of actual scenes into neural networks and optimize the performance of algorithms by adjusting the structure and parameters of neural networks.

Regarding an OFDM wireless receiver, some researchers have used a fully connected deep neural network to improve the existing modular OFDM receiver. The process of the OFDM receiver after removing the cyclic prefix is regarded as a black box. Many data samples are obtained as a training set to train the neural network, learn the parameters of each layer of the neural network, and minimize the difference between the output of the neural network and the original information. In this way, the fully connected neural network receiver, after learning, uses a large number of pilot frequency and corresponding channel data as the input of multi-layer fully connected neurons and the corresponding demodulation signal

as the output. Following extensive learning, the fully connected neural network receiver employs many pilot frequencies and matching channel data as the input of multi-layer fully connected neurons, with the accompanying demodulation signal serving as the output. Fitting the complex mapping relationship between the two can effectively improve the signal reception performance and demodulation accuracy and has a powerful ability to perform channel estimation and signal detection. Thus, the performance of the receiver is significantly improved.

In [108], a model-driven deep learning (DL) approach was proposed that combines deep learning with expert knowledge to replace existing orthogonal frequency division multiplexing receivers in wireless communications. In [109], a machine learning (ML) assisted physical layer receiver technique was proposed to demodulate the OFDM signals, subject to very high Doppler effects and corresponding distortions in the received signal. To find a balance between full-size CP and non-existent CP, the authors of [110] investigate the redundancy problem and propose a minimum redundant OFDM receiver using deep learning (DL) tools. In [111], the receivers were designed based on deep neural networks (DNNS) in deep learning, consisting of a layer of DNNS and soft decisions. The problems of channel estimation error, delay, and decoding limits between users with traditional detection methods have been solved. It can recover the symbols of all users at one time and jointly perform channel estimation and signal detection. In [112], a novel generative supervised deep neural network is designed that can be trained using a reasonable number of pilots. After channel estimation, the neural network-based receiver (specifically, the autoencoder) jointly learns the pre-encoder and decoder for data symbol detection. In [113], an intelligent receiver for the OFDM communication system was designed based on the Densenet neural network structure, and the intelligent receiver is realized by optimizing the Densenet neural network structure. This method can recover information at the receiving end and avoid complicated pilot operations and signal error accumulation. In [114], a CNN (CNN) was used to reduce the bit error rate by using the mathematical calculation function of discrete Fourier transform (DFT) and the training of OFDM signal samples.

3.3.3 AI-Based Beam Management

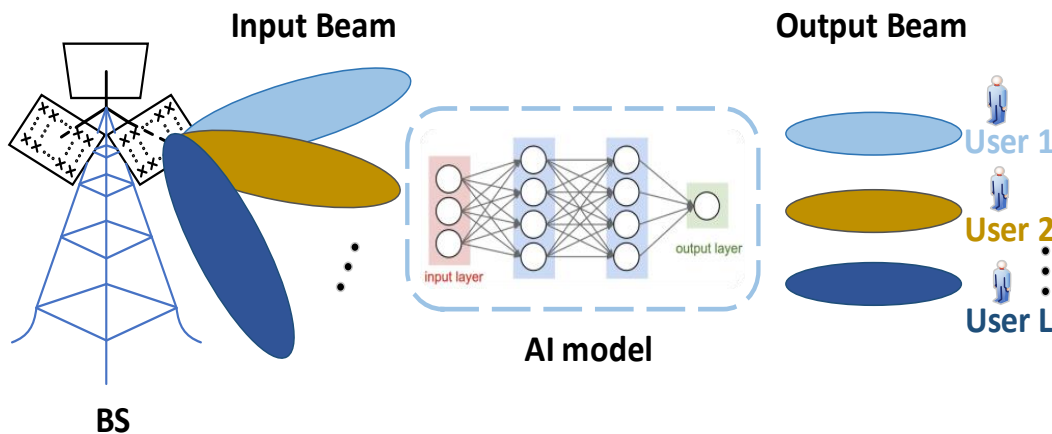

Figure 12 This is the structure diagram of AI-based beam management. AI selects the optimal beam by looking for the complex mapping relationship between input and output, which can significantly reduce the search cost of the beam while ensuring prediction accuracy.

Compared with traditional multi-antenna technology, the large-scale multi-antenna system produces more beams and narrow widths and faces new challenges in beam alignment. In September 2022, the IMT 2030 (6G) promotion group released the Research report [115] on Very large MIMO technology, pointing out that hierarchical scanning is generally adopted to align the beam quickly. In the existing academic literature, the beam selection methods of multi-antenna systems can be divided into several categories, including beam selection based on beam scanning [116], [117], beam selection based on training signals [118], beam selection based on position prediction [119], [120], and beam selection [121], [122] based on hierarchical search.

The traditional beam management methods have some limitations when applied to millimeter wave

Massive MIMO systems [123]. The primary cause is that the real-world wireless propagation environment often has a variety of it. After a beam is narrowed, the signal transmission is more susceptible to occlusion. The significant increase in the number of beams significantly increases the number of beam search operations in beam alignment. It is difficult to accurately select the optimal beam instantaneously.

AI can fully explore the correlation between the beams themselves, which allows for solving the problems existing in the traditional beam management method as shown in Figure 12. In the actual communication scenario, the massive historical beams provide enough data for training AI models, and the search for the optimal beam based on the correlation between beams constructed by AI dramatically reduces the search space of the beam. At the same time, due to the implicit structure of AI, more complex functional relationships can be explored. Compared with the traditional beam management method received signal strength (RSS), even in a low signal-to-noise ratio environment, the optimal beam selection based on AI still has obvious advantages and robustness. As shown in Fig. 12, red and blue represent antenna arrays with two polarization directions. AI is used to intelligently select beams without beam search, effectively reducing system complexity.

A wide beam can also be used to predict a narrow beam, reducing the beam search space and improving the accuracy of beam prediction. As the input of the AI model, the wide beam is used to predict the narrow beam without activating all antenna arrays, thus reducing the computational search cost on the BS side. Compared with the RSS method, the prediction accuracy is still high in low SNRs.

3.3.4 AI-Based CSI Feedback Algorithm

With the development of multi-antenna technology, CSI feedback design has become a critical point in the research of broadband wireless communication systems. In frequency division duplex mode, the terminal estimates the channel through a downlink pilot to obtain downlink channel information. Since the reciprocity of upstream and downstream channels is not apparent, the terminal needs to feed CSI back to the BS through the uplink. The BS side needs to know the downlink channel to form a beam with better alignment. As the uplink resources are precious, ensuring the accuracy of channel reconstruction and reducing the CSI feedback cost as much as possible is one of the bottleneck problems to overcome in the massive MIMO system based on Frequency Division Duplex.

Traditional CSI feedback includes codebook-based CSI feedback and compressed sensing-based CSI feedback. The standard maker designed the traditional codebook-based CSI feedback in advance and cannot adapt to all possible channel state changes. Sometimes, there is a significant feedback error [124]. CSI feedback based on compressed sensing [125] relies on the sparsity of the channel matrix to ensure performance. In other words, if the channel is not sparse enough, the accuracy of the CSI reconstructed based on compressed sensing theory will be affected. In addition, under the limited feedback overhead, either type of traditional CSI feedback requires many matrix operations, resulting in computing power overhead.

The massive CSI data and the inherent random characteristics of CSI make it preferable to introduce AI to design a new CSI feedback mechanism, as shown in Figure 13 compared with the traditional method. For example, the nonlinear characteristics of deep learning can be used to extract the features of CSI efficiently, and the original CSI data can be transformed into a more compact feature representation, thus reducing the communication overhead in the CSI feedback process. An example of an implementation is the autoencoder architecture, which uses neural networks to extract and compress the features of CSI channel information. The autoencoder consists of an encoder and a decoder. The encoder compiles the high-dimensional channel state information into code words. The decoder is responsible for decoding the code words into the original CSI. The internal structure of encoders and decoders of different algorithms is different, resulting in a difference in channel reconstruction performance. The authors of [126] apply deep learning to CSI feedback first. The proposed CsiNet scheme uses convolution to extract channel features, compress and reconstruct channels, and is superior to the CSI feedback scheme based on compressed sensing regarding feedback accuracy and computational complexity.

The studies in [127–130] increase the size of the convolutional kernel based on CsiNet to improve the perceptual field of view of the convolutional layer, which is conducive to extracting the sparsity of the channel and further enhancing the accuracy of channel reconstruction. Although a larger perceptive field of view can effectively extract the sparsity of CSI, a smaller convolution kernel can extract finer features from CSI. In [131], a Non-Local neural network is introduced based on the CsiNet network to capture a wide range of dependencies, and the accuracy of channel recovery was improved compared to CsiNet.

CRNet proposed in literature [132] uses convolution kernels of different sizes for channel feature extraction and recovery, reducing the computation and improving the accuracy of channel reconstruction.

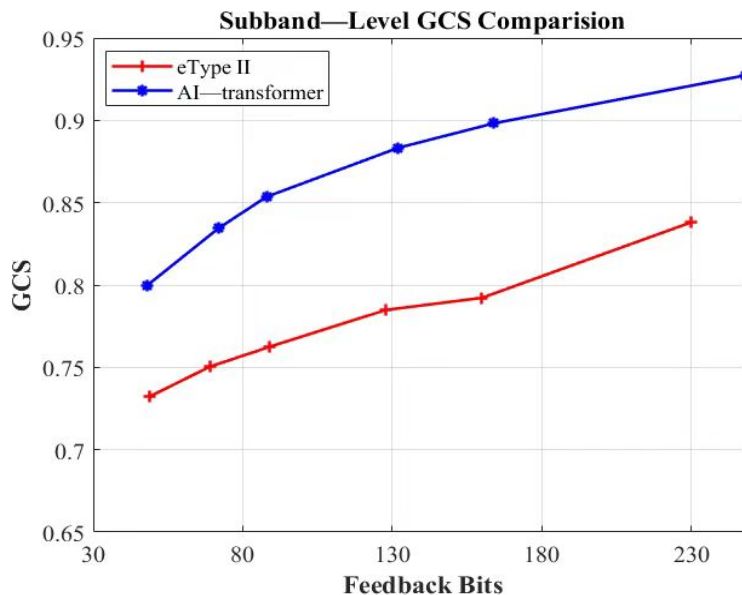

Figure 13 GCS performance between AI-based CSI feedback and codebook-based CSI feedback.

3.4 New Technological Applications Enabled

AI algorithms can dynamically allocate resources, such as bandwidth and power, to create and manage network slices in the wireless network. This can enable the creation of customized networks tailored to the needs of different applications and services. The booming development of AI has enabled the development of many new technological applications, such as network slicing, mobility management, and wireless localization.

3.4.1 AI-Based Network Slicing

As a core component of 5G technology, network slicing divides infrastructure networks into multiple proprietary logical networks through virtualization technology to meet the customized needs of different vertical industries [133, 134]. Based on isolation principles, customization and end-to-end, network slicing can provide users with differentiated, mutually isolated, and customizable network services with functions and capacities while ensuring the realization of the end-to-end service level agreement (SLA) for services. Although network slicing technology has brought revolutionary changes to 5G networks, its implementation still faces challenges and limitations [135, 136]. Firstly, the complexity of managing and maintaining network slicing increases with the number of slices while meeting the customized needs of different industries and applications. Secondly, the dynamic network environment and changing service demands require network slicing to adapt and adjust quickly, which is often difficult to achieve under the traditional network management framework. In addition, ensuring the isolation between different network slices to prevent resource contention and performance interference is also a vital issue in implementing network slicing [137].

After introducing AI technology, the management and optimization of network slicing will face changes [138] [139]. AI technology can automate the configuration, optimization, and troubleshooting of network slicing through a data-driven approach, significantly improving network flexibility and efficiency. For example, AI technology can use raw monitoring data from SDN (software-defined network) controllers to predict the impact of new slicing on the network and make the right resource management decisions to ensure efficient use of network resources while reducing operational and maintenance costs [140]. AI can also enhance the adaptive capability of network slicing, enabling it to respond in real time to changes in network conditions and the evolution of service demand, thus providing more stable and high-quality services.

3.4.2 AI-Based Wireless Localization

Wireless positioning refers to obtaining the location information of mobile users in a cellular environment. This location information is usually in the form of the mobile user's geographic coordinates relative to some reference points. Wireless location is also commonly referred to as mobile location, wireless location, and geolocation [141].

Wireless positioning technology can be divided into wide and local area positioning according to the scope of services. Wide area positioning provides users with universal positioning services. Local area positioning is mainly used in indoor scenarios. Wide area positioning primarily includes mobile communication network positioning and global satellite navigation systems (e.g., the global positioning system). The GPS is a kind of high-precision radio navigation positioning system based on artificial Earth satellites, which can provide accurate geographical position, vehicle speed and accurate time information anywhere in the world and near-earth space. Local wireless positioning mainly includes Wi-Fi, Bluetooth, UWB, etc. Its positioning technology can be divided into four types: ranging positioning based on signal strength (RSS), fingerprint positioning based on signal characteristics, and positioning based on signal transmission time and Angle measurement [142].

Many applications need high-precision positioning, such as industrial AGV and asset tracking, especially indoor precision positioning, but GPS cannot be used indoors. Despite having a specific positioning reference signal, LTE cannot meet the requirements for high-precision positioning because of its low positioning accuracy and 100-meter BS separation (20 MHz). Bluetooth, Wi-Fi, UWB and other wireless location-based technologies have high deployment costs and are difficult to become a universal positioning technology [143].

AI technology has been introduced to achieve high-precision positioning in the 5G era. One approach is to utilize the random forest technique, which can create a classification model to split a vast area into many small grids and then predict the grid where the user is located. It can also make a regression model to predict the user's position coordinates. In another method, multi-layer perceptron has a similar application to random forest and can establish regression and classification models to locate targets [144]. AI algorithms can also be trained to recognize the fingerprint of a wireless signal in a specific location and process and fuse data from different sensors (such as Wi-Fi and Bluetooth) to achieve high-precision positioning.

With the widespread use of massive MIMO technology, AI has shown more significant advantages in high-precision positioning [7]. Since systems already use CSI, there is no additional cost for positioning. Using the location in the LOS/NLOS channel co-existence scenario based on the neural network as an example, machine learning and a significant volume of channel data can help effectively map the relationship between channel response and position coordinates, resolving the location problem in complex environments and increasing location accuracy. Very high positioning accuracy is achieved without negligible additional cost, even about 20 mm accuracy under indoor LOS and NLOS conditions.

3.4.3 AI-based Situational Awareness

Network situational awareness technology can bring real-time monitoring, prediction and response capabilities to mobile communication networks, including network management [86] and optimization [87], [84], [89], security monitoring, and fault detection and prediction [145]. The technology includes three levels of environmental element awareness, situation understanding and situation prediction. The network system can recognize and understand various network environmental factors, such as network state, network data, and user behavior patterns while making predictions and timely responses to the future trends of the network state. Figure 14 shows the AI-empowered situational awareness.

In the traditional situational awareness system, the rule engine is typically used to realize the perception of the network state. This sensing method is based on pre-defined rules and logic, which depends on the experience of the rule maker and cannot fully deal with the underlying information and patterns in big data. Traditional systems use data mining and statistical analysis methods to make predictions for network situation prediction models. These methods face problems such as inflexibility and difficulty dealing with complex patterns.

Applying AI technology can significantly enhance the performance of situational awareness systems. Network awareness enabled by AI technology is a data-driven network cognition mode, which can effectively improve the problems existing in traditional situational awareness systems. The massive network data collected by the system under the situational element awareness model can provide data support for

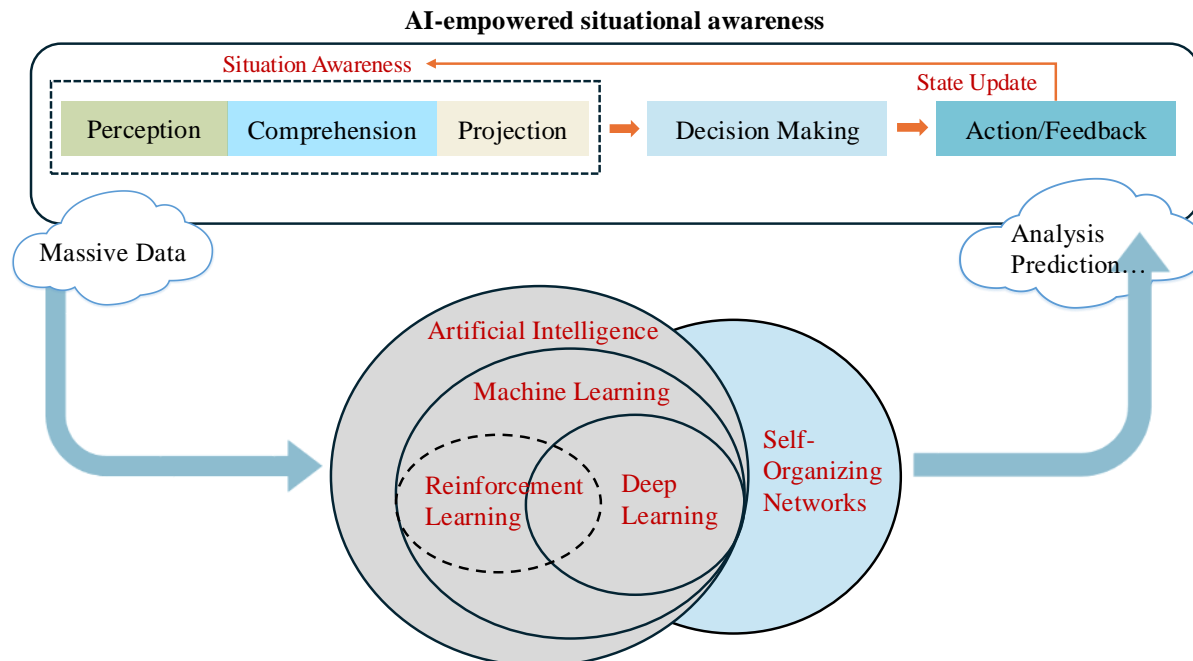

Figure 14 AI-empowered situational awareness

AI. In this model, the system can more accurately identify the state of different modes in the network, including traffic, logs, and network KPIs, through AI methods such as deep learning and predict the development trend of the network. At the same time, AI technology can use the perceptual information and the predicted state for analysis and make accurate and effective response decisions.

Specifically, it can be applied from the following four aspects:

1) Application of deep learning in network situation awareness: The application of deep learning in network situation awareness mainly focuses on effectively analyzing and processing large-scale network data to predict network state and future trends accurately [146]. Traditional situational awareness systems rely on pre-defined rules and logic, and these approaches often fail to deal with complex patterns and underlying information in big data. In contrast, by building complex neural network models, deep learning can extract valuable features from massive network traffic and log data, and make efficient classification and prediction. For example, deep learning models like CNN and RNN are used to process network traffic data to identify abnormal behavior and security threats. These models can learn and adjust automatically to adapt to changes in different network environments, thus improving network security monitoring and fault detection efficiency and accuracy.

2) Reinforcement learning application in Ad-hoc network architecture: In the Ad-hoc network architecture, reinforcement learning is widely used to optimize network resource allocation and automate network management [147]. Through trial and error and reward mechanisms, reinforcement learning enables the network to independently adjust and optimize decisions according to the current environment and goals [148]. For example, intelligent agents trained by reinforcement learning algorithms can adjust network configuration parameters in real time under changing network conditions to maximize network performance and user experience. Reinforcement learning algorithms can significantly reduce the need for human intervention, improve the adaptability and fault tolerance of the network, and reduce the cost and complexity of network management.

3) Data-driven network cognition models: A fundamental problem faced by traditional situational awareness systems is that they often rely on human-made rules and static logic, which are difficult to adapt to dynamic and complex network environments. A data-driven network cognition model uses big data technology and machine learning methods to extract knowledge from network data and realize intelligent network management and optimization [149]. By establishing a data-based network cognitive model, the system can collect, analyze and understand various states and changes in the network in real time, such as traffic patterns, network topology and user behavior patterns. In this mode, the system realizes real-time perception of network status, predicts future trends, and automatically adjusts network

policies and configurations to improve overall performance and security.

In the future, network situational awareness technology development will face new challenges and opportunities. Key developments include further improving the efficiency and accuracy of deep learning models in network data processing, optimizing the application of reinforcement learning algorithms in complex network environments, and promoting the practice and standardization of data-driven network cognitive models. Multiple technologies and challenges, such as data privacy and security protection, algorithmic adaptability and robustness, must be addressed to achieve these goals.

4 Network for AI

The current network has achieved preliminary success in advancing AI4NET, developing a series of AI use cases and scenarios, and partially implementing standardization efforts. However, most of these AI4NET implementations adopt an “add-on” design pattern, which, while convenient, may introduce additional challenges (such as latency, data privacy concerns, etc.), hindering the network’s evolution towards more efficient AI services to a certain extent. The underlying reason lies in the insufficient support the current network architecture provides for deeply integrating AI into the network. Although 5G exhibits a trend towards cloud-native, IT software-defined Service virtualization (exemplified by the adoption of Service-Based Architecture Core Network and cloud-native deployment of core networks), 3GPP has standardized the Network Data Analytics Function (NWDAF), Management Data Analytics Function, and related mechanisms and processes, with attempts to define and introduce standardized AI operational paradigms for critical use cases in RAN3 and RAN1, limitations persist due to factors such as technical maturity, security concerns, and the complexity of system operation and maintenance. As a result, the access network side largely retains the conventional “siloe CT-based BS architecture” and a relatively rigid protocol stack model. From an end-to-end perspective of AI service flows, there is a lack of defined AI functional components on the access network side, and the AI service functionalities between the core network and access network have yet to be integrated or aligned. This overall design remains incomplete, with vulnerabilities and deficiencies hindering the current network architecture from supporting the intelligent vision of 6G.

To support “native intelligence” and achieve ubiquitous general intelligence, the 6G network necessitates groundbreaking innovative designs at the network architecture level, enabling the endogenous embedding of AI capabilities within the network. This represents the core concept of Phase II (i.e., NET4AI) in the deep integration of 6G and AI, signifying a shift from a communication network solely providing connectivity services to a new network paradigm that offers a diverse array of services encompassing connectivity, computing power, data, and algorithms. Through this new paradigm, encompassing core networks, access networks, and terminals, the network leverages resources and functionalities, such as connectivity, computation, data, and models, to bolster AI with multiple support capabilities. This enables AI training/inference to be executed more efficiently in real time or enhances data security and privacy protection, among other benefits.

4.1 NET4AI Architecture over 6G

The research on architecturally integrating 6G networks with AI has commenced and is under continuous exploration and development. Both industry and academia have shown immense interest, with preliminary visions of novel concepts and target architectures tailored for the proposed fusion of 6G and AI.

China Mobile has proposed a systematic 6G network architecture design that transcends connectivity in the industry, centered on the core concept of “three layers and six planes” [150]. The “three layers” encompass the Physical Resource Layer, the Network Function Layer, and the Application & Service Layer. At the same time, the “six planes” comprise the Communication Plane, the Data Plane, the Computing Plane, the Intelligence Plane, and the Security Plane. This architecture focuses on multi-dimensional capability elements within the network, aiming to provide comprehensive services throughout the information flow process. China Telecom has proposed a ubiquitous and ultra-converge 6G network architecture, built upon the core concept of “three layers and three sectors” [151]. The “three layers” consist of the Infrastructure Layer, the Network Function Layer, and the Network Operating System Layer. The “three sectors” embody Data Integration, Intelligent Simplicity, and Trustworthiness. This architecture leverages the Intelligent Simplicity sector to integrate the intelligent brain, connections, and

facilities across the three layers, thereby enabling intelligent inclusiveness. China Unicom's vision for future 6G networks is summarized as intelligent, converged, green, and trustworthy, structured vertically into three vertical communication layers of land-based, air-based, and space-based, as well as three horizontal domains of Perception Resource Domain, Function Control Domain, and Service Application Domain [152]. This structure is interconnected through two chains: Intelligent Native and Secure & Trustworthy.

Huawei has unveiled a task-centric AI architecture of 6G networks [153], asserting that 6G networks will introduce new resource dimensions and support the coordination of multi-dimensional resources, enabling 6G networks to natively support AI and achieve a transformation from session-centric to task-centric operations. CICT puts forward the concept of multi-network integration and ubiquitous intelligence, believing that 6G would realize global three-dimensional deep coverage, develop body area networks centered on human beings, form multi-layer coverage with both breadth and depth and learn the ubiquitous intelligence system with multi-network integration [154,155]. ZTE has identified intelligent radio, coverage, and evolution as the fundamental technical characteristics of 6G network architecture. Enabling technologies for 6G will include three-dimensional connectivity, intelligent MIMO, on-demand topology, on-demand AI, and new horizon communications. OPPO indicates that 6G will reshape human interaction and AI, making AI a ubiquitous infrastructure. The 6G system architecture will be coordinated by intelligence, performance, and flexibility, deeply integrating AI capabilities into the user plane, control plane, and function plane [156]. The IMT-2030 (6G) Promotion Group has envisioned the 6G network architecture as an open and innovative platform for information services [157], offering capabilities that transcend mere connectivity. These capabilities encompass computing power networks, trusted security, sensing, data services, and AI-based network intelligent autonomy.

Ericsson is focused on researching cognitive networks and leveraging AI to achieve data-driven security and highly automated network operations [158]. Qualcomm advocates that AI and ML will fundamentally transform the design and deployment of wireless communication and networking systems. As the leader of the EU's 6G project Hexa-X, Nokia states that AI will be the primary driving force behind the technological transformation of the new radio interface for 6G. The company is creating unique AI use cases and scenarios and developing foundational AI technologies [159]. LG Electronics is focused on the research and development of 6G AI technology, anticipating that 6G systems will usher in the era of the "Internet of Everything and Environment" powered by AI. Japan's "Beyond 5G Promotion Strategy" project aims to introduce AI into network management, enabling network autonomy and driving network evolution towards intelligence.

Zhang *et al.* at Beijing University of Posts and Telecommunications (BUPT), put forth a 6G network design philosophy of "Human-Machine-Thing-Spirit", emphasizing the inevitable trend of AI integration in 6G, leveraging cognitive enhancement and decision-making simulation to intelligently define network requirements, ensuring secure and reliable network transmission, and realizing intent-driven networks [160]. Cui *et al.* also from BUPT, designed a fusion of 6G RAN and AI, summarizing its four key characteristics as green, multi-dimensional, stereo, and full-scenario service [161]. You *et al.* at the Purple Mountain Laboratories and Southeast University proposed that 6G will integrate communication, computation, control/caching, and AI to enable full-application scenarios, with 6G networks being inherently secure [162]. Liang *et al.* at the University of Electronic Science and Technology of China (UESTC) demonstrated the vision of integrating 6G and AI and studied implementation examples in wireless communications based on two classic AI algorithms: deep learning and reinforcement learning [163]. Zhang *et al.* at Zhejiang University (ZJU) and Zhejiang Lab explained that AI will become the cornerstone of 6G, and "Intelligent inclusion" will become an essential feature of 6G [164]. The 6G network will be able to provide intelligent services to all types of end users. Tao *et al.* at Shanghai Jiaotong University (SJTU) indicated that the typical technical feature of 6G is the intelligence of the network, which is not only reflected in the network itself being able to self-learn and self-optimize but also being able to provide intelligent services to the outside world [165]. Among them, 6G edge intelligence is expected to become an important research topic. Cui *et al.* at the Chinese University of Hong Kong (Shenzhen) and Shenzhen Research Institute of Big Data pointed out that in the 6G era, networks and AI will be fully integrated, and customized AI services will be provided on the wireless network side [166,167]. Gao *et al.* at Tsinghua University (THU) advocated that AI will be used in wireless communications and change the top-level architecture of wireless networks [168]. At the University of Oslo in Norway, Zhang Yan and his team reported that 6G would enhance its progress in intelligence, especially in edge intelligence [169]. Among them, integrating DT and edge networks will be a promising attempt. At the University of Oulu

in Finland, Taleb and his team initiated the 6G Flagship research program, advocating for realizing context-aware intelligent services and applications for human and non-human users through AI [170].

Incorporating the aforementioned research ideas and architectural visions, the industry has reached a core understanding of the intelligent design of 6G network architectures, emphasizing “distributed structure”, “endogenous intelligence”, and “integrated simplicity”. Based on this consensus, future networks will evolve into advanced, integrated platforms that surpass mere communication connectivity services, offering multi-dimensional services and corresponding network capabilities beyond communication. Generally speaking, the consensus suggests that 6G networks are expected to provide communication connectivity, data and services, computing and services, security and services, AI and services, and management and orchestration capabilities and services. Furthermore, they will cater to diverse businesses by offering end-to-end lifecycle management services throughout their entire process. These consensuses are illustrated in Figure 15.

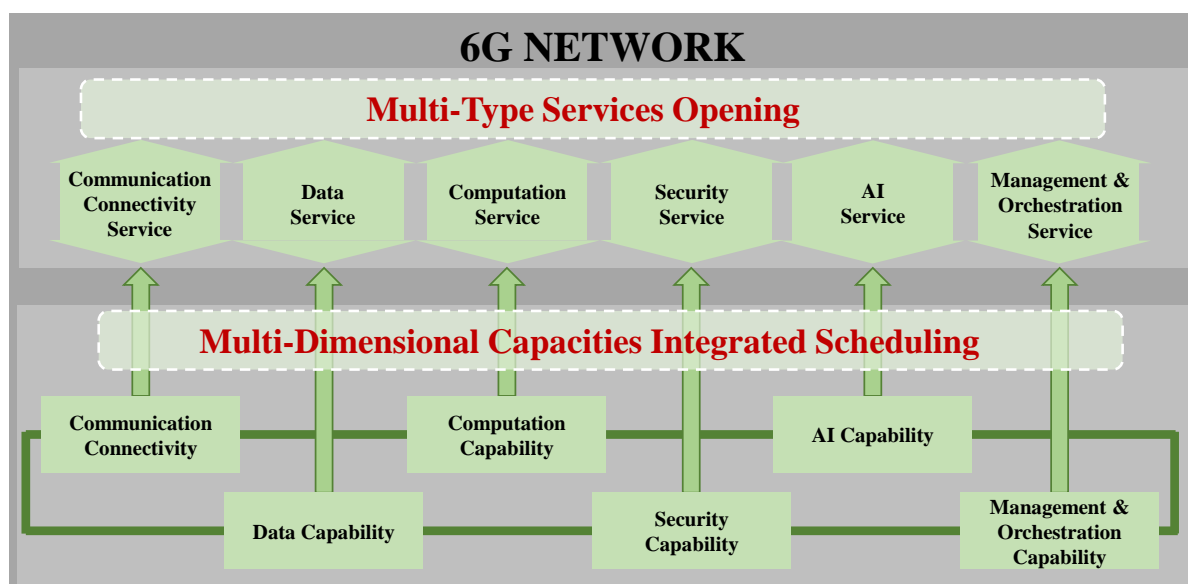

Figure 15 Logical consensus of 6G network. Based on current research, we can conclude that the 6G system will inherently possess six network capabilities encompassing communication connectivity, data, computation, security, AI, and management & orchestration. We will offer six fundamental service categories that evolve from these capabilities. In the 6G era, any business or scenario can be disaggregated into demands and combinations of these basic services, with the network capable of synergistically and dynamically scheduling multi-dimensional capabilities on demand, thereby supporting all scenarios and businesses. For instance, the autonomous driving business can be decomposed into a combination of six basic services: communication connectivity (data and model transmission between vehicles and vehicles/BSs/servers), data (storage and scheduling of vehicle driving data), computation (data preprocessing and model gradient optimization), security (transmission security, data security, and model security), AI (model training and model aggregation), and management & orchestration (cooperative transmission/computation/training). These services are realized through the corresponding six capabilities provided by the 6G network.

• **Communication Connectivity Capability:** In 6G, the Control Plane (CP) and User Plane (UP) within the communication layer will undergo further enhancement designs to deepen the service orientation and openness of network functions to address the complex and diverse business scenarios and emerging demands of the future.

(1) *Enhanced CP:* Within the CP, 6G necessitates enhancing and optimizing the service management and interfaces of existing CP functions to reduce the complexity of network function and signaling interaction processes. Additionally, 6G will extend the traditional CP by integrating space-terrestrial ubiquitous access control management, enabling new functionalities and service-oriented offerings for session management and policy control across communication, computing, data, and other essential elements.

(2) *Enhanced UP:* The enhancement of the UP focuses on augmenting or introducing new, more generalized, and flexible UP forwarding protocols that can perform agile service forwarding and processing based on communication, computing, and other elements. Leveraging microservice technologies and next-generation hardware support, e.g., high-performance programmable chips, cloud-native technologies, and the P4 (Programming Protocol-Independent Packet Processors) advanced language, UP functions will be restructured into service-oriented modules. This flexible invocation and efficient collaboration among

functional modules will break the constraints of traditional layered protocols, enhancing data forwarding efficiency and bandwidth utilization.

- **Data Capability:** The traditional UP architecture struggles to support distributed management and efficient utilization in response to the diverse and highly time-sensitive requirements of sensory data, AI data, network behavior, status data, and other forms. Consequently, 6G networks necessitate a novel data capability that differs from traditional UPs. This capability must adhere to data regulation and supervision requirements while enhancing data analysis and processing efficiency, addressing data management challenges, and enabling value realization.

The data capability supports the realization of information collection, cleaning, storage, and more, enabling the complete lifecycle management of data service processes while ensuring data privacy and security. By leveraging a hybrid data processing and storage model that combines centralized and distributed approaches, the 6G network can flexibly address diverse scenario requirements: 1) For sensitive or high-privacy-level data, local processing and storage can be performed at the RAN/TN/CN and terminal sides to ensure no data leakage; 2) Global and comprehensively analyzed data, on the other hand, is processed and stored centrally in the data center, which also assumes the responsibilities of global data orchestration and access authentication, achieving efficient data organization and collaboration. Through tight cooperation between the central data center and edge nodes, 6G can efficiently manage massive amounts of data originating from various technological and business domains while safeguarding privacy, thereby facilitating the development of data applications and services.

- **Computation Capability:** The 6G computation capability will encompass functionalities such as computational sensing, control, and execution. Among them, the computational sensing function gathers information on the ubiquitous computing power resources distributed across the spectrum from central clouds to terminals. The computational control function, tailored to computing service demands, provides pervasive computing power control and scheduling strategies. The computational execution function, based on these scheduling strategies, offers services like session management, traffic control, and policy execution. Additionally, computational capability needs to synergize with communication connectivity to optimize the efficiency and overall energy consumption of emerging services like AI. Furthermore, introducing computational capability involves the creation of a unified environment enabling continuous computing service operations across terminals, edges, networks, and clouds. This allows the selection of optimal computing nodes for computational tasks based on latency, bandwidth, computing power, and energy efficiency requirements, seamlessly transitioning between terminals, networks, edge nodes, and clouds.

- **Security Capability:** Traditional security measures have struggled to meet the complex and ever-changing security demands of 6G. Currently, the design of security mechanisms stands independently from the network architecture, leaving room for improvement in both security and efficiency. Hence, 6G networks necessitate establishing an inherently trustworthy and self-driving security system at the core of the system. The rapid advancements in cloud computing, big data, and AI technologies offer technical support for constructing a 6G network security system. The 6G security system will be structured around three key components: security capabilities, security controls, and security decision-making. The security capability layer deploys security resources (including physical security resources and pooled security capabilities) on demand, enabling flexible scheduling. The security control layer oversees the scheduling of security resources and orchestrates trust and security collaborations. Meanwhile, the security decision-making layer integrates AI analytics capabilities with DT networks to facilitate intelligent security analysis, simulation, and the integration and delivery of security service capabilities. Based on this architecture, 6G networks will foster a trustworthy and inherently secure system characterized by intelligent proactive defense, ubiquitous intelligent collaboration, and robust privacy protection.

- **AI Capability:** Aligned with the trend of network intelligence evolution, the 6G network architecture will support ubiquitous and inclusive AI capabilities. This necessitates a breakthrough from the external or patch-based intelligence of 5G, transforming intelligence into an inherent network ability. Consequently, the AI capabilities in 6G networks refer to those that cater to the network's operation and maintenance and provide AI services to users or externally. By endogenously constructing AI elements (e.g., computing power, algorithms, data, etc.) and under centralized intelligent orchestration, management, control, and distributed intelligent execution, 6G enables the on-demand customization of AI services.

The network side will provide lifecycle management functions for AI models and data, encompassing capabilities such as AI data management (e.g., training data reporting, gradient reporting), AI model management (e.g., model generation, storage, selection, distribution, updating, replacement, acti-

vation/deactivation, and performance monitoring), and AI computing power allocation (e.g., for training and inference execution).

• **Management & Orchestration Capability:** The immense logical structure and technological ecosystem complicate network operation and maintenance management, necessitating high network autonomy in 6G networks. Consequently, there is an urgent need for management and orchestration capabilities to uniformly and dynamically orchestrate and schedule various functional components based on business requirements, enabling self-optimization, self-evolution, and self-healing of the network. The 6G system will introduce external applications and service demands while exposing internal diversified resources and functions. This requires flexible cross-functional flow and scheduling of multi-dimensional resources, such as computing, communication, and storage within the network, offering customized and personalized application services based on virtualization and microservice technologies. For instance, AI capabilities and analyzed data within the network can be opened to third parties to provide services and necessary support, a crowdsourcing behavior that necessitates the support of management and orchestration functions. Furthermore, through joint analysis and prediction of computing resources and network traffic, containerized gNBs can automatically scale up or down based on predicted network traffic loads, enabling dynamic resource allocation and network energy savings. Therefore, management and orchestration capabilities are closely related to all other capabilities, orchestrating and managing resources and functions efficiently and flexibly across all functional layers of the 6G network, achieving joint optimization.

Within the consensus of the 6G network architecture, communication connectivity is responsible for establishing end-to-end communication links and providing precise and highly reliable connectivity services. The data capability oversees data collection, cleansing, processing, and storage within the end-to-end network, offering data subscription and update services to other planes. The computation capability is tasked with scheduling and optimizing various computational resources within the network to handle computational tasks. The security capability provides inherent security support for the entire network, offering security services to customers while opening up security capabilities to external partners or facilitating crowdsourcing of external security capabilities. The AI capability provides an AI engine that, in conjunction with functional requirements across various domains within the network, offers big data analytics, AI algorithms, model training services, and simulation verification of related solutions. AI capabilities can be centralized or distributed in network elements and terminals to support real-time AI applications or in the cloud, leveraging vast cloud data for complex algorithm implementations. Additionally, the network's AI capabilities can be opened to the outside world, while external AI capabilities can be introduced into the network, enabling the crowdsourcing of AI capabilities. The management & orchestration capability is responsible for scheduling various capabilities within the network to achieve flexible organization, fulfilling the orchestration and management of different resources and functions to meet users' personalized service demands.

Drawing upon the aforementioned consensus on network capabilities in 6G, we further elaborate on the NET4AI architecture, i.e., the support provided by the other five capabilities/services in the network (i.e., communication connectivity, data, computation, security, and management & orchestration) for the AI capabilities/services, with an emphasis on their connectivity with the AI, as illustrated in Figure 16.

4.1.1 Connection for AI

For emerging services like AI, the current network's support in communication is yet to be clarified, necessitating enhanced design to ensure that future 6G networks can better meet the new demands of AI services from a connectivity perspective. Based on the types of AI service-related data carried by communication connections and the principle of control and user plane separation [161], the data can be naturally categorized into two major groups: AI signaling and AI data. Consequently, connection for AI embodies providing connectivity support for AI signaling and data.

• **AI Signaling:** 1) The AI Signaling is used for transmitting AI-related control messages, e.g., AI service request/response messages; request/response messages related to computing power required for AI analysis, etc. 2) For the transmission of AI analysis information, including intermediate analysis information (when multiple entities perform joint analysis).

• **AI Data:** 1) The AI data is used to transfer AI input data, generally referred to as input vectors for invoking an AI model or represented as inputs in an AI algorithm. 2) It is also used for transmitting AI outputs, generally called the output of the invoked AI model/algorithm. 3) It can be further used for

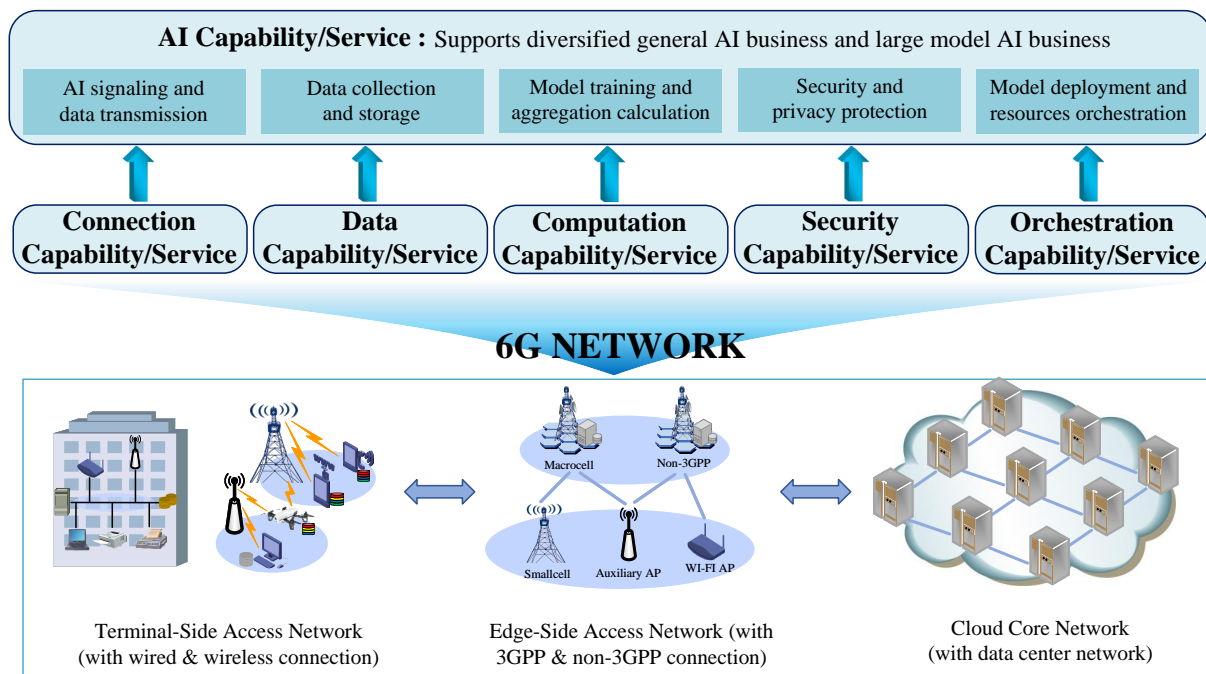

Figure 16 Architecture diagram of NET4AI. The 6G network physically comprises three entity networks: the cloud core network (including centralized data/computation centers), the edge-side access network (including 3GPP and non-3GPP connection methods), and the terminal-side access network (including wired and wireless connection methods), as depicted in the lower half of the figure. NET4AI represents the mapping and supporting role of communication connectivity, data, computing, security, and management orchestration within AI, among the six capabilities and services (i.e., communication connectivity, data, computation, security, AI, and management & orchestration) abstracted from the 6G network’s functional services, as indicated by the arrows in the upper half of the figure.

transmitting AI models, e.g., transmitting a neural network model usually means transmitting its parameter weights (which can be represented as vectors) and its network structure (which can be represented as scalars).

For AI business scenarios and related connectivity performance requirements, 3GPP TS 22.261 (based on the conclusions of TR 22.874) also has some KPI requirement level analysis and results for 5G systems, mainly on the impact of traditional connectivity performance metrics, such as throughput, latency, reliability, etc., i.e., the current 3GPP standard only analyzes the impact of the 5G system (mainly the core network portion) in terms of how it supports different AI services/applications from the functional and performance perspectives. From an overall end-to-end process analysis perspective, AI signaling and AI data involved in AI services/applications necessitate transmission via the air interface. However, in the current standards and architectures, no relevant modules guide the transmission process or standardize the transmission content. As a result, AI services, as an emerging service type under the vision of intelligence embedded, inherently demand that the network provide better support for AI based on connection.

4.1.2 Data for AI

Future mobile communication networks will continuously generate massive amounts of data with diverse types, and data is precisely one of the core production factors for AI, providing a solid data foundation for 6G’s endogenous intelligent AI services [171]. Leveraging this vast array of multi-category, multi-modal data to support a broad spectrum of AI services realizes the vision of 6G’s “ubiquitous intelligence”. Consequently, data for AI aims to efficiently support end-to-end data collection, transmission, storage, and sharing, addressing how to facilitate, expedite, and securely provide data to AI functions within or external to the 6G network. This endeavor strives to reduce the difficulty in data acquisition, enhance data service efficiency, and facilitate the realization of 6G AI while adhering to privacy and security laws and regulations. Depending on the potential functional scope, the data support provided by data for AI should encompass five components:

- **Data Collection/Distribution.** This component provides a basic publish-subscribe mechanism for

data producers and consumers, enhancing data collection/distribution efficiency and supplying samples for large-scale training required by AI models to achieve optimal results.

- **Data Security and Privacy.** This component leverages security and privacy protection technologies to provide high-quality, trusted data services tailored to user and network needs, ensuring user and network privacy protection and data security, immutability, and traceability. By safeguarding data privacy, it also protects the security of AI models during training and data transmission.

- **Data Analysis.** This component utilizes AI models, algorithms, and knowledge to provide statistical information, predictive insights, network anomaly analysis, and optimization suggestions, enhancing the data consumption experience for internal and external network functions and related intelligent applications.

- **Data Preprocessing.** This component applies generic tools for format conversion, noise reduction, feature extraction, and other preprocessing tasks to collected data, fulfilling AI model training requirements for input data and facilitating the management of multi-dimensional complex data.

- **Data Storage.** This component stores and retrieves collected data, providing storage support for data services related to data security and privacy, data analysis, or data preprocessing, and further establishing a data foundation to support AI services.

Through standardized data service functions, a complete data service process can be established within the 6G network, providing a robust foundation for AI at the data level.

4.1.3 Computation for AI

Computation is one of the core production factors of AI. In future network architectures, computational power will be ubiquitous across various infrastructures, including central clouds, edge clouds, network devices, and even end-user devices, providing a solid computational foundation for the diversification of AI services across all industries in 6G [172,173]. This computational power, along with the AI algorithms or functionalities attached, serves the network or devices to improve performance and optimize network operations but is also potentially exploited through unified interfaces to serve upper-layer applications. Consequently, computation for AI focuses on how the widely available computational power in the network can support AI services. This computational power can be broadly categorized into three types: dedicated computing power for network elements, distributed external computing power, and endogenous computing power within the network.

- **Network Element Dedicated Computing Power (for AI):** This type of computing power typically consists of computing and storage units composed of specialized processors and programmable devices. It serves network elements in mobile communication networks (BSs or core networks). It is primarily used for customized AI application services (i.e., AI4NET) to enhance communication performance or optimize network operations, like CSI feedback, channel estimation, and beamforming. Due to resource restrictions, it cannot support AI services and applications requiring large-scale computations and training. It is challenging to implement for third-party applications.

- **Distributed External Computing Power (for AI):** This type of computing power typically exists in the form of distributed Edge Computing / Multi-access Edge Computing (MEC), primarily utilizing general-purpose CPUs and potentially including high-performance GPUs and programmable acceleration cards. External computing power shifts computations from centralized data centers to the edge of the access network, enabling network optimization and supporting industry applications with high computational demands and stringent latency requirements, such as video acceleration and AR/VR scenarios. Due to its external nature, it requires management through unified network functions, introducing some latency that may impact extremely latency-sensitive AI services and applications. Moreover, this external overlay approach may not optimize resource utilization, hindering efficient construction, deployment, and usage of AI services.

- **Distributed Network-Native Computing Power (for AI):** In the vision of future networks, each network element will possess control, forwarding, and computing capabilities, with numerous computing nodes deployed throughout the network. This computational power, known as endogenous computing power, promotes the development and deployment of endogenous AI, enabling large-scale intelligent distributed collaborative services. It compensates for the shortcomings of external computing power, promptly responding to changes in mobility and networks while fostering the emergence and development of future AI applications, such as immersive cloud XR, holographic communication, sensory interconnection, communication-sensing integration, and DT.

Through the construction of multi-category computational power, 6G networks will provide abundant computing services, supporting diversified AI services and accelerating the training process of AI models.

4.1.4 *Security for AI*

Some security vulnerabilities remained after the design of 2G-5G systems, and traditional security measures often failed to ensure safety. In recent years, trusted endogenous security has emerged as a new security approach for 6G, characterized by four main features: collaboration, intelligent proactive defense, trustworthiness, and privacy protection. The concept of trusted endogenous security also applies to ensuring the security of the AI plane.

- ***Ubiquitous Collaboration:*** Collaboration has become a technological approach to enhancing communication capabilities. Intelligent ubiquitous collaboration will enable NET4AI to adapt to various complex and dynamic environments and scenarios while improving the robustness of the AI plane to identify potential malicious attacks or abnormal behaviors accurately. Future security defenses will shift from isolated to highly efficient collaboration, achieving individual collaborative defenses between entities or intelligent agents, inter-layer defenses between protocol layers or architecture layers, and inter-domain defenses between network space domains.

- ***Intelligent Active Defense:*** The rapid development of 6G networks and AI technology presents opportunities for intelligent security defenses. The intelligent, proactive defense will enable NET4AI to continuously learn and adapt while automatically adjusting defense strategies based on changes in the network environment and AI security threats to counteract attacks promptly. This transition represents a shift from passive protection to proactive sensing and defense [174].

- ***Trustworthiness:*** 6G will further evolve towards trustworthiness capabilities, achieving a comprehensive endogenous security system encompassing Security (i.e., confidentiality, integrity, availability, CIA), Reliability, Resilience, and Safety [175]. This can provide a trusted ecosystem for NET4AI. Furthermore, flexible and reliable access control [176] and effective identity authentication [177] can, to some extent, prevent unauthorized access from impacting the endogenous trusted environment of NET4AI.

- ***Privacy Protection:*** The deep integration of AI, big data, and 6G networks will exacerbate the challenges of data privacy protection. NET4AI must handle massive business and personal data while preventing privacy leakage. Emerging distributed machine learning, while achieving distributed ubiquitous intelligence and partially avoiding privacy leakage caused by AI model training, still has security risks [178]. Therefore, NET4AI will integrate distributed machine learning with existing privacy protection methods at multiple points to enhance data privacy protection and build an efficient and secure data ecosystem.

4.1.5 *Orchestration for AI*

Orchestration for AI of the intelligence plane signifies efficient support for deploying, operating, and optimizing AI services within the network through orchestration. It automatically configures and orchestrates network resources based on the specific requirements of AI services, ensuring that AI applications obtain the necessary computational power, storage, network bandwidth, and other resources. Additionally, this orchestration capability enables real-time monitoring of AI service performance, dynamically adjusting resource allocation to accommodate fluctuations in service loads, thereby guaranteeing the stability and efficiency of AI services [179]. This seamless integration and support facilitates smoother AI service operation within the network, providing robust network guarantees for various intelligent applications. Specifically, this manifests in the following three aspects:

- ***Automated Deployment and Resource Allocation:*** The orchestration capability swiftly responds to AI services' network resource demands through automation. Upon AI service deployment, the orchestrator intelligently analyzes the current network resource utilization, automatically configuring network devices, establishing links, and deploying services. This automated process enhances deployment efficiency, mitigates human errors, and ensures rapid AI service launch and stable operation.

- ***Dynamic Optimization and Elastic Scaling:*** As AI services operate, their resource requirements may fluctuate. The orchestration capability features dynamic optimization and continuous monitoring of AI service performance, including CPU usage, memory consumption, network bandwidth, and other key metrics. Upon detecting resource shortages or surpluses, the orchestration system automatically adjusts resource allocation, such as adding compute nodes, expanding storage capacity, or optimizing network bandwidth, to meet AI services' dynamic demands. Furthermore, the orchestration system supports

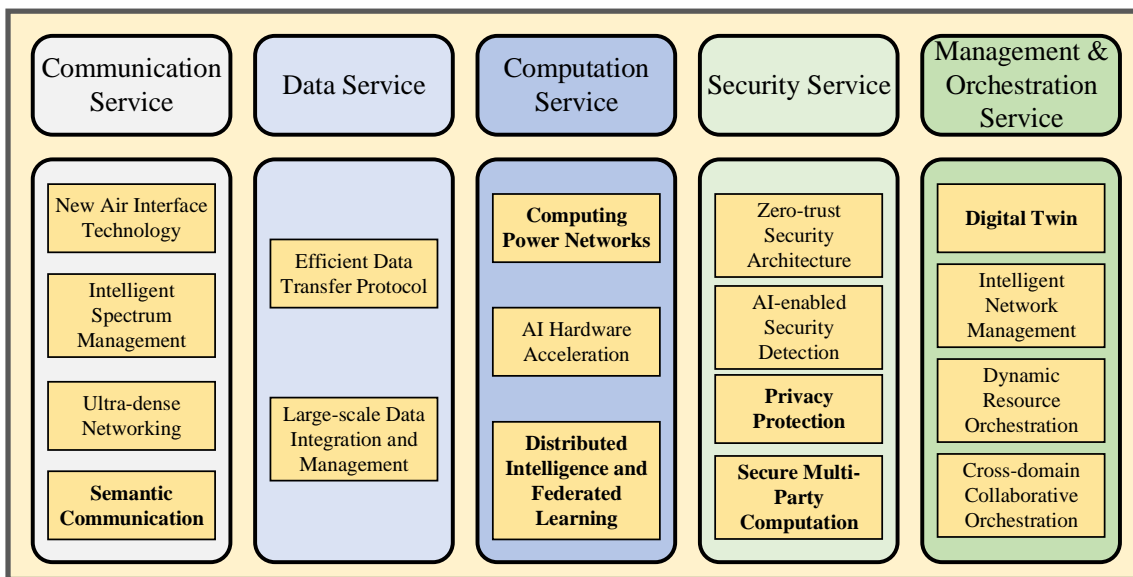

Figure 17 Net4AI Enabling Technology

elastic scaling, automatically resizing resources based on AI service loads, ensuring service stability and efficiency.

•**Fault Self-Healing and Intelligent Operations and Maintenance (O&M):** By integrating monitoring, alerting, and troubleshooting functions, the orchestrator promptly identifies and locates faults within the network, automatically triggering recovery mechanisms. This fault self-healing capability minimizes service disruptions for AI services, enhancing service availability and reliability. Additionally, the orchestration facilitates intelligent network O&M, empowering network administrators to manage network resources and AI services more efficiently, reducing O&M costs, and improving efficiency.

4.2 Key Enabling Technologies

This section describes the key enabling technologies for Net4AI. We compile the key enabling technologies for five planes in 6G networks and present them in Figure 17. In the following, we focus on enabling technologies closely related to the needs of AI, introducing their research background, research significance, and research status.

4.2.1 Distributed Intelligence and Federated Learning

The NET4AI architecture must support low-latency, high-reliability communication computing requirements and increasing privacy concerns. Distributed intelligence and federated learning (FL) are the key technologies that can solve this problem. Traditional centralized architectures in wireless networks can no longer meet low-latency, high-reliability communication and computation demands. Additionally, conventional centralized architectures are inefficient in supporting the ubiquitous intelligence required by future wireless networks. This trend towards deploying intelligent decentralized elements has become apparent, with intelligence gradually shifting from centralized to distributed systems. Therefore, introducing distributed intelligent computing architectures is necessary to fully utilize the multi-dimensional data and computing resources held by user terminals and nodes, enabling intelligent connectivity.

Wireless distributed intelligence refers to organizing AI tasks in a distributed manner within wireless networks, incorporating collaborative AI and machine learning without uploading all raw data to a central cloud. This approach alleviates the network bandwidth pressure and reduces the central cloud's computational burden. Moreover, as the computing power of smartphones and IoT devices increases and users become more concerned about data privacy, mobile devices can handle more AI computations and training. This proximity of AI to users and data allows for faster iteration and upgrade cycles, efficiently supporting the pervasive intrinsic intelligence of 6G networks.

Distributed intelligence is a key technology for achieving the intrinsic intelligence of 6G networks. It adopts a decentralized architecture, dispersing network functions and resources across multiple nodes or devices, eliminating the dependence on a single central node to control the entire network. Nodes in a distributed network possess a certain degree of autonomy, enabling them to make decisions and execute tasks independently without frequent communication or coordination with other nodes. This autonomy enhances network flexibility, allowing it to better adapt to various environmental and demand changes. Data is typically stored across multiple nodes in a distributed network, and computational tasks can be distributed among these nodes for processing. This distributed data storage and processing method improves network scalability, accelerates the training and inference processes of large-scale models, and enhances the efficiency of AI systems. Distributed intelligence also supports online learning and continuous optimization by collecting and processing data in real-time, continuously updating models, and improving AI system performance and accuracy. By leveraging the potential of large-scale distributed edge devices, distributed AI technology can overcome the bottlenecks of centralized AI, reduce communication costs, and address data privacy concerns. Distributed AI and swarm intelligence will build a new intelligent ecosystem for 6G. As shown in Figure 18, the wireless distributed intelligence architectures widely recognized in academia and industry include :

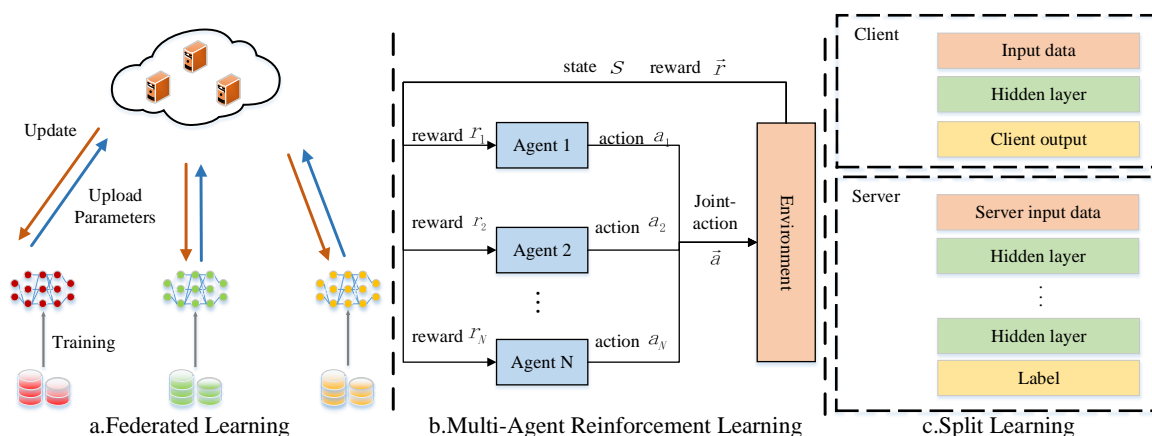

Figure 18 FL, Multi-Agent Reinforcement Learning and Split Learning

- **Horizontal FL:** Also known as sample-based FL, this can be applied in scenarios where the datasets of the various participants in FL have the same feature space but different sample spaces. Horizontal FL enhances privacy by training AI models on local devices and sharing only model parameters rather than raw data. Each node trains the model locally during training and periodically uploads model weights. The central node integrates these weights to form federated model weights, which are then sent back to the nodes for the next training cycle or local inference. FL ensures that user data remains local, transmitting only weights/gradients to achieve global training, thereby enhancing privacy.

Through horizontal federation learning, different participants can jointly train a more powerful AI model based on local data sets while protecting privacy and improving the accuracy and generalization of the model. Additionally, horizontal FL enables real-time learning on distributed edge devices, allowing for timely model parameter updates to constantly changing environments and data. This is crucial for AI applications that require quick responsiveness and strong adaptability. It also supports collaboration across devices with varying computational capabilities and data distributions, catering to the diverse needs of 6G network terminals. Personalized model training on local devices enhances user experience by offering more individualized services.

The main application areas of horizontal FL include smart healthcare, personalized services, and intelligent manufacturing [180]. The authors of [181] provide the framework for an advanced blockchain-orchestrated machine learning system for privacy-preserving FL in medicine and a new utility in health. The authors of [182] combined blockchain and FL to accelerate AI model training in healthcare and improve model robustness. The authors of [183] introduced personalized FL (PFL) methods with theoretical performance derivations, modeling user personalization and data distribution. The authors of [184]

categorized PFL techniques based on key challenges and strategies, highlighting critical ideas and future research directions in PFL architecture, realistic benchmarks, and trustworthy methods. The authors of [185] propose a new FL framework for cross-domain prediction for intelligent manufacturing, designed to quickly adapt to new products, processes, and applications with limited training data.

- **Vertical FL:** Vertical FL refers to a setup where datasets have different features but share the same samples/users. It is suitable for scenarios where there is a high overlap of users among participants but low or no overlap in feature space by extracting parts where participants have the same users but not the same features for joint training. In the training process, it is first necessary to sample align each participant's data to obtain overlapping user data, then train the model locally and upload the parameters to the server [186]. The difference between vertical and horizontal FL is that horizontal FL emphasizes cooperation and sharing between different data sources. In contrast, vertical FL focuses on collaboration and sharing within varying levels of the same data source.

Vertical FL can leverage the correlation between different levels of data sources to achieve data augmentation. By sharing model parameters, various data sources can complement and enrich each other's data, improving AI models' generalization ability and robustness. Furthermore, vertical FL can facilitate cross-level learning and knowledge transfer. Different data sources can share model parameters and learning experiences, achieving cross-level knowledge transfer and migration and enhancing the overall model's effectiveness.

The main application areas of vertical FL include recommendation systems, smart healthcare, and smart transportation. The authors of [187] propose a method based on clustering and latent factor models under the vertical federated recommendation system. Considering the diversity of a large number of different users in each participant, users are clustered to reduce the dimension of the matrix and improve the accuracy of user recommendations. The authors of [188] describe the idea of Intention-Hiding Vertical FL and illustrate a framework to achieve this privacy-preserving goal. The authors of [189] propose a Federated Deep Learning based on the Spatial-Temporal Long and Short-Term Networks algorithm to predict traffic flow by utilizing observed historical traffic data. An additive homomorphic encryption method based on vertical FL trains local TFP models and shares short-term spatio-temporal hiding information.

- **Multi-Agent Reinforcement Learning:** This branch of reinforcement learning studies the behavior of multiple learning agents coexisting in a shared environment. Each agent pursues its reward and acts to advance its interests. The primary goal is to achieve cooperative and win-win strategy learning among multiple distributed nodes, suitable for multi-agent collaboration or competition scenarios. 6G networks must support diverse AI application scenarios, such as smart cities and intelligent transportation. Multi-agent reinforcement learning (MARL), with its flexible learning and decision-making capabilities, can offer personalized and optimized solutions across various applications. By learning the characteristics of their environment and tasks, agents can autonomously optimize and adjust to meet different application needs, enhancing user experience.

MARL has been widely applied in practice, making progress in smart cities, intelligent transportation, smart manufacturing, personalized services, and unmanned systems. The study in [190] presents, for the first time, a fully scalable and decentralized MARL algorithm for adaptive traffic signal control in complex urban traffic networks. The authors of [191] propose a novel multi-agent recurrent deep deterministic policy gradient algorithm based on a deep deterministic policy gradient (DDPG) algorithm for traffic light control in vehicular networks. The authors of [192] present new cyber-physical integration in smart factories for online scheduling of low-volume-high-mix orders. The authors of [193] propose a novel multi-agent deep reinforcement learning scheme to solve the multichannel access and task offloading problem in MEC-enabled industry 4.0. The authors of [194] first apply deep reinforcement learning to the problem of forming long-term driving strategies. The authors of [195] propose using Partially Observable Markov Games to formulate the connected autonomous driving problems with realistic assumptions.

- **Split Learning:** This technique separates machine learning model architecture between clients and servers, allowing joint model training without disclosing raw data. High-computation tasks are assigned to powerful central nodes, while shallower data processing layers are kept at data-holding terminals. Split learning offers better privacy than FL and reduces the processing load on resource-limited devices. Its applications focus on healthcare, where lightweight devices train intelligent models based on users' private health data [196].

The following are the future research directions of distributed intelligence [197]:

- (1) Future distributed networks will focus more on improving performance and reliability. More effec-

tive error correction and retransmission mechanisms can be adopted to address data loss and errors in unreliable communication environments, such as advanced error-correcting codes and adaptive retransmission strategies, to reduce error rates and enhance communication reliability.

(2) As data breaches and network attacks become more prominent, future distributed networks will prioritize security and privacy protection. Enhanced data encryption, identity authentication, and access control measures will protect user data from unauthorized access and tampering.

4.2.2 Digital Twins for 6G Network native AI

In terms of management and orchestration services, DT is a key enabling technology that enables more efficient and accurate allocation of resources and system optimization for AI services. In B5G/6G communication systems, the rapid growth in user demand and the continuous evolution of technical standards have posed significant challenges to resource allocation and system optimization. Traditional communication systems, which rely on historical data and static models, struggle to adapt swiftly to dynamic network changes, making real-time adjustments difficult. These limitations hinder the adaptability, reliability, and flexibility of communication networks. DT technology has been introduced into the communication domain to address these challenges, offering a flexible, efficient, and precise approach to resource optimization. Adopting DT not only enhances system agility and performance but also introduces innovative models for network operation, significantly reducing research and development costs and risks [198]. Figure 19 depicts the relationship between 6G physical infrastructure and DT for AI.

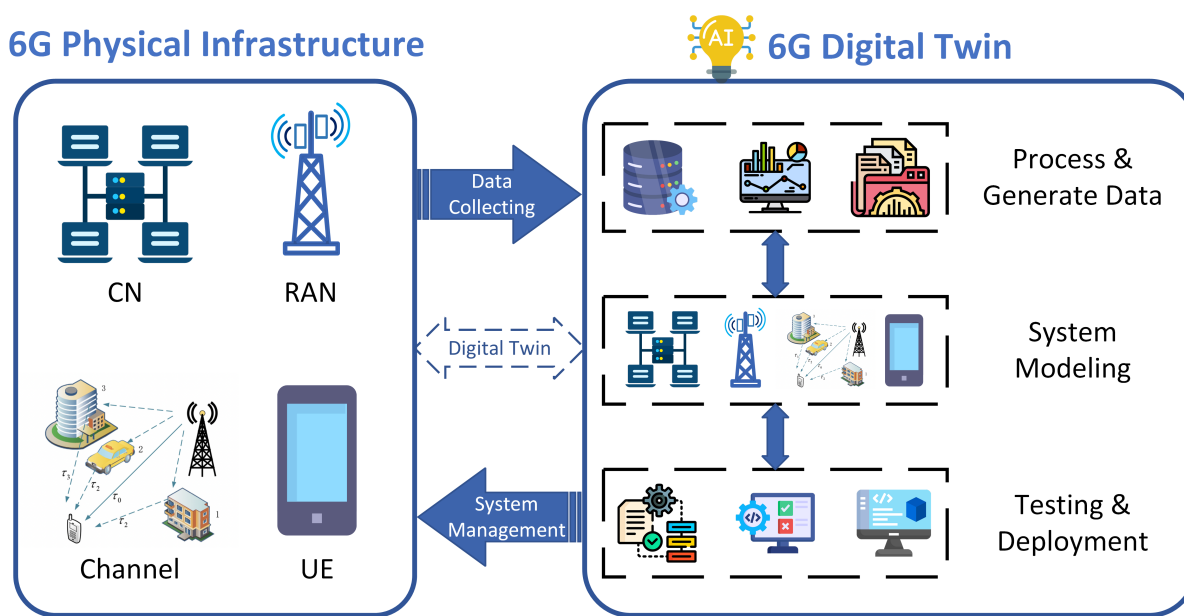

Figure 19 Digital Twin for AI

The concept of the DT was first proposed by Professor Michael Grieves [199]. It represents a technology that leverages sensors, data processing, modeling, and simulation to comprehensively map physical entities' behavior, performance, and state in a virtual environment. By creating a virtual replica of a physical object, DTs establish a bidirectional connection between the physical and digital worlds, enabling real-time reflection of the physical entity's operational state and the simulation of its future behavior. The primary objective of DT technology is to enable comprehensive monitoring, prediction, and optimization of physical entities through digitalization and intelligence, thereby enhancing system reliability, flexibility, and performance. In 6G communication systems, DT technology facilitates the construction of comprehensive network digital replicas to monitor network devices in real time, predict network states, and optimize resource allocation [200]. This holistic digital mapping transforms network operations from static planning to dynamic responsiveness.

The implementation of DT technology relies on the synergy of several key technologies, including high-precision data collection, real-time modeling and simulation, bidirectional data interaction, and intelligent analysis and optimization. In communication systems, distributed sensor networks continuously gather

diverse data from physical entities, such as network device statuses, traffic dynamics, environmental parameters, and user behavior patterns. This data is transmitted to the DT platform via high-speed, low-latency communication links.

The DT platform employs physical models and data-driven machine learning algorithms to construct high-fidelity virtual replicas that comprehensively simulate physical entities' operational state and dynamic changes. These virtual replicas accurately reflect the current state and leverage simulation techniques to predict future system behaviors or potential anomalies. With bidirectional data interaction, physical systems and virtual replicas achieve real-time data synchronization. The DT analyzes large-scale data intelligently, generates optimized decisions, and swiftly relays these to the physical system. For instance, when a network traffic surge is anticipated, the DT can proactively adjust load distribution strategies, optimize spectrum and power resources, and alleviate stress on network devices.

The integration of edge computing further enhances the efficiency of this technology by distributing modeling, simulation, and optimization tasks to edge nodes closer to physical entities. This setup ensures processing speed and responsiveness meet ultra-low latency requirements. Through the seamless integration of these advanced technologies, DT enables intelligent management and dynamic optimization of complex networks in 6G communication systems, providing robust support for efficient resource utilization, network stability, and intelligent upgrades [201].

The 6G network aims to achieve ultra-high capacity, ultra-short-range communication, beyond-best-effort and high-precision communication, and integrate multiple communication types [202]. However, this ambitious vision introduces security, spectrum efficiency, intelligence, energy efficiency, and affordability challenges. The emergence of DT technology offers promising opportunities to address these challenges. DT provides a virtualized counterpart for 6G networks, enabling comprehensive network traffic monitoring and analysis. By collecting traffic data across the entire network, DT utilizes data analytics to proactively uncover traffic patterns and detect anomalies. Leveraging feedback from the virtualized network, 6G systems can enhance their security by preparing for potential threats in advance. Additionally, DT enables the automation of demand identification and service provisioning by analyzing communication data to discern usage patterns and rules. Predictive insights into communication demands allow 6G networks to reserve resources, such as spectrum, in anticipation of future needs. Moreover, the integration of DT technology empowers 6G to support innovative services, including augmented reality (AR), virtual reality (VR), and autonomous driving. By addressing key challenges in security, spectrum efficiency, intelligence, energy efficiency, and customization, DT technology redefines and accelerates the development of 6G networks [203].

Significant research has integrated DT technology with 6G networks to enhance network performance. For instance, DT has been proposed for managing metasurface reflectors in 6G terahertz communications [204]. By modeling, predicting, and controlling the propagation characteristics of indoor signals, DT maximizes the system's terahertz signal-to-noise ratio (SNR). Additionally, Lu et al. introduced the concept of DT Wireless Networks (DTWN) by integrating DT into wireless networks. This approach shifts real-time data processing and computation to the edge plane and leverages DT to mitigate the unreliability of long-distance communications between end users and edge servers in 6G networks [205]. Overall, the deep integration of DT with 6G effectively bridges physical systems and digital spaces, providing robust technical support for efficient and reliable wireless communication.

One of the critical capabilities of 6G networks will be supporting massive-scale terminal devices that generate extensive data traffic. In this context, DT can optimize edge resources to meet user demands better. For example, the authors of [206] designed a DT model for edge computing in 6G wireless networks. By incorporating mobile users' dynamic network state and DT, the study addressed edge association problems using deep reinforcement learning and transfer learning, successfully reducing average system latency and improving resource utilization. Similarly, the authors of [207] proposed a DT-assisted task offloading method, creating DTs for all device states to achieve lower latency and power consumption in the network. Furthermore, the authors of [208] investigated dynamic resource allocation mechanisms for DT-based services in the 6G Internet of Things (IoT). The study improved resource allocation efficiency by establishing service function chains with DTs and employing a collective reinforcement learning method.

In addition, Digital Twin Channel (DTC) is also a research direction of DT for 6G Network native AI. DTC is proposed as a digital virtual mapping of a wireless channel that reflects the entire process of channel fading states and variations in the physical world [209]. DTC is envisaged to continually interact with the wireless communications system (WCS) channel requirements to support the system's ability to adapt to complex communication environments actively. It can be applied in various typical 6G usage

scenarios, offering significant performance enhancements in data rate, latency, spectral efficiency, energy efficiency, and link reliability [210]. To boost the capabilities of the DTC for the predictive 6G network, a novel DTC implementation platform is proposed, including data acquisition, environment sensing and reconstruction module to build the relationship between environment and channel for channel prediction, communication decision and interaction [211,212]. A cluster-nuclei (CN) based channel model is proposed to analyze the mapping relationship between clusters and scatterers in the propagation environment, enabling channel reconstruction across various scenarios [213]. In addition, a radio environment knowledge pool (REKP) is proposed to serve as a specific enabler for DTC. Based on the principles of REKP, the electromagnetic wave property inspired radio environment knowledge (REK) construction method is proposed, which fills the gap in the interpretable mathematical representation of the relationship between adequate environment information and channel [214].

The ITU documentation defines the requirements and architecture of DT Networks (DTNs), emphasizing their core role as virtual representations of physical networks. By leveraging data collection, real-time interaction mapping, unified data models, and standardized interfaces, DTNs enable physical network analysis, diagnosis, simulation, and control. The ITU proposal introduces a "three-layer, three-domain, double closed-loop" architecture design, highlighting applications in complex network operations, optimization, innovation, and security strategy drills. DTNs' functional requirements include data management, modeling, and lifecycle management, while service requirements focus on compatibility, scalability, and privacy, further supporting the intelligent, automated, and secure development of future networks.

DT technology is pivotal in developing 6G systems and various communication domains. By enabling precise modeling and real-time interaction with physical entities, DT provides practical solutions for optimizing resource allocation, enhancing communication security, and improving service management. For instance, DT optimizes computation offloading in industrial IoT in ultra-reliable, low-latency communication links. Integrating DT with blockchain and FL technologies in wireless communication strengthens system security and privacy protection. In the vehicular network domain, DT leverages traffic prediction, edge computing, and load-balancing techniques to enhance real-time data processing and overall system efficiency. DT is driving innovation and development across multiple dimensions of communication systems, demonstrating its transformative potential. The application of DT technology in communication systems is currently experiencing rapid development, showcasing significant potential across various domains, particularly in the research and development of 5G and the emerging 6G networks. In industrial IoT environments, DT technology plays a crucial role. For instance, the authors of [215] address minimizing computation offloading delays in ultra-reliable low-latency communication (URLLC) links by leveraging DT-enabled wireless edge networks. The study focuses on modeling the computational capabilities of edge servers and optimizing system-wide resource allocation.

To enable wireless communication systems based on proactive online learning, the authors of [216] introduce a DT design framework. This framework considers aspects such as twin object access, security and privacy, and air interface design, while also discussing the challenges and opportunities of DT in wireless systems. Additionally, the authors of [217] propose a blockchain-empowered FL framework to enhance communication security and data privacy within DT-enabled edge networks. The study incorporates asynchronous aggregation mechanisms and DT-driven reinforcement learning to optimize user scheduling and spectrum resource allocation.

DT technology has also seen applications in vehicular networks. The authors of [218] present a DT-assisted real-time traffic data prediction method capable of delivering accurate short-term forecasts for traffic flow and speed. The authors of [219] propose an innovative vehicular edge computing network combining DT and multi-agent learning. This approach helps uncover potential matches for edge services among large-scale vehicles, reducing the complexity of service management. Similarly, the authors of [220] introduce a DT-based load-balancing prediction model for autonomous vehicles, which accurately predicts road network conditions while ensuring high data transmission security. Furthermore, the authors of [221] explore the use of DT in vehicular edge computing, developing models that reflect the real-time state of the vehicular environment. The study introduces two metrics, QDT and CDT, to evaluate the quality and cost of DT models for edge nodes, optimizing system performance and reducing costs. These studies highlight DT's transformative potential across communication systems, from resource optimization in industrial IoT to service management and predictive modeling in vehicular networks.

The application of DT technology in communication systems has made initial progress but is still in the exploratory stage. In the future, DT technology needs to improve model construction methods and accuracy further, optimize real-time performance and latency, enhance security and privacy, and reduce

resource consumption and costs. With AI and machine learning technology advancements, DT is expected to provide more intelligent network operation and maintenance solutions, achieving more efficient fault prediction, network optimization, and service quality management.

4.2.3 Computing Power Network and AI

The NET4AI architecture requires powerful computing service capabilities because wireless networks show great interest in computing tasks related to high-performance computing, such as ultra-large-scale data processing and deep learning. The computing power network is a key enabling technology for computing services [222]. It achieves ubiquitous computing interconnection through mutual sense and collaboration between the network and computing resources [223], promotes efficient harmony between cloud, edge and terminal resources, and serves all computing tasks in the network, especially AI-related computing services.

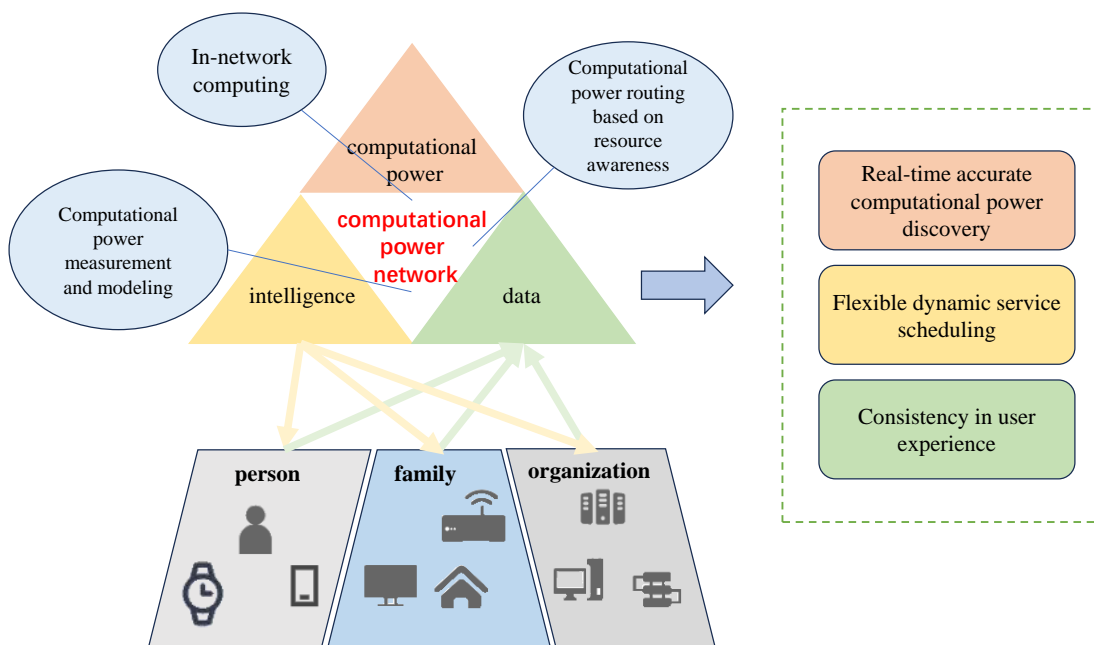

Figure 20 Computing Power Network and AI

The computing power network is a new type of information infrastructure. As shown in Figure 20, it supports computing power discovery, computing power management, task offloading and network computing, and based on this, it builds an Internet network composed of massive data, efficient computing power and ubiquitous intelligence, bringing computing services to every person, family and organization [223, 224]. Essentially, the computing power network is a service for computational resources. Its core idea is to connect geographically distributed computing power center nodes through new network technologies [222], dynamically sense the status of computing power resources in real time, then coordinate the allocation and scheduling of computing tasks, transmit data, and form a network that senses, allocates, and schedules computing power on a global scale. On this basis, computing power, data, and application resources are gathered and shared [225]. The technical principles of the computing power network can be divided into three aspects: 1) Real-time and accurate computing power discovery: Based on real-time network layer sense, computing power information (such as location and operating status) can be collected, whether it is concentrated in the cloud or distributed throughout the wireless network, thereby achieving rapid sense and discovery of computing power and advance routing calculation planning to ensure real-time and accurate provision of computing resources in the service. 2) Flexible and dynamic service scheduling: Dynamically plan and provide on-demand services based on the SLA requirements of the business. Through real-time resource status sense and accurate, flexible, and dynamic scheduling, business traffic can be quickly matched to the optimal node, achieving seamless service switching and delivery and enhancing user experience. 3) Consistency of user experience: The computing power network

realizes the accurate sense and flexible allocation of computing resources between the cloud, edge and terminal devices, ensures a comprehensive and consistent user experience based on collaborative scheduling, and eliminates the need for users to care about the location or deployment status of computing resources within the network.

Currently, the computing power network is widely recognized in both academia and industry and primarily includes:

- **Computational power measurement and modeling:** This is a foundational technology for providing computational power services [223, 226]. In the future, computational power providers in computational power networks will not be confined to a specific data center or computing cluster. They will include ubiquitous computational power from cloud, edge, and end devices. Efficient sharing of this ubiquitous computational power through network connections requires accurate sensing of the computational capacity of these heterogeneous chips, the business types suitable for different chips, and their locations in the network, as well as effective management and supervision.
- **Computational power routing based on resource awareness:** In computational power networks, after measuring and modeling computational resources, the information is encoded and loaded into network control layer packets for sharing [222, 227]. The network control layer makes network decisions based on shared computational resource information, guiding business routing to different computational resource pools or through collaboration between computational resource pools for business processing, thus enabling network awareness of computational resources to guide global routing.
- **In-network computing (INC):** Leveraging the deployment of programmable network technologies, INC processes packets within the network [228]. Sharing INC power using open and programmable heterogeneous resources accelerates data processing close to the source without altering the original business operating mode, reduces application response delays, and simplifies application deployment processes.

In summary, the computing power network provides stable and reliable computing resources for AI, using idle computing power in the network to complete the computing requirements of large-scale AI tasks, improving computing efficiency and reducing costs. Users do not need to build their computing infrastructure, enhancing the accessibility of AI computing and promoting the widespread application and adoption of AI technology. The computing power network integrates distributed computing resources to provide efficient, flexible, and scalable computing power to meet the real-time and environmental requirements of modern computing environments. It supports users to dynamically adjust resource scale according to demand to adapt to AI applications of different scales and complexities [227]. For example, users can request a large amount of idle computing power through the computing power network to support the high computing power requirements in new applications such as virtual reality (XR) and augmented reality (AR).

In addition, the computing power network also can be combined with other novel technologies. For example, by adopting blockchain technology [229], the computing power network can provide AI with a secure and privacy-protected computing environment, ensuring the transparency and traceability of the computing process. The introduction of technologies such as smart contracts can further protect user privacy and data security, allowing users to safely use the computing power provided by the computing power network to process sensitive data and tasks, thereby improving overall security and credibility. The composability of the computing power network gives it a brighter future in 6G networks.

With the explosive growth of data volume in the network and computing requirements becoming increasingly complex, the computing power network has become the focus of attention of many researchers to solve these complex challenges. The authors of [230] implemented a Kubernetes-based prototype testing platform for the computing power network using a microservices architecture, achieving key enabling technologies for the computing power network, including computational modeling, sense, announcement, and offloading. The authors of [231] described a lightweight multi-cluster hierarchical edge resource scheduling scheme based on a cloud-native resource scheduling mechanism, successfully managing and deploying many heterogeneous edge devices within a unified framework using a lightweight cloud-native platform. The authors of [225] proposed an integrated ICT network architecture of “connectivity + computing + intelligence,” integrating network, computing, storage, and applications into a unified design. The network can sense computational resources and perform related management and control. The authors of [232] designed an on-demand compute resource scheduling model and proposed a two-stage evolutionary search scheme. Numerical results indicate that this scheme significantly improves the efficiency and stability of task offloading and compute resource scheduling in edge computing networks. Detailed power analysis

of several INC use cases in [228] showed that INC becomes more energy-efficient at very low processing loads, with increased processing loads having little impact on INC power consumption. The computing power network provides support and empowerment for AI in many ways. In [233], the fog computing network offers powerful computing power support for AI model training, reasoning and other tasks. This helps shorten model training cycles, improve training efficiency, and enable AI models to iterate and optimize faster. The study presented in [234] takes deep neural networks as a typical AI application, and formulates optimization problems under the constraints of energy consumption, delay, computing and communication resources to efficiently utilize computing resources and avoid resource waste.

4.2.4 Secure Multi-Party Computation

The 6G network supports ubiquitous interconnection services. However, this will generate a large amount of user data, posing risks of privacy exposure and unauthorized use during collection, storage, and transmission. Moreover, the 6G network deeply integrates the digital and physical worlds, making social management, economic production, and daily life increasingly reliant on reliable network operations. A large amount of critical data related to social management, financial activities, and personal privacy information will be transmitted and stored through the network. The massive data flow across multiple networks and entities requires a secure, reliable, and trustworthy governance system capable of providing decentralized mechanisms and privacy protection. The 6G network will also be highly complex, heterogeneous, and dynamically changing. Extensive data exchange and collaboration between devices, service providers, and applications will be necessary. While achieving efficient cooperation, the 6G network must also ensure data security.

Network attack methods are becoming increasingly sophisticated as network technology continues to evolve. Traditional security mechanisms are often inadequate to counter these emerging threats. As shown in Figure 21, secure Multi-Party Computation (SMPC) [235] is an encryption protocol that allows multiple parties to compute a function while keeping their input data private jointly. Each party obtains the correct computation result without knowing the other parties' private inputs. SMPC has characteristics such as decentralization, input data security, and accurate computation results. It enables AI to handle complex network environments, protect user privacy and data security, support emerging application scenarios, and promote data sharing and utilization.

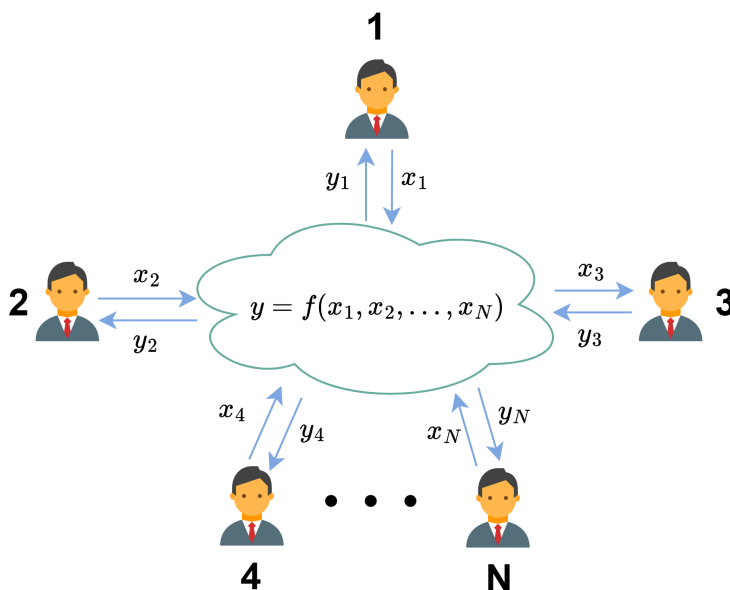

Figure 21 Secure Multi-Party Computation

The leading supporting technologies of SMPC include Garbled Circuits [236], Oblivious Transfer [237], Secret Sharing [238], and Homomorphic Encryption [239].

(1) *Garbled Circuits* This technique involves compiling computational logic into a circuit and encrypting each gate (such as AND, XOR, etc.). Participants can complete the computation by interacting with the encrypted information without knowing the specific logic of the circuit.

(2) *Oblivious Transfer* Oblivious Transfer is a protocol that allows one party (e.g., the sender) to send one of many pieces of information to another (the receiver), where the receiver can choose only one piece of information. The sender does not know which piece of information the receiver has chosen.

(3) *Secret Sharing* This method involves splitting a secret into multiple shares and distributing them to different participants. The original secret can only be reconstructed when sufficient shares are combined.

(4) *Homomorphic Encryption* Homomorphic Encryption is a unique encryption method that allows specific computations (such as addition and multiplication) to be performed on encrypted data. When decrypted, the result of these computations corresponds to the exact computations performed on the original data.

With the development of 6G networks and AI technology, SMPC provides solid guarantees for privacy protection in 6G networks based on the technologies mentioned above. It has been widely applied in privacy-preserving machine learning and other related areas. Recent research has leveraged SMPC for secure FL model aggregation. FL involves training machine learning models on numerous decentralized devices while localizing the training data. This collaborative approach allows multiple parties to train models without exposing their training data. For example, to counter reverse attacks on data, a privacy-preserving data aggregation mechanism based on secret sharing techniques in SMPC can efficiently protect FL against such attacks [240]. To address the issues of high communication overhead and poor scalability in traditional SMPC, a two-phase SMPC-based FL framework has been proposed [241]. This framework enables multiple clients to train AI models while collaboratively protecting their data privacy. To mitigate the high communication costs and poor scalability associated with aggregating global models at only some nodes, a hierarchical FL architecture using SMPC has been developed. This architecture improves communication efficiency and scalability without compromising privacy [242].

To protect the privacy of medical data and ensure it is unaffected by IoT devices, an FL scheme based on homomorphic re-encryption has been proposed [243]. In this scheme, data is collected by IoT devices, encrypted, and uploaded to fog nodes. In coordination with cloud servers, the fog nodes complete the model training. Scholars have combined homomorphic encryption with FL algorithms to protect medical data privacy from the perspective of deep learning model attacks. Using secure multi-party protocols safeguards CNN network models from malicious attacks, thus protecting real medical datasets [244]. Additionally, with encryption technology, the more complex the homomorphic algorithm used, the more training time FL consumes, indicating that the complexity of encryption technology is a significant research factor [245].

In urban computing scenarios, data is often characterized by high volume, high frequency, and asynchronous communication, presenting new challenges for implementing FL. A novel hybrid FL architecture has been proposed, which combines FL with Trusted Execution Environments, SMPC and Beidou satellites. This architecture achieves secure key distribution, encryption, and decryption and provides verification mechanisms for each participant to ensure the security of local data [246]. SMPC can also be combined with blockchain technology to track and mitigate malicious behavior, achieving a secure and trustworthy collaborative edge learning framework [247]. Additionally, in privacy-preserving machine learning, SMPC can identify spam messages [248] and train text classifiers [249].

In general, SMPC enhances the security of AI models during data sharing and collaboration, ensuring data privacy. It can be combined with various AI algorithms or models, offering broad application prospects, flexibility, and scalability.

4.2.5 *Semantic Communication*

Semantic communication can be viewed as a key enabling technology for AI services using wireless communication services due to its higher compression and spectral efficiency, depicted in Figure 22. 6G networks will provide users with immersive, personalized, and all-encompassing services, ultimately achieving the goal of services that adapt to user desires. Under this background, networks are expected to change according to needs. With the emergence and development of new technologies, such as brain-computer interaction, brain-like computing, and semantic perception and recognition, 6G networks will possess semantic perception, recognition, analysis, understanding, and reasoning capabilities. To meet the new demands of 6G applications and services, semantic communication stands out as a paradigm that sends only meanings of semantics, addressing the latest requirements of 6G networks.

6G networks will deeply integrate multi-modal semantic perception and communication, fully utilizing standard semantic information and universal knowledge domains under different conditions, including

users, devices, contexts, scenes, and environments. This integration will automatically perceive, recognize, extract, infer, and transfer the semantics and knowledge contained in transmitted information. This fundamentally solves incompatibility issues and poor interoperability across systems, protocols, networks, and human-machine interactions in traditional data-driven communication protocols, significantly improving communication efficiency, reducing information transmission and understanding delays, minimizing semantic distortion, and enhancing user quality of experience.

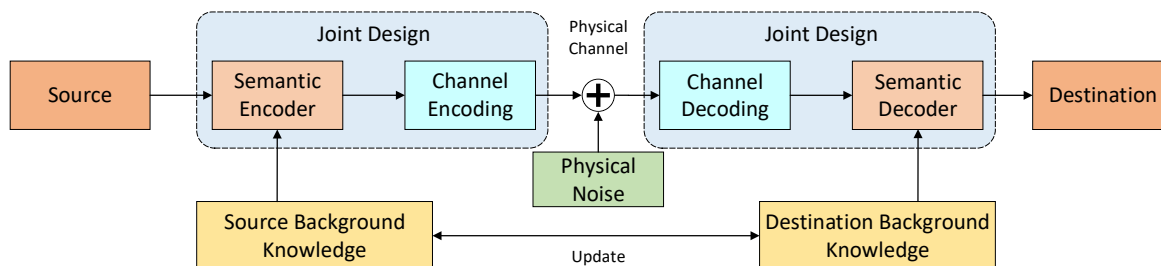

Figure 22 Semantic Communication

Traditional transmission methods focus on the accurate transmission of information symbols (e.g., bits), assuming that the sender and receiver are unintelligent entities, thereby overlooking the relevance and effectiveness of the transmitted contextual information. This results in the transmission of large amounts of redundant data, wasting communication resources such as transmission power and bandwidth. Moreover, acquiring, processing, and sending these vast amounts of redundant real-time data increases computational waste, communication delay, and security issues.

Semantic communication interprets information at the semantic level, transmits meanings, and restores information. Its transmitter can understand and extract semantics from information, while the receiver can receive and understand semantics to recover the data or execute the tasks. In recent years, the unique advantages of semantic communication networks in knowledge sharing and semantic understanding have gained attention in academia and have been applied in various scenarios, including tactile internet, holographic communication, XR, and human-machine symbiotic networks. Semantic communication, using semantics-oriented compression algorithms, can more effectively eliminate redundant information, significantly reducing the amount of data to be transmitted, thus improving communication efficiency and lowering bandwidth requirements. Additionally, semantic communication can understand the data context, preserving essential semantic relationships when transmitting information, thereby aiding downstream AI systems in making more intelligent and accurate decisions. It can also semantically integrate different modalities (e.g., text, images and audio), providing more comprehensive and precise information input and enhancing the collaborative capabilities of AI systems. Additionally, semantic communication offers more robust security through data anonymization, reducing the risk of data breaches.

The authors of [250] provided a pioneering work in semantic information theory, establishing the mathematical framework for semantic information theory, which lays the foundation for semantic communication. The authors of [251] proposed the concept of Modulation Division Multiple Access technology, which efficiently distinguishes users based on semantic features from the information dimension, thereby improving resource utilization in multi-user semantic communication systems, which contributes to multi-user semantic communication systems. Semantic extraction and recovery, also called semantic encoding and decoding, are the core components of semantic transceivers. Four dominant advanced semantic extraction techniques [252]: DL-based semantic extraction, RL-based semantic extraction, KB-assisted semantic extraction, and native semantic extraction. Moreover, semantic communication systems (Sem-Com) can be categorized into text transmission, audio transmission and recognition, image transmission and recognition, and video transmission and recognition from the perspective of data modality and task classification.

• **Text Transmission:** The authors of [253] developed a DL-based text semantic communication system named DeepSC, which performs joint semantic-channel coding to achieve superior performance gains compared to existing technologies, particularly at low SNRs. Recognizing that most semantic metrics are non-differentiable, the authors of [254] introduced a reinforcement learning-based optimization paradigm for large-scale and complex text semantic transmission. This technique uses self-critical random iterative

updates to train decoupled semantic transceivers, addressing the non-differentiable semantic channel optimization issue. The authors of [255] proposed a text semantic communication technique named semantic coding Reed Solomon HARQ by combining hybrid automatic repeat request (HARQ) and Reed-Solomon channel coding with semantic coding to tackle inefficiency and inflexibility with varying sentence lengths.

•**Audio Transmission and Recognition:** A DL-based audio semantic communication system named DeepSC-S was rapidly developed, as noted in [256, 257]. This system enhances transmission efficiency by transmitting only semantic information. The audio SemCom scheme employs a joint semantic encoder/decoder and channel encoder/decoder to facilitate efficient learning and voice feature extraction while mitigating wireless channel distortions. Additionally, the authors of [258] explored using FL for audio semantic communication, developing a wav2vec-based autoencoder composed of CNNs. This system effectively encodes, transmits, and decodes audio semantic information, reducing communication overhead.

•**Image Transmission and Recognition:** The authors of [259] investigated a DeepJSCC image SemCom architecture, where the encoder and decoder functions are parameterized by CNNs and jointly trained on the same dataset to minimize the mean squared error of the reconstructed images. Joint training enables DeepJSCC to avoid the cliff effect and adapt smoothly to changes in channel signal-to-noise ratio (SNR), with performance that degrades gracefully as the SNR deviates from the assumed value during training.

•**Video Transmission and Recognition:** The authors of [260] developed a video SemCom system that benefits from semantic information. This video SemCom framework utilizes nonlinear transformations and conditional coding architectures to adaptively extract the semantic features of video frames transmitted through a set of variable-length DeepJSCC encoders/decoders and wireless channels. This video SemCom technology significantly outperforms traditional wireless video coding transmission schemes.

Semantic communication networks have unique advantages in knowledge sharing and semantic understanding, driving advancements in applications such as the tactile internet, holographic communication, XR, and human-machine symbiotic networks, fostering an increasingly intelligent and efficient society.

5 Wireless Network Large Model

As technology advances, large-scale AI models (LAM) exhibit remarkable capabilities and extensive potential in theoretical research and practical applications. However, this rapid development trend presents new challenges and requirements for the supporting network infrastructure. As a crucial component of modern communication infrastructure, wireless networks directly impact large-scale AI models' data transmission efficiency, processing speed, and overall performance. Therefore, this chapter aims to explore the critical role of wireless networks in supporting the operation of these models and conduct a systematic analysis and reflection on the relevant issues related to wireless networks in the context of constructing large-scale AI models.

5.1 Differences between LLMs and Wireless Network Large Model

As a token-based approach, LLM [261] has demonstrated outstanding performance in text and image processing tasks. Compared to the standardized text and image inputs typically handled by LLMs, the data from wireless communication systems covering air interface protocols, core network architectures, and operational management present significant complexity and diversity. Wireless communication data encompasses standardized and non-standardized heterogeneous data types characterized by temporal and relational features.

Specifically, the air interface involves wireless channels' transmission and scheduling management, encompassing diverse information generated by various wireless communication standards, such as LTE and 5G. The core network handles routing, authentication, and service control of user data, which includes sensitive content such as user behavior and location information, demanding high levels of privacy and security. Operational management data covers status monitoring, fault diagnosis, and performance optimization of network equipment. These datasets are typically large-scale, high-dimensional, lacking effective designs for unifying data across different standards. These characteristics necessitate the consideration of complex factors such as spatiotemporal relationships, real-time requirements, and system

stability when processing and analyzing wireless communication data, presenting significant differences and challenges compared to traditional LLM data processing approaches, as illustrated in Figure 23.













LLMs	Wireless Network Large Model
Input Data Format   Text tokens Images	Input Data Format    Non-standardized data
Task Type  Text generation	Task Type    Complex heterogeneous tasks
Inference Requirement  Emphasize logic	Inference Requirement   Extremely high accuracy and speed

Figure 23 Differences between LLMs and wireless network large model

Moreover, wireless communication systems constitute a highly complex ecosystem [262] employing multiple technological paradigms to meet diverse technical requirements and environmental scenarios. For instance, coding and modulation techniques are pivotal in ensuring data transmission reliability and efficiency; MIMO technology enhances data transfer rates and signal quality by utilizing multiple transmit and receive antennas; wireless interference management aims to increase overall channel capacity; traffic forecasting facilitates effective network planning and resource allocation; load balancing techniques optimize the distribution of user and data traffic across different network resources; and IP route optimization maximizes the efficiency of data packet transmission paths. These disparate wireless task models exhibit significant differences, and their commonalities are not always clear, contributing to the need for a nuanced approach to developing a large wireless network model that diverges from traditional LLM methodologies.

In contrast to the relatively lenient requirements for inference speed in LLM models used in text and image processing, the demands placed on model inference speed in wireless communication tasks are critically important. Insufficient inference speed in a large wireless network model can lead to outdated results due to significant changes in channel conditions and signal characteristics during the inference process. Therefore, ensuring that models in wireless communication systems can quickly obtain inference results is a key performance indicator for deployment effectiveness.

On the other hand, the requirements for inference accuracy in large wireless network Models far exceed those of LLMs. In language models, different combinations of word arrangements have minimal impact on semantic expression; however, in wireless communication systems, which rely on exact mathematical models, sensitivity to inference errors is markedly high, with repercussions that are difficult to quantify. Signal modulation, a critical process encoding information onto carrier signals, exemplifies this sensitivity. Minor deviations in predicting modulation parameters by the model, such as errors in frequency or phase, can prevent the receiver from correctly demodulating signals, resulting in data loss or errors. In distributed wireless networks, even slight errors in predicting clock offsets or sync signals by the model can lead to synchronization failures among nodes, thereby compromising network stability. Therefore, precise control over the inference accuracy of the Wireless Network Large Model is a critical research challenge.

Although LLM models have significantly advanced text and image processing, directly applying them to construct a large wireless network model is impractical. In practical applications, integrating domain expertise with advanced data processing techniques is essential for effectively handling and analyzing wireless communication data, addressing its complexities and dynamic challenges.

5.2 Potential Approaches to Constructing Wireless Network Large Model

Wireless Network Large Model [263] refers to an intelligent and efficient solution for communication network operations, achieved through integrating knowledge and technologies from the communication domain. The Wireless Network Large Model provides network management and operations fault detection and diagnostic services. Traditional network faults often lead to performance degradation and service interruptions. By analyzing massive network data, the Wireless Network Large Model can monitor network status in real time, promptly identify and locate potential fault points, and provide accurate fault diagnosis and handling recommendations to operations personnel.

Furthermore, the Wireless Network Large Model optimizes task orchestration and scheduling. Modern communication networks involve complex and diverse tasks and business processes, requiring efficient scheduling and management to ensure network operations. Through an in-depth analysis of network topology and business requirements, the Wireless Network Large Model optimizes task execution sequences and resource allocations, enhancing network resource utilization and business processing efficiency.

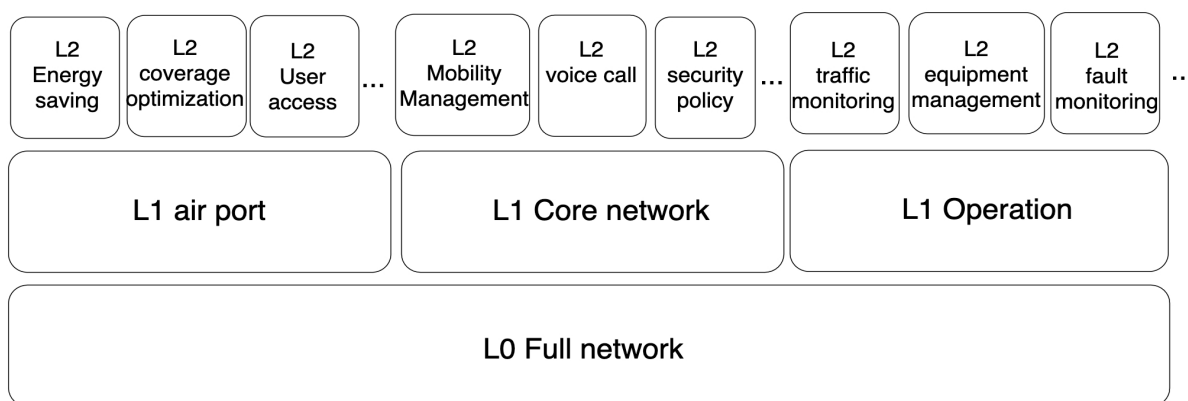

Figure 24 The three-layer architecture of Wireless Network Large Model

In terms of performance optimization and resource allocation [264], the Wireless Network Large Model employs intelligent strategies and algorithms. By continuously monitoring network load and traffic conditions and integrating predictive analytics and dynamic adjustment mechanisms [265], it achieves real-time optimization of network performance and rational allocation of resources, ensuring network stability and reliability. These functionalities enable the Wireless Network Large Model to enhance network management efficiency and capabilities for operators and network administrators, delivering stable and high-quality communication services to users.

The prevailing industry viewpoint suggests that the wireless network large model should adopt a three-layer model structure, as demonstrated in Figure 24. The L2 layer can provide customized solutions tailored to specific business scenarios in this framework. For instance, the L2 layer model can optimize energy utilization efficiency in energy conservation within networks by analyzing data traffic and device loads. Regarding traffic prediction and fault monitoring, the L2 layer model can employ deep learning techniques to identify anomalies and issue early warnings, thereby enhancing network stability and reliability.

Subsequently, the L1 layer involves domain-specific grand models. The design of the L1 layer emphasizes modeling and optimization for specific domain challenges and issues. For example, the L1 layer model can analyze wireless channel conditions and user behavior in the air interface to improve data transmission rates and coverage. The L1 layer model can utilize network topology and device status information for fault diagnosis and optimization scheduling in the core network and operations. Lastly, the L0 layer represents the universal grand model for the entire network. The design of this layer needs to consider the overall architecture and operational mechanisms of communication systems to ensure it possesses strong generalization capabilities across various scenarios. Through comprehensive data analysis and intelligent decision-making, it aims to provide optimization and management services for all communication tasks.

As shown in Figure 25, the conceptual framework for constructing a large wireless network model in

communication networks encompasses architecture design, dataset construction, computational support, and application scenarios. These aspects complement each other to form the fundamental framework of the Wireless Network Large Model.

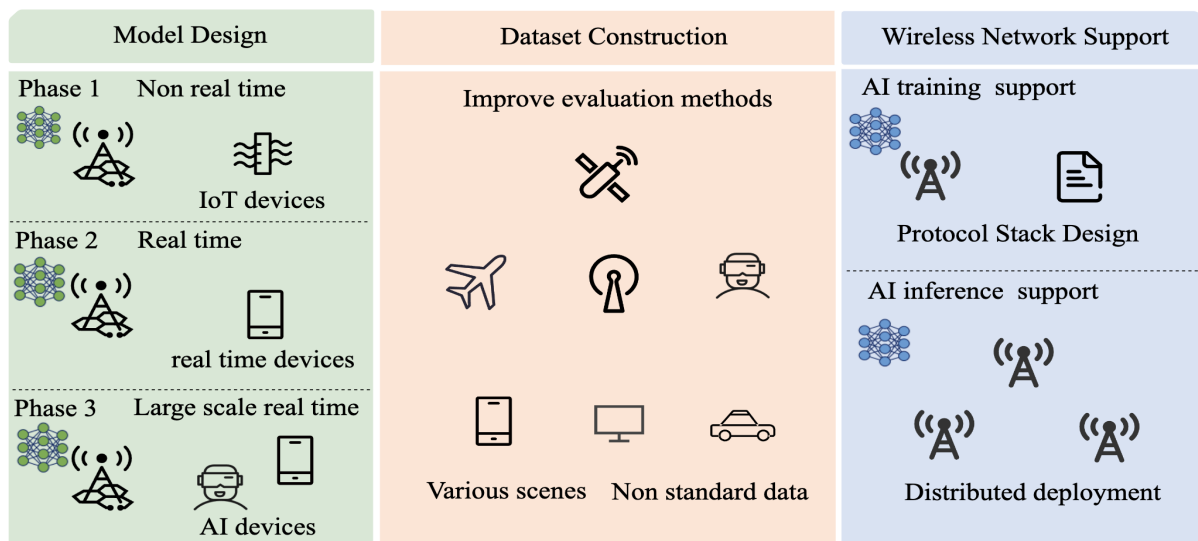

Figure 25 Potential Approaches

Firstly, considering the architecture design of the Wireless Network Large Model in communication networks, constructing a universally applicable large model for the entire network faces numerous challenges. On the one hand, data within communication networks exhibits highly structured characteristics, encompassing extensive information from various devices and sensors [266], including network traffic, device status, and user behavior. The diversity and complexity of these data present significant challenges for model construction and optimization. On the other hand, tasks within communication networks exhibit complex interdependencies and relationships, with difficulties in clearly defining their commonalities and differences. For instance, network traffic characteristics may vary substantially across different business scenarios, rendering traditional unified modeling approaches less suitable. Therefore, directly constructing a universally applicable large-scale model for the entire network is exceptionally challenging.

A phased approach to model construction becomes particularly crucial to address the aforementioned challenges effectively. This strategy reduces the complexity of model design and optimization and enhances scalability and adaptability, providing reliable foundational support for developing and optimizing large-scale network models. When implementing the phased exploration strategy, the initial focus should be small-scale, offline L2-level models. Through the in-depth research and practical validation of critical business scenarios such as network energy efficiency, traffic prediction, and fault monitoring, efficient utilization of network resources can be achieved, thereby improving overall network performance and sustainability. Subsequently, progression towards large-scale, real-time responsive L1 and L0-level models should be undertaken. In designing L1-level models, emphasis should be placed on addressing domain-specific challenges and issues, employing targeted modeling and optimization approaches to achieve domain generalization capabilities across air interface, operations, and core network sides. To construct a universally applicable L0-level model encompassing the entire network, carefully considering the communication system’s overall architecture and operational mechanisms is essential to ensure the model’s ability to support services and strategies for all communication tasks. Constructing datasets is also crucial for large-scale network models [267] directly impacting AI models’ training efficacy and application performance. Current challenges primarily revolve around data acquisition and quality difficulties [268]. Addressing these issues requires effective measures to ensure dataset quality and completeness.

To tackle the challenge of data acquisition difficulties, multiple avenues should be explored, including proactive collaboration with industry partners to promote data sharing and openness [269], involving telecommunications operators, equipment manufacturers, and others to expand the coverage of datasets. Furthermore, establishing industry standards and guidelines can guide stakeholders in adhering to unified data collection and processing standards, facilitating data sharing and exchange to overcome data

acquisition challenges.

In terms of data quality, it is essential to establish a comprehensive data quality assessment framework [270] to conduct thorough evaluations and inspections of the data. Utilizing data quality metrics such as accuracy, completeness, and consistency, the data should be assessed and monitored to detect any data quality anomalies and take corresponding measures for improvement and optimization. Additionally, employing data quality management tools and technologies can automate quality checks and validations, thereby enhancing the efficiency and precision of data quality management.

During the data collection process, it is crucial to enhance the monitoring and management of data sources to ensure the comprehensiveness and reliability of data acquisition. Advanced data cleaning and preprocessing techniques should be implemented to denoise and handle missing values in raw data, enhancing data accuracy and usability. Simultaneously, establishing robust data standardization procedures to unify data formats reduces dataset heterogeneity and inconsistencies, thereby improving the effectiveness of model training.

Regarding the computational demands of 6G communication to support large-scale network models, optimization efforts are needed in both AI training and deployment. This aims to achieve efficient, reliable, secure, and stable data transmission and utilization of computing resources. In AI training services [271], key factors include efficient and reliable training data collection and transmission processes, proprietary protocol design, support from network elements, and customized traffic scheduling algorithms. Proprietary protocols tailored explicitly for AI task transmission should be developed in the design of access and core networks in the design of access and core networks. These protocols need to account for the unique characteristics of AI tasks, such as large data volumes and computational intensity, to ensure optimal transmission efficiency and performance. Secondly, critical network elements must fully support AI task transmission, encompassing network and computing devices. These devices should have sufficient computing and storage capabilities to handle the extensive data and complex computational demands generated during AI training.

When designing network elements to support AI task transmission, considerations should be made regarding hardware architecture and software functionality to process and transmit AI training tasks effectively. Additionally, in traffic scheduling, selecting appropriate strategies is crucial for supporting the training of large AI models. Conventional traffic scheduling strategies may not suffice for AI training tasks, necessitating the design of customized traffic scheduling algorithms tailored to the characteristics of AI tasks. These algorithms should factor in task priorities, network load conditions, and device resource availability to ensure that AI training tasks receive sufficient network and computing resources promptly, thereby facilitating smooth training processes.

In AI inference services, the high demands of large AI models on storage space and computational capabilities often exceed what a single BS can provide. A viable approach is to consider designing an effective architecture utilizing distributed node collaboration [272] to collectively handle model storage and inference tasks. Alongside the design of distributed node collaboration architecture, effective management and scheduling of inference tasks are crucial to maximize the utilization of each node's computational resources while ensuring system efficiency and stability [273]. A key consideration in this regard is the design of task allocation and scheduling algorithms.

Traditional task scheduling algorithms may fail to adequately account for load conditions and computational resource utilization among nodes, resulting in decreased system performance or uneven workload distribution. Hence, intelligent task scheduling algorithms must be designed to dynamically monitor and analyze load conditions across nodes and evaluate inference task priorities and computational resource requirements in real time. This approach allows for the rational allocation and scheduling of inference tasks, effectively enhancing overall system performance and ensuring optimal utilization of node resources to achieve efficient completion of inference tasks.

Additionally, attention should be given to enhancing system monitoring and automated management. Automated management tools and mechanisms, such as automated configuration and deployment, fault diagnosis and recovery, can be introduced to detect and promptly address faults and anomalies. This reduces management and maintenance costs and improves system maintainability and manageability. These optimization measures collectively provide better technical support and assurance for AI large model computation capabilities in 6G communication networks.

5.3 Challenges of Wireless Network Large Model

- **Data Heterogeneity:** In wireless networks, the diversity and complexity of data present significant challenges for constructing adequate large-scale model datasets and inference inputs. These data encompass a wide range of types [274], including uplink and downlink channel information, Measurement Reports, Minimization of Drive Test data, Key Performance Indicator (KPI) monitoring data, network topology performance metrics, as well as cost and energy consumption data, among various standardized or non-standardized formats. These data may exhibit significant granularity and temporal resolution differences from diverse sources. A primary research concern is effectively aligning such heterogeneous data to establish a consistent and representative dataset. The differences in data formats, sources, and collection environments must be carefully considered during data preprocessing to ensure high accuracy and reliability in training and inference for the final model. Techniques such as data normalization, time-series alignment, data fusion, and handling of missing data may be necessary. Furthermore, for constructing a large wireless network model, attention must be given to converting processed data into suitable input formats for inference algorithms. This may involve feature extraction and selection, data dimensionality reduction, and constructing appropriate input representations to enable efficient inference and decision-making by the model.

- **Real-Time Inference:** Wireless Network Large Model is commonly employed for real-time decision-making and optimization tasks [275] such as dynamic spectrum allocation, power control, and user access management. However, if the inference time of these models is prolonged or inefficient, timely responses to network changes and demands may be compromised [276], thereby impacting overall network performance and user experience. Consequently, deploying the large wireless network model demands exceptionally high performance standards. This is particularly critical in network resource scheduling, where stringent time constraints necessitate model inference completion within milliseconds to effectively manage and allocate communication network resources. This directly influences the network's real-time responsiveness and service quality. To meet these requirements [277], the design and deployment of the Wireless Network Large Model must prioritize optimizing inference speed. This involves hardware acceleration, algorithm optimization, and adjustments to network architecture [278]. Moreover, achieving a balance between model accuracy and computational efficiency is essential to enable efficient and reliable management and scheduling of network resources.

- **Ambiguous Route:** In wireless communication technology, constructing a broadly applicable large-model framework continues to present challenges. At the same time, current industry practices favor leveraging large-scale pre-trained language models as foundational elements, subsequently fine-tuned for specific industry applications. The complexity and dynamics of wireless networks demand models with heightened adaptability and flexibility. Recent explorations in semantic communication-based models [279] have made strides towards a more profound understanding and processing of data flows within wireless networks. However, the feasibility and efficacy of these models in practical deployment, including their stability and performance across diverse environments and conditions, remain open research questions requiring further empirical validation.

- **Protocol Compatibility:** Integrating and deploying the Wireless Network Large Model inevitably relies on the protocol stack of communication networks. However, since large-model technologies have emerged recently, compatibility issues with existing communication protocol stacks require urgent resolution. The capability of current communication protocol stack architectures to meet the demands of future large-scale models and strategies for augmenting and optimizing existing protocol stacks to support these models in wireless networks better constitute significant technical challenges. This involves thoroughly analyzing existing protocol stacks to identify potential barriers to integration with large-scale models and exploring new protocol design principles to ensure efficient and stable operation of Wireless Network Large Models in wireless network environments.

- **Security Threats:** Wireless Network Large Model faces multiple security challenges [280]. Firstly, there are concerns regarding data privacy and protection. In deploying 5G networks, large datasets may include sensitive information such as user locations, mobility patterns, and communication content. Without adequate protection, these data could risk privacy breaches [281], leading to compromised user trust and legal issues. Secondly, data tampering presents another significant threat to large models. Attackers may inject misleading data or manipulate sources to influence the model's learning process and decision outcomes. For instance, incorrect input data could misjudge user demands or network congestion conditions. Additionally, network attacks targeting large wireless network models are hazardous. Mali-

cious actors may disrupt model operations or regular requests through flooding or resource consumption attacks, severely impacting service availability and real-time decision-making capabilities. Finally, ensuring the security and integrity of large model architectures is crucial. Reverse engineering and leakage of model parameters could provide attackers with sensitive information about intellectual property or operational mechanisms, jeopardizing service stability and reliability.

6 AI as a Service

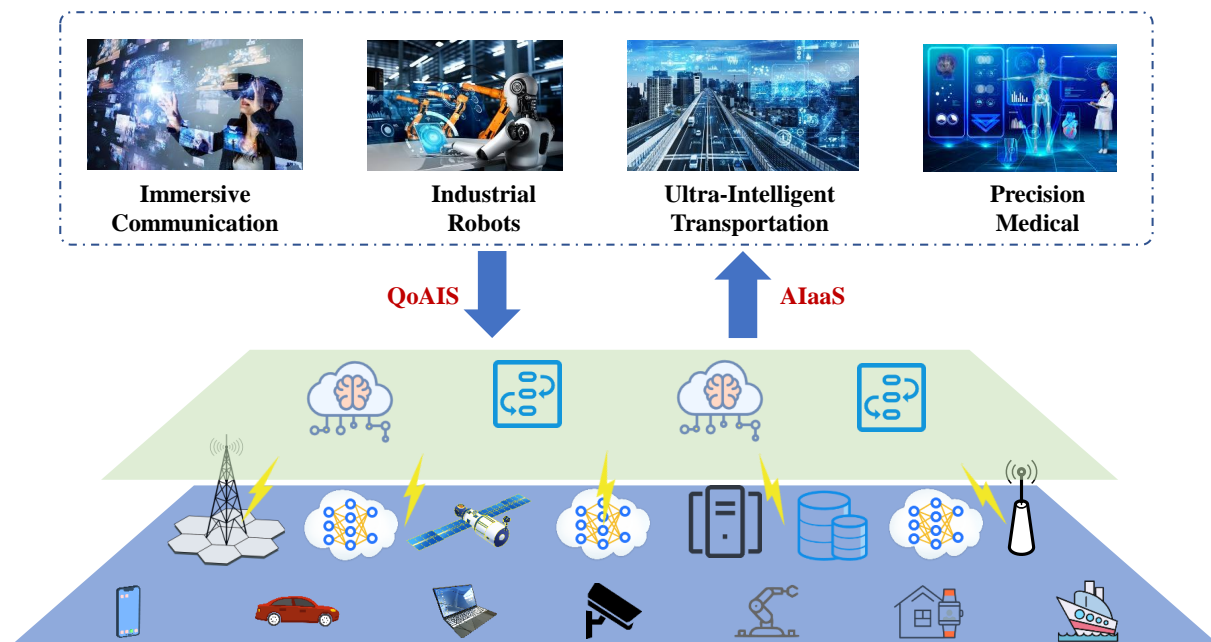

Figure 26 AI as a Service

As described in Section 1, to more effectively support "native intelligence" and achieve ubiquitous "universal intelligence," future 6G networks will treat AI as a service, giving rise to the concept of 6G AI as a Service (AIaaS) [282], which is presented in Figure 26. 6G will provide efficient end-to-end support for AI-related businesses and applications, intelligently connecting distributed agents for large-scale AI deployment across various industries. 6G AI services will address needs for high real-time performance, high security and privacy, or low overall energy consumption by conducting AI training or inference within the network, offering intelligent capabilities tailored to different application scenarios.

6G networks, as inherently intelligent architectures, will be able to efficiently train or infer large-scale distributed AI through resources and functionalities within the network, including communication, computation, datasets, and foundational models [283]. This transition from AI for networks in 5G to networks for AI in 6G will ultimately provide intelligence that goes beyond data, directly targeting users. This transformation will redefine the ecosystem of edge clouds and create new business models through 6G mobile networks, transitioning from connectivity-focused to service-oriented networks and ultimately achieving ubiquitous intelligence.

6.1 Typical Scenarios of AIaaS

Typical scenarios for 6G AIaaS are contexts and situations where AI in 6G networks comes into play, including but not limited to industries and fields such as industry, agriculture, daily life, education, and healthcare [284].

6.1.1 Immersive Communication

In future communication, immersive technologies like VR, AR, and Measurement Reports will enhance interactive experiences [285]. AIaaS will support these technologies with real-time language translation,

emotion analysis, and personalized suggestions in virtual environments, improving communication efficiency. Trained AI models will be validated to ensure realistic and credible interactions. 6G AIaaS will offer comprehensive AI training, collecting user data for multimodal learning and enabling rapid model training and updates [286]. It will support multi-device linkage, allowing various devices to interact with virtual environments. 6G's extended coverage will seamlessly connect virtual and real worlds, facilitating cross-system information sharing. DT technology will enhance AI validation, generating richer sample data than physical environments and improving model stability and performance. As intelligent terminals increase, 6G's ultra-large connectivity and low latency will be essential for AI training and validation, supporting precise positioning and massive data collection.

6G AIaaS must deliver high-quality autonomous services to ensure secure interactions in virtual environments, with options ranging from fully autonomous to human-controlled services. This support will lead to more realistic and efficient immersive communication, advancing remote collaboration and communication.

6.1.2 *Intelligent Industrial Robots*

Industrial robots will be widely utilized in future industrial manufacturing and transportation scenarios [287]. For instance, construction robots can complete building tasks under remote control. Industrial robots will be considered to replace human workers for hazardous tasks, particularly in extreme working environments such as high temperatures and high altitudes. This will enable an "unmanned factory," where people only need to use their terminal devices. After completing the AI training of intelligent robots, it is essential to validate the AI models before deployment to ensure the safe and efficient execution of production tasks by the intelligent robots.

6G AIaaS provides AI training services for robots, such as data collection through robots, applying model training for multi-agent learning, and distributing the trained models to the robots. The extreme transmission capabilities of 6G will support rapid model training and parameter exchange between robots and the network. 6G AIaaS also offers multi-system linkage capabilities, allowing various terminal devices to network with robots flexibly and enabling remote control via computers, smartphones, and VR devices. The coverage of the 6G mobile communication system extends from traditional user terminals to environmental sensing devices. Robots can connect and interact with the environment through 6G AIaaS's sensing technology. They can even engage in cross-environment and cross-system learning with robots from different departments, sharing experiences. Additionally, the 6G network can leverage DT networks to provide AI verification services, iteratively training AI models with greater robustness and better performance through performance pre-validation. 6G AIaaS offers AI verification services for trained models, requiring the DT network to generate sample data in more scenarios than the physical environment, reducing the overhead and performance impact of data collection from the physical network, thereby further improving the stability and performance of AI models.

Intelligent industrial robots demand service quality regarding algorithmic performance metrics, training time, computational precision, duration, and efficiency. With the increasing variety of intelligent terminal types in recent years, 5G may gradually become insufficient to meet the AI training needs of more devices. This necessitates 6G to offer ultra-high connectivity, low latency, and stable AI training services. AI verification services require the 6G network to provide the DT network's virtual environment with massive data collection, precise positioning, and ultra-low latency transmission capabilities. Furthermore, the intelligent industrial robot scenario requires service quality indicators for the autonomy dimension. The safety of industrial robots can prevent many hazards caused by human negligence or fatigue, requiring 6G AIaaS to provide high-quality services that are fully autonomous, partially human-controlled, and fully human-controlled.

6.1.3 *Precision Medical*

In the future, smart healthcare will encompass various aspects of disease prevention, prediction, diagnosis, reasoning, monitoring, clinical surgery, patient care, and vaccine and drug development throughout the entire lifecycle [288]. Smart healthcare will involve centralized hospitals at all levels and distributed community and home healthcare scenarios in the spatial dimension. In the professional dimension, it will integrate and utilize knowledge and experience across different medical disciplines. The overall vision of smart healthcare is to enable individuals to obtain better care, treatment, and protection for their health and well-being at lower costs and more conveniently and efficiently. The new 6G system will

better support the massive information transmission and synchronization required for smart healthcare and directly empower the processing and decision-making of medical information.

Healthcare is closely related to individual life and health safety, making the accuracy and reliability of predictive diagnostics crucial. Traditional predictive diagnostics based on single AI models face limitations in accuracy, reliability, and real-time performance due to the maturity of AI algorithms and the availability of case data samples. By leveraging AI over 6G networks, geographically dispersed medical institutions and individual practitioners can connect more extensively, aggregate more AI models and case data samples, and rapidly transmit and synchronize information between doctors and patients. This enhances FL and group learning, continually improving the accuracy, reliability, and real-time performance of predictive diagnostics and treatment actions, thereby increasing trust in the prospects of smart healthcare.

Smart healthcare can also achieve more rational planning and optimized allocation of various medical resources through 6G network AI, significantly reducing the physical and psychological stress on doctors and patients and addressing issues such as "difficulties in seeking medical treatment," "long waiting times," and "over-medication." Additionally, protecting the privacy of predictive diagnostics and treatment results for certain diseases is vital. Using a 6G network, AI-distributed technology can better safeguard individual medical information privacy.

6.1.4 *Ultra-Intelligent Transportation*

In the future, ultra-intelligent transportation will involve various stages across the temporal dimension, including high-definition map downloads, vehicle environment perception, environmental prediction, and route planning [289]. Spatially, ultra-intelligent transportation will cover scenarios such as highways, urban roads, and enclosed areas. The vision for ultra-intelligent transportation is to enable intelligent vehicles to provide users with a safer, more efficient, and more comfortable riding experience at a lower cost. As the new foundational infrastructure for future information and communication technology, the 6G system boasts ultra-low latency, high-reliability transmission, supercomputing power, and precise sensing. These characteristics will support the real-time transmission, processing, and intelligent decision-making of data related to ultra-intelligent transportation, achieving full network intelligence.

In the context of ultra-intelligent transportation, taking autonomous driving as an example, the 6G system can provide AI-based data services, AI computation offloading services, and AI-based environment prediction or path planning. AI-based data services refer to the 6G system providing autonomous vehicles with AI-driven environmental perception results. For instance, when an autonomous vehicle encounters a perception blind spot, the 6G system can collect perception data through sensors or wireless signals, then use AI models to infer the environment within the blind spot and feed the results back to the vehicle, enhancing driving safety. AI computation offloading refers to the process where autonomous vehicles offload part of their AI model inference or training computations to the 6G system. For example, when a vehicle drives through a complex road segment, the computational power required for AI model inference can increase significantly, resulting in unacceptable latency. In such cases, the vehicle can offload some of the AI computation tasks to the 6G system, thereby reducing the processing burden on the vehicle's chips.

Targeting sea, land, air, and space transportation, the 6G network's extensive coverage and intelligent capabilities enable autonomous driving and smart traffic management for vehicles, intelligent scheduling for ships and aviation, and unified control and management of water, land, underground, and aerial transportation. With the 6G network's deep learning and multi-sensor fusion capabilities, an integrated perception and decision-making architecture is established for vehicles, roadside infrastructure, and cloud platforms. This architecture advances a new era of intelligent transportation characterized by intelligent travel, ubiquitous services, and comprehensive management and control. In terms of travel, it achieves the organic unification of individual optimal travel solutions and the overall highest efficiency of the transportation system.

6.2 QoAIS

QoAIS refers to a system of metrics framework for AI services in the network, which broadly needs to involve dimensions such as performance, connectivity, computation, data, security, and orchestration [290]. The performance dimension metrics in QoAIS differ from the model KPIs for ML. This is because the latter refers to the evaluation metrics of the model itself, which are mainly used for optimization and tuning of the model. The former extends that content, such as generalizability and robustness of

Table 7 QoAIS indicator system of AI services

Service Category	Indicator Dimension	QoAIS Indicators
AI Services	Performance	Boundary of performance metrics, training time, generalization, reusability, robustness, interpretability, consistency between loss function and optimization objectives, fairness, etc.
	Connection	Bandwidth and jitter, link delay and jitter, bit error rate and jitter, reliability, etc.
	Data	Feature redundancy, completeness, data accuracy, time-consuming data preparation, sample space balance, sample distribution dynamics, etc.
	Computation	Computing accuracy, duration, efficiency, etc.
	Security	Information confidentiality, data/algorithm privacy levels, data authenticity, traceability, etc.
	Orchestration	Full autonomy, partially controllable by humans, fully controllable by humans, etc.

the model/algorithm, to describe the whole system more comprehensively in terms of performance. The metrics of other dimensions in QoAIS are new metrics that consider the 6G network itself and thus extend it. As shown in Table 7, the content of the whole QoAIS system should include:

- **Performance-related:** boundary of performance metrics, training time, generalization, reusability, robustness, interpretability, consistency between loss function and optimization objectives, fairness, etc. 1) Boundary of Performance Metrics: Defines the upper and lower limits for assessing the quality of model performance indicators, such as error rate, precision, recall, etc. 2) Generalization: The ability of a model, after training, to accurately predict outcomes on new, unseen data. 3) Reusability: The capability of a model to continue functioning effectively when applied to varying scenarios. 4) Robustness: The characteristic of a model to maintain certain performance levels despite perturbations, attacks, or uncertainty in the input data. 5) Interpretability: The extent to which a model supports understanding its internal mechanisms and the outcomes it produces. 6) Consistency Between Loss Function and Optimization Objectives: The alignment between the design of the loss function during model training and the optimization goals specific to AI use cases, including whether all variables relevant to the optimization targets are fully accounted for in the function.
- **Connection-related:** bandwidth and jitter, link delay and jitter, bit error rate and jitter, reliability, etc.
- **Data-related:** feature redundancy, completeness, data accuracy, time-consuming data preparation, sample space balance, sample distribution dynamics, etc.
- **Computation-related:** computing accuracy, duration, efficiency, etc.
- **Security-related:** information confidentiality, data/algorithm privacy levels, data authenticity, traceability, etc.
- **Orchestration-related:** full autonomy, partially controllable by humans, fully controllable by humans, etc. Autonomy refers to the requirements for autonomous operation and human intervention in the AI data/training/validation/inference service workflow, reflecting users' expectations for the degree of automation in AI services. It is classified into three levels: 1) Full Autonomy: Fully automated AI services requiring no human intervention throughout the process. 2) Partially Controllable by Humans: AI service workflows that are automated in some stages but require human assistance in others. 3) Fully Controllable by Humans: AI service workflows necessitate human involvement in all stages.

7 Standardization Process

As wireless communication and AI integration is a focus of the industry's research direction, important standardization organizations and industry alliances at home and abroad have launched research on integrating mobile communication networks and AI since 2017. These include the third-generation Mobile

Communication Partnership Project (3GPP), International Telecommunication Union (ITU), European Telecommunication Standardization Institute (ETSI), China Communication Standardization Association (CCSA), IMT-2020 (5G) Promotion Group, IMT-2030 (6G) promotion group, etc. Currently, 3GPP has three Technical Specification Groups: the core network and terminals (CT), radio access network (RAN), and Service and system aspects (SA). Each TSG has 4 to 6 Working Groups. The 3GPP SA WG2 (responsible for developing the overall 3GPP system architecture and services, including User Equipment, Access Network, Core Network and IP multimedia Subsystem System Architecture and Services) and the 3GPP RAN WG3 (responsible for the overall radio network architecture and the specification of protocols for the related network interfaces) already accomplished some specification work on data collection, data analytic, and associated procedures at core network and radio network. 3GPP SA WG5 has progressed in standardizing network management data analytics services for managing AI/ML Models and functions. ETSI's zero-touch network and service management working group focuses on the research and analysis of technologies related to automated closed-loop operations, aiming to achieve a high degree of automation in network and service management. ETSI's Experiential Networked Intelligence (ENI) working group is focused on defining an experiential and aware network management architecture that uses AI to improve operators' experience in network deployment and operations. Its goal is to use AI technology to improve the efficiency and automation of network management by defining a perception-adaptive-decision-execute control model. Figure 27 displays the application process of the AI model.

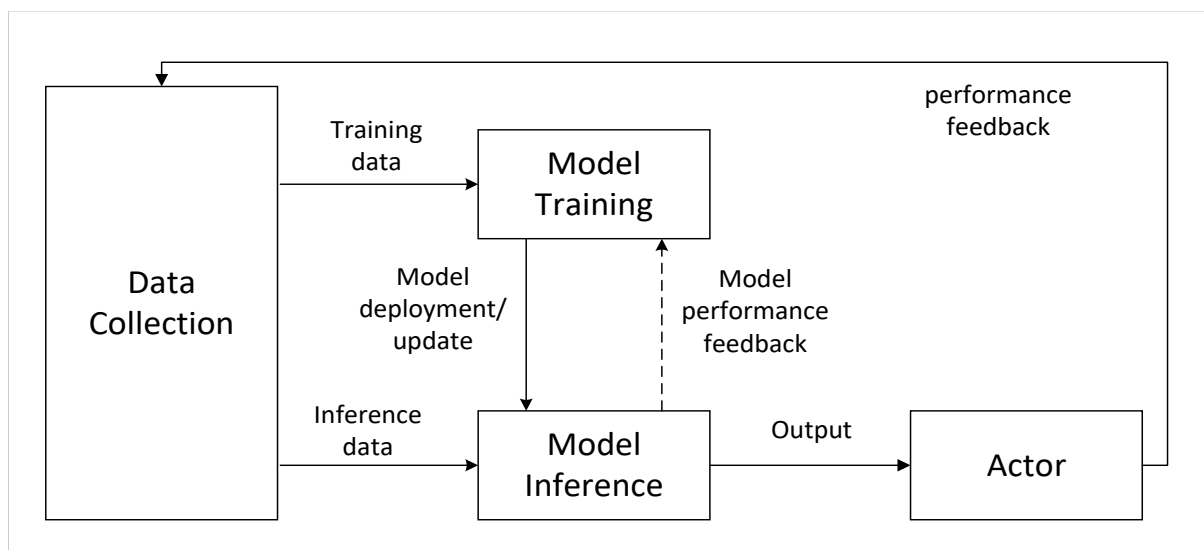

Figure 27 This is the flowchart when applying the AI model to the communication process. The training task of the AI model needs to collect a large amount of data information in advance. The trained model must also be deployed in the corresponding position, and the model inference performance determines whether the AI model still has application value.

3GPP has conducted relevant research on network intelligence and automation and introduced network data analytics function (NWDAF) as a core network AI element since Release-15. NWDAF can collect data from any network functions in 5GC and third-party application functions. Due to time limitations, only slice-specific network data analytics is supported in Rel-15. Various network data and third-party application data from AF and 5GC network functions could be used as input to NWDAF, and output analytic results from NWDAF could be used by other NFs to guide network optimization, such as the following use cases been introduced in the Release-16: customized mobile management, 5G quality of service (QoS) enhancement, user plane function (UPF) selection, network functions load balancing, slicing SLA guarantee, etc. Rel-17 allows multiple NWDAFs to be deployed in a distributed architecture. Another enhancement is decomposing the monolithic tWDAF into a Model Training Logic Function, Analytics Logical Function, and Analytics Data Repository Function. Further, the data collection coordination function (DCCF) enhances the data collection framework. Rel-18, the model performance monitoring, multi-vendor ML Model sharing, Horizontal FL, and six more use cases have been standardized.

In wireless access networks, 3GPP has identified typical application scenarios for SON and has applied machine learning techniques, successfully verifying its usefulness in optimizing network performance. In 2018, 3GPP SA5 Group set up a research project, "a study on SON for 5G," aimed at the integra-

tion of SON and 5G network technology, studying to promote the integration of SON and 5G network infrastructure by strengthening the collection and application of wireless big data.

The RAN1 Working Group identified the Study Item "Study on AI/machine learning for NR air interface" in the Rel-18 phase. The SI explores how AI/ML algorithms can enhance air interface performance (throughput, robustness, accuracy, or reliability) and reduce overhead. The main application scenarios of this research include AI-based CSI feedback, AI-based beam management, AI-based positioning enhancement, and life cycle management of AI/ML model/functionality for the air interface.

The 3GPP RAN2 Working Group identified the rStudy on AI/ML for mobility in NR" research project in December 2023. The study project aims to evaluate potential benefits and potential specification impacts of AI/ML-aided mobility for network-triggered L3-based handover, considering the following aspects: AI/ML-based RRM measurement and event prediction for L3 Mobility, HO failure/RLF prediction, and Measurement events prediction.

The 3GPP RAN3 Working Group identified the study item "Study on further enhancement for data collection" in July 2020; the SI aims to enable an intelligent functional architecture for RAN through use cases to enhance data collection further and identify potential standardization implications for current NG-RAN nodes and interfaces. In February 2022, the SI was completed, and the intelligent typical functional architecture on the RAN side, input, output, feedback, and potential standard impact of three high-priority use cases (e.g., network energy saving, load balancing, and mobility optimization) were written into TR 37.817. The intelligent universal functional architecture on the RAN side includes functions such as data collection, model training, model inference, and action execution. The 3GPP RAN3 Working Group identified the "AI/Machine Learning for NG-RAN" work item. The WI aims to incorporate data collection enhancements and signaling support specified in existing NG-RAN interfaces and architectures to enable AI/ML-based network energy saving, load balancing, and mobility optimization.

The TSG SA (responsible for the overall architecture and service capabilities of 3GPP systems and the cross-3GPP TSG coordination) identified the Study item, "3GPP AI/ML Consistency Alignment," in June 2024. The SI will investigate ongoing AI/ML work in TSG CT, TSG RAN and TSG SA Working Groups and identify instances of any potential misalignment and/or inconsistencies. TSG SA leads the study in close collaboration and inputs from TSG CT and TSG RAN. The technical report of this SI will be finalized by June 2025.

In addition to the 3GPP-defined NWDAF network element, the 5G-Monarch project in Europe introduced RAN-DAF, an independent AI analysis function explicitly designed for CU in 5G NR, for data analysis and decision-making. As a network element for AI and data analysis on the RAN side, RAN-DAF can monitor and collect UE and RAN data, and AI can prioritize local processing based on these real-time data to solve the need for rapid response of operations such as wireless resource management. MoNArch recommends that the RAN-DAF pass information to the controller on the RAN side to collaborate with the RCA to optimize wireless side performance, such as slice-sensitive selection, live wireless resource control, cross-slice resource management, and so on.

ITU-T Study Group 13 established the ITU-T Focus Group on Machine Learning for Future Networks and 5G in November 2017. The group has drafted several technical reports and specifications for machine learning in future networks, including network architectures, interfaces, protocols, algorithms, etc. There are three working groups (WG) under the focus group where WG1 studies potential machine learning use cases in future networks and identifies the needs of use cases, and WG2 mainly works to classify machine learning in mobile communication networks and define the required data formats and related mechanisms to protect security and privacy. WG3 primarily studies the requirements of machine learning on network architecture in mobile communication networks, including network functions, interfaces, resources, etc.

In 2017, ETSI established the ENI Working Group dedicated to applying AI technologies to network operations. Improve the experience of operator network deployment and operations with a closed-loop AI mechanism based on context-aware and data-driven strategies. Since its inception, ENI has published several versions of specifications and reports, including system architectures with context-aware policy management, data processing mechanisms, and hierarchical evaluation methods for network AI. In 2019, ETSI ENI published the first edition of this research report and standard and launched the second phase of the closed-loop control study for real-time networks.

In recent years, standardization organizations have also focused on the research and preparation of 6G. In June 2019, the China IMT-2030 (6G) promotion group was established to gather the strength of Chinese industry, universities and research institutes, promoting China's 6G mobile communication technology research and carrying out international exchanges and cooperation and successively releasing several

white papers and research reports such as the data format and model proposal of mobile communication and AI integration. In June 2023, the 44th meeting of the ITU radio communication sector 5D working group (ITU-R WP5D) was held in Geneva, Switzerland, and the recommendation on the framework and overall objectives of the IMT for 2030 and Beyond was completed. This proposal aims to set a framework and overall goals for the development of international mobile communications (IMT) in 2030 and beyond, involving a global 6G vision consensus, 6G goals and trends, typical 6G scenarios and capability indicators system, including the convergence of AI and communication scenarios, and define AI-related indicators. On September 12, 2024, at the 105th Plenary meeting held in Melbourne, Australia, 3GPP officially launched the first 6G Study Item - “6G use cases and Service Requirements”. This initiative formally marks the 6G technology from the pre-research stage into the substantive standardization stage.

The vigorous development of AI standardization will significantly promote the integration of communication and AI, as shown in Figure 28. AI still has a way to go from standardization to landing, which is also the main research direction of many standardization organizations in the future.

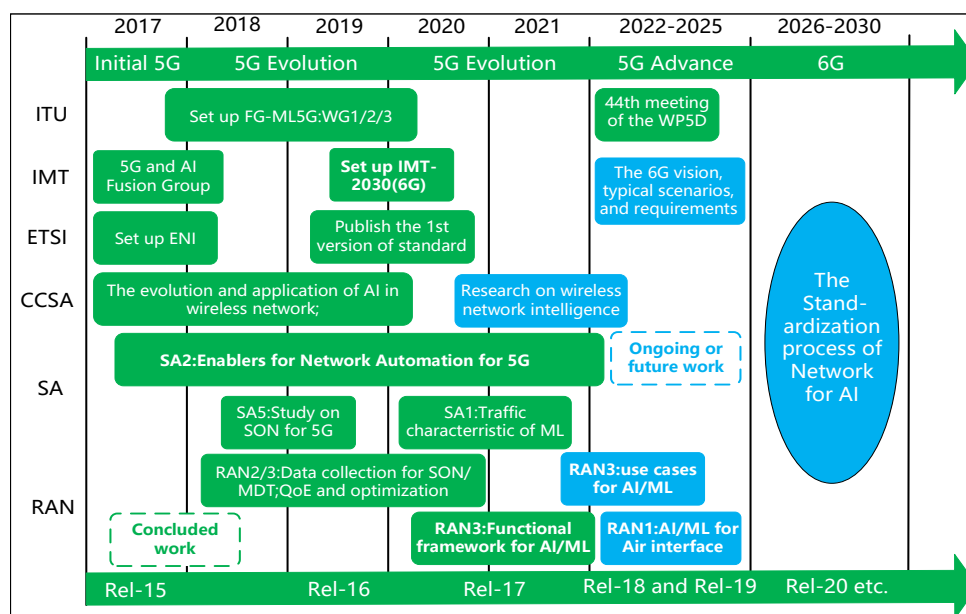

Figure 28 AI standardization process

8 Challenges of AI and communication for 6G

Integrating AI into 6G networks presents a dual-edged sword, offering significant advantages and notable challenges. On the one hand, AI enhances network efficiency, enabling intelligent resource allocation, real-time data analysis, and adaptive communication strategies. Semantic communication, for instance, leverages AI to interpret and convey the intended meaning of messages, reducing bandwidth usage and improving transmission accuracy. Generative AI further contributes by creating predictive models that enhance network performance and user experience.

On the other hand, these advancements introduce complexities. The challenges of AI for the network include the strain on bandwidth and storage due to complex models. Conversely, the challenges of the network for AI require robust infrastructure to support advanced functionalities. The reliance on AI raises concerns about sustainability, as increased energy demands impact the environmental footprint. The requirement for real-time AI necessitates ultra-low latency, demanding sophisticated computational infrastructure. Security and privacy are at risk from potential attacks on sensitive data. Lastly, human-AI interactive collaboration presents ethical challenges, necessitating transparent oversight to ensure trust and accountability.

This section focuses on the multifaceted challenges faced by AI and communication for 6G from the abovementioned perspectives.

8.1 Challenges of AI For Network

The practiced deployment of AI in complex, time-varying wireless environments also challenges AI. At the same time, improving the interpretability of AI deployment in wireless environments, promoting people to understand AI, trust AI, and use AI will also be important in introducing AI into wireless communication.

- ***Generalization of AI models***

The generalization problem is widely prevalent in integrating AI with communication systems [291–294]. Network models with poor generalization capabilities cannot often extend their learned knowledge to other variable domains. Consequently, such models favor one or a few data types, resulting in suboptimal performance when reasoning on different data types. This issue becomes particularly critical when the model is exposed to diverse datasets on which it was not explicitly trained, leading to a significant decline in its effectiveness.

The application of AI in wireless communications imposes even higher demands on model generalization [291–293, 295–299]. In wireless environments, users are situated in varying contexts, with factors such as the relative position to BSs and user mobility playing significant roles. This variability means that pre-trained AI models may lose effectiveness when confronted with new data that deviate from their training sets. In the dynamic and complex wireless environments characteristic of 6G networks, models with poor generalization capabilities will lack the potential for deployment and widespread use. Therefore, enhancing the generalization ability of AI models within 6G networks is a critical issue requiring industry and academia dedicated attention. Addressing this challenge will ensure that AI models maintain high performance and adaptability across diverse and evolving wireless scenarios, thus facilitating their successful integration into future communication systems.

- ***Robustness of AI models***

Robustness, derived from the concept of cybernetics [300], plays a central role in AI as it measures whether an AI model can maintain its efficacy and reliability in the face of real-world complexity and uncertainty. A robust AI model can keep the stability of its output in the face of minor deviations from the data. This property is critical in determining whether the model suits real-world scenarios.

In modern wireless communication systems, AI technologies such as deep learning are playing an increasingly important role [300]. For example, in the field of semantic communication, deep neural networks are widely used for critical tasks such as semantic coding, decoding and understanding [253, 256, 301]. However, the fragility of deep learning models and the open nature of wireless channels make these AI-powered communication systems extremely vulnerable to physical layer adversarial attacks. Attackers can mislead the semantic interpretation on the receiving end by injecting carefully designed perturbation signals, causing catastrophic consequences in certain critical domains that rely on highly reliable communication (e.g., autonomous driving, smart healthcare, etc.). In this context, the robustness of AI algorithms in communication systems is particularly important [253, 256, 300, 301]. Ensuring the robustness of AI algorithms in communication systems has become a critical issue.

- ***Interpretability of AI***

Deep learning is essentially a black box due to its highly nonlinear nature. The model learns through neurons, convolution kernel and other ways. People cannot understand the meaning, importance and fluctuation range of parameters in the neural network through basic statistical assumptions like linear regression parameters, which leads to unexplainability. For example, we only focus on the encoder and decoder output if we use AI for CSI feedback. We do not have a concrete understanding of how AI performs feature extraction and recovery, leading to the randomness of model training and inference performance that is difficult to control and increased unreliability against harsh, extreme environments.

Interpretable AI is not only a technical issue but also a complex issue involving trust, fairness, regulation, and human relations. Improving the explainability of AI and helping human users understand the decision-making process, working principle and potential bias of AI to build trust in AI is necessary to promote the broad application of AI in communication and even in various fields. The millions or even billions of parameters in deep neural networks and their nonlinear activation function form a highly complex decision boundary. This complexity makes the model's decision-making process difficult to understand intuitively, thus posing significant challenges for interpretability.

8.2 Challenges of Network For AI

The inherent characteristics of wireless communication will have an impact on the performance of RAN in supporting AI services, mainly in five aspects: the dynamics of wireless transmission, the heterogeneity of wireless networks, the discrete nature of wireless nodes, the large-scale complexity of network development, and the scarcity of computing resources in wireless networks. In this paper, we research the characteristics of these five aspects to explore their impact on AI's performance and deployment realization in wireless access networks and propose potential solutions.

• *Dynamics of Networks*

Constructing an AI execution environment in wireless networks inherently entails significant dynamic variations. The interference and loss in the wireless connection between terminals and BSs are impacted by the surrounding urban environment and changes in the operational states of other BSs, subsequently affecting the uplink and downlink connection rates. At the same time, terminals exhibit high mobility, potentially moving from the center to the edge of a cell, switching to another cell, or even leaving the wireless coverage area. Additionally, distinct from dedicated computing resources in IT clouds, wireless networks carry traditional mobile connectivity tasks, with the mobile traffic load on individual network elements continually fluctuating. BSs alternate between busy and idle periods, and terminals enter an idle state when there are no uplink or downlink services. These variations contribute to the dynamic nature of mobile wireless networks, resulting in slow model training convergence and adversely affecting model inference performance. It can lead to the failure or loss of partial information, such as gradients or losses, during AI model computations, further slowing down convergence and, in severe cases, causing divergence and failure to converge.

Acknowledging the influence of these dynamic wireless transmission factors, the authors of [302] designed a mitigation strategy for unreliable communication nodes. This approach leverages dynamic wireless channel state predictions to estimate the training completion latency for each user equipment's local model. It avoids unreliable wireless communication nodes, prioritizing nodes with stable and high-speed wireless connections for training participation. When unstable or disconnected device nodes occur during training, the strategy advocates for their exclusion to ensure continuous and efficient AI training. Simulation results demonstrate that avoiding unreliable nodes facilitates stable convergence during AI model training.

• *Heterogeneity of Networks*

In wireless communication networks, a myriad of heterogeneities exist, encompassing communication heterogeneity arising from the varying geographical locations of nodes and the time-varying nature of communication network links; computational heterogeneity due to differences in the number, manufacturing processes, and architectures of node chips; data heterogeneity in terms of the volume and distribution of data possessed by nodes, influenced by factors such as storage capacity and application scenarios; and model heterogeneity stemming from varying task objectives that lead to the training of diverse models. These heterogeneities pose challenges to achieving efficient distributed learning.

This diverse heterogeneity influences both AI performance and convergence. Data heterogeneity results in disparities among local gradients computed by AI models, causing inconsistency in the direction of aggregated gradients, which can lead to model divergence or even non-convergence. Differences in computational power and communication capabilities lead to variations in AI model computation and information transmission efficiency, giving rise to the straggler effect. Furthermore, in AI learning, when the number of user devices is sufficiently large or the local models are adequately complex, the consumption of wireless resources during transmission becomes significant.

• *Discreteness of Networks*

The discrete nature of 6G mobile networks, characterized by highly heterogeneous and dynamically changing environments, poses significant challenges to the application of AI. This discreteness manifests through the rapid and unpredictable variations in network topology, user mobility patterns, and service demands, leading to inconsistent and fragmented data streams. Such conditions impede the ability of AI models to maintain accuracy and reliability, as the models must continuously adapt to a multitude of scenarios with limited contextual information. The resulting variability can degrade the performance of AI algorithms, particularly those relying on stable and predictable data inputs, thereby affecting tasks such as predictive analytics, resource allocation, and anomaly detection.

These challenges necessitate a concerted effort from academia and industry to develop AI models with enhanced robustness and generalization capabilities. This involves advancing research in adaptive

learning techniques, transfer learning, and FL for the academic community to handle better the sporadic and diverse data inherent in 6G networks. For the industry, there is a pressing need to design and implement resilient AI-driven network management systems capable of real-time adaptation to fluctuating conditions. Addressing these challenges satisfactorily will be crucial for leveraging the full potential of AI in optimizing the performance and efficiency of 6G mobile networks.

- ***Complexity of Networks***

The large scale and complexity of 6G networks significantly affect the deployment and performance of AI systems. The many connected devices, diverse applications, and heterogeneous network environments introduce unprecedented data volume, variety, and velocity levels. AI models must process and analyze this extensive data in real time to make effective decisions, which is a daunting task due to the high-dimensional and dynamic nature of the information. The large-scale deployment of AI in 6G networks also necessitates distributed and decentralized processing architectures, complicating data aggregation and synchronization. Furthermore, the intricate interplay between various network components, such as edge and core networks, requires AI models to handle multifaceted interactions and dependencies, leading to increased computational overhead and latency. Consequently, AI algorithms' scalability and efficiency are tested, making it challenging to maintain high performance and reliability across the entire network.

Addressing these challenges demands innovative approaches from both academia and industry. From the perspective of academia, there is a need to advance research in scalable AI techniques, including distributed learning, edge computing, and hierarchical models, to efficiently handle the massive and complex data in 6G networks. Developing AI algorithms capable of real-time processing and decision-making with minimal latency is crucial. Additionally, robust frameworks for integrating AI with existing network infrastructures must be explored to ensure seamless operation. The industry should focus on implementing scalable AI-driven solutions that can dynamically adapt to the network's complexity and scale. This involves designing intelligent network management systems that can autonomously optimize resources, enhance security, and improve user experiences. Collaborative efforts between academia and industry will be essential to develop and deploy AI technologies that can fully leverage the capabilities of 6G networks, ensuring robust performance and efficient operation in an increasingly complex and large-scale environment.

- ***Resource Scarcity of Networks***

In large-scale and dynamic edge federated networks, the localized model training and transmission may not always succeed due to constraints on mobile devices' power and computational resources, bandwidth limitations, wireless channel impairments, etc., directly compromising the performance of FL regarding model accuracy and convergence speed. Consequently, evaluating the trade-off relationship between cognitive performance and multi-dimensional resource allocation becomes imperative upon introducing distributed learning.

The authors of [303] focus on FL-enabled edge intelligence networks by leveraging Poisson Point Processes to construct an analytical model. The work delves into three specific scenarios, each deriving mathematical relationships between FL performance, consumed computational resources, and communication resources by analyzing the impact of Signal-to-Interference-plus-Noise Ratio, SNR, and faulty transmissions on local and global models. This provides a theoretical foundation and basis for optimizing the framework design of intelligent access networks and allocating communication, computing power, and data resources.

8.3 Consideration of Sustainability

The imperative to reduce energy consumption in the context of AI and 6G integration is deeply rooted in the global consensus on carbon neutrality and peak carbon emissions. Through agreements like the Paris Agreement, the international community has committed to significant environmental goals, including halving carbon emissions by 2030. These commitments reflect an agreement on the urgent need to combat climate change and its potentially devastating impacts. AI's role in enhancing 6G network performance is indisputable. The advanced capabilities of AI are crucial for managing the complex operations of 6G networks, which promise unprecedented speeds, low latency, and high reliability. However, the computational power required for AI comes at a high energy cost, which, if unchecked, could increase carbon emissions. This directly conflicts with the global movement towards reducing greenhouse gas emissions and achieving a sustainable, low-carbon future [304]. Therefore, the concept of "green" development has become a core tenet of 6G evolution. The telecommunications industry is under increasing pressure to

demonstrate environmental responsibility by minimizing its carbon footprint. This is a response to regulatory requirements and mandates and reflects consumer expectations and corporate social responsibility. As a result, striking a balance between performance and green objectives has emerged as one of the main challenges for future 6G development.

Techniques such as pruning, quantization, and using neural architecture search can help create leaner models that maintain high accuracy while reducing computational load [305]. Developing energy-aware AI models that dynamically adjust their energy consumption based on the current network demands can contribute to a more sustainable operation [306]. Another aspect is optimizing data processing and transmission within 6G networks [307]. Leveraging AI for intelligent traffic routing and predictive maintenance can reduce unnecessary energy expenditure. Furthermore, deploying AI at the network's edge can help localize data processing, reducing the energy costs associated with data transfer across long distances. Integrating renewable energy sources into 6G infrastructure is also critical to the green 6G vision. The telecommunications industry can significantly reduce its reliance on fossil fuels and its overall carbon footprint by powering data centers and network operations with solar, wind, and other renewable energies.

8.4 Requirement of Real-Time AI

The 6G aims to achieve uRLLC to support various real-time applications, including autonomous driving, telemedicine, and industrial automation. These scenarios impose unprecedented requirements on network real-time responsiveness and reliability, necessitating data transmission and processing to be completed within milliseconds or even microseconds. However, the current state-of-the-art AI models, characterized by large parameter spaces and intensive computation, typically employ distributed deployment, which inevitably introduces additional latency. The computational complexity of AI models presents a direct challenge to the real-time capabilities of 6G networks. The inference process of deep learning models involves extensive matrix operations, especially when processing high-dimensional data, significantly increasing computational load. Achieving rapid model inference without sacrificing performance is a critical barrier to realizing the uRLLC objectives of 6G. The importance of real-time processing capabilities in 6G networks is not only reflected in enhancing user experience. Ensuring the regular operation and safety of critical services is crucial. For instance, the latency requirements for perception and decision-making systems in autonomous driving are extremely stringent; any delay could result in untimely system responses, thus posing safety risks. Therefore, real-time performance is a fundamental metric within 6G networks.

The challenge of model optimization is presented to achieve real-time AI in a 6G environment. Reducing the computational requirements of models without significantly compromising accuracy is possible through techniques such as model pruning, parameter quantization, and adopting more efficient network architectures, such as lightweight versions of CNN and RNN [308]. Additionally, adopting edge computing can reduce latency by shifting data processing tasks from the central cloud to the network edge [309]. Innovations in network architecture, such as network slicing technology, can also provide customized network resources for different services and applications, ensuring critical tasks receive the necessary bandwidth and latency guarantees [310]. Moreover, AI can manage network resources dynamically and accommodate real-time changes in network conditions. The development of hardware acceleration is also crucial for achieving real-time AI. Dedicated AI processors, such as Graphics Processing Units (GPU), Tensor Processing Units, and Field-Programmable Gate Arrays, can expedite the inference process of models, helping to meet the stringent real-time requirements of 6G networks.

8.5 Security and Privacy

The integration of AI and 6G introduces complex security and privacy challenges. The convergence of AI and 6G introduces security vulnerabilities at multiple levels. AI algorithms are susceptible to adversarial attacks, where slight, often imperceptible, perturbations in the input data can lead to incorrect outputs, thereby compromising the system's integrity. Moreover, the reliance on large-scale data for training AI models poses privacy risks, as sensitive information may be inferred from the training data. Additionally, the distributed nature of 6G networks, with many devices connected at the edge, expands the attack surface, making it more challenging to secure against unauthorized access and data breaches [311].

Some existing work has inspired addressing these security and privacy issues. One aspect involves the development of robust AI models through techniques like adversarial training, which can enhance the

resilience of AI systems against malicious to mitigate these inputs [312]. Another approach is the implementation of FL, where AI models are trained across multiple decentralized devices without exchanging the raw data, thereby preserving privacy [313]. In addition to technological solutions, regulatory frameworks and policies must be established to define clear data protection and cybersecurity standards in the context of AI-6G integration. This includes setting guidelines for responsible AI usage, ensuring compliance with privacy regulations such as the General Data Protection Regulation, and fostering international collaboration to combat cyber threats. Moreover, secure multi-party computation and homomorphic encryption can perform computations on encrypted data, ensuring data privacy even when processed by third parties [314].

8.6 Human-AI Interactive Collaboration

Integrating AI with 6G communication networks presents transformative opportunities for enhancing human-AI interactive collaboration. However, this convergence also introduces significant challenges that must be addressed to realize its full potential. One of the primary issues is the stringent real-time response requirements imposed by 6G's ultra-low latency capabilities. Traditional AI algorithms, which often require substantial computational resources and time, may struggle to develop this, so developing lightweight AI models optimized for edge computing is essential. These models must be capable of rapid processing and decision-making, reducing the dependency on centralized data centers and minimizing latency. Furthermore, 6G networks will facilitate the transmission of diverse data types, including video, audio, text, and sensor data, necessitating human-AI interactive collaboration systems to handle and interpret multimodal data adeptly. Advances in deep learning and multimodal learning technologies are crucial for effectively fusing and understanding these varied data streams, thereby enhancing the naturalness and intuitiveness of interactions.

In addition to technical advancements, the architectural design of AI deployment within 6G networks plays a pivotal role in optimizing human-AI interactive collaboration. The distributed AI architecture inherent to 6G offers new avenues for more flexible and efficient interaction experiences. By strategically deploying intelligent algorithms at the network edge and on terminal devices, achieving a more seamless and responsive human-AI interactive collaboration is possible. This distributed approach not only alleviates the computational burden on central servers but also enhances the adaptability and resilience of the system. Moreover, integrating AI and 6G necessitates robust security and privacy measures to protect sensitive user data, which is paramount in maintaining user trust and compliance with regulatory standards. Future research should focus on developing secure, privacy-preserving AI models and algorithms that operate efficiently within the 6G framework. By addressing these challenges, the integration of AI and 6G can significantly advance human-AI interactive collaboration, providing more intelligent, efficient, and user-friendly communication services that meet the evolving demands of future societies.

9 Future Works

As we look towards the future, integrating AI and 6G networks presents many research opportunities and challenges. The following areas highlight key directions for future work:

- ***Adaptive Learning Mechanisms***

The advent of 6G networks heralds a paradigm shift in managing network operations, with AI playing a central role. Adaptive learning mechanisms, leveraging AI, are set to become the cornerstone of smart network management. These mechanisms must handle the complexity and dynamism of 6G environments characterized by heterogeneous devices, variable traffic patterns, and the need for real-time processing.

Research is expected to focus on developing machine learning models that can continuously learn and adapt without human intervention. These models should be scalable to manage the exponential increase in connected devices and robust to ensure consistent performance under varying network states. One promising approach is using DRL, which can dynamically optimize network decisions. DRL can adjust network parameters in real-time, ensuring optimal performance for changing network loads and user mobility patterns. Moreover, integrating transfer learning techniques can enable these AI models to apply knowledge gained in one domain to new but related problems. This is particularly relevant in 6G networks that will operate in diverse environments and must quickly adapt to new conditions. Transfer learning can reduce the need for extensive retraining of models, thereby saving computational resources and time. Another focus area can be the development of self-healing networks using AI. By

incorporating predictive analytics, networks can anticipate failures and automatically reroute traffic or adjust parameters to mitigate the impact. This proactive approach to fault management will be critical for maintaining the high reliability and availability required by 6G applications.

- ***Optimized Network Architectures***

The underlying network must be optimized to cater to their requirements for AI applications to reach their full potential. 6G networks, with their promise of higher bandwidths and lower latencies, provide an ideal platform for AI applications but also pose significant challenges in terms of architectural design.

Future research can delve into creating network architectures that are inherently flexible and can dynamically adapt to the needs of AI applications. Such architectures must support high data rates and the ability to process large volumes of data with minimal latency. AI can significantly enhance the capability of the network to manage these requirements by predicting traffic patterns and adjusting resources accordingly. A key component of such architectures is edge computing, which brings computational resources closer to the data sources. This is crucial for latency-sensitive AI applications that require near-instantaneous decision-making. Research should explore the development of edge computing solutions that can seamlessly integrate with central cloud resources, providing a balanced computational hierarchy. Furthermore, deploying AI at the network edge introduces new challenges in distributed learning and data privacy. The FL emerges as a viable solution, allowing AI models to be trained locally at the edge, with only model updates being shared to the central server. This reduces the bandwidth requirements and addresses privacy concerns by keeping sensitive data localized.

- ***Green AI and 6G Networking***

The sustainability of 6G networks is a critical concern that must be addressed from an environmental and an economic perspective. AI has the potential to drive significant advancements in this area by optimizing network operations to reduce energy consumption.

Future research should focus on developing AI models that can accurately predict the energy consumption of network components and optimize their operation to minimize waste. This includes the dynamic adjustment of network infrastructure, such as BSs and data centers, based on user demand and traffic patterns. AI can enable these components to enter low-power states when demand is low and quickly ramp up when the demand increases. In addition to optimizing existing infrastructure, research should explore the design of new, energy-efficient hardware that can support AI operations at the network edge. This includes the development of specialized processors that can run AI algorithms with high efficiency and low power consumption.

Renewable energy sources in 6G networks can be another critical area of research. AI can manage integrating renewable energy sources, such as solar and wind, into the network's power supply. This involves predicting energy generation patterns and adjusting network operations to match the availability of renewable energy. Furthermore, AI can contribute to developing new communication protocols designed with energy efficiency in mind. By optimizing how data is transmitted and received, these protocols can reduce the energy consumption of network devices and extend their operational lifetime.

- ***AI for Ultra-Low Latency Communications***

Ultra-low latency communications are a key feature of 6G networks, enabling a new generation of applications that require immediate response times. AI is poised to play a pivotal role in achieving this goal by providing real-time data processing and decision-making capabilities.

Future research should focus on developing AI systems that can operate at the network edge, providing near-instantaneous response times for critical applications. This includes creating lightweight AI models that can be deployed on edge devices with limited computational resources. One of the challenges in this area is the need for AI algorithms that can make decisions based on incomplete or uncertain data. Research should explore the use of techniques such as probabilistic modeling and approximate computing to enable AI systems to operate effectively under these conditions. Another critical research area can be the development of AI-driven network orchestration tools that can manage the allocation of computational resources in real time. These tools must be able to predict the computational needs of different applications and allocate resources accordingly to ensure that latency requirements are met.

- ***AI-Enhanced Cybersecurity in 6G***

The security of 6G networks is of utmost importance, as these networks will support a wide range of critical applications and services. AI has the potential to significantly enhance the cybersecurity of 6G networks by providing advanced threat detection and response capabilities. Future research can look into developing AI-based security frameworks that can identify and respond to cyber threats in real time.

This involves using machine learning algorithms to analyze network traffic and detect anomalies that may indicate a security breach.

One of the challenges in this area is the need for AI systems that can adapt to the constantly evolving landscape of cyber threats. Research should explore using adaptive learning algorithms that can update their models in response to new types of attacks. Another critical research area can be the development of AI-driven security protocols that can automatically patch vulnerabilities and respond to incidents without human intervention. This requires the creation of intelligent systems that can understand the context of security incidents and take appropriate actions to mitigate their impact. The use of AI for cybersecurity also raises significant privacy concerns. Research can address these concerns by developing privacy-preserving AI algorithms that protect user data while providing adequate security.

- ***AI-Driven Innovations in 6G Communication Technologies***

The AI with 6G communication networks promises significant advancements in key technologies such as reconfigurable intelligence surfaces (RIS) [315], integrated sensing and communication (ISAC), Open Radio Access Networks (ORAN), Non-Terrestrial Networks (NTN) and near-field communication [316]. Intelligent reflecting surfaces can dynamically manipulate wireless environments to optimize signal propagation. Future research should develop advanced AI algorithms for real-time RIS optimization, leveraging machine learning to adapt to changing channel conditions. Additionally, the interaction between RIS and other 6G technologies, such as massive MIMO and millimeter-wave communications, needs thorough exploration to enhance spectral efficiency and network capacity.

The ISAC merges sensing and communication functions to improve spectrum utilization and provide environmental context for network optimization. AI-driven techniques for joint waveform design and resource allocation are crucial for seamless ISAC integration [317]. Moreover, developing AI algorithms for real-time data fusion will be essential for extracting actionable insights from ISAC systems. ORAN's software-defined architecture can benefit from AI-driven network management, enhancing adaptability and resilience. NTN, including satellite systems, can leverage AI for efficient resource management and fault detection, ensuring robust global connectivity. Future research should focus on AI models tailored to NTNs, addressing challenges like latency and dynamic network topology [318]. By advancing AI applications in these key areas, researchers can unlock new levels of performance and efficiency in 6G networks, paving the way for a more connected and intelligent world.

10 Conclusions

In this all-encompassing review, we initially highlight that the 6G network's evolution towards an integrated wireless infrastructure platform amalgamating communication, sensing, computation, intelligence, and storage hinges on the profound integration of AI and communications. The retrospective analysis of the development of AI and the evolution of large-scale models within the paper distinctly discloses its fundamental role in molding modern communication technology. Concurrently, the exposition of the three-stage integration of AI within 6G networks, namely "AI for Network," "Network for AI," and "AI as a Service," furnishes a lucid blueprint for understanding the technological development trajectory. These three consecutive stages present the strategic shift from utilizing AI to optimize the network, through the network facilitating support for AI to the network offering AI as a service, thereby underlining the interdependent and coordinative developmental relationship between communication and AI. In studying the standardization process of AI within the network environment, we have systematically organized the key milestones and current priorities. This is vital for guaranteeing the coordinated global development of the technology. Analyzing the pros and cons of integrating AI and communication in 6G networks furnishes a foundation for a comprehensive evaluation of the technology's impact. This enables us to maximize the benefits and minimize the risks during its development. Additionally, we have analyzed the challenges of integrating AI and communication from the perspectives of sustainability, real-time performance, security, etc. The proposed countermeasures for the current research challenges offer feasible directions for subsequent research and practice. We are convinced that this review holds profound significance for the research on the integration of AI and communication for the 6G network, and it can provide deep-seated insights for academic researchers and industry experts alike.

References

- 1 Li K, Lau B P L, Yuan X, et al. Toward ubiquitous semantic metaverse: Challenges, approaches, and opportunities. *IEEE Internet Things J.*, 2023, 10: 21855–21872
- 2 Cisco U. Cisco annual internet report (2018–2023) white paper. Cisco: San Jose, CA, USA, 2020, 10: 1–35
- 3 Cui Q, Ni W, Li S, et al. Learning-assisted clustered access of 5G/B5G networks to unlicensed spectrum. *IEEE Wireless Commun.*, 2020, 27: 31–37
- 4 Zhang J, Cui Q, Zhang X, et al. Online optimization of energy-efficient user association and workload offloading for mobile edge computing. *IEEE Transactions on Vehicular Technology*, 2022, 71: 1974–1988
- 5 Cui Q, Gong Z, Ni W, et al. Stochastic Online Learning for Mobile Edge Computing: Learning from Changes. *IEEE Commun. Mag.*, 2019, 57: 63–69
- 6 Wang J, Jiang C, Kuang L. High-mobility satellite-uav communications: Challenges, solutions, and future research trends. *IEEE Communications Magazine*, 2022, 60: 38–43
- 7 Van Den Broek F, Verdult R, De Ruiter J. Defeating imsi catchers. In: *Proceedings of the 22Nd ACM SIGSAC Conference on Computer and Communications Security*. 2015, 340–351
- 8 Saleem R, Ni W, Ikram M, et al. Deep-reinforcement-learning-driven secrecy design for intelligent-reflecting-surface-based 6G-IoT networks. *IEEE Internet of Things Journal*, 2023, 10: 8812–8824
- 9 Dutta A, Hammad E. 5G security challenges and opportunities: A system approach. In: *2020 IEEE 3rd 5G world forum (5GWF)*. IEEE, 2020, 109–114
- 10 Lyu X, Ren C, Ni W, et al. Online learning of optimal proactive schedule based on outdated knowledge for energy harvesting powered internet-of-things. *IEEE Transactions on Wireless Communications*, 2021, 20: 1248–1262
- 11 Gong Z, Hashash O, Wang Y, et al. Uav-aided lifelong learning for aoi and energy optimization in non-stationary iot networks. *IEEE Internet of Things Journal*, 2024: 1–1
- 12 Li X, Cui Q, Xue Q, et al. A new batch access scheme with global qos optimization for satellite-terrestrial networks. In: *GLOBECOM 2022 - 2022 IEEE Global Communications Conference*. Rio de Janeiro, Brazil, 2022, 3929–3934
- 13 Cui Q, Zhang X, Ni W, et al. Big data analytics for intelligent management of autonomous vehicles in smart cities. in the book: *Communication Technologies for Networked Smart Cities*, IET Press., 2021
- 14 Ren Y, Cui Q, Zhao X, et al. Data-driven intelligent management of energy constrained autonomous vehicles in smart cities. *Cognitive Radio-Oriented Wireless Networks.*, 2021
- 15 Cui Q, Wang Y, Chen K C, et al. Big data analytics and network calculus enabling intelligent management of autonomous vehicles in a smart city. *IEEE Internet of Things Journal*, 2019, 6: 2021–2034
- 16 Yue L, Chen T. AI large model and 6G network. In: *2023 IEEE Globecom Workshops (GC Wkshps)*. IEEE, 2023, 2049–2054
- 17 Tong W, Li G Y. Nine challenges in artificial intelligence and wireless communications for 6G. *IEEE Wireless Communications*, 2022, 29: 140–145
- 18 Hong E K, Lee I, Shim B, et al. 6G R&D vision: Requirements and candidate technologies. *Journal of Communications and Networks*, 2022, 24: 232–245
- 19 Yang T, Ning J, Lan D, et al. Kubeedge wireless for integrated communication and computing services everywhere. *IEEE Wireless Communications*, 2022, 29: 140–145
- 20 Tao Z, Xu W, Huang Y, et al. Wireless network digital twin for 6G: Generative AI as a key enabler. *arXiv preprint arXiv:2311.17451*, 2023
- 21 Chen X, Guo Z, Wang X, et al. Foundation model based native AI framework in 6G with cloud-edge-end collaboration. *arXiv preprint arXiv:2310.17471*, 2023
- 22 Wu J, Li R, An X, et al. Toward native artificial intelligence in 6G networks: System design, architectures, and paradigms. *arXiv preprint arXiv:2103.02823*, 2021
- 23 Liu G, Deng J, Zheng Q, et al. 6G native intelligence: Technical challenges architecture and key features. *Mobile Communications*, 2021, 45: 68–78
- 24 Shan B, Yuan X, Ni W, et al. Preserving the privacy of latent information for graph-structured data. *IEEE Transactions on Information Forensics and Security*, 2023, 18: 5041–5055
- 25 Maatouk A, Piovesan N, Ayed F, et al. Large language models for telecom: Forthcoming impact on the industry. *arXiv preprint arXiv:2308.06013*, 2023
- 26 Turing A M. Computing machinery and intelligence. *Mind*, 1950, 59: 433–460
- 27 Flasiński M. *History of Artificial Intelligence*. Springer International Publishing, Cham, 2016
- 28 Shortliffe E H. Mycin: A knowledge-based computer program applied to infectious diseases. *Proceedings of the Annual Symposium on Computer Application in Medical Care*, 1977: 66
- 29 Hinton G E. Deep belief networks. *Scholarpedia*, 2009, 4: 5947
- 30 Krizhevsky A, Sutskever I, Hinton G E. Imagenet classification with deep convolutional neural networks. In: *Pereira F, Burges C, Bottou L, et al., eds., Advances in Neural Information Processing Systems*. Curran Associates, Inc., 2012, vol. 25
- 31 Behera R, Das K. A survey on machine learning: Concept, algorithms and applications. *International Journal of Innovative Research in Computer and Communication Engineering*, 2017, 2
- 32 Hossain Z, Sohail F, Shiratuddin M F, et al. A comprehensive survey of deep learning for image captioning. *Acm Computing Surveys*, 2019, 51: 1–36
- 33 Bengio Y, Courville A, Vincent P. Unsupervised feature learning and deep learning: A review and new perspectives. 2012
- 34 Mnih V, Kavukcuoglu K, Silver D, et al. Playing atari with deep reinforcement learning. *Computer Science*, 2013
- 35 Dong S, Wang P, Abbas K. A survey on deep learning and its applications. *Computer Science Review*, 2021, 40: 100379
- 36 Li H, Lin Z, Shen X, et al. A convolutional neural network cascade for face detection. *IEEE*, 2015
- 37 Lipton Z C, Berkowitz J, Elkan C. A critical review of recurrent neural networks for sequence learning. *Computer Science*, 2015
- 38 Goodfellow I, Pouget-Abadie J, Mirza M, et al. Generative adversarial nets. In: *Ghahramani Z, Welling M, Cortes C, et al., eds., Advances in Neural Information Processing Systems*. Curran Associates, Inc., 2014, vol. 27
- 39 You F, Yuan X, Ni W, et al. A novel privacy-preserving incentive mechanism for multi-access edge computing. *IEEE Transactions on Cognitive Communications and Networking*, 2024, 10: 1928–1943
- 40 Cui Q, Zhang X, Ni W, et al. Multi-agent deep reinforcement learning-based interdependent computing for mobile edge computing-assisted robot teams. *IEEE Trans. Veh. Technol.*, 2023, 72: 6599–6610
- 41 Cao Y, Li S, Liu Y, et al. A comprehensive survey of AI-generated content (aigc): A history of generative AI from gan to chatgpt. *arXiv preprint arXiv:2303.04226*, 2023

- 42 Knill K, Young S. Hidden Markov Models in Speech and Language Processing, Springer Netherlands, Dordrecht. 1997, 27–68
- 43 Reynolds D. Gaussian Mixture Models, Springer US, Boston, MA. 2009, 659–663
- 44 Operationnelle D, Bengio Y, Ducharme R, et al. A neural probabilistic language model. 2001
- 45 Kombrink S, Mikolov T, Karafiát M, et al. Recurrent neural network based language modeling in meeting recognition. In: Proceedings of the Annual Conference of the International Speech Communication Association, INTERSPEECH. 2011, 2877–2880
- 46 Graves A. Supervised Sequence Labelling with Recurrent Neural Networks, vol. 385. 2012
- 47 Dey R, Salem F M. Gate-variants of gated recurrent unit (gru) neural networks, 2017. 1701.05923
- 48 Goodfellow I J, Pouget-Abadie J, Mirza M, et al. Generative adversarial networks, 2014. 1406.2661
- 49 Kingma D P, Welling M. Auto-encoding variational bayes, 2022. 1312.6114
- 50 Brown T, Mann B, Ryder N, et al. Language models are few-shot learners. In: Larochelle H, Ranzato M, Hadsell R, et al., eds., Advances in Neural Information Processing Systems. Curran Associates, Inc., 2020, vol. 33, 1877–1901
- 51 Ramesh A, Pavlov M, Goh G, et al. Zero-shot text-to-image generation. In: Meila M, Zhang T, eds., Proceedings of the 38th International Conference on Machine Learning. PMLR, 2021, vol. 139 of Proceedings of Machine Learning Research, 8821–8831
- 52 Dosovitskiy A, Beyer L, Kolesnikov A, et al. An image is worth 16x16 words: Transformers for image recognition at scale, 2021. 2010.11929
- 53 Liu Z, Lin Y, Cao Y, et al. Swin transformer: Hierarchical vision transformer using shifted windows. In: 2021 IEEE/CVF International Conference on Computer Vision (ICCV). 2021, 9992–10002
- 54 Radford A, Kim J W, Hallacy C, et al. Learning transferable visual models from natural language supervision, 2021. 2103.00020
- 55 Rombach R, Blattmann A, Lorenz D, et al. High-resolution image synthesis with latent diffusion models, 2022. 2112.10752
- 56 Deng J, Dong W, Socher R, et al. Imagenet: A large-scale hierarchical image database. In: 2009 IEEE Conference on Computer Vision and Pattern Recognition. 2009, 248–255
- 57 Lin T Y, Maire M, Belongie S, et al. Microsoft coco: Common objects in context, 2015. 1405.0312
- 58 Zhu Y, Kiros R, Zemel R, et al. Aligning books and movies: Towards story-like visual explanations by watching movies and reading books, 2015. 1506.06724
- 59 Gao L, Biderman S, Black S, et al. The pile: An 800gb dataset of diverse text for language modeling, 2020. 2101.00027
- 60 Gemmeke J F, Ellis D P W, Freedman D, et al. Audio set: An ontology and human-labeled dataset for audio events. In: 2017 IEEE International Conference on Acoustics, Speech and Signal Processing (ICASSP). 2017, 776–780
- 61 Miech A, Zhukov D, Alayrac J B, et al. Howto100m: Learning a text-video embedding by watching hundred million narrated video clips, 2019. 1906.03327
- 62 Raffel C, Shazeer N, Roberts A, et al. Exploring the limits of transfer learning with a unified text-to-text transformer, 2023. 1910.10683
- 63 OpenAI. ChatGPT: An AI Language Model. <https://www.openai.com/chatgpt>, 2024. Accessed: 2024-07-04
- 64 Katz D M, Bommarito M J, Gao S, et al. GPT-4 passes the bar exam. Philosophical Transactions of the Royal Society A: Mathematical, Physical and Engineering Sciences, 2024, 382
- 65 Touvron H, Martin L, Stone K, et al. Llama 2: Open foundation and fine-tuned chat models, 2023. 2307.09288
- 66 Tunstall L, Beeching E, Lambert N, et al. Zephyr: Direct distillation of lm alignment, 2023. 2310.16944
- 67 Dubois Y, Galambosi B, Liang P, et al. Length-controlled alpacaeval: A simple way to debias automatic evaluators, 2024. 2404.04475
- 68 Zheng L, Chiang W L, Sheng Y, et al. Judging llm-as-a-judge with mt-bench and chatbot arena, 2023. 2306.05685
- 69 Xu C, Sun Q, Zheng K, et al. Wizardlm: Empowering large language models to follow complex instructions, 2023. 2304.12244
- 70 Borji A. Generated faces in the wild: Quantitative comparison of stable diffusion, midjourney and dall-e 2, 2023. 2210.00586
- 71 Yu J, Li X, Koh J Y, et al. Vector-quantized image modeling with improved vqgan, 2022. 2110.04627
- 72 Liu Y, Zhang K, Li Y, et al. Sora: A review on background, technology, limitations, and opportunities of large vision models, 2024. 2402.17177
- 73 Wang Q, Zou S, Sun Y, et al. Toward intelligent and adaptive task scheduling for 6G: An intent-driven framework. IEEE Transactions on Cognitive Communications and Networking, 2024, 10: 1975–1988
- 74 Reddy A G, Sinha S, Reddy P A, et al. Network traffic prediction for 5G network. In: 2023 International Conference on Recent Advances in Electrical, Electronics, Ubiquitous Communication, and Computational Intelligence (RAEEUCCI). 2023, 1–5
- 75 Ulanowicz B, Dopart D, Knapieńska A, et al. Combining random forest and linear regression to improve network traffic prediction. In: 2023 23rd International Conference on Transparent Optical Networks (ICTON). 2023, 1–4
- 76 Ye L, Ding S, Liu C, et al. Network traffic prediction based on double-synchronized periodic lstm. In: 2022 IEEE 46th Annual Computers, Software, and Applications Conference (COMPSAC). 2022, 409–410
- 77 Li S, Song J, Xu L, et al. Network traffic prediction based on the feature of newly-generated network flows. In: 2022 IFIP Networking Conference (IFIP Networking). 2022, 1–8
- 78 Gao D, Wang Y, Zhao Z, et al. Prediction model of bursty network traffic for cloud data center based on gan-trellisnet. In: 2023 IEEE 3rd International Conference on Information Technology, Big Data and Artificial Intelligence (ICIBA). 2023, vol. 3, 1697–1701
- 79 Qiu L, Jin L, Chai L. Network traffic prediction based on spatio-temporal graph convolutional network. In: 2023 42nd Chinese Control Conference (CCC). 2023, 8426–8431
- 80 Han F, Zhao S, Zhang L, et al. Survey of strategies for switching off base stations in heterogeneous networks for greener 5G systems. IEEE Access, 2016, 4: 4959–4973
- 81 Yu X, Xiao B, Ni W, et al. Optimal adaptive power control for over-the-air federated edge learning under fading channels. IEEE Transactions on Communications, 2023, 71: 5199–5213
- 82 China unicom. China unicom 5G intelligent energy-saving technology white paper v3.0[r/ol].(2022-05).
- 83 Kaur J, Khan M A, Iftikhar M, et al. Machine learning techniques for 5G and beyond. IEEE Access, 2021, 9: 23472–23488
- 84 Mao Q, Hu F, Hao Q. Deep learning for intelligent wireless networks: A comprehensive survey. IEEE Communications Surveys & Tutorials, 2018, 20: 2595–2621
- 85 China mobile research institute. White paper on 5G base station energy saving technology [r/ol]. (2020-09-06). [2023-8-20]. <http://www.chuangze.cn/attached/file/20200906/20200906165430923092.pdf>

- 86 Chernogorov F, Puttonen J. User satisfaction classification for minimization of drive tests qos verification. In: 2013 IEEE 24th Annual International Symposium on Personal, Indoor, and Mobile Radio Communications (PIMRC). 2013, 2165–2169
- 87 Luo Z Q, Zheng X, López-Pérez D, et al. Scon: A data-driven network performance simulator for real-world wireless networks. *IEEE Communications Magazine*, 2023, 61: 96–102
- 88 You X, Pan Z, Gao X, et al. Development trend and some key technologies of 5G mobile communication. *Science China (Information Sciences)*, 2014, 44: 551–563
- 89 Tu Y H, Ma Y W, Li Z X, et al. Applying deep reinforcement learning for self-organizing network architecture. In: 2023 IEEE 6th International Conference on Knowledge Innovation and Invention (ICKII). 2023, 16–20
- 90 Mohanty M N, Patnaik L. Adaptive handoff technique for next-generation wireless system. In: 2013 International Conference on Machine Intelligence and Research Advancement. 2013, 493–497
- 91 Cheng M H, Chen H Y, Hwang W S, et al. A precise handover algorithm for wireless communication networks on high-speed mobile environment. In: 2018 IEEE International Conference on Applied System Invention (ICASI). 2018, 1358–1361
- 92 Oh S M, Kang S Y, Go K C, et al. An enhanced handover scheme to provide the robust and efficient inter-beam mobility. *IEEE Communications Letters*, 2015, 19: 739–742
- 93 He C, Yang Q, Han S, et al. A vertical handover algorithm based on velocity pre-decision and fuzzy logic for heterogeneous private network. In: 2020 International Wireless Communications and Mobile Computing (IWCMC). 2020, 1555–1560
- 94 Wang W, Duan X, Sun W, et al. Research on mobility prediction in 5G and beyond for vertical industries. In: 2021 IEEE/CIC International Conference on Communications in China (ICCC Workshops). 2021, 379–383
- 95 Liu Q, Chuai G, Wang J, et al. Proactive mobility management with trajectory prediction based on virtual cells in ultra-dense networks. *IEEE Transactions on Vehicular Technology*, 2020, 69: 8832–8842
- 96 Gismalla M S M, Azmi A I, Salim M R B, et al. Survey on device to device (d2d) communication for 5GB/6G networks: Concept, applications, challenges, and future directions. *IEEE Access*, 2022, 10: 30792–30821
- 97 Nan G, Li Z, Zhai J, et al. Physical-layer adversarial robustness for deep learning-based semantic communications. *IEEE Journal on Selected Areas in Communications*, 2023, 41: 2592–2608
- 98 Van De Beek J J, Edfors O, Sandell M, et al. On channel estimation in ofdm systems. In: 1995 IEEE 45th Vehicular Technology Conference. Countdown to the Wireless Twenty-First Century. IEEE, 1995, vol. 2, 815–819
- 99 Biguesh M, Gershman A B. Training-based mimo channel estimation: A study of estimator tradeoffs and optimal training signals. *IEEE transactions on signal processing*, 2006, 54: 884–893
- 100 Kewen L, et al. Research of mmse and ls channel estimation in ofdm systems. In: The 2nd international conference on information science and engineering. IEEE, 2010, 2308–2311
- 101 Ye H, Li G Y, Juang B H. Power of deep learning for channel estimation and signal detection in ofdm systems. *IEEE Wireless Communications Letters*, 2017, 7: 114–117
- 102 Khan M N I, Alam M J. Noise reduction algorithm for ls channel estimation in ofdm system. In: 2012 15th International Conference on Computer and Information Technology (ICCIT). IEEE, 2012, 310–315
- 103 Hussein Y S, Alias M Y, Abdulkafi A A. On performance analysis of ls and mmse for channel estimation in vlc systems. In: 2016 IEEE 12th International Colloquium on Signal Processing & Its Applications (CSPA). IEEE, 2016, 204–209
- 104 Khelifi A, Bouallegue R. Performance analysis of ls and lmmse channel estimation techniques for lte downlink systems. *arXiv preprint arXiv:1111.1666*, 2011
- 105 Jin Y, Zhang J, Jin S, et al. Channel estimation for cell-free mmwave massive mimo through deep learning. *IEEE Transactions on Vehicular Technology*, 2019, 68: 10325–10329
- 106 Soltani M, Pourahmadi V, Mirzaei A, et al. Deep learning-based channel estimation. *IEEE Communications Letters*, 2019, 23: 652–655
- 107 He H, Wen C K, Jin S, et al. Deep learning-based channel estimation for beamspace mmwave massive mimo systems. *IEEE Wireless Communications Letters*, 2018, 7: 852–855
- 108 Gao X, Jin S, Wen C K, et al. Comnet: Combination of deep learning and expert knowledge in ofdm receivers. *IEEE Commun. Lett.*, 2018, 22: 2627–2630
- 109 Pihlajasalo J, Korpi D, Honkala M, et al. Deep learning based ofdm physical-layer receiver for extreme mobility. In: 2021 55th Asilomar Conference on Signals, Systems, and Computers. 2021, 395–399
- 110 Mendonça M O K, Diniz P S R. Ofdm receiver using deep learning: Redundancy issues. In: 2020 28th European Signal Processing Conference (EUSIPCO). 2021, 1687–1691
- 111 Chen W, Tang Z. Research on improved receiver of noma-ofdm signal based on deep learning. In: 2021 International Conference on Communications, Information System and Computer Engineering (CISCE). 2021, 173–177
- 112 Balevi E, Andrews J G. One-bit ofdm receivers via deep learning. *IEEE Transactions on Communications*, 2019, 67: 4326–4336
- 113 Wang B, Xu K, Song P, et al. A deep learning-based intelligent receiver for ofdm. In: 2021 IEEE 18th International Conference on Mobile Ad Hoc and Smart Systems (MASS). 2021, 562–563
- 114 An Y, Wu Z, Chunyang T. Performance of ofdm system receiver based on deep learning. In: 2021 International Conference on Intelligent Transportation, Big Data & Smart City (ICITBS). 2021, 571–574
- 115 Imt-2030 propellant group. vlsi mimo technology research report. 2022
- 116 Hussain M, Michelusi N. Throughput optimal beam alignment in millimeter wave networks. In: 2017 Information Theory and Applications Workshop (ITA). 2017, 1–6
- 117 Jeong C, Park J, Yu H. Random access in millimeter-wave beamforming cellular networks: issues and approaches. *IEEE Communications Magazine*, 2015, 53: 180–185
- 118 Heng Y, Mo J, Andrews J G. Learning site-specific probing beams for fast mmwave beam alignment. *IEEE Transactions on Wireless Communications*, 2022, 21: 5785–5800
- 119 Zhu D, Choi J, Cheng Q, et al. High-resolution angle tracking for mobile wideband millimeter-wave systems with antenna array calibration. *IEEE Transactions on Wireless Communications*, 2018, 17: 7173–7189
- 120 Jayaprakasam S, Ma X, Choi J W, et al. Robust beam-tracking for mmwave mobile communications. *IEEE Communications Letters*, 2017, 21: 2654–2657
- 121 Giordani M, Mezzavilla M, Barati C N, et al. Comparative analysis of initial access techniques in 5G mmwave cellular networks. In: 2016 Annual Conference on Information Science and Systems (CISS). 2016, 268–273
- 122 Yu H, Guan P, Qu W, et al. An improved beam training scheme under hierarchical codebook. *IEEE Access*, 2020, 8: 53627–53635
- 123 Cui Q, Zhang Z, Shi Y, et al. Dynamic multichannel access based on deep reinforcement learning in distributed wireless

- networks. *IEEE Systems Journal*, 2022, 16: 5831–5834
- 124 Gao Z, Dai L, Wang Z, et al. Spatially common sparsity based adaptive channel estimation and feedback for fdd massive mimo. *IEEE Transactions on Signal Processing*, 2015, 63: 6169–6183
- 125 Lv Z, Li Y. A channel state information feedback algorithm for massive mimo systems. *IEEE Communications Letters*, 2016, 20: 1461–1464
- 126 Li J, Zhang Q, Xin X, et al. Deep learning-based massive mimo csi feedback. In: 2019 18th International Conference on Optical Communications and Networks (ICOON). 2019, 1–3
- 127 Guo J, Wen C K, Jin S, et al. Convolutional neural network-based multiple-rate compressive sensing for massive mimo csi feedback: Design, simulation, and analysis. *IEEE Transactions on Wireless Communications*, 2020, 19: 2827–2840
- 128 Wang Y, Sun J, Wang J, et al. Multi-rate compression for downlink CSI based on transfer learning in FDD massive MIMO systems. In: 2021 IEEE 94th Vehicular Technology Conference (VTC2021-Fall). 2021, 1–5
- 129 Zhang Y, Zhang X, Liu Y. Deep learning based csi compression and quantization with high compression ratios in fdd massive mimo systems. *IEEE Wireless Commun. Lett.*, 2021, 10: 2101–2105
- 130 Liang P, Fan J, Shen W, et al. Deep learning and compressive sensing-based csi feedback in fdd massive mimo systems. *IEEE Trans. Veh. Technol.*, 2020, 69: 9217–9222
- 131 Yu X, Li X, Wu H, et al. Ds-nlcsinet: Exploiting non-local neural networks for massive mimo csi feedback. *IEEE Commun. Lett.*, 2020, 24: 2790–2794
- 132 Lu Z, Wang J, Song J. Multi-resolution csi feedback with deep learning in massive mimo system. In: ICC 2020 - 2020 IEEE International Conference on Communications (ICC). 2020, 1–6
- 133 Zhang S. An overview of network slicing for 5G. *IEEE Wireless Communications*, 2019, 26: 111–117
- 134 Pu L, Cui Q, I X L, et al. Federated learning-based heterogeneous load prediction and slicing for 5G systems and beyond. In: GLOBECOM 2022 - 2022 IEEE Global Communications Conference. 2022, 166–172
- 135 Lyu X, Li Y, He Y, et al. Objective-driven differentiable optimization of traffic prediction and resource allocation for split AI inference edge networks. *IEEE Transactions on Machine Learning in Communications and Networking*, 2024, 2: 1178–1192
- 136 Chen X, Li Z, Ni W, et al. Towards dynamic resource allocation and client scheduling in hierarchical federated learning: A two-phase deep reinforcement learning approach. *IEEE Transactions on Communications*, 2024: 1–1
- 137 Foukas X, Patounas G, Elmokashfi A, et al. Network slicing in 5G: Survey and challenges. *IEEE communications magazine*, 2017, 55: 94–100
- 138 Wu W, Zhou C, Li M, et al. AI-native network slicing for 6G networks. *IEEE Wireless Communications*, 2022, 29: 96–103
- 139 Bega D, Gramaglia M, Garcia-Saavedra A, et al. Network slicing meets artificial intelligence: An AI-based framework for slice management. *IEEE Communications Magazine*, 2020, 58: 32–38
- 140 Vassilaras S, Gkatzikis L, Liakopoulos N, et al. The algorithmic aspects of network slicing. *IEEE Communications Magazine*, 2017, 55: 112–119
- 141 Sayed A H, Yousef N R. *Wireless location*, 2003
- 142 Liu J, Jain R. Survey of wireless based indoor localization technologies. Department of Science & Engineering, Washington University, 2014
- 143 Luan N, Xiong K, Zhang Y, et al. 6G: Typical applications, key technologies and challenges. *Chin. J. Internet Things*, 2022, 6: 29–42
- 144 Shan L, et al. Outdoor positioning technology based on telecom data. *Computer Engineering & Science*, 2018, 40: 649
- 145 Fan J, Mu D, Liu Y. Research on network traffic prediction model based on neural network. In: 2019 2nd International Conference on Information Systems and Computer Aided Education (ICISCAE). 2019, 554–557
- 146 Geraldine R, Goncalves A, Lai T, et al. Uav-based situational awareness system using deep learning. *IEEE access*, 2019, 7: 122583–122594
- 147 Abdallah S, Lesser V. Multiagent reinforcement learning and self-organization in a network of agents. In: Proceedings of the 6th international joint conference on Autonomous agents and multiagent systems. 2007, 1–8
- 148 Amiri R, Almasi M A, Andrews J G, et al. Reinforcement learning for self organization and power control of two-tier heterogeneous networks. *IEEE Transactions on Wireless Communications*, 2019, 18: 3933–3947
- 149 Lytras M, Visvizi A, Zhang X, et al. Cognitive computing, big data analytics and data driven industrial marketing, 2020
- 150 Liu G, Zhang H, Tong Z, et al. 6G Mobile Information Network Architecture: Migrate from Communication to XaaS. *Sci. China Inform. Sci.*, 2024, 54: 1236–1266
- 151 China Telecom Research Institute. 6G Vision and Technology White Paper. 2022
- 152 China Unicom Research Institute. China Unicom 6G White Paper. 2021
- 153 Wu J, Deng J, Peng C, et al. Task-centered 6G network AI architecture. *Radio Communications Technology*, 2022, 48: 599–613
- 154 CICT, DTmobile. Full Coverage, Scene Intelligence-6G Vision and Technology Trends White Paper. 2020
- 155 CICT, CICT Mobile. Full coverage, scene intelligence-6G network architecture white paper. 2022
- 156 OPPO Research Institute. 6G AI-cube intelligent network (white paper). 2021. <https://www.oppo.com/content/dam/oppo/cn/mkt/newsroom/press/455/whitepaper.pdf>
- 157 IMT-2030 (6G) promotion group. 6G network architecture outlook white paper. 2023. <https://www.imt2030.org.cn/html/default/zhongwen/chengguofabu/baipishu/index.html?index=2>
- 158 Ericsson. 6G – Connecting a Cyber-Physical World (white paper). 2022. <https://www.ericsson.com/en/reports-and-papers/white-papers/a-research-outlook-towards-6g>
- 159 Hoydis J, Aoudia F A, Valcarce A, et al. Toward a 6G AI-native air interface. *IEEE Communications Magazine*, 2021, 59: 76–81
- 160 Zhang P, Niu K, Tian H, et al. Technology Prospect of 6G Mobile Communications. *Journal on Communications*, 2019, 40: 141–148
- 161 Beijing University of Posts and Telecommunications. 6G Green Wireless Access Network White Paper for Multi-Dimensional Stereo and Full Scenarios. 2023
- 162 Southeast University, Purple Mountain Laboratories. 6G Research White Paper. 2020
- 163 Zhang L, Liang Y C, Niyato D. 6G Visions: Mobile Ultra-Broadband, Super Internet-of-Things, and Artificial Intelligence. *China Commun.*, 2019, 16: 1–14
- 164 Wu J, Li R, An X, et al. Toward Native Artificial Intelligence in 6G Networks: System Design, Architectures, and Paradigms. 2021. <https://arxiv.org/pdf/2103.02823>
- 165 Hu X, Wang L, Wong K K, et al. Edge and Central Cloud Computing: A Perfect Pairing for High Energy Efficiency and

- Low-Latency. *IEEE Transactions on Wireless Communications*, 2019, 19: 1070–1083
- 166 Yang Y, Ma M, Wu H, et al. 6G network AI architecture for everyone-centric customized services. *IEEE Network*, 2022, 37: 71–80
- 167 Cui Q, Zhang X, Ni W, et al. Edge intelligence for beyond 5G networks: Edge intelligence-empowered, unified authentication and trust evaluation for heterogeneous B5G systems. *IEEE Wireless Commun.*, 2021, 28: 78–85
- 168 Luo H, Zhang T, Zhao C, et al. Integrated Sensing and Communications Framework for 6G Networks. 2024. <https://arxiv.org/pdf/2405.19925>
- 169 Lu Y, Maharjan S, Zhang Y. Adaptive edge association for wireless digital twin networks in 6G. *IEEE Internet of Things Journal*, 2021, 8: 16219–16230
- 170 Taleb T, Aguiar R L, Grida Ben Yahia I, et al. White Paper on 6G Networking. 6G Re-search Visions, No. 6. University of Oulu., 2020. <http://urn.fi/urn:isbn:9789526226842>
- 171 6G Alliance of Network AI (6GANA). 6G data service concept and requirements white paper. 2022. <https://www.6g-ana.com/upload/file/20220523/6378893028172687311971492.pdf>
- 172 6G Alliance of Network AI (6GANA). 6G network AI concept and terminology white paper. 2022. <https://www.6g-ana.com/upload/file/20220523/6378893017578935554735081.pdf>
- 173 Lyu X, Ren C, Ni W, et al. Distributed online learning of cooperative caching in edge cloud. *IEEE Transactions on Mobile Computing*, 2021, 20: 2550–2562
- 174 Liu Y, Zhang W, Li L, et al. Toward autonomous trusted networks-from digital twin perspective. *IEEE Network*, 2024
- 175 NGMN. 6G Requirements and Design Considerations (white paper). Feb. 2023. https://www.ngmn.org/wp-content/uploads/NGMN_6G_Requirements_and_Design_Considerations.pdf
- 176 Cui Q, Zhu Z, Ni W, et al. Edge-intelligence-empowered, unified authentication and trust evaluation for heterogeneous beyond 5G systems. *IEEE Wireless Communications*, 2021, 28: 78–85
- 177 Li K, Cui Q, Zhu Z, et al. Lightweight, privacy-preserving handover authentication for integrated terrestrial-satellite networks. In: ICC 2022-IEEE International Conference on Communications. IEEE, Seoul, Korea, 2022, 25–31
- 178 Hu S, Chen X, Ni W, et al. Distributed machine learning for wireless communication networks: Techniques, architectures, and applications. *IEEE Commun. Surveys Tutorials*, 2021, 23: 1458–1493
- 179 6G Alliance of Network AI (6GANA). White paper on native AI technology requirements of 6G network. 2022. <https://www.6g-ana.com/upload/file/20220523/6378893017730497434706068.pdf>
- 180 Nevrateki T, Iliadou A, Ntolkeras G, et al. A survey on federated learning applications in healthcare, finance, and data privacy/data security. In: AIP Conference Proceedings. AIP Publishing, 2023, vol. 2909
- 181 Passerat-Palmbach J, Farnan T, McCoy M, et al. Blockchain-orchestrated machine learning for privacy preserving federated learning in electronic health data. In: 2020 IEEE international conference on blockchain (Blockchain). IEEE, 2020, 550–555
- 182 Polap D, Srivastava G, Yu K. Agent architecture of an intelligent medical system based on federated learning and blockchain technology. *Journal of Information Security and Applications*, 2021, 58: 102748
- 183 Fallah A, Mokhtari A, Ozdaglar A. Personalized federated learning with theoretical guarantees: A model-agnostic meta-learning approach. *Advances in neural information processing systems*, 2020, 33: 3557–3568
- 184 Tan A Z, Yu H, Cui L, et al. Towards personalized federated learning. *IEEE transactions on neural networks and learning systems*, 2022, 34: 9587–9603
- 185 Kevin I, Wang K, Zhou X, et al. Federated transfer learning based cross-domain prediction for smart manufacturing. *IEEE Transactions on Industrial Informatics*, 2021, 18: 4088–4096
- 186 Liu Y, Kang Y, Zou T, et al. Vertical federated learning: Concepts, advances, and challenges. *IEEE Transactions on Knowledge and Data Engineering*, 2024
- 187 Zhang J, Jiang Y. A vertical federation recommendation method based on clustering and latent factor model. In: 2021 International Conference on Electronic Information Engineering and Computer Science (EIECS). IEEE, 2021, 362–366
- 188 Tang F, Liang S, Ling G, et al. Ihvfl: a privacy-enhanced intention-hiding vertical federated learning framework for medical data. *Cybersecurity*, 2023, 6: 37
- 189 Yuan X, Chen J, Yang J, et al. Fedstn: Graph representation driven federated learning for edge computing enabled urban traffic flow prediction. *IEEE Transactions on Intelligent Transportation Systems*, 2022, 24: 8738–8748
- 190 Chu T, Wang J, Codecà L, et al. Multi-agent deep reinforcement learning for large-scale traffic signal control. *IEEE transactions on intelligent transportation systems*, 2019, 21: 1086–1095
- 191 Wu T, Zhou P, Liu K, et al. Multi-agent deep reinforcement learning for urban traffic light control in vehicular networks. *IEEE Transactions on Vehicular Technology*, 2020, 69: 8243–8256
- 192 Zhou T, Tang D, Zhu H, et al. Multi-agent reinforcement learning for online scheduling in smart factories. *Robotics and computer-integrated Manufacturing*, 2021, 72: 102202
- 193 Cao Z, Zhou P, Li R, et al. Multiagent deep reinforcement learning for joint multichannel access and task offloading of mobile-edge computing in industry 4.0. *IEEE Internet of Things Journal*, 2020, 7: 6201–6213
- 194 Shalev-Shwartz S, Shammah S, Shashua A. Safe, multi-agent, reinforcement learning for autonomous driving. <https://arxiv.org/abs/1610.03295>
- 195 Palanisamy P. Multi-agent connected autonomous driving using deep reinforcement learning. In: 2020 International Joint Conference on Neural Networks (IJCNN). IEEE, 2020, 1–7
- 196 Vepakomma P, Gupta O, Swedish T, et al. Split learning for health: Distributed deep learning without sharing raw patient data. <https://arxiv.org/abs/1812.00564>
- 197 Chen M, Gündüz D, Huang K, et al. Distributed learning in wireless networks: Recent progress and future challenges. *IEEE Journal on Selected Areas in Communications*, 2021, 39: 3579–3605
- 198 Nguyen H X, Trestian R, To D, et al. Digital twin for 5G and beyond. *IEEE Communications Magazine*, 2021, 59: 10–15
- 199 Grieves M W. Product lifecycle management: the new paradigm for enterprises. *International Journal of Product Development*, 2005, 2: 71–84
- 200 Tao F, Zhang H, Liu A, et al. Digital twin in industry: State-of-the-art. *IEEE Transactions on industrial informatics*, 2018, 15: 2405–2415
- 201 Barricelli B R, Casiraghi E, Fogli D. A survey on digital twin: Definitions, characteristics, applications, and design implications. *IEEE access*, 2019, 7: 167653–167671
- 202 Li Z, Duan M, Xiao B, et al. A novel anomaly detection method for digital twin data using deconvolution operation with attention mechanism. *IEEE Transactions on Industrial Informatics*, 2022, 19: 7278–7286
- 203 Qin B, Pan H, Dai Y, et al. Machine and deep learning for digital twin networks: A survey. *IEEE Internet of Things*

- Journal, 2024
- 204 Wu X, Lian W, Zhou M, et al. A digital twin-based fault diagnosis framework for bogies of high-speed trains. *IEEE Journal of Radio Frequency Identification*, 2022, 7: 203–207
- 205 Cui C, Ma Y, Cao X, et al. Human-autonomy teaming on autonomous vehicles with large language model-enabled human digital twins. In: 2023 IEEE/ACM Symposium on Edge Computing (SEC). IEEE, 2023, 319–324
- 206 Lu Y, Maharjan S, Zhang Y. Adaptive edge association for wireless digital twin networks in 6G. *IEEE Internet of Things Journal*, 2021, 8: 16219–16230
- 207 Liu T, Tang L, Wang W, et al. Digital-twin-assisted task offloading based on edge collaboration in the digital twin edge network. *IEEE Internet of Things Journal*, 2021, 9: 1427–1444
- 208 Huang Z, Li D, Cai J, et al. Collective reinforcement learning based resource allocation for digital twin service in 6G networks. *Journal of Network and Computer Applications*, 2023, 217: 103697
- 209 Wang J, Zhang J, Zhang Y, et al. Towards 6G digital twin channel using radio environment knowledge pool. <https://arxiv.org/abs/2312.10287>
- 210 Wang H, Zhang J, Nie G, et al. Digital twin channel for 6G: Concepts, architectures and potential applications. <https://arxiv.org/abs/2403.12467>
- 211 Nie G, Zhang J, Zhang Y, et al. A predictive 6G network with environment sensing enhancement: From radio wave propagation perspective. *China Commun.*, 2022, 19: 105–122
- 212 Miao Y, Zhang Y, Zhang J, et al. Demo abstract: Predictive radio environment for digital twin communication platform via enhanced sensing. In: IEEE INFOCOM 2023-IEEE Conference on Computer Communications Workshops (INFOCOM WKSHPS). IEEE, 2023, 1–2
- 213 Zhang J. The interdisciplinary research of big data and wireless channel: A cluster-nuclei based channel model. *China Commun.*, 2016, 13: 14–26
- 214 Wang J, Zhang J, Sun Y, et al. Electromagnetic wave property inspired radio environment knowledge construction and AI-based verification for 6G digital twin channel. <https://arxiv.org/abs/2406.00690>
- 215 Van Huynh D, Nguyen V D, Khosravirad S R, et al. Ullc edge networks with joint optimal user association, task offloading and resource allocation: A digital twin approach. *IEEE Transactions on Communications*, 2022, 70: 7669–7682
- 216 Khan L U, Han Z, Saad W, et al. Digital twin of wireless systems: Overview, taxonomy, challenges, and opportunities. *IEEE Communications Surveys & Tutorials*, 2022, 24: 2230–2254
- 217 Lu Y, Huang X, Zhang K, et al. Communication-efficient federated learning and permissioned blockchain for digital twin edge networks. *IEEE Internet of Things Journal*, 2020, 8: 2276–2288
- 218 Hu C, Fan W, Zeng E, et al. Digital twin-assisted real-time traffic data prediction method for 5G-enabled internet of vehicles. *IEEE Transactions on Industrial Informatics*, 2021, 18: 2811–2819
- 219 Zhang K, Cao J, Zhang Y. Adaptive digital twin and multiagent deep reinforcement learning for vehicular edge computing and networks. *IEEE Transactions on Industrial Informatics*, 2021, 18: 1405–1413
- 220 Chen D, Lv Z. Artificial intelligence enabled digital twins for training autonomous cars. *Internet of Things and Cyber-Physical Systems*, 2022, 2: 31–41
- 221 Liu K, Xu X, Dai P, et al. Cooperative sensing and uploading for quality-cost tradeoff of digital twins in vec. *IEEE Transactions on Consumer Electronics*, 2023
- 222 IMT-2030 (6G) Promotion Group. 6G network architecture vision and key technology outlook white paper. 2021. <https://www.imt2030.org.cn/>
- 223 Yukun S, Bo L, Juniin L, et al. Computing power network: A survey. *China Commun.*, 2024
- 224 Qingmin J, Kai G, Xiaomao Z, et al. Design and discussion for new computing power network architecture. *Information and Communications Technology and Policy*, 2022, 48: 18
- 225 YAO H, GENG L. Trend of next generation network architecture: computing and networking convergence evolution. *Telecommunications Science*, 2019, 35: 38–43
- 226 Tang X, Cao C, Wang Y, et al. Computing power network: The architecture of convergence of computing and networking towards 6G requirement. *China Commun.*, 2021, 18: 175–185
- 227 Wang X, Ren X, Qiu C, et al. Net-in-AI: A computing-power networking framework with adaptability, flexibility, and profitability for ubiquitous AI. *IEEE Network*, 2020, 35: 280–288
- 228 Tokusashi Y, Dang H T, Pedone F, et al. The case for in-network computing on demand. In: *Proceedings of the Fourteenth EuroSys Conference 2019*. 2019, 1–16
- 229 Ren X, Qiu C, Wang X, et al. AI-bazaar: A cloud-edge computing power trading framework for ubiquitous AI services. *IEEE Transactions on Cloud Computing*, 2022, 11: 2337–2348
- 230 Liu J, Sun Y, Su J, et al. Computing power network: A testbed and applications with edge intelligence. In: *IEEE INFOCOM 2022-IEEE Conference on Computer Communications Workshops (INFOCOM WKSHPS)*. IEEE, 2022, 1–2
- 231 Mingxuan L, Chang C, Xiongyan T, et al. Research on edge resource scheduling solutions for computing power network. *Frontiers of Data and Computing*, 2020, 2: 80–91
- 232 Chen Q, Yang C, Lan S, et al. Two-stage evolutionary search for efficient task offloading in edge computing power networks. *IEEE Internet of Things Journal*, 2024
- 233 Sodhro A H, Sodhro G H, Guizani M, et al. AI-enabled reliable channel modeling architecture for fog computing vehicular networks. *IEEE Wireless Communications*, 2020, 27: 14–21
- 234 Deng C, Fang X, Wang X. Uav-enabled mobile-edge computing for AI applications: Joint model decision, resource allocation, and trajectory optimization. *IEEE Internet of Things Journal*, 2022, 10: 5662–5675
- 235 Yao A C. Protocols for secure computations. In: *23rd annual symposium on foundations of computer science (sfcs 1982)*. IEEE, 1982, 160–164
- 236 Shamir A. How to share a secret. *Communications of the ACM*, 1979, 22: 612–613
- 237 Haque A, Heath D, Kolesnikov V, et al. Garbled circuits with sublinear evaluator. In: *Annual International Conference on the Theory and Applications of Cryptographic Techniques*. Springer, 2022, 37–64
- 238 Lindell Y, Pinkas B. A proof of security of yao’s protocol for two-party computation. *Journal of cryptology*, 2009, 22: 161–188
- 239 Acar A, Aksu H, Uluagac A S, et al. A survey on homomorphic encryption schemes: Theory and implementation. *ACM Computing Surveys (Csur)*, 2018, 51: 1–35
- 240 Wang R, Lai J, Zhang Z, et al. Privacy-preserving federated learning for internet of medical things under edge computing. *IEEE journal of biomedical and health informatics*, 2022, 27: 854–865

- 241 Song J, Wang W, Gadekallu T R, et al. Eppda: An efficient privacy-preserving data aggregation federated learning scheme. *IEEE Transactions on Network Science and Engineering*, 2022, 10: 3047–3057
- 242 Zhu H, Goh R S M, Ng W K. Privacy-preserving weighted federated learning within the secret sharing framework. *IEEE Access*, 2020, 8: 198275–198284
- 243 Ku H, Susilo W, Zhang Y, et al. Privacy-preserving federated learning in medical diagnosis with homomorphic re-encryption. *Computer Standards & Interfaces*, 2022, 80: 103583
- 244 Wibawa F, Catak F O, Kuzlu M, et al. Homomorphic encryption and federated learning based privacy-preserving cnn training: Covid-19 detection use-case. In: *Proceedings of the 2022 European Interdisciplinary Cybersecurity Conference*. 2022, 85–90
- 245 Pejic I, Wang R, Liang K. Effect of homomorphic encryption on the performance of training federated learning generative adversarial networks. *arXiv preprint arXiv:2207.00263*, 2022
- 246 Huang A, Liu Y, Chen T, et al. Starfl: Hybrid federated learning architecture for smart urban computing. *ACM Transactions on Intelligent Systems and Technology (TIST)*, 2021, 12: 1–23
- 247 Tang X, Zhu L, Shen M, et al. Secure and trusted collaborative learning based on blockchain for artificial intelligence of things. *IEEE Wireless Communications*, 2022, 29: 14–22
- 248 Reich D, Todoki A, Dowsley R, et al. Privacy-preserving classification of personal text messages with secure multi-party computation. *Advances in Neural Information Processing Systems*, 2019, 32
- 249 Resende A, Railsback D, Dowsley R, et al. Fast privacy-preserving text classification based on secure multiparty computation. *IEEE Transactions on Information Forensics and Security*, 2022, 17: 428–442
- 250 Niu K, Zhang P. A mathematical theory of semantic communication. <https://arxiv.org/abs/2401.13387>
- 251 Zhang P, Xu X, Dong C, et al. Model division multiple access for semantic communications. *Frontiers of Information Technology & Electronic Engineering*, 2023, 24: 801–812
- 252 Yang W, Du H, Liew Z Q, et al. Semantic communications for future internet: Fundamentals, applications, and challenges. *IEEE Communications Surveys & Tutorials*, 2022, 25: 213–250
- 253 Xie H, Qin Z, Li G Y, et al. Deep learning enabled semantic communication systems. *IEEE Transactions on Signal Processing*, 2021, 69: 2663–2675
- 254 Lu K, Li R, Chen X, et al. Reinforcement learning-powered semantic communication via semantic similarity. <https://arxiv.org/abs/2108.12121>
- 255 Jiang P, Wen C K, Jin S, et al. Deep source-channel coding for sentence semantic transmission with harq. *IEEE transactions on communications*, 2022, 70: 5225–5240
- 256 Weng Z, Qin Z. Semantic communication systems for speech transmission. *IEEE Journal on Selected Areas in Communications*, 2021, 39: 2434–2444
- 257 Weng Z, Qin Z, Li G Y. Semantic communications for speech signals. In: *ICC 2021-IEEE International Conference on Communications*. IEEE, 2021, 1–6
- 258 Tong H, Yang Z, Wang S, et al. Federated learning for audio semantic communication. *Frontiers in communications and networks*, 2021, 2: 734402
- 259 Bourtsoulatz E, Kurka D B, Gündüz D. Deep joint source-channel coding for wireless image transmission. *IEEE Transactions on Cognitive Communications and Networking*, 2019, 5: 567–579
- 260 Wang S, Dai J, Liang Z, et al. Wireless deep video semantic transmission. *IEEE Journal on Selected Areas in Communications*, 2022, 41: 214–229
- 261 Yenduri G, Ramalingam M, Selvi G C, et al. Gpt (generative pre-trained transformer)—a comprehensive review on enabling technologies, potential applications, emerging challenges, and future directions. *IEEE Access*, 2024, 12: 54608–54649
- 262 Chowdhury M Z, Shahjalal M, Ahmed S, et al. 6G wireless communication systems: Applications, requirements, technologies, challenges, and research directions. *IEEE Open Journal of the Communications Society*, 2020, 1: 957–975
- 263 Tong W, Peng C, Yang T, et al. Ten issues of netgpt, 2023
- 264 Shao J, Tong J, Wu Q, et al. Wirelessllm: Empowering large language models towards wireless intelligence. 2024
- 265 Zou H, Zhao Q, Tian Y, et al. Telecomgpt: A framework to build telecom-specific large language models, 2024
- 266 Letaief K B, Chen W, Shi Y, et al. The roadmap to 6G – AI empowered wireless networks. *IEEE Communications Magazine*, 2019, 57: 84–90
- 267 Zhang N, Yang P, Ren J, et al. Synergy of big data and 5G wireless networks: Opportunities, approaches, and challenges. *IEEE Wireless Communications*, 2018, 25: 12–18
- 268 Chen Z, Zhang Z, Yang Z. Big AI models for 6G wireless networks: Opportunities, challenges, and research directions. *IEEE Wireless Communications*, 2024: 1–9
- 269 Qian L, Zhu J, Zhang S. Survey of wireless big data. *Journal of Communications and Information Networks*, 2017, 2: 1–18
- 270 Dai H N, Wong C W, Wang H, et al. Big data analytics for large scale wireless networks: Challenges and opportunities. *ACM Computing Surveys*, 2019
- 271 Chen T, Tang Q, Liu G. Efficient task scheduling and resource allocation for AI training services in native AI wireless networks. In: *2023 IEEE International Conference on Communications Workshops (ICC Workshops)*. 2023, 637–642
- 272 Chen Y, Li R, Zhao Z, et al. Netgpt: An AI-native network architecture for provisioning beyond personalized generative services. *IEEE Network*, 2024: 1–1
- 273 Challita U, Ryden H, Tullberg H. When machine learning meets wireless cellular networks: Deployment, challenges, and applications. *IEEE Communications Magazine*, 2020, 58: 12–18
- 274 Singh A. 5G application for methodologies for big data application. In: *2024 IEEE International Conference on Computing, Power and Communication Technologies (IC2PCT)*. 2024, vol. 5, 1071–1075
- 275 Huang Y, Tan J, Liang Y C. Wireless big data: transforming heterogeneous networks to smart networks. *Journal of Communications and Information Networks*, 2017, 2: 19–32
- 276 Mamane A, Fattah M, Ghazi M E, et al. Scheduling algorithms for 5G networks and beyond: Classification and survey. *IEEE Access*, 2022, 10: 51643–51661
- 277 Zhu J, Li R, Ding G, et al. Aoi-based temporal attention graph neural network for popularity prediction and content caching. *IEEE Transactions on Cognitive Communications and Networking*, 2023, 9: 345–358
- 278 Fang C, Hu Z, Meng X, et al. Drl-driven joint task offloading and resource allocation for energy-efficient content delivery in cloud-edge cooperation networks. *IEEE Transactions on Vehicular Technology*, 2023, 72: 16195–16207
- 279 Qiao L, Mashhadi M B, Gao Z, et al. Latency-aware generative semantic communications with pre-trained diffusion models. 2024

- 280 Shin M, Ma J, Mishra A, et al. Wireless network security and interworking. *Proceedings of the IEEE*, 2006, 94: 455–466
- 281 Cui Q, Zhu Z, Ni W, et al. Edge-intelligence-empowered, unified authentication and trust evaluation for heterogeneous beyond 5G systems. *IEEE Wireless Communications*, 2021, 28: 78–85
- 282 IMT-2030. 6G AlaaS requirement research (white paper). 2023. <https://file.imt2030.org.cn/>
- 283 TG1 G. 6G AlaaS requirements whitepaper. 2023. <https://6g-ana.com/>
- 284 Yang Y, Ma M, Wu H, et al. 6G network AI architecture for everyone-centric customized services. *IEEE Network*, 2023, 37: 71–80
- 285 Partarakis N, Zabulis X. A review of immersive technologies, knowledge representation, and AI for human-centered digital experiences. *Electronics*, 2024, 13: 269
- 286 Guo J, Chen H, Song B, et al. Distributed task-oriented communication networks with multimodal semantic relay and edge intelligence. *IEEE Commun. Mag.*, 2024, 62: 82–89
- 287 Benotsmane R, Kovács G, Dudás L. Economic, social impacts and operation of smart factories in industry 4.0 focusing on simulation and artificial intelligence of collaborating robots. *Social Sciences*, 2019, 8: 143
- 288 Santos M A, Munoz R, Olivares R, et al. Online heart monitoring systems on the internet of health things environments: A survey, a reference model and an outlook. *Information Fusion*, 2020, 53: 222–239
- 289 Kirwan C, Zhiyong F. Chapter 1 - evolution of cities/technologies. In: Kirwan C, Zhiyong F, eds., *Smart Cities and Artificial Intelligence*, Elsevier. 2020, 1–24
- 290 Yang Y, Wu J, Chen T, et al. Task-oriented 6G native-AI network architecture. *IEEE Network*, 2024, 38: 219–227
- 291 Nichol A, Achiam J, Schulman J. On first-order meta-learning algorithms. <https://arxiv.org/pdf/1803.02999>
- 292 Wu Y, Ren M, Liao R, et al. Understanding short-horizon bias in stochastic meta-optimization. <https://arxiv.org/pdf/1803.02021>
- 293 Shin J, Lee H B, Gong B, et al. Large-scale meta-learning with continual trajectory shifting. <https://arxiv.org/pdf/2102.07215>
- 294 Dong C, Xiong X, Xue Q, et al. A survey on the network models applied in the industrial network optimization. *Sci. China Inform. Sci.*, 2024, 67: 121301
- 295 Wen C K, Shih W T, Jin S. Deep learning for massive mimo csi feedback. *IEEE Wireless Commun. Lett.*, 2018, 7: 748–751
- 296 Yang R, Zhang Z, Zhang X, et al. Meta-learning for beam prediction in a dual-band communication system. *IEEE Trans. Commun.*, 2023, 71: 145–157
- 297 Yang Y, Gao F, Zhong Z, et al. Deep transfer learning-based downlink channel prediction for FDD massive MIMO systems. *IEEE Trans. Commun.*, 2020, 68: 7485–7497
- 298 Kim H, Choi J, Love D J. Massive MIMO channel prediction via meta-learning and deep denoising: Is a small dataset enough? *IEEE Trans. Wireless Commun.*, 2023, 22: 9278–9290
- 299 Guo Y, Du R, Dong Y, et al. Task-aware adaptive learning for cross-domain few-shot learning. In: 2023 IEEE/CVF International Conference on Computer Vision (ICCV). Paris, France, 2023, 1590–1599
- 300 Hamon R, Junklewitz H, Sanchez I, et al. Robustness and explainability of artificial intelligence. Publications Office of the European Union, 2020, 207: 2020
- 301 Huang D, Gao F, Tao X, et al. Toward semantic communications: Deep learning-based image semantic coding. *IEEE J. Sel. Areas Commun.*, 2022, 41: 55–71
- 302 Zhao B, Cui Q, Liang S, et al. Green concerns in federated learning over 6G. *China Commun.*, 2022, 19: 50–69
- 303 Liu Y J, Feng G, Sun Y, et al. Resource consumption for supporting federated learning enabled network edge intelligence. In: 2022 IEEE International Conference on Communications Workshops (ICC Workshops). Seoul, Korea, 2022, 01–06
- 304 Yang H, Alphones A, Xiong Z, et al. Artificial-intelligence-enabled intelligent 6G networks. *IEEE Networks*, 2020, 34: 272–280
- 305 Zawish M, Dharejo F A, Khowaja S A, et al. AI and 6G into the metaverse: Fundamentals, challenges and future research trends. *IEEE Open Journal of the Communications Society*, 2024, 5: 730–778
- 306 Zawish M, Ashraf N, Ansari R I, et al. Energy-aware AI-driven framework for edge-computing-based IoT applications. *IEEE Internet Things J.*, 2023, 10: 5013–5023
- 307 Li X, Zhang H, Shen Y, et al. Intelligent traffic data transmission and sharing based on optimal gradient adaptive optimization algorithm. *IEEE Transactions on Intelligent Transportation Systems*, 2023, 24: 13330–13340
- 308 Woźniak M, Silka J, Wiczorek M, et al. Recurrent Neural Network Model for IoT and Networking Malware Threat Detection. *IEEE Transactions on Industrial Informatics*, 2021, 17: 5583–5594
- 309 Mao Y, You C, Zhang J, et al. A survey on mobile edge computing: The communication perspective. *IEEE Transactions on Industrial Informatics*, 2017, 19: 2322–2358
- 310 Richart M, Baliosian J, Serrat J, et al. Resource slicing in virtual wireless networks: A survey. *IEEE Transactions on Industrial Informatics*, 2016, 13: 2322–2358
- 311 Vaigandla K K, Venu D N. A survey on future generation wireless communications 5G: Multiple access techniques, physical layer security, beamforming approach. *J. Inf. Comput. Sci.*, 2021, 11: 449–474
- 312 Raja A, Njilla L, Yuan J. Adversarial attacks and defenses toward AI-assisted UAV infrastructure inspection. *IEEE Internet Things J.*, 2022, 9: 23379–23389
- 313 Wei K, Li J, Ding M, et al. Federated learning with differential privacy: Algorithms and performance analysis. *IEEE Transactions on Information Forensics and Security*, 2020, 15: 3454–3469
- 314 Lagendijk R, Erkin Z, Barni M. Encrypted signal processing for privacy protection: Conveying the utility of homomorphic encryption and multiparty computation. *IEEE Signal Processing Magazine*, 2013, 30: 82–105
- 315 Cao Y, Wang H, Lv T, et al. Intelligent reflecting surfaces and next generation wireless systems. <https://arxiv.org/pdf/2402.16453>
- 316 Zhang N, Zhang J, Xing C, et al. Intelligent secure near-field communication. *Sci. China Inform. Sci.*, 2024, 67: 199302
- 317 Zhu G, Lyu Z, Jiao X, et al. Pushing AI to wireless network edge: an overview on integrated sensing, communication, and computation towards 6G. *Sci. China Inform. Sci.*, 2023, 66: 130301
- 318 Li K, Cui Q, Zhu Z, et al. Lightweight, privacy-preserving handover authentication for integrated terrestrial-satellite networks. In: ICC 2022 - IEEE International Conference on Communications. Seoul, Korea, 2022, 25–31