

# FLRONet: Deep Operator Learning for High-Fidelity Fluid Flow Field Reconstruction from Sparse Sensor Measurements

Hiep Vo Dang,<sup>1</sup> Joseph B. Choi,<sup>2</sup> and Phong C. H. Nguyen<sup>3, a)</sup>

<sup>1</sup>*Katz School of Science and Health, Yeshiva University, NY 10016, United States*

<sup>2</sup>*School of Data Science, University of Virginia, VA 22903, United States*

<sup>3</sup>*Faculty of Mechanical Engineering and Mechatronics, Phenikaa University, Hanoi 100000, Vietnam*

(Dated: 31 January 2025)

Reconstructing high-fidelity fluid flow fields from sparse sensor measurements is vital for many science and engineering applications but remains challenging because of dimensional disparities between state and observational spaces. Due to such dimensional differences, the measurement operator becomes ill-conditioned and non-invertible, making the reconstruction of flow fields from sensor measurements extremely difficult. Although sparse optimization and machine learning address the above problems to some extent, questions about their generalization and efficiency remain, particularly regarding the discretization dependence of these models. In this context, deep operator learning offers a better solution as this approach models mappings between infinite-dimensional functional spaces, enabling superior generalization and discretization-independent reconstruction. We introduce FLRONet, a deep operator learning framework that is trained to reconstruct fluid flow fields from sparse sensor measurements. FLRONet employs a branch-trunk network architecture to represent the inverse measurement operator that maps sensor observations to the original flow field, a continuous function of both space and time. Validation performed on the CFD Bench dataset has demonstrated that FLRONet consistently achieves high levels of reconstruction accuracy and robustness, even in scenarios where sensor measurements are inaccurate or missing. Furthermore, the operator learning approach endows FLRONet with the capability to perform zero-shot super-resolution in both spatial and temporal domains, offering a solution for rapid reconstruction of high-fidelity flow fields.

## I. INTRODUCTION

The ability to reconstruct the fluid flow field from limited sensor measurements is of paramount importance in numerous scientific and engineering applications. In this problem, the objective is to reconstruct the high-fidelity flow field  $\mathbf{u}(t)$  from a sparse set of sensor observations  $\mathbf{y}(t)$ . Here, both  $\mathbf{u}(t)$  and  $\mathbf{y}(t)$  are functions of time and return values in  $\mathbb{R}^m$  and  $\mathbb{R}^p$  (with  $m \gg p$ ), respectively. This task is typically difficult due to the distinctive characteristics of the measurement operator  $\mathcal{H} : \mathbb{R}^m \rightarrow \mathbb{R}^p$  that maps a specific state of the flow field  $\mathbf{u}$  at time  $t = \tau$  to its corresponding observations  $\mathbf{y}$ . Due to the large discrepancy between the dimension of  $\mathbb{R}^m$ , *i.e.*, the *state space*, and the dimension of  $\mathbb{R}^p$ , *i.e.*, the *observational space*, the measurement operator  $\mathcal{H}$  is often ill conditioned and thus is noninvertible. Therefore, it is nearly impossible to derive the forward map  $\mathcal{G} : \mathbb{R}^p \rightarrow \mathbb{R}^m$  as the inverse of  $\mathcal{H}$ . For this reason, alternative methodologies such as data-driven approaches<sup>1</sup>, sparse optimization<sup>2</sup>, and data assimilation<sup>3</sup> are frequently adopted. However, despite significant progress reported in the literature, the reconstruction of fluid flow fields from sparse sensor measurements remains a formidable and unresolved challenge.

The emergence of machine learning, particularly deep learning, has significantly advanced research on flow field reconstruction from sparse sensor measurements. Powered by the strong modeling capability of neural networks, deep learning models trained with computational fluid dynamic (CFD) simulation data have been widely employed for field reconstruction. In particular, deep learning has effectively facilitated multiple aspects of the field reconstruction process. For example, it has been employed to directly learn the inverse operator, as evidenced in the works of Erichson *et al.*<sup>1</sup>, Wu *et al.*<sup>4</sup>, and Li *et al.*<sup>5</sup>. In addition, it can be used to provide an efficient representation scheme, also known as the implicit neural representation, which, later, can be used to facilitate the sparse optimization for field reconstruction<sup>6</sup>. Finally, deep learning can also contribute to the data assimilation approach by serving as a prior regression from sensor observations or as a dynamic model for rough predictions.<sup>7</sup>

Research has shown that deep learning reconstruction methods can achieve higher accuracy and computational speeds compared to traditional methods such as modal decomposition or direct numerical simulation. However, the advancement of deep learning in reconstructing flow fields is still constrained by its limited ability to generalize when asked to operate on different discretization schemes. Notably, the majority of methodologies are confined to applicability for a single mesh resolution, necessitating retraining upon the requirement of a different mesh resolution. This presents challenges in two main dimensions. First, the acquisition of high-fidelity fluid flow data is inherently costly, making training for high-fidelity reconstruction a “small data” problem, which may result in inadequate generalization due to overfitting. Second, even when high-fidelity flow field training

<sup>a)</sup>Corresponding author: phong.nguyenconghong@phenikaa-uni.edu.vn

data is accessible, the training expense associated with such a problem is substantial. This increases both the duration of training and the power consumption of the process, making it impractical for application.

For this reason, efforts have shifted toward operator learning, which operates on functional spaces instead of vector spaces as in the case of neural networks. For example, neural operators<sup>8</sup>, an approximation paradigm that operates in functional spaces, have recently been proposed. Notably, neural operators offer discretization-invariant capabilities, meaning they are independent of the chosen mesh system and can achieve zero-shot super-resolution. This is a significant advantage, as engineering data are often provided in non-uniform grid systems that vary depending on the geometry of the domain. Moreover, experimental studies demonstrate that neural operators, with their inductive bias architectures, outperform other deep learning methods in approximating partial differential equation (PDE) solutions and can replace CFD simulations due to their computational efficiency after training<sup>8–13</sup>.

Inspired by the advantages of neural operators, Zhao *et al.*<sup>14</sup> proposed *RecFNO*, a model based on the Fourier Neural Operator (FNO)<sup>13</sup>, for the reconstruction of heat flow fields from sparse sensor measurements. The authors have demonstrated an enhanced reconstruction capability for RecFNO compared to other deep learning methods. Moreover, with the zero-shot super-resolution capability, RecFNO can achieve up to eight times the resolution refinement without retraining. However, while RecFNO’s discretization-independent capability is demonstrated in the spatial domain, this is not guaranteed in the temporal domain. Although 3D FNO models could be applied, their computational efficiency and effectiveness remain inadequate as will be demonstrated later.

The deep operator network (DeepONet)<sup>15</sup> is another approximation framework that has demonstrated notable efficiency in the realm of operator learning. As highlighted by Lu *et al.*<sup>15</sup>, DeepONet extends the universal approximation theorem, which was originally for deep neural networks, to aid in the learning of continuous operators. Specifically, it seeks to learn the operator that correlates discrete observations of the input function to a continuous output function through an architecture akin to the formulation of Green’s function. Since its introduction, DeepONet has been widely applied across a range of disciplines within physical science and engineering. In such applications, DeepONet has exhibited an exceptional proficiency in learning operators that function on continuous domains, characterized by its highly accurate predictions which well adhere to physics laws. Moreover, the architecture of DeepONet is ideally suited to the flow field reconstruction from sparse sensor measurement problem. In the formulation of DeepONet, sensor measurements can serve as discrete observations of the input function, whereas the reconstructed field is typically the continuous output function. In light of this perspective, we hypothesize that the core principles underpinning DeepONet can be employed for the flow field reconstruction problem as the two shares many commonalities in their formulations.

In this work, we introduce FLRONet, a deep operator network that can reconstruct the original fluid flow field from limited sensor observations and is independent of the discretization in both spatial and temporal domains. Given the sensor observation at specific locations in space-time domains, our goal is to reconstruct the original flow fields at any given time within the observation time window. In addition, we also want our field reconstruction to be independent of the discretization in the spatial domain. To achieve such goals, we also employ the DeepONet branch-trunk network architecture with the branch network modeled by the two-dimensional Fourier neural operator (2D-FNO). We show that given sparse sensor measurement at several time points, FLRONet can feature high-accuracy flow field reconstructions that are independent of discretization in both spatial and temporal domains. We also discuss the potential of FLRONet applications in a real-world scenario.

## II. PROBLEM FORMULATION

Our problem formulation is illustrated in Fig. 1. Given a fluid flow system, the state of the flow field is represented as a time-dependent function  $\mathbf{u}(t)$  that returns values in  $\mathbb{R}^m$ . Measurements  $\mathbf{y} \in \mathbb{R}^p$  are acquired at specified discrete-time instances  $\tau_i \in [\tau_0, \tau_1, \dots, \tau_n]$  and taken at  $p$  locations within the fluid domain. This process is represented by a measurement operator  $\mathcal{H} : \mathbb{R}^m \rightarrow \mathbb{R}^p$ :

$$\mathbf{y} = \mathcal{H}[\mathbf{u}].$$

In this formulation,  $\mathbb{R}^m$  is referred to as the state space, while  $\mathbb{R}^p$  is designated as the observational space. Our objective here is to reconstruct the state field  $\mathbf{u}$  from the sparse sensor measurement  $\mathbf{y}$  at a specified time  $t \in [\tau_0, \tau_n]$ . This task is fundamentally equivalent to determining the forward operator  $\mathcal{G} : \mathbb{R}^p \rightarrow \mathbb{R}^m$ , which theoretically is the inverse of the measurement operator  $\mathcal{H} : \mathbb{R}^m \rightarrow \mathbb{R}^p$ :

$$\mathbf{u} = \mathcal{G}[\mathbf{y}] \approx \mathcal{H}^{-1}[\mathbf{y}].$$

In contrast to available methodologies that focus on modeling  $\mathcal{G}$  as a mapping between sensor observations and the state field at a single discrete time point, our approach seeks to incorporate the dynamic properties of fluid flow into the reconstruction

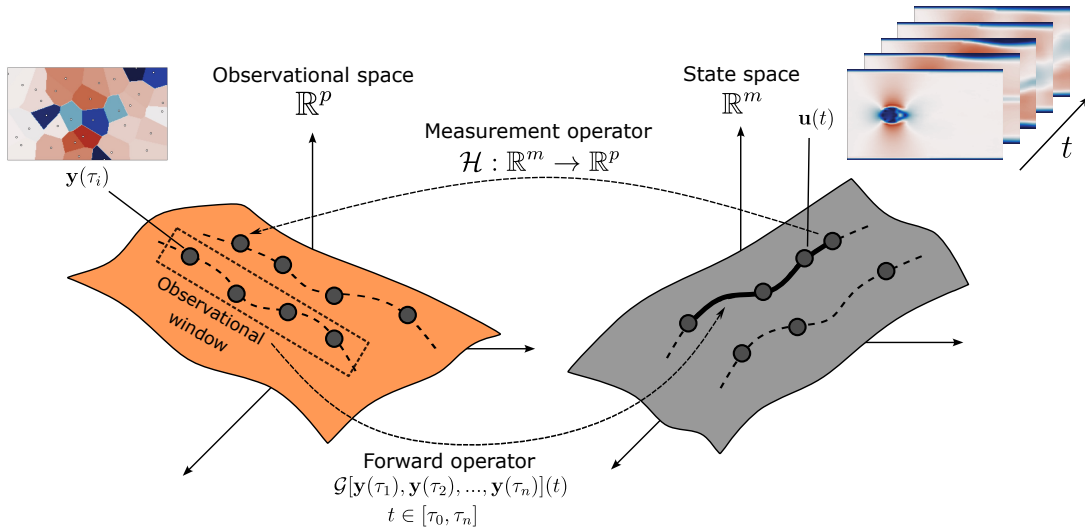

FIG. 1. **Problem formulation of FLRONet.** FLRONet utilize deep operator network to reconstruct the original flow field evolution for a given observation time window  $[\tau_0, \tau_n]$ . The reconstruction is continuous in both spatial and temporal domains.

process. This integration imposes an additional constraint on the learning process, ensuring the integrity of the reconstructed field. Moreover, we also want our reconstructed fields to be independent of the selected discretization settings. Therefore, our objective is to reconstruct the state field  $\mathbf{u}$  given a set of sensor observations at discrete time points  $[\mathbf{y}(\tau_0), \mathbf{y}(\tau_1), \dots, \mathbf{y}(\tau_n)]$  for any given time  $t \in [\tau_0, \tau_n]$ :

$$\mathbf{u}(t) = \mathcal{G}[\mathbf{y}(\tau_1), \mathbf{y}(\tau_2), \dots, \mathbf{y}(\tau_n)](t).$$

with  $\mathbf{u}(t)$  is discretization independent in both space and time. With the above objective and inspired by the deep operator theory of Lu *et al.*<sup>15</sup>, we approximate the operator  $\mathcal{G}$  by a deep operator network for which we named FLRONet.

### III. METHODOLOGY

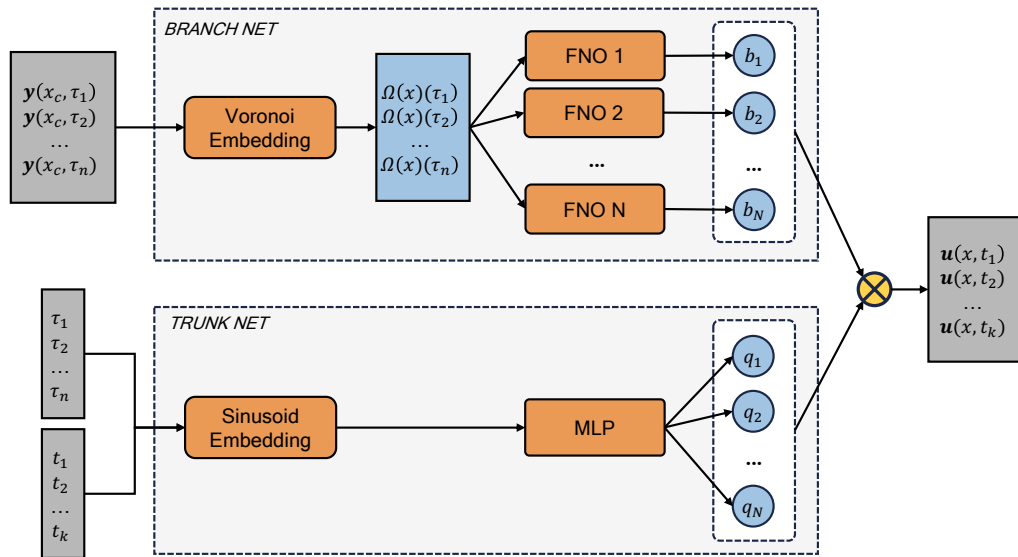

FIG. 2. **Architectural design of FLRONet.** FLRONet employs a branch-trunk network architecture, with 2D Fourier Neural Operators for the branch network and multilayer perceptrons for the trunk. Their results are combined via dot product.

### A. Architecture design

Figure 2 illustrates the architectural framework of FLRONet. FLRONet architecture consists of two separate networks: the branch network and the trunk network. The branch network encodes sensor observations obtained from a range of discrete sampling sites, while the trunk network encodes the temporal domain of the flow field subject to reconstruction. Initially, the branch network processes sensor data collected at  $p$  discrete temporal points, represented as  $\{\tau_0, \tau_1, \dots, \tau_p\}$ , and transforms these into an image-like representation using Voronoi embedding, as detailed in Section III C. Subsequently, these transformed data are processed through  $N$  branch networks, yielding  $N$  output fields. In this study, Fourier neural operators are employed as branch networks<sup>13</sup> to allow FLRONet to achieve resolution-independent spatial domain reconstructions. In parallel, the trunk network processes the data, utilizing both the target temporal parameter for reconstruction and the temporal parameters linked to the sensor observations as input. This input is encoded using a multi-layer perceptron (MLP) architecture, also producing  $N$  output values. The final prediction of the reconstructed flow field is generated by combining the outputs from both the branch and trunk networks through a dot product.

### B. Operator network for spatiotemporal discretization independent

*a. DeepONet with FNO branch net* The primary contribution of our work lies in the ability to reconstruct the evolution of fluid flow fields from sparse sensor measurements that is independent of discretization in both the spatial and temporal domains. This capability is achieved through the implementation of a DeepONet-like architecture. In particular, the forward operator  $\mathcal{G}$  can be modeled as follows:

$$\mathcal{G}(\mathbf{y}(\boldsymbol{\tau}))(\mathbf{t}) = \mathcal{B}(\mathbf{y}(\boldsymbol{\tau})) \otimes \mathcal{T}(\mathbf{t}|\boldsymbol{\tau}). \quad (1)$$

In Eq. 1, the branch network  $\mathcal{B}$  processes sensor measurements  $\mathbf{y}$  at discrete time instances  $\boldsymbol{\tau}$ , while the trunk network  $\mathcal{T}$  receives the target reconstruction time stamp  $\mathbf{t}$  as input, which is conditioned on  $\boldsymbol{\tau}$ , the time stamps at which sensor measurements were taken. This formulation aims to elucidate the relative proximity between the reconstruction time  $\mathbf{t}$  and the observation time  $\boldsymbol{\tau}$ . Outputs of the branch and trunk networks are combined by a fusion operation, denoted by  $\otimes$ , which is merely a product of a dot between two vectors.

In our work, the trunk network  $\mathcal{T}$  is modeled using an MLP with three fully connected layers, preceded by a sinusoidal embedding, denoted  $\Phi$ , to improve the representation of relative temporal positions. The sinusoidal embeddings of the time instances  $\boldsymbol{\tau}$  and the reconstruction time points  $\mathbf{t}$  are combined using a dot product, where the value of the dot product increases in response to temporal proximity. This design allows the trunk network to effectively capture the temporal relationship between sensor inputs and reconstruction targets.

The branch network  $\mathcal{B}$  is designed to mimic the unstacked version of DeepONet<sup>15</sup> to increase the expressive capacity of FLRONet. Although the branch network can be modeled with various architectures, such as U-Net<sup>16</sup> and fully connected networks<sup>15</sup>, in our work, we employ the Fourier Neural Operator (FNO) to attain spatial resolution independence for the reconstructed field.

With this architecture design, Eq. 1 becomes:

$$\mathcal{G}(\mathbf{y}(\boldsymbol{\tau}))(\mathbf{t}) = \langle \text{FNO}[\Omega(\mathbf{y})], \text{MLP}[\Phi(\mathbf{t}) \cdot \Phi(\boldsymbol{\tau})] \rangle \quad (2)$$

where,  $\Omega(\cdot)$  refers to the Voronoi embedding, which is positioned before the FNO blocks to encode sensor measurements, while  $\Phi(\cdot)$  refers to the sinusoidal embedding. Additionally, the fusion operation is executed simply as a dot product  $\langle \cdot, \cdot \rangle$ .

*b. FNO branch net* In this research, a two-dimensional Fourier Neural Operator (FNO) was utilized to model the branch network, enabling the ability to reconstruct flow fields that are independent of spatial resolution. The input for each FNO branch is the sensor measurements obtained at the specified time  $\tau_i$  at which the observations were recorded. This sensor data is processed through the Voronoi embedding layer prior to its utilization as input for the FNO networks. The resulting output field after the Voronoi embedding can be modeled as a function of the spatial coordinates  $\Omega(\mathbf{x})$ , where  $\mathbf{x}$  denotes the spatial coordinate of the query point. Under this framework, the computation conducted within an FNO branch network is delineated as:

$$\text{FNO}(\Omega(x)) = \mathcal{F}^{-1}(\mathcal{F}(\kappa) \cdot \mathcal{F}(\Omega))(x), \quad (3)$$

where  $\kappa$  is the kernel function while  $\mathcal{F}$  and  $\mathcal{F}^{-1}$  are the Fourier transform and its inverse in the spatial domain. By definition, for any function  $f$  defined in the spatial domain  $D$ , the Fourier transform and its inverse are given as:



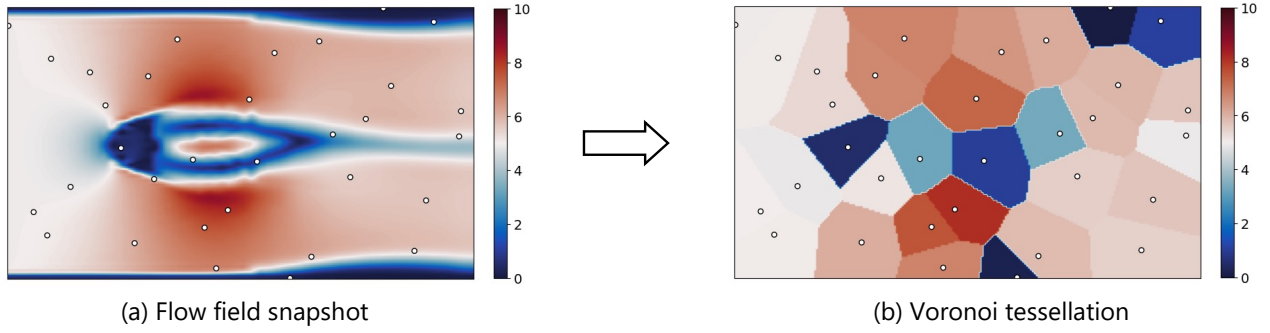

FIG. 3. **Voronoi-Tessellation-Based Embedding:** (a) An original snapshot of the flow field from the CFD dataset, with 32 randomly distributed sensors marked as white dots. (b) The corresponding Voronoi tessellation, computed from sensor locations and field values.

$$(\mathcal{F}f)(k) = \int_D f(x)e^{-2\pi ikx} dx, \quad (\mathcal{F}^{-1}f)(x) = \int_D \mathcal{F}(f)(k)e^{2\pi ikx} dk. \quad (4)$$

Considering that we are restricted to evaluating the value  $\mathbf{u}(x)$  on a finite mesh. Equations 4 can be discretized by the two-dimensional discrete Fourier transform (DFT) and the inverse discrete Fourier transform (IDFT). Assume that the examined domain is discretized into a uniform grid, where  $N_h$  and  $N_w$  are the number of grid points in the vertical and horizontal dimensions, respectively. The two-dimensional DFT and its inverse IDFT for a function  $f$  defined on this grid are given by:

$$\text{DFT}(f)(k_h, k_w) = \sum_{n_h=0}^{N_h-1} \sum_{n_w=0}^{N_w-1} f(n_h\Delta h, n_w\Delta w) e^{-2\pi i \left( \frac{k_h n_h}{N_h} + \frac{k_w n_w}{N_w} \right)}, \quad \text{IDFT}(f)(h, w) = \frac{1}{N_h N_w} \sum_{k_h=0}^{N_h-1} \sum_{k_w=0}^{N_w-1} f(k_h, k_w) e^{2\pi i \left( \frac{k_h h}{N_h} + \frac{k_w w}{N_w} \right)}.$$

Moreover, we adhere to the original parameterization for  $\mathcal{F}(\kappa)$ : Given  $d$  as the embedding dimension, then  $\mathcal{F}(\kappa) = R_\phi \in \mathbb{C}^{k_h \times k_w \times d \times d}$ .

Lastly, one of the main principles of the FNO is that it retains only the low-frequency modes for further processing, while truncating the rest. This principle is based on Parseval's Theorem, which indicates that the low-frequency modes of a function contain the majority of its information, whereas high-frequency modes typically contain redundant details or noise. In this study, we choose  $d = 64$ ; and in the spatial domain of  $(H \times W) = (140 \times 240)$ , we retain up to 24 modes along the vertical dimension ( $k_h = 24$ ) and 48 modes along the horizontal dimension ( $k_w = 48$ ).

### C. Voronoi tessellation for sensor measurements embedding

Traditional regressive field reconstruction methods often represent sensor measurements as vectors<sup>1,17</sup>, restricting the ability of machine learning models to generalize effectively to different sensor settings (e.g., varying sensor locations or layouts). Particularly, this representation scheme omits information about sensor positions, leaving ML models unaware of sensor locations and causing them to struggle to adapt to different sensor configurations, e.g., different sensor position<sup>7</sup>. Several pioneer studies have attempted to apply masked images as a way to encode sensor positions; however, these approaches cannot achieve proper reconstruction accuracy, especially when sensor measurements are sparse. In this work, we used the Voronoi tessellation to encode the sensor measurement information.

Fig. 3 illustrates the Voronoi-tessellation-based embedding method. Given  $n$  sensors located at coordinates  $\mathbf{x}_{ci}$  in the examined domain  $D$ , the Voronoi tessellation divides  $D$  into  $n$  Voronoi cells, denoted as  $V = [V_1, V_2, \dots, V_n]$ . Each Voronoi cell  $V_i$  can be defined as:

$$V_i = \{\mathbf{x} \in D \mid d(\mathbf{x}, \mathbf{x}_{ci}) < d(\mathbf{x}, \mathbf{x}_{cj}), \forall j \neq i\}, \quad (5)$$

where  $\mathbf{x}$  is a grid point in  $V_i$ , and  $d(\cdot, \cdot)$  denotes the Euclidean distance between two points. After the Voronoi tessellation process, all grid points within each Voronoi cell are assigned the sensor value associated with that cell. This results in an embedding field with dimensions similar to those of the state field, which is later used as the input for FLRONet.

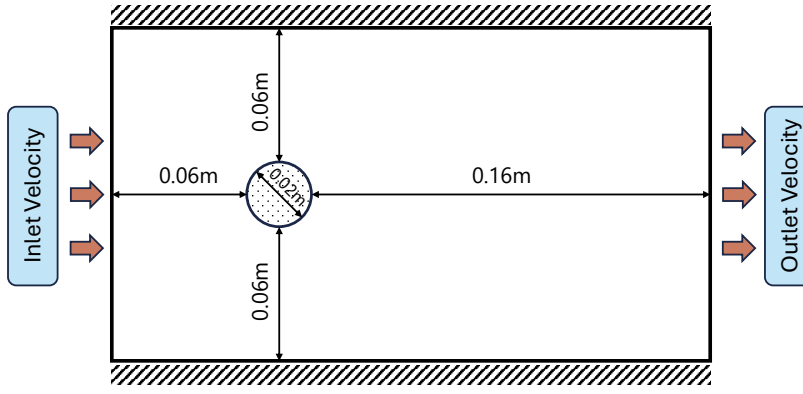

FIG. 4. The geometry of the fluid flow around the circular cylinder problem as described in the CFD dataset.

The specialty of Voronoi tessellation-based embedding lies in the fact that each Voronoi cell is influenced exclusively by its assigned sensor. This assigned sensor determines the values of all grid points within the cell. Moreover, the shape and size of each Voronoi cell are already optimized for its corresponding sensor; therefore, the influence of sensor observations on the value of a particular grid point is properly modeled. Another advantage of applying Voronoi tessellation-based embedding is that it allows the network to easily cope with different sensor configurations (e.g., varying sensor positions or the number of sensors used) without having to modify the architecture of the neural network. This advantage will be demonstrated later in Section IV B when FLRONet has to deal with missing sensor observations.

#### D. Data and Training

We trained FLRONet using the CFDBench cylinder dataset<sup>18</sup>. The dataset contains numerical simulations of fluid flow around a cylindrical obstacle (Fig. 4). The examined domain has a physical size of  $0.14 \times 0.24(m)$ , which is tessellated in a grid of  $140 \times 240$  (pixels). There are 50 simulation cases in the dataset, each having a unique inlet velocity increasing incrementally from 0.1 m/s to 5.0 m/s. For each simulation case, the total simulation time of 1 second is recorded using 1,000 snapshots with the time interval between snapshots being 0.001 (s). For each case, 32 sensors are randomly distributed across the domain to record velocity magnitudes at 32 different locations, providing sparse observations that FLRONet uses as input. Fig. 4 illustrates the dimensions of the examined domain and the sensor layout.

To construct the training data, we created observation windows containing five snapshots of sensor data, with the time interval between two snapshots being 0.005 (s), resulting in a window of 0.02-seconds. With this setup, 980 observation windows were generated for a single simulation case. Within each window, we randomly select a single snapshot to record the velocity field at that time point, which serves as the ground truth for FLRONet. To evaluate generalization, we randomly sampled the 50 simulation cases into two exclusive sets: 45 cases for training and five cases for testing. The training set includes all cases of inlet velocity, except for those specifically reserved for the test set. The test set consists of cases with inlet velocities of 3.5, 3.9, 4.2, 4.6, and 5.0 m/s. FLRONet was trained using the Adam optimizer with a learning rate of  $10^{-3}$ .

#### E. Validation metrics

For the quantitative validation of FLRONet, we used two metrics, namely the root mean squared error (RMSE) and the mean absolute error (MAE). Given  $T$  as the temporal resolution; in particular, the CFD dataset has  $T = 1,000$  (time steps). Denote  $\hat{\mathbf{u}}(t)$  as the reconstructed field at time  $t$ ,  $\mathbf{u}(t)$  is the corresponding ground truth. The derivation of these metrics is defined as follows.

$$\text{RMSE} = \frac{1}{T} \sum_{t=1}^T \|\hat{\mathbf{u}}(t) - \mathbf{u}(t)\|_2, \quad \text{MAE} = \frac{1}{T} \sum_{t=1}^T \|\hat{\mathbf{u}}(t) - \mathbf{u}(t)\|_1, \quad (6)$$

where  $\|\cdot\|_2$  and  $\|\cdot\|_1$  denote the  $\ell_2$ -norm and  $\ell_1$ -norm, respectively, computed over the spatial domain of the flow field at reconstruction time  $t$ .

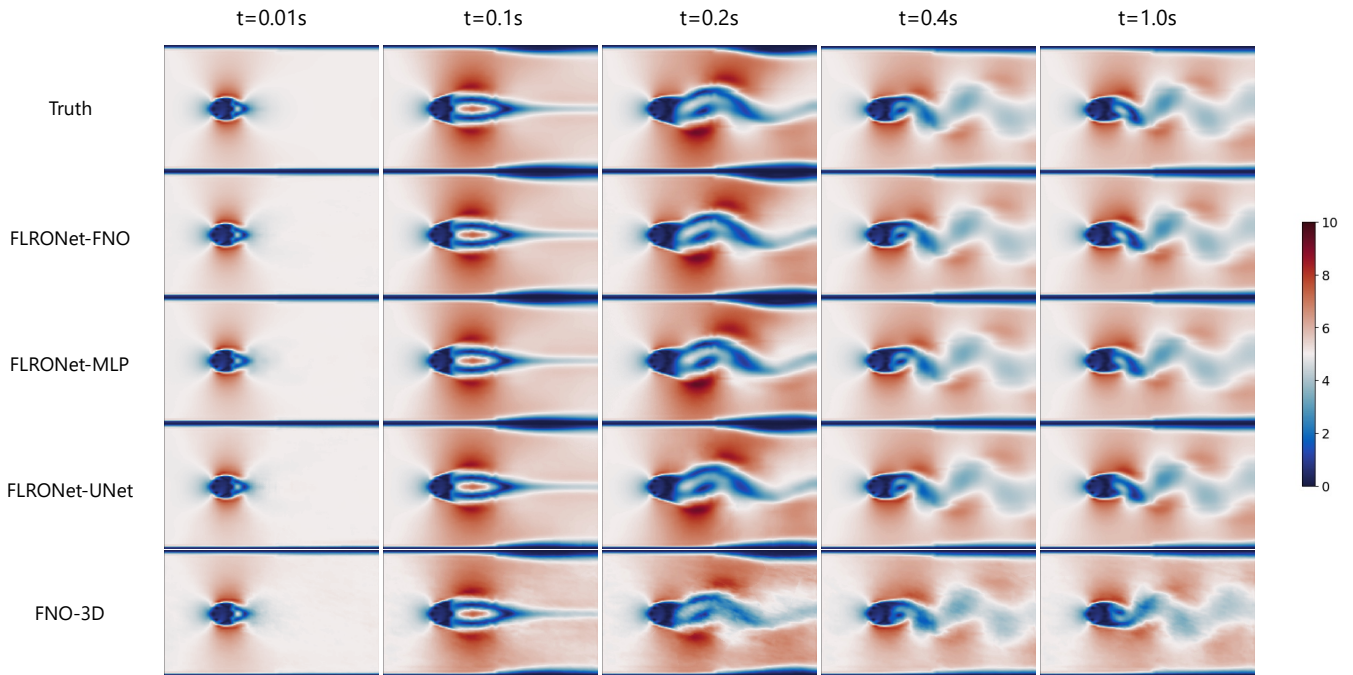

FIG. 5. **Reconstructed fluid flow across architectures for the boundary condition  $v_0 = 3.5$  m/s.** The comparison highlights differences in reconstruction quality, with FLRONet-FNO showing the closest resemblance to the ground truth.

#### IV. RESULTS AND DISCUSSION

We validate our FLRONet on the CFD Bench dataset described in Section III D. For comparison purposes, we compared the reconstruction capability of FLRONet with that of FNO 3D. We also included two additional branch net architectures for FLRONet, namely U-Net (FLRONet-UNet) and MLP (FLRONet-MLP), for comparison purposes. Here, we aim to demonstrate the unique ability of FLRONet with the FNO branch net (FLRONet-FNO) to perform zero-shot super-resolution in both space and time while still exhibiting high reconstruction accuracy compared to other baselines.

##### A. Prediction accuracy

We first validate FLRONet in an ideal condition where all sensor measurements are clean and free of noise. We also assume that FLRONet has data from all sensor observations for reconstruction. Based on this clean and perfect input, we ask FLRONet and other baselines to reconstruct the flow field at the exact time when the sensor data are measured. Fig. 5 shows the reconstructed flow fields, the ground truth from CFD, and the corresponding MAE maps for FLRONet-FNO and other baselines in the case where the inlet velocity is 3.5 m/s, which is not included in the training. Visually, all baselines can capture the overall structure of the flow field. However, it is clear that FLRONet-FNO produces the most accurate reconstructions among all baselines. Its reconstruction fields are closely aligned with the ground truth fields from CFD. In contrast, FNO-3D, the primary competitor of FLRONet-FNO, exhibits significantly noisier reconstructions, particularly at the tail of the vortex shredding feature. Fig. 5 also suggests that the two other FLRONet baselines, FLRONet-MLP and FLRONet-UNet, offer reconstruction capabilities similar to FLRONet-FNO. Their reconstructed fields are visually indistinguishable from those produced by FLRONet-FNO. However, as will be shown in the quantitative analysis, they actually exhibit slightly higher RMSE and MAE values.

The quantitative analysis in Fig. 6 further approves the qualitative validation mentioned above. In this experiment, we measured the average MAE and RMSE of the reconstructed fields of FLRONet across all simulation time steps and compared them with those of other baselines. Here, we tested five inlet velocities, including  $v_0 = 3.5, 3.9, 4.2, 4.6,$  and  $5.0$  m/s. As indicated in Fig. 6, the field reconstructed by FLRONet-FNO is consistently the most accurate, having the lowest reconstructed MAE and RMSE for all inlet velocities; meanwhile, FNO-3D appears to have the highest average reconstructed MAE and RMSE. Other variants of the FLRONet family, FLRONet-UNet and FLRONet-MLP, yield slightly higher reconstruction error compared to FLRONet-FNO, but their accuracy is still higher than FNO-3D.

An important observation we should also point out is that the reconstruction accuracy of all models tends to increase as the inlet velocity increases. This is because when the inlet velocity increases, the overall magnitude of the velocity field increases.

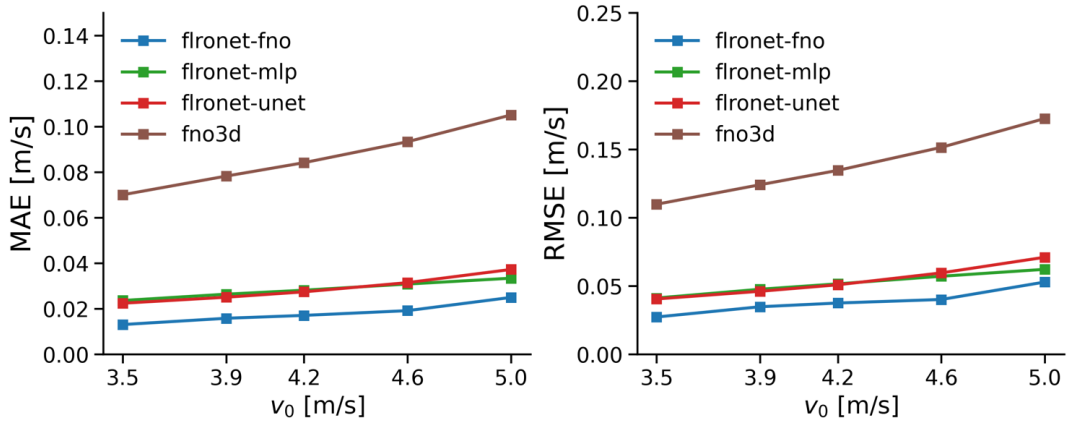

FIG. 6. **Average reconstruction error across unseen inlet velocities.** FLRONet-FNO consistently achieves the lowest error. FLRONet-MLP and FLRONet-UNet perform similarly, with slightly higher errors compared to FLRONet-FNO. FNO-3D shows the highest errors, particularly at higher  $v_0$ .

Therefore, for the same relative reconstruction error, the absolute error (MAE and RMSE) for simulation cases with higher inlet velocities is significantly higher than for those with lower inlet velocities. Furthermore, in the high inlet velocity case, the Reynolds numbers are higher, leading to more unstable and complex flow patterns. These issues lead to difficulties in accurately reconstructing the flow field for high inlet velocity cases, thereby increasing their reconstruction complexity.

## B. Robustness to incomplete sensor measurements

In practice, it is not always possible to acquire all sensor data due to connection loss or sensor malfunction. As a result, machine learning models are required to reconstruct the flow field from incomplete sensor observations. In such scenarios, consistency in the reconstruction accuracy of the model is critical, as it can affect downstream tasks. Therefore, it is crucial to ensure that FLRONet performs consistently even in situations where sensor measurements are incomplete. For this reason, we are now validating FLRONet’s performance in situations where sensor measurements are incomplete. In this experiment, we randomly remove one or a few sensors (up to 20) and measure the accuracy of fields reconstructed by FLRONet and other baselines, as they are required to reconstruct the flow field from the remaining subset of sensors.

Figure 7 shows the performance of the FLONet with different branch nets and FNO-3D in the case of missing sensor observations. The result in Fig. 7 shows a strong resilience to missing sensor data from FLRONet-FNO, FLRONet-UNet and FNO-3D, while FLRONet-MLP is extremely sensitive to missing sensor input. As indicated in Fig. 7, FLRONet-MLP experiences an exponential increase in both RMSE and MAE values as the number of missing sensors increases. In contrast, FLRONet-FNO, FLRONet-UNet, and FNO-3D all maintain robust reconstruction accuracy. Interestingly, all of these models leverage the Voronoi embedding layer to encode input sensor data, which likely contributes to their consistent accuracy under incomplete sensor measurements. Based on sensor coordinates, the Voronoi embedding layer effectively encodes the spatial relationships among the sensors. This allows missing values to be easily interpolated back from their nearest neighbors. This interpolation mechanism acts as a buffer to withstand the degradation of input quality caused by missing data. Conversely, in the case of FLRONet-MLP, there are no mechanisms to incorporate any spatial information from the sensors; therefore, when some sensors are lost, their values are unavoidably dropped to zeros, which severely distorts the reconstruction results.

In addition to the Voronoi embedding’s advantage, Fourier-based methods like FNO-3D and FLRONet-FNO tend to exhibit slower accuracy degradation, making them more resilient to sensor loss. This resilience stems from the fundamental property of Fourier-based approaches, which aim to learn an operator mapping between two functional spaces. These methods treat input data as a continuous function, enabling missing values to be interpolated naturally through the function’s continuity before being fed to the operator. As a result, the distance between the complete sensor input function  $\mathbf{y}(t)$  and the incomplete sensor input function  $\mathbf{y}'(t)$  remains small.

## C. Robustness to Imprecise Sensor Measurements

In addition to the potential for missing data due to sensor connection loss, sensor measurements are also often subjected to noise from hardware limitations or environmental factors. In this case, machine learning models are required to have the

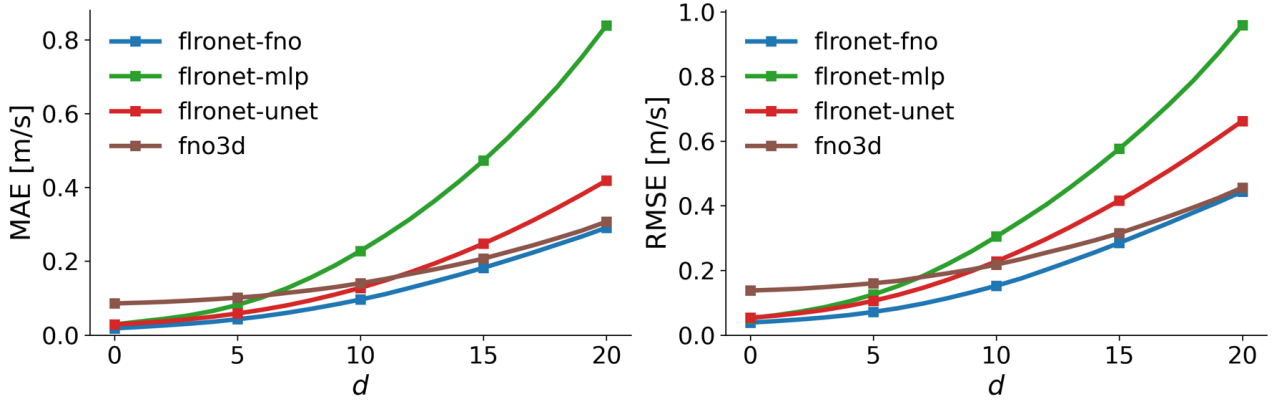

FIG. 7. **Reconstruction performance under different numbers of lost sensors.** The figure shows the MAE and RMSE of FLRONet-based models and FNO-3D as the number of lost sensors,  $d$ , increases from 0 to 20. FLRONet-FNO and FNO-3D handle sensor loss effectively, showing minimal error increase. FLRONet-UNet performs well for small  $d$  but degrades gradually as  $d > 5$ . FLRONet-MLP delivers the poorest performance, with a steep error increase due to its lack of spatial interpolation capabilities.

capability to handle such imperfections in the input data. Also, a model that can handle noise and is robust is more useful than one that is sensitive to noise because it makes more reliable predictions, especially when the data quality is poor, such as in the case of using cheap sensors or in harsh environments.

In this experiment, we evaluated the resilience of FLRONet and other baselines to varying intensities of noise applied to sensor measurements. Here we assume that the error in sensor measurements follows a Gaussian distribution. Specifically, Gaussian noise  $\xi \in \mathbb{R}^p$  is added to sensor observation  $\mathbf{y} \in \mathbb{R}^p$  by the following equation:

$$\mathbf{y} \leftarrow \mathbf{y} + \xi, \quad \xi_i \sim \mathcal{N}(0, (\varepsilon|\mathbf{y}_i|)^2), \quad \forall i \in \{1, \dots, p\}, \quad (7)$$

where:

$\mathbf{y}_i$ : The velocity field measurement of the  $i$ -th sensor.

$\xi_i$ : Independent Gaussian noise applied to the sensor  $i$ , with a mean of 0 and variance  $(\varepsilon|\mathbf{y}_i|)^2$ .

$\varepsilon \geq 0$ : The noise level, which controls the magnitude of the noise relative to the measurement.

With the above formulation, we create a controlled environment to assess the resilience of each model to different levels of noise simply by adjusting  $\varepsilon$ . The standard deviation of the Gaussian noise, which is proportional to the magnitude of the sensor observation, ensures that the perturbations scale with the measurements, facilitating a fair comparison regardless of their size.

Figure 8 presents the MAE and RMSE of the FLRONet family and FNO-3D with increasing levels of noise. The result in Fig. 8 indicates that FLRONet-MLP demonstrates strong resistance to noise at all levels of  $\varepsilon$ . Unlike other architectures, FLRONet-MLP does not employ Voronoi embedding, meaning that noise affecting a sensor at a particular position does not propagate to its neighboring regions. Additionally, the MLP branch net models the sensor measurements independently. It relies on global interactions across the entire input space rather than localized spatial relationships. This formulation inherently limits the impact of local noise, as perturbations in a small subset of input features can be offset in the dense network. Fig. 8 shows that while FLRONet-MLP is less competitive than FLRONet-FNO under noise-free inputs, it achieves the lowest MAE and RMSE across almost all noise levels. Its error increases only gradually as  $\varepsilon$  increases from 0% to 20%.

In addition, the result presented in Fig. 8 also reveals that FLRONet-UNet is the most influenced by noise. Here, we hypothesize that skip connections in FLRONet-UNet convey both noise and essential features directly to the output, with only a few convolutional layers to process them, which is inadequate. Therefore, the noise in the sensor measurements can directly affect the resulting reconstructed field and cause a reduction in the reconstruction accuracy. As shown, the FLRONet-UNet reconstructed fields show a sharp increase in MAE and RMSE even at a minimal  $\varepsilon$ . In particular, at  $\varepsilon = 10\%$ , its MAE exceeds 0.25 m/s, and at  $\varepsilon = 20\%$ , its RMSE exceeds 0.5 m/s, making it the least robust to noisy sensor measurement.

In the case of FLRONet-FNO and FNO-3D, they are notably effective at managing noise in the input, possibly due to their utilization of spectral transformations and mode truncations. These methods transform the input data into the frequency domain and eliminate redundant high-frequency modes that are often noise-dominated. However, FLRONet-FNO outperforms FNO-3D when  $\varepsilon < 10\%$ , as illustrated in Fig. 8. We hypothesize that FLRONet-FNO is better at handling noise because it only filters noise in the spatial domain using its two-dimensional Fourier transformation and mode truncations. In contrast, FNO-3D filters noise in both spatial and temporal dimensions. The resistance of FNO-3D to elevated noise levels is improved by additional temporal filtering.



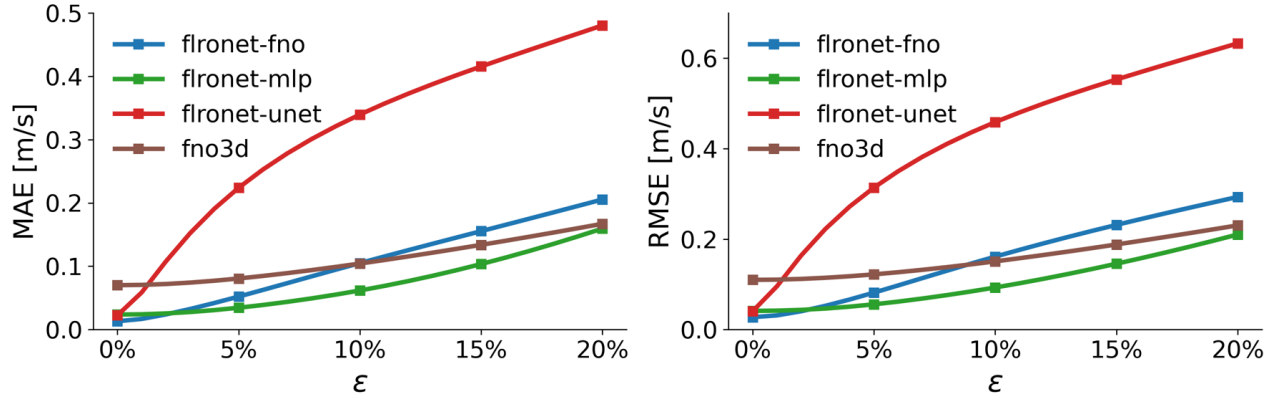

FIG. 8. **Reconstruction performance under different noise levels:** We compare the reconstruction performance of FLRONet-based models and FNO3D under varying levels of noise  $\epsilon$ . FLRONet-MLP, by leveraging global patterns without relying heavily on spatial dependencies, is less affected by noise. In contrast, FLRONet-UNet propagates noise directly through its skip connections in the branch network with insufficient processing, making it significantly more sensitive to noise. Fourier-based methods like FLRONet-FNO and FNO-3D effectively filter noise through spectral transformations and mode truncations, providing robust performance across noise levels.

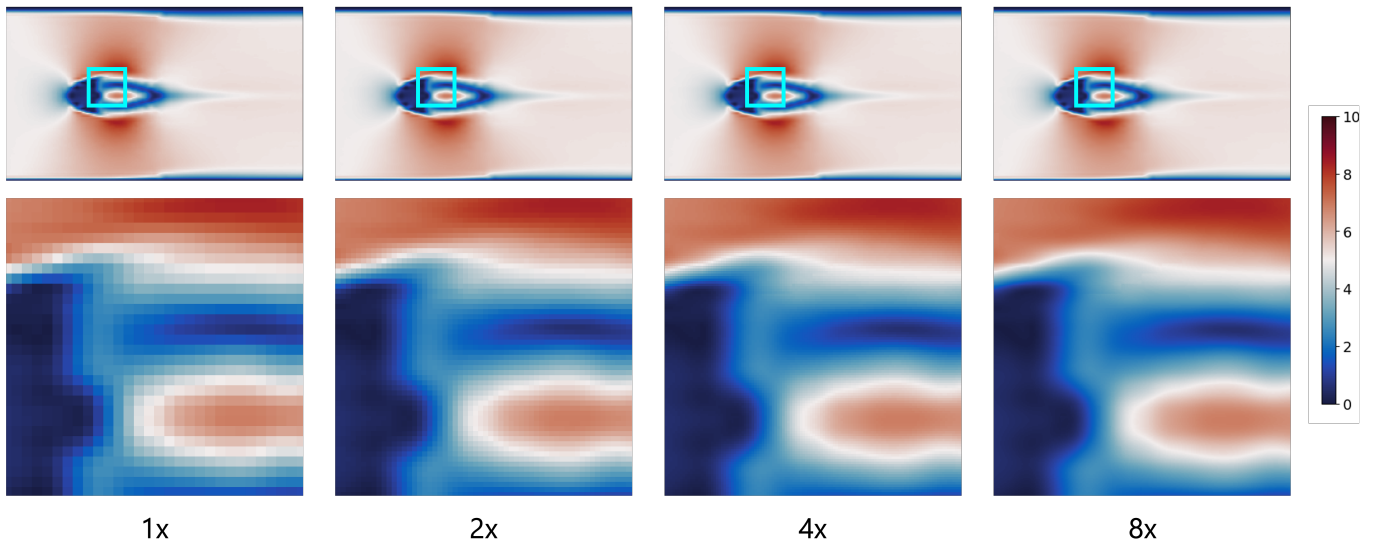

FIG. 9. **Super-resolution in space** The top row shows the full-field reconstruction, the bottom row provides magnified views of the highlighted regions to illustrate the improvement in spatial detail. Here, we can see the progressive reduction in pixelation and enhancement of spatial details as the resolution increases. Theoretically, FLRONet-FNO is able to reconstruct the complete vector field at arbitrary scales, constrained only by hardware memory.

#### D. Zero-shot super resolution in spatial domain

In contrast to MLP-based or CNN-based architectures, which are inherently resolution dependent, FLRONet-FNO has a distinctive flexibility that makes it especially useful for applications requiring resolution independent in the spatial domain. Standard MLP-based or CNN-based architectures typically require retraining for different spatial scales, hence limiting their practical applicability. In contrast, FLRONet-FNO can reconstruct the complete flow field at arbitrary scales, constrained only by hardware memory.

Figure 9 shows that FLRONet-FNO can successfully reconstruct the flow field at different levels of detail, from low to high. Here, FLRONet was trained on a resolution of  $140 \times 240$  and asked to make inferences on the resolutions of  $280 \times 480$ ,  $560 \times 960$ , and  $1120 \times 1920$ , which scale up the resolution twice, four, and eight times, respectively. The 8x reconstruction requires approximately 30GB of VRAM, which is well within the capacity of most modern GPUs. Higher-end GPUs, e.g., NVIDIA's A100 with 80GB VRAM or the H100 series, can even accommodate 16x reconstructions, providing much more

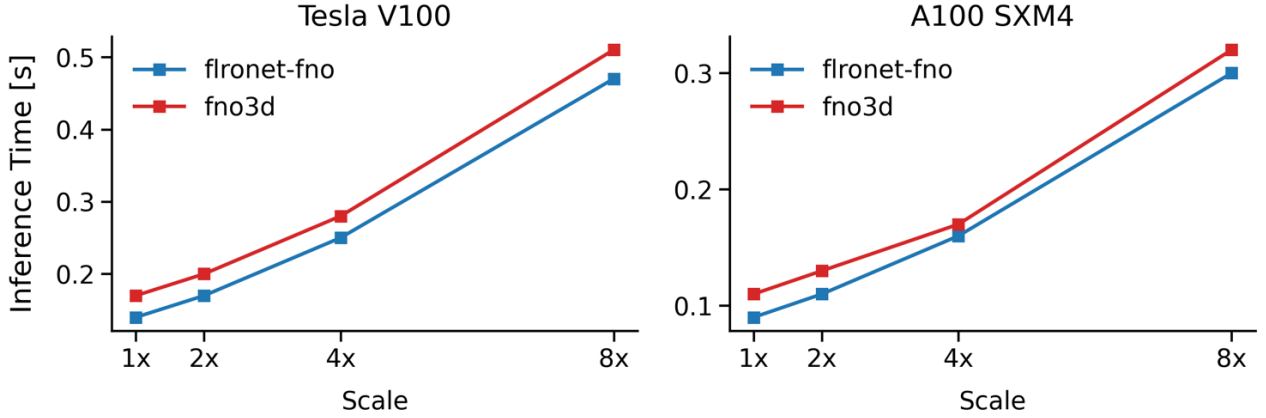

FIG. 10. **Measured Inference Time for Zero-Shot Super Resolution in Space.** The average inference time per time step for FLRONet-FNO and FNO-3D. We test on four different spatial scales  $\{1x; 2x; 4x; 8x\}$  using two popular GPUs: Tesla V100 (32GB) and A100 SMX4 (40GB). FLRONet-FNO consistently achieves lower inference times than FNO-3D at all scales.

fine-grain details.

The capability of FLRONet-FNO to reconstruct the flow field at different resolutions without training is due to the fact that it utilizes Fourier layers to reconstruct the physical field in the functional space. This approach allows the model to be trained on lower-resolution data while still being able to predict at higher resolutions without the need of retraining. The zero-shot super-resolution is feasible because FLRONet-FNO treats both inputs and outputs as continuous functions. During inference at higher spatial resolutions, the models naturally interpolate intermediate values using the predicted continuous function. As a result, knowledge learned from low-resolution data can be directly transferred to high-resolution settings, promoting efficiency and scalability.

The only method comparable to FLRONet in performing zero-shot super-resolution in space is FNO-3D. Both FLRONet-FNO and FNO-3D incur most of their computational cost from the Fourier transformations and their inverses. Consequently, the inference time for both models scales as  $O(S \log(S))$ , where  $S$  represents the spatial resolution of the output. This theoretical analysis is supported by the plots in Fig. 10, in which we measure the average inference time of each model on two popular mid-range GPUs: Tesla V100 (32GB) and A100 SMX4 (40GB). As we expected, the increase in the inference time almost follows a linear logarithmic pattern. However, FLRONet-FNO slightly achieves a lower inference time across all resolutions on both GPUs. The efficiency gap between the two models is more pronounced on the Tesla V100, a lower FLOPS GPU. These empirical results signify the computational advantage of FLRONet-FNO, particularly on lower FLOPS hardware.

### E. Zero-shot super resolution in temporal domain

One of the most prominent features of FLRONet is its capability to perform zero-shot super-resolution in the temporal domain. This refers to the model’s proficiency in reconstructing the flow field at any given time step within the observational window without the necessity of having the sensor observation at that specific time (see Fig. 11). This capability is particularly useful in the case where vortex shedding occurs and the flow becomes highly unstable. In this scenario, it is required to capture finer temporal details, and this requirement can be easily fulfilled by FLRONet via its zero-shot temporal super-resolution.

In this experiment, FLRONet-FNO is required to use sensor data from five time steps uniformly distributed within the interval  $\Delta_t = 0.02$  to reconstruct the flow field at any specified time  $t$  within this interval. Figure 11 illustrates the FLRONet reconstruction result for this task. For the field plots in Fig. 11, FLRONet used sensor measurements at  $t = 0.165, 0.170, 0.175, 0.180, 0.185$  and reconstructed the flow field at any specified time  $t \in [0.165, 0.185]$ . Here, the reconstructed flow fields correspond to times  $t = 0.176, 0.177, 0.178, 0.179$ . As illustrated in Fig. 11, FLRONet-FNO is capable of accurately reconstructing high-fidelity flow fields even in the absence of sensor measurements, showing good agreement with the ground truth from CFD. Moreover, the MAE plots (row (d)) in Fig. 11 also reveal that the maximum MAE for the reconstructions, when no sensor measurement is available, is only 0.047 m/s, occurring at  $t = 0.177, 0.178$ , which are the farthest from the time steps with the sensor data. For reference, at time steps that are adjacent to or coincide with those that have sensor data, the MAE values are confined within a range of 0.036 m/s to 0.039 m/s.

Figure 12 presents a more comprehensive analysis of the performance of FLRONet-FNO in reconstructing flow fields for time steps where sensor observations are not available. As illustrated in Fig. 12, FLRONet-FNO predictions for time steps with available sensor observations (indices 0, 5, 10, 15, 20) consistently achieve lower errors compared to those without sensor

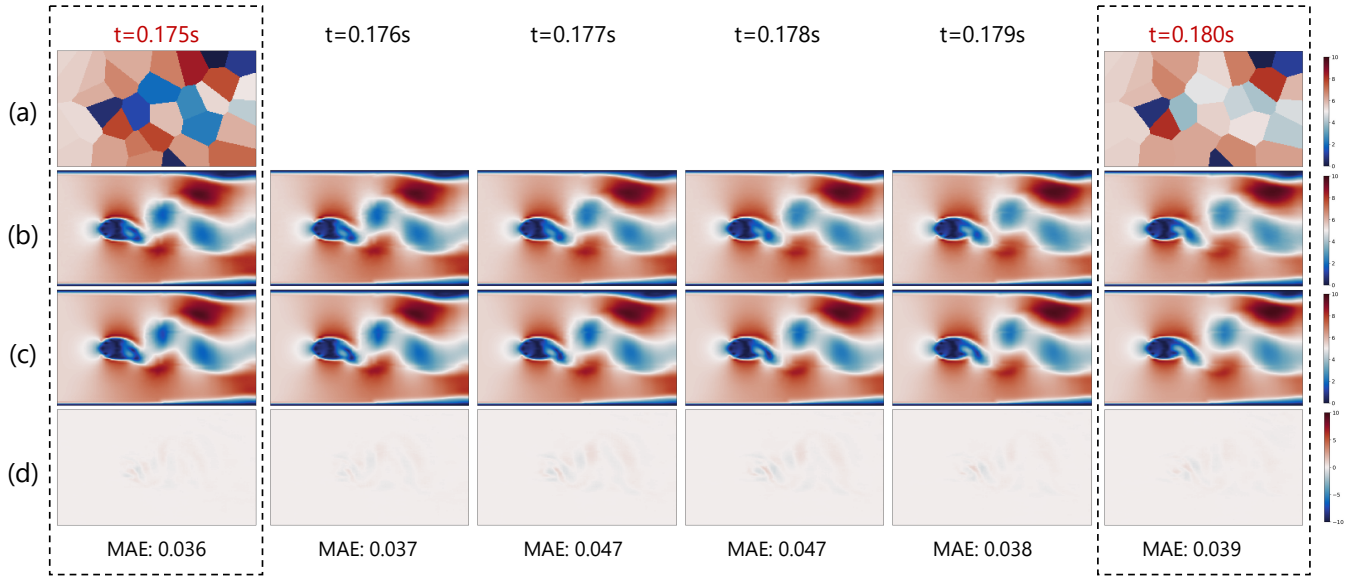

FIG. 11. **Reconstruction results under the boundary condition  $v_0 = 3.5$  m/s.** (a) The input Voronoi map. (b) The reconstructed velocity field predicted by the model. (c) The ground truth velocity field. (d) The MAE map of the reconstructed velocity field. The aggregated MAE values are provided below each time step to quantify the reconstruction accuracy.

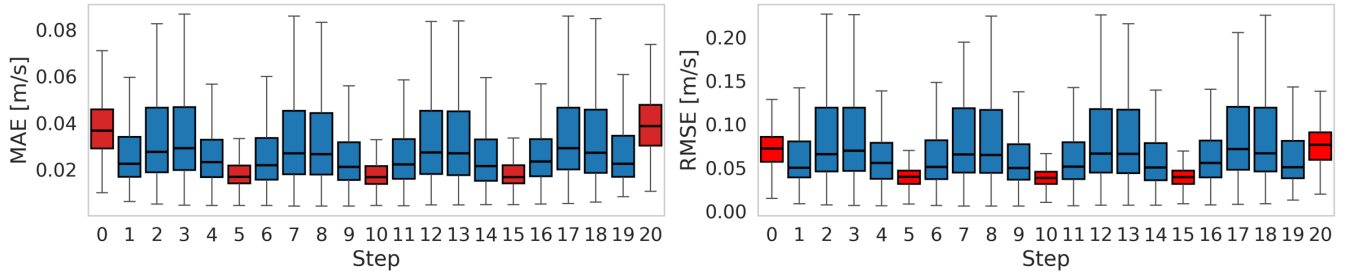

FIG. 12. **Reconstruction performance at each step in the sliding window.** Steps corresponding to sensor inputs (indices  $\{0; 5; 10; 15; 20\}$ ) consistently achieve the lowest errors, with minimal variability in both MAE and RMSE values. Predictions tend to be more accurate when made closer to the sensor inputs or towards the center of the sliding window. Predictions at indices  $\{2; 3; 7; 8; 12; 13; 17; 18\}$  exhibit higher errors as they are temporally furthest from the sensor inputs at  $\{0; 5; 10; 15; 20\}$ . This trend aligns with the expected challenge of predicting further from observed data points. Notably, predictions at indices  $\{0; 20\}$  also exhibit higher errors despite being sensor input steps, as they are located at the edges of the sliding window and receive only partial temporal context compared to interior steps.

observations. In contrast, the reconstruction in time steps further away from those with sensor observations exhibits the higher errors. Interestingly, the reconstructed fields at the edges of the time window (indices 0, 20) show higher errors compared to other time frames despite the availability of sensor observations. This is likely due to the limited temporal context available at the boundaries of the sliding window. In particular, time steps at boundaries of the time window can only access half of the temporal context; i.e., they can only use data from either the time before or after them, depending on their position. This is different from interior time steps, which can use information from both sides of the context. Overall, the reconstruction accuracy of FLRONet at time steps without sensor observations is comparable with those with sensor observations, despite having slightly higher reconstruction errors. This result has further validated the zero-shot temporal super-resolution reconstruction capability of FLRONet-FNO.

The zero-shot temporal super-resolution capability of FLRONet-FNO enables it to reconstruct the flow field with an extremely high temporal resolution. For example, Fig. 13 illustrates the FLRONet-reconstructed fields at multiple intermediate time steps within the interval of 0.001s, a temporal resolution higher than that of the training data. Although the ground truth at such fine temporal resolution is unavailable for quantitative validation, the reconstructed fields by FLRONet-FNO appear visually valid, showing no signs of numerical instability or artifacts. In fact, FLRONet can reconstruct the flow field at any specified time point  $t \in \mathcal{W}$  within  $\mathcal{W}$ , the temporal window of sensor observation. To further exemplify this capability, row (c) in Fig. 13 enhances the resolution by demonstrating the reconstructed velocity fields at  $t = 0.1752 + 10^{-8}$ ,  $t = 0.1752 + 10^{-7}$ ,  $t = 0.1752 + 10^{-6}$ ,



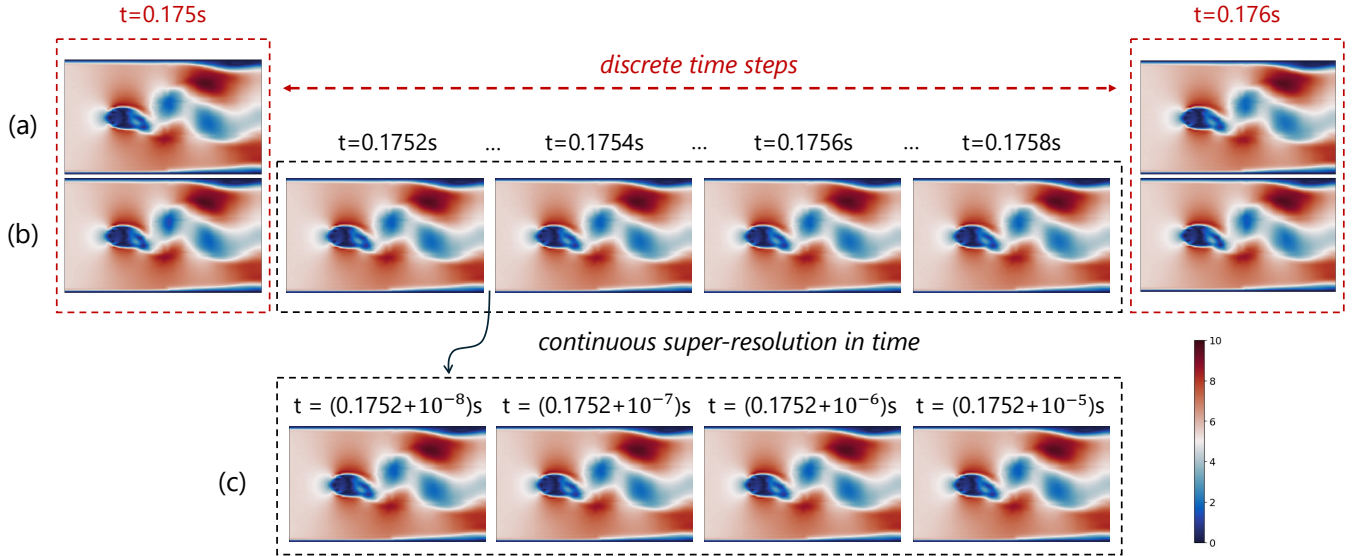

FIG. 13. **Continuous Super-Resolution in Time.** (a) The true velocity fields provided by the CFD dataset at discrete time steps  $t = 0.175s$  and  $t = 0.176s$ . (b) The reconstructed velocity fields at intermediate time points  $t \in \{0.1750; 0.1752; 0.1754; 0.1756; 0.1758; 0.1760\}s$ , highlighting the model’s ability to continuously generate smooth transitions between consecutive discrete steps. (c) The capability of temporal super-resolution by presenting reconstructions at finer time:  $t = (0.1752 + 10^{-8})s$ ,  $t = (0.1752 + 10^{-7})s$ ,  $t = (0.1752 + 10^{-6})s$ , and  $t = (0.1752 + 10^{-5})s$ .

and  $t = 0.1752 + 10^{-5}$ . Theoretically, deep operator learning allows predictions at any real value of  $t$ , constrained only by the floating-point precision of the data type. This floating-point precision dictates the smallest time step, practically resolved by FLRONet-FNO reconstruction.

## F. Discussion and implications

The above validation study has justified the capability of FLRONet in terms of both the accuracy of the reconstruction and the visual quality of the reconstruction. Here, we want to emphasize the unique zero-shot super-resolution capability in both space and time of FLRONet and its implications. In the industrial setting, the acquisition of real-time high-frequency data frequently becomes impractical due to hardware limitations and the considerable expenses associated with high-speed sensors. The deployment of FLRONet facilitates the reconstruction of fine-scale temporal dynamics from data collected at lower frequencies, thereby enabling thorough analysis without the need for specialized equipment. This functionality is especially crucial for the analysis of unstable or turbulent flow regimes, where minor fluctuations in the flow field over time can substantially influence overall dynamics. In this context, FLRONet’s ability to reconstruct the flow field at these subtle temporal variations without requiring retraining on high-resolution time-series data is generally indispensable, providing a cost-effective solution for investigating complex fluid dynamics.

## V. CONCLUSION

We introduce FLRONet, a deep operator learning method designed for the reconstruction of high-fidelity fluid flow fields from sparse sensor measurements. FLRONet was validated using the CFDBench dataset. Our findings indicate that FLRONet can produce field reconstructions that closely align with ground-truth flow fields derived from CFD simulations. Moreover, FLRONet also demonstrated high robustness against noise in sensor data and demonstrated strong performance even when given incomplete sensor information. Finally, a significant advantage of FLRONet is its ability to execute zero-shot super-resolution in both spatial and temporal domains without the necessity for retraining, a capability that is not available for other conventional deep learning-based field reconstruction techniques that depend on MLPs or CNNs. With this unique feature, FLRONet can be used for tasks that need rapid upscale interpolation in both space and time, such as when studying complex and unstable fluid flow. Our future work on FLRONet will focus on evaluating its temporal extrapolation capability, specifically assessing its efficacy in forecasting tasks. Additionally, validation using real-world data is imperative to ensure the generalizability of FLRONet.

## CONFLICT OF INTEREST STATEMENT

The authors have no conflicts to disclose.

## DATA AVAILABILITY

The data and source code supporting the findings of this study are available at <https://github.com/hiep dang-ml/FLRONet>

## AUTHOR CONTRIBUTIONS

**Hiep Dang:** Methodology (lead), Software (lead), Writing - Original Draft (Lead) ; **Joseph Choi:** Software (equal), Writing - Review and Editing (equal); **Phong Nguyen:** Conceptualization (lead), Supervision (lead), Methodology (equal), Writing - Review and Editing (lead), Funding Acquisition (lead).

## REFERENCES

- <sup>1</sup>N. B. Erichson, L. Mathelin, Z. Yao, S. L. Brunton, M. W. Mahoney, and J. N. Kutz, "Shallow neural networks for fluid flow reconstruction with limited sensors," Proceedings of the Royal Society A: Mathematical, Physical and Engineering Sciences **476**, 20200097 (2020).
- <sup>2</sup>J.-C. Loiseau, B. R. Noack, and S. L. Brunton, "Sparse reduced-order modelling: sensor-based dynamics to full-state estimation," Journal of Fluid Mechanics **844**, 459–490 (2018).
- <sup>3</sup>V. Mons, J.-C. Chassaing, T. Gomez, and P. Sagaut, "Reconstruction of unsteady viscous flows using data assimilation schemes," Journal of Computational Physics **316**, 255–280 (2016).
- <sup>4</sup>J. Wu, D. Xiao, and M. Luo, "Deep-learning assisted reduced order model for high-dimensional flow prediction from sparse data," Physics of Fluids **35** (2023), 10.1063/5.0166114.
- <sup>5</sup>R. Li, B. Song, Y. Chen, X. Jin, D. Zhou, Z. Han, W.-L. Chen, and Y. Cao, "Deep learning reconstruction of high-reynolds-number turbulent flow field around a cylinder based on limited sensors," Ocean Engineering **304**, 117857 (2024).
- <sup>6</sup>X. Luo, W. Xu, B. Nadiga, Y. Ren, and S. Yoo, "Continuous field reconstruction from sparse observations with implicit neural networks," in *The Twelfth International Conference on Learning Representations* (2024).
- <sup>7</sup>S. Cheng, C. Liu, Y. Guo, and R. Arcucci, "Efficient deep data assimilation with sparse observations and time-varying sensors," Journal of Computational Physics **496**, 112581 (2024).
- <sup>8</sup>N. Kovachki, Z. Li, B. Liu, K. Azizzadenesheli, K. Bhattacharya, A. Stuart, and A. Anandkumar, "Neural operator: Learning maps between function spaces with applications to pdes," Journal of Machine Learning Research **24**, 1–97 (2023).
- <sup>9</sup>Z. Li, N. B. Kovachki, K. Azizzadenesheli, B. Liu, K. Bhattacharya, A. M. Stuart, and A. Anandkumar, "Neural operator: Graph kernel network for partial differential equations," CoRR **abs/2003.03485** (2020), 2003.03485.
- <sup>10</sup>Z.-Y. Li, N. B. Kovachki, K. Azizzadenesheli, B. Liu, K. Bhattacharya, A. M. Stuart, and A. Anandkumar, "Multipole graph neural operator for parametric partial differential equations," ArXiv **abs/2006.09535** (2020).
- <sup>11</sup>G. Wen, Z.-Y. Li, K. Azizzadenesheli, A. Anandkumar, and S. M. Benson, "U-fno - an enhanced fourier neural operator based-deep learning model for multiphase flow," ArXiv **abs/2109.03697** (2021).
- <sup>12</sup>Z.-Y. Li, H. Zheng, N. B. Kovachki, D. Jin, H. Chen, B. Liu, K. Azizzadenesheli, and A. Anandkumar, "Physics-informed neural operator for learning partial differential equations," ArXiv **abs/2111.03794** (2021).
- <sup>13</sup>Z. Li, N. B. Kovachki, K. Azizzadenesheli, B. Liu, K. Bhattacharya, A. M. Stuart, and A. Anandkumar, "Fourier neural operator for parametric partial differential equations," CoRR **abs/2010.08895** (2020), 2010.08895.
- <sup>14</sup>X. Zhao, X. Chen, Z. Gong, W. Zhou, W. Yao, and Y. Zhang, "Recfno: A resolution-invariant flow and heat field reconstruction method from sparse observations via fourier neural operator," International Journal of Thermal Sciences **195**, 108619 (2024).
- <sup>15</sup>L. Lu, P. Jin, G. Pang, Z. Zhang, and G. E. Karniadakis, "Learning nonlinear operators via DeepONet based on the universal approximation theorem of operators," Nature Machine Intelligence **3**, 218–229 (2021).
- <sup>16</sup>O. Ronneberger, P. Fischer, and T. Brox, "U-net: Convolutional networks for biomedical image segmentation," Medical Image Computing and Computer-Assisted Intervention – MICCAI 2015, 234–241 (2015).
- <sup>17</sup>P. Dubois, T. Gomez, L. Planckaert, and L. Perret, "Machine learning for fluid flow reconstruction from limited measurements," Journal of Computational Physics **448**, 110733 (2022).
- <sup>18</sup>L. Yining, C. Yingfa, and Z. Zhen, "Cfdbench: A large-scale benchmark for machine learning methods in fluid dynamics," (2023).