

The effect of formation temperature and flexo-chemical strains on the electrophysical properties of the molybdenum-disulfide-oxide nanoflakes

Oleksandr S. Pylypchuk¹, Victor V. Vainberg^{1*}, Vladimir N. Poroshin¹, Anastasyia V. Terebilenko², Andrii S. Nikolenko³, Vadym I. Popenko³, Anatoliy S. Tolochko¹, Maryna V. Olenchuk¹, Oleksii Bezkrivnyi⁴, Galina I. Dovbeshko¹, Tomash Sabov³, Boris M. Romanyuk³, Anna N. Morozovska^{1†}, and Sergey V. Kolotilov[‡]

¹ Institute of Physics, National Academy of Sciences of Ukraine,
46, pr. Nauky, 03028 Kyiv, Ukraine

² L.V. Pisarzhevskii Institute of Physical Chemistry, National Academy of Sciences of Ukraine,
31, pr. Nauky, 03028 Kyiv, Ukraine

³ Lashkarev Institute of Semiconductor Physics, National Academy of Sciences of Ukraine,
41, pr. Nauky, 03028 Kyiv, Ukraine

⁴ W. Trzebiatowski Institute of Low Temperature and Structure Research, Polish Academy of
Sciences, 50-422 Wroclaw, Poland

Abstract

We synthesized the powder of molybdenum-disulfide-oxide nanoflowers consisting of self-assembled 10-20 nm thin nanoflakes by reaction of $(\text{NH}_4)_6\text{Mo}_7\text{O}_{24}$ with thiourea in aqueous solution at temperatures from 130°C to 180°C in hydrothermal conditions. The detailed analysis of the XPS, EDX and Raman spectroscopy results reveal the significant amount of the molybdenum oxides, sulfides and sulfates in the molybdenum disulfide nanoflakes, which allows to consider the “effective” formulae MoS_xO_y for their chemical composition.

The MoS_xO_y nanoflakes reveal unusual electric transport features interesting for material science and promising for applications. The chemical composition and microstructure of the nanoflakes, which are determined by the temperature of synthesis, is shown to be responsible for the electro-conduction mechanism. Namely, the current-voltage characteristics (I-V curves) grow monotonically with the applied voltage for the samples, synthesized at the temperatures $T_s \ll 150^\circ\text{C}$ and $T_s \gg 150^\circ\text{C}$, being non-ohmic and hysteretic at lower voltages and becoming close to the ohmic at higher voltages. The I-V curves acquire N-like shape with a strongly pronounced negative

* corresponding author, e-mail: viktor.vainberg@gmail.com

† corresponding author, e-mail: anna.n.morozovska@gmail.com

‡ corresponding author, e-mail: s.v.kolotilov@gmail.com

differential resistivity (NDR) part at $T_s = 150^\circ\text{C}$. Both with and without N-shape, the I-V curves manifest hysteretic behavior with the difference between increasing and decreasing voltage sweeps, and the hysteresis loop parameters are determined by the temperature of synthesis. Important, that the studied nanoflakes manifest very long living deep charging and discharging after the voltage switching “on” and “off”.

Considering that the presence of oxygen non-stoichiometry and bending can create strong flexo-chemical strains in the nanoflakes, we proposed the flexo-chemical model of the polar and electro-transport properties of the pressed MoS_xO_y nanoflakes, which describes the observed I-V curves. The revealed experimentally and explained features of resistive switching and charge accumulation in the MoS_xO_y nanoflakes look promising for applications in memristors and high-performance supercapacitors.

I. INTRODUCTION

Semiconducting low-dimensional (LD) transition metal dichalcogenides (TMD), in the form of flexible ultrathin films [1], nanoflakes and their flower-like arrays [2, 3, 4], are promising candidates for nanoelectronics [5, 6, 7], supercapacitors [8], strain- and isotope-engineering [9, 10], and flexo-tronics [11]. The possibilities of controlling the structural, polar, and electronic properties of the LD TMD by applying homogeneous compressive or tensile elastic strains [12, 13, 14], and bending deformations [15, 16] have been revealed.

In particular, the possibilities to control the electronic properties of the chemically pure MoS_2 nanoflakes ensembles (e.g., in the form of powders) have been revealed and explained by the fact that the part of their volume undergoes the phase transition from the “bulk” semiconducting 2H phase to the “surface” metallic 1T' phase. The transition is caused by the synergetic effect of the mechanical compression and filament formation in the strong electric field. This type of the phase transition maybe observed in the I-V curves of the MoS_2 powder starting from relatively small compressions (above 0.2%) and electric fields more than (80 – 100) V/cm [17].

The thermal annealing can significantly influence structural, optic and electronic properties of MoS_2 nanosheets [18, 19] and thin films [20]. In particular, the metastable metallic 1T phase emerges with Li intercalation into a few-layer thick MoS_2 , and the mild annealing at temperatures from 50°C to 300°C leads to gradual restoration of the 2H semiconducting phase [21]. The annealing impacts sulfur vacancies and electronic transport in MoS_2 films [22] and allows defect engineering on the MoS_2 surface [23]. The temperature of MoS_2 formation in a solution may influence its properties like annealing in the solid state.

Complementary to the strain- and isotope-engineering of LD TMDs, the advanced methods based on the use of MoS_2 nanopowders mixed with relative Mo compounds like MoO_3 [24, 25] or

Mo₂S₃ [26] have been successfully developed. These efforts focus on the development of clean energy conversion and storage systems, such as hydrogen production devices, supercapacitors, including fabrication technology, structure features and electric properties [27, 28].

Similarly to epitaxial elastic strains, the chemical strains [29, 30], induced by impurities, such as elastic defects (elastic dipoles or dilation centers), can control the electronic properties [31] and local symmetry [32, 33] of LD TMDs. Above a certain deformation threshold, chemical strains can induce ferroelectric-like domain structures and conductive domain walls in the LD-TMD [31, 32].

The possibilities of controlling the electronic and polar properties of LD TMDs by bending uses the fact, that the flexoelectric effect can play a very important role [34]. Flexoelectricity, defined as the coupling between the strain gradient (e.g., bending or rippling) and electric polarization [35], can be responsible for many important features in the LD TMD [11, 36]. The flexoelectricity is expected to be extremely strong in sliding van der Waals (vdW) ferroelectrics [37], such as TMD nanoflakes. The flexoelectricity can induce, enhance or reverse the polarization, change domain chirality and/or influence strongly the domain morphology in versatile ferroic films [38] and nanoparticles [39], including nanoflakes with vdW layered structure [40].

The sliding flexo-ferroelectricity can induce the interfacial charge accumulation in the curved LD layered vdW TMDs [41, 42]. The sliding ferroelectricity has been revealed in artificially stacked 2D TMD [43, 44], which out-of-plane electric polarization originates from the interlayer charge transfer in their stacking. The stack polarization can be reversed across the interlayer sliding with an ultralow barrier [45]. The LD vdW materials, which are free-standing sliding ferroelectrics, typically have high fracture stress and low bending stiffness, enabling their significant out-of-plane curvature, corresponding to the strain gradients of several orders of magnitude higher than those achieved in epitaxial ultra-thin oxide films clamped to rigid substrates [46].

In this work we reveal unusual electrophysical properties of the pellets made of the compressed powder of 10-20 nm thin MoS_xO_y nanoflakes self-assembled in nanoflowers formed at different temperatures (from 130°C to 180°C). The detailed analysis of the XPS, EDX and Raman spectroscopy results reveals the significant amount of the molybdenum oxides, sulfides and sulfates in the molybdenum disulfide (MoS₂) nanoflakes, which allows to consider the “effective” formulae MoS_xO_y for their chemical composition. Considering that the presence of oxygen non-stoichiometry and bending can create strong flexo-chemical strains in the nanoflakes, we proposed the flexo-chemical model of the polar and electro-transport properties of the pressed MoS_xO_y nanoflakes, which describe the observed I-V curves.

II. SAMPLES CHARACTERIZATION

A. Samples characterization by HRTEM, SEM, EDS and XRD

The overall morphology and elemental compositional of the MoS_xO_y nanoflakes were studied by Scanning Electron Microscopy (SEM) using Tescan Vega 3 LMU microscope equipped with Bruker XFlash EDS detector for Energy-dispersive X-ray Spectroscopy (EDX). Internal structure of the samples was determined by the Transmission Electron Microscopy (TEM), using a Philips CM-20 Super Twin instrument operating at 160 kV. Chemical state of the samples was studied by the X-ray Photoelectron Spectroscopy (XPS).

The XPS analyses were carried out with a PHI 5600 spectrometer using a monochromatic Al K(alpha) source. The instrument work function was calibrated to give the binding energy (BE) of 84 eV for the Au 4f7/2 line for metallic gold and the spectrometer dispersion was adjusted to give a BE of 932.6 eV for the Cu 2p3/2 line of metallic copper. Survey scan analysis was carried out with the passing energy of 93.9 eV and 0.2 eV step. Before analysis the samples were not pre-etched with the ion gun.

A PROTO AXRD Benchtop powder diffractometer equipped with a DECTRIS® MYTHEN2R 1D linear detector was used for the X-ray diffraction spectra measurements. Experimental conditions correspond to Cu K α radiation ($\lambda = 1.5418 \text{ \AA}$), Ni filter, $U = 30 \text{ kV}$, $I = 20 \text{ mA}$. Scanning was performed in the range of angles $2\theta = (10 - 65)^\circ$ with the step of $\Delta 2\theta = 0.04^\circ$, in the Bragg-Brentano geometry, $\theta/2\theta$ mode.

The Raman spectra of the samples were recorded at room temperature in the backscattering geometry by the Horiba Jobin-Ivon T64000 triple Raman spectrometer (200-1700 nm) with a solid-state laser Spectra Physics EXLSR-532-150-CDRH (532 nm).

Typical TEM images of the nanoflakes formed at 150°C are shown in **Figs. 1(a)** and **1(b)**. The profiles of the sharp and very contrast edges correspond to the small thickness (about 10 nm or less) and strong bending of the individual nanoflakes, which are strongly oxidized. Typically, non-oxidized MoS_2 nanoflakes have smooth diffuse edges. Representative SEM images of the nanoflowers, self-assembled from the individual nanoflakes, are shown in **Figs. 1(c)** (the temperature of synthesis 130°C) and **1(d)** (the temperature of synthesis 180°C). From these images, the nanoflower diameter varies from 100 nm to 1 μm , and the shape of most flowers is round-like.

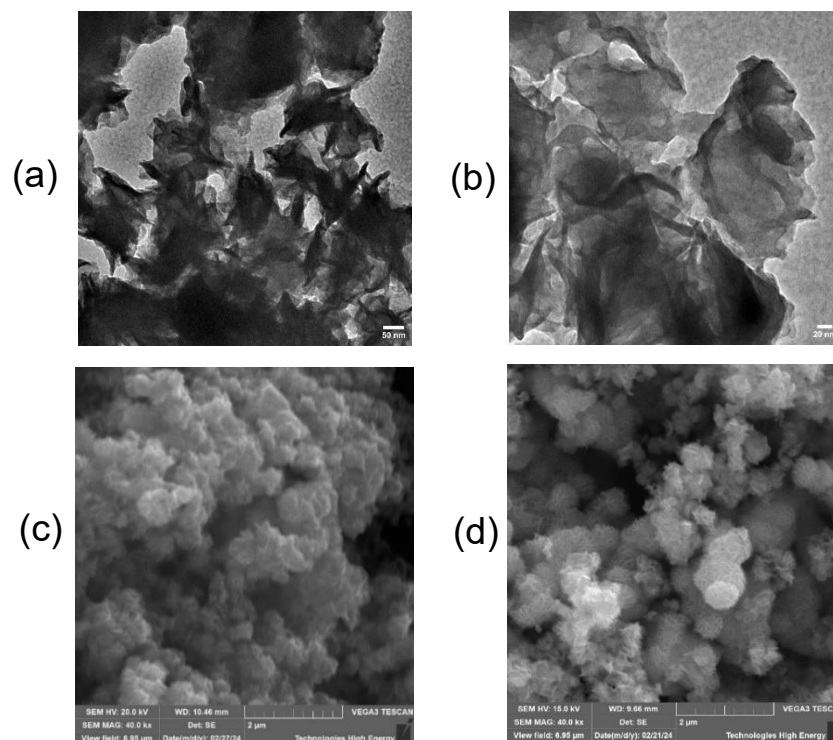

Figure 1. Typical TEM images of the individual MoS_xO_y nanoflakes synthesized at 150 C with lower **(a)** and higher **(b)** magnifications. Representative SEM images of the nanoflowers, self-assembled from the individual nanoflakes synthesized at 130 C, with smaller globules **(c)** and those, synthesized at 180 C, with larger globules **(d)** (the scale is 200 nm).

The low-resolution (scale 200 μm) SEM images of the flower-like MoS_xO_y nanoflakes synthesized at the temperatures 140, 150 and 160°C are shown in **Fig. 2(a)**, **2(b)** and **2(c)**, respectively. As evidenced by the images, the particles within all samples display consistent, in general, morphological features and some inclination towards aggregation. These images are chosen because they demonstrate the characteristic changes of the whole set. Let us underline some distinctive features of the SEM image in **Fig. 2(b)**, which shows the powder of nanoflakes formed at 150°C compared to the other two. The image looks denser and “brighter” (even with metallic shine), and the particles look smaller. The left and right images are “darker” and have large blocks of particles, which are relatively well separated.

The EDX spectra for the same three samples are shown in **Fig. 2(d)**, **2(e)** and **2(f)**, respectively. All spectra contain the peak at 2.4 eV attributed to the molybdenum (Mo). However, the EDX spectrum of the nanoflakes formed at 150°C (shown in the middle) reveals a distinctive feature compared to the left and right spectra, namely it contains smaller % of oxygen (see the data presented in **Table 1**).

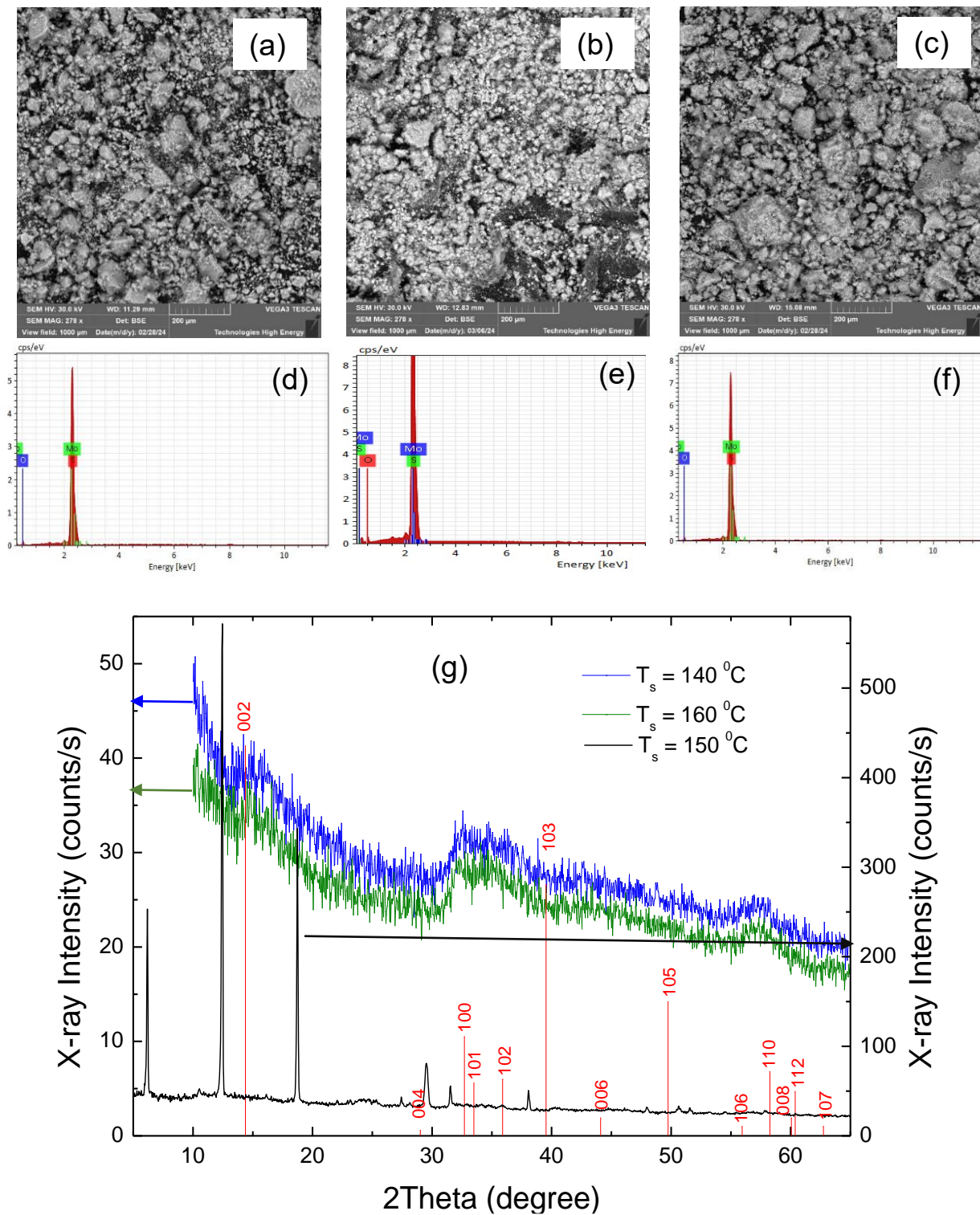

Figure 2. Low-resolution SEM images (a-c) of the powder-like MoS_xO_y nanoflake samples formed at 140, 150 and 160°C, respectively. EDX spectra of these samples (d), (e) and (f), respectively. (g) XRD spectra of the powder-like nanoflake samples formed at 140°C (the blue curve), 150°C (the black curve) and 160°C (the green curve). Red vertical lines correspond to the angular positions and relative intensities of the diffraction peaks of the hexagonal MoS₂ determined according to the Crystallography Open Database (# 9009144).

The diffraction patterns of the nanoflakes synthesized at 140°C and 160°C are very similar to each other (see green and blue spectra in **Fig. 2(g)**). In both cases broad maxima with low intensity are observed, which corresponds to the very small sizes (6 nm according to the Scherrer formula) of the coherent scattering regions (CSR). Some peaks, which are characteristic for the hexagonal structure of MoS₂, namely (002), (100), (102) and (110), are visible in the diffractograms. At the same time, the diffraction peaks (103) and (105), which should be pronounced for the pure hexagonal MoS₂, are absent. This may indicate the presence of a texture or an anisotropic shape of the synthesized nanoflakes, or, very likely, amorphous phase inclusions.

The XRD pattern of the nanoflakes synthesized at 150°C differs strongly from the hexagonal MoS₂ (# 9009144) according to the Crystallography Open Database (compare the black peaks and red vertical lines in **Fig. 2(g)**). It appeared impossible to identify the phase composition of the nanoflakes from these spectra as that of MoS₂, since their diffraction peaks do not complain with any known polymorphs of MoS₂ (namely, with 2H, 3R and 1T), as well as with molybdenum oxides. Hence, we assume that the XRD patterns may correspond to the MoS_xO_y nanopowders with complex morphology of individual nanoflakes.

The content of the oxygen (O), sulfur (S) and molybdenum (Mo) elements in the three above-mentioned samples, calculated from these EDX spectra, is listed in **Table 1**. It is seen that all samples contain a significant amount of oxygen. The main distinction of the sample, formed at 150°C, consists in a somewhat distinctive ratio between the O and S elements, shifted to a higher content of S.

Table 1. Element content in the three points of the MoS_xO_y nanoflake powders synthesized at 140, 150 and 160°C (from the EDX data)

Element	Mass %	At %	Temperature of synthesis, °C
O	20.14; 18.43; 17.23	44.14; 41.42; 39.85	140
S	36.66; 37.52; 36.71	40.08; 42.07; 42.38	
Mo	43.19; 44.05; 46.06	14.78; 16.51; 17.77	
O	16.25; 14.45; 13.94	38.30; 34.31; 33.40	150
S	36.75; 40.34; 40.51	43.22; 47.79; 48.41	
Mo	47.00; 45.21; 45.54	18.48; 17.90; 18.19	
O	20.31; 19.88; 21.29	45.78; 45.51; 46.73	160
S	32.41; 31.42; 33.57	36.45; 35.89; 36.76	
Mo	47.28; 48.71; 45.13	17.77; 18.60; 16.52	

Three diffuse maxima of the XRD spectra, shown in **Fig. 2(g)**, confirm the nanoscale morphology of the samples studied.

C. XPS spectroscopy

The typical XPS survey spectrum of the MoS_xO_y nanoflowers formed at 150°C is shown in **Fig. 3(a)**. The total set of the survey spectra for all studied samples is presented in **Fig. A1** in

Appendix A. In general, the spectra are similar and show the presence of the large amount (more than 13 %) of molybdenum oxide, oxides, sulfoxides and sulfates along with molybdenum disulfide in all samples. The quantitative composition of these components in the samples, calculated from the corresponding parts of the survey spectrum based on the commonly used procedure, is listed in **Table 2**. It is seen that the samples contain noticeable quantity of molybdenum oxide, sulfoxides and sulfate along with molybdenum disulfide. It is also seen from the table that all samples may be divided conditionally into the two groups with less and more content of oxides, sulfoxides and sulfates. The XPS data, like the EDX data, reveal that the samples contain a large amount of oxygen. At that, the averaged content of oxygen by compounds in both mentioned groups considerably differs. Also, one should notice that the XPS spectrum shows the presence of some quantity of carbon. However, its content varies randomly and does not depend on the temperature of synthesis. Collation of these groups with the temperature of synthesis of sample shows that one of them is obtained at the temperature of 150°C, while another group corresponds to all other temperatures, either below or above 150°C. All in all, the samples formed at 150°C have noticeably lower content of MoS₂ and higher content of the oxide/sulfoxide and sulfate. This issue, including the forms of sulfoxides, and their collation with the synthesis conditions, enables making certain conclusions, while require further studies.

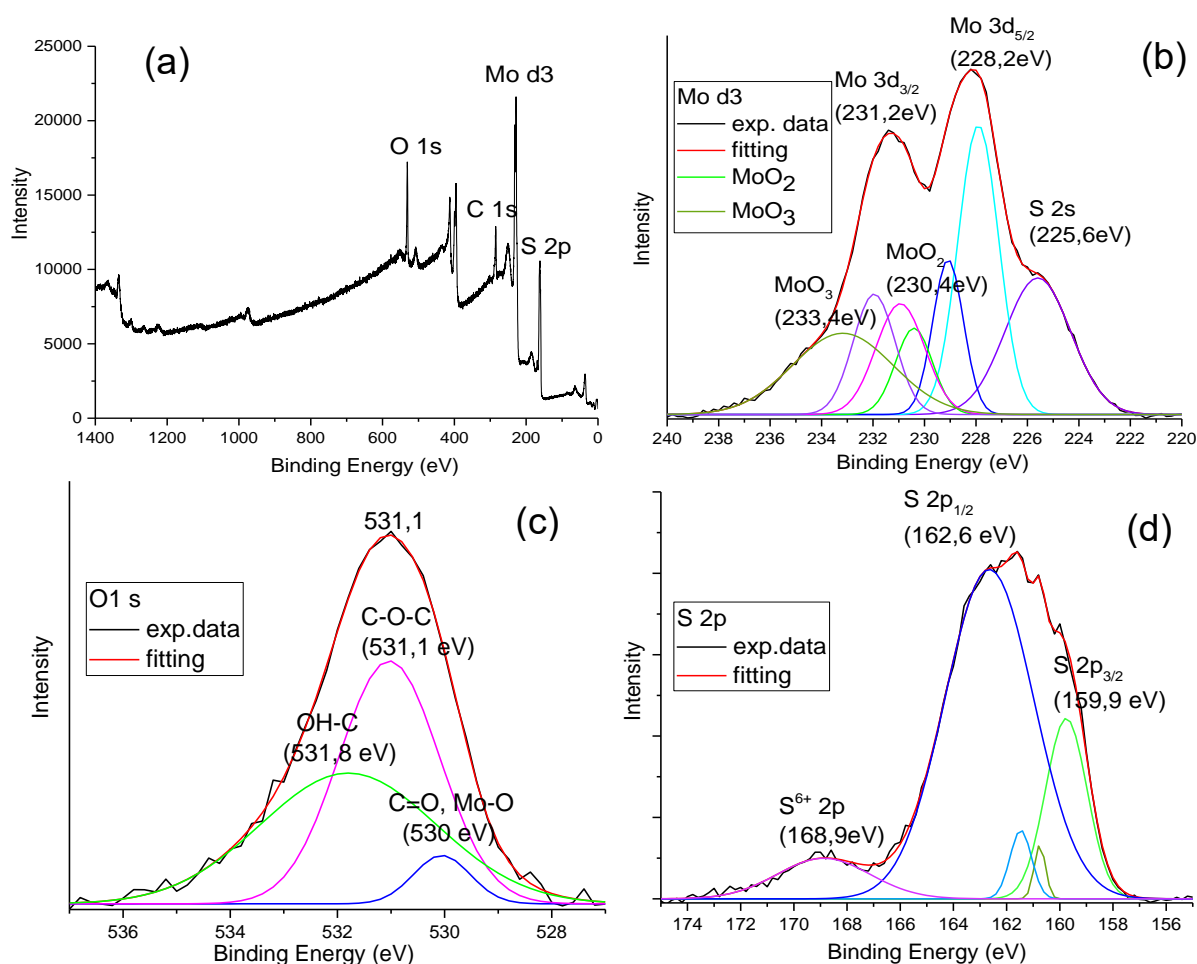

Figure 3. (a) Typical survey XPS spectrum of the nanoflowers powder samples formed at 150°C. The parts of the XPS spectrum in the Mo 3d (b), O 1s (c) and S 2p (e) regions. Red curves are the overall fit of the experimental spectra (shown by black curves). Other colors correspond to the red curves decomposition using Voigt profile associated with separated peaks.

Table 2. Quantitative chemical composition of the samples (from the XPS data)

Sample №	T, °C	MoS ₂ , %	Oxide/sulfoxide, %	Sulfate, %	O/S	S/Mo
S1	132	73.9	26.1	7.75	0.69	0.46
S2	142	76	24	2.95	0.59	0.57
S3	140	66.1	33.9	15.5	1.05	0.45
S4	160	74.9	25.1	2.6	0.56	0.58
S5	150	47.6	52.4	66.35	3.61	0.42
S9	140	86.7	13.3	2.61	0.44	0.54
S11	150	34.4	65.6	61.2	3.35	0.44
S12	160	59.3	40.7	8.97	1.56	0.36

C. Raman spectroscopy

Below we analyze the Raman spectra of the slightly compressed MoS_xO_y nanoflakes, formed at 140, 150 and 160°C. The spectra, which are the most representative and the most important for the understanding of electro-transport features, are shown in **Fig. 4** and summarized in **Table 3**. MoS_xO_y nanoflakes, formed at 140 and 160°C, are inhomogeneous and demonstrate a typical behavior depending on the sample point p1-p8, where the spectra were recorded. We recorded the Raman spectra of the amorphous phase with broad bands, the spectra with broadened bands of the MoS₂ phase characteristic of nanostructures, and the spectra with narrow bands of crystalline molybdenum oxides, possibly h-MoO₃, o-Mo₄O₁₁, or/and others (see e.g., Refs. [47, 48, 49]). The latter are registered for the sample areas in the form of crystallites with a regular shape (see inset in **Fig. 4(a)**). At low excitation power of 0.5 mW the spectra manifest the peaks at 376 cm⁻¹ and 404 cm⁻¹, which are clearly seen and can be ascribed to the A_{1g} and E_{2g}¹ modes of MoS₂, respectively. All other observed modes (like the intense peaks at 960 cm⁻¹ and 1017 cm⁻¹) are characteristic to the vibration and distortion modes of oxides, presumably due to the presence of oxygen atoms and sulfoxide groups on the surface of nanoflowers.

For the MoS_xO_y nanoflakes formed at 150°C, only the spectrum of the amorphous phase with broad bands and the spectrum of molybdenum oxides (possibly h-MoO₃, o-Mo₄O₁₁, or/and others) with narrow bands were observed. In contrast to the MoS_xO_y nanoflakes, formed at 140 and 160°C, no laser-induced oxidation (crystallization) to the α-MoO₃ phase was observed for the MoS_xO_y nanoflakes formed at 150°C.

Thus, the increase of laser power may cause the oxidation of amorphous regions and additional amorphization of other regions for all temperatures of synthesis. This result agrees with the statement

that laser treatment of amorphous, defect-rich MoS₂ can significantly improve its crystallinity at a certain irradiation dose, however results in oxidation at higher doses [50]. In addition, laser-induced transformations between different oxidation states of molybdenum oxides can be observed [51].

To summarize, the Raman spectra confirm the presence of molybdenum oxide and sulfoxide groups on the surface of all MoS_xO_y nanoflakes (as well as their self-assembling in nanoflowers) in high amount, as follows from the relative intensities of corresponding peaks. The fraction of the molybdenum oxides, sulfoxides and/or other possible oxygen-containing compounds non-monotonically depends on the temperature of synthesis, showing distinctive features at $T_S = 150^\circ\text{C}$.

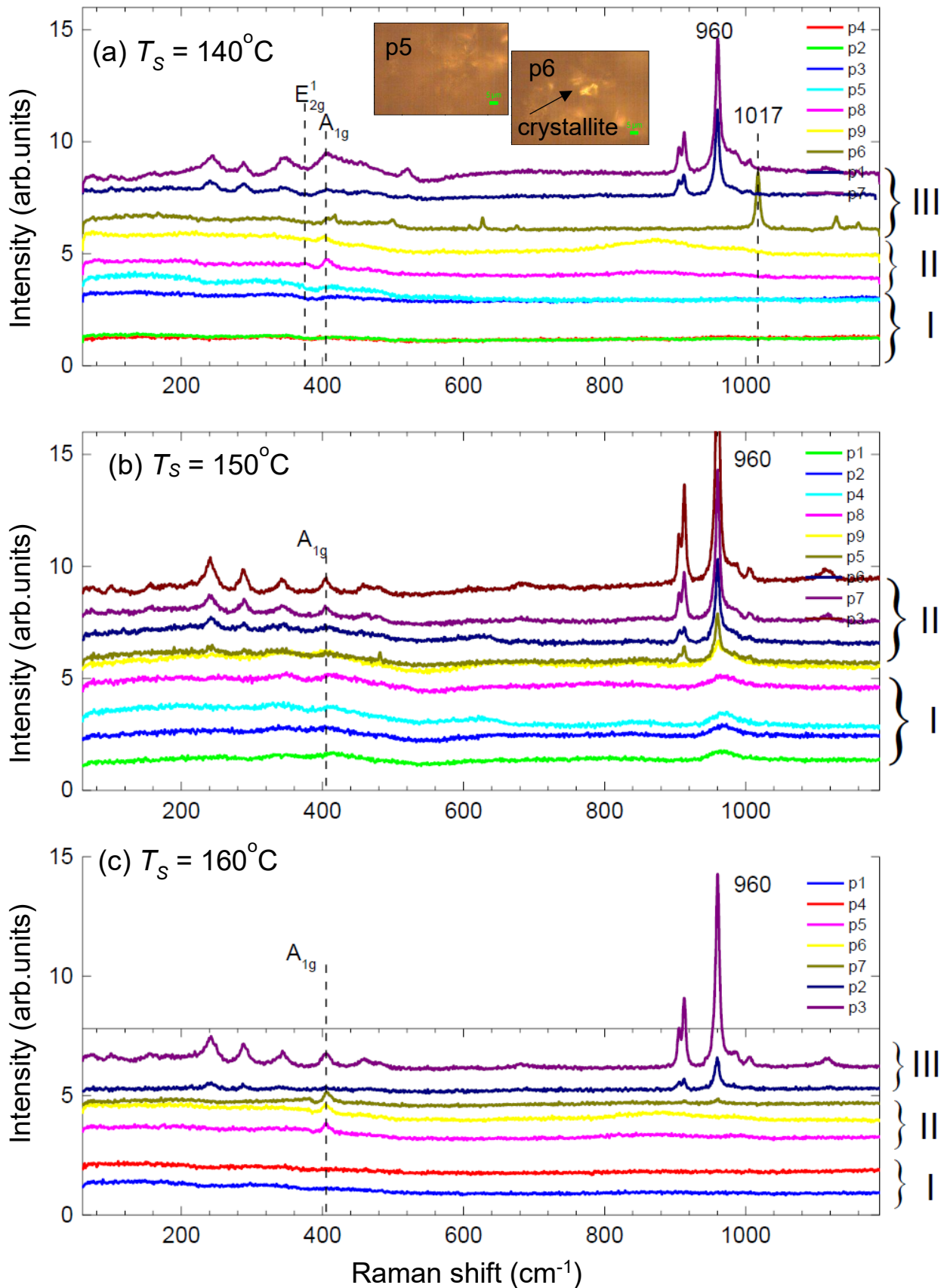

Figure 4. Raman spectra of the slightly pressed MoS_xO_y nanoflakes formed at the temperatures 140°C (a), 150°C (b) and 160°C (c) with designated A_{1g} and E_{2g}^1 peaks.

Table 3. The samples characterization (from Raman data)

T_S , °C	Amorphous phase	The MoS ₂ phase	Crystalline oxide phase	Increase in excitation power
140	(I) spectra of the amorphous phase with broad bands (p2, p3, p4, p5)	(II) spectra with MoS ₂ phase bands characteristic of nanostructures (p8, p9)	(III) spectra with narrow bands of probably crystalline molybdenum oxide (p1, p6, p7). Spectra of type (III) are registered for areas in the form of crystallites of regular shape.	Oxidation (or crystallization) to the α -MoO ₃ phase occurs for the amorphous areas, which is evidenced by the appearance of narrow intense bands. For the areas showing narrow Raman bands of oxides at low excitation power, their amorphization occurs under the power increase, as evidenced by the broadening of the bands
150	(I) spectra of the amorphous phase with broad bands (p1, p2, p4, p8)	absent	(II) spectra with narrow bands of molybdenum oxide (not α -MoO ₃) (p3, p5, p6, p7, p9). Spectra of type (II) are recorded for areas in the form of crystallites of regular shape.	For amorphous areas, there is a slight restructuring of the spectrum, probably due to oxidation, the bands become more pronounced, but typical for the amorphous phase. For areas that had narrow bands at low power, their amorphization occurs when the power is increased, which is evidenced by the broadening of the bands.
160	(I) spectra of the amorphous phase with broad bands (p1, p4)	(II) spectra with MoS ₂ phase bands characteristic of nanostructures (p5, p6, p7)	(III) spectra with narrow bands probably of crystalline oxide (not α -MoO ₃) of molybdenum (p2, p3). Spectra of type (III) are registered for areas in the form of crystallites of regular shape.	For amorphous areas, their oxidation (or crystallization) to the α -MoO ₃ phase occurs, as evidenced by the appearance of corresponding narrow intense bands. For areas that had narrow bands at low power, the shape of the spectrum does not change drastically when the power is increased.

II. ELECTROPHYSICAL PROPERTIES OF MoS_xO_y NANOFLLAKES:

EXPERIMENT AND MODELLING

A. Experimental details

The samples for the study of the electric transport properties were prepared by compressing the MoS_xO_y nanoflakes powder and have two forms, shown in **Fig. 5(a)** and **5(b)**.

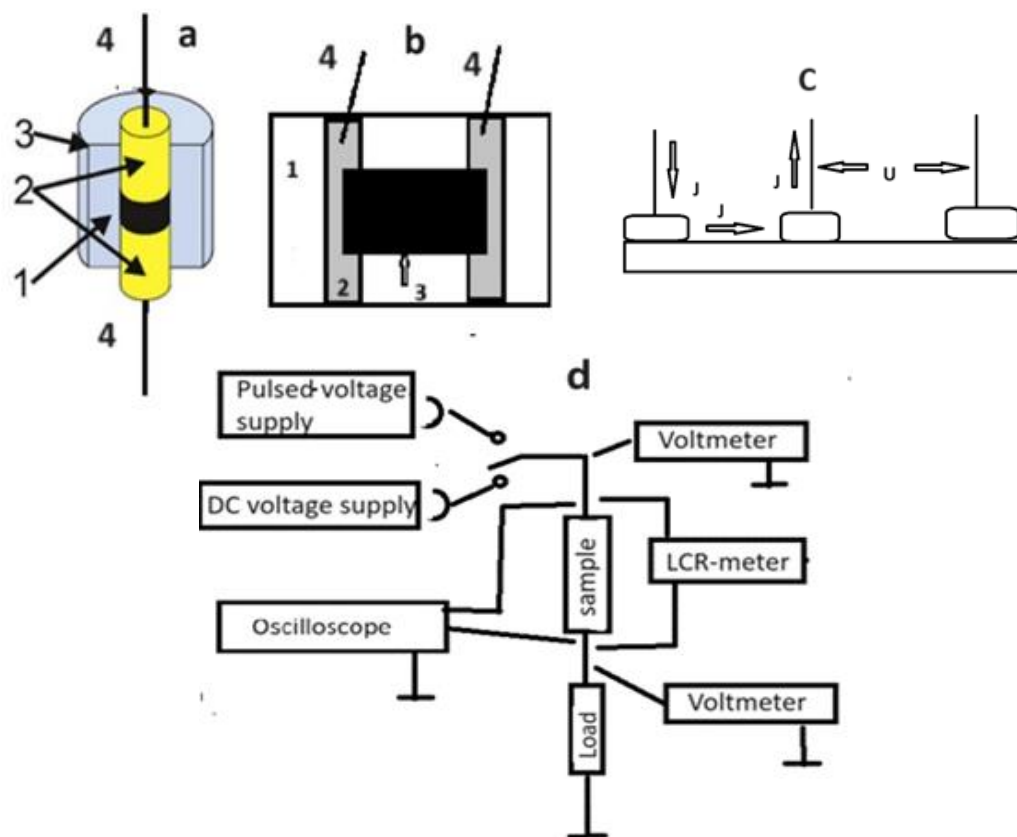

Figure 5. Schematic images of the cells with the samples. **(a)** The cell with a sample under constant compression: “1” is the powder sample, “2” are the steel plungers serving as electrical contacts and plungers compressing the powder, “3” is the Teflon tube, “4” are the electric wires. **(b)** The cell with preliminarily compressed powder sample in a free state: “1” is the textolite substrate, “2” are the metallized strips to form electrical contacts, “3” is a powder sample compressed as a film on the substrate, 4 are the electric wires. **(c)** The schematic image of the sample for investigation of electric contact characteristics. **(d)** The principal electric circuit of electric measurements.

The samples were formed of MoS_xO_y nanoflakes powder either under permanent compression (placed between compressing plungers in the cylindrical Teflon tube, see **Fig. 5(a)**) or in the form of a preliminarily compressed film on the textolite substrate (see **Fig. 5(b)**). The first form enables studying the samples under different controllable compression. The metallic plungers serve both as electric contacts and to perform uniaxial compression of the sample in the pressure range of 0.5–2.5 MPa. The sample in the cell had a disk shape with 4 mm diameter and about 0.15 mm thickness. These dimensions were chosen to provide acceptable limits for measurements of sample resistance and to provide the sample thickness to be much larger than nanoflakes sizes in order to avoid the short circuit conditions.

The electric voltage was applied to the sample, connected in series with the load resistor, from the software-controlled dc power supply GW Instek PSP-603. The voltage drop across the sample

and the load resistor were measured by the digital multimeters Keithley 2000 and recorded by the computer. To record quick transient processes, we used the digital oscilloscope Tektronix TDS1002B and the pulsed supply G5-63. The dielectric characteristics were measured by the LCR-meters UniT-612 and E7-12.

B. Current-voltage characteristics. Resistive switching and negative differential resistivity

The MoS_xO_y nanoflakes samples (temperatures of synthesis varies from 130 to 180°C) are characterized by a long-lasting transient process of charging on applying voltage on a sample. Therefore, measurements of current-voltage characteristics demand a proper time delay between the successively recorded points. The results are presented in **Fig. 6**. They were recorded with voltage step of 20 mV and a delay of 2 s after each step to measure the current through the sample at temperatures 285 – 295 K under uniaxial pressure of 2.5 MPa. The results shown in **Fig. 6(a)** were obtained for the samples of the first type, according to the classification made above. All results for the second type samples (**Fig. 6(b)**) are qualitatively and semi-quantitatively close to each other.

From **Fig. 6**, the following conclusions can be made. All I-V curves have the shape of more or less pronounced hysteresis loop. They also can be divided into two types. The first type demonstrates a monotonic change of the current with increase and decrease of the applied voltage. The second type, which corresponds to the samples formed at 150°C, is distinguished by the pronounced part with the negative differential conductivity (NDC).

Note that the measurements were carried out in the voltage range (0 – 10) V. The dissipated power in the samples, considering that the maximal current was no more 1 mA, does not exceed 10 mW. Therefore, the effect of the Joule heating can be neglected. Also, the measurements of all samples showed that the voltage drop across the electric contacts does not exceed (1 – 10) % of the total voltage drop on the sample. Specifically, no more than 1 % for the nanoflake samples formed at 130, 140, 160 and 180°C, and less than 10 % for the nanoflake samples formed at 150°C.

The I-V curves of the compressed MoS_xO_y nanoflakes formed at 150°C are characterized by the presence of the pronounced part of the negative slope, i.e., negative differential conductivity and strong resistive effect between the forward and backward branches (see e.g., **Fig. 6(a)**). The behavior of the I-V curves of the compressed MoS_xO_y nanoflakes, synthesized at lower (i.e., 130 and 140°C) or higher (e.g., 160°C) temperatures, is close to the ohmic behavior with a very small hysteresis between the forward and backward branches (see e.g., **Fig. 6(b)**). The most pronounced hysteresis is observed in the most conductive sample S4. We also should note that at the temperatures of synthesis above 160°C the behavior of the I-V curves belongs to the second type.

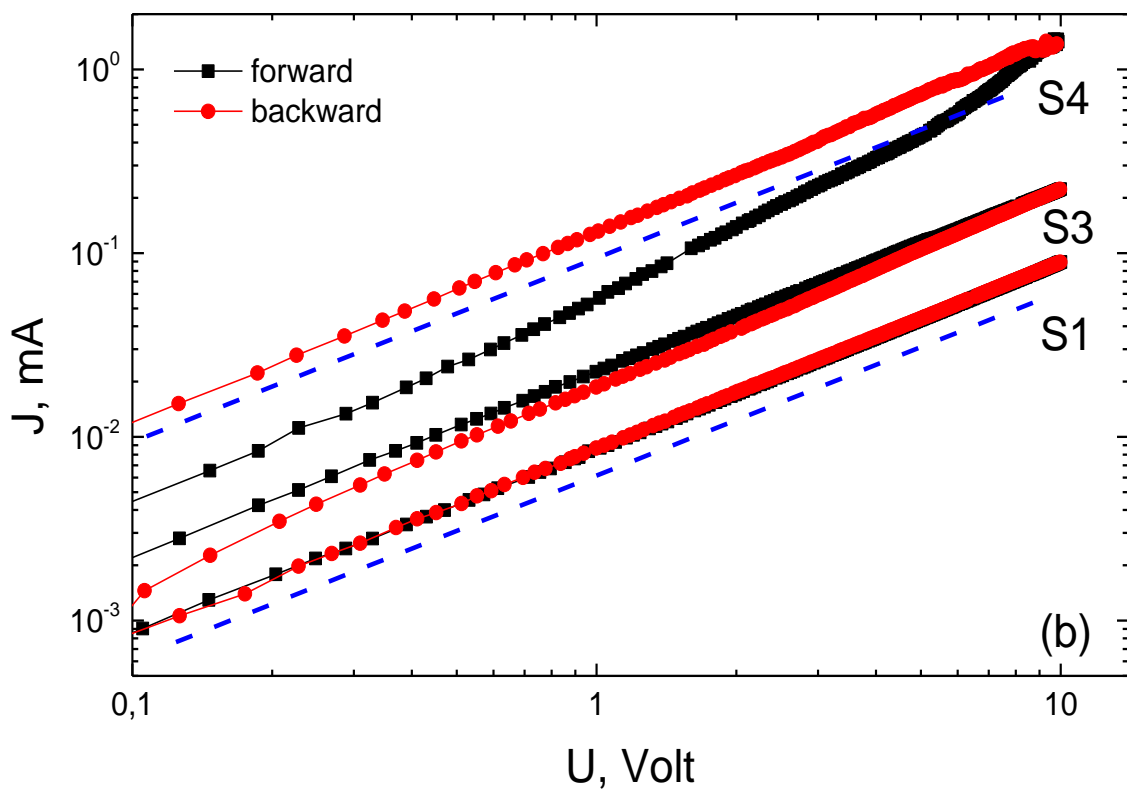
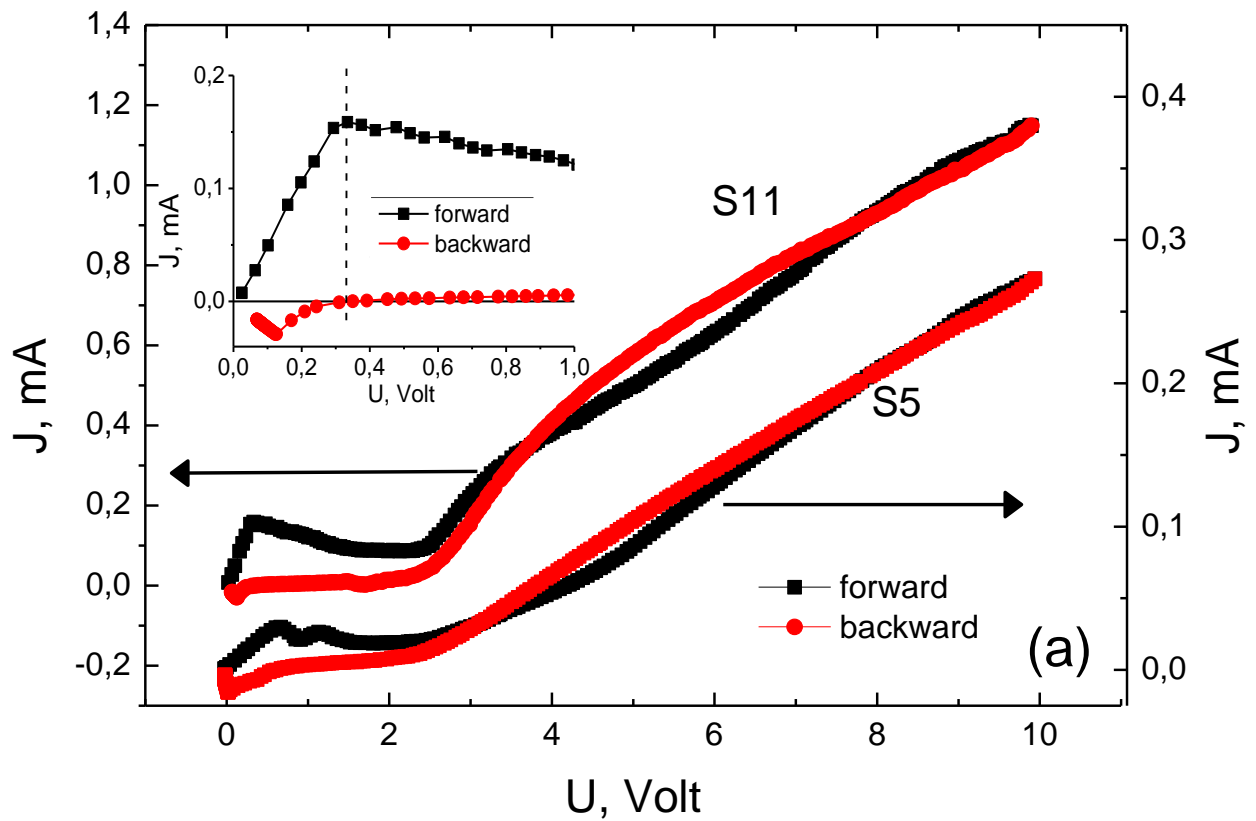

Figure 6. (a) The I-V curves of the compressed MoS_xO_y nanoflakes, formed at 150°C , which reveal the pronounced NDC part. Zoomed NDC part in the forward and backward IVC branches is shown in the inset. (b) The I-V curves of the compressed MoS_xO_y nanoflakes, formed at the lower

temperature (from 132 to 140°C). The blue dashed lines correspond to the ohmic behavior of the I-V curves.

The dependence of the compressed MoS_xO_y nanoflakes resistance on the applied voltage is shown in **Fig. 7**. The samples of the first type (synthesized at 150°C) manifest a pronounced effect of the resistive switching from the “low” to “high” resistive states between the forward and backward branches of the I-V curves (see the curves with black and red symbols in **Fig. 7(a)**). The samples of the second type (synthesized at 130, 140 and 160°C) demonstrate very weak and non-systematic switching (see the curves with black and red symbols in **Fig. 7(b)**).

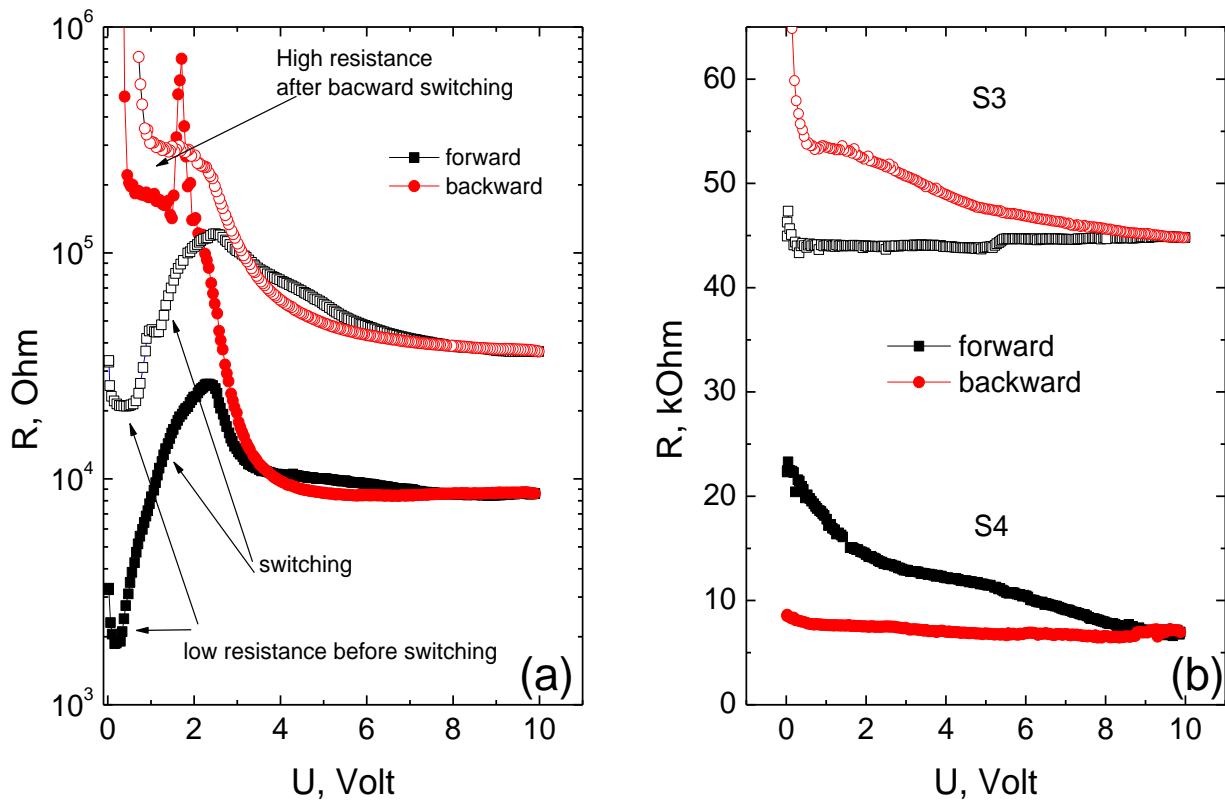

Figure 7. The forward and backward branches of the resistance of compressed MoS_xO_y nanoflakes vs. the applied voltage. The temperature of nanoflake synthesis is 150 °C **(a)** and lower **(b)**.

Figure 7(a) demonstrates the resistive switching in the first type of the nanoflake samples. These dependences are calculated from the I-V curves shown in **Fig. 6**. It is seen that the NDC part begins at a quite small voltage drop (about 0.4 V), and the resistivity increases by an order of magnitude and reaches the plateau at about 4 V. On the backward branch, the resistance again increases at least by an order of magnitude at voltages less than about 4 V and remains high down to the smallest voltage drop. It is seen from **Fig. 6(a)**, that the current changes its sign at the lowest

voltage drop at the backward branch. This evidences the discharge process and returning to the initial state. The obtained results reveal that the MoS_xO_y nanoflakes formed at 150°C have an additional metastable state characterized by a lower conductivity in the studied nanopowders. Under the application of electric field, the charge carriers transfer to the metastable state. Note that, as is shown below, the samples with the NDC demonstrate very long duration of the charge/discharge processes on applying voltage with the magnitude of a few volts. This effect supports our suggestion about the charge carriers transfer to the metastable state.

The resistive switching curves for the second type of samples are presented in **Fig. 7(b)**. It is seen that the high/low resistance (HR/LR) ratio between the forward and backward branches is much less for the second type of samples. Furthermore, it may be both HR/LR and LR/HR switching among the samples. In general, the lower the temperature of synthesis, the less noticeable the switching ratio is. The I-V curves of the samples formed at 132°C (see the curves “S1” in **Fig. 6(b)**) are almost linear without any hysteresis features. The I-V curves of the samples synthesized at 140°C (see the curves “S3” in **Figs. 6(b) and 7(b)**) show some deviation from the linear ohmic behavior and reveal a small hysteresis. The sample resistivity in the forward branch is almost constant, being lower compared to the resistivity of the samples formed at 132°C , and equal about $45\text{ k}\Omega$ at 290 K . The samples synthesized at 160°C and 180°C belong to the second type (see e.g., the curves “S4” in **Fig. 7(b)**). They have more pronounced hysteresis with both HR to LR switching and LR to HR switching, as well as the smallest resistance among the second type of nanoflake samples.

Thus, we reveal the anomaly of the electro-transport characteristics in the series of MoS_xO_y nanoflake samples formed at 150°C . The anomaly consists in the distinction in the contents of oxide/sulfoxide components, which may change energy spectrum, possibly forming metastable states, so that enables to transfer charge particles from the high mobility states to the low mobility states by strong enough electric fields. Another possible explanation of the observed anomaly can be the suggestion that a part of charge carriers may draw in the strong electric field from the conducting state to the localized state. This issue needs additional studies.

The nanoflakes formed at other temperatures also have hysteresis loop-like I-V curves, though much less expressed and closer to that of the chemically pure MoS_2 I-V curves [17]. Its nature also needs additional experimental studies to obtain a comprehensive explanation.

The results obtained for the samples with the N-shaped I-V curves are promising for memristor applications based either on the charge transfer between metastable states or creation of highly conductive filaments [52, 53, 54]. The nanoflake samples with N-shaped I-V curves enable them to make a three-level memristor.

The structures perspective for the resistive switching may be also promising for the charge accumulation devices. To study the charge accumulation in the nanoflake samples synthesized at

150°C the following experiment was performed. The voltage pulse with the 2 V amplitude and 90 sec duration was applied to the sample, and the current vs time through the sample was recorded. Then, after 90 seconds the circuit was disconnected, the sample was switched to the no-load regime, and the decay of the sample voltage across the sample was recorded. When we break the circuit, i.e., switch to the no load regime, then, first, there is a jumping decrease in voltage on the sample by approximately two times, and then a long-term drop in the voltage is associated with the transport of ions [17]. The jumping decrease may be related to fast polarization processes unrelated with the redistribution of the ion space charge. The traces of the current decay after switching the voltage “on” and voltage decay after switching the voltage “off” are shown in **Fig. 8**. It is seen that both the voltage switching “on” and “off” results in a very long-term charge accumulation and discharge, respectively.

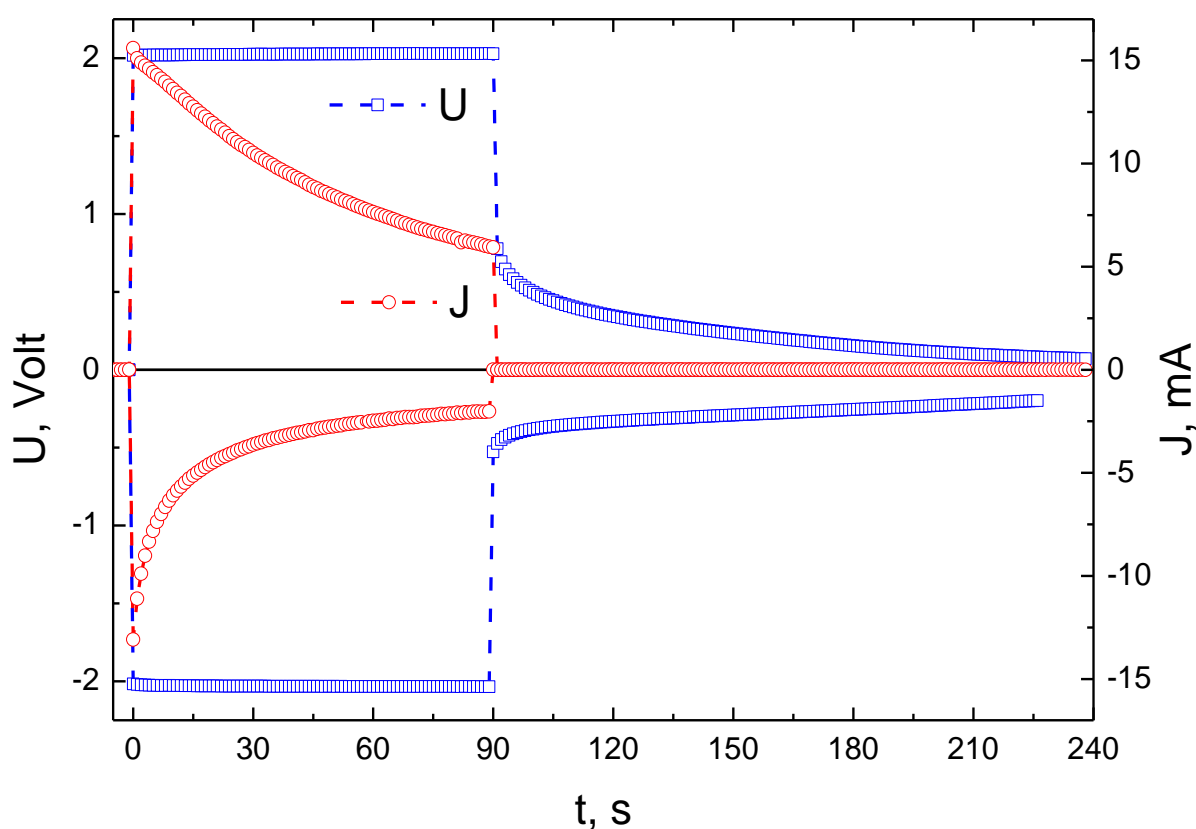

Figure 8. Charging and discharging of the compressed MoS_xO_y nanoflakes formed at 150°C.

Summarizing the results on electric transport properties of the compressed MoS_xO_y nanoflakes, we conclude that the properties strongly correlate with their structural features studied by different methods. Namely, the temperature of synthesis affects substantially and similarly both on the structure and the conductivity mechanism. In a wide range of formation temperatures, except the narrow vicinity of 150°C, the I-V curves have a monotonic behavior with a hysteresis loop between the direct (increasing voltage) and backward (decreasing voltage) branches, which is pronounced (or not) depending on the temperature of synthesis. The I-V curve of the nanoflake sample formed at 150°C

has a distinctive N-shaped behavior with the negative differential conductivity part. All the samples (according to EDS and XPS studies) contain a high content of the oxygen and sulfoxides compounds, while there is a noticeable difference in the oxygen/sulfoxide ratio the sample with $T_S = 150^\circ\text{C}$ and other samples. The NDC-type of nanoflake samples is promising both for memristor and charge accumulation applications.

B. Theoretical modelling

Modern theory of resistive switching originates from Strukov et al. [55, 56, 57], who demonstrated that memristive behavior can be inherent to thin semiconductor films, at that the memory resistance depends on the thickness ratio of the doped and pure regions of the semiconductor.

Note, that the flexo-chemical strains can be the reason of resistive switching observed in thin semiconducting films with a mixed ionic-electronic conductivity [58], and the bending effects can influence very strongly the conductivity of the LD TMD [36]. Since we observed I-V curves, which belong to memristor type [59, 60], the model describing the memristive switching should be used.

Though one can expect pronounced resistive switching effects and strong correlation between the nonlinear current-voltage and strain-voltage response of the suppressed TMD nanoflakes, the latter was not studied theoretically. Intentions to fill the gap in the knowledge motivated us to perform self-consistent modelling of nonlinear electric transport and electromechanical response of the oxidated TMD nanoflakes allowing for steric effects of mobile defects (i.e., aggregation of ions or vacancies), flexoelectricity and flexo-chemical coupling with the Vegard strains and/or strains appeared (or restored) during the nanoflakes formation.

To apply the memristive switching models to describe the experimentally observed I-V curves one should use some hypothesis of the possible origin and physical nature of the mobile charges in the studied nanoflakes.

The strong bending of the oxidated free-standing nanoflake may occur due to the flexo-electric field effect, and the effect can also change the bending degree up to the appearance of the symmetry lowering in the nanoflake. Notably, that the effect magnitude can be critically sensitive to the concentration of elastic defects, which (in their turn) can depend very strongly and nonmonotonically on the synthesis conditions (especially when we speak about oxygen states).

According to the model of sliding flexo-ferroelectricity [41], the charge Q_{flexo} accumulated by the nanoflake due to the flexoelectric coupling can be estimated from the following relation:

$$Q_{flexo} \approx \iiint_0^V \text{div}(\vec{P}_{flexo}) dV \approx \iiint_0^V f_{ijkl} \frac{\partial^2 u_{kl}^{flexo}}{\partial x_i \partial x_j} dV \approx \iiint_0^V f_{ijkl} \left(q_{klmn} \frac{\partial^2}{\partial x_i \partial x_j} (E_k^{loc} E_l^{loc}) + z_{klmnop} \frac{\partial^2}{\partial x_i \partial x_j} (E_k^{loc} E_l^{loc} E_o^{loc} E_p^{loc}) + z'_{klmnoprs} \frac{\partial^2}{\partial x_i \partial x_j} (E_k^{loc} E_l^{loc} E_o^{loc} E_p^{loc} E_r^{loc} E_s^{loc}) + \dots \right) dV, \quad (1)$$

where V is the nanoflake volume, \vec{P}_{flexo} is the flexoelectric polarization, f_{ijkl} is the flexoelectric tensor, u_{kl}^{flexo} is the flexoelectric deformation, q_{klmn} is the second-order electrostriction tensor, z_{klmnop} is the fourth-order electrostriction tensor, etc. Notably, strong bending requires the consideration of the higher-order electrostriction couplings. E_k^{loc} is the component of the local electric field induced by the homogeneous external field and inhomogeneous flexo-chemical field, i.e., $E_k^{loc}(\vec{r}, t) = E_k^{ext}(t) + \delta E_k^{f-c}(\vec{r}, t)$. Hereinafter, we consider the case when the flexo-chemical strain is linearly proportional to the distributed concentration of the random elastic defects $\delta C(\vec{r})$ (the Vegard law for chemical strains [61, 62]). The statistic average $\langle\langle \frac{\partial^2}{\partial x_i \partial x_j} \delta C \rangle\rangle = 0$ (as well as for all odd powers).

The calculations of the local field are very complex, since the field depends in a self-consistent way on the flake bending, defects concentration and distribution, as well as on the electric state of surrounding nanoflakes and their concentration. Nevertheless, since the field is induced by the application of the electric voltage U , which can change the flake shape, it is reasonable to assume that its amplitude is proportional to the applied voltage, $E_k^{loc} \sim U(1 + \delta C)$ at small U , and saturates under the voltage increase. Assuming the nonzero mean-square statistic average $\langle\langle \delta C \frac{\partial^2}{\partial x_i \partial x_j} \delta C \rangle\rangle$, the Q_{flexo} can be expanded in series over the even powers of the applied voltage:

$$Q_{flexo} \cong \frac{Q_1 U^2 + Q_2 U^4 + Q_3 U^6}{1 + D_3 U^6}, \quad (2)$$

where the coefficients Q_i are proportional to the corresponding integrals in Eq.(1), e.g., $Q_1 = \frac{1}{U^2} \iiint_0^V f_{ijkl} q_{klmn} \langle\langle \frac{\partial^2}{\partial x_i \partial x_j} E_k^{loc} E_l^{loc} \rangle\rangle dV$, etc., and the constant D_3 originates from the local field saturation at high voltages.

Equation (2) describes phenomenologically the nonlinear static dependence of the accumulated charge, which is one possible contribution to the electric charge-discharge process. Other charge accumulation processes, leakage and discharge mechanisms may be responsible for the hysteresis-like differences of the forward and backward branches of the I-V curves (see e.g., Ref.[63]). Following Ref.[63], we can assume that the space charges can be trapped by the sites of different shapes and sizes corresponding to interfaces and intersections of nanoflakes in the compressed powder. The charge dynamics is conditioned by the charge trapping in one site and release from the site due to the leakage effect, as well as by the trapping in another site and eventual escape from the capacitor after a huge amount of trapping and release, further associated with the hopping conduction mechanism. A negligibly small number of charges can enter and exit the capacitor with TMD nanoflakes without undergoing trapping-and-release steps.

Considering the hopping and leakage effects, as well as the sliding flexo-ferroelectric and flexo-chemical contribution to the charge accumulation, the electric current density j can be estimated as:

$$\vec{j} = \varepsilon_0 \frac{d\vec{E}}{dt} + \frac{d\vec{P}_{flexo}}{dt} + \vec{j}_{hopping} + \vec{j}_{leakage}. \quad (3a)$$

Here ε_0 is the universal dielectric constant. Corresponding electric current is [41, 63]:

$$I = C_0 \frac{dU}{dt} + \frac{dQ_{flexo}}{dt} + \left(G_0 + \frac{e\mu}{L^2} \delta n \right) U. \quad (3b)$$

Here we used that $E = U/L$, $C = \varepsilon_0 \varepsilon S/L$ is the effective capacitance (L is the width and S is the surface area, $V = SL$). The sum $G_0 + \frac{e\mu}{L^2} \delta n$ is the residual leaking conductance and the hopping mobility contributions. It maybe $G_0 \gg \frac{e\mu}{L^2} \delta n$, where μ is the mobility of nonequilibrium carriers with the charge density $e\delta n$.

Using Eq.(2) and (3b), the phenomenological relation for the I-V curves fitting acquires the form:

$$I(U) \approx \frac{U}{R_0} + \frac{dU}{dt} \left(C_0 + \frac{2Q_1U + 4Q_2U^3 + 6Q_3U^5}{1 + D_3U^6} \right) + \frac{1}{1 + D_3U^6} \left(\frac{dQ_1}{dt} U^2 + \frac{dQ_2}{dt} U^4 + \frac{dQ_3}{dt} U^6 \right), \quad (4a)$$

where R_0 is the resistance in the linear approximation (without consideration of the sliding flexo-ferroelectricity and elastic defects), and so $\frac{1}{R_0} \cong G_0 + \frac{e\mu}{L^2} \delta n$. The nonlinear terms originate from the flexo-chemical strains. Hereinafter the phenomenological coefficients Q_i and the saturation rate D_3 are treated as the fitting parameters for I-V curves, which signs and values depend on the synthesis conditions. From Eq.(4a), the resistivity can be introduced as:

$$R(U) = \frac{U}{I(U)}. \quad (4b)$$

If the electric discharge time τ is much longer than the voltage step delay τ_V , we can use the approximate equalities $\frac{dU}{dt} \approx \frac{U}{\tau_V}$ and $\frac{dQ_i}{dt} \approx \frac{Q_i}{\tau}$ and the strong inequality $\frac{1}{\tau} \ll \frac{1}{\tau_V}$ in Eq.(4a). Indeed, the voltage step delay is 2 s, and the discharge time is much more than 20 s (see **Fig. 8**). The circumstance allows to approximate Eqs.(4) in the quasi-static limit as:

$$I(U) \approx U \left(\frac{1}{R_0} + \frac{1}{\tau_V} \left[C_0 + \frac{2Q_1U + 4Q_2U^3 + 6Q_3U^5}{1 + D_3U^6} \right] \right), \quad (5a)$$

$$R(U) = \frac{R_0}{1 + \frac{R_0}{\tau_V} \left[C_0 + \frac{2Q_1U + 4Q_2U^3 + 6Q_3U^5}{1 + D_3U^6} \right]}. \quad (5b)$$

Equations (5) describe phenomenologically the nonlinear static dependence of the accumulated charge, but they cannot explain the differences between the forward and backward branches of the I-V and R-V curves observed experimentally (see **Figs. 6 and 7**). To do this a phase delay between the ohmic resistance and capacitance should be considered. The delay leads to a more cumbersome equation for complex amplitudes of the current (\tilde{I}) and voltage (\tilde{U}):

$$\tilde{I}(U) \approx \frac{\tilde{U}}{R_0} \left(1 + \frac{C_1 U + C_2 U^3 + C_3 U^5}{1 + D_3 U^6} + i\omega R_0 C_0 \left[1 + \frac{D_1 U + D_2 U^3 + D_3 U^5}{1 + D_3 U^6} \right] \right), \quad (6)$$

The fitting parameters C_i are related with the parameters D_i as $D_1 = 2 \frac{C_1 C_0}{\tau}$, $D_2 = 4 \frac{C_2 C_0}{\tau}$ and $D_3 = 6 \frac{C_3 C_0}{\tau}$. Note that τ can be a fitting parameter.

The I-V curves and resistivity calculated from Eqs.(6) for the curved TMD nanoflakes at increasing magnitude of the flexo-chemical strain are shown in **Fig. 9**. Red and blue curves correspond to the direct (increase) and inverse (decrease) direction of the voltage cycling. It is seen that the shape of the I-V curves, their slope, current and voltage scales resemble the experimentally measured I-V curves shown in **Fig. 6**. The increase in the flexo-chemical strains leads to the transition of the quasi-linear I-V curves (**Fig. 9(a)**) to the curves with the NDR region in the actual voltage range (**Fig. 9(b)**). The voltage dependences of the corresponding resistances contain the regions of NDR at least for the direct run of the voltage sweep (see **Figs. 9(c)-(d)**). To summarize, the proposed model may explain the observed polar and electronic properties of the oxidated TDM nanoflakes.

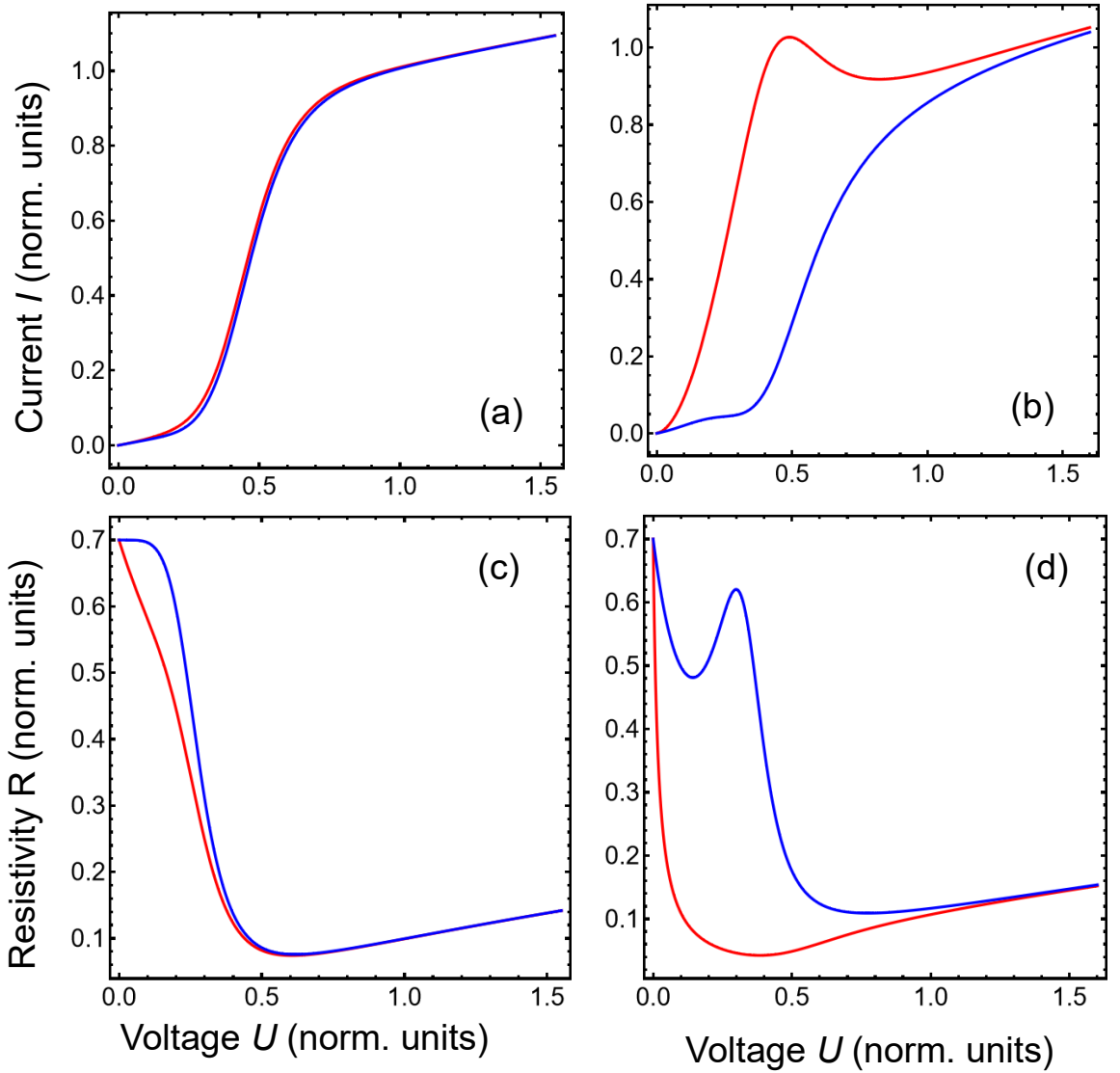

Figure 9. I-V curves (**a-b**) and resistivity (**c-d**) calculated for the oxidated TMD nanoflakes at increasing magnitude of the flexo-chemical strain, which is small for the plots (**a, c**), and large for the plots (**b, d**). Red and blue curves correspond to the direct (increase) and inverse (decrease) direction of the voltage sweep. The plots are calculated in normalized units. Fitting parameters are listed in **Table 4**.

Table 4. Fitting parameters (in dimensionless units)

Fitting parameter	Small flexo-chemical strain	Large flexo-chemical strain
R_0	70	70
C_1	0.2 (forward) – 0 (backward)	5.5 (forward) – 0.55 (backward)
C_2	0	-0.1
C_3	0.0055	0.0055
D_3	0.00009	0.00009

III. SUMMARY

We synthesized the powder of molybdenum-disulfide-oxide nanoflowers consisting of self-assembled 10-20 nm thin nanoflakes. The detailed analysis of the XPS, EDS and Raman spectroscopy results reveals the significant amount of the molybdenum oxides and sulfoxides in the presumably molybdenum disulfide nanoflakes, which allows to consider the “effective” formulae MoS_xO_y for their chemical composition.

The MoS_xO_y nanoflakes reveals unusual electric transport features interesting for material science and promising for applications. The chemical composition and microstructure of the nanoflakes, which are determined by the temperature of synthesis, are shown to be responsible for the electro-conduction mechanism. Namely, the current-voltage characteristics (I-V curves) grow monotonically with the applied voltage at the temperatures of synthesis $T_s \ll 150^\circ\text{C}$ and $T_s \gg 150^\circ\text{C}$, being non-ohmic and hysteretic at lower voltages and becoming close to the ohmic at higher voltages. The I-V curves acquire N-like shape with a strongly pronounced negative differential resistivity (NDR) part at $T_s = 150^\circ\text{C}$. Both with and without N-shape, the I-V curves manifest hysteretic behavior with the difference between increasing and decreasing voltage sweeps, and the hysteresis loop parameters are determined by the temperature of synthesis. Important, that the studied nanoflakes manifest very long living deep charging and discharging after the voltage switching of “on” and “off”.

It is well-known that the presence of oxygen non-stoichiometry and bending can create strong flexo-chemical strains in the individual nanoflakes in the suppressed state of their dense powder. Taking this into account, we proposed the flexo-chemical model of the polar and electro-transport properties of the pressed MoS_xO_y nanoflakes, which describe the observed I-V curves. The revealed experimentally and explained features of memristive resistive switching and charge accumulation in

the MoS_xO_y nanoflakes look promising for applications in memristors and high-performance supercapacitors based on the nanoflakes.

Acknowledgments. Synthesis of samples (A.V.T. and S.V.K.) was supported by the National Academy of sciences, project “Development of composites based on sulfides of metals of the 6 and 7 group and porous carriers for liquid-phase selective catalytic hydrogenation of halogen-containing heterocyclic compounds. Structural study (G.I.D) was supported by Joensuu Foundation Project Decision number 359463. Electrophysical measurements (O.S.P.) are supported by the Ministry of Science and Education of Ukraine (grant № PH/ 23 – 2023 and № 1/PH/23-2024, “Influence of size effects on the electrophysical properties of graphene-ferroelectric nanostructures”), as well as by the Target Program of the National Academy of Sciences of Ukraine, Project No. 4.8/23-p (V.N.P. and V.V.V). The theoretical work of A.N.M. is supported by the DOE Software Project on “Computational Mesoscale Science and Open Software for Quantum Materials”, under Award Number DE-SC0020145 as a part of the Computational Materials Sciences Program of US Department of Energy, Office of Science, Basic Energy Sciences. Analytical results, presented in this work, are visualized in Mathematica 14.2 [64].

Author contributions. O.S.P., V.V.V. and V.N.P. conceived, performed and analyzed results of the electrophysical experiments. A.V.T. and S.V.K. prepared the samples and characterized them by SEM and EDS. A.S.N. and V.I.P. performed Raman studies. A.S.N., M.V.O. and G.I.D. analyzed the spectra. G.I.D. and O.B. performed TEM and analyzed obtained results. A.S.T. performed XRD analysis. T.S. and B.M.R. performed XPS measurements. A.N.M. proposed the model for interpretation of the experimental results. V.V.V. and A.N.M. wrote the manuscript draft, and all authors participate in its improvement.

Appendix A

Samples preparation. Samples were prepared by reaction of $(\text{NH}_4)_6\text{Mo}_7\text{O}_{24}$ with thiourea in aqueous solution at temperatures from 130°C to 180°C in hydrothermal conditions. In typical procedure, 1.23 g (0.001 mol) of $(\text{NH}_4)_6\text{Mo}_7\text{O}_{24}\cdot 4\text{H}_2\text{O}$ and 2.285 g (0.03 mol) of thiourea were dissolved in 35 mL of distilled water with stirring for 30 min at 40 °C. The solution was placed in a Teflon reaction beaker in a steel autoclave with a capacity of 100 mL and kept in a thermostat unit for 20 hours at certain temperature (T_s). After this time, the autoclave was cooled down to room temperature, and the solid phase was separated from the reaction mixture by centrifugation. The resulting black product was washed with distilled water (3×20 ml), then by absolute ethanol (20 ml) and dried at 65 °C during 10-12 h. The compounds were stored on air without special precautions.

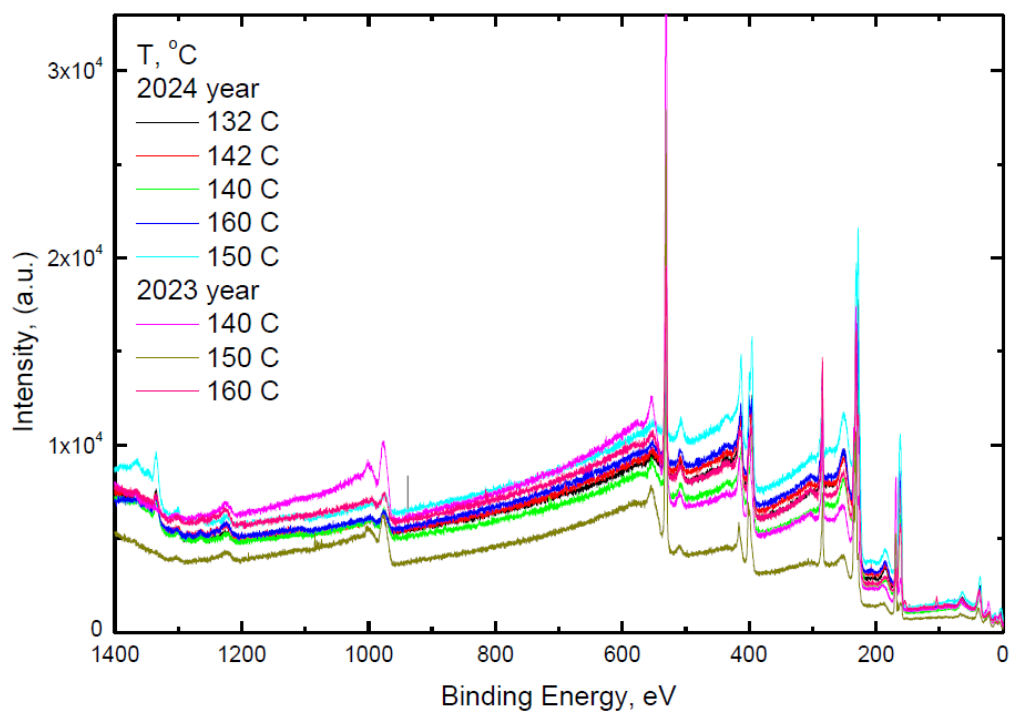

Figure A1. XPS spectra the MoS₂ nanoflowers formed at temperatures T_S from 132°C to 160°C. Green curves correspond to the as-prepared samples (2024 year) and blue curves correspond to the aged samples (2023 year).

References

- [¹] Shrouq H. Aleithan, Kawther Al-Amer, Zakia Alhashem, Nada A. Alati, Zainab H. Alabbad, and Khan Alam. "Growth of MoS₂ films: High-quality monolayered and multilayered material." *AIP Advances* 12, no. 7 (2022): 075220. <https://doi.org/10.1063/5.0086228>
- [²] Wang, F., Zheng, M., Zhang, B. et al. Ammonia intercalated flower-like MoS₂ nanosheet film as electrocatalyst for high efficient and stable hydrogen evolution. *Sci Rep* 6, 31092 (2016). <https://doi.org/10.1038/srep31092>
- [³] A comparative study on the electrochemical capacitor performance of 1T/2H hybridized phase and 2H pure phase of MoS₂ nanoflowers *Nanotechnology* (2021) DOI:10.1088/1361-6528/ac2e24
- [⁴] Charapale, M.R., Dongale, T.D., Patil, O.A. et al. Hierarchical 3D flowers of 1T@2H-MoS₂ assembled with an array of ultrathin nano-petals for high-performance supercapacitor electrodes. *J Solid State Electrochem* 28, 181–195 (2024). <https://doi.org/10.1007/s10008-023-05676-7>
- [⁵] Xinmao Yin, Qixing Wang, Liang Cao, Chi Sin Tang, Xin Luo, Yujie Zheng, Lai Mun Wong et al. "Tunable inverted gap in monolayer quasi-metallic MoS₂ induced by strong charge-

lattice coupling." *Nature communications* 8, no. 1 (2017): 486. <https://doi.org/10.1038/s41467-017-00640-2>

[⁶] M.A. Rodder, and A. Dodabalapur. "Modeling of a back-gated monolayer MoS₂ FET by extraction of an accurate threshold voltage and gate-bias-dependent source/drain resistance." *IEEE Journal of the Electron Devices Society* 5, no. 5 (2017): 384-389.

<https://doi.org/10.1109/JEDS.2017.2722458>

[⁷] Maksym V. Strikha, Mykola Yelisiiev, and Anna N. Morozovska. Fundamental miniaturization limits for MOSFETs with a monolayer MoS₂ channel *Appl. Phys. Lett.* 119, 042102 (2021); <https://doi.org/10.1063/5.0056720>

[⁸] Swapnil S. Karade, Deepak P. Dubal, and Babasaheb R. Sankapal. "MoS₂ ultrathin nanoflakes for high performance supercapacitors: room temperature chemical bath deposition (CBD)." *RSC advances* 6, no. 45 (2016): 39159-39165. <https://doi.org/10.1039/C6RA04441G>

[⁹] S. Song, D. H. Keum, S. Cho, D. Perello, Y. Kim, and Y. H. Lee, "Room Temperature Semiconductor–Metal Transition of MoTe₂ Thin Films Engineered by Strain," *Nano Lett.*, vol. 16, no. 1, pp. 188–193, Jan. 2016, DOI: 10.1021/acs.nanolett.5b03481.

[¹⁰] Vaibhav Varade, Golam Haider, Luka Pirker, Jaganandha Panda, Jan Sykora, Otakar Frank, Martin Kalbac, and Jana Vejpravova. "Sulfur isotope engineering of exciton and lattice dynamics in monolayers." *2D Materials* 10, no. 2 (2023): 025024. <https://doi.org/10.1088/2053-1583/acc4d8>

[¹¹] Anna N. Morozovska, Eugene A. Eliseev, Galina I. Dovbeshko, Maya D. Glinchuk, Yunseok Kim, and Sergei V. Kalinin. Flexo-induced ferroelectricity in low dimensional transition metal dichalcogenides. *Phys. Rev. B* 102, 075417 (2020)

<https://link.aps.org/doi/10.1103/PhysRevB.102.075417>

[¹²] P. Johari and V. B. Shenoy, "Tuning the Electronic Properties of Semiconducting Transition Metal Dichalcogenides by Applying Mechanical Strains," *ACS Nano*, vol. 6, no. 6, pp. 5449–5456, Jun. 2012, DOI: 10.1021/nn301320r.

[¹³] J. Berry, S. Zhou, J. Han, D. J. Srolovitz, and M. P. Haataja, "Domain morphology and mechanics of the H/T' transition metal dichalcogenide monolayers," *Phys. Rev. Mater.*, vol. 2, no. 11, p. 114002, Nov. 2018, DOI: 10.1103/PhysRevMaterials.2.114002.

[¹⁴] Berry J. Domain morphology and mechanics of the H/T' transition metal dichalcogenide monolayers / Berry J., Zhou S., Han J. et al. // *Phys. Rev. Mater.* – 2018. – Vol. 2. – P. 114002. DOI: 10.1103/PhysRevMaterials.2.114002.

[¹⁵] Kang S. Tunable out-of-plane piezoelectricity in thin-layered MoTe₂ by surface corrugation-mediated flexoelectricity / Kang S., Jeon S., Kim S. et al. // *ACS Appl. Mater. Inter.* – 2018. – Vol. 10. – P. 27424. DOI: 10.1021/acsami.8b06325.

-
- [16] J. Berry, S. Zhou, J. Han, D. J. Srolovitz, and M. P. Haataja, "Dynamic Phase Engineering of Bendable Transition Metal Dichalcogenide Monolayers," *Nano Lett.*, vol. 17, no. 4, pp. 2473–2481, Apr. 2017, DOI: 10.1021/acs.nanolett.7b00165.
- [17] V. V. Vainberg, O. S. Pylypchuk, V. N. Poroshin, M. V. Olenchuk, G. I. Dovbeshko, and G. P. Monastyskyi. "Transient processes in electric transport in the powder MoS₂ samples." *Journal of Applied Physics*, 131, 234301 (2022), <https://doi.org/10.1063/5.0090012>
- [18] Li Li, Jiyang Chen, Keyue Wu, Chunbin Cao, Shiwei Shi, and Jingbiao Cui. "The Stability of Metallic MoS₂ nanosheets and their property change by annealing." *Nanomaterials* 9, no. 10 (2019): 1366. <https://doi.org/10.3390/nano9101366>
- [19] Rosy Rahman, Manobina Karmakar, Dipanjan Samanta, Amita Pathak, Prasanta Kumar Datta, and Tapan Kumar Nath. "One order enhancement of charge carrier relaxation rate by tuning structural and optical properties in annealed cobalt doped MoS₂ nanosheets." *New Journal of Chemistry* 46, no. 4 (2022): 1877-1895. <https://doi.org/10.1039/D1NJ05446E>
- [20] Gongying Chen, Benchu Lu, Xinyu Cui, and Jianrong Xiao. "Effects of deposition and annealing temperature on the structure and optical band gap of MoS₂ films." *Materials* 13, no. 23 (2020): 5515. <https://doi.org/10.3390/ma13235515>
- [21] Goki Eda, Hisato Yamaguchi, Damien Voiry, Takeshi Fujita, Mingwei Chen, and Manish Chhowalla. "Photoluminescence from chemically exfoliated MoS₂." *Nano letters* 11, no. 12 (2011): 5111-5116. <https://doi.org/10.1021/nl201874w>
- [22] M.Z. Xie, J. Y. Zhou, H. Ji, Y. Ye, X. Wang, K. Jiang, L. Y. Shang, Z. G. Hu, and J. H. Chu. "Annealing effects on sulfur vacancies and electronic transport of MoS₂ films grown by pulsed-laser deposition." *Applied Physics Letters* 115, no. 12 (2019): 121901. <https://doi.org/10.1063/1.5116174>
- [23] Weigang Lu, Blake Birmingham, and Zhenrong Zhang. "Defect engineering on MoS₂ surface with argon ion bombardments and thermal annealing." *Applied Surface Science* 532 (2020): 147461. <https://doi.org/10.1016/j.apsusc.2020.147461>
- [24] Krishna Hari Sharma, Da-Ren Hang, Satish Bolloju, Jyh-Tsung Lee, Hui-Fen Wu, Sk Emdadul Islam, Mitch M.C. Chou, Chi-Te Liang d, Rupesh Rohan Srivastava. Two-dimensional molybdenum trioxide nanoflakes wrapped with interlayer-expanded molybdenum disulfide nanosheets: Superior performances in supercapacitive energy storage and visible-light-driven photocatalysis. *International Journal of Hydrogen Energy* V 46, Issue 70, 11 October 2021, Pages 34663-34678
- [25] Zusong Zhua, Dequan Zhu, Guisheng Jiang, Lihua Zhang, Shengbao Zhan, Jun Wen, and Jiancun You. Synthesis and characterization of large-sized monolayer MoS₂ nanoflakes by

sulfurization of exfoliated MoO₃ powder. *AIP Advances* **12**, 035016 (2022); doi:
10.1063/5.0076711.

[²⁶] G.E. Yakovleva, A. S. Berdinsky, A. I. Romanenko, S. P. Khabarov and V.E. Fedorov. The conductivity and TEMF of MoS₂ with Mo₂S₃ additive. MIPRO 2015, 25-29 May 2015, Opatija, Croatia.

[²⁷] Wei Hau Low, Poi Sim Khiew, Siew Shee Lim, Chiu Wee Siong, Ejikeme Raphael Ezeigwe. Recent development of mixed transition metal oxide and graphene/mixed transition metal oxide based hybrid nanostructures for advanced supercapacitors. *Journal of Alloys and Compounds* **775** (2019) 1324-1356.

[²⁸] Shuang Yuan, Xiao Duan, Jiaqi Liu, Yun Ye, Fusen Lv, Tie Liu, Qiang Wang, Xinbo Zhang. Recent progress on transition metal oxides as advanced materials for energy conversion and storage. *Energy Storage Materials* **42** (2021) 317–369.

[²⁹] D. A. Freedman, D. Roundy, and T. A. Arias. Elastic effects of vacancies in strontium titanate: Short- and long-range strain fields, elastic dipole tensors, and chemical strain. *Phys. Rev. B* **80**, 064108 (2009), <https://doi.org/10.1103/PhysRevB.80.064108>

[³⁰] Y. Kim, A. S. Disa, T. E. Babakol, and J. D. Brock. Strain screening by mobile oxygen vacancies in SrTiO₃. *Appl. Phys. Lett.* **96**, 251901 (2010), <https://doi.org/10.1063/1.3455157>

[³¹] Anna N. Morozovska, Eugene A. Eliseev, Kevin D. Stubbs, Rama Vasudevan, Yunseok Kim, and Sergei V. Kalinin. Phase Diagrams of Single Layer Two-Dimensional Transition Metal Dichalcogenides: Landau Theory. *Phys. Rev. B*, **101**, 195424 (2020)
<https://link.aps.org/doi/10.1103/PhysRevB.101.195424>

[³²] Rama K. Vasudevan, Maxim Ziatdinov, Lukas Vlcek, Anna N. Morozovska, Eugene A. Eliseev, Shi-Ze Yang, Yongji Gong, Pulickel Ajayan, Wu Zhou, Matthew F. Chisholm, Sergei V. Kalinin. Investigating phase transitions from local crystallographic analysis based on statistical learning of atomic environments in 2D MoS₂-ReS₂. *Applied Physics Reviews*, **8**, 011409 (2021)
<https://doi.org/10.1063/5.0012761>

[³³] M.V. Olenchuk, U.K. Afonina, O.P. Gnatyuk, V.V. Strelchuk, A.S. Nikolenko and G.I. Dovbeshko. Heat annealing Influences the optical property of 2D MoS₂ nanoparticles. *Molecular Crystals and Liquid Crystals*, **749**:1, 1-8 (2022) <https://doi.org/10.1080/15421406.2022.2067669>

[³⁴] W. Shi, Y. Guo, Z. Zhang, and W. Guo, "Flexoelectricity in Monolayer Transition Metal Dichalcogenides," *J. Phys. Chem. Lett.*, vol. 9, no. 23, pp. 6841–6846, Dec. 2018, DOI: 10.1021/acs.jpcclett.8b03325.

[³⁵] "Flexoelectricity in Solids: From Theory to Applications". Ed. by A.K. Tagantsev and P.V. Yudin, World Scientific (2016)

-
- [³⁶] A. N. Morozovska, E. A. Eliseev, H. V. Shevliakova, Y. Yu. Lopatina, G. I. Dovbeshko, M. D. Glinchuk, Y. Kim, and S. V. Kalinin. Correlation between corrugation-induced flexoelectric polarization and conductivity of low-dimensional transition metal dichalcogenides. *Phys. Rev. Applied* **15**, 044051 (2021) <https://link.aps.org/doi/10.1103/PhysRevApplied.15.044051>
- [³⁷] K. Yasuda, X. Wang, K. Watanabe, T. Taniguchi, and P. Jarillo-Herrero, Stacking-engineered ferroelectricity in bilayer boron nitride, *Science* **372**, 1458 (2021), <https://doi.org/10.1126/science.abd3230>
- [³⁸] G. Catalan, A. Lubk, A. H. G. Vlooswijk, E. Snoeck, C. Magen, A. Janssens, G. Rispens, G. Rijnders, D. H. A. Blank, and B. Noheda, Flexoelectric rotation of polarization in ferroelectric thin films, *Nat. Mater.* **10**, 963 (2011).
- [³⁹] A. N. Morozovska, R. Hertel, S. Cherifi-Hertel, V. Yu. Reshetnyak, E. A. Eliseev, and D. R. Evans. Chiral Polarization Textures Induced by the Flexoelectric Effect in Ferroelectric Nanocylinders. *Phys.Rev.B* **104**, 054118 (2021) <https://link.aps.org/doi/10.1103/PhysRevB.104.054118>
- [⁴⁰] A. N. Morozovska, E. A. Eliseev, Y. Liu, K. P. Kelley, A. Ghosh, Y. Liu, J. Yao, N. V. Morozovsky, A. L Kholkin, Y. M. Vysochanskii, and S. V. Kalinin. Bending-induced isostructural transitions in ultrathin layers of van der Waals ferrielectrics. *Acta Materialia*, **263**, 119519 (2024), <https://doi.org/10.1016/j.actamat.2023.119519>
- [⁴¹] M. Vizner Stern, Y. Waschitz, W. Cao, I. Nevo, K. Watanabe, T. Taniguchi, E. Sela, M. Urbakh, O. Hod, and M. Ben Shalom, Interfacial ferroelectricity by van der Waals sliding, *Science* **372**, 1462 (2021), <https://doi.org/10.1126/science.abe8177>
- [⁴²] Ri He, Hua Wang, Fenglin Deng, Yuxiang Gao, Binwen Zhang, Yubai Shi, Run-Wei Li, Zhicheng Zhong. Sliding Flexoelectricity in Two-Dimensional van der Waals Systems. <https://doi.org/10.48550/arXiv.2408.00445>
- [⁴³] R. He, B. Zhang, H. Wang, L. Li, P. Tang, G. Bauer, and Z. Zhong, Ultrafast switching dynamics of the ferroelectric order in stacking-engineered ferroelectrics, *Acta Materialia* **262**, Article 119416 (2024), <https://doi.org/10.1016/j.actamat.2023.119416>
- [⁴⁴] R. Bian, R. He, E. Pan, Z. Li, G. Cao, P. Meng, J. Chen, Q. Liu, Z. Zhong, W. Li *et al.*, Developing fatigue-resistant ferroelectrics using interlayer sliding switching, *Science* **385**, N 6704, 57 (2024), <https://doi.org/10.1126/science.adol744>
- [⁴⁵] M. Wu and J. Li, Sliding ferroelectricity in 2D van der Waals materials: Related physics and future opportunities, *Proceedings of the National Academy of Sciences* **118**, e2115703118 (2021), <https://doi.org/10.1126/science.abe8177> .

-
- [46] D. Lee, A. Yoon, S. Y. Jang, J. G. Yoon, J. S. Chung, M. Kim, J. F. Scott, and T. W. Noh, Giant flexoelectric effect in ferroelectric epitaxial thin films, *Phys. Rev. Lett.* **107**, 057602 (2011), <https://doi.org/10.1103/PhysRevLett.107.057602>
- [47] Natanael Cuando-Espitia, Jon Redenius, Kendrick Mensink, Marco Camacho-López, Santiago Camacho-López, and Guillermo Aguilar, "Influence of oxygen pressure on the fs laser-induced oxidation of molybdenum thin films," *Opt. Mater. Express* **8**, 581-596 (2018), <https://doi.org/10.1364/OME.8.000581>
- [48] Guan, X., Ren, Y., Chen, S. *et al.* Charge separation and strong adsorption-enhanced MoO₃ visible light photocatalytic performance. *J Mater Sci* **55**, 5808–5822 (2020), <https://doi.org/10.1007/s10853-020-04418-8>
- [49] Zhang, C. C., L. Zheng, Z. M. Zhang, R. C. Dai, Z. P. Wang, J. W. Zhang, and Z. J. Ding. "Raman studies of hexagonal MoO₃ at high pressure." *physica status solidi (b)* 248, no. 5 (2011): 1119-1122. <https://doi.org/10.1002/pssb.201000633>
- [50] A. Jagminas, G. Niaura, R. Žalneravičius, R. Trusovas, G. Račiukaitis, and V. Jasulaitiene. Laser light induced transformation of molybdenum disulphide-based nanoplatelet arrays. *Scientific Reports* **6**, 37514 (2016), <https://doi.org/10.1038/srep37514>
- [51] M. A. Camacho-López, L. Escobar-Alarcón, M. Picquart, R. Arroyo, G. Córdoba, and E. Haro-Poniatowski. Micro-Raman study of the m-MoO₂ to α -MoO₃ transformation induced by cw-laser irradiation. *Optical Materials* **33**, 480 (2011), <https://doi.org/10.1016/j.optmat.2010.10.028>
- [52] L. O. Chua, *IEEE Trans. Circuit Theory*, **18**, 507 (1971);
- [53] Zhongrui Wang, Huaqiang Wu, Geoffrey W. Burr, Cheol Seong Hwang, Kang L. Wang, Qiangfei Xia and J. Joshua Yang, Resistive switching materials for information processing, *Nature Reviews Materials* volume 5 March 2020 173
- [54] L. O. Chua, S. M. Kang, *Proc. IEEE*, **64**, 209 (1976).
- [55] D. B. Strukov, G. S. Snider, D. R. Stewart, R. S. Williams. The missing memristor found. *Nature*, **453**, 80–83 (2008), <https://doi.org/10.1038/nature06932>
- [56] D. B. Strukov, J.L. Borghetti, and R. Stanley Williams. Coupled Ionic and Electronic Transport Model of Thin-Film Semiconductor Memristive Behavior, *Small*, **5** (9), 1058 (2009), <https://doi.org/10.1002/sml.200801323>
- [57] J.P. Strachan, D. B Strukov, J. Borghetti, J. J. Yang, G. Medeiros-Ribeiro, and R S. Williams. The switching location of a bipolar memristor: chemical, thermal and structural mapping, *Nanotechnology* **22**, 254015 (2011), <https://doi.org/10.1088/0957-4484/22/25/254015>
- [58] A. N. Morozovska, E. A. Eliseev, O. V. Varenkyk, Y. Kim, E. Strelcov, A. Tselev, N. V. Morozovsky, and S. V. Kalinin. Space charge dynamics in solid electrolytes with steric effect and

-
- Vegard stresses: resistive switching and ferroelectric-like hysteresis of electromechanical response. *Journal of Applied Physics* **116**, 066808 (2014); <https://doi.org/10.1063/1.4891346>
- [⁵⁹] R. Waser, M. Aono, Nanoionics-based resistive switching memories, *Nature materials* **6**, 833 (2007), <https://doi.org/10.1038/nmat2023>
- [⁶⁰] K Szot, M. Rogala, W. Speier, Z. Klusek, A. Besmehn, R. Waser, *Nanotechnology* **22**, 254001 (2011), <https://doi.org/10.1088/0957-4484/22/25/254001>
- [⁶¹] L. Vegard. Die konstitution der mischkristalle und die raumfüllung der atome. *Zeitschrift für Physik* **5**, 17-26 (1921), <https://doi.org/10.1007/BF01349680>
- [⁶²] S. Lee, H. Miyazaki, S. D. Mahanti, and S. A. Solin. Composition-driven c-axis expansion of intercalated layered solids: 1D non-Vegard's-law behavior in a 2D solid solution. *Physical review letters* **62**, 3066 (1989), <https://doi.org/10.1103/PhysRevLett.62.3066>
- [⁶³] O. Lipan, F. Hartmann, S. Höfling, and V. Lopez-Richard. Unveiling Ferroelectric-Like Behavior in Leaky Dielectrics: A Microscopic Model for Polarization Dynamics and Hysteresis Inversion. arXiv preprint arXiv:2410.16084 (2024), <https://doi.org/10.48550/arXiv.2410.16084>
- [⁶⁴] The Mathematica (<https://www.wolfram.com/mathematica>) notebook, which contain the codes, is available per reasonable request.