

Enhancing Feature Selection and Interpretability in AI Regression Tasks Through Feature Attribution

A Case Study of Predicting Blade Vibrations in Turbo Machinery

Alexander Hinterleitner^{a,*}, Thomas Bartz-Beielstein^a, Richard Schulz^a, Sebastian Spengler^b, Thomas Winter^b, Christoph Leitenmeier^b

^aTH Koeln, Institute for Data Science, Engineering & Analytics, Steinmueller Allee 1, Gummersbach, 51643

^bMAN Energy Solutions, Stadtbachstraße 1, Augsburg, 86224

Abstract

Research in Explainable Artificial Intelligence (XAI) is increasing, aiming to make deep learning models more transparent. Most XAI methods focus on justifying the decisions made by Artificial Intelligence (AI) systems in security-relevant applications. However, relatively little attention has been given to using these methods to improve the performance and robustness of deep learning algorithms. Additionally, much of the existing XAI work primarily addresses classification problems. In this study, we investigate the potential of feature attribution methods to filter out uninformative features in input data for regression problems, thereby improving the accuracy and stability of predictions. We introduce a feature selection pipeline that combines Integrated Gradients with k-means clustering to select an optimal set of variables from the initial data space. To validate the effectiveness of this approach, we apply it to a real-world industrial problem - blade vibration analysis in the development process of turbo machinery.

Keywords: XAI, Explainable artificial intelligence, Feature attribution, Feature selection, Deep neural network, Regression

1. Introduction

Neural networks have proven to be universal function approximators, especially for high dimensional and complex data sets [1][2]. However, despite their powerful capabilities, they often require substantial computational resources, and their predictions lack interpretability due to their black-box nature. While neural networks can learn complex representations, feature selection may enhance efficiency and performance [3][4]. In the context of neural networks, classical approaches such as wrapper methods are often computationally prohibitive due to the necessity of multiple training and evaluation cycles. Filter methods select features by looking at their statistical properties (e.g., correlation, mutual information) with respect to the target variable. These methods do not involve the model itself and tend to capture only linear or simple relationships between features and the target. Since neural networks are known for their ability to model complex, non-linear patterns in data, filter methods are often not sufficient in such cases, as they may not be able to detect important feature interactions that only become apparent when modeling more complex structures.

*Corresponding author

Email addresses: alexander.hinterleitner@th-koeln.de (Alexander Hinterleitner), thomas.bartz-beielstein@th-koeln.de (Thomas Bartz-Beielstein), richard.schulz@th-koeln.de (Richard Schulz), sebastian.spengler@man-es.com (Sebastian Spengler), thomas.winter@man-es.com (Thomas Winter), christoph.leitenmeier@man-es.com (Christoph Leitenmeier)

In recent years, various explainable artificial intelligence (XAI) approaches, particularly feature attribution methods, have been developed to make the decision-making processes of neural networks more transparent and to understand which features influence their predictions [5][6][7][8][9][10]. While the majority of these methods have focused on classification problems, there are a few notable efforts addressing feature attribution in regression problems [11][12]. Additionally, most work in this field has focused on explaining the decisions of models for legal or ethical purposes rather than using it for Machine Learning Engineering. Biecek and Samek (2024) [13] differentiate between these two scopes of explanations by categorizing them into BLUE (responsiBle models, Legal issues, trUst in predictions, Ethical issues) and RED (Research on data, Explore models, Debug models) XAI.

Our research focuses on investigating the potential of a popular group of XAI methods, known as feature attribution methods, for feature selection to filter out uninformative data and enhance neural network performance in a real-world regression problem related to blade vibration analysis in turbomachinery. We argue that models can identify patterns in the data that may be unknown to domain experts. Therefore, using explanations of a specific network can be beneficial in determining the optimal parameter set through a reverse engineering process. We employ Integrated Gradients (IG), a gradient-based and model-agnostic approach that has been previously utilized in regression contexts [11][12]. We propose a data-driven process that combines the aggregation of local attribution values for a global perspective with the k-Means clustering algorithm to ensure the selection of only the most relevant features for the neural network’s decision-making process. While most work in this field employs out-of-the-box neural network architectures that are analyzed using feature attribution methods, we use surrogate-based hyperparameter optimization to find the best hyperparameter setting for our model. This is crucial because we argue that the information provided by the gradient-based attribution method is only as valuable as the prediction quality of our model. Silva et al. investigated this relationship between model performance and feature attribution [14]. To validate IG, we first conduct experiments using generated, transparent dummy data before applying it to real-world problems. We also compare our method with established base line feature selection approaches and KernelShap, an approximation of one of the most famous attribution methods known as Shapley values.

2. Related Work

2.1. Classical Feature Selection Methods

Feature selection is an important part of the preprocessing stage in machine learning applications. Especially for high-dimensional problems, the reduction of input features can speed up the training of the algorithm and make the problem more interpretable. The prediction quality of the model can also be improved by eliminating disturbance variables. Classic feature selection methods can be categorized as filters, wrappers, and embedded methods [15][16][17].

Filter methods for feature selection are computationally efficient techniques that evaluate the relevance of features independently of any specific learning algorithm. These methods typically employ statistical measures to score and rank features based on their correlation with the target variable. Common filter approaches include the Pearson correlation coefficient [18], mutual information [19], Chi-squared test [20], and information gain [21]. The key advantage of filter methods is their speed and scalability, making them suitable for high-dimensional datasets. However, they usually do not consider feature interactions or complex non-linear correlations. These methods are often used as preprocessing steps or baselines for more sophisticated methods [22][23].

The second category of feature selection algorithms is wrapper methods. These methods are model-dependent and use the model’s performance as a criterion to evaluate feature subsets, effectively “wrapping” the selection process around the model itself [24]. One common approach within this category is forward selection, where the process begins with an empty feature set and iteratively adds features that maximize model performance. At each iteration, the model is trained on the current feature subset along with each remaining feature individually, and the feature that yields the highest performance improvement is permanently added to the subset. This continues until no significant improvement is observed or a predetermined number of features is

reached. Wrapper approaches tend to be more accurate than filter methods but are generally higher in their computational costs [25], especially for high-dimensional problems and Deep Learning applications.

The third category of methods is defined as embedded methods, which integrate feature selection directly into the model training process [26][27]. Unlike filter methods that do not incorporate learning, and wrapper methods that evaluate feature subsets using a learning machine without considering the specific structure of the classification or regression model, embedded methods combine the learning and feature selection processes. Examples of embedded methods include tree algorithms [28][29] or linear models and related algorithms like Lasso or Ridge regression [30][31].

2.2. Feature Attribution

Feature attribution methods have become essential tools for interpreting complex machine learning models. These methods aim to quantify the importance of input features on a model’s predictions, thereby increasing model transparency and aiding feature selection. In this section, we review state-of-the-art feature attribution methods, highlighting both model-agnostic and model-specific approaches.

Introduced by Lundberg and Lee (2017) [6], SHAP (SHapley Additive exPlanations) consolidates several prior attribution methods into a unified framework based on Shapley values from cooperative game theory. This approach provides a consistent and theoretically sound method for feature attribution, maintaining properties such as local accuracy and consistency. Its versatility allows it to effectively analyze feature importance across various machine learning models. However, it is important to note that SHAP’s computational demands can sometimes be prohibitive, especially with large datasets and complex models, as it requires evaluating numerous feature combinations to compute the Shapley values. Another model-agnostic approach is proposed by Ribeiro et al. (2016) [7]. LIME (Local Interpretable Model-agnostic Explanations) explains individual predictions by approximating the model locally with an interpretable model, often linear regression. While LIME’s flexibility and user-friendly nature contribute to its popularity, it may exhibit less stability and consistency compared to SHAP, primarily due to its reliance on local approximations. A third notable model-agnostic method is permutation-based variable importance [32]. It assesses how the model’s prediction error changes when the values of a feature are permuted. This technique offers a global measure of feature importance applicable to any model. However, Feature Permutation can be computationally intensive for high-dimensional data and may not fully capture complex feature interactions.

Other attribution methods have been developed specifically for certain models, utilizing components inherent to their architectures, such as gradients in neural networks. DeepLIFT, proposed by Shrikumar et al. (2017) [8], calculates importance scores by comparing neuron activations to reference activations. Effective for non-linear models, DeepLIFT captures complex feature interactions, particularly beneficial for high-dimensional problems. It serves as a faster alternative to SHAP values while maintaining interpretability. Introduced by Bach et al. (2015) [10], Layer-Wise Relevance Propagation (LRP) decomposes the output of a neural network recursively, layer by layer, assigning relevance to each input feature. While originally developed for image classification, it has been adapted for other tasks. LRP provides detailed attributions at the input feature level, but can be computationally intensive for deep networks. IG, developed by Sundararajan et al. (2017) [9], attributes predictions of deep networks by accumulating gradients along a straight-line path from a baseline to the input. This method satisfies essential axioms such as completeness and sensitivity, making it well-suited for neural network models. IG leverages gradient information inherent in neural networks, ensuring efficient computation and scalability to high-dimensional data.

While the majority of XAI investigations in real-world scenarios have focused on classification problems, there are some publications exploring the application of these techniques to regression tasks. Recent studies have demonstrated the potential of XAI methods in several domains where regression models are prevalent. Mamalakis et al. (2023) conducted a comprehensive analysis of feature attribution methods in climate science [11]. Their work highlights the importance of carefully selecting baselines when applying XAI techniques to regression problems in geoscientific applications. The authors showed that different baselines can lead to substantially different attributions, both in magnitude and spatial patterns, emphasising the need for

careful consideration of baselines to avoid misidentifying sources of predictability. In a different domain, Letzgs et al. (2022) examined two different use cases for feature attribution in regression problems [12]. The first involved age prediction from facial images, demonstrating how XAI techniques can provide insight into the features contributing to age estimates. The second focused on molecular energy prediction in quantum chemistry, demonstrating the versatility of XAI methods across different scientific disciplines. Notably, these studies focus primarily on local feature mapping, aiming to explain specific predictions rather than the overall behaviour of the models. This approach allows for a granular understanding of how individual features contribute to particular outcomes, which is particularly valuable in critical domains where decision-making processes need to be transparent and justifiable.

Even though feature attribution has not been extensively investigated in the context of feature selection, initial work has begun to address this topic. Zacharias et al. (2022) employ SHAP for XGBoost to enhance the interpretability of model preprocessing steps [33]. Van Zyl et al. (2023) utilize SHAP and Grad-CAM for feature selection in Convolutional Neural Networks applied to time series data [34]. This work offers promising results regarding improvements in model performance and reduction in training time.

Table 1 provides an overview of the advantages and disadvantages of different feature selection methods.

Table 1: Comparison of feature selection methods.

Group	Example	Advantages	Disadvantages
Filters	Chi-Square Test	Simple, fast, univariate. Suitable for categorical data.	Ignores feature interactions. Not suitable for continuous features directly (requires discretization).
Wrappers	Recursive Feature Elimination (RFE)	Considers interactions, generally good performance	Computationally intensive
Embedding Methods	LASSO	Embedded in model training, can handle large datasets	May not perform well if features are highly correlated
Feature attribution	SHAP	Stable, local accuracy, consistency	High computational demand
Feature attribution	DeepLIFT	Fast, local explanations	Only applicable to neural networks
Feature attribution	LRP (Layer-wise Relevance Propagation)	Provides detailed insights into model decisions	Requires a specific type of neural network
Feature attribution	Integrated Gradients	Theoretically sound, works with any differentiable model	Requires multiple model evaluations, high computational cost

2.3. Neural Networks for Turbo Machinery

Turbomachines are inherently complex systems characterized by highly nonlinear physical processes. The vibration behavior of these machines is influenced by numerous unknown variables, making accurate modeling and analysis challenging. Additionally, the presence of measurement noise further complicates the identification of underlying patterns and behaviors. Therefore, the integration of Deep Learning and Machine Learning into turbomachinery design has garnered significant attention in recent years, with various studies exploring their potential to enhance design efficiency and performance.

Michelassi and Ling (2021) [35] discuss recent trends in turbomachinery design methods that leverage both AI and high-fidelity simulations to address the increasing demands for efficiency, availability, and cost of ownership in energy conversion and propulsion systems. One of the key components is the supplementation of physical models with data-driven approaches. The authors emphasize that AI approaches do not replace scientific expertise but rather build upon it, combining data-driven methods with traditional scientific knowledge to overcome limitations in available data within the turbomachinery field.

Fei et al. (2016) [36] investigated the potential of neural networks with Gaussian kernel functions to predict compressor performance maps. This novel approach was compared with other data-driven models. It was shown that the proposed network is beneficial compared to the other approaches, especially for extrapolating compressor performance maps from a small number of data samples.

Weber et al. (2024) [37] provide an in-depth analysis of compressor blade vibrations in turbochargers, emphasizing the importance of damping in mitigating high-cycle fatigue. They explore the integration of AI techniques with traditional measurement methods to advance turbocharger development. The study highlights the use of strain gauges and blade tip timing for precise blade vibration measurement, alongside a simplified method for predicting critical damping ratios during the early design phase. In Focus, an AI-driven methodology employing Deep Learning is used to assess genuine damping ratios from experimental data. These approaches accelerate turbocharger development by providing accurate data early in the design process, validating numerical predictions, and enhancing confidence in these methodologies. The AI-based damping estimator is particularly noteworthy, offering engineers a practical tool for improving the reliability and efficiency of turbocharger systems.

3. Background of the Real World Problem

3.1. High-Cycle Fatigue in Turbo Charging Systems

Modern turbocharging systems are critical for enhancing the efficiency and power of engines. Beside the classic automotive domain this technology is intensively developing in the marine and power industry. There is a growing need to push the technological boundaries of these systems, optimizing layout parameters beyond traditional applications. The market demands turbochargers capable of achieving higher pressure ratios and increased flow capacities while maintaining the highest efficiencies. These features are crucial not only for the competitiveness of the turbocharger itself but also for the engine manufacturers who significantly benefit from this new generation of turbochargers [38].

However, these advancements come with substantial challenges. Components such as compressors and turbines must withstand higher loads, requiring robust designs that account for various fatigue conditions, including low-cycle fatigue, thermo-mechanical fatigue, and especially high-cycle fatigue (HCF) [37][38][39]. As pressure levels rise, the vibrations get stronger, and the faster air flow makes the conditions more complex, causing more stress on the parts. To meet thermodynamic demands for efficiency and pressure, bladed nozzle rings with minimal clearance to rotating parts are used. This design choice focuses on the related excitation orders (EOs) and the blade design itself to ensure an HCF-safe design. Additionally, the wide variety of differing variation parts used in turbochargers to meet specific medium- and low-speed engine requirements adds another layer of complexity. This complexity is particularly pronounced in the area of vibration analysis, where complex interactions must be thoroughly understood. Engineers often focus on determining resonant frequencies with their vibration behavior and assessing the effects of various physical parameters [38][40].

Traditionally, this process relies heavily on extensive numerical simulations and physical testing, the latter of which can be particularly costly and time-consuming. Due to the high cost of testing these configurations, data-driven approaches are being explored to complement and partially replace traditional methods in determining HCF-safe designs. This involves predicting amplitudes, as discussed in this paper.

3.2. Description of Experiment Data

The data was provided by MAN Energy Solutions. Due to confidentiality and the high level of competition in this domain, we are not authorized to publish the data. The data set is based on a test setup for

turbomachinery. The systems are subjected to different excitation frequencies to identify critical oscillation behaviors. Stresses (or amplitudes) at the blades are measured using strain gauges and analyzed with appropriate software to calculate the stresses at the most critical points. The calculated stress at these critical points is referred to as the ‘upgraded amplitude’. This interim step is necessary to minimize the number of strain gauges used. The positioning of the strain gauges is a compromise to capture and upgrade many different eigenmodes of the system. Otherwise, it would be necessary to attach a separate strain gauge for each eigenmode, as the peaks never occur at the same location. The aim of our experiments is to predict the amplitude levels based on various process parameters measured during the test runs. An exemplary illustration of an turbine and compressor wheel of a turbo machine can be seen in 1.

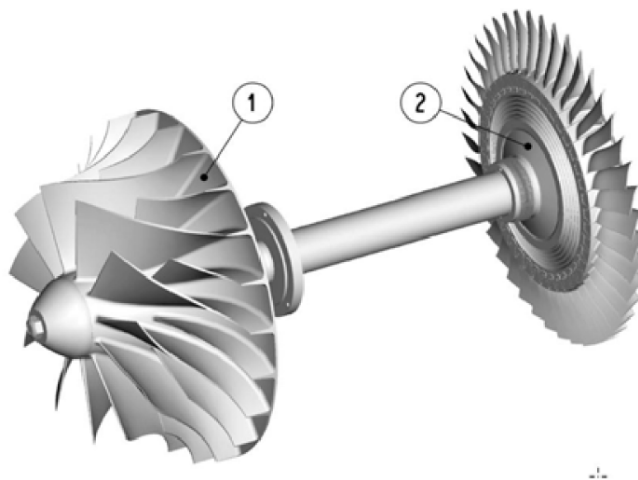

Figure 1: Illustrative visualization of the turbine wheel (1) and compressor wheel (2) in a turbocharging system. Critical vibrations occur at the blades mounted on the wheels. (MAN Energy Solutions, 2023)

We divide the features that we use to predict the upgraded amplitude into different subgroups. Most of the parameters are thermodynamic variables, such as pressures and temperatures at various points in the system. This group accounts for 67 features out of 86. Five features can be summarized under the term ‘Quality Criteria’, which contain various quality measures for the numerical valorization of the amplitudes. We summarize the information on modes, node diameters, and order under the heading ‘Oscillations Characteristics’. In addition to the thermodynamic process parameters, purely mechanical parameters are also measured. These include compressor and motor speeds at the resonance points, vibration frequencies of the turbine blades, and circumferential speeds of the compressor wheel. The time stamp of the measurements represents a separate category. The area ratio between the inlet of the compressor wheel and the inlet of the bladed outlet diffuser, as well as the throttle positions of the system, refer to the geometric setup. We have defined the designations of the measurement series and strain gauges as part of the experimental setup.

4. Methods

4.1. Data Preprocessing

In our experiments, we utilize 86 features. The target variable we aim to predict is the upgraded oscillation amplitude at the rotor blades of the system. Most of the data consists of numerical values, except for two features that contain categorical data: the labels of the strain gauges and the measurement series. First, we remove data points that contain NA entries or are labeled with insufficient measurement quality. We also exclude data with implausible values, such as negative values for modes or frequencies that are too low and were not part of the measurement process. After this filtering process, we retain 27,857 data samples.

After data cleaning, we encode the two categorical columns using scikit-learn’s implementation of an ordinal encoder, transforming them into numerical values. The data is then scaled using our custom implementation of a standard scaler. To avoid data leakage, we fit the scaler by calculating the mean and standard deviation of our training data, which comprises 70% of the entire dataset. We then transform both the training and test data using the fitted scaler. This approach ensures that the test data remains unseen during the training process, maintaining the integrity of our evaluation.

4.2. Neural Network Architecture and Hyperparameter Tuning with *spotpython*

4.2.1. Introduction to *spotpython*

Surrogate model-based optimization methods are widely used in the fields of simulation and optimization. The Sequential Parameter Optimization Toolbox (SPOT) was developed to address the need for robust statistical analysis of simulation and optimization algorithms. It is freely available on GitHub as a Python package, *spotpython*¹. SPOT offers advanced methodologies for optimization (tuning), based on classical regression techniques and analysis of variance. It includes state-of-the-art tree-based models such as classification and regression trees, and random forests, as well as Bayesian optimization models like Gaussian processes, also known as Kriging. Additionally, SPOT allows for the integration and combination of different meta-modeling approaches.

SPOT comes equipped with a sophisticated surrogate model-based optimization method capable of handling both discrete and continuous inputs. Furthermore, any model implemented in *scikit-learn* can be seamlessly used as a surrogate within *spotpython*, providing extensive flexibility to users.

SPOT also implements crucial techniques such as exploratory fitness landscape analysis and sensitivity analysis. These features enable users to comprehensively understand the performance and underlying behavior of various algorithms, thus enriching algorithmic insights and enhancing optimization outcomes. Hyperparameter tuning can be performed using SPOT, which is particularly useful for optimizing neural network architectures.

The *spot* loop consists of the following steps:

1. Init: Build initial design X
2. Evaluate initial design on real objective f : $y = f(X)$
3. Build surrogate: $S = S(X, y)$
4. Optimize on surrogate: $X_0 = \text{optimize}(S)$
5. Evaluate on real objective: $y_0 = f(X_0)$
6. Impute (Infill) new points: $X = X \cup X_0, y = y \cup y_0$.
7. Goto 3.

4.2.2. The Neural-Network Architecture

A neural network class for regression tasks implemented in *spotpython* is used for the neural network for both dummy data and real-world experiments. The network is a multi-layer perceptron (MLP) that is constructed using the Python frameworks PyTorch and PyTorch-Lightning [41][42]. This network consists of four hidden layers. The input layer has the same dimension as the feature space. The optimal number of neurons in the first hidden layer is determined through hyperparameter tuning. The second and third hidden layers have half of the neurons of the first hidden layer, while the third hidden layer has only a quarter of the neurons of the first hidden layer. After each of these layers, there is a dropout layer. The output layer of the network is a linear layer with one neuron, as we want to predict one target variable. During hyperparameter optimization, the activation functions of the hidden layers, the batch size, the dropout probabilities of the dropout layers, the number of training epochs, and the number of neurons in the first hidden layer are optimized. In addition, the best optimizer and the number of epochs that the training is continued without improvement in performance are determined. Instead of tuning the learning rate itself, a multiplication factor

¹<https://github.com/sequential-parameter-optimization/>

for the learning rate is tuned in `spotpython`. This is useful because the learning rates for different optimizers differ. For example, the learning rate for the Adagrad optimizer results from the $learningrate \times 0.01$, while for the Adam optimizer it results from the formula $learningrate \times 0.001$. Further details can be found in the `spotpython` source code. For all tuning runs related to this article, surrogate-based optimization is used. The surrogate model is a Gaussian process model built on 10 initial evaluations. During the tuning process, 30 additional evaluations are performed. The boundaries of the numerical hyperparameters are shown in Table 2, and those for the categorical hyperparameters are shown in Table 3.

Table 2: Numerical hyperparameters and their boundaries. The 2^x transformation indicates that the integers describing the parameters are used as exponents of 2.

Parameter	Lower Bound	Upper Bound	Type	Transformation	Description
l1	5	9	Integer	2^x	Number of neurons in the first hidden layer
epochs	5	10	Integer	2^x	Number of training epochs
batch_size	3	6	Integer	2^x	Batch size
dropout_prob	0.005	0.25	Float	-	Dropout probability for the dropout layer
lr_mult	0.25	5.0	Float	-	Multiplier for the learning rate of the optimizer
patience	3	5	Integer	2^x	Number of epochs the training continues without improvement

Table 3: Categorical hyperparameters and their levels.

Parameter	Levels	Description
optimizer	Adadelta, Adamax, Adagrad	The optimizer that is during for backpropagation
act_fn	ReLU, LeakyReLU	The activation function for the layers of the neural network

4.3. Integrated Gradients

Introduced by Sundararajan et al. (2017), IG is a feature attribution method that aims to attribute the prediction of a deep learning model to its input features by integrating gradients along the path from a baseline input to the actual input [9]. The key idea is to compute the integral of the gradients of the model’s output with respect to the input features, taken along a straight path from a baseline (typically an input with no information, such as a black image or a zero vector) to the actual input. The algorithm fulfills the two axioms of sensitivity and implementation invariance. Sensitivity means that if an input feature changes the model’s prediction, the attribution for that feature should be non-zero. Implementation invariance means that if two models produce the same prediction for the same input, the attribution values should also be the same. IG can be described by the following formula:

$$IG_i(x) = (x_i - x'_i) \times \int_{\alpha=0}^1 \frac{\partial F(x' + \alpha \times (x - x'))}{\partial x_i} d\alpha$$

where:

- x is the input for which the attributions are computed.

- x' is a baseline input.
- α is a scalar that scales the interpolation between the baseline input x' and the input x .
- $\frac{\partial F(x)}{\partial x_i}$ is the gradient of the model output $F(x)$ with respect to the i -th input feature.

Since calculating the integral directly can be computationally intensive, it is often approximated using methods like the Riemann sum or Gauss-Legendre quadrature rule. For our specific problem of selecting the most relevant features to improve neural network regression performance, we argue that IG is the most suitable approach. This choice is supported by several key advantages that IG offers in the context of complex neural network models. Firstly, IG stands on a solid theoretical foundation. It satisfies important axioms such as completeness and sensitivity, ensuring that the attributions it provides are both reliable and consistent [9] [43]. This theoretical soundness is crucial when dealing with the intricate decision-making processes of neural networks. Secondly, IG demonstrates excellent scalability, a critical factor in our high-dimensional regression tasks. Its computational efficiency allows it to handle large-scale datasets without compromising performance, making it particularly well-suited for complex regression problems that often involve numerous input features. As a model-specific method, IG provides insights that are directly tied to the neural network’s internal workings. This characteristic allows for more accurate and relevant attributions compared to model-agnostic approaches, which may not capture the nuances of the neural network’s decision-making process. Furthermore, IG’s gradient-based approach aligns well with the architecture of neural networks. By leveraging the gradient information that is readily available in these models, IG can efficiently perform attributions by quantifying how infinitesimal changes in input features affect the prediction, making it a natural fit for our neural network-based regression tasks [43]. Lastly, IG excels in handling non-linearity, a common characteristic of complex neural network models. Unlike simpler attribution methods, IG can effectively capture and represent non-linear relationships between inputs and outputs, providing a more comprehensive understanding of feature importance in our regression tasks.

4.4. KernelSHAP

Kernel SHAP is an estimation method for Shapley values using a weighted linear regression. The Shapley value for a feature (i) can be approximated as [6]:

$$\phi_i = \sum_{z' \subseteq x'} \frac{|\mathcal{Z}| - 1}{\binom{|\mathcal{Z}|}{|z'|} |z'| (|\mathcal{Z}| - |z'|)} \cdot [f(z' \cup x_i) - f(z')]$$

where:

- ϕ_i is the Shapley value for feature i .
- z' represents a subset of the feature set x' .
- $|\mathcal{Z}|$ is the total number of features.
- $|z'|$ is the number of features in subset z' .
- $f(z' \cup x_i)$ is the model output when feature i is added to subset z' .
- $f(z')$ is the model output for subset z' .

We use this approach to compare the feature selection abilities with our approach that relies on IG. We chose this method because Shapley values are one of the most well-known XAI methods. For our real-world experiments, where we have an initial data set of 86 features, computing the classical Shapley values would be computationally unfeasible, due to their exponential time complexity [44]. Therefore, we decided to use KernelShap as an approximator.

5. Experimental Setup

To underline the reliability of our methods, we start by applying IG to a dummy dataset that we generated. This allows us to determine the ground truth regarding the importance of the variables and to test whether

our approach can effectively filter out unimportant features. Afterwards, we continue by using IG in our feature selection pipeline for our real-world experiment.

5.1. Dummy

To generate the dummy data, we have written a function based on a linear model. The coefficients are generated using a uniform distribution. To resemble the real-world experiment, 86 coefficients are generated. It is assumed that 29 of the coefficients are positively correlated with the target variable (coefficients between 0.1 and 1), and another 29 are negatively correlated (coefficients between -0.1 and -1). The remaining 28 coefficients have no significance for predicting the target variable and therefore have a value of 0. The coefficients are multiplied by randomly generated X values, which add up to the target variable. Analogous to our real-world experiments, 27,857 data points are generated in this manner. No feature interactions are considered, as this information is not available for the real-world data either. The source code for generating the data, as well as the data itself, can be found on GitHub². In the dummy experiments, the aim is to filter out these insignificant values using IG. Therefore we start by optimizing the neural network based on the tuning setup as described in Section 4.2, followed by the IG analysis.

5.2. Real World Experiment

5.2.1. Baseline with linear Model

For some engineering problems, classical regression models are better suited than more advanced algorithms. Classical models also have the advantage that the results are often much easier to interpret. For complex problems involving non-linearities and noisy data, more complex black box models such as neural networks are the better choice [45][1]. To ensure that our problem is non-trivial and necessitates advanced methods, such as a neural network, we first attempt to predict the oscillation amplitudes using simple linear regression, employing the `sklearn` implementation [46]. We utilize all 86 features, as described in Chapter X, and split the data into 70% training and 30% test sets. Additionally, we perform five fold cross-validation to ensure robust and reliable results.

5.2.2. Feature Selection Pipeline

Our novel feature selection process can be described as a data-driven reverse engineering approach. First, the neural network is tuned, taking into account all available features. This ensures that we have a suitable architecture for the corresponding data. This step is particularly important because feature attribution methods, such as IG, examine the extent to which features contribute to the prediction of the target variables. Therefore, the trustworthiness of these methods depends on the performance of the network. After optimizing the hyperparameters, the model is tested using a k-fold cross-validation with five folds. Model performance for all experiments in this article is measured using Mean Squared Error (MSE). This metric is particularly suitable for our use case, where predicting oscillation amplitudes accurately, including extreme values or outliers, is crucial. MSE is the preferred choice because it penalizes outliers more heavily during training, thus encouraging the model to improve its predictions for these extreme values. The attribution values are calculated using an IG implementation that uses a Gaussian Legendre quadrature with 50 approximation steps from the Python package Captum [47]. The algorithm computes local attribution values for each sample in the dataset. To make a global statement about the importance of the features, the mean of all local attribution values is determined. The baseline can be viewed as a state where all features are absent, which in our case means that the system is in a state where it does not vibrate at all. Since we aim to determine the features generally relevant for predicting upgraded vibration amplitudes, we set the baseline for IG to a null vector. Changing the baseline to a state of expected vibration would be more appropriate if we wanted to explain individual predictions that deviate from the expected behavior. After aggregating the attribution values, they are grouped using a K-Means clustering algorithm [48]. The number of clusters (k) is varied to categorize the features into different importance classes. Following each clustering procedure, the cluster containing the least important features is removed from the dataset. This process results in n

²https://github.com/ahinterl94-th/data_generator

distinct sub-datasets, where n is the number of K-Means evaluations with different k values. This approach represents a data-driven method for filtering features based on their importance in predicting the target variable. Consequently, there are no fixed limits on the number of features to include or exclude. Following the feature selection process, the models are re-tuned using each of the distinct feature subsets. This crucial step ensures a fair comparison among models based on different feature combinations. After the tuning, each model is evaluated using the k-fold cross-validation with five folds. By doing so, we can effectively validate the efficacy of our feature selection methodology. The whole process of the feature selection process using IG and K-Means is visualized in Figure 2.

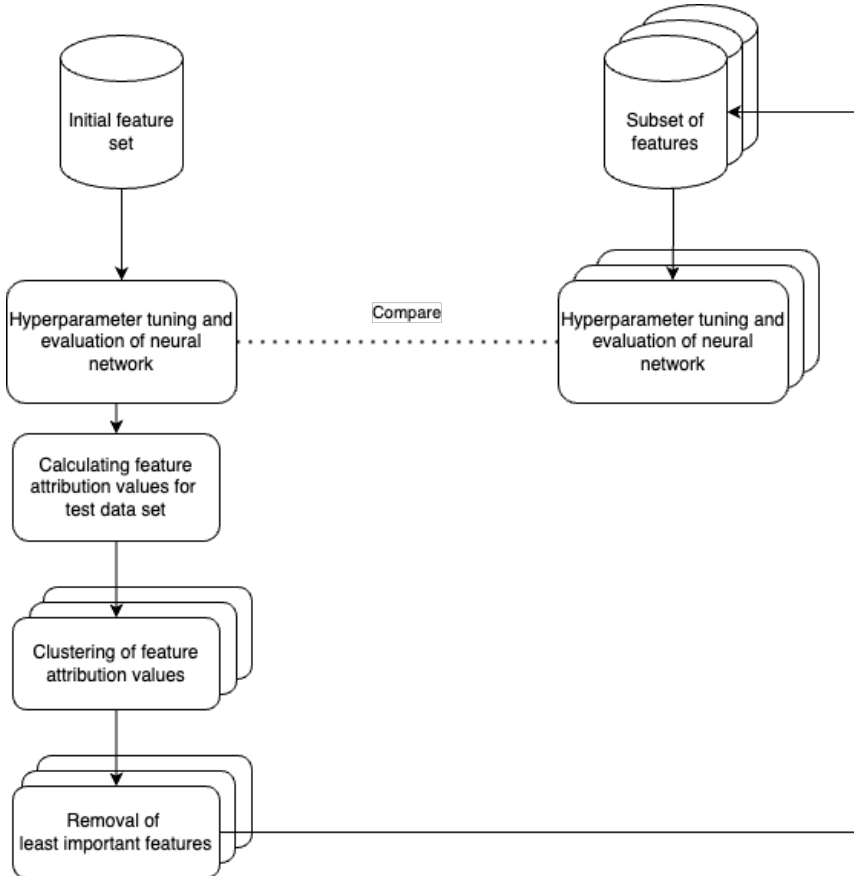

Figure 2: Process for feature selection based on feature attribution and clustering. The process starts with tuning a neural network using all available features. The tuned network is then analyzed using integrated gradients to calculate attribution values. Next, these attribution values are clustered with varying k values. By removing the least important cluster from each clustering, different new feature sets are created. A neural network is subsequently tuned for each of these feature sets. The results are compared with each other and with the network based on the initial feature set.

5.2.3. Feature Selection Validation Experiments

As this work serves as a proof of concept for utilizing feature attribution for explainable feature selection, we aim to validate our approach by conducting four additional comparative experiments.

In the first experiment, we perform a Cross-Check by taking the best performing feature subset identified previously and then tune and evaluate a network using the remaining features from the initial feature set, which were identified as having the lowest information density. It is hypothesized that the performance of this model should be significantly worse compared to the model utilizing the important features. This procedure is designed to verify that the feature importance methods have a meaningful impact and do not

exhibit random behavior.

The second and third experiments employ two classical feature selection methods. In one approach, we use the Pearson correlation to select the top n features with the highest correlation to the target variable, where n corresponds to the number of features in the best-performing subset from the experiment described in Section 5.2.2. The other classical method is an embedded approach: Lasso regression. This linear model is a regularization technique that performs both feature selection and coefficient shrinkage by adding an L1 penalty term to the linear regression cost function. In this study, we opted for Lasso regression over Ridge regression for feature selection due to its ability to shrink coefficients to exactly zero, thereby effectively eliminating less important features, which aligns with our goal of identifying the most influential predictors in our high-dimensional dataset [30][49].

The final experiment involves using KernelShap to identify the n most important features. This serves as a comparison of the feature selection capabilities of IG with another attribution method, allowing us to evaluate the robustness and effectiveness of our feature selection approach.

6. Results and Discussion

The “Results and Discussion” chapter is divided into two sections: the results related to the dummy data and the results of the real-world experiments. The first section validates the ability of IG to detect the most important features based on the known ground truth of the dummy data. The second section discusses the outcomes of the real-world experiments.

6.1. Results and Discussion of the Dummy Data Experiments

Figure 3 demonstrates the neural network’s ability to capture the behavior of the dummy data. This is visualized by comparing the actual and predicted values, as well as by showing the residuals of the predicted values. Due to the simple linear characteristics of the dummy data, the network predicts the target values with high accuracy, as indicated by the very small residuals compared to the target values. The average MSE after cross-validation is 0.00073. Ensuring suitable performance is crucial because the quality of the attribution methods highly depends on the network’s prediction accuracy.

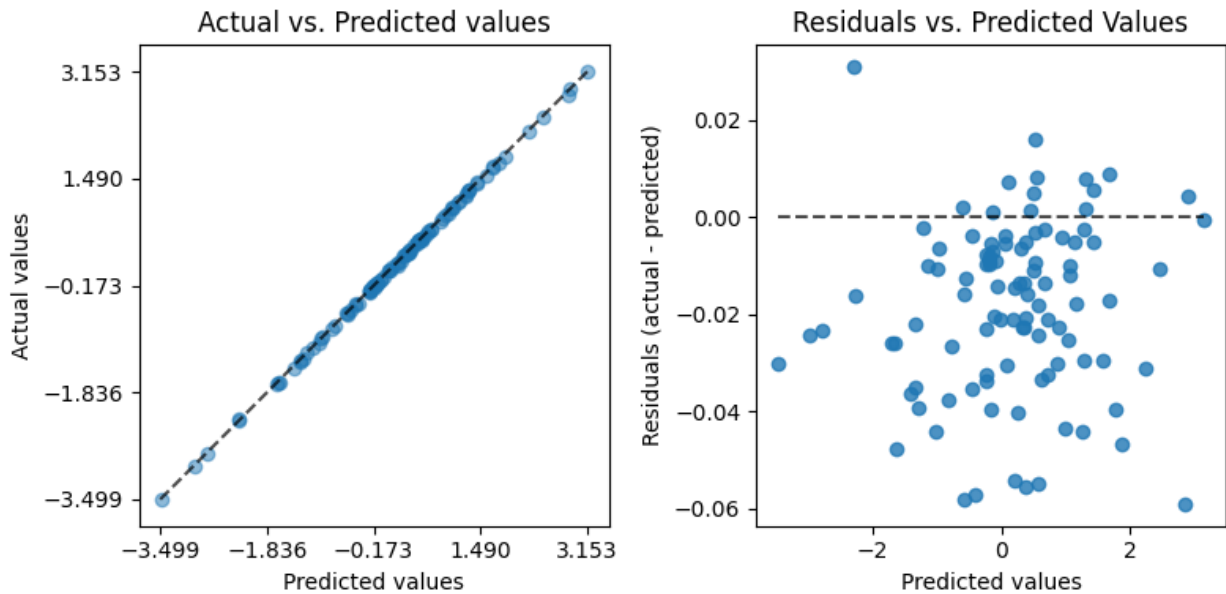

Figure 3: Performance of the tuned neural network on the dummy data. The left side shows the comparison between actual and predicted values. The right graph shows the residuals between of the predicted values. The graphs indicate that the network accurately captures the behavior of the dummy data.

After evaluating the neural network, the IG analysis is performed. Figure 4 shows the comparison between the scaled attribution values (blue bars) and the coefficients of the linear model (orange bars) used to generate the dummy data. The attribution values are scaled between the minimum and maximum values of the coefficients using a min-max scaler from `sklearn` [46]. This ensures the comparability of the two sets of values. It can be seen that the two bar plots follow a similar pattern for each feature. IG successfully detected all relevant coefficients by assigning significantly higher values to these features compared to those with a coefficient of zero. Even the order of importance is correct. Features based on coefficients of zero receiving negligible attribution values. These findings indicate that IG is a suitable approach for assessing the importance of features in high-dimensional datasets for regression tasks. However, it should be noted that the dummy data does not include feature interactions or non-linear behavior.

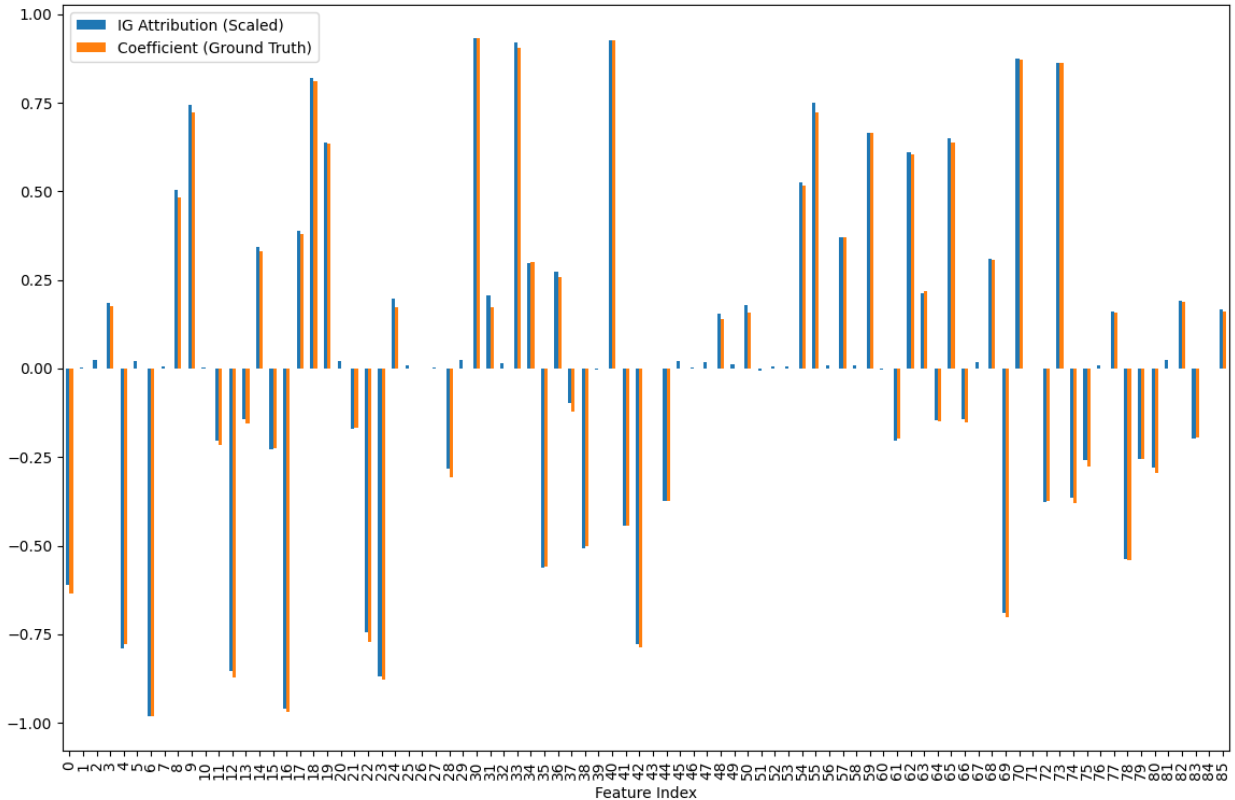

Figure 4: Comparison between scaled IG feature attribution values and the coefficients of the linear model used to generate the dummy data. The attribution values are scaled between the minimum and maximum values of the coefficients to ensure the same ranges for the comparison. It can be seen that coefficients and the attribution values follow a similar pattern.

6.2. Results and Discussion Real World Experiment

The linear model, which serves as a baseline for our real-world experiments, achieves an average MSE of 32,993 across five folds during cross-validation. This performance is significantly worse than that of our initial neural network, which achieves an average MSE of 8.718. This result demonstrates that employing neural networks to capture the complex non-linear patterns inherent in the underlying real-world problem is a more effective approach.

When applying our feature selection pipeline, the attribution values, which are based on the IG analysis of the initially tuned network with all features, were clustered several times. The value of k was changed for each clustering. In total, clustering was performed nine times with k values ranging from two to ten. For each clustering run, the cluster with the lowest attribution values, and therefore the lowest relevance for the prediction, was removed from the initial feature set. An exemplary plot of the clustering process for $k = 6$ can be seen in Figure 5. The points below and on the red dotted line correspond to the lowest attribution values. The features that are related to these points are removed during the feature selection process. The visualization of all clustering runs for all different k -values can be seen in the appendix. This visualization shows that these clusters are identical for k values four and five, as well as six to ten. This reduces the number of tunings and evaluations performed with different feature sets from ten to five (including the initial evaluation with all features).

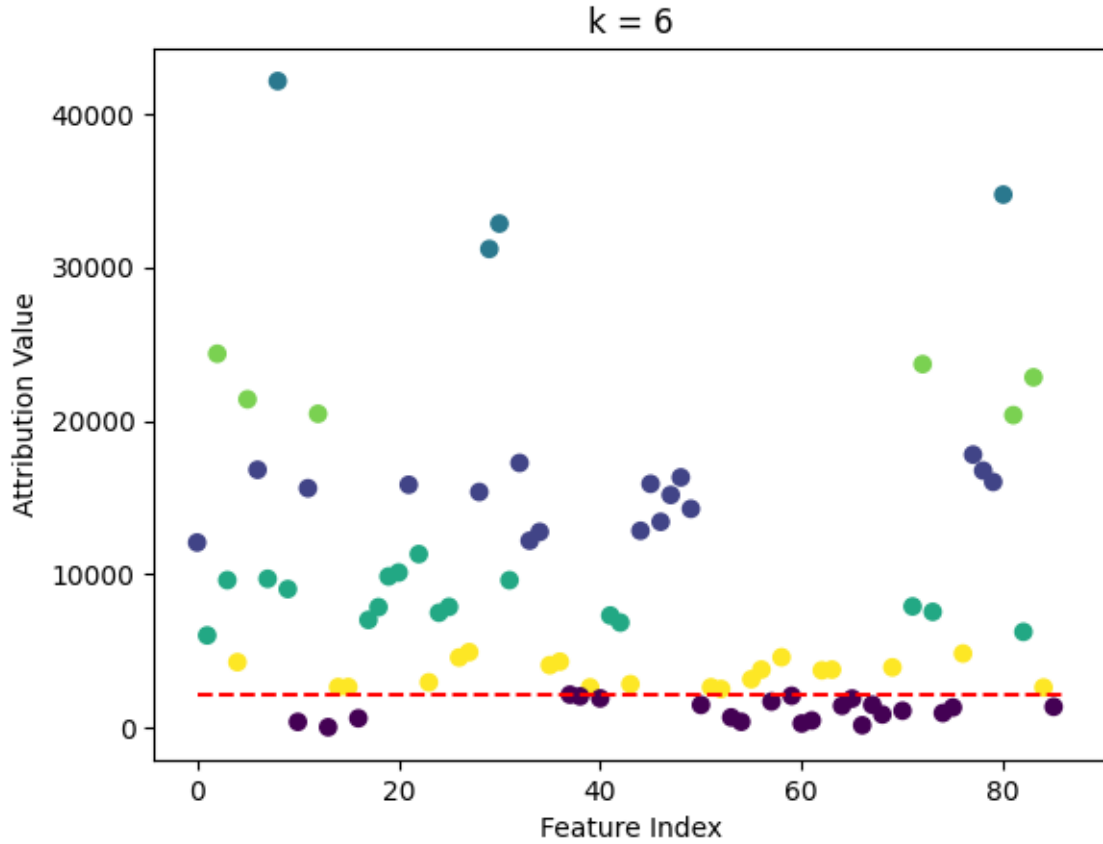

Figure 5: K-Means clustering for the Integrated Gradient based feature attribution values. The attribution values were calculated for a tuned neural network across all 86 input features. This visualization exemplifies the clustering process for K-Means with $k = 6$. The points on and below the red dotted line correspond to the cluster with the lowest attribution values, which are removed during the feature selection process.

Table 4 shows the results of the evaluations of the experiments in relation to the different k values and the associated number of features. It can be seen that the initial tuning achieves an average MSE of 8.718 across all cross-validations. However, the standard deviation of the MSE values for the individual cross-validations is higher here than in the evaluations of the experiments with reduced feature sets. This suggests a lack of robustness in the predictions. For the evaluations in which the number of features is reduced to less than half of the initial feature set, the average MSE increases. This indicates that with this drastic reduction of the feature set, relevant information for predicting the vibration amplitudes was also removed from the input data. The results of the predictions with 44 features show, on average, a minimally lower MSE than the results of the prediction with all 86 input variables. However, the standard deviation is significantly lower for the 44 features. This indicates that disturbance variables were filtered out, allowing the model to make more stable predictions. The best performance in the experiments is achieved with 64 features. A significantly better MSE is achieved here than with the full data set. Additionally, the standard deviation is minimized in this evaluation. This shows that IG could detect the features with the highest information density and that the clustering process effectively eliminated less relevant information and disturbances.

Table 4: The results of the cross-validation depend on the different subsets of features that are selected using IG and K-Means. The table presents the performance values as MSE, along with the selected number of clusters and the resulting number of features. Additionally, it shows the standard deviation of the MSE across all cross validations. In some clustering experiments, the same number of resulting features is obtained, as the cluster containing the least important features remains unaffected by variations in the k values.

n Features	k Cluster	Fold 1 MSE	Fold 2 MSE	Fold 3 MSE	Fold 4 MSE	Fold 5 MSE	Mean MSE	SD MSE
86	-	7,705	8,250	11,428	9,402	6,807	8,718	1.594
27	2	11,94	9,601	8,716	10,156	10,387	10,160	1.060
33	3	8,30	10,282	11,379	9,729	8,155	9,570	1.218
44	4, 5	9,336	8,474	7,670	8,667	8,209	8,471	0.547
64	6-10	6,605	5,477	5,524	5,627	5,576	5,762	0.425

This observation is further supported by Figure 6. It displays the individual MSE values (grey dots), along with the mean (black dots) and standard deviations (black lines) of the MSE values, based on the number of n most important features used. It is evident that both the mean MSE and the variability of the MSE values are minimized when using the 64 most important features.

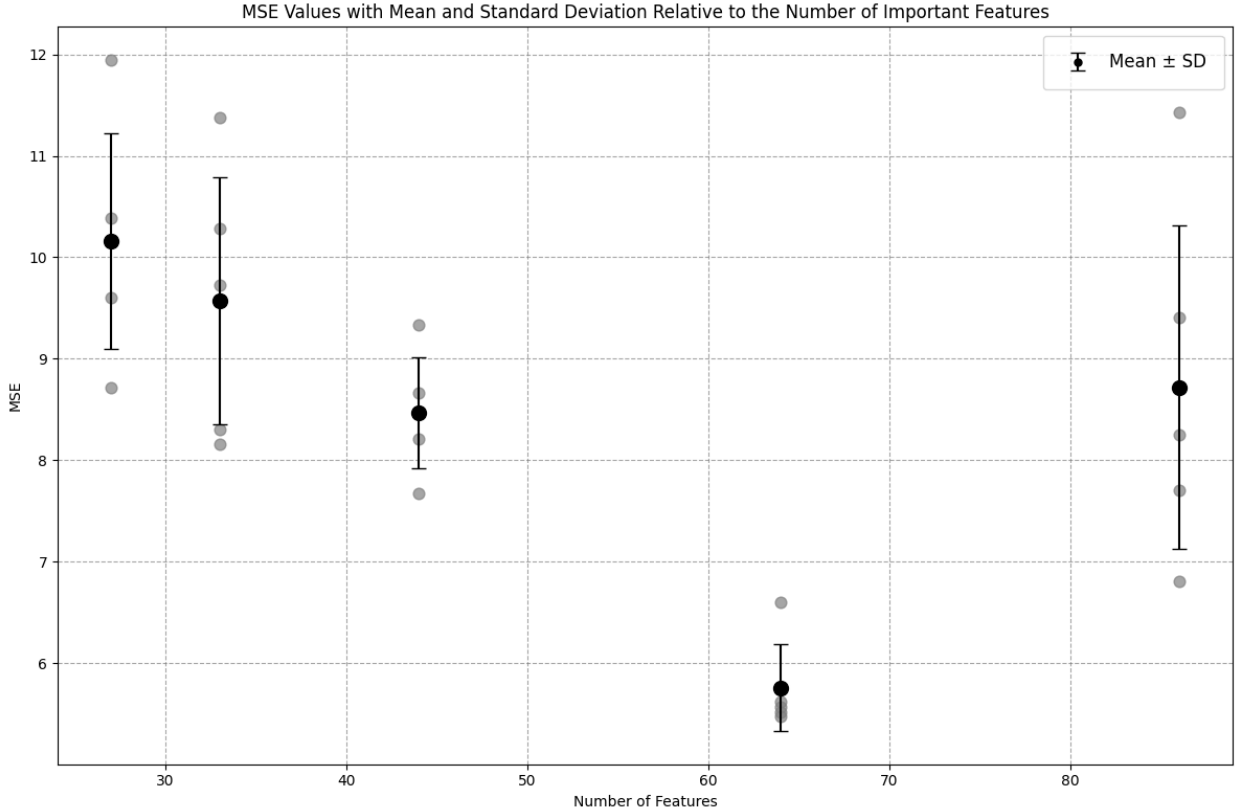

Figure 6: Visualization of MSE values for predicting upgraded amplitudes based on the number of important features determined by IG and used in the neural network. The light grey points represent the actual MSE values across all cross-validations for each feature set. The black dots indicate the mean MSE, while the black lines represent the standard deviation of the MSE values for each feature set.

6.2.1. Results and Discussion of the Feature Selection Validation Experiments

The results of the cross-validation experiments suggest that our approach outperforms the other methods used for comparison in the feature selection process. The experiment using the least important features identified by our approach yields a MSE nearly three times higher than that of the 64 most significant features determined by IG (see Table 5). This outcome serves as a plausibility check for our method, confirming its effectiveness. Utilizing Pearson correlation for selecting the top 64 informative features results in poor performance. This can be explained by the fact that all Pearson correlation values are below 0.15. It is important to note that Pearson correlation only accounts for linear relationships, which appears inadequate for accurately capturing the complexities of a real-world dataset. Lasso Regression, as a standard feature selection technique, performs better than Pearson correlation but does not achieve as low an MSE as the IG approach. However, the standard deviation of the results is relatively low, indicating that the algorithm successfully captures global importances. By introducing the regularization term, Lasso Regression builds a more stable model compared to other approaches. The KernelShap method serves as a direct competitor to IG, as both are feature attribution techniques. The results indicate that the neural network utilizing the 64 most important features identified by KernelShap performs better than those relying on classical feature selection approaches. However, the average MSE is higher than that of the IG experiment, and the standard deviation is more than twice as high. The results underline our assumption that the feature selection loop based on IG is a suitable approach for identifying the most important features. IG considers the gradient information of the network, which is essential for the algorithm’s decision-making process. This can be particularly beneficial when working with high-dimensional and complex data in the domain of neural networks, compared to other feature selection methods.

Table 5: Results of the comparison between the best performing feature set, determined by IG and K-Means, and the other cross-check experiments. It is shown that feature selection techniques based on feature attribution seem to be beneficial in comparison to the classical feature selection approaches.

Experiment	n Features	Fold 1 MSE	Fold 2 MSE	Fold 3 MSE	Fold 4 MSE	Fold 5 MSE	Mean MSE	SD MSE
IG + k-means (most relevant features)	64	6,605	5,477	5,524	5,627	5,576	5,762	0.425
IG + k-means (most uninformative features)	22	16.795	15.872	18.692	15.498	15.537	16.477	1.201
Pearson (most correlating features)	64	13,921	15,743	11,82	13,731	9,916	13.026	1.990
Lasso Regression	64	7.338	8.775	8.907	8.345	8.849	8.443	0.587
KernelShap (most relevant features)	64	7.113	8.657	7.238	9.268	6.287	7.824	1.089

6.3. Feature Importance Discussion

While our primary goal is to use feature attribution for feature selection, these methods also provide valuable insights into the decision-making process of the network, potentially revealing previously unknown aspects of the underlying physical process. Figure 7 illustrates the feature importance across various feature categories as outlined in Section 3.2. It is evident from the figure that IG identifies the oscillation mode (index 8) from the “Oscillation Characteristics” group as the most significant variable for predicting the updated oscillation amplitude. From an engineering perspective, this is entirely logical, as the mode (the natural frequency) is a key characteristic of the oscillation. Within the same group, another crucial feature is the excitation order (index 5). From the category of thermodynamic variables, several features stand out as influential in the neural network’s prediction process. These include two temperatures measured on the drive train (indices 80 and 83), the mass flow of air in front of the compressor (index 30), the volume flow of air in front of the compressor (index 29), and the pressure of the lubricating oil (index 72). The high importance of the temperature values measured on the drivetrain is particularly interesting. This could be

explained by a delayed correlation with the rotation speed. However, it is unexpected that the measured temperatures appear to be more important for the neural network’s decision-making than the measured rotation speed (index 18) itself. Additionally, the feature that describes the name and position of the strain gauges (index 2) from the “Experimental Setup” category provides valuable information for an accurate prediction of the amplitude. Moreover, one feature from the “Quality Criteria” group (index 12) has also proven to be particularly important for the predictions of the neural network.

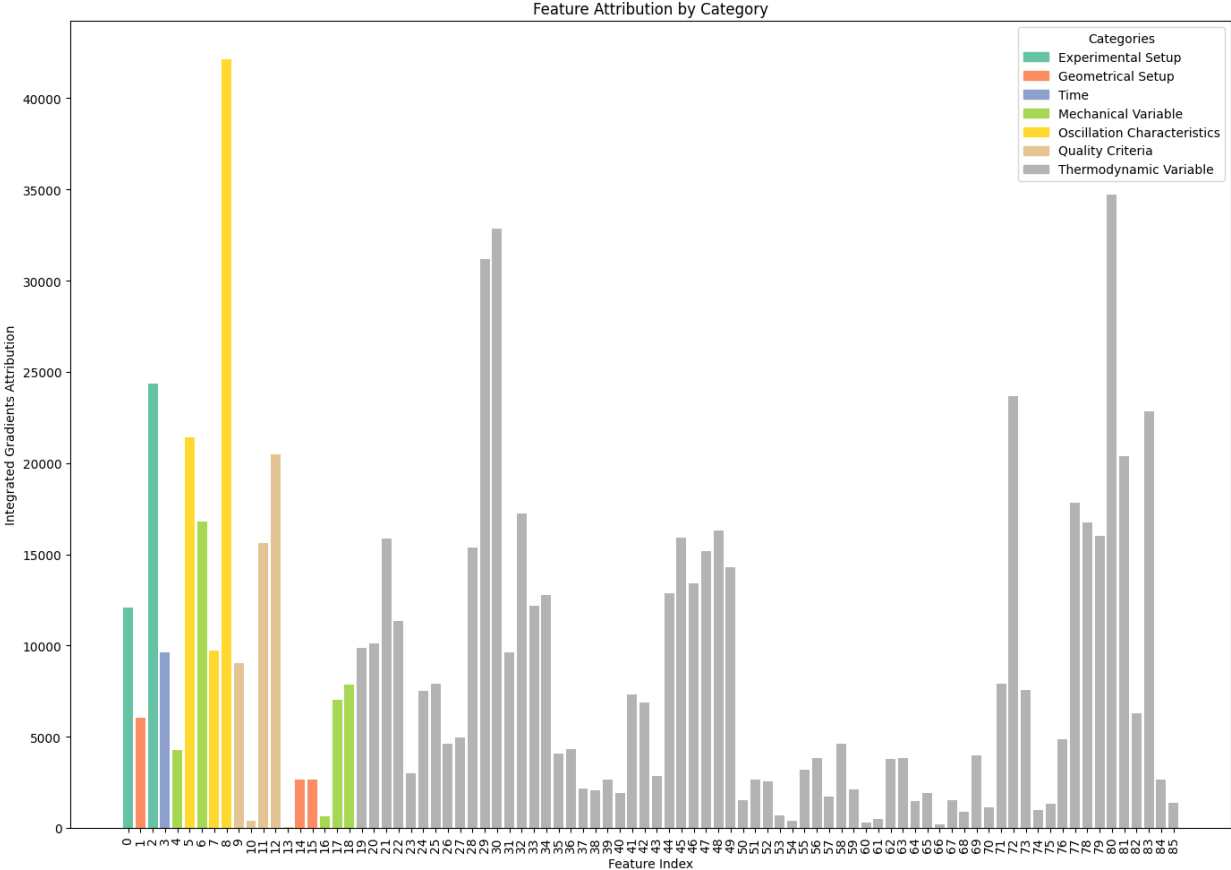

Figure 7: Absolute feature attribution values based on Integrated Gradients for the subcategories of the data. The attribution values are accumulated over the entire dataset, with different colors representing different feature categories.

7. Conclusion

Even though neural networks possess structural feature engineering capabilities, this work demonstrates that feature attribution serves as an effective tool for explainable feature selection. This approach enhances model performance and stability by identifying informative features and filtering out noise and disturbances in the data. By combining feature attribution with clustering techniques, we present a data-driven method for categorizing features based on their importance, thereby eliminating the need for arbitrary thresholds in feature selection.

Our approach serves as an embedded feature selection method for neural networks, utilizing the model’s gradient information to evaluate feature importance directly from its decision-making processes. This strategy enhances predictive accuracy and robustness by eliminating noise in the input, which in turn reduces the standard deviation of the error. Additionally, it offers valuable insights into the model’s reasoning, promoting the development of more transparent and interpretable AI systems.

While the primary advantage of our method is the transparency it brings to feature selection, making AI systems more explainable, our initial comparative experiments demonstrate that this approach also outperforms classical feature selection methods. However, it is important to note that these comparisons were made against standard methods and were based on the best results of our approach. In future studies, we plan to build on the findings of this work by conducting more comprehensive comparative experiments with advanced feature selection methods. Additionally, we aim to enrich our method by incorporating other feature attribution techniques.

Despite the promising results, it should not be ignored that the quality of XAI methods depends on the initial prediction quality of the network. There may be use cases where the prediction with the initial feature set is insufficient, and conventional feature selection methods need to be applied before feature attribution methods. The relatively good results from the initial evaluation with all features in our study can be attributed to the feature engineering capabilities of neural networks.

Another interesting finding of this study is the potential to predict oscillation amplitudes using AI methods. Even though this was not the main goal of our work, this method seems to offer significant added value for the development process of turbomachinery. Future research can therefore focus on fine-tuning the prediction performance by investigating other machine learning models, more complex network structures and further hyperparameter tuning.

Appendix

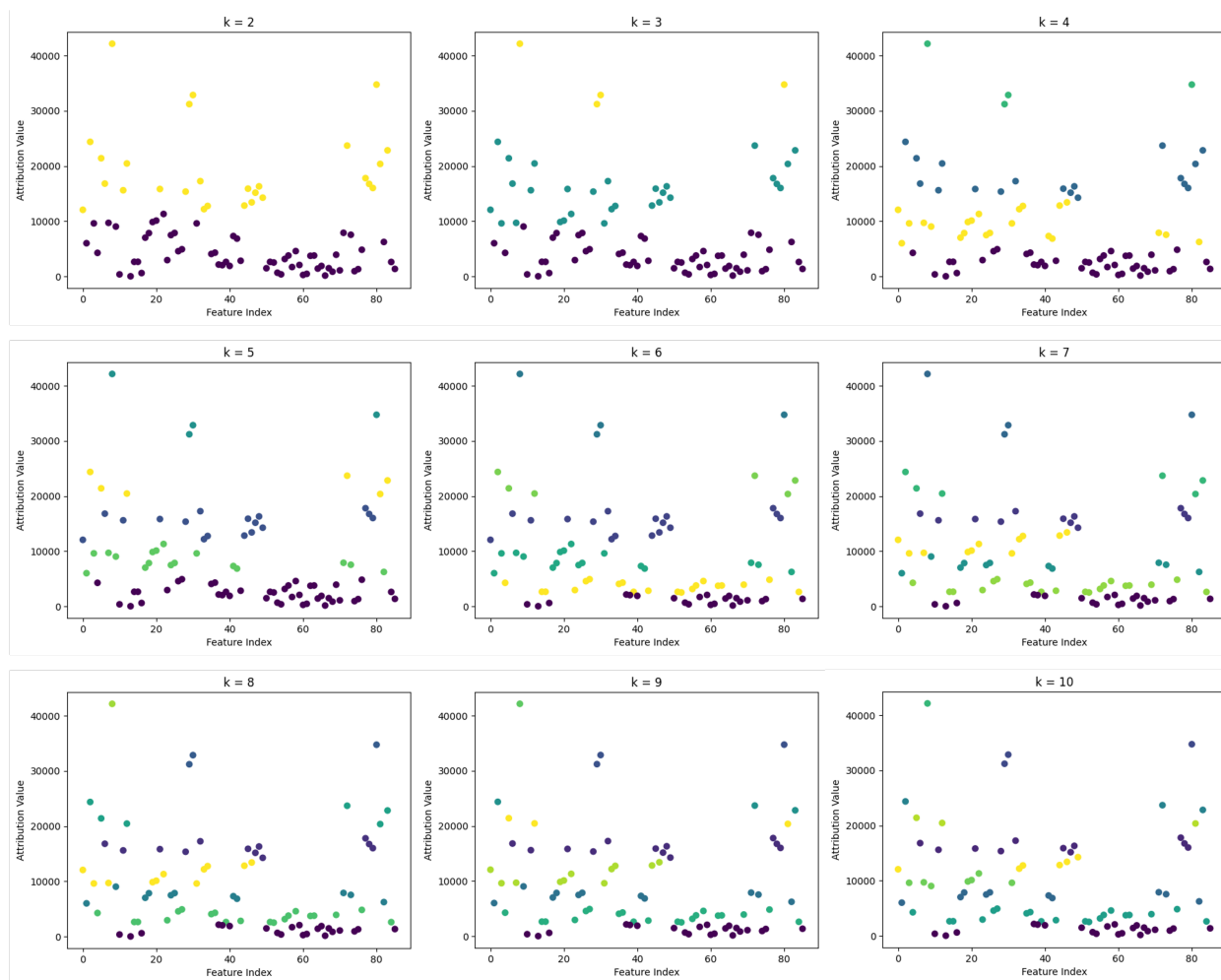

K-Means clustering for the Integrated Gradient based feature attribution values. The attribution values are calculated for the tuned neural network on all 86 input features. The K-Means analyses are performed with different k-values ($k=3 - k=10$). All dots of one colour represent a cluster. In all subgraphs, the violet cluster is related to the least important features, which are removed for the subsequent evaluation.

References

- [1] Y. LeCun, Y. Bengio, G. Hinton, Deep learning, *nature* 521 (7553) (2015) 436–444.
- [2] S. Yang, T. Ting, K. L. Man, S.-U. Guan, Investigation of neural networks for function approximation, *Procedia Computer Science* 17 (2013) 586–594. doi:10.1016/j.procs.2013.05.076.
- [3] A. Verikas, M. Bacauskiene, Feature selection with neural networks, *Pattern recognition letters* 23 (11) (2002) 1323–1335.
- [4] A. Navot, R. Gilad-Bachrach, Y. Navot, N. Tishby, Is feature selection still necessary?, in: *International Statistical and Optimization Perspectives Workshop "Subspace, Latent Structure and Feature Selection"*, Springer, 2005, pp. 127–138.
- [5] R. R. Selvaraju, M. Cogswell, A. Das, R. Vedantam, D. Parikh, D. Batra, Grad-cam: Visual explanations from deep networks via gradient-based localization, in: *Proceedings of the IEEE international conference on computer vision*, 2017, pp. 618–626.
- [6] S. M. Lundberg, S.-I. Lee, A unified approach to interpreting model predictions, *Advances in neural information processing systems* 30 (2017).
- [7] M. T. Ribeiro, S. Singh, C. Guestrin, "why should i trust you?" explaining the predictions of any classifier, in: *Proceedings of the 22nd ACM SIGKDD international conference on knowledge discovery and data mining*, 2016, pp. 1135–1144.
- [8] A. Shrikumar, P. Greenside, A. Kundaje, Learning important features through propagating activation differences, in: *International conference on machine learning*, PMLR, 2017, pp. 3145–3153.

- [9] M. Sundararajan, A. Taly, Q. Yan, Axiomatic attribution for deep networks, in: International conference on machine learning, PMLR, 2017, pp. 3319–3328.
- [10] S. Bach, A. Binder, G. Montavon, F. Klauschen, K.-R. Müller, W. Samek, On pixel-wise explanations for non-linear classifier decisions by layer-wise relevance propagation, *PloS one* 10 (7) (2015) e0130140. doi:10.1371/journal.pone.0130140.
- [11] A. Mamalakis, E. A. Barnes, I. Ebert-Uphoff, Carefully choose the baseline: Lessons learned from applying xai attribution methods for regression tasks in geoscience, *Artificial Intelligence for the Earth Systems* 2 (1) (2023) e220058. doi:10.1175/aies-d-22-0058.1.
- [12] S. Letzgs, P. Wagner, J. Lederer, W. Samek, K.-R. Müller, G. Montavon, Toward explainable artificial intelligence for regression models: A methodological perspective, *IEEE Signal Processing Magazine* 39 (4) (2022) 40–58.
- [13] P. Biecek, W. Samek, Explain to question not to justify, arXiv preprint arXiv:2402.13914 (2024).
- [14] P. Silva, C. T. Silva, L. G. Nonato, Exploring the relationship between feature attribution methods and model performance, arXiv preprint arXiv:2405.13957 (2024).
- [15] A. Jović, K. Brkić, N. Bogunović, A review of feature selection methods with applications, in: 2015 38th international convention on information and communication technology, electronics and microelectronics (MIPRO), Ieee, 2015, pp. 1200–1205.
- [16] J. Li, K. Cheng, S. Wang, F. Morstatter, R. P. Trevino, J. Tang, H. Liu, Feature selection: A data perspective, *ACM computing surveys (CSUR)* 50 (6) (2017) 1–45. doi:10.1145/3136625.
- [17] J. Cai, J. Luo, S. Wang, S. Yang, Feature selection in machine learning: A new perspective, *Neurocomputing* 300 (2018) 70–79.
- [18] Y. Liu, Y. Mu, K. Chen, Y. Li, J. Guo, Daily activity feature selection in smart homes based on pearson correlation coefficient, *Neural processing letters* 51 (2020) 1771–1787. doi:10.1007/s11063-019-10185-8.
- [19] J. R. Vergara, P. A. Estévez, A review of feature selection methods based on mutual information, *Neural computing and applications* 24 (2014) 175–186.
- [20] I. S. Thaseen, C. A. Kumar, Intrusion detection model using fusion of chi-square feature selection and multi class svm, *Journal of King Saud University-Computer and Information Sciences* 29 (4) (2017) 462–472.
- [21] B. Azhagusundari, A. S. Thanamani, et al., Feature selection based on information gain, *International Journal of Innovative Technology and Exploring Engineering (IJITEE)* 2 (2) (2013) 18–21.
- [22] N. Sánchez-Marño, A. Alonso-Betanzos, M. Tombilla-Sanromán, Filter methods for feature selection—a comparative study, in: *International Conference on Intelligent Data Engineering and Automated Learning*, Springer, 2007, pp. 178–187.
- [23] M. Cherrington, F. Thabtah, J. Lu, Q. Xu, Feature selection: filter methods performance challenges, in: *2019 International Conference on Computer and Information Sciences (ICCIS)*, IEEE, 2019, pp. 1–4.
- [24] R. Kohavi, G. H. John, Wrappers for feature subset selection, *Artificial intelligence* 97 (1-2) (1997) 273–324. doi:10.1016/s0004-3702(97)00043-x.
- [25] J. C. Ang, A. Mirzal, H. Haron, H. N. A. Hamed, Supervised, unsupervised, and semi-supervised feature selection: a review on gene selection, *IEEE/ACM transactions on computational biology and bioinformatics* 13 (5) (2015) 971–989. doi:10.1109/tcbb.2015.2478454.
- [26] S. Wang, J. Tang, H. Liu, Embedded unsupervised feature selection, in: *Proceedings of the AAAI conference on artificial intelligence*, Vol. 29, 2015, pp. 1–8. doi:10.1609/aaai.v29i1.9211.
- [27] T. N. Lal, O. Chapelle, J. Weston, A. Elisseeff, Embedded methods, in: *Feature extraction: Foundations and applications*, Springer, 2006, pp. 137–165.
- [28] J. R. Quinlan, Induction of decision trees, *Machine learning* 1 (1986) 81–106.
- [29] L. Breiman, Random forests, *Machine learning* 45 (2001) 5–32.
- [30] R. Tibshirani, Regression shrinkage and selection via the lasso, *Journal of the Royal Statistical Society Series B: Statistical Methodology* 58 (1) (1996) 267–288.
- [31] A. E. Hoerl, R. W. Kennard, Ridge regression: Biased estimation for nonorthogonal problems, *Technometrics* 12 (1) (1970) 55–67.
- [32] A. Fisher, C. Rudin, F. Dominici, All models are wrong, but many are useful: Learning a variable’s importance by studying an entire class of prediction models simultaneously, *Journal of Machine Learning Research* 20 (177) (2019) 1–81.
- [33] J. Zacharias, M. von Zahn, J. Chen, O. Hinz, Designing a feature selection method based on explainable artificial intelligence, *Electronic Markets* 32 (4) (2022) 2159–2184. doi:10.1007/s12525-022-00608-1.
- [34] C. Van Zyl, X. Ye, R. Naidoo, Harnessing explainable artificial intelligence for feature selection in time series energy forecasting: A comparative analysis of grad-cam and shap, *Applied Energy* 353 (2024) 122079. doi:10.1016/j.apenergy.2023.122079.
- [35] V. Michelassi, J. Ling, Challenges and opportunities for artificial intelligence and high-fidelity simulations in turbomachinery applications: A perspective, *Journal of the Global Power and Propulsion Society* 2021 (May) (2021) 1–14.
- [36] J. Fei, N. Zhao, Y. Shi, Y. Feng, Z. Wang, Compressor performance prediction using a novel feed-forward neural network based on gaussian kernel function, *Advances in Mechanical Engineering* 8 (1) (2016) 1687814016628396.
- [37] R. Weber, M. Glatt, Compressor blade vibrations of next generation of turbocharger with focus on damping: Simplified prediction and ai-based evaluation, in: *Turbo Expo: Power for Land, Sea, and Air*, Vol. 88025, American Society of Mechanical Engineers, 2024, p. V10AT23A009.
- [38] S. Spengler, C. Leitenmeier, T. Willeke, L. Aurahs, High cycle fatigue – advanced development and design methods for increased robustness (2023).
- [39] T. Nicholas, Critical issues in high cycle fatigue, *International Journal of Fatigue* 21 (1999) S221–S231.
- [40] M. P. Castanier, C. Pierre, Modeling and analysis of mistuned bladed disk vibration: current status and emerging directions, *Journal of Propulsion and power* 22 (2) (2006) 384–396.

- [41] A. Paszke, S. Gross, F. Massa, A. Lerer, J. Bradbury, G. Chanan, T. Killeen, Z. Lin, N. Gimelshein, L. Antiga, A. Desmaison, A. Kopf, E. Yang, Z. DeVito, M. Raison, A. Tejani, S. Chilamkurthy, B. Steiner, L. Fang, J. Bai, S. Chintala, [Pytorch: An imperative style, high-performance deep learning library](#), in: *Advances in Neural Information Processing Systems 32*, Curran Associates, Inc., 2019, pp. 8024–8035.
URL <http://papers.neurips.cc/paper/9015-pytorch-an-imperative-style-high-performance-deep-learning-library.pdf>
- [42] W. Falcon, The PyTorch Lightning team, [PyTorch Lightning](#) (Mar. 2019). doi:10.5281/zenodo.3828935.
URL <https://github.com/Lightning-AI/lightning>
- [43] Y. Wang, T. Zhang, X. Guo, Z. Shen, Gradient based feature attribution in explainable ai: A technical review, arXiv preprint arXiv:2403.10415 (2024).
- [44] E. Strumbelj, I. Kononenko, An efficient explanation of individual classifications using game theory, *The Journal of Machine Learning Research* 11 (2010) 1–18.
- [45] L. Alzubaidi, J. Zhang, A. J. Humaidi, A. Al-Dujaili, Y. Duan, O. Al-Shamma, J. Santamaría, M. A. Fadhel, M. Al-Amidie, L. Farhan, Review of deep learning: concepts, cnn architectures, challenges, applications, future directions, *Journal of big Data* 8 (2021) 1–74.
- [46] F. Pedregosa, G. Varoquaux, A. Gramfort, V. Michel, B. Thirion, O. Grisel, M. Blondel, P. Prettenhofer, R. Weiss, V. Dubourg, J. Vanderplas, A. Passos, D. Cournapeau, M. Brucher, M. Perrot, E. Duchesnay, Scikit-learn: Machine learning in Python, *Journal of Machine Learning Research* 12 (2011) 2825–2830.
- [47] N. Kokhlikyan, V. Miglani, M. Martin, E. Wang, B. Alsallakh, J. Reynolds, A. Melnikov, N. Kliushkina, C. Araya, S. Yan, et al., Captum: A unified and generic model interpretability library for pytorch. arxiv 2020, arXiv preprint arXiv:2009.07896 (2021).
- [48] S. Lloyd, Least squares quantization in pcm, *IEEE transactions on information theory* 28 (2) (1982) 129–137.
- [49] P. Filzmoser, M. Gschwandtner, V. Todorov, Review of sparse methods in regression and classification with application to chemometrics, *Journal of Chemometrics* 26 (3-4) (2012) 42–51.