

HIGHER-CATEGORICAL ASSOCIAHEDRA

SPENCER BACKMAN, NATHANIEL BOTTMAN, AND DARIA POLIAKOVA

ABSTRACT. The second author introduced 2-associahedra as a tool for investigating functoriality properties of Fukaya categories, and he conjectured that they could be realized as face posets of convex polytopes. We introduce a family of posets called categorical n -associahedra, which naturally extend the second author's 2-associahedra and the classical associahedra. Categorical n -associahedra give a combinatorial model for the poset of strata of a compactified real moduli space of a tree arrangement of affine coordinate subspaces. We construct a family of complete polyhedral fans, called velocity fans, whose coordinates encode the relative velocities of pairs of colliding coordinate subspaces, and whose face posets are the categorical n -associahedra. In particular, this gives the first fan realization of 2-associahedra. In the case of the classical associahedron, the velocity fan specializes to the normal fan of Loday's realization of the associahedron.

In order to prove that the velocity fan is a fan, we first construct a cone complex of metric n -bracketings and then exhibit a piecewise-linear isomorphism from this complex to the velocity fan. We demonstrate that the velocity fan, which is not simplicial, admits a canonical smooth flag triangulation on the same set of rays, and we describe a second, finer triangulation which provides a new extension of the braid arrangement. Although n -associahedra are typically too large to be realized as coarsenings of the braid arrangement, we describe piecewise-unimodular maps on the velocity fan such that the image of each cone is a union of cones in the braid arrangement, and we highlight a connection to the theory of building sets and nestohedra. We explore the local iterated fiber product structure of categorical n -associahedra and the extent to which this structure is realized by the velocity fan. For the class of concentrated n -associahedra we exhibit generalized permutahedra having velocity fans as their normal fans recovering Loday's associahedron and Forcey's multiplihedron. In future work we will investigate projectivity for general velocity fans.

CONTENTS

1. Introduction	3
1.1. Compactified real moduli spaces	12
1.2. The wonderful associahedral fan and the braid arrangement	14
1.3. Glossary of essential notation	16
1.4. Acknowledgments	17
2. n -bracketings and categorical n -associahedra	18
2.1. The definition of categorical n -associahedra	18
2.2. Collisions as atoms	25

2.3.	Collisions as tree maps	29
2.4.	Collision definitions and lemmas	31
3.	The metric n -bracketing cone complex	37
3.1.	Cone complexes and piecewise-linear transformations	37
3.2.	Metric n -bracketings	42
3.3.	Metric n -bracketings as conical combinations of collisions	44
3.4.	The metric n -bracketings form an abstract fan	47
4.	The velocity fan	49
4.1.	Definition of the velocity fan	49
4.2.	Metric n -bracketings and the velocity fan	54
4.3.	\mathcal{T} -shuffles and adjoint permutation transformations	55
4.4.	The main lemma for the velocity fan	65
4.5.	The velocity fan is a fan	70
4.6.	The velocity fan is complete	73
5.	Triangulating n -associahedra	74
5.1.	Nested collisions and triangulated n -associahedra	74
5.2.	The collision mixed graph	77
5.3.	Tree combinatorics of $\Delta_{\mathcal{T}}$	78
5.4.	$\bar{\mathcal{K}}^{\text{met}}(\Delta_{\mathcal{T}})$ is a triangulation of $\bar{\mathcal{K}}^{\text{met}}(\mathcal{T})$	80
5.5.	$\bar{\mathcal{F}}(\Delta_{\mathcal{T}})$ is a smooth triangulation of $\bar{\mathcal{F}}(\mathcal{T})$	83
5.6.	The permutahedral n -associahedron	85
5.7.	1-dimensional n -associahedra and walls of the velocity fan	88
6.	Piecewise-unimodular maps to the braid arrangement	93
6.1.	Piecewise-unimodular transformations and permutahedroids	94
6.2.	The shuffle atlas for the velocity fan	99
6.3.	The nestohedral atlas for the triangulated velocity fan	103
7.	The local nested fiber product structure of the velocity fan	108
7.1.	Fiber products of sets, posets, cone complexes, and fans	109
7.2.	Fiber products of n -associahedra	114
7.3.	Fiber products of velocity fans	116
7.4.	Fiber products of metric n -bracketing complexes	119
7.5.	Proof of Theorem 7.28	121
8.	Concentrated n -associahedra as generalized permutahedra	122
8.1.	Collision units for polytopes	125
8.2.	Minkowski sums of simplices	131
8.3.	Recovering the constrainahedra	132
8.4.	Vertex presentation	135
	References	139

1. INTRODUCTION

Given a word of length n , the associahedron \mathcal{K}_n is the set of parenthesizations of this word, partially ordered by inclusion. There is a rich history of realizing \mathcal{K}_n as the face poset of a convex polytope [Sta63a, HT78, Hai84, Lee89, GZK89, Gel91, SS93, Sta97, CFZ02, RSS03, FZ03, Lod04, San04, Rea06, HL07, BHLT09, Buc08, Pos09, HLT11, Ste13, CSZ15, AHBHY18, PPPP23, BDLLS23, GT24].^{1,2}

The associahedron makes fundamental appearances in several different parts of mathematics such as homotopy theory, representation theory, operad theory, category theory, Grassmannians, Coxeter groups, A -discriminants, cluster algebras, polytopal subdivisions, Catalan combinatorics, wonderful compactifications, scattering amplitudes, and tropical geometry. These appearances motivate many interesting generalizations of the associahedron, which often admit polytopal realizations [BS92, Kap93, GKZ94, RZ94, Jon03, SW05, ARW05, AKW06, Pos09, PS12, OT12, Esc16, DFRS15, SSW17, AHT14, Pos18, AHBHY18, CPS19, DS23, PPP21, AHHL⁺21, Gal21, DFLM21, GPW22].

There is an area of mathematics where the associahedron plays a distinguished role which may be less well-known to researchers in algebraic and geometric combinatorics: the Fukaya category of a symplectic manifold. The associahedra form an example of an operad, and in the study of operads there is a notion of a category over an operad, where the operad controls the algebraic structure of the morphisms. Thus, a linear A_∞ -category is defined as a category over the operad of cellular chains on the associahedra. (See [AB22, Prop. 2.20].³) The Fukaya category of a symplectic manifold M is a collection of Lagrangian submanifolds of M equipped with morphisms given by Floer cochains, and this category is an important example of an A_∞ -category.

In 2017 the second author introduced a family of posets called 2-associahedra for investigating functoriality properties of Fukaya categories [Bot19a]. He and Carmeli proved in [BC21] that the 2-associahedra form a relative 2-operad and can be used to define $(A_\infty, 2)$ -categories. As described in [AB22], the functoriality properties of the Fukaya category can be encoded in the construction of an $(A_\infty, 2)$ -category whose objects are symplectic manifolds. In the context of Fukaya categories, the relevant interpretation of the associahedron is the poset of strata of a compactified moduli space of points on a real line, a construction due to Kapranov [Kap93] building on ideas of Drinfeld [Dri89, Dri88] (see Figure 1).⁴ Similarly, the second author

¹See [CSZ15] for a thorough account of the history up to 2015.

²The associahedron is often interpreted in the language of other collections of objects whose maximal elements are enumerated by the Catalan numbers, e.g. the subdivisions of a polygon.

³Note that versions of the associahedra were already used to define A_∞ -algebras in J.P. May's seminal [May72], while H-spaces of [Sta63a], [Sta63b] can be viewed as a topological version of A_∞ -algebras.

⁴We note that there are other connections between associahedra and symplectic geometry which do not pass through the Fukaya category [OT12, DJL21, GT24].

proved that a 2-associahedron is the poset of strata of a compactified moduli space of marked vertical lines in \mathbb{R}^2 [Bot19b] (see Figure 2).

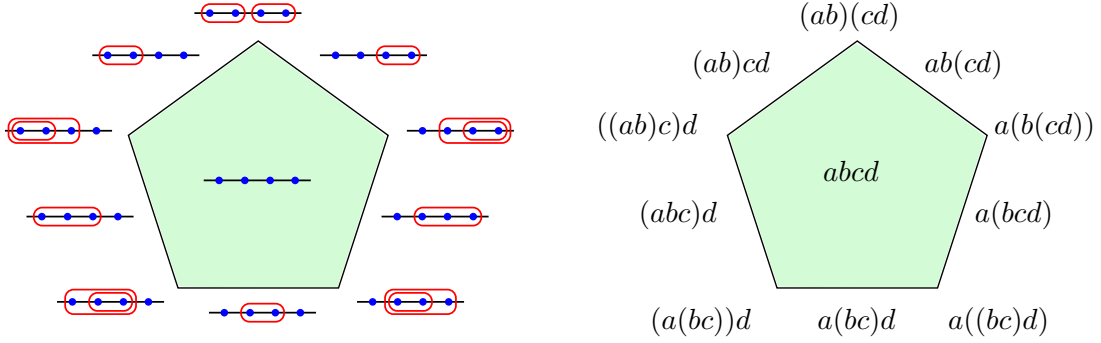

FIGURE 1. K_4 , presented in terms of 1-bracketings (left) and parenthesizations (right).

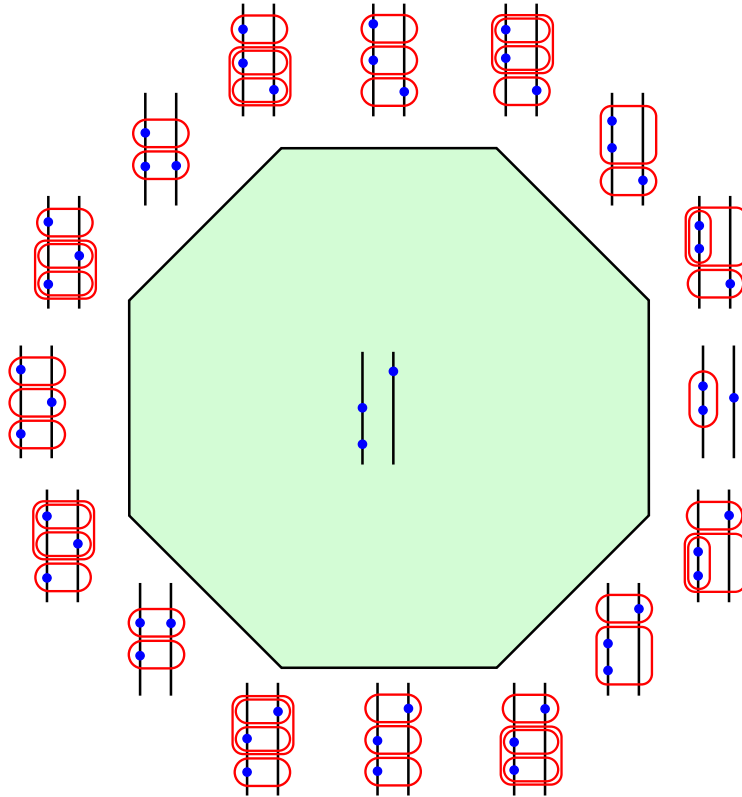

FIGURE 2. The 2-associahedron associated to 2 lines with 2 points on the first line and 1 point on the second line.

From this perspective, 2-associahedra are natural enough that the authors feel they could have been discovered independently of considerations of Fukaya categories, although without this strong motivation it may have been difficult to anticipate that 2-associahedra are so well-behaved.

The second author conjectured that 2-associahedra could be realized as face posets of convex polytopes and made progress towards resolving this conjecture by proving that they are abstract polytopes [Bot19a], that they are Eulerian ([BM19], with Mavrides), and that they are homeomorphic to closed balls ([AB22], with Abouzaid, relying on [BO19], with Oblomkov). We take a significant next step towards resolving this conjecture by producing the first complete fan realization of 2-associahedra, which we call *the velocity fan*. This allows us to recover all of the aforementioned partial results. Furthermore, we introduce a natural extension of 2-associahedra and classical associahedra, which we call *categorical n -associahedra*, and prove that our velocity fan provides a realization for this larger class of posets. In future work, we will investigate projectivity for velocity fans, i.e. the existence of polytopes whose normal fans are the velocity fans.

While the precise definition of a 2-associahedron is not short, the essential idea of this construction can be conveyed very intuitively via compactified real moduli spaces as indicated above. This perspective in turn motivates the introduction of categorical n -associahedra in §2. We begin by recalling the description of the associahedron as the poset of strata of a compactified real moduli space. Take the space of n ordered points on a line, considered up to translation and positive dilation, where points are allowed to move but cannot collide with or move past their neighboring points. We compactify this space by allowing points to collide, and then further allowing iterated collisions of points in infinitesimal neighborhoods of other collisions. This idea is captured combinatorially by the parenthesization of a word encoding the points, hence the compactified space obtained in this way has the associahedron as its poset of strata (see Figure 1).

Suppose that one has an arrangement X of vertical lines in \mathbb{R}^2 with a possibly empty set of points on each line, although at least one line should have a point. For describing the 2-associahedron determined by X , we are similarly interested in this space of points and lines, considered up to translation and dilation, where points are allowed to move vertically but they cannot collide with or move past neighboring points, and vertical lines are allowed to move horizontally but they cannot collide with or move past neighboring vertical lines. The second author proved that 2-associahedra can be realized as the poset of strata of a Gromov compactification of this space of marked vertical lines in \mathbb{R}^2 [Bot19b]. Because a 2-associahedron is determined by the combinatorial type of X , we can index each 2-associahedron $W_{\mathbf{n}}$ by a sequence of nonnegative integers \mathbf{n} encoding the number of points on each line. The elements of a 2-associahedron are called 2-bracketings and should be understood as a 2-version of the parenthesization of a word. In the same way that a parenthesization of a word can be considered as a union of compatible pairs of parentheses, a 2-bracketing in a 2-associahedron can always be considered as a union

of compatible collisions of points and lines. For a bracketing in the associahedron, this expression is unique, whereas a 2-bracketing can often be expressed as the union of collisions in multiple ways. This implies that associahedra are simple, but 2-associahedra are not.

We introduce categorical n -associahedra as an extension of this viewpoint to \mathbb{R}^n . In this work we give a combinatorial definition of categorical n -associahedra as a model for the poset of strata of a compactification of the real moduli space of a tree of affine initial coordinate subspaces. The formal definition of categorical n -associahedra takes as input a single rooted plane tree \mathcal{T} of depth n (see Figure 3). In this way, our categorical n -associahedra specialize to the 2-associahedra where the indexing sequence of nonnegative integers is encoded by a rooted plane tree of depth two, and to the classical associahedra where the indexing positive integer is encoded by a rooted plane tree of depth one.⁵

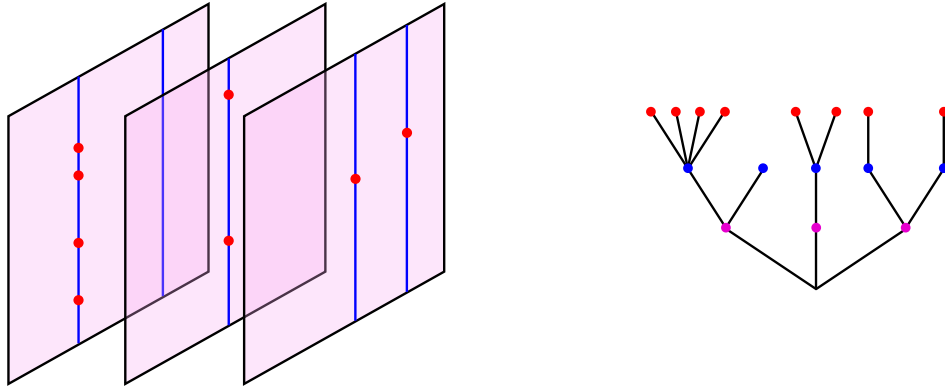

FIGURE 3. On the left: an arrangement of affine spaces for producing a categorical 3-associahedron. On the right: A rooted plane tree \mathcal{T} encoding the combinatorial type of the arrangement on the left.

Given a rooted plane tree \mathcal{T} and its corresponding categorical n -associahedron $\mathcal{K}(\mathcal{T})$, we introduce a collection of polyhedral cones called the velocity fan $\mathcal{F}(\mathcal{T})$. The ray generators for the velocity fan are associated to collisions, i.e. the atoms of $\mathcal{K}(\mathcal{T})$, and have coordinates encoding the relative velocities of consecutive pairs of affine coordinate subspaces in an arrangement during a collision. The cones of the velocity fan are then determined by these rays generators: for a particular element of $\mathcal{B} \in \mathcal{K}(\mathcal{T})$ the associated cone $\tau(\mathcal{B})$ is the convex hull of all ray generators $\rho(\mathcal{C})$ for collisions $\mathcal{C} \leq \mathcal{B}$, plus the linear span of the all ones vector. The following is the main result of this article:

⁵It is well-known that rooted plane trees can be identified with the faces of associahedra. Thus we have a bijection between categorical n -associahedra and faces of associahedra — at the time of writing this is simply a curious observation, but it would be wonderful to have some deeper justification for this correspondence.

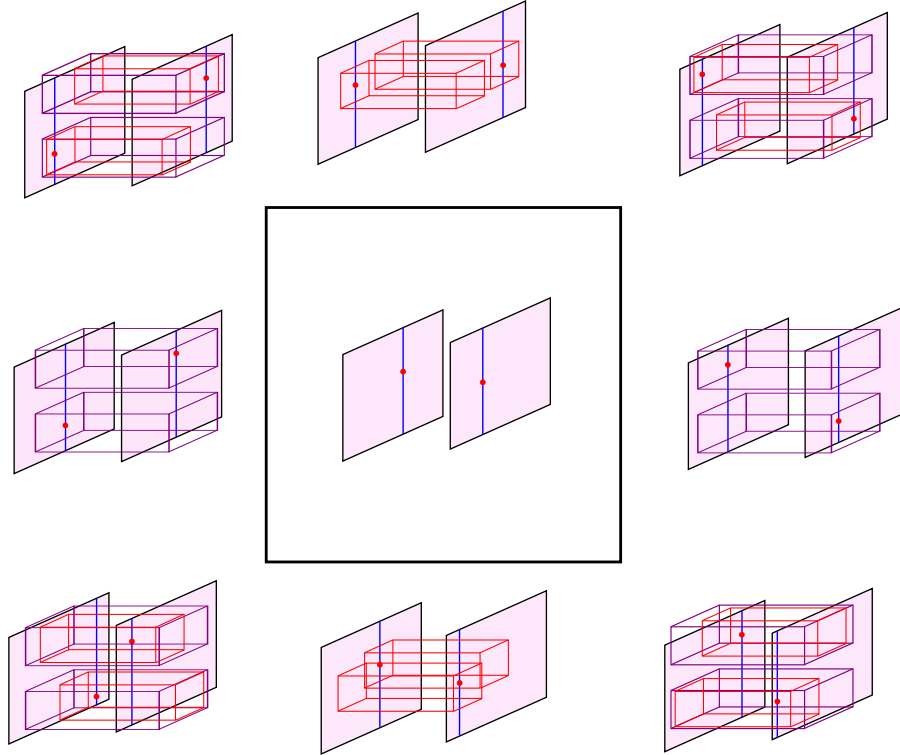

FIGURE 4. A 2-dimensional example of a 3-associahedron.

Theorem 1.1. (4.3) *The velocity fan $\mathcal{F}(\mathcal{T})$ is a complete fan whose face poset is $\mathcal{K}(\mathcal{T})$.*

It requires significant work to prove that $\mathcal{F}(\mathcal{T})$ is indeed a fan. For doing so, we utilize the theory of cone complexes, which abstract and generalize the notion of a fan. Cone complexes play a central role in modern logarithmic geometry where they have been applied in the study of moduli spaces, tropical geometry, and Berkovich spaces. We construct a cone complex $\mathcal{K}^{\text{met}}(\mathcal{T})$ of metric n -bracketings and prove that this cone complex has a face poset equal to that of $\mathcal{K}(\mathcal{T})$. Theorem 1.1 (without completeness) is a direct consequence of the following result.

Proposition 1.2. (4.13) *There exists a piecewise-linear isomorphism*

$$(1) \quad \Gamma : \mathcal{K}^{\text{met}}(\mathcal{T}) \rightarrow \mathcal{F}(\mathcal{T}).$$

See Figure 2 for the 2-associahedron $W_{2,1}$, and Figure 6 for its abstract fan of metric 2-bracketings and its velocity fan. We feel that this concrete combinatorial application of cone complexes is a curious feature of this article and may be of general interest to polyhedral and logarithmic geometers.

During a collision, the affine spaces in a tree arrangement can be permuted — this is an essential feature of n -associahedra. For the 2-associahedra associated to a pair

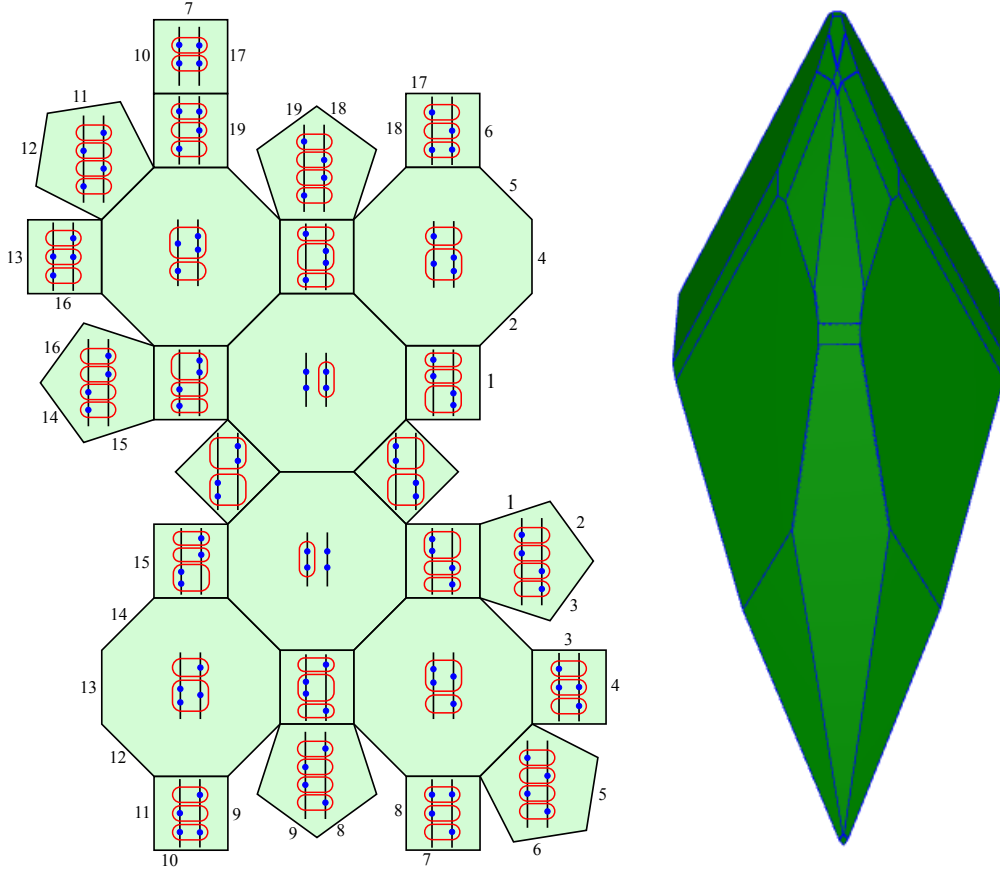

FIGURE 5. On the left: a net depicting the 2-associahedron $W_{2,2}$. On the right: a polytopal realization of the 2-associahedron $W_{2,2}$ with normal fan given by the velocity fan.

of lines, the permutations of points which can occur are precisely the riffle shuffle permutations, thus we refer to these permutations for general n -associahedra as \mathcal{T} -shuffles. Let P_σ be the standard permutation transformation written in the basis of the positive simple roots. The adjoint permutation transformation P_σ^T allows us to describe how the shuffle σ is manifested geometrically in the velocity fan. (See Lemmas 4.31 and 4.32 for precise statements.) We note that the lineality space $\langle \mathbf{1} \rangle_{\mathbb{R}}$ of the velocity fan $\mathcal{F}(\mathcal{T})$ is not contained in the eigenspace of P_σ^T , and for this reason we cannot quotient out $\mathcal{F}(\mathcal{T})$ by its lineality space until argumentation involving P_σ^T has been concluded.

In the case of the classical associahedra, our velocity fan specializes to the normal fan of Loday’s realization of the associahedron \mathcal{F}_n [Lod04]. It is well-known that \mathcal{F}_n is a coarsening of the braid arrangement and thus Loday’s realization is a generalized permutahedron, equivalently a polymatroid base polytope. In fact, Loday’s

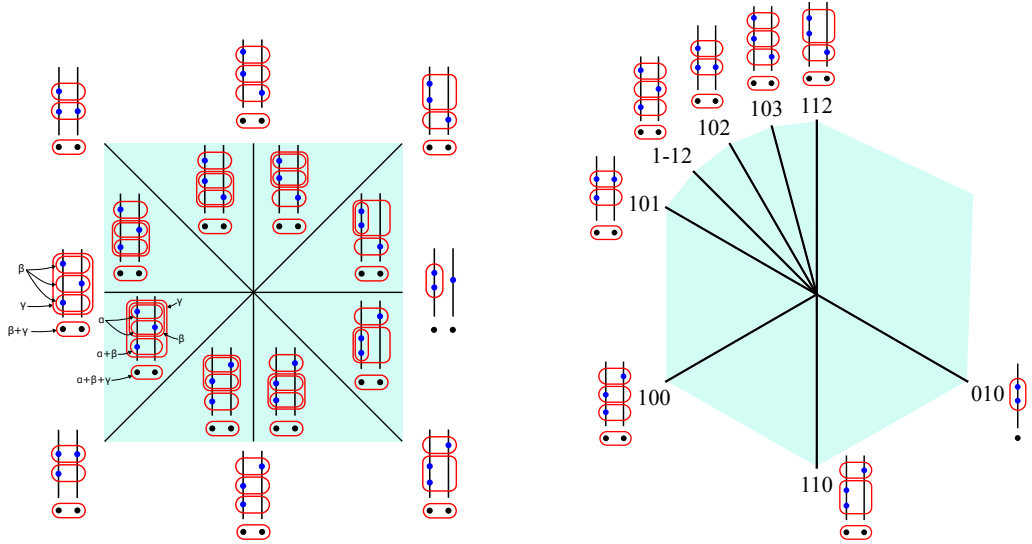

FIGURE 6. On the left is a depiction of the cone complex $\mathcal{K}^{\text{met}}(\mathcal{T})$ of metric 2-bracketings for $W_{2,1}$; this figure should not be taken literally as $\mathcal{K}^{\text{met}}(\mathcal{T})$ is not embedded in Euclidean space. On the right is the velocity fan $\mathcal{F}(\mathcal{T})$ for $W_{2,1}$ viewed along the vector $(1, 1, 1)$. See also Figure 30.

associahedron was one of the primary motivations for Postnikov’s development of the theory of generalized permutahedra where he expressed Loday’s associahedron as a Minkowski sum of standard simplices [Pos09].⁶ It is impossible to realize all categorical n -associahedra as generalized permutahedra for the simple fact that their face posets are too large.⁷ On the other hand, because our velocity fan specializes to the normal fan of Loday’s associahedron, as well as the normal fan of Forcey’s multiplihedron, which is also a generalized permutahedron [For08, AD13], it is reasonable to ask whether there is a direct connection between general velocity fans

⁶We refer the curious reader to the excellent recent survey of Loday’s associahedron by Pilaud–Santos–Ziegler [PSZ23].

⁷ Each 2-dimensional generalized permutahedron has at most 6 sides, but the 2-associahedron $W_{2,1}$ is an octagon. There are a few different extensions of generalized permutahedra, perhaps the most prominent constructions being the generalized bipermutahedra of Ardila–Denham–Huh [ADH23], the type B/C-generalized permutahedra of Gelfand et al. [ACEP20, BGW03, GS87], and the generalized nested permutahedra of Castillo–Liu [CL22]. It is impossible to realize categorical n -associahedra as generalized bipermutahedra for the same reason as for the generalized permutahedra; the former cannot realize octagons. The 2-dimensional type B/C generalized permutahedron is an octagon, but the 3-dimensional type B/C permutahedron has 26 facets, whereas the 2-associahedron $W_{2,2}$ has 27 facets (see Figure 5), thus it is also impossible to realize n -associahedra in this setting. It is not so easy to exclude the generalized nested permutahedra based on f -vector considerations, although we note that the rays of the velocity fan are not rays of the nested braid fan.

and the braid arrangement. We provide an affirmative answer to this question in several ways outlined below.

While the velocity fan is not simplicial, we produce a simplicial fan $\mathcal{F}(\Delta_{\mathcal{T}})$ and establish the following result.

Proposition 1.3. (5.12) *The fan $\mathcal{F}(\Delta_{\mathcal{T}})$ is a canonical smooth flag triangulation of $\mathcal{F}(\mathcal{T})$ on the same set of rays.⁸*

The chambers of this triangulated velocity fan $\mathcal{F}(\Delta_{\mathcal{T}})$ admit a description in terms of certain rooted binary trees whose nodes are labeled by collisions. This generalizes a classical description of the associahedron, and we make an explicit connection with Postnikov’s B -trees and nestohedra, an important family of generalized permutahedra arising from the theory of wonderful compactifications. We also describe a second, finer triangulation $\mathcal{F}(\mathcal{O}(\mathcal{T}))$ which specializes to the triangulation of the normal fan of Loday’s associahedron by the braid arrangement, and thus offers a new generalization of the braid arrangement associated to a rooted plane tree.

Generalized permutahedra can be characterized as those polytopes whose normal fans have walls which are orthogonal to the type A roots $e_i - e_j$ and thus Loday’s associahedron, being a generalized permutahedron, has a normal fan with this property. We apply the triangulated velocity fan to give a recursive calculation of the normal vectors for the walls of the velocity fan. In particular, our calculation demonstrates that the normal vectors of the walls of $\mathcal{F}(\mathcal{T})$ have unbounded support.

As a second application of the triangulated velocity fan, we prove that the map Γ from Proposition 1.2 restricts to a monoid isomorphism from the integral metric n -bracketings in a conical set of $\mathcal{K}^{\text{met}}(\mathcal{T})$ to the integer points in the corresponding cone of the velocity fan $\mathcal{F}(\mathcal{T})$.

We then produce a function Γ_{ζ}^{ρ} on the velocity fan and prove the following result.

Theorem 1.4. (6.2) *The function $\Gamma_{\zeta}^{\rho} : \mathcal{F}(\mathcal{T}) \rightarrow \mathbb{R}^m$ is a piecewise-unimodular map which is nondegenerate on each cone, and the image of each cone is union of cones in the braid arrangement \mathcal{A}_m .*

This connection between general velocity fans and the braid arrangement suggests a new extension of generalized permutahedra, which we call permutahedroids. We then produce a different family of maps $\{\Gamma_{\sigma}^{\rho}\}$ defined on certain shuffle charts $\{\Gamma(U_{\sigma})\}$ of the velocity fan which are determined by a fixed shuffle order on the underlying affine spaces. We establish the following result.

Theorem 1.5. (6.20) *For a fixed shuffle σ , the map $\Gamma_{\sigma}^{\rho} : \Gamma(U_{\sigma}) \rightarrow \mathbb{R}^m$ is a piecewise-unimodular isomorphism onto its image, and the image of each cone is a union of cones in the braid arrangement \mathcal{A}_m . Moreover, when we apply Γ_{σ}^{ρ} to $\Gamma(U_{\sigma})$ in the triangulated velocity fan, the image is a full-dimensional subfan of a nestohedral fan.*

⁸Technically, we must first quotient out these fans by their lineality space $\langle \mathbf{1} \rangle_{\mathbb{R}}$ for this statement to be accurate.

This result, applied in reverse, shows that the triangulated velocity fan can be constructed by taking a collection of certain nestohedral fans, deleting the stars of some of the coordinate rays, acting on the remaining cones by piecewise unimodular isomorphisms, and then gluing the resulting collection of cones together. See Figure 30 for an illustration of these results.

Each face of an associahedron factors as a product of smaller associahedra — this observation is essential for understanding the associahedron as an operad, and is referred to by some authors as the Hopf algebra or Hopf monoid structure of the associahedron (see [AA23]). It was shown by the second author that 2-associahedra admit a similar but more intricate recursive structure: each facet of a 2-associahedron factors as a product of two smaller objects, where the first is a smaller 2-associahedron and the second is a fiber product of 2-associahedra over an associahedron — the second author and Carmeli used this recursive structure to establish that 2-associahedra form a relative 2-operad [BC21]. We extend this description to categorical n -associahedra: each facet of an n -associahedron factors as a product of a smaller n -associahedron with an iterated fiber product of n -associahedra, and we leave open the problem of verifying that n -associahedra determine a relative n -operad. The normal fan of Loday’s associahedron realizes the recursive structure of the associahedron geometrically: the star of each ray factors as a product of two smaller such fans. The following result characterizes how this result extends to the velocity fan.

Theorem 1.6. (7.28) *Let $\rho(\mathcal{C})$ be a ray of the velocity fan $\mathcal{F}(\mathcal{T})$. There exists a piecewise-unimodular isomorphism*

$$(2) \quad \Theta_{\mathcal{C}} : \mathcal{F}(\mathcal{T})_{\rho(\mathcal{C})} \rightarrow \mathcal{F}(\mathcal{T}/_{\mathcal{C}}) \times \mathcal{F}(\mathcal{T}|_{\mathcal{C}})$$

such that $\Theta_{\mathcal{C}}^{-1}$ restricted to $\mathcal{F}(\mathcal{T}/_{\mathcal{C}}) \times \mathbf{0}$ is linear and agrees with $(P_{\sigma}^T)^{-1} \times \mathbf{0}$ restricted to $\mathcal{F}(\mathcal{T}/_{\mathcal{C}}) \times \mathbf{0}$, with σ a compatible \mathcal{T} -shuffle for \mathcal{C} , and with coordinates ordered according to σ .

We conclude our article by investigating a natural class of n -associahedra, containing the associahedron and the multiplihedron, which we call *concentrated n -associahedra*. These are the n -associahedra determined by rooted plane trees such that each pair of vertices at depth k are siblings. For this class, there can be no shuffling of subspaces during a collision in the corresponding arrangement. This manifests geometrically in an interesting way: the velocity fans of concentrated n -associahedra are coarsenings of the braid arrangement. As an advertisement for our future work, where we will investigate projectivity for general velocity fans, we establish the following result.

Theorem 1.7. (8.31) *Each concentrated n -associahedron $\mathcal{K}(\mathcal{T})$ can be realized as the face poset of an integral generalized permutahedron whose normal fan is the velocity fan $\mathcal{F}(\mathcal{T})$.*

We give explicit facet and vertex descriptions for these polytopes generalizing Loday’s realization of the associahedron and Forcey’s realization of Stasheff’s multiplihedron. Additionally, we describe these polytopes as positive Minkowski sums of standard simplices generalizing a description of Loday’s associahedron due to Postnikov [Pos09] and a description of Forcey’s multiplihedron due to Ardila-Doker [AD13]. We also demonstrate how to recover the constrainedhedra of the second and third authors: each constrainedhedron is the Minkowski sum of all concentrated n -associahedra with a fixed profile.

1.1. Compactified real moduli spaces.

In this subsection, we provide some further details concerning the topological realization of n -associahedra as the poset of strata of compactified moduli spaces of configurations of subspaces in \mathbb{R}^n . (This subsection is entirely motivational. In principle it can be skipped, but we recommend against this.)

We begin by recalling how the associahedra K_r can be realized as a compactified moduli space of configurations of r numbered marked points on \mathbb{R} [Kap93, Dri89, Dri88, LTV10]. (It is more conventional to consider $r + 1$ marked points on S^1 , with one marked point distinguished; this is an entirely equivalent perspective.) This realization is a necessary part of the construction of the Fukaya category of a symplectic manifold [Sei08, §9f], because the pseudoholomorphic maps involved in the definition of the composition operation have domains that are disks with boundary marked points, one of them distinguished.

Define \mathcal{M}_r to be the moduli space

$$(3) \quad \mathcal{M}_r := \{(x_1, \dots, x_r) \mid x_1 < \dots < x_r\} / \sim,$$

where the quotient indicates that we identify two configurations that differ by an overall translation and dilation $x \mapsto ax + b$, for $a \in \mathbb{R}_{>0}$, $b \in \mathbb{R}$.

Example 1.8. Consider the case of \mathcal{M}_4 . The locus of points of the form $(0, 1, x_3, x_4)$ with $1 < x_3 < x_4$ defines a global slice for the action of translations and dilations, so we can identify \mathcal{M}_4 with an open simplex. △

We can form a Gromov-compactification of \mathcal{M}_r by defining $\overline{\mathcal{M}}_r$ to be the moduli space of *stable trees of configurations of points on \mathbb{R}* . We will not define $\overline{\mathcal{M}}_r$ precisely, but we invite the interested reader to consult [Bot19b, §2].⁹ $\overline{\mathcal{M}}_r$ is constructed by including limits of Cauchy sequences in \mathcal{M}_r , following the instruction that when points collide, we “zoom in” on the collision site and remember the fashion in which the points collided by adding in an auxiliary copy of \mathbb{R} that carries these points. The space $\overline{\mathcal{M}}_r$ naturally has the structure of a CW complex. In fact, it is a CW

⁹A standard technique in symplectic geometry is to enlarge spaces of pseudoholomorphic maps by including nodal maps, to form “Gromov-compactified moduli spaces”. The principle is that when the gradient blows up in a sequence of maps, one rescales at the blowup point to form a “bubble”. This is treated in great detail in [MS12, §§4–5, and §4.2 in particular]. The Gromov-compactification of \mathcal{M}_r that we describe here is an analogous procedure for configuration spaces, rather than spaces of maps. In the symplectic context, these configuration spaces should be thought of as moduli spaces of domains.

realization of \mathcal{M}_r : the poset of cells is isomorphic to the associahedron K_r . See Figure 1 for a depiction of the $r = 4$ case.

We motivate the n -associahedra in terms of a generalization of $\overline{\mathcal{M}}_r$. Specifically, we will consider moduli spaces of certain configurations of affine subspaces of \mathbb{R}^n . While we will not prove a relationship between these spaces and the n -associahedra, we expect that they are a topological, and even a smooth, realization of the n -associahedra, just as $\overline{\mathcal{M}}_r$ is a topological realization of K_r . (See Expectation 1.10.)

We begin by defining *trees of spaces*.

Definition 1.9. Let n and k be positive integers with $k \leq n$. We say that $V \subset \mathbb{R}^n$ is an *initial coordinate subspace of dimension k* if there exists a vector $\mathbf{a} \in \mathbb{R}^{n-k}$ such that

$$(4) \quad V = \{\mathbf{x} \in \mathbb{R}^n \mid x_j = a_j \forall j \in [1, n - k]\}.$$

A *tree of spaces in \mathbb{R}^n* is a nonempty finite collection $\mathcal{C} = \bigcup_{k=0}^n \mathcal{C}_k$ of initial coordinate subspaces in \mathbb{R}^n , such that the following conditions hold:

- (1) Every $A \in \mathcal{C}_k$ has dimension k .
- (2) For every $k \leq n - 1$ and $A \in \mathcal{C}_k$, there exists $A' \in \mathcal{C}_{k+1}$ such that the containment $A \subset A'$ holds.

The *type* of \mathcal{C} is the directed rooted plane tree defined like so:

- (1) We define the vertex set by $V(\mathcal{T}(\mathcal{C})) := \mathcal{C}$. For clarity, we denote by p_A the vertex corresponding to $A \in \mathcal{C}$.
- (2) For $A, A' \in \mathcal{C}$, there is an edge from p_A to $p_{A'}$ if and only if $\dim A' = \dim A + 1$, and A is contained in A' .
- (3) The root of $\mathcal{T}(\mathcal{C})$ is $p_{\mathbb{R}^n}$.
- (4) For any $p_A \in \mathcal{C}_k$, we equip the set of incoming vertices of p_A with the linear order induced by considering the $(n - k + 1)$ -st coordinate of the elements of \mathcal{C}_{k-1} contained in A .

Suppose that \mathcal{C} is a tree of spaces in \mathbb{R}^n . We say that \mathcal{C} is *stable* if \mathcal{C}_0 is nonempty, and $\mathcal{T}(\mathcal{C})$ has at least $n + 1$ edges. △

Now that we have introduced trees of spaces, we can explain the topological version of the n -associahedra. Suppose that \mathcal{T} is a depth- n rooted plane tree with at least $n + 1$ edges. We then define $\widehat{\mathcal{M}}(\mathcal{T})$ to be the collection of all stable trees of spaces in \mathbb{R}^n of type \mathcal{T} . The group $\mathbb{R}^n \rtimes \mathbb{R}_{>0}$ acts on \mathbb{R}^n by translations and dilations, which induces an action of the same group on $\widehat{\mathcal{M}}(\mathcal{T})$. The stability condition implies that this action is free, and we now define $\mathcal{M}(\mathcal{T})$ to be the quotient

$$(5) \quad \mathcal{M}(\mathcal{T}) := \widehat{\mathcal{M}}(\mathcal{T}) / (\mathbb{R}^n \rtimes \mathbb{R}_{>0}).$$

In the following expectation, we describe a compactification of $\mathcal{M}(\mathcal{T})$ that is motivated by the Gromov-compactification of the $n = 2$ case of $\mathcal{M}(\mathcal{T})$ performed in [Bot19b] and Bottman–Oblomkov’s work in [BO19]. This compactification is the

topological version of the n -associahedra. We intend to verify the following expectation in forthcoming work. This expectation shows how $\mathcal{M}(\mathcal{T})$ informs our definition of categorical n -associahedra in §2.

Expectation 1.10. For any depth- n rooted plane tree with at least $n + 1$ edges, there is a compact, contractible, and metrizable space $\overline{\mathcal{M}}(\mathcal{T})$ that contains $\mathcal{M}(\mathcal{T})$ as a dense subset. This will reduce to the space $\overline{2\mathcal{M}}_{\mathbf{n}}$ constructed in [Bot19b] in the case $n = 2$. Convergence in $\overline{\mathcal{M}}(\mathcal{T})$ will be defined in terms of the Gromov-convergence explained in [Bot19b, §1]. Given a sequence $(\mathcal{C}^{(i)})_{i=1}^{\infty}$ of trees of spaces in $\mathcal{M}(\mathcal{T})$, here is the approximate procedure for determining the limit:

- (1) Identify the set of points $p \in \mathbb{R}^n$ with the property that as $i \rightarrow \infty$, a collision takes place at p and involves at least one marked point.
- (2) For each such p , choose a sequence of real numbers $\epsilon_1, \epsilon_2, \dots \rightarrow 0^+$ such that if we recenter $\mathcal{C}^{(i)}$ at p and rescale by a factor of $\frac{1}{\epsilon_i}$, then we have separated the objects that are the slowest to collide at p to a positive finite distance.
- (3) Iteratively continue this procedure until every collision has been resolved. Record the results in a tree of trees of spaces.

We encourage the reader to consult [Bot19b, §1.1] for a detailed and explicit example of a Gromov-convergent sequence. The Gromov-compactification $\overline{\mathcal{M}}(\mathcal{T})$ will have a stratification (in fact, a CW decomposition) by combinatorial type of the trees of trees of spaces, and the poset of strata will coincide with the categorical n -associahedron $\mathcal{K}(\mathcal{T})$.

The construction of $\overline{\mathcal{M}}(\mathcal{T})$ is purely topological, but we intend to go further and equip it with a smooth structure — specifically, with the structure of a manifold with generalized corners [Joy16]. These are generalizations of manifolds with corners, which can be thought of as a positive-real version of toroidal varieties. In the $n = 2$ case, the first author constructed with Oblomkov in [BO19] a complex version of the 2-associahedra as toroidal complex varieties. The ideas in Bottman–Oblomkov’s work can be used to endow the $n = 2$ case of $\overline{\mathcal{M}}(\mathcal{T})$ with the structure of a manifold with g -corners. We plan to generalize Bottman–Oblomkov’s work to the arbitrary- n case, and to show that in a precise sense, the positive-real part of the resulting varieties can be identified with $\overline{\mathcal{M}}(\mathcal{T})$. \triangle

1.2. The wonderful associahedral fan and the braid arrangement.

We give a brief self-contained presentation of the associahedron and the normal fan of Loday’s realization of the associahedron, which we refer to in this article as the *wonderful associahedral fan*.¹⁰ A *bracket* of $[n]$ is a nonempty consecutive subset $A \subseteq [n]$.

Definition 1.11. A *bracketing* is a collection \mathcal{B} of brackets from $[n]$ such that

¹⁰We have chosen this name because the toric variety of this fan corresponds to a wonderful compactification of the torus, in the sense of De Concini-Procesi [DCP95], with respect to a building set which is neither maximal nor minimal. Pilaud [Pil22] calls this fan the *sylvestre fan* — “sylvestre” is an old English word meaning forest.

- (1) $[n] \in \mathcal{B}$,
- (2) for each $i \in [n]$, we have $\{i\} \in \mathcal{B}$,
- (3) if $A_i, A_j \in \mathcal{B}$ and $A_i \cap A_j \neq \emptyset$, then $A_i \subseteq A_j$ or $A_j \subseteq A_i$.

The associahedron \mathcal{K}_n is the collection of all bracketings of $[n]$ ordered by containment.¹¹ △

Loday’s polytopal realization of the associahedron is one of the most important realizations of the associahedron. It is celebrated for being the simplest realization as well as for making appearances in many different parts of mathematics [PSZ23]. Here we do not fully recall the construction of Loday’s polytopal realization (it is recoverable as a special case of the results in §8 on concentrated n -associahedra). We instead give a description of the normal fan for Loday’s realization of the associahedron, *the wonderful associahedral fan*. We will later observe that our velocity fan realization of categorical n -associahedra specializes to the wonderful associahedral fan for categorical 1-associahedra, i.e. associahedra.

Definition 1.12. Let $n \in \mathbb{Z}_{\geq 2}$, and let $A \subseteq [n]$ be a bracket. We define the vector $\rho(A) \in \mathbb{R}^{n-1}$ with i th entry

$$(6) \quad \rho(A)_i = \begin{cases} 1 & \text{if } i, i+1 \in A \\ 0 & \text{otherwise.} \end{cases}$$

Given a bracketing \mathcal{B} we define the associated cone

$$(7) \quad \tau(\mathcal{B}) = \text{cone}\{\rho(A) : A \in \mathcal{B}\} + \langle \mathbf{1} \rangle_{\mathbb{R}}.$$

The *wonderful associahedral fan* is the collection of polyhedral cones

$$(8) \quad \mathcal{F}_n = \{\tau(\mathcal{B}) : \mathcal{B} \in \mathcal{K}_n\}.$$

△

Definition 1.13. Let $n \in \mathbb{N}$. The *braid arrangement* \mathcal{A}_n is the following collection of hyperplanes in \mathbb{R}^n :

$$(9) \quad \mathcal{A}_n = \{H_{i,j} = \{\mathbf{x} \in \mathbb{R}^n : x_i = x_j\} : 1 \leq i \neq j \leq n\}.$$

One may identify a hyperplane arrangement with the fan structure it induces on \mathbb{R}^n . Thus, as an abuse of terminology and notation, we will also call the following fan, the braid arrangement. Let $\mathbf{F} = \{\emptyset = F_0 \subsetneq \dots \subsetneq F_k = [n]\}$ denote a flag of subsets. Let \mathcal{F}_n denote the set of all such flags. Given a set $S \subseteq [n]$, let χ_S denote the indicator vector for S . Given $\mathbf{F} \in \mathcal{F}_n$ we associate the cone

$$(10) \quad \tau_{\mathbf{F}} = \left\{ \sum_{F_i \in \mathbf{F}} \lambda_i \chi_{F_i} : \lambda_i \geq 0 \right\} + \langle \mathbf{1} \rangle_{\mathbb{R}},$$

¹¹The brackets in (1) and (2) are not strictly necessary. We have chosen to include them as this definition of a bracketing is compatible with our definition of n -bracketings (where the maximum and singleton brackets are more useful).

and we define *the braid arrangement* to be

$$(11) \quad \mathcal{A}_n = \{\tau_{\mathbf{F}} : \mathbf{F} \in \mathcal{F}_n\}.$$

△

Definition 1.14. A *generalized permutahedron* [Pos09], equivalently a *polymatroid base polytope* [EDM70], is a polytope whose normal fan coarsens the braid arrangement \mathcal{A}_n . A generalized permutahedron, or polymatroid base polytope, is *integral* if its vertices have integer coordinates. △

Theorem 1.15. [SS93, Lod04, Pos09] (see [PSZ23]) *The wonderful associahedral fan \mathcal{F}_n is a complete fan whose face poset is \mathcal{K}_n . Moreover, \mathcal{F}_n is a coarsening of the braid arrangement, and \mathcal{F}_n is the normal fan of a polytope (an integral generalized permutahedron).*

1.3. Glossary of essential notation.

notation	interpretation	page first defined
\mathcal{T}	a rooted plane tree	p. 18
$V^k(\mathcal{T})$	the depth k vertices of \mathcal{T}	p. 18
$\pi^k(\mathcal{T})$	The k -th truncation of \mathcal{T}	p. 18
$C(u)$	the children of u	p. 18
$D(u)$ ($\bar{D}(u)$)	the (weak) descendants of u	p. 18
u_i^k	the i -th depth- k vertex \mathcal{T} with respect to the plane order	p. 18
$A = (A^0, \dots, A^k)$	a k -bracket	p. 18
$\mathcal{B} = (\mathcal{B}^0, \dots, \mathcal{B}^n)$	an n -bracketing	p. 20
\mathcal{B}_{\min}	the minimum n -bracketing	p. 20
$\mathcal{K}(\mathcal{T})$	a categorical n -associahedron	p. 21
$\mathcal{K}(A)$	the restriction of $\mathcal{K}(\mathcal{T})$ to an n -bracket A	p. 23
$\hat{\mathcal{K}}(\mathcal{T})$	$\mathcal{K}(\mathcal{T}) \sqcup \{\star\}$, the completion of $\mathcal{K}(\mathcal{T})$	p. 24
\mathcal{C}	a collision	p. 25
$\mathfrak{X}(\mathcal{T})$	the collection of collisions	p. 25

$\widehat{\mathfrak{X}}(\mathcal{T})$	$\mathfrak{X}(\mathcal{T}) \sqcup \{\mathcal{B}_{\min}\}$	p. 25
$\psi_{\mathcal{T}/\mathcal{C}}^{\mathcal{T}}$	the collision map associated to \mathcal{C}	p. 29
\mathcal{T}/\mathcal{C}	the quotient of a rooted plane tree by a collision	p. 31
\mathcal{F}, \mathcal{G}	cone complexes, e.g. fans	p. 38
$\mathcal{P}(\mathcal{F})$	the face poset of a cone complex	p. 39
$(\mathcal{B}, \ell_{\mathcal{B}})$	a metric n -bracketing with underlying n -bracketing \mathcal{B}	p. 43
$\ell(\mathcal{C})$	the standard metric n -bracketing associated to a collision	p. 45
$\mathcal{K}^{\text{met}}(\mathcal{T}), (\overline{\mathcal{K}}^{\text{met}}(\mathcal{T}))$	the (reduced) metric n -bracketing complex associated to \mathcal{T}	p. 48
\mathbf{v}	vector notation	p. 49
$\mathbf{1}$	the all-ones vector	p. 49
$\rho(\mathcal{C})$	the standard ray generator for the collision \mathcal{C}	p. 49
$\tau(\mathcal{B})$	the cone in the velocity fan associated to the n -bracketing \mathcal{B}	p. 49
$\mathcal{F}(\mathcal{T}), (\overline{\mathcal{F}}(\mathcal{T}))$	the (reduced) velocity fan associated to \mathcal{T}	p. 50, (p. 51)
$\pi(\mathcal{K}(\mathcal{T}))$	$\mathcal{K}(\pi(\mathcal{T}))$	p. 53
$P_{\sigma}^{\mathcal{T}}$	the adjoint permutation transformation associated to σ	p. 56
$\mathcal{F}(\Delta_{\mathcal{T}}), (\overline{\mathcal{F}}(\Delta_{\mathcal{T}}))$	the (reduced) triangulated velocity fan associated to \mathcal{T}	p. 75, (p. 75)
$\mathcal{K}(\mathcal{T} _{\mathcal{C}})$	the fiber product associated to a collision	p. 114

1.4. Acknowledgments.

We thank Federico Castillo, Sergei Elizalde, Gaku Liu, Sam Molcho, Arnau Padrol, Sam Payne, Vincent Pilaud, Vic Reiner, Andrew Sack, David Speyer, Eric Stucky, Jim Stasheff, Hugh Thomas, Martin Ulirsch, Greg Warrington, and Geva Yashfe for helpful conversations.

S.B. was supported by a Simons Collaboration Gift #854037 and an NSF Grant (DMS-2246967). N.B. was supported by an NSF Grant (DMS-1906220). D.P. was

supported by Danish National Research Foundation grant (DNRF157). S.B., N.B., and D.P. are grateful to the Max Planck Institute for Mathematics in Bonn for its hospitality and financial support. S.B. and D.P. are thankful to the Simons Center for Geometry and Physics for their hospitality and financial support during the workshop “Combinatorics and Geometry of Convex Polyhedra”.

2. n -BRACKETINGS AND CATEGORICAL n -ASSOCIAHEDRA

In this section, we will define the categorical n -associahedra and explore their basic structure.

2.1. The definition of categorical n -associahedra.

Our input for defining an n -associahedron will be a rooted plane tree of depth n . The rooted plane trees of depth 1 are naturally in bijection with the natural numbers and index 1-associahedra, i.e. classical associahedra.

Definition 2.1. A *rooted tree* \mathcal{T} is a tree equipped with a distinguished vertex u_0 , called the *root*. The *depth* of a vertex u in \mathcal{T} is the distance from u_0 to u . The depth of \mathcal{T} is the maximum depth of a vertex in \mathcal{T} . We denote the set of depth k vertices in \mathcal{T} by $V^k(\mathcal{T})$.

Given a rooted tree \mathcal{T} with root u_0 and distinct $u, w \in V(\mathcal{T})$, we say that w is a *descendant* of u if u is on the unique path from u_0 to w . If w is a descendant of u and, in addition, (u, w) is an edge of \mathcal{T} , we say that w is a *child* of u . We denote the set of descendants of u by $D(u)$, and the set of children of u by $C(u)$. The set of *weak descendants* of u is $\bar{D}(u) := D(u) \sqcup \{u\}$.

Given rooted tree \mathcal{T} of depth n , we define the *k -level truncation* of \mathcal{T} to be the tree $\pi^{n-k}(\mathcal{T})$ obtained by deleting all of the vertices of depth greater than k . For simplicity, we refer to the $(n-1)$ -level truncation of a rooted plane tree of depth n as simply the *truncation* of \mathcal{T} , and denote it as $\pi(\mathcal{T})$. \triangle

Definition 2.2. A *rooted plane tree* \mathcal{T} will be a rooted tree \mathcal{T} with a total order $<_{\mathcal{T}}$ on the children $C(u)$ of each vertex $u \in V(\mathcal{T})$. \triangle

Definition 2.3. We can naturally encode the vertices of a rooted plane tree by positive integer vectors: suppose that w is the i -th child of u , and $\mathbf{v}(u)$ is the positive integer vector which encodes u . The positive integer vector $\mathbf{v}(w)$ encoding w is obtained from $\mathbf{v}(u)$ by appending an entry equal to i . The lexicographic ordering of $V^k(\mathcal{T})$ induces a total order on the vertices of $V^k(\mathcal{T})$, which we denote by $<_{\mathcal{T}}$ (as it extends the total order on the children of each vertex). We let $u_i^k \in V(\mathcal{T})$ denote the i th vertex of $V^k(\mathcal{T})$ with respect to $<_{\mathcal{T}}$. See Figure 7. \triangle

Definition 2.4 (k -brackets). Fix $n \geq 0$ and a rooted plane tree \mathcal{T} of depth n . Fix k with $0 \leq k \leq n$. A *k -bracket* of \mathcal{T} is a tuple $A = (A^0, \dots, A^k)$ where for each $1 \leq i \leq k$, $A^i \subseteq V^i(\mathcal{T})$, and the following conditions hold.

- (1) If $u \in A^i$ then the parent of u is in A^{i-1} .

- (2) If $u \in A^{i-1}$, then $A^i \cap C(u)$ is a consecutive subset of $C(u)$ with respect to $<_{\mathcal{T}}$. △

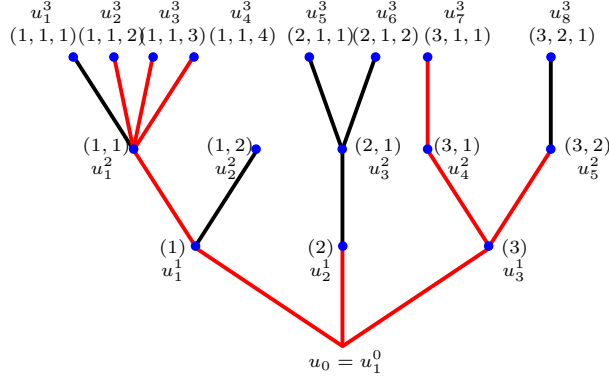

FIGURE 7. A rooted plane tree previously depicted in Figure 3, and a subtree whose vertices determine a 3-bracket.

Definition 2.5 (truncation of k -brackets). Suppose that $A = (A^0, \dots, A^k)$ is a k -bracket of a rooted plane tree \mathcal{T} , and suppose that k is at least 1. Then the *truncation* $\pi(A)$ of A is the $(k-1)$ -bracket (A^0, \dots, A^{k-1}) . For any $0 \leq i \leq n$, we denote by $\pi^i(A)$ the result of applying π to A i times. △

Remark 2.6. We will use the notation π for several different, but compatible, notions of truncations in this paper. We may alternately refer to truncations as *projections*. We say that an object Y is a *weak projection* of an object X , or that X *weakly projects to* Y , if there exists some $i \geq 0$ such that $\pi^i(X) = Y$. △

Remark 2.7. Throughout this paper, we will use superscripts to indicate the different parts of a bracket (and later, a bracketing); we will use subscripts to index different objects. △

Definition 2.8 (singleton, maximum, and nontrivial k -brackets). Suppose that u is a depth- k vertex of a rooted plane tree \mathcal{T} , for some $k \geq 0$. Then the *singleton k -bracket associated to u* , denoted $A(u)$, is the k -bracket where $A(u)^\ell$ consists of the unique depth- ℓ vertex of \mathcal{T} that lies on the path between u and the root of \mathcal{T} .

For any depth- n rooted plane tree \mathcal{T} and k with $0 \leq k \leq n$, the *maximum k -bracket of \mathcal{T}* is the k -bracket A such that $A^\ell = V^\ell(\mathcal{T})$ for $\ell \leq k$. We say that a k -bracket A of \mathcal{T} is *nontrivial* if A is neither a singleton k -bracket nor the maximum k -bracket. △

Definition 2.9 (containment of k -brackets). Suppose that A_1 and A_2 are k -brackets of \mathcal{T} . We write $A_1 \subseteq A_2$ if, for every ℓ with $0 \leq \ell \leq k$, we have $A_1^\ell \subseteq A_2^\ell$. △

We encourage the reader to refer to Figures 8 and 9 while parsing the following definition. In those figures, and all future figures, we depict a k -bracket A by drawing

a bubble in a tree arrangement which encloses the elements in A^k , and projects to the bubble depicting $\pi(A)$.

Definition 2.10 (*n*-bracketings). Fix $n \geq 0$ and a rooted plane tree \mathcal{T} of depth n that has at least $n + 1$ edges, i.e. \mathcal{T} is not a path. An *n*-bracketing of \mathcal{T} is a pair

$$(12) \quad \mathcal{B} = ((\mathcal{B}^0, \dots, \mathcal{B}^n), <_{\mathcal{B}}),$$

where for each k , \mathcal{B}^k is a collection of k -brackets of \mathcal{T} , and $<_{\mathcal{B}}$ is a partial order on $\bigsqcup_{k=0}^n \mathcal{B}^k$, called *the height partial order*, such that \mathcal{B} satisfies the following conditions.

(TRIVIAL k -BRACKETS) Each \mathcal{B}^k contains the maximum k -bracket and every singleton k -bracket of \mathcal{T} .

(k -BRACKETING PROJECTION) If $A \in \mathcal{B}^k$ with $1 \leq k \leq n$, then $\pi(A) \in \mathcal{B}^{k-1}$.

(NESTED) If $A_1, A_2 \in \mathcal{B}^k$ and $A_1^k \cap A_2^k \neq \emptyset$, then $A_1 \subseteq A_2$ or $A_2 \subseteq A_1$.

For any k with $1 \leq k \leq n$ and any $A \in \mathcal{B}^{k-1}$, write $\mathcal{B}_A^k := \{ \tilde{A} \in \mathcal{B}^k \mid \pi(\tilde{A}) = A \}$.

(PARTITION)

- For any k with $1 \leq k \leq n$ and $A \in \mathcal{B}^{k-1}$, we have $\bigcup_{\tilde{A} \in \mathcal{B}_A^k} \tilde{A}^k = \bigcup_{u \in A} C(u)$.
- Fix $A_1, A_2 \in \mathcal{B}_A^k$ with $A_2 \subsetneq A_1$. For every $u \in A^{k-1}$ and $u' \in C(u) \cap A_1^k$, there exists $A_3 \in \mathcal{B}_A^k$ with $A_3 \subsetneq A_1$ and $u' \in A_3^k$.

(HEIGHT PARTIAL ORDERS) The height partial order $<_{\mathcal{B}}$ has the following properties:

- Distinct $A_1, A_2 \in \mathcal{B}^k$ are comparable with respect to $<_{\mathcal{B}}$ if and only if $\pi(A_1) = \pi(A_2)$ and $A_1^k \cap A_2^k = \emptyset$.
- For any $u \in V^{k-1}(\mathcal{T})$ and for any $u_1, u_2 \in C(u)$ with $u_1 <_{\mathcal{T}} u_2$, we have

$$(13) \quad A(u_1) <_{\mathcal{B}} A(u_2).$$

- Fix $\tilde{A}, A \in \mathcal{B}^{k-1}$ with $A \subseteq \tilde{A}$. Fix distinct $A_1, A_2 \in \mathcal{B}_A^k$ and distinct $\tilde{A}_1, \tilde{A}_2 \in \mathcal{B}_{\tilde{A}}^k$ such that $\tilde{A}_1 \subseteq A_1$ and $\tilde{A}_2 \subseteq A_2$, and such that A_1 and A_2 , respectively \tilde{A}_1 and \tilde{A}_2 , are comparable. Then we have the equivalence

$$(14) \quad A_1 <_{\mathcal{B}} A_2 \iff \tilde{A}_1 <_{\mathcal{B}} \tilde{A}_2.$$

We let \mathcal{B}_{\min} denote the containment-minimal n -bracketing, and we give an explicit description of \mathcal{B}_{\min} : for any k with $1 \leq k \leq n$, \mathcal{B}_{\min}^k contains the singleton k -brackets and maximum k -bracket, and for each $u \in V(\mathcal{T})$, the partial order $<_{\mathcal{B}_{\min}}$ on the singleton brackets associated to $C(u)$ agrees with $<_{\mathcal{T}}$ on $C(u)$. \triangle

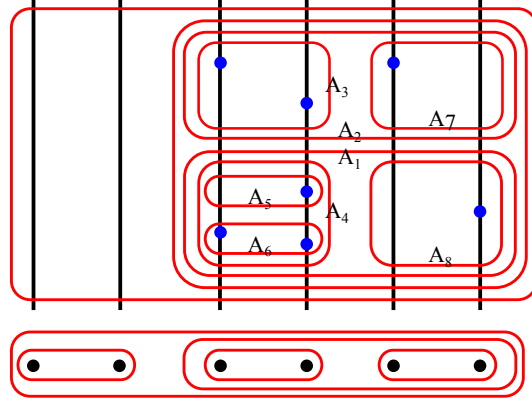

FIGURE 8. A depiction of a 2-bracketing \mathcal{B} with bubbles representing nonsingleton brackets. The conditions (k -BRACKETING PROJECTION), (NESTED), and (TRIVIAL k -BRACKETS) are easy to verify in the figure. For the relevance of the property (PARTITION), notice that the points in A_5 and A_6 partition the points in A_4 . Similarly, the points in A_1 and A_2 partition the points in the maximum 2-bracket. As the name suggests, the height partial order $<_{\mathcal{B}}$ is compatible with the heights of the bubbles in the figure. For the relevance of the property (HEIGHT PARTIAL ORDER), notice that $A_1 <_{\mathcal{B}} A_2$ which implies that $A_4 <_{\mathcal{B}} A_3$ and $A_8 <_{\mathcal{B}} A_7$. Note that there are no 2-brackets that project to the left-most 1-bracket. Because the maximum brackets are always present in a bracketing, we may omit them in some later figures. We will depict maximum brackets when we feel that they help illustrate some aspect of a construction or argument, e.g. when they appear as essential brackets in a collision, or when they are in the support of a metric n -bracketing.

Definition 2.11 (categorical n -associahedra). Let \mathcal{T} be a rooted plane tree. The categorical n -associahedron $\mathcal{K}(\mathcal{T})$ (or simply n -associahedron) is the collection of n -bracketings of \mathcal{T} equipped with the following partial order: $\mathcal{B}_1 \leq \mathcal{B}_2$ if for every k with $0 \leq k \leq n$ we have that $\mathcal{B}_1^k \subseteq \mathcal{B}_2^k$, and $<_{\mathcal{B}_1}$ is a restriction of $<_{\mathcal{B}_2}$. \triangle

Remark 2.12. There is a unique 0-associahedron, and it is the singleton poset. \triangle

Remark 2.13. In the case of 2-associahedra, the poset $\mathcal{K}(\mathcal{T})$ defined above is the opposite of the poset $W_{\mathbf{n}}^{\text{br}}$ defined by the second author. We have chosen to work with $\mathcal{K}(\mathcal{T})$ because it is compatible with the procedure of taking unions of n -bracketings, and with the facial structure of the velocity fan. \triangle

Remark 2.14. The (TRIVIAL k -BRACKETS) condition may seem strange to some readers. For one thing, we want to be able to apply the (PARTITION) condition with A the maximum $(k - 1)$ -bracket. For another, as explained with the extended height partial order below, we want the partial orders to cohere with the orders on

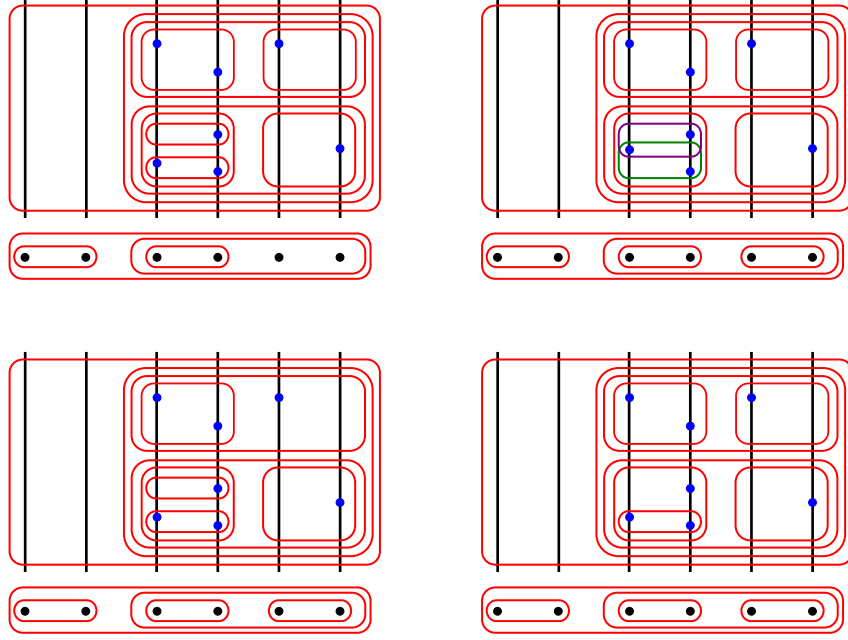

FIGURE 9. In this figure, we illustrate four different nonexamples of 2-bracketings. In the upper left, we have deleted the right-most nontrivial 1-bracket, so the result fails the $(k\text{-BRACKETING PROJECTION})$ condition. In the upper right, we have enlarged one of the smaller 2-brackets, so that the result fails the (NESTED) condition. (We have colored the relevant 2-brackets purple and green, respectively, for clarity.) In the bottom left and bottom right, we have deleted 2-brackets so that the results fail the first and second parts of the (PARTITION) condition, respectively.

vertices, which is imposed by $(\text{HEIGHT PARTIAL ORDERS})$ in conjunction with the fact that all singleton brackets are included. There are other reasons besides these; in general, the theory works better when we always include all trivial brackets. \triangle

We define a natural extension of the height partial order.

Definition 2.15. Consider an n -bracketing \mathcal{B} . Fix distinct $A_1, A_2 \in \mathcal{B}^k$ and distinct $\tilde{A}_1, \tilde{A}_2 \in \mathcal{B}^k$. If $A_1 <_{\mathcal{B}} A_2$, we set $A_1 \hat{<}_{\mathcal{B}} A_2$. If $\tilde{A}_1 \subseteq A_1$, $\tilde{A}_2 \subseteq A_2$, and $\tilde{A}_1 <_{\mathcal{B}} \tilde{A}_2$, we set $A_1 \hat{<}_{\mathcal{B}} A_2$. If $A_1 \subseteq \tilde{A}_1$, $A_2 \subseteq \tilde{A}_2$, and $\tilde{A}_1 <_{\mathcal{B}} \tilde{A}_2$, we set $A_1 \hat{<}_{\mathcal{B}} A_2$. We refer to $\hat{<}_{\mathcal{B}}$ as the *extended height partial order*. \triangle

The (NESTED) and $(\text{HEIGHT PARTIAL ORDER})$ properties imply that $\hat{<}_{\mathcal{B}}$ is well-defined. Observe in Figure 8 that $A_8 \subseteq A_1$, $A_3 \subseteq A_2$, and $A_1 <_{\mathcal{B}} A_2$, therefore $A_8 \hat{<}_{\mathcal{B}} A_3$, and this agrees with the height of these brackets in the figure.

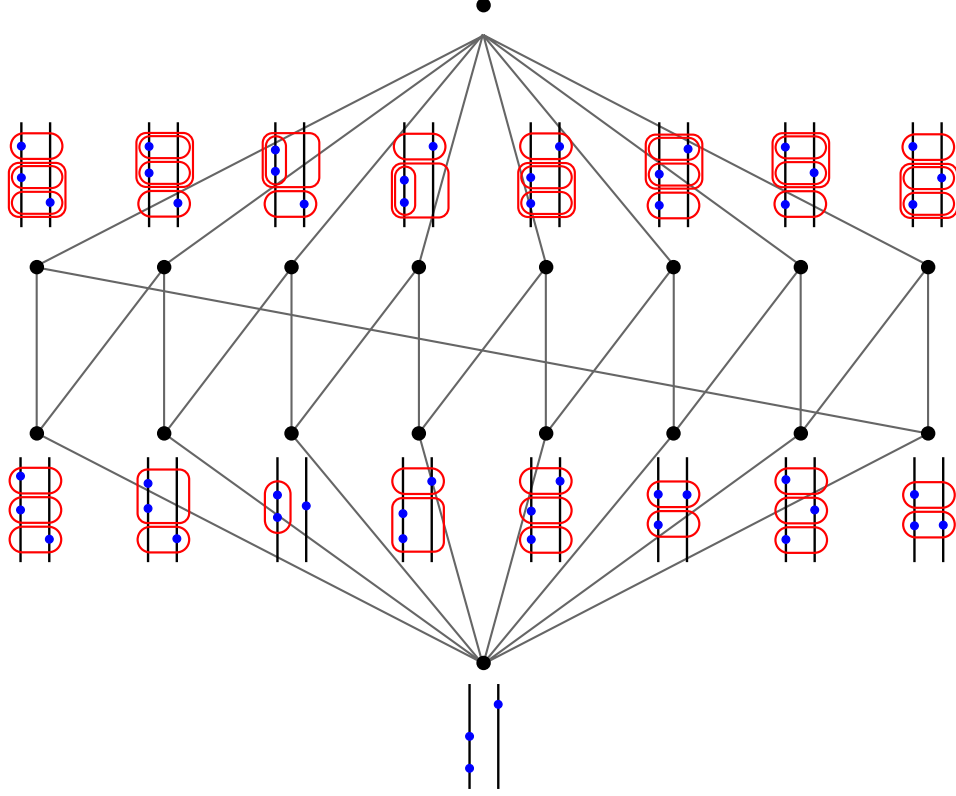

FIGURE 10. A 2-associahedron.

Lemma 2.16. *The extended height partial order $\widehat{<}_{\mathcal{B}}$ on the singleton brackets in \mathcal{B} determines the height partial order $<_{\mathcal{B}}$ on all brackets in \mathcal{B} .*

Proof. Suppose that $A_1, A_2 \in \mathcal{B}^k$ are distinct and comparable. Then $A_1 <_{\mathcal{B}} A_2$ if and only if for any pair of vertices $u_i^k \in A_1^k$ and $u_j^k \in A_2^k$, we have $A(u_i^k) \widehat{<}_{\mathcal{B}} A(u_j^k)$. \square

Definition 2.17 (restriction of an n -associahedron to an n -bracket). Let A be a k -bracket. The n -bracket A naturally defines a rooted plane subtree of \mathcal{T} depth k , which we denote $\mathcal{T}|_A$. We define $\mathcal{K}(A) := \mathcal{K}(\mathcal{T}|_A)$. \triangle

Definition 2.18. Given an n -bracketing $\mathcal{B} \in \mathcal{K}(\mathcal{T})$ and a nontrivial k -bracket $A \in \mathcal{B}^k$ for some $1 \leq k \leq n$. We say that A is *containment-minimal* in \mathcal{B} if there exists no nontrivial $A' \in \mathcal{B}^k$ such that $(A')^k \subsetneq A^k$. \triangle

Definition 2.19. Suppose that $\mathcal{B}_1, \dots, \mathcal{B}_m$ are n -bracketings in $\mathcal{K}(\mathcal{T})$. We say that this collection is *compatible* if the following conditions hold:

- (1) $\mathcal{B}_1 \cup \dots \cup \mathcal{B}_m := (\mathcal{B}_1^0 \cup \dots \cup \mathcal{B}_m^0, \dots, \mathcal{B}_1^n \cup \dots \cup \mathcal{B}_m^n)$ satisfies the (NESTED) condition in Def. 2.10.

- (2) There exists a partial order on $\mathcal{B}_1 \cup \dots \cup \mathcal{B}_m$ that satisfies the (HEIGHT PARTIAL ORDERS) condition in Def. 2.10, and restricts to the height partial order on \mathcal{B}_i for every i . \triangle

Proposition 2.20. *Suppose that $\mathcal{B}_1, \dots, \mathcal{B}_m$ are a compatible collection of n -bracketings in $\mathcal{K}(\mathcal{T})$. Then the partial order in condition (2) of Definition 2.19 is uniquely-defined. We may therefore interpret $\mathcal{B}_1 \cup \dots \cup \mathcal{B}_m$ as an n -bracketing in a unique way. \triangle*

Proof. The only part of this definition that we need to check is that if $\mathcal{B}, \mathcal{B}'$ are n -bracketings satisfying the two bulleted conditions, then the partial orders appearing in the second bullet are determined uniquely. Fix $A \in \mathcal{B}^k$ and $A' \in \mathcal{B}'^k$ that lie over the same $(k-1)$ -bracket $\tilde{A} \in \mathcal{B}^{k-1} \cup (\mathcal{B}')^{k-1}$ and that have $A^k \cap A'^k = \emptyset$. By the (NESTED) and (PARTITION) axioms, there exists $A'' \in \mathcal{B}_{\tilde{A}}$ with $A''^k \cap A'^k \neq \emptyset$. A and A'' are comparable by $<_{\mathcal{B}}$, which determines the relation between A and A' by $<_{\mathcal{B} \cup \mathcal{B}'}$. \square

Definition 2.21. Given a poset \mathcal{P} without a maximum element, we define the completion of \mathcal{P} , denoted $\widehat{\mathcal{P}}$, as the poset on set of elements $\mathcal{P} \sqcup \{\star\}$ having the relations from \mathcal{P} and the added relations $\star \geq x$ in $\widehat{\mathcal{P}}$ for every $x \in \mathcal{P}$. \triangle

Definition 2.22. A *join-semilattice* is a partially ordered set \mathcal{P} such that for any $x, y \in \mathcal{P}$, the least upper bound for $\{x, y\}$ exists in \mathcal{P} . In such a case we write $x \vee y$ for this least upper bound and call this object the *join* of x and y . Similarly, a *meet-semilattice* is a partially ordered set \mathcal{P} such that for any $x, y \in \mathcal{P}$, the greatest lower bound for $\{x, y\}$ exists in \mathcal{P} . In such a case we write $x \wedge y$ for this least upper bound and call this object the *meet* of x and y . A *lattice* is a poset which is both a join-semilattice and a meet-semilattice. \triangle

It is a classical fact that join-semilattice with a minimum element is also a meet-semilattice, and thus a lattice.

Proposition 2.23. *The poset $\widehat{\mathcal{K}}(\mathcal{T})$ is a lattice.*

Proof. The poset $\widehat{\mathcal{K}}(\mathcal{T})$ has a minimum element \mathcal{B}_{\min} , hence it suffices to show that $\widehat{\mathcal{K}}(\mathcal{T})$ is a join-semilattice. Given two n -bracketings \mathcal{B} and \mathcal{B}' , $\mathcal{B} \cup \mathcal{B}'$ is the smallest n -bracketing such that $\mathcal{B} \leq \mathcal{B} \cup \mathcal{B}'$ and $\mathcal{B}' \leq \mathcal{B} \cup \mathcal{B}'$ if one exists, in which case $\mathcal{B} \vee \mathcal{B}' = \mathcal{B} \cup \mathcal{B}'$. If $\mathcal{B} \cup \mathcal{B}'$ does not exist, then $\mathcal{B} \vee \mathcal{B}' = \star$. \square

Next we demonstrate that n -associahedra are flag. While flagness is a condition typically discussed for (face posets of) simplicial complexes, and $\mathcal{K}(\mathcal{T})$ is usually not simplicial, flagness exists in greater generality. The following definition is equivalent to the one given in [Hua24].

Definition 2.24. Let \mathcal{P} be a poset, then \mathcal{P} is *flag* if the following condition holds:

- Let $x_1, \dots, x_\ell \in \mathcal{P}$ such that $x_i \vee x_j \in \mathcal{P}$ for all $1 \leq i, j \leq \ell$, then $\bigvee_{i=1}^{\ell} x_i \in \mathcal{P}$. \triangle

Lemma 2.25. *The poset $\mathcal{K}(\mathcal{T})$ is flag.*

Proof. We prove the claim by induction on ℓ with base case $\ell = 3$. Consider n -bracketings $\mathcal{B}_1, \mathcal{B}_2, \mathcal{B}_3$. The only potential issue we must consider is whether there is a valid height partial order on $\mathcal{B} := \mathcal{B}_1 \cup \mathcal{B}_2 \cup \mathcal{B}_3$.

Fix disjoint $A, A' \in \mathcal{B}^k$ which lie over the same $(k-1)$ -bracket \tilde{A} . We must exclude the following representative situation:

$$(15) \quad A <_{\mathcal{B}_1 \cup \mathcal{B}_2} A', \quad A >_{\mathcal{B}_1 \cup \mathcal{B}_3} A'.$$

Suppose that A lies in \mathcal{B}_1 and A' lies in \mathcal{B}_2 and \mathcal{B}_3 . (The other possibilities may be treated in a similar way.) By the (NESTING) and (PARTITION) properties, we may choose $A'' \in (\mathcal{B}_1)_{\tilde{A}}$ with $(A'')^k \cap (A')^k \neq \emptyset$, and $(A'')^k \cap (A)^k = \emptyset$. Then A and A'' are comparable via $<_{\mathcal{B}_1}$, and this determines the relation between A and A' with respect to both $<_{\mathcal{B}_1 \cup \mathcal{B}_2}$ and $<_{\mathcal{B}_1 \cup \mathcal{B}_3}$.

Now take $\ell \geq 4$. By the $\ell = 3$ argument above, it is the case that for every i , $\mathcal{B}_1 \cup \mathcal{B}_2$ is compatible with \mathcal{B}_i . The collection $(\mathcal{B}_1 \cup \mathcal{B}_2) \cup (\mathcal{B}_i)_{3 \leq i \leq \ell}$ therefore satisfies the hypothesis of the lemma, so we may apply induction to this collection. \square

2.2. Collisions as atoms.

In this subsection, we introduce *collisions*, which are the minimal elements of $\mathcal{K}(\mathcal{T}) \setminus \{\mathcal{B}_{\min}\}$. We provide a combinatorial characterization of collisions and prove that the n -associahedra are atomic lattices.

Definition 2.26. Let (P, \leq) be a partially ordered set with a minimum element denoted $\hat{0}$. An atom in P is an element $x \in P$ such that x covers $\hat{0}$. \triangle

Definition 2.27. An n -bracketing \mathcal{B} is a *collision* if it is an atom in $\mathcal{K}(\mathcal{T})$. We will typically denote a collision by \mathcal{C} rather than \mathcal{B} . We let $\mathfrak{X}(\mathcal{T})$ denote the set of all collisions in $\mathcal{K}(\mathcal{T})$, and let $\hat{\mathfrak{X}}(\mathcal{T}) := \mathfrak{X}(\mathcal{T}) \sqcup \{\mathcal{B}_{\min}\}$ be the set of *extended collisions*. \triangle

Remark 2.28. The term ‘‘collision’’ is related to the geometric motivation for n -associahedra. Indeed, as described in §1.1, the n -associahedra will be the posets of strata for a certain compactification of a configuration space of coordinate subspaces in \mathbb{R}^n . A collision in $\mathcal{K}(\mathcal{T})$ corresponds to an indecomposable collision of subspaces, i.e. a codimension-1 stratum in this topological realization. \triangle

Remark 2.29. As the notation suggests, $\hat{\mathfrak{X}}(\mathcal{T})$ is naturally the completion of $\mathfrak{X}(\mathcal{T})$ equipped with a certain partial order described in §5. \triangle

We define the root bracket and fusion brackets of an n -bracketing, and utilize these notions for characterizing collisions. These results will also be used in Proposition 2.46.

Definition-Proposition 2.30. *Fix an n -bracketing $\mathcal{B} \in \mathcal{K}(\mathcal{T}) \setminus \{\mathcal{B}_{\min}\}$. Define*

$$(16) \quad S := \left\{ A(u) \in \mathcal{B} \text{ a singleton bracket} \mid \forall \text{ nontrivial } A \in \mathcal{B}, \exists \ell \geq 0 : \pi^\ell(A) = A(u) \right\}.$$

We define the root bracket of \mathcal{B} to be the k -bracket in S with the largest k . \triangle

Proof. We justify the well-definedness of the root bracket of a collision \mathcal{C} . The set S is nonempty, because it contains the unique 0-bracket. Suppose that k is the largest integer such that S contains at least one k -bracket, and suppose that $A(u_1), A(u_2)$ are k -brackets in S . Let $A \in \mathcal{B}^j$ be a nontrivial j -bracket, then by the definition of S , we must have $\pi^{j-k}(A) = A(u_1)$ and $\pi^{j-k}(A) = A(u_2)$, so $A(u_1) = A(u_2)$. \square

Definition 2.31. Fix an n -bracketing $\mathcal{B} \in \mathcal{K}(\mathcal{T})$, and denote by $A(u)$ the root bracket of \mathcal{B} . We say that $A \in \mathcal{B}$ is a *fusion bracket* of \mathcal{B} if it is a nonsingleton bracket which satisfies the following conditions:

- (1) There exists a nontrivial $\tilde{A} \in \mathcal{B}$ and $\ell \geq 0$ such that $\pi^\ell(\tilde{A}) = A$.
- (2) The projection $\pi(A)$ is a singleton bracket. \triangle

Proposition 2.32. *Suppose that $\mathcal{B} \in \mathcal{K}(\mathcal{T})$ is an n -bracketing. Then \mathcal{B} is a collision if and only if the following two conditions hold:*

- (1) \mathcal{B} has a unique fusion bracket.
- (2) For each k , there exist no nontrivial k -brackets $A, A' \in \mathcal{B}^k$ with $A \subsetneq A'$.

Proof. Suppose that \mathcal{B} is a collision, but A_1 and A_2 are two distinct fusion brackets for \mathcal{B} . We can construct an n -bracketing \mathcal{B}_1 with $\mathcal{B}_1 < \mathcal{B}$ by taking the singleton and maximum brackets together with the brackets which project to A_1 , and equipping \mathcal{B}_1 with the restriction of the height partial order for \mathcal{B} . This contradicts the claim that \mathcal{B} is a collision.

Suppose that A, A' are nontrivial brackets with $A \subsetneq A'$. Suppose that $A, A' \in \pi(\mathcal{B})$, then by induction on n , $\pi(\mathcal{B})$ is not a collision, so let $\tilde{\mathcal{B}}$ is an $(n-1)$ -bracketing with $\tilde{\mathcal{B}} < \pi(\mathcal{B})$. We can lift $\tilde{\mathcal{B}}$ to an n -bracketing $\mathcal{B}' < \mathcal{B}$ by adding the singleton and maximum n -brackets to $\tilde{\mathcal{B}}$ together with the n -brackets in \mathcal{B} which project to $(n-1)$ -brackets in $\tilde{\mathcal{B}}$, and taking $<_{\tilde{\mathcal{B}}}$ the restriction of $<_{\mathcal{B}}$. Thus we may assume that A, A' are n -brackets and $\pi(A) = \pi(A')$, then we can obtain \mathcal{B}' from \mathcal{B} by deleting A' . The (NESTED) and (PARTITION) conditions are preserved by the deletion of A' , hence \mathcal{B}' is an n -bracketing with $\mathcal{B}' < \mathcal{B}$.

Conversely, suppose that \mathcal{B} is not a collision, and \mathcal{C} is a collision such that $\mathcal{C} < \mathcal{B}$. Suppose that \mathcal{B} has a unique fusion bracket. This must be the same as the fusion bracket for \mathcal{C} . It now follows from the (NESTED) and (PARTITION) conditions that \mathcal{B} must have a pair of distinct nontrivial brackets A, A' with $A \subsetneq A'$. \square

Lemma 2.33. *Let $\mathcal{C} \in \mathfrak{X}(\mathcal{T})$ and take $A \in \mathcal{C}$ the fusion bracket of \mathcal{C} . The projection $\pi(A)$ is equal to the root bracket $A(u)$ of \mathcal{C} . In particular, every nontrivial bracket in \mathcal{C} weakly projects to A .*

Proof. Suppose that $\pi(A)$ is not the root bracket of \mathcal{C} . By the definition of the root bracket, there exists a nontrivial bracket $\tilde{A} \in \mathcal{B}$ and $\ell \geq 0$ such that for every $\ell \geq 0$, $\pi^\ell(\tilde{A}) \neq \pi(A)$. It must be that \tilde{A} projects to some fusion bracket, but this contradicts the assumption that A is the unique fusion bracket for \mathcal{C} . \square

Definition 2.34. Let \mathcal{C} be a collision. We say that:

- \mathcal{C} is *type 1* if \mathcal{C} contains a single nontrivial n -bracket A , and $\pi(A)$ is a singleton $(n - 1)$ -bracket.
 - \mathcal{C} is *type 2* if $\pi(\mathcal{C})$ is an $(n - 1)$ -collision.
 - \mathcal{C} is *type 3* if $\pi(\mathcal{C})$ is the minimal $(n - 1)$ -bracketing and \mathcal{C} is not type 1.
- △

It is a direct consequence of Lemma 2.32 that each collision is either type 1, 2, or 3.

Definition 2.35. Let $\mathcal{C} \in \mathfrak{X}(\mathcal{T})$, and $A \in \mathcal{C}^k$. We say that A is an *essential bracket* of \mathcal{C} if

- (1) there exists a nontrivial bracket $A' \in \mathcal{C}^l$ with $l \geq k$ such that $\pi^{l-k}(A') = A$, and
 - (2) there exists some $j \geq 0$ such that $\pi^j(A)$ is equal to the fusion bracket of \mathcal{C} .
- △

The set of essential brackets of a collision \mathcal{C} is a slight enlargement of the set of nontrivial brackets in \mathcal{C} ; if the fusion bracket for \mathcal{C} is a maximum bracket (necessarily the maximum 1-bracket), then the maximum k -brackets in \mathcal{C} which are projections of nontrivial brackets are essential. This subtle definition is useful, and sometimes necessary, for investigating certain constructions built from collisions.

Remark 2.36. We make the convention that the extended collision \mathcal{B}_{\min} has the maximum 1-bracket as its fusion bracket, the unique 0-bracket as its root bracket, and the collection of all maximum k -brackets as its essential brackets.

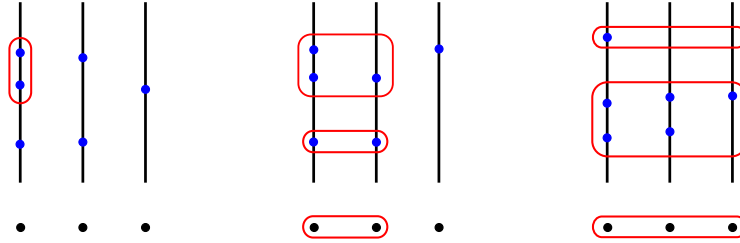

FIGURE 11. On the left, we depict a type 1 collision. As with any type 1 collision, its only nontrivial bracket is also its fusion bracket. The singleton bracket corresponding to the left line is its root bracket. In the middle is a type 2 collision. Its nontrivial 1-bracket is its fusion bracket. On the right is a type 3 collision. The maximum 1-bracket is its fusion bracket. The maximum 1-bracket is an essential bracket in this collision. This is the only essential bracket present in these three collisions which is trivial. For the middle and right collisions, the root bracket is the singleton 0-bracket, which corresponds to the plane.

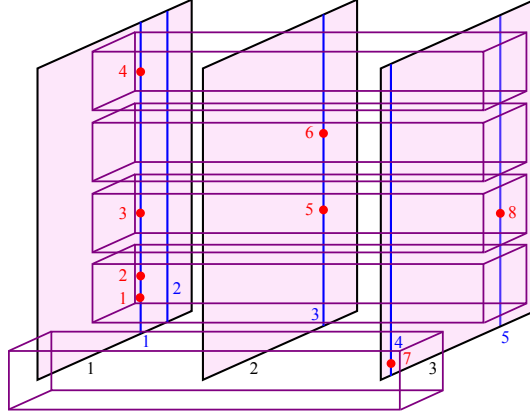

FIGURE 12. A collision in the 3-associahedron depicted in Figures 3 and 7.

Definition 2.37. A lattice is atomic if every element $x \in P$ is expressible as the join of a collection of atoms. \triangle

Lemma 2.38. *Let A be a nontrivial k -bracket in \mathcal{B}^k . There exists a collision $\mathcal{C} \leq \mathcal{B}$ with $A \in \mathcal{C}^k$.*

Proof. We prove this claim by induction on n . In what follows, we will discuss construction of collisions. To avoid repetitious language, we will implicitly always be adding the necessary singleton and maximum brackets, and necessary height partial orders will be assumed to be the restrictions of the height partial order $<_{\mathcal{B}}$. For $n = 1$, we can take \mathcal{C} to be the 1-bracketing determined by A . Next, suppose $n \geq 2$. First suppose that $k < n$, then by induction, there exists some $\tilde{\mathcal{C}}$ an $(n-1)$ -collision such that $\tilde{\mathcal{C}} \leq \pi(\mathcal{B})$ and $A \in \tilde{\mathcal{C}}^k$. We can lift $\tilde{\mathcal{C}}$ to a type 2 collision \mathcal{C} with $\mathcal{C} \leq \mathcal{B}$ by taking, for each nontrivial $(n-1)$ -bracket $A \in \mathcal{C}^{n-1}$, the collection of containment-minimal n -brackets from \mathcal{B} which project to A .

We will now assume that $A \in \mathcal{B}^n$. First, suppose that $\pi(A)$ is a singleton $(n-1)$ -bracket. Then we can take \mathcal{C} to be the type 1 collision whose fusion bracket is A .

Next, suppose that $\pi(A)$ is the maximum $(n-1)$ -bracket. We can define \mathcal{C} to be the type 3 collision whose nontrivial n -brackets consists of A along with all containment-minimal nontrivial n -brackets $A' \in \mathcal{B}^n$ with $A^n \cap (A')^n = \emptyset$ and $\pi(A')$ is the maximum $(n-1)$ -bracket. It follows from the (PARTITION) condition that \mathcal{C} is a valid n -bracketing.

Finally, suppose that $\pi(A)$ is a nontrivial $(n-1)$ -bracket. By induction, there exists an $(n-1)$ -collision $\tilde{\mathcal{C}} \leq \pi(\mathcal{B})$ such that $(\tilde{\mathcal{C}})^{n-1}$ contains $\pi(A)$. We will define a type 2 collision $\mathcal{C} \leq \mathcal{B}$ with the properties that $\pi(\mathcal{C}) = \tilde{\mathcal{C}}$, and \mathcal{C}^n contains A . For each such $(n-1)$ -bracket $\tilde{A} \in \tilde{\mathcal{C}}^{n-1}$ not equal to $\pi(A)$, we add to \mathcal{C}^n the set of containment-minimal nontrivial n -brackets in $\mathcal{B}_{\tilde{A}}$. For $\pi(A)$, we add A to \mathcal{C}^n .

together with the set of all containment-minimal nontrivial n -brackets $A' \in \mathcal{B}_{\pi(A)}$ that have $A^n \cap (A')^n = \emptyset$. \square

Proposition 2.39. *The n -associahedron $\widehat{\mathcal{K}}(\mathcal{T})$ is atomic.*

Proof. By Lemma 2.38, for each nontrivial bracket $A \in \mathcal{B}^k$, we can construct a collision \mathcal{C} with $A \in \mathcal{C}^k$ and $\mathcal{C} \leq \mathcal{B}$. The collection of such collisions, varying over all A is compatible, and thus we can take their join. By Proposition 2.20 this join is equal to \mathcal{B} . \square

2.3. Collisions as tree maps.

In this subsection we provide an alternate characterization of collisions via certain maps of rooted plane trees. This characterization will later be used for defining the velocity fan. We begin with some preparatory definitions.

Definition 2.40 (morphisms of rooted plane trees). Suppose that $\mathcal{T}, \mathcal{T}'$ are rooted plane trees. A *morphism of rooted plane trees* $f: \mathcal{T} \rightarrow \mathcal{T}'$ is a map induced by its restriction to the vertices $f: V(\mathcal{T}) \rightarrow V(\mathcal{T}')$, which must satisfy the following conditions:

- (1) f sends the root of \mathcal{T} to the root of \mathcal{T}' .
- (2) If $u, w \in V(\mathcal{T})$ and $(u, w) \in E(\mathcal{T})$, then $(f(u), f(w)) \in E(\mathcal{T}')$.
- (3) For any vertex u of \mathcal{T} , f restricts to a map $C(u) \rightarrow C(f(u))$ which is weakly-order-preserving: for $w_1, w_2 \in C(u)$ with $w_1 < w_2$, we have $f(w_1) \leq f(w_2)$. \triangle

Remark 2.41. If $f: \mathcal{T} \rightarrow \mathcal{T}'$ is a morphism of rooted plane trees, then f is a graph homomorphism. Furthermore, if we consider \mathcal{T} and \mathcal{T}' as directed graphs with all edges directed toward the roots, then f is a directed graph homomorphism. If u is a depth- k vertex of \mathcal{T} , then $f(u)$ is a depth- k vertex of \mathcal{T}' . \triangle

Definition 2.42. Let \mathcal{T} be a rooted plane tree, u a vertex of \mathcal{T} , and $W = (w_1, \dots, w_k)$ a tuple of consecutive elements of $C(u)$. We let $\mathcal{T}(u; W)$ denote to the rooted plane subtree of \mathcal{T} induced by the vertices u, w_1, \dots, w_k , and the descendants of the w_i . Here $\mathcal{T}(u; W)$ inherits the structure of a rooted plane tree with root u from \mathcal{T} . \triangle

Definition 2.43 (collision maps). Suppose that \mathcal{T} is a depth- n rooted plane tree. A *local collision map* f consists of the following data.

- A vertex u of \mathcal{T} .
- A collection W of consecutive elements of $C(u)$, with $|W| \geq 2$.
- A rooted plane tree \mathcal{T}' with one depth-1 vertex, and a surjective morphism $f: \mathcal{T}(u; W) \rightarrow \mathcal{T}'$ of rooted plane trees. We exclude the possibility that \mathcal{T}' is the path with $n + 1$ vertices.

Denote by $\tilde{\mathcal{T}}$ the result of replacing $\mathcal{T}(u; W)$ by \mathcal{T}' in \mathcal{T} . That is, we delete all the nonroot vertices of $\mathcal{T}(u; W)$ in \mathcal{T} , and then identify the root of \mathcal{T}' with the root of $\mathcal{T}(u; W)$.

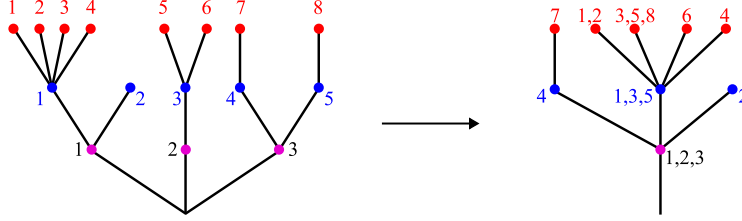

FIGURE 13. A collision map associated to the collision depicted in Figure 12.

The map $\mathcal{T}(u; W) \rightarrow \mathcal{T}'$ extends by the identity to a map $\mathcal{T} \rightarrow \tilde{\mathcal{T}}$, which we call a *global collision map*, or simply a *collision map*. We will denote a collision map as $\psi_{\tilde{\mathcal{T}}}$ or simply ψ if \mathcal{T} and $\tilde{\mathcal{T}}$ are clear from the context. Observe that given a collision map $\psi_{\tilde{\mathcal{T}}} = \psi$ we can naturally pullback brackets along this map: let A be a k -bracket on $\tilde{\mathcal{T}}$, then we let $\psi^{-1}(A)$ denote the k -bracket on \mathcal{T} with $(\psi^{-1}(A))^\ell = \psi^{-1}(A^\ell)$. \triangle

Remark 2.44. A local collision map can be recovered uniquely from the global collision map that it gives rise to, so these two notions of collision maps are equivalent. \triangle

We now explain how collision maps are naturally in bijection with collisions.

Proposition 2.45. *Let $\psi_{\tilde{\mathcal{T}}} = \psi$ be a collision map. Then we may define a collision $\mathcal{C} =: \alpha(\psi)$ of \mathcal{T} in the following way:*

- \mathcal{C} contains all singleton and maximum brackets.
- Let $u' \in V^k(\tilde{\mathcal{T}})$, and let $A(u')$ be the corresponding singleton k -bracket in $\tilde{\mathcal{T}}$. Then \mathcal{C} contains the k -bracket $\psi^{-1}(A(u'))$.
- For $u' \in V(\tilde{\mathcal{T}})$ and $u_1, u_2 \in C(u')$. Suppose that $u_1 <_{\tilde{\tau}} u_2$, then we take $\psi^{-1}(A(u_1)) <_{\mathcal{C}} \psi^{-1}(A(u_2))$.

Proof. Observe that if \mathcal{C} is an n -bracketing then it clearly satisfies the conditions of Proposition 2.32 with unique fusion bracket given by $\psi^{-1}(W)$. We now verify that \mathcal{C} is an n -bracketing.

The conditions (TRIVIAL k -BRACKETS) and (k -BRACKETING PROJECTION) are immediate. For verifying the (NESTED) condition, suppose that A_1, A_2 are k -brackets corresponding to vertices u_1, u_2 in $\tilde{\mathcal{T}}$. If $u_1 = u_2$, then A_1 and A_2 are the same k -brackets. If $u_1 \neq u_2$, then A_1^k and A_2^k are disjoint. The first part of the (PARTITION) condition holds as ψ is a surjective map of rooted plane trees. The second part of the (PARTITION) condition holds vacuously as \mathcal{C} does not contain any nested nontrivial brackets.

For verifying the first part of the (HEIGHT PARTIAL ORDERS) condition, let A_1, A_2 be k -brackets in \mathcal{C} such that $\pi(A_1) = \pi(A_2)$. This implies $A_1 = \psi^{-1}(u_1)$ and $A_2 = \psi^{-1}(u_2)$ for $u_1, u_2 \in C(u')$ for some $u' \in \tilde{\mathcal{T}}$. The condition that A_1, A_2 are

moreover disjoint is equivalent to $u_1 \neq u_2$. It follows from our definition of \mathcal{C} that A_1 and A_2 are comparable. The second and third parts of the (HEIGHT PARTIAL ORDERS) condition hold as a consequence of the fact that ψ is a map of rooted plane trees and thus is weakly order preserving. \square

Proposition 2.46. *The map α sending collision maps on \mathcal{T} to collisions on \mathcal{T} , is bijective.*

Proof. Given a collision \mathcal{C} , we construct $\alpha^{-1}(\mathcal{C}) = \psi_{\mathcal{T}/\mathcal{C}}^{\mathcal{T}}$. For describing the tree $\mathcal{T}/\mathcal{C} = \tilde{\mathcal{T}}$, we must define the tree \mathcal{T}' . We do so by taking the root bracket $A(u)$ of \mathcal{C} to be associated to the root vertex of \mathcal{T}' . Let the vertices of \mathcal{T}' correspond to the essential brackets of \mathcal{C} . We order the vertices in \mathcal{T}' according to the height partial order of \mathcal{C} . Let W be the vertices in the fusion bracket of \mathcal{C} . We define the local collision map $f : \mathcal{T}(u; W) \rightarrow \mathcal{T}'$ to send $u_i^k \in \mathcal{T}(u; W)$ to the vertex of \mathcal{T}' corresponding to the bracket $A \in \mathcal{C}^k$ such that $u_i^k \in A^k$. Given this local collision map f , we associate the global collision map $\psi_{\mathcal{T}}^{\mathcal{T}}$. It is straightforward to verify that $\psi_{\mathcal{T}}^{\mathcal{T}}$ is indeed a collision map with $\alpha(\psi_{\mathcal{T}}^{\mathcal{T}}) = \mathcal{C}$. \square

Definition 2.47 (contraction of an n -associahedron along a collision). Fix a collision $\mathcal{C} \in \mathfrak{X}(\mathcal{T})$. Let $\psi : \mathcal{T} \rightarrow \tilde{\mathcal{T}}$ be the corresponding collision map. We define the contraction of \mathcal{T} along \mathcal{C} to be $\tilde{\mathcal{T}}$, and we define, the contraction of $\mathcal{K}(\mathcal{T})$ along \mathcal{C} denoted $\mathcal{K}(\mathcal{T}/\mathcal{C})$, to be $\mathcal{K}(\tilde{\mathcal{T}})$. \triangle

Remark 2.48. Geometrically, we can think about $\mathcal{K}(\mathcal{T}/\mathcal{C})$ in the following way. Consider a collision of coordinate subspaces in \mathbb{R}^n . To take such a limit, we let subspaces fuse, and bubble off additional copies of \mathbb{R}^n wherever appropriate (see footnote 9). If we consider only the “base” copy of \mathbb{R}^n , then the combinatorial type of the arrangement of coordinate subspaces there is exactly $\tilde{\mathcal{T}}$. \triangle

Definition 2.49 (contraction of an n -bracketing along a collision). Let $\mathcal{C} \in \mathfrak{X}(\mathcal{T})$ with corresponding collision map ψ . Let $\mathcal{B} \in \mathcal{K}(\mathcal{T})$ which is compatible with \mathcal{C} . We define the quotient of \mathcal{B} by \mathcal{C} , denoted \mathcal{B}/\mathcal{C} , to be the n -bracketing with $(\mathcal{B}/\mathcal{C})^k = \{\psi(A) : A \in \mathcal{C}\}$ and the height partial order inherited from $\mathcal{B} \cup \mathcal{C}$. \triangle

We leave it to the reader to verify from the definitions that \mathcal{B}/\mathcal{C} is indeed an n -bracketing.

2.4. Collision definitions and lemmas.

We continue to develop the theory of collisions introducing several definitions and useful lemmas which will be employed in this article. The reader should feel welcome to skim (or even skip) this subsection, and return to it as it is needed.

Definition 2.50. Fix $\mathcal{C}_1, \mathcal{C}_2 \in \mathfrak{X}(\mathcal{T})$. We say that \mathcal{C}_1 is contained in \mathcal{C}_2 , and write $\mathcal{C}_1 \rightarrow \mathcal{C}_2$, if \mathcal{C}_1 and \mathcal{C}_2 are compatible and for each essential bracket $A_1 \in \mathcal{C}_1^k$, there exists an essential bracket $A_2 \in \mathcal{C}_2$ such that $A_1 \subseteq A_2$. If it is not true that $\mathcal{C}_1 \rightarrow \mathcal{C}_2$, we may write $\mathcal{C}_1 \not\rightarrow \mathcal{C}_2$. \triangle

Remark 2.51. One may alternately define $\mathcal{C}_1 \rightarrow \mathcal{C}_2$ as follows: \mathcal{C}_1 and \mathcal{C}_2 are compatible, and for every $k \geq 0$ such that $\pi^k(\mathcal{C}_2) \neq \pi^k(\mathcal{B}_{\min})$, each nontrivial $(n-k)$ -bracket $A_1 \in \mathcal{C}_1^{n-k}$ is contained in a nontrivial $(n-k)$ -bracket $A_2 \in \mathcal{C}_2^{n-k}$. We will use this characterization in arguments below. \triangle

Definition 2.52. Let $\mathcal{C}_1, \mathcal{C}_2 \in \mathfrak{X}(\mathcal{T})$ and let A_1 and A_2 be the fusion brackets for \mathcal{C}_1 and \mathcal{C}_2 , respectively. Let $\overline{D}(A_1)$ and $\overline{D}(A_2)$ denote the weak descendants of the vertices in A_1 and A_2 , respectively, then \mathcal{C}_1 and \mathcal{C}_2 are *disjoint*, written $\mathcal{C}_1 \sim \mathcal{C}_2$, if $\overline{D}(A_1) \cap \overline{D}(A_2) = \emptyset$. Equivalently for any nontrivial brackets $A_1 \in \mathcal{C}_1^k$ and $A_2 \in \mathcal{C}_2^k$ we have $A_1^k \cap A_2^k = \emptyset$. If \mathcal{C}_1 and \mathcal{C}_2 are not disjoint, we may write $\mathcal{C}_1 \asymp \mathcal{C}_2$. \triangle

Note that if $\mathcal{C}_1 \sim \mathcal{C}_2$, then \mathcal{C}_1 and \mathcal{C}_2 are compatible.

Remark 2.53. Although we are employing \sim notation, this binary relation is not an equivalence relation: it is reflexive and symmetric, but not transitive. This choice is instead motivated by graph adjacency notation as is justified in §5. \triangle

We extend the above relations to $\widehat{\mathfrak{X}}(\mathcal{T})$ by insisting that $\mathcal{C} \rightarrow \mathcal{B}_{\min}$ and $\mathcal{C} \asymp \mathcal{B}_{\min}$ for all $\mathcal{C} \in \mathfrak{X}(\mathcal{T})$. The following is immediate from the definitions.

Lemma 2.54. *Let $\mathcal{C}, \mathcal{C}' \in \mathfrak{X}(\mathcal{T})$ which are both not type 1.*

- *If $\mathcal{C} \sim \mathcal{C}'$, then $\pi(\mathcal{C}) \sim \pi(\mathcal{C}')$.*
- *If $\mathcal{C} \rightarrow \mathcal{C}'$ then $\pi(\mathcal{C}) \rightarrow \pi(\mathcal{C}')$.*

Definition 2.55. Fix $\mathcal{B} \in \mathcal{K}(\mathcal{T})$ and $\mathcal{C} \in \mathfrak{X}(\mathcal{T})$ with $\mathcal{C} \leq \mathcal{B}$. We say that \mathcal{C} is *containment-minimal* in \mathcal{B} if each nontrivial bracket $A \in \mathcal{C}^k$ is containment-minimal in \mathcal{B} . \triangle

Lemma 2.56. *Fix $\mathcal{B} \in \mathcal{K}(\mathcal{T})$ and $\mathcal{C} \in \mathfrak{X}(\mathcal{T})$. Then \mathcal{C} is containment-minimal in \mathcal{B} if and only if the following conditions hold:*

- (1) $\mathcal{C} \leq \mathcal{B}$.
- (2) *for every $\mathcal{C}' \in \mathfrak{X}(\mathcal{T})$ with $\mathcal{C}' \leq \mathcal{B}$ either $\mathcal{C} \rightarrow \mathcal{C}'$ or $\mathcal{C} \sim \mathcal{C}'$.*

Proof. Suppose that \mathcal{C}_1 is containment-minimal in \mathcal{B} and \mathcal{C}_2 is another collision with $\mathcal{C}_2 \leq \mathcal{B}$. If $\mathcal{C}_1 \sim \mathcal{C}_2$ there is nothing to prove. So suppose that there exists some nontrivial brackets $A_1 \in \mathcal{C}_1^k$ and $A_2 \in \mathcal{C}_2^k$ such that $A_1^k \cap A_2^k \neq \emptyset$. Then $A_1 \subseteq A_2$ as A_1 is containment-minimal in \mathcal{B} . Let $A'_1 \in \mathcal{C}_1^j$ be another nontrivial bracket and suppose $\pi^{n-j}(\mathcal{C}_2) \neq \pi^{n-j}(\mathcal{B}_{\min})$. We wish to prove that there exists some nontrivial $A'_2 \in \mathcal{C}_2^j$ such that $A'_1 \subseteq A'_2$. Because projection of brackets respects containment, we know that the fusion bracket for \mathcal{C}_1 weakly projects into the fusion bracket for \mathcal{C}_2 . There is some $i \geq 0$ such that $\pi^i(A'_1)$ is the fusion bracket of \mathcal{C}_1 . For an element $u \in (A'_1)^j$, repeated application of the (PARTITION) property applied to the fusion bracket for \mathcal{C}_2 gives some nontrivial bracket of $A'_2 \in \mathcal{C}_2^j$ such that $u \in (A'_2)^j$. The desired containment $A'_1 \subseteq A'_2$ then follows by containment-minimality of A'_1 .

Conversely, suppose that \mathcal{C}_1 satisfies the conditions of the lemma, but is not containment-minimal, then there exists some $A \in \mathcal{C}_1^k$ and some $A' \in \mathcal{B}$ such that

$A' \subsetneq A$. By Lemma 2.38, we know that there is some collision $\mathcal{C}_2 \leq \mathcal{B}$ such that $A' \in \mathcal{C}_2$, but then it is clear that $\mathcal{C}_1 \rightarrow \mathcal{C}_2$, a contradiction. \square

From the above argument that we have the following scholium.¹²

Scholium 2.57. Fix $\mathcal{B} \in \mathcal{K}(\mathcal{T})$ and $\mathcal{C} \in \mathfrak{X}(\mathcal{T})$. Let $\mathcal{C}_1, \dots, \mathcal{C}_k \in \mathfrak{X}(\mathcal{T})$ such that $\bigvee_{i=1}^k \mathcal{C}_i = \mathcal{B}$. Then \mathcal{C} is containment-minimal in \mathcal{B} if and only if the following conditions hold:

- (1) $\mathcal{C} \leq \mathcal{B}$.
- (2) for $1 \leq i \leq k$, either $\mathcal{C} \rightarrow \mathcal{C}_i$ or $\mathcal{C} \sim \mathcal{C}_i$.

Lemma 2.58. Let $\mathcal{B} \in \mathcal{K}(\mathcal{T})$. There exists a collision $\mathcal{C} \in \mathfrak{X}(\mathcal{T})$ such that \mathcal{C} is containment-minimal in \mathcal{B} .

Proof. If there exists a type 1 collision $\mathcal{C}' \leq \mathcal{B}$ with fusion bracket A , then there exists a type 1 collision \mathcal{C} with $\mathcal{C} \rightarrow \mathcal{C}'$ which is containment-minimal in \mathcal{B} . Therefore we may assume that there is no such \mathcal{C}' . Let $\overline{\mathcal{C}} \in \widehat{\mathfrak{X}}(\pi(\mathcal{T}))$ such that $\overline{\mathcal{C}}$ is containment-minimal in $\pi(\mathcal{B})$. We can lift $\overline{\mathcal{C}}$ to a collision $\mathcal{C} \in \mathfrak{X}(\mathcal{T})$, i.e. $\pi(\mathcal{C}) = \overline{\mathcal{C}}$ by defining the nontrivial n -brackets in \mathcal{C}^n to be the containment-minimal n -brackets in \mathcal{B}^n which project to some essential $(n-1)$ -bracket in $\overline{\mathcal{C}}^{n-1}$. By the assumption that there is no type 1 collision \mathcal{C}' with $\mathcal{C}' \leq \mathcal{B}$, it follows that the collision \mathcal{C} is containment-minimal in \mathcal{B} . \square

As a consequence of the previous argument we have the following scholium.

Scholium 2.59. For every $\mathcal{C}' \in \widehat{\mathfrak{X}}(\pi(\mathcal{T}))$ such that $\mathcal{C}' \leq \pi(\mathcal{B})$ there exists $\mathcal{C} \in \widehat{\mathfrak{X}}(\mathcal{T})$ with $\mathcal{C} \leq \mathcal{B}$ and $\pi(\mathcal{C}) = \mathcal{C}'$.

Lemma 2.60. For any $\mathcal{B}' \in \mathcal{K}(\pi(\mathcal{T}))$ there exists some $\mathcal{B} \in \mathcal{K}(\mathcal{T})$ such that $\pi(\mathcal{B}) = \mathcal{B}'$.

Proof. We can lift \mathcal{B}' to \mathcal{B} by taking \mathcal{B}^n to consist of the singleton n -brackets, the maximum n -bracket, and the following nontrivial n -brackets. For each $A' \in \mathcal{B}'$ and $u_i^n \in V^n(\mathcal{T})$ we construct an n -bracket A such that $\pi(A) = A'$ and $A^n = \{u_i^n\}$. Finally we take the height partial order on the n -brackets which is induced by the extended height partial order on singleton brackets, as in Lemma 2.16, which agrees with $<_{\mathcal{T}}$. \square

Lemma 2.61. Let $\mathcal{C} \in \widehat{\mathfrak{X}}(\mathcal{T})$ such that \mathcal{C} is not type 1, and let $\mathcal{B} \in \mathcal{K}(\mathcal{T})$ such that \mathcal{C} is containment-minimal in \mathcal{B} , then $\pi(\mathcal{C})$ is containment-minimal in $\pi(\mathcal{B})$.

Proof. This is a direct consequence of the definition of a containment-minimal collision. \square

¹²We use the word *scholium* to indicate a statement which follows as a consequence of a proof. This is in contrast to a corollary, which should be a consequence of a statement of a proposition. We have found this to be a useful term, and we hope the reader does not consider its application too pretentious.

Lemma 2.62. *Let $\mathcal{B} \in \mathcal{K}(\mathcal{T})$ and $\mathcal{C} \in \mathfrak{X}(\mathcal{T})$ with $\mathcal{C} \leq \mathcal{B}$. Let \mathcal{B}' obtained from \mathcal{B} by removing all nontrivial $A \in \mathcal{B}^k$ for which there exists no nontrivial $A' \in \mathcal{C}^k$ such that $A \subseteq A'$, and taking $\langle \mathcal{B}' \rangle$ to be the restriction of $\langle \mathcal{B} \rangle$. Then \mathcal{B}' is an n -bracketing.*

Proof. One can check that the (NESTED) and (PARTITION) properties are preserved for \mathcal{B}' . \square

Lemma 2.63. *If $\mathcal{C} \in \widehat{\mathfrak{X}}(\mathcal{T})$ and $\mathcal{B} \in \mathcal{K}(\mathcal{T})$ with $\mathcal{C} \leq \mathcal{B}$, then there exists some $\mathcal{C}' \in \widehat{\mathfrak{X}}(\mathcal{T})$ which is containment-minimal in \mathcal{B} such that $\mathcal{C}' \rightarrow \mathcal{C}$.*

Proof. By Lemma 2.62, the restriction of \mathcal{B} to \mathcal{C}' defines an n -bracketing and we can take \mathcal{C}' to be containment-minimal in this n -bracketing. \square

Definition 2.64. We say that $\mathcal{C} \in \mathfrak{X}(\mathcal{T})$ is a *minimal collision* if there exists no $\mathcal{C}' \in \mathfrak{X}(\mathcal{T})$ such that $\mathcal{C}' \rightarrow \mathcal{C}$. We say that $\mathcal{C} \in \widehat{\mathfrak{X}}(\mathcal{T})$ is a *minimal extended collision* if \mathcal{C} is a minimal collision or $\mathcal{C} = \mathcal{B}_{\min}$. \triangle

The following lemma characterizes minimal collisions.

Lemma 2.65. *Suppose that $\mathcal{C} \in \mathfrak{X}(\mathcal{T})$. Then \mathcal{C} is a minimal collision if and only if*

- *the fusion bracket A of \mathcal{C} is a k -bracket with $|A^k| = 2$ and*
- *for each $j > k$, every essential j -bracket in $\widetilde{A} \in \mathcal{C}^j$ has $|\widetilde{A}^j| = 1$.*

Moreover, if \mathcal{C} is not a minimal collision then there exists distinct $\mathcal{C}_1, \mathcal{C}_2 \in \widehat{\mathfrak{X}}(\mathcal{T})$ such that $\mathcal{C}_1 \rightarrow \mathcal{C}$ and $\mathcal{C}_2 \rightarrow \mathcal{C}$.

Proof. Suppose that $\mathcal{C} \in \widehat{\mathfrak{X}}(\mathcal{T})$ satisfies the conditions of Lemma 2.65. Suppose for contradiction that \mathcal{C} is not a minimal collision. Then there exists some $\widetilde{\mathcal{C}} \in \mathfrak{X}(\mathcal{T})$ with $\widetilde{\mathcal{C}} \neq \mathcal{C}$ such that $\widetilde{\mathcal{C}} \rightarrow \mathcal{C}$. We may assume without loss of generality that $\widetilde{\mathcal{C}}$ is a minimal collision. As $\widetilde{\mathcal{C}} \neq \mathcal{C}$ there must exist some essential i -bracket $\widetilde{A} \in \widetilde{\mathcal{C}}^i$ and a nontrivial i -bracket $A' \in \mathcal{C}$ such that $\widetilde{A} \subsetneq A'$, but this is clearly impossible. Conversely, let $\mathcal{C} \in \widehat{\mathfrak{X}}(\mathcal{T})$ be a minimal collision with fusion bracket A , and suppose for contradiction that the conditions of Lemma 2.65 are not satisfied. We can construct two collisions $\mathcal{C}_1, \mathcal{C}_2$ such that $\mathcal{C}_1 \rightarrow \mathcal{C}$, $\mathcal{C}_2 \rightarrow \mathcal{C}$. Moreover \mathcal{C}_1 and \mathcal{C}_2 will both satisfy the conditions of 2.65 and hence be minimal. There are two cases:

- $|A^k| \geq 3$ or
- there is some j -bracket in $\widetilde{A} \in \mathcal{C}$ with $j > k$, which is an essential bracket in \mathcal{C} and $|\widetilde{A}^j| \geq 2$.

In either case it is easy to find the desired extended collisions \mathcal{C}_1 and \mathcal{C}_2 (see Figure 14.) \square

For the following lemmas, recall Definition 2.49.

Lemma 2.66. *Let $\mathcal{C}, \mathcal{C}_1, \mathcal{C}_2 \in \mathfrak{X}(\mathcal{T})$ such that for each $i \in \{1, 2\}$ either $\mathcal{C} \rightarrow \mathcal{C}_i$ or $\mathcal{C} \sim \mathcal{C}_i$. Then $\mathcal{C}_1/\mathcal{C} \neq \mathcal{C}_2/\mathcal{C}$.*

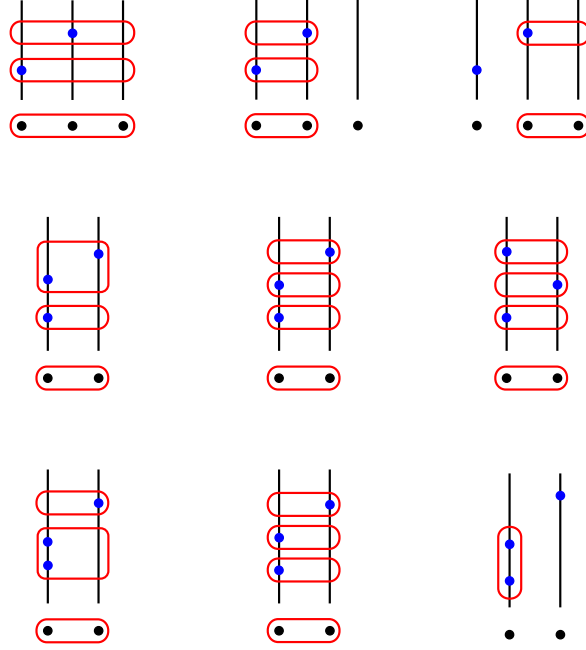

FIGURE 14. In each line, the collision on the left violates the conditions of a minimal collision described in Lemma 2.65, and the middle and right collisions in each row give a pair of minimal collisions \mathcal{C}_1 and \mathcal{C}_2 such that $\mathcal{C}_1 \rightarrow \mathcal{C}$ and $\mathcal{C}_2 \rightarrow \mathcal{C}$.

Proof. If $A \in \mathcal{C}_1^k$ and $A \notin \mathcal{C}_2^k$, then $A/\mathcal{C} \notin (\mathcal{C}_2/\mathcal{C})^k$. \square

Lemma 2.67. *Let $\mathcal{C} \in \widehat{\mathfrak{X}}(\mathcal{T})$, and let $\overline{\mathcal{C}} \in \widehat{\mathfrak{X}}(\mathcal{T}/\mathcal{C})$, then there is a unique preimage \mathcal{C}' of $\overline{\mathcal{C}}$ in $\widehat{\mathfrak{X}}(\mathcal{T})$ so that $\mathcal{C}'/\mathcal{C} = \overline{\mathcal{C}}$. Moreover, \mathcal{C}' is such that either $\mathcal{C} \rightarrow \mathcal{C}'$ or $\mathcal{C} \sim \mathcal{C}'$.*

Proof. For each k -bracket $A \in \mathcal{C}$, the image of A in \mathcal{T}/\mathcal{C} is a singleton bracket by definition. Given a k -bracket $A' \in \mathcal{T}/\mathcal{C}$, it has a well-defined preimage k -bracket in \mathcal{T} . We address two cases separately. In both cases \mathcal{C}' will be assumed to have all singleton and maximum brackets, as it must, and \mathcal{C}' will be equipped with a height partial order inherited from $\overline{\mathcal{C}}$. Let $A(u)$ be the image of the fusion bracket of \mathcal{C} in \mathcal{T}/\mathcal{C} . Let $A(u') \in \overline{\mathcal{C}}$ be the root bracket of $\overline{\mathcal{C}}$ in \mathcal{T}/\mathcal{C} .

The first case is where there does not exist some $i \geq 0$ such that $\pi^i(A(u')) = A(u)$. In this case we simply take the preimage of each nontrivial k -bracket in $\overline{\mathcal{C}}$. This produces \mathcal{C}' such that $\mathcal{C} \sim \mathcal{C}'$

The second case is that there does exist some $i \geq 0$ such that $\pi^i(A(u')) = A(u)$. We construct \mathcal{C}' by taking the collection of preimages of nontrivial k -brackets in $\overline{\mathcal{C}}$ together with the preimages of each singleton k -bracket $A(u'')$ in \mathcal{T}/\mathcal{C} such that $A(u'')$ is not contained in a nontrivial k -bracket in $\overline{\mathcal{C}}$, and for which there exists

some $j \geq 0$ such that $\pi^j(A(u'')) = A(u)$. This produces a collision $\mathcal{C}' \in \mathfrak{X}(\mathcal{T})$ such that $\mathcal{C} \rightarrow \mathcal{C}'$. Uniqueness follows from Lemma 2.66. \square

Lemma 2.68. *If $\mathcal{C}, \mathcal{C}' \in \mathfrak{X}(\mathcal{T})$, $\mathcal{C} \rightarrow \mathcal{C}'$, and $\mathcal{C}, \mathcal{C}'$ have different fusion brackets, then the quotient \mathcal{C}'/\mathcal{C} is a collision.*

Proof. We know that the quotient \mathcal{C}'/\mathcal{C} is an n -bracketing. To verify that it is a collision, we should check the two conditions of Lemma 2.32. That there are no nontrivial nested brackets is clear. Because the fusion bracket A for \mathcal{C}' properly contains the fusion bracket for \mathcal{C} , we can see that the image of A is the unique fusion bracket for \mathcal{C}' . \square

See Figure 15 above for an example demonstrating how the conclusion of the lemma can fail if the fusion bracket for \mathcal{C}' is equal to the fusion bracket for \mathcal{C} . The following Lemma refines the above observation.

Lemma 2.69. *Suppose that $\mathcal{C}, \mathcal{C}' \in \mathfrak{X}(\mathcal{T})$ and let $\mathcal{C} \rightarrow \mathcal{C}'$. Then $\overline{\mathcal{C}'}$, the image of \mathcal{C}' in $\mathcal{K}(\mathcal{T}/\mathcal{C})$, is an n -bracketing which is uniquely expressible as*

$$(17) \quad \overline{\mathcal{C}'} = \bigcup_{r=1}^t \mathcal{C}_r,$$

where $\mathcal{C}_r \in \mathfrak{X}(\mathcal{T}/\mathcal{C})$ with $1 \leq r \leq t$. Moreover, for $1 \leq r, s \leq t$ with $r \neq s$ we have that $\mathcal{C}_r \sim \mathcal{C}_s$.

Proof. Let A and A' be the fusion brackets for \mathcal{C} and \mathcal{C}' , respectively. If $A' \neq A$, then $\overline{\mathcal{C}'}$ is a collision as described above in Lemma 2.68. On the other hand, suppose that $A = A'$. Let $\{A_r : 1 \leq r \leq t\}$ be the set of essential brackets in \mathcal{C}' which properly contain some nontrivial bracket in \mathcal{C} , but $\pi(A_r)$ is equal to some bracket in \mathcal{C} . Let X_r be the set of essential brackets in \mathcal{C}' which project to A_r . Then the images of the X_r in \mathcal{T}/\mathcal{C} form the essential k -brackets of \mathcal{C}_r in the statement of the Lemma, and the images of the A_r are their fusion brackets. \square

Lemma 2.70. *Suppose that $\mathcal{C} \in \mathfrak{X}(\mathcal{T})$ and let $\{\mathcal{C}_r : 1 \leq r \leq t\} \subseteq \mathfrak{X}(\mathcal{T}/\mathcal{C})$ such that for $1 \leq r, s \leq t$ with $r \neq s$ we have that $\mathcal{C}_r \sim \mathcal{C}_s$, and the root vertex of \mathcal{C}_r weakly projects to the image of the fusion bracket of \mathcal{C} in \mathcal{T}/\mathcal{C} . Then there exists a unique collision $\mathcal{C}' \in \mathfrak{X}(\mathcal{T})$ such that $\mathcal{C} \rightarrow \mathcal{C}'$ and $\overline{\mathcal{C}'}$, the image of \mathcal{C}' in \mathcal{T}/\mathcal{C} decomposes as*

$$(18) \quad \overline{\mathcal{C}'} = \bigvee_{r=1}^t \mathcal{C}_r.$$

Proof. Let S be the collection of essential brackets which appear in some \mathcal{C}_r . Let T be the collection of singleton brackets in \mathcal{T}/\mathcal{C} which project to the image of the fusion bracket of \mathcal{C} , i.e. the singletons which are the images of the essential brackets in \mathcal{C} . We can construct \mathcal{C}' by taking, in addition to the necessary singleton and maximum brackets, the preimages of the brackets in S and the preimages of the singleton brackets in T which are not contained in any bracket in S . We take the

height partial order on these nontrivial brackets inherited from the height partial orders on \mathcal{C} and the $\{\mathcal{C}_r\}$. The resulting \mathcal{C}' is an n -bracketing which satisfies the desired conditions. Uniqueness follows from Lemma 2.66. \square

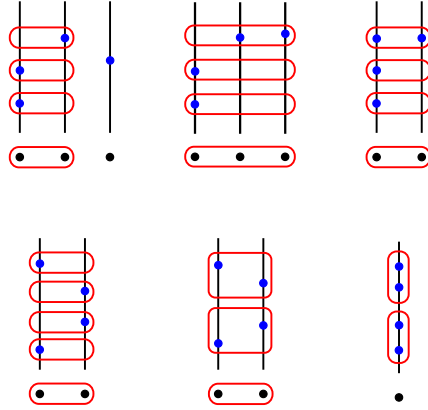

FIGURE 15. In each line, the first and second figures give a pair of collisions \mathcal{C} and \mathcal{C}' with $\mathcal{C} \rightarrow \mathcal{C}'$ and the third figure is the quotient \mathcal{C}'/\mathcal{C} . In the first line, the quotient is a collision, and the second line the quotient \mathcal{C}'/\mathcal{C} is the union of two disjoint collisions.

3. THE METRIC n -BRACKETING CONE COMPLEX

In this section, we begin by recalling the theory of cone complexes. We then introduce the collection of metric n -bracketings $\mathcal{K}^{\text{met}}(\mathcal{T})$, and prove that $\mathcal{K}^{\text{met}}(\mathcal{T})$ forms a cone complex whose face poset is $\mathcal{K}(\mathcal{T})$. The image of a finite cone complex under a globally injective piecewise-linear map to \mathbb{R}^m is a fan, and in §4 we apply this fact to demonstrate that the velocity fan is indeed a fan. In later sections, $\mathcal{K}^{\text{met}}(\mathcal{T})$ will continue to serve as our central tool for investigating the structure of the velocity fan.

3.1. Cone complexes and piecewise-linear transformations.

A cone complex is a generalization of a (rational) fan which arises naturally in the context of logarithmic geometry. Our presentation of cone complexes is slightly different from what others have given and is motivated by our applications as well as a desire to provide an elementary description of these objects which is accessible to researchers who may not be fluent in toric geometry. In Remark 3.10, we outline how our definition compares with definitions in the existing literature. We note that our definition of a cone complex suppresses ambient lattices and thus admits irrational fans as a special case.

We begin by introducing the notion of a conical set complex, which may be viewed as a “precone complex”. Recall that, informally, a monoid is a group without

inverses and a semiring is a ring without additive inverses. The reader may consult [Gol03] for precise definitions if they are unfamiliar with these notions.

Definition 3.1 (§7, [Gol03]). Suppose that R is a semiring. A (left) R -semimodule is an additively-written commutative monoid M with identity 0_M , together with a function $R \times M \rightarrow M$, $(r, m) \mapsto rm$, which is required to satisfy the following conditions for all $r, s \in R$ and $m, n \in M$:

- (1) $(rs)m = r(sm)$,
- (2) $r(m + n) = rm + rn$,
- (3) $(r + s)m = rm + sm$,
- (4) $1_R m = m$,
- (5) $r0_M = 0_M = 0_R m$. △

Definition 3.2. A *conical set* is a semimodule over $\mathbb{R}_{\geq 0}$. △

Definition 3.3. Let τ_1 be a conical set and $\tau_2 \subseteq \tau_1$. We say that τ_2 is a *conical subset* of τ_1 if τ_2 is a conical set and its $\mathbb{R}_{\geq 0}$ -semimodule structure is the restriction of the $\mathbb{R}_{\geq 0}$ -semimodule structure on τ_1 .

Definition 3.4. Given a conical set τ_1 , we define a *face* of τ_1 to be a conical subset $\tau_2 \subseteq \tau_1$ such that given any $\lambda \in \mathbb{R}_{> 0}$ and $x, y \in \tau_1$, the following implications hold:

- (1) $\lambda x \in \tau_2 \Rightarrow x \in \tau_2$,
- (2) $x + y \in \tau_2 \Rightarrow x, y \in \tau_2$. △

Definition 3.5. Let X be a set and \mathcal{F} be a collection of conical sets with $\tau \subseteq X$ for every $\tau \in \mathcal{F}$. We say that \mathcal{F} is a *conical set complex* if

- (1) For any $\tau_1 \in \mathcal{F}$ and for any conical set τ_2 which is a face of τ_1 , we have $\tau_2 \in \mathcal{F}$.
- (2) For any $\tau_1, \tau_2 \in \mathcal{F}$, $\tau_1 \cap \tau_2$ is a union of faces of both τ_1 and τ_2 . △

Definition 3.6. Let τ_1, τ_2 be conical sets and f be a map $f: \tau_1 \rightarrow \tau_2$, then f is *linear* if for every $\lambda \in \mathbb{R}_{\geq 0}$ and $x, y \in \tau_1$ we have

$$(19) \quad f(\lambda x) = \lambda f(x), \quad f(x + y) = f(x) + f(y).$$

A linear map f is an *isomorphism* if it is bijective. △

Definition 3.7. Let $\tau \subseteq \mathbb{R}^n$ be a conical set. We say that τ is a *closed polyhedral cone* if it is a conical set in \mathbb{R}^n which is closed and has finitely many faces. We say that τ is an *open polyhedral cone* if it is the relative interior of some closed polyhedral cone. △

When no confusion may arise, we will simply refer to a closed polyhedral cone as a *cone*.

Definition 3.8. An *abstract cone* is a conical set which admits a linear isomorphism to a closed polyhedral cone. △

Definition 3.9. A conical set complex \mathcal{F} is a *cone complex* if each conical set in \mathcal{F} is an abstract cone. △

Remark 3.10. There are some slight variations in the definition of a cone complex in the literature (see [KKMSD73, Kat94, AK00, Pay09, Uli17]). Often one defines a cone complex as a topological space and then acquires the algebraic structure via homeomorphisms to polyhedral cones. Instead we begin with the algebraic structure of a conical set complex and observe that the relevant topology on a cone complex can be acquired as the weak-* topology induced by the linear isomorphisms from the conical sets to polyhedral cones. Thus our definition essentially agrees with, for example, the one given in [Uli17]. Almost all other authors keep careful track of ambient lattices in their definition, which we have not done, and observe that this allows irrational fans as a special case (although all fans considered in this article are rational). We note that there are ambient lattices, often implicit, in our work, and all maps presented respect these lattice structures (see Corollary 5.40). Finally, we note that we do not insist that the conical sets or cones under consideration are pointed, i.e. strongly convex. Indeed, as is justified by Remark 4.5, we will work with cone complexes with lineality spaces. \triangle

Definition 3.11. Let X be a set and \mathcal{F} be a finite collection of abstract cones with $\tau \subseteq X$ for every $\tau \in \mathcal{F}$. We say that \mathcal{F} is an *abstract fan* if

- (1) For any $\tau_1 \in \mathcal{F}$ and for any conical set τ_2 which is a face of τ_1 , we have $\tau_2 \in \mathcal{F}$.
- (2) For any $\tau_1, \tau_2 \in \mathcal{F}$, $\tau_1 \cap \tau_2$ is a face of both τ_1 and τ_2 . \triangle

We emphasize that abstract fans are cone complexes where we have restricted to finite collections of conical sets and strengthened condition (2).¹³

Definition 3.12. A *fan* is an abstract fan whose ambient space is some Euclidean space \mathbb{R}^m . \triangle

Definition 3.13. Let \mathcal{F} be a conical set complex, then the *face poset* of \mathcal{F} is the partially ordered set $\mathcal{P}(\mathcal{F})$ whose elements are the conical sets belonging to \mathcal{F} , and for $\tau_1, \tau_2 \in \mathcal{F}$, $\tau_1 \leq \tau_2$ when τ_1 is a face of τ_2 . \triangle

Definition 3.14. Let \mathcal{F} be a conical set complex with ambient set X . We define the *support* of \mathcal{F} to be the set of points $\text{supp}(\mathcal{F}) = \{\mathbf{v} \in X : \exists \tau \in \mathcal{F}, \mathbf{v} \in \tau\}$. \triangle

Definition 3.15. Let \mathcal{F} be a fan in \mathbb{R}^m . We say that \mathcal{F} is *complete* if the support of \mathcal{F} is a linear space. \triangle

Typically, authors define a fan to be complete if its support is equal to all of \mathbb{R}^n , so this definition is a bit more general, but one can always project onto a coordinate subspace so that the support becomes all of a Euclidean space while preserving the face poset of the fan. Alternately, one can add the orthogonal complement of the support of \mathcal{F} as the lineality space. Our choice to work with a more general definition is only relevant in §7 on fiber products of fans. More precisely, for Corollary 7.14 to be true, we must use this more general definition of completeness for fans.

¹³The authors were tempted to define an abstract fan as a conical set complex satisfying conditions (1) and (2) of Definition 3.11, i.e. to not insist that abstract fans be cone complexes. Other researchers may be interested in considering such objects.

Lemma 3.16. *Let τ_1 be a conical set for which there exists $R = \{x_1, \dots, x_k\} \subseteq \tau_1$ such that $\tau_1 = \{\sum_{i=1}^k \lambda_i x_i : \lambda_i \in \mathbb{R}_{\geq 0}\}$. For τ_2 a face of τ_1 , there exists some $S \subseteq R$ such that $\tau_2 = \{\sum_{i=1}^k \lambda_i x_i : \lambda_i \in \mathbb{R}_{\geq 0}, x_i \in S\}$.*

Lemma 3.17. *Let τ_1 be an abstract cone and let τ_2 be a conical subset of τ_1 , then τ_2 is an abstract cone.*

Definition 3.18. Let \mathcal{F} be a conical set complex, and let \mathcal{G} be a collection of conical sets such that the elements of \mathcal{G} are subsets of a common ambient space Y . Let f be a collection of maps $\{f_\tau : \tau \in \mathcal{F}\}$ such that the domain of f_τ is τ and the codomain of f_τ is some $\tau' \in \mathcal{G}$. Then we say that f is *piecewise-linear* if each f_τ is linear on τ and for any two conical sets $\tau_1, \tau_2 \in \mathcal{F}$, we have

$$(20) \quad f_{\tau_1}|_{\tau_1 \cap \tau_2} = f_{\tau_2}|_{\tau_1 \cap \tau_2}.$$

Such an f is a *morphism* of conical set complexes. \triangle

The following notion is due to Gross [Gro18], and was motivated by the desire to develop tropical intersection theory for cone complexes.

Definition 3.19. Let \mathcal{F} be a cone complex and \mathcal{G} be a collection of cones in \mathbb{R}^n . Let $f : \mathcal{F} \rightarrow \mathcal{G}$ be a piecewise-linear map such that each f_τ with $\tau \in \mathcal{F}$ is a linear isomorphism. Then we say that the triple $(\mathcal{F}, \mathcal{G}, f)$ is a *weakly embedded cone complex* and \mathcal{F} is a *weakly embeddable cone complex*. \triangle

Note that in Definition 3.19, the cones in \mathcal{G} need not be internally disjoint.

Definition 3.20. Let \mathcal{F}_1 and \mathcal{F}_2 be conical set complexes and f be a piecewise-linear map from \mathcal{F}_1 to \mathcal{F}_2 . We say that f is a *piecewise-linear isomorphism* if there exists some piecewise-linear $g : \mathcal{F}_2 \rightarrow \mathcal{F}_1$ such that g is a two-sided inverse for f . \triangle

The proof of the following lemma is straightforward.

Lemma 3.21. *Let \mathcal{F} be an conical set complex with ambient set X , and let \mathcal{G} be a collection of conical sets with ambient set Y . Suppose that f is piecewise-linear function from \mathcal{F} to \mathcal{G} such that f induces a bijection from $\text{supp}(\mathcal{F})$ to $\text{supp}(\mathcal{G})$, and for each τ , the map f_τ is an isomorphism onto a conical set in \mathcal{G} . Then \mathcal{G} is a conical set complex, f is a piecewise-linear isomorphism, and $\mathcal{P}(\mathcal{F}) \cong \mathcal{P}(\mathcal{G})$.*

We now discuss subdivisions of conical set complexes.

Definition 3.22. Let τ be a conical set and \mathcal{F} be a conical set complex. We say that τ is *simplicial* if there exists no nontrivial relation

$$(21) \quad \sum_{x_i \in Y} \lambda_i x_i = \sum_{x_i \in Y} \gamma_i x_i,$$

for some finite set $Y \subseteq \tau$, and $\lambda_i, \gamma_i \geq 0$. We say that \mathcal{F} is *simplicial* if each conical set in \mathcal{F} is simplicial. \triangle

Definition 3.23. Let $\mathcal{F}_1, \mathcal{F}_2$ be conical set complexes living in a common ambient set X . We say that \mathcal{F}_2 is a *refinement* of \mathcal{F}_1 if $\text{supp}(\mathcal{F}_1) = \text{supp}(\mathcal{F}_2)$, and each conical set in \mathcal{F}_1 is a union of conical sets in \mathcal{F}_2 . We say that \mathcal{F}_2 is a *triangulation* of \mathcal{F}_1 if \mathcal{F}_2 is a refinement of \mathcal{F}_1 and each conical set in \mathcal{F}_2 is simplicial. \triangle

The following is immediate.

Lemma 3.24. Let \mathcal{F}_1 and \mathcal{G}_1 be conical set complexes and suppose that $f : \mathcal{F}_1 \rightarrow \mathcal{G}_1$ is a piecewise-linear isomorphism. Suppose that \mathcal{F}_2 is a conical set complex which refines \mathcal{F}_1 , then the image $f(\mathcal{F}_2)$ refines \mathcal{G}_1 .

Definition 3.25. Let τ be an abstract cone. We say that $V \subseteq \tau$ is a *vector subspace* if V is a conical subset of τ such that for each $x \in \tau$ there exists a $y \in \tau$ such that $x + y = 0_M$. For $x, y \in \tau$, let $x \sim_V y$ if $x = y + v$ for some $v \in V$. We define τ/V as the quotient of τ by the relation \sim_V . Suppose that \mathcal{F} is a cone complex living in an ambient space X . We say that $V \subseteq X$ is a *vector subspace of \mathcal{F}* if, for every conical set τ of \mathcal{F} , V is a vector subspace of τ . If V is a vector subspace of \mathcal{F} , we define the quotient $\mathcal{F}/V = \{\tau/V : \tau \in \mathcal{F}\}$. We define the *lineality space of \mathcal{F}* to be the maximum vector subspace of \mathcal{F} . If L is the lineality space of \mathcal{F} , we may denote \mathcal{F}/L by $\overline{\mathcal{F}}$. \triangle

Note that if V is a vector subspace of a conical set τ , then the semimodule structure of V over $\mathbb{R}_{\geq 0}$ extends to a module structure over \mathbb{R} , and τ/V is a conical set.

Lemma 3.26. Suppose that \mathcal{F} is a cone complex, and that V is a vector subspace of \mathcal{F} . Then the quotient \mathcal{F}/V is a cone complex, and $\mathcal{P}(\mathcal{F}/V) = \mathcal{P}(\mathcal{F})$.

Lemma 3.27. Suppose that $f : \mathcal{F} \rightarrow \mathcal{G}$ is a piecewise-linear isomorphism of cone complexes, then the induced map $\overline{f} : \overline{\mathcal{F}} \rightarrow \overline{\mathcal{G}}$ is piecewise-linear isomorphism of cone complexes.

Definition 3.28. If τ is a conical set whose lineality space is 0_M , we say that τ is *pointed*. If \mathcal{F} is a cone complex whose lineality space is 0_M , we say that \mathcal{F} is *pointed*. \triangle

Definition 3.29. Let σ be an abstract cone. We define $\langle \sigma \rangle_{\mathbb{R}} = \{x - y : x, y \in \sigma\}$ with $x - y := \{(x, y) \in \sigma \times \sigma\} / \sim$ where \sim is the equivalence relation $(x_1, y_1) \sim (x_2, y_2)$ if $x_1 + y_2 = x_2 + y_1$. \triangle

Definition 3.30. Suppose that \mathcal{F} is a cone complex, and $\sigma \in \mathcal{F}$. We define the *star of σ* to be $\text{star}(\sigma) = \{\tau \in \mathcal{F} : \sigma \subseteq \tau\}$. For $\tau \in \text{star}(\sigma)$, we define the *localization of τ at σ*

$$(22) \quad \tau_{\sigma} = \tau + \langle \sigma \rangle_{\mathbb{R}} := \{x - y \mid x \in \tau, y \in \sigma\},$$

with $x - y$ defined as in Definition 3.29. We then define *localization of \mathcal{F} at σ* to be the union of all of these conical sets

$$(23) \quad \mathcal{F}_{\sigma} := \{\tau_{\sigma} \mid \tau \in \text{star}(\sigma)\}.$$

\triangle

We will not immediately pass to $\mathcal{F}_\sigma/\langle\sigma\rangle_{\mathbb{R}}$ for reasons alluded to in Remark 4.5, which are manifested in Theorem 7.28.

Lemma 3.31. *Suppose that \mathcal{F} is a cone complex and $\sigma \in \mathcal{F}$, then \mathcal{F}_σ is a cone complex.*

Lemma 3.32. *Let \mathcal{F} and \mathcal{G} be cone complexes such that \mathcal{F} refines \mathcal{G} and both \mathcal{F} and \mathcal{G} have the same lineality space, then the quotient $\overline{\mathcal{F}}$ refines the quotient $\overline{\mathcal{G}}$.*

Definition 3.33. Let \mathcal{F} be a cone complex with lineality space V . We define a ray to be a face τ of \mathcal{F} for which there exists some $\rho \in \tau$ such that

$$(24) \quad \tau = \{\lambda\rho + V : \lambda \in \mathbb{R}_{\geq 0}\}.$$

If τ is a ray, we call any such ρ a *ray generator* for τ . △

Remark 3.34. Usually a ray of a cone τ or fan \mathcal{F} is defined to be a 1-dimensional face. The definition above is reasonable; if we project an abstract cone τ (or a cone complex \mathcal{F}) along its lineality space L , we obtain a pointed conical set (or cone complex), and the rays project to the one dimensional conical sets of the image. This will arise naturally in our setting as the metric n -bracketing complex and the velocity fan both have 1-dimensional lineality spaces. The velocity fan, like the braid arrangement, has a lineality space generated by the all-ones vector. Anticipating this construction we offer the following definition. △

Definition 3.35. We define *tropical projective space* to be the quotient vector space

$$(25) \quad \mathbb{T}^{m-1} = \mathbb{R}^m / \langle \mathbf{1} \rangle_{\mathbb{R}}.$$

△

For analyzing the local structure of fans and cone complexes we will need the following lemma.

Lemma 3.36. *Let \mathcal{F} be a cone complex with lineality space L , and let τ be a ray of \mathcal{F} . The rays of \mathcal{F}_τ are of the form $\tau' + \tau$, where τ' is a ray in \mathcal{F} and $\tau' + \tau \in \mathcal{F}$.*

3.2. Metric n -bracketings.

In [Bot21], the second author introduced a simplicial complex $W_{\mathbf{n}}^W$, which is composed of the *type- \mathbf{n} metric 2-bracketings* and is expected to be homeomorphic to the realization of $W_{\mathbf{n}}$ as a stratified topological space (see [Bot19b]). In this section, we introduce a generalization of a slight variation on the notion of a metric 2-bracketing. We abuse terminology and call our version by the same name.

Remark 3.37. The terminology “metric n -bracketings” is inspired by the second author’s notion of metric tree-pairs in [Bot21], which in turn was inspired by the metric rooted plane trees that appear in the Boardman–Vogt’s W -construction (see e.g. [MS06]). △

Remark 3.38. In symplectic geometry, a metric 2-bracketing can be thought of as a witch curve (in the sense of [Bot19b]), together with instructions on how much, and

whether, to smooth the nodes. One can think of a metric n -bracketing in a similar way. This is not of obvious relevance to symplectic geometry, but nevertheless it provides some geometric intuition. \triangle

Definition 3.39 (metric n -bracketings). For $n \geq 1$, and \mathcal{T} a rooted plane tree of depth n , a *metric n -bracketing* is a pair $(\mathcal{B}, \ell_{\mathcal{B}})$ consisting of an n -bracketing $\mathcal{B} \in \mathcal{K}(\mathcal{T})$ and a function $\ell_{\mathcal{B}}$ from the brackets of \mathcal{T} to \mathbb{R} satisfying the following requirements:

- (1) For any k -bracket A not in \mathcal{B}^k , we have $\ell_{\mathcal{B}}(A) = 0$.
- (2) For any singleton k -bracket $A(u) \in \mathcal{B}^k$, we have $\ell_{\mathcal{B}}(A(u)) = 0$.
- (3) For $A \in \mathcal{B}^k$ a nontrivial bracket, we have $\ell_{\mathcal{B}}(A) > 0$.
- (4) Fix a k -bracket \tilde{A} that is not a singleton. Fix $(k+1)$ -brackets $A, A' \in \mathcal{B}_{\tilde{A}}$ with A containment-maximal in $\mathcal{B}_{\tilde{A}}$ and A' containment-minimal in $\mathcal{B}_{\tilde{A}}$. We require that the following equality holds:

$$(26) \quad \ell_{\mathcal{B}}(\tilde{A}) = \sum_{\substack{A'' \in \mathcal{B}_{\tilde{A}}, \\ A' \subseteq A'' \subseteq A}} \ell_{\mathcal{B}}(A'').$$

When there is no ambiguity, we will abuse notation and denote a metric n -bracketing $(\mathcal{B}, \ell_{\mathcal{B}})$ by $\ell_{\mathcal{B}}$. By convention, we declare that there is a unique metric 0-bracketing consisting of the unique 0-bracketing and the function from this bracketing to 0. \triangle

Remark 3.40. Note that by the (NESTED) condition required for n -bracketings, the brackets A'' appearing in (26) form a chain. That is, for any two such brackets, one is contained in the other. \triangle

Definition 3.41. Fix a rooted plane tree \mathcal{T} and an n -bracketing $\mathcal{B} \in \mathcal{K}(\mathcal{T})$. We define $\tau^{\text{met}}(\mathcal{B})$ to be the set of all metric n -bracketings of the form $\ell_{\mathcal{B}'}$ with $\mathcal{B}' \leq \mathcal{B}$. \triangle

Lemma 3.42. For $\mathcal{B} \in \mathcal{K}(\mathcal{T})$, the set $\tau^{\text{met}}(\mathcal{B})$ is naturally equipped with the structure of a conical set.

Proof. We explain how the metric n -bracketings in $\tau^{\text{met}}(\mathcal{B})$ form an additive monoid with a multiplication by nonnegative real numbers making $\tau^{\text{met}}(\mathcal{B})$ an $\mathbb{R}_{\geq 0}$ semi-module, i.e. a conical set. Suppose that $(\mathcal{B}_1, \ell_{\mathcal{B}_1})$ and $(\mathcal{B}_2, \ell_{\mathcal{B}_2})$ are metric n -bracketings such that $\mathcal{B}_1, \mathcal{B}_2 \leq \mathcal{B}$, then we can define the metric n -bracketing

$$(27) \quad (\mathcal{B}_1, \ell_{\mathcal{B}_1}) + (\mathcal{B}_2, \ell_{\mathcal{B}_2}) := (\mathcal{B}_1 \vee \mathcal{B}_2, \ell_{\mathcal{B}_1} + \ell_{\mathcal{B}_2}).$$

Let $(\mathcal{B}, \ell_{\mathcal{B}})$ be a metric n -bracketing and t a nonnegative real, then $t(\mathcal{B}, \ell_{\mathcal{B}}) := (\mathcal{B}, t\ell_{\mathcal{B}})$ is a metric n -bracketing. \square

Definition 3.43. Let

$$(28) \quad X^{\text{met}}(\mathcal{T}) := \{(\mathcal{B}, \ell_{\mathcal{B}}) : \mathcal{B} \in \mathcal{K}(\mathcal{T})\}$$

The metric n -bracketing complex is

$$(29) \quad \mathcal{K}^{\text{met}}(\mathcal{T}) = \{\tau^{\text{met}}(\mathcal{B}) : \mathcal{B} \in \mathcal{K}(\mathcal{T})\}$$

in the ambient space $X^{\text{met}}(\mathcal{T})$. △

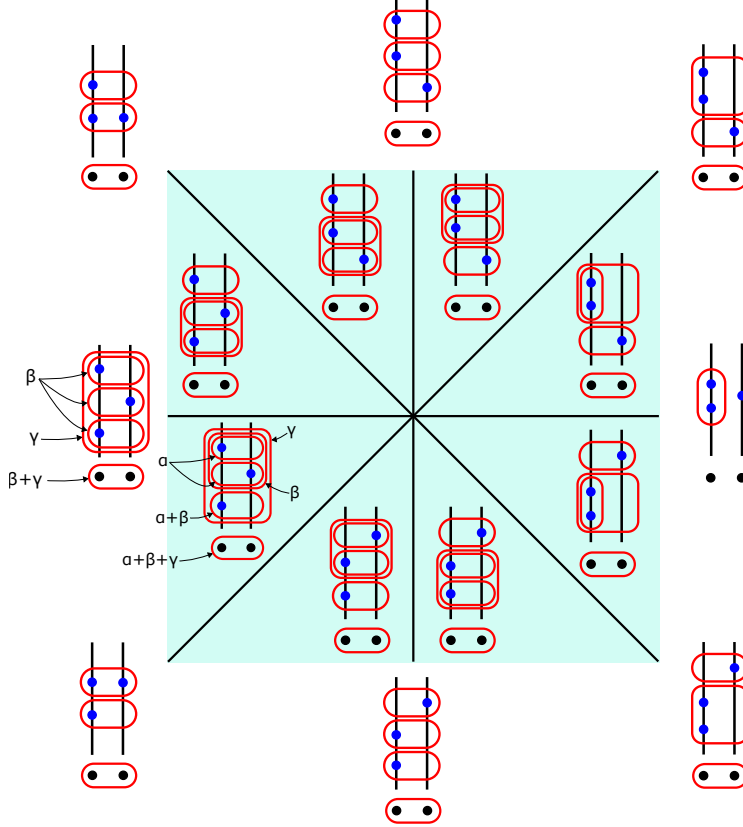

FIGURE 16. Here we depict the metric 2-bracketings of type $(2,1)$, which has 17 conical sets. For two of these conical sets, we indicate the numbers associated to the brackets and the relations they must satisfy. For the remaining 15 conical sets, we indicate only the underlying 2-bracketing. This figure should not be taken too literally as this metric n -bracketing complex is not embedded in \mathbb{R}^2 .

3.3. Metric n -bracketings as conical combinations of collisions.

There is a canonical map which associates a metric n -bracketing to each extended collision.

Definition-Proposition 3.44. Let $\mathcal{C} \in \widehat{\mathfrak{X}}(\mathcal{T})$. We define the associated metric n -bracketing

$$(30) \quad \ell_{\mathcal{C}}(A) := \begin{cases} 1 & \text{if } A \text{ is an essential bracket in } \mathcal{C}, \\ 0 & \text{otherwise.} \end{cases}$$

△

It is straightforward to verify that $\ell_{\mathcal{C}}$ is a metric n -bracketing. In the future we will typically denote $\ell_{\mathcal{C}}$ by $\ell(\mathcal{C})$. We now characterize the metric n -bracketings in $\tau^{\text{met}}(\mathcal{B})$.

Proposition 3.45. Let $\mathcal{B} \in \mathcal{K}(\mathcal{T})$ and let $\{\mathcal{C}_0, \mathcal{C}_1, \dots, \mathcal{C}_k\} \subseteq \widehat{\mathfrak{X}}(\mathcal{T})$ such that $\mathcal{C}_i \leq \mathcal{B}$, and let $\mathcal{C}_0 = \mathcal{B}_{\min}$. Then

$$(31) \quad \tau^{\text{met}}(\mathcal{B}) = \left\{ \sum_{i=0}^k \lambda_i \ell(\mathcal{C}_i) : \lambda_i \in \mathbb{R}, \text{ and } \lambda_i \geq 0 \text{ for } i \neq 0 \right\}.$$

Proof. It is clear that $\tau^{\text{met}}(\mathcal{B})$ contains the right hand side, so it remains to establish that $\tau^{\text{met}}(\mathcal{B})$ is contained in the right hand side. Fix a metric n -bracketing $(\mathcal{B}', \ell_{\mathcal{B}'}) \in \tau^{\text{met}}(\mathcal{B})$. We must show that there exist $\lambda_0 \dots, \lambda_k$ as in the statement of the lemma so that $\ell_{\mathcal{B}'} = \sum_{i=0}^k \lambda_i \ell(\mathcal{C}_i)$. We prove this by induction on the number of nontrivial brackets in \mathcal{B}' . For \mathcal{B}' a collision or the minimum bracketing, this is trivial. Next, suppose that \mathcal{B}' is neither a collision nor the minimum bracketing. Choose a collision $\mathcal{C} \leq \mathcal{B}'$. Set $t = \min \ell_{\mathcal{B}'}(A)$ taken over all nontrivial brackets in the support of $\ell_{\mathcal{C}}$. Then we claim that there is a metric n -bracketing $\ell_{\mathcal{B}''}$ with $\mathcal{B}'' < \mathcal{B}'$ such that $\ell_{\mathcal{B}''} + t \ell_{\mathcal{C}} = \ell_{\mathcal{B}'}$. While conical sets do not admit subtraction, it does make sense to subtract the functions $\ell_{\mathcal{B}'} - t \ell_{\mathcal{C}}$. We can check that this function does satisfy the conditions of Definition 3.39 (ignoring for a moment that the underlying object should be an n -bracketing). It is then straightforward to check that the support $\ell_{\mathcal{B}'} - t \ell_{\mathcal{C}}$ (together with the singleton and maximum brackets) determines a collection of brackets satisfying the conditions of an n -bracketing \mathcal{B}'' . The (PARTITION) condition follows as a consequence of the fact that property (4) from the definition of a metric n -bracketing is preserved. We can equip \mathcal{B}'' with the height partial order obtained by the restriction of the height partial order for \mathcal{B}' . □

Scholium 3.46. Define $\tau_{\mathbb{Z}}^{\text{met}}(\mathcal{B})$ to be the metric n -bracketings in $\tau^{\text{met}}(\mathcal{B})$ such that for each $A \in \mathcal{B}^k$, we have $\ell_{\mathcal{B}}(A) \in \mathbb{Z}$; these are the integer points of $\tau^{\text{met}}(\mathcal{B})$. It follows from the above argumentation that

$$(32) \quad \tau_{\mathbb{Z}}^{\text{met}}(\mathcal{B}) = \left\{ \sum_{i=0}^k \lambda_i \ell(\mathcal{C}_i) : \lambda_i \in \mathbb{Z}, \text{ and } \lambda_i \geq 0 \text{ for } i \neq 0 \right\}.$$

△

Scholium 3.46 is extended by Scholium 5.32 and Corollary 5.40, which provide a justification for our claim that while we ignore the standard lattice theoretic aspects of the definition of a cone complex, our cone complexes have implicit lattices and our maps respect these lattices.

We observe another useful scholium of the proof of Proposition 3.45.

Scholium 3.47. *Let $\ell_{\mathcal{B}}$ be a metric n -bracketing with $\mathcal{B} \neq \mathcal{B}_{\min}$. Let $\mathcal{C} \in \mathfrak{X}(\mathcal{T})$ with $\mathcal{C} \leq \mathcal{B}$ and set $t_0 = \min \ell_{\mathcal{B}}(A)$ taken over all nontrivial brackets in the support of $\ell_{\mathcal{C}}$. If $t \in \mathbb{R}_{\geq 0}$ with $t \leq t_0$, then $(\mathcal{B}, \ell_{\mathcal{B}}) - t(\mathcal{C}, \ell_{\mathcal{C}})$ is a metric n -bracketing, and if $t = t_0$, the support of this metric n -bracketing is strictly bounded above by the support of $\ell_{\mathcal{B}}$. \square*

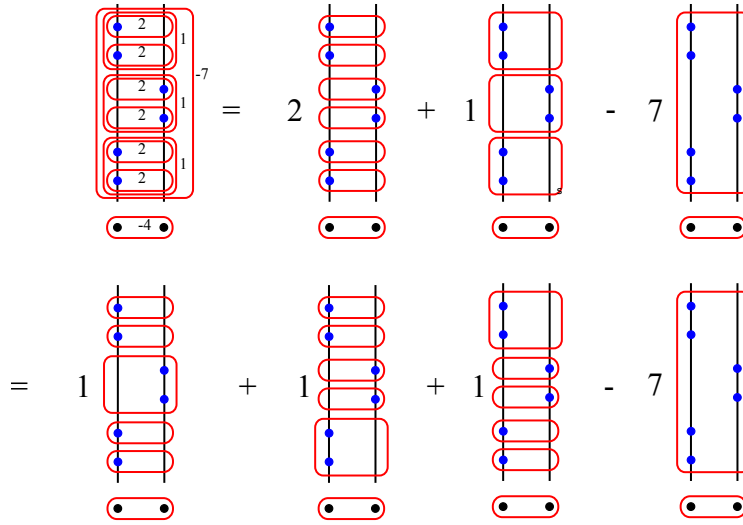

FIGURE 17. A metric n -bracketing and two different expressions for this metric n -bracketing as a conical combination of metric n -bracketings associated to collisions.

Lemma 3.48. *Let $\mathcal{B} \in \mathcal{K}(\mathcal{T})$ and $\ell_{\mathcal{B}} \in \mathcal{K}^{\text{met}}(\mathcal{T})$. Let $\mathcal{C}_0, \dots, \mathcal{C}_k \in \widehat{\mathfrak{X}}(\mathcal{T})$ with $\mathcal{C}_i \leq \mathcal{B}$ for all i , and $\mathcal{C}_0 = \mathcal{B}_{\min}$. Suppose that*

$$(33) \quad \ell_{\mathcal{B}} = \sum_{i=0}^k \lambda_i \ell(\mathcal{C}_i)$$

with $\lambda_i \in \mathbb{R}$ and $\lambda_i \geq 0$ for $i > 0$. Let A be a fusion bracket for \mathcal{B} . Let $\ell_{\mathcal{B}|_A}$ be the restriction of $\ell_{\mathcal{B}}$ to the brackets which weakly project to A , and extended by 0 elsewhere. Let $R(A) \subseteq \{\mathcal{C}_i : 0 \leq i \leq k\}$ be the subset of extended collisions which have A as their fusion bracket, then

$$(34) \quad \ell_{\mathcal{B}|_A} = \sum_{\mathcal{C}_i \in R(A)} \lambda_i \ell(\mathcal{C}_i).$$

In particular, $\ell_{\mathcal{B}|_A}$ is a metric n -bracketing.

Proof. First assume that A is nontrivial. Let $A' \in \mathcal{B}^k$ be a (necessarily nontrivial) bracket which weakly projects to A . Observe that for a particular i , we have $A' \in \mathcal{C}_i$ if and only if A is the fusion bracket for \mathcal{C}_i , i.e. $\mathcal{C}_i \in R(A)$. The statement when A is the maximum 1-bracket (the only possible trivial fusion bracket for a collision) and A' is some maximum k -bracket is similar. Note that in this case, $\mathcal{B}_{\min} \in R(A)$. \square

Lemma 3.49. *Let $\mathcal{B} \in \mathcal{K}(\mathcal{T})$ and let $U(\mathcal{B})$ be the collection of fusion brackets for \mathcal{B} . Let $\ell_{\mathcal{B}}$ be a metric n -bracketing, then*

$$(35) \quad \ell_{\mathcal{B}} = \sum_{A \in U(\mathcal{B})} \ell_{\mathcal{B}|_A}$$

Proof. This is a direct consequence of Proposition 3.45 and Lemma 3.48. \square

Lemma 3.50. *Let $\mathcal{B} \in \mathcal{K}(\mathcal{T})$ and let $\{\mathcal{C}_0, \mathcal{C}_1, \dots, \mathcal{C}_k\} \subseteq \widehat{\mathfrak{X}}(\mathcal{T})$ be the set of extended collisions such that $\mathcal{C}_i \leq \mathcal{B}$, and let $\mathcal{C}_0 = \mathcal{B}_{\min}$. Let $\lambda_i, \gamma_i \in \mathbb{R}$ with $\lambda_i, \gamma_i \geq 0$ if $i > 0$.*

Suppose that

$$(36) \quad \ell_{\mathcal{B}} = \sum_{i=0}^k \lambda_i \ell(\mathcal{C}_i) = \sum_{i=0}^k \gamma_i \ell(\mathcal{C}_i).$$

Then

$$(37) \quad \sum_{i=0}^k \lambda_i = \sum_{i=0}^k \gamma_i.$$

Proof. By Lemma 3.49, we can group the terms in both expressions for $\ell_{\mathcal{B}}$ according to the fusion brackets of the collisions, and each sum must agree. Therefore the verification of this lemma reduces to the case where \mathcal{B} has a single fusion bracket A . If A is an n -bracket then there is only a single (type 1) collision having A as its fusion bracket, and the statement is trivial. Otherwise, we can project the sums, i.e. replace each term $\ell(\mathcal{C})$ with $\ell(\pi(\mathcal{C}))$, and apply induction. \square

3.4. The metric n -bracketings form an abstract fan.

Lemma 3.51. *The metric n -bracketing complex $\mathcal{K}^{\text{met}}(\mathcal{T})$ is a conical set complex whose face poset is $\mathcal{K}(\mathcal{T})$.*

Proof. We must verify the conditions of Definition 3.5. For establishing condition (1), let $\mathcal{B} \in \mathcal{K}(\mathcal{T})$ and let τ be a face of $\tau^{\text{met}}(\mathcal{B})$. Let $\mathcal{C}_1, \dots, \mathcal{C}_k \in \widehat{\mathfrak{X}}(\mathcal{T})$ be the collisions such that $\ell(\mathcal{C}_i) \in \tau$ for all i . We claim that $\tau = \tau(\mathcal{B}')$ with $\mathcal{B}' = \vee_{i=1}^k \mathcal{C}_i$. As τ is a conical set, we know that $\tau(\mathcal{B}') \subseteq \tau$. On the other hand if $\ell_{\mathcal{B}''} \in \tau$ with $\mathcal{B}'' \not\leq \mathcal{B}'$, then by Lemma 3.45 there is an expression for $\ell_{\mathcal{B}''}$ as a conical combination of metric collisions. There must be some $\ell(\mathcal{C})$ in this expression with $\mathcal{C} \leq \mathcal{B}''$ such that $\mathcal{C} \not\leq \mathcal{B}'$. By Definition 3.4 for a face, $\ell(\mathcal{C}) \in \tau$ contradicting the assumption that $\mathcal{C} \neq \mathcal{C}_i$ for any i .

For verifying condition (2), we show the stronger statement that if $\tau^{\text{met}}(\mathcal{B}_1)$ and $\tau^{\text{met}}(\mathcal{B}_2)$ are elements of $\mathcal{K}^{\text{met}}(\mathcal{T})$, then $\tau^{\text{met}}(\mathcal{B}_1) \cap \tau^{\text{met}}(\mathcal{B}_2) = \tau^{\text{met}}(\mathcal{B}_1 \wedge \mathcal{B}_2)$. Both inclusions $\tau^{\text{met}}(\mathcal{B}_1 \wedge \mathcal{B}_2) \subseteq \tau^{\text{met}}(\mathcal{B}_1) \cap \tau^{\text{met}}(\mathcal{B}_2)$ and $\tau^{\text{met}}(\mathcal{B}_1) \cap \tau^{\text{met}}(\mathcal{B}_2) \subseteq \tau^{\text{met}}(\mathcal{B}_1 \wedge \mathcal{B}_2)$ are straightforward. The face poset of $\mathcal{K}^{\text{met}}(\mathcal{T})$ is $\mathcal{K}(\mathcal{T})$ by the definition of $\mathcal{K}^{\text{met}}(\mathcal{T})$. \square

Lemma 3.52. *The metric n -bracketing complex $\mathcal{K}^{\text{met}}(\mathcal{T})$ is a weakly embeddable cone complex.*

Proof. We define a piecewise-linear map $\eta : \mathcal{K}^{\text{met}}(\mathcal{T}) \rightarrow \mathbb{R}^w$, where w is the total number of nonsingleton brackets for \mathcal{T} , such that the image of each conical set is a cone. Send $\ell_{\mathcal{B}} \mapsto \mathbf{v}_{\ell_{\mathcal{B}}}$ where the coordinate of $\mathbf{v}_{\ell_{\mathcal{B}}}$ associated to the bracket A has entry $\ell_{\mathcal{B}}(A)$. It is clear that this map is piecewise-linear and nondegenerate on each $\tau^{\text{met}}(\mathcal{B})$. \square

Remark 3.53. The map η forgets the height partial order, thus it may not be globally injective, and the image of η may not be a fan. We note that image is a fan if $\mathcal{K}(\mathcal{T})$ is a concentrated n -associahedron. It is clear from considerations of dimension that this fan is not complete. For the associahedron, this provides a seemingly canonical fan realization which we are not aware of authors having explicitly considered previously, perhaps because it is incomplete. \triangle

Proposition 3.54. *The metric n -bracketing complex $\mathcal{K}^{\text{met}}(\mathcal{T})$ is an abstract fan whose face poset is $\mathcal{K}(\mathcal{T})$.*

Proof. This follows from combining Lemma 3.51 with Lemma 3.52. \square

Remark 3.55. Lemma 3.52 is not an ingredient in establishing Theorem 4.3; we only need Lemma 3.51. We have chosen to define an abstract fan as being a cone complex so that we may freely discuss quotients and localizations.

Definition 3.56. The *reduced metric n -bracketing complex* is the quotient

$$(38) \quad \overline{\mathcal{K}}^{\text{met}}(\mathcal{T}) := \mathcal{K}^{\text{met}}(\mathcal{T}) / \langle \ell_{\mathcal{B}_{\min}} \rangle.$$

\triangle

Definition 3.57. Fix a collision \mathcal{C} in an n -associahedron $\mathcal{K}(\mathcal{T})$. We define the \mathcal{C} -metric n -bracketing complex to be the localization $\mathcal{K}^{\text{met}}(\mathcal{T})_{\tau^{\text{met}}(\mathcal{C})}$, which we denote $\mathcal{K}^{\text{met}}(\mathcal{T})_{\mathcal{C}}$, and we define the \mathcal{C} -metric n -bracketings to be the elements of $\mathcal{K}^{\text{met}}(\mathcal{T})_{\mathcal{C}}$. \triangle

Lemma 3.58. *The \mathcal{C} -metric n -bracketings are naturally identified with pairs $(\mathcal{B}, \ell_{\mathcal{B}})$ for $\mathcal{C} \leq \mathcal{B}$ with $\ell_{\mathcal{B}}$ as described in Definition 3.39 with condition (4) relaxed to allow $\ell_{\mathcal{B}}(A) < 0$ if A is an essential bracket in \mathcal{C} .*

Proof. Let $(\mathcal{B}, \ell_{\mathcal{B}})$ be an \mathcal{C} -metric n -bracketing, then it is clear that $\ell_{\mathcal{B}}$ is a function as described in Definition 3.39 with the prescribed relaxation of condition (4) because we have subtracted some multiple of $\ell_{\mathcal{C}}$ from a metric n -bracketing. Conversely, suppose that $\ell_{\mathcal{B}}$ is a function as described in Definition 3.39 with the prescribed

relaxation of condition (4). Then we can add $\lambda \ell(\mathcal{C})$ for $\lambda > 0$ large enough to obtain the new function $\ell'_{\mathcal{B}}$ which is a metric n -bracketing. It follows that $\ell'_{\mathcal{B}} \in \tau^{\text{met}}(\mathcal{B})$ and thus $\ell_{\mathcal{B}}$ is a \mathcal{C} -metric n -bracketing. \square

4. THE VELOCITY FAN

In this section we will introduce a collection of polyhedral cones called the *velocity fan* associated to an n -associahedron. We establish Theorem 4.3, the main result of this paper: the velocity fan associated to $\mathcal{K}(\mathcal{T})$ is a complete polyhedral fan whose face poset is $\mathcal{K}(\mathcal{T})$.

4.1. Definition of the velocity fan.

We are now ready to define the velocity fan associated to a categorical n -associahedron. Our formal definition is given using the input of a rooted plane tree. Afterward, we will explain how the velocity fan can be understood very naturally via relative velocities of colliding affine coordinate spaces. We emphasize that, despite its name, it is not at all clear that the velocity fan is in fact a fan, this is the content of Theorem 4.15.

Let \mathcal{T} be a rooted plane tree of depth $n \geq 1$ with $\mathcal{K}(\mathcal{T})$ the corresponding n -associahedron. We begin by recalling that there is a natural linear order $<_{\mathcal{T}}$ on $V^k(\mathcal{T})$ induced by the rooted plane structure of \mathcal{T} (see Definitions 2.2 and 2.3). We define the function $d_{\mathcal{T},k} : V^k(\mathcal{T}) \rightarrow \mathbb{N}$ where for $u \in V^k(\mathcal{T})$, we have that u is the $d_{\mathcal{T},k}(u)$ -th vertex in $V^k(\mathcal{T})$ with respect to $<_{\mathcal{T}}$ so that $d_{\mathcal{T},k}(u_i^k) = i$. We simply write $d_{\mathcal{T}}$ for $d_{\mathcal{T},k}$ if k is clear from the context. Let $m = |V(\mathcal{T})| - n$, and for $1 \leq k \leq n$ set $t_k = |V^k(\mathcal{T})| - 1$.¹⁴ Given $\mathbf{v} \in \mathbb{R}^m$, we denote its coordinates as

$$(39) \quad \mathbf{v} = (v_1^1, \dots, v_{t_1}^1, \dots, v_1^n, \dots, v_{t_n}^n).$$

For defining the velocity fan, we first introduce a distinguished collection of ray generators associated to the collisions in $\mathcal{K}(\mathcal{T})$. Given $\mathcal{C} \in \mathfrak{X}(\mathcal{T})$, let

$$(40) \quad \psi_{\mathcal{T}/\mathcal{C}}^{\mathcal{T}} : V(\mathcal{T}) \rightarrow V(\mathcal{T}/\mathcal{C})$$

be the associated collision map as described in Definition 2.43, Propositions 2.45 and 2.46. We may write $\psi_{\mathcal{T}/\mathcal{C}}$ if \mathcal{T} is clear from the context, or simply ψ if both \mathcal{T} and \mathcal{T}/\mathcal{C} are clear from the context. We define a ray generator $\rho(\mathcal{C}) \in \mathbb{R}^m$ having entries

$$(41) \quad \rho(\mathcal{C})_i^k = d_{\mathcal{T}/\mathcal{C}}(\psi(u_i^k)) - d_{\mathcal{T}/\mathcal{C}}(\psi(u_{i+1}^k)) + 1.$$

Furthermore, we define

$$(42) \quad \rho(\mathcal{B}_{\min}) = \mathbf{1},$$

where $\mathbf{1}$ is the all-ones vector. Given $\mathcal{B} \in \mathcal{K}(\mathcal{T})$, we define the corresponding cone

$$(43) \quad \tau(\mathcal{B}) = \left\{ \sum_{\mathcal{C} \leq \mathcal{B}} \lambda_{\mathcal{C}} \rho(\mathcal{C}) + \lambda \rho(\mathcal{B}_{\min}) : \mathcal{C} \in \mathfrak{X}(\mathcal{T}), \lambda_{\mathcal{C}} \in \mathbb{R}_{\geq 0}, \lambda \in \mathbb{R} \right\}.$$

¹⁴We note that our construction ignores each vertex in \mathcal{T} which is the unique vertex at its depth.

For $n = 0$ and \mathcal{B}_{\min} the unique 0-bracketing, we define $\tau(\mathcal{B}_{\min}) = \mathbb{R}^0$.

Definition 4.1. Given a rooted plane tree \mathcal{T} of depth $n \geq 0$, we define the *velocity fan* to be the collection of polyhedral cones

$$(44) \quad \mathcal{F}(\mathcal{T}) = \{\tau(\mathcal{B}) : \mathcal{B} \in \mathcal{K}(\mathcal{T})\}.$$

△

Remark 4.2. Observe that that $\tau(\mathcal{B}_{\min}) = \langle \mathbf{1} \rangle_{\mathbb{R}}$. Once $\mathcal{F}(\mathcal{T})$ has been shown to be fan, it follows immediately that the lineality space of $\mathcal{F}(\mathcal{T})$ is $\langle \mathbf{1} \rangle_{\mathbb{R}}$. Additionally, observe that

$$(45) \quad \tau(\mathcal{C}) = \{\lambda\rho(\mathcal{C}) + \gamma\rho(\mathcal{B}_{\min}) : \lambda, \gamma \in \mathbb{R}, \lambda \geq 0\}.$$

△

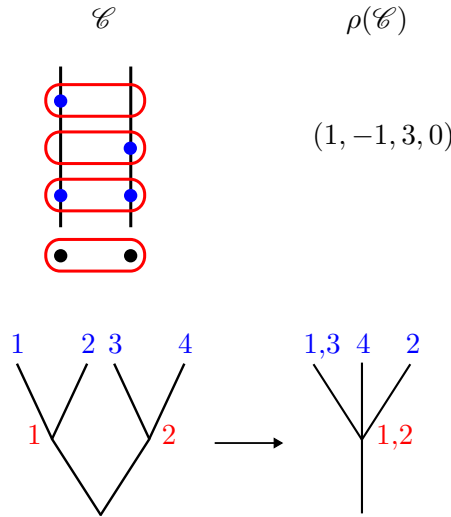

FIGURE 18. A collision \mathcal{C} and the corresponding ray $\rho(\mathcal{C})$.

The following is the main result of this paper.

Theorem 4.3. *The velocity fan $\mathcal{F}(\mathcal{T})$ is a complete fan whose face poset is $\mathcal{K}(\mathcal{T})$.*

Proof. We will establish Theorem 4.3 as a combination of two results: Theorem 4.15 (the velocity fan is a fan) and Theorem 4.43 (the velocity fan is complete). Theorem 4.15 will follow as a direct consequence of Proposition 4.13 (the velocity fan is piecewise-linearly isomorphic to the metric n -bracketing complex $\mathcal{K}^{\text{met}}(\mathcal{T})$), combined with Lemma 3.21 (The bijective piecewise-linear image of conical set complex is a conical set complex with the same face poset) and Lemma 3.51 ($\mathcal{K}^{\text{met}}(\mathcal{T})$ is a conical set complex with face poset $\mathcal{K}(\mathcal{T})$). □

Thus Theorem 4.3 reduces to verifying Proposition 4.13 and Theorem 4.43.

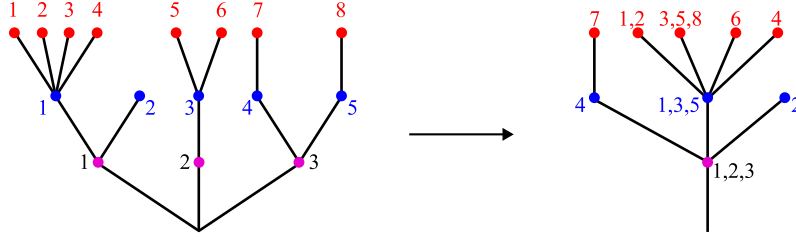

$$\rho(\mathcal{C}) = (1, 1, 0, 2, 2, 0, 1, 0, -1, 3, 0, 4, -2)$$

FIGURE 19. The collision (map) from Figures 12 and 13, and the corresponding ray generator.

Definition 4.4. We define the *reduced velocity fan* to be the image of the velocity fan in tropical projective space

$$(46) \quad \overline{\mathcal{F}}(\mathcal{T}) = \{\tau(\mathcal{B})/\langle \mathbf{1} \rangle_{\mathbb{R}} : \mathcal{B} \in \mathcal{K}(\mathcal{T})\}.$$

△

Remark 4.5. As noted above, the velocity fan has lineality space $\langle \mathbf{1} \rangle_{\mathbb{R}}$, hence it will follow as an immediate consequence of Theorem 4.3 that the reduced velocity fan is a pointed complete polyhedral fan. Experts will note that the relationship between these two fans is a common and sometimes subtle distinction which arises in the literature on tropical geometry and generalized permutahedra. Our choice to work with the velocity fan for much of the paper, rather than the reduced velocity fan, is due to two considerations. The first, more superficial, reason is that some arguments are quite technical and we find it easier to work with explicit coordinates. The second, more substantive, reason is that we will be interested in acting on subsets of the velocity fan by certain linear transformations (the adjoint permutation transformations P_{σ}^T) which do not have $\mathbf{1}$ as an eigenvector, and we currently do not have a satisfactory way of discussing such maps in tropical projective space (see subsection 4.3). We feel that this second reason highlights a deeper aspect of our construction. △

For considering the following proposition, we invite the reader to revisit Subsection 1.2.

Proposition 4.6. *The velocity fan of a categorical 1-associahedron, i.e. an associahedron, is the wonderful associahedral fan, i.e. the normal fan of Loday’s polytopal realization of the associahedron.*

Proof. By Theorem 1.15, know that the wonderful associahedral fan $\mathcal{F}(\mathcal{K}_n)$ has face poset given by the associahedron \mathcal{K}_n , and $\langle \mathbf{1} \rangle_{\mathbb{R}}$ as its lineality space. Thus for verifying this statement it suffices, by the definition of the velocity fan, to observe that

our ray generators specialize to the standard 0-1 ray generators for the wonderful associahedral fan. \square

Remark 4.7. In our definition of the ray generator associated to a collision,

$$(47) \quad \rho(\mathcal{C})_i^k = d_{\mathcal{T}/\mathcal{C}}(\psi(u_i^k)) - d_{\mathcal{T}/\mathcal{C}}(\psi(u_{i+1}^k)) + 1,$$

the 1 added at the end can be removed and this does not change the definition of the velocity fan. This is because $\mathbf{1}$ is in the lineality space of each cone and thus we could replace each ray generator with $\rho(\mathcal{C}) - \mathbf{1}$. We have chosen not to do this for two reasons. The first is that in Proposition 4.6, our choice of $\rho(\mathcal{C})$ specializes to the standard 0-1 ray generators for the wonderful associahedral fan. More generally, as will be seen in §8, our velocity fan specializes to certain coarsenings of the braid arrangement where our choice of ray generators agrees with the standard 0-1 ray generators for the braid arrangement. The second reason, explained in the following Remark 4.8, is that there is a natural way of understanding our ray generators in terms of relative velocities of colliding affine coordinate spaces and our choice to leave the 1 is made to agree with this framework. This all being said, there are some results for which $\rho(\mathcal{C}) - \mathbf{1}$ appears to be slightly nicer to work with, e.g. Lemma 4.31. \triangle

Remark 4.8. The reason the velocity fan is called the velocity fan.

Take $u \in V(\mathcal{T})$ and let $\mathbf{v}(u)$ be the vector encoding u (see Definition 2.3 and Figure 2.10). We define a geometric arrangement of affine coordinate spaces. Let $L(u) \subseteq \mathbb{R}^n$ be the affine coordinate space cut out by the equations $x_i = \mathbf{v}(u)_i$. We define the arrangement $Y_{\mathcal{T}} = \{L(u) : u \in V(\mathcal{T})\}$. Let $\mathcal{C} \in \mathfrak{X}(\mathcal{T})$. Imagine the arrangement $Y_{\mathcal{T}}$ moving to the arrangement $Y_{\mathcal{T}/\mathcal{C}}$ over a single unit of time, then $\rho(\mathcal{C})_i^k$ is equal to the relative velocity of $L(u_i^k)$ and $L(u_{i+1}^k)$ in the direction x_k . See Figure 20. \triangle

We conclude this subsection with some fundamental lemmas for the velocity fan. Let

$$(48) \quad \mathbf{v} = (v_1^1, \dots, v_{t_1}^1, \dots, v_1^n, \dots, v_{t_n}^n) \in \mathbb{R}^m$$

and take

$$(49) \quad \Delta_{j,k}^n(\mathbf{v}) := \sum_{h=j}^{k-1} v_h^n.$$

Lemma 4.9. *Let $\mathcal{C}, \mathcal{C}' \in \widehat{\mathfrak{X}}(\mathcal{T})$ and $1 \leq j < k \leq t_n$, then*

- $\Delta_{j,k}^n(\rho(\mathcal{C})) = k - j$ if and only if $u_j^n, u_k^n \in A$ for some essential $A \in \mathcal{C}^n$,
- $\Delta_{j,k}^n(\rho(\mathcal{C})) > k - j$ if and only if $A(u_k^n) \widehat{<}_{\mathcal{C}} A(u_j^n)$,¹⁵
- $\Delta_{j,k}^n(\rho(\mathcal{C})) = 0$ if u_j^n, u_k^n are not descended from the root vertex of \mathcal{C} .

¹⁵Recall here, $\widehat{<}_{\mathcal{C}}$ is the extended height partial order for \mathcal{C} .

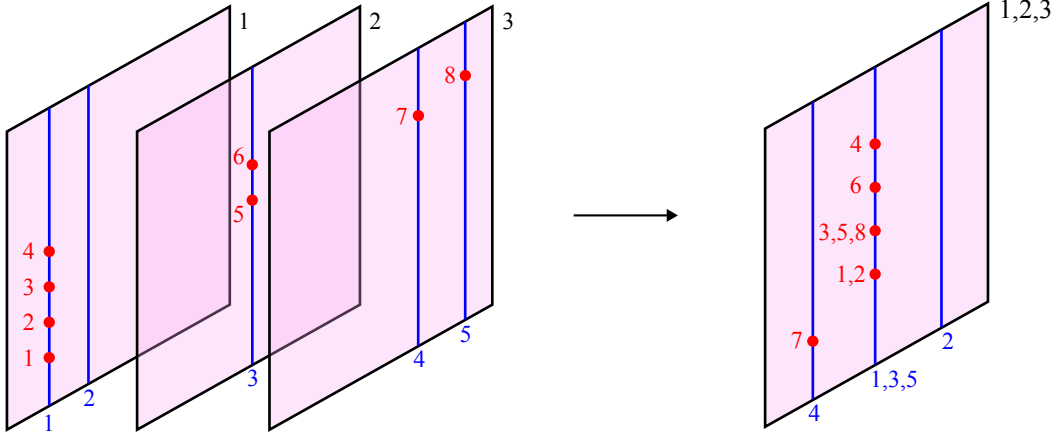

FIGURE 20. A collision in a tree arrangement of spaces previously depicted in Figures 12 and 13. The ray generator $\rho(\mathcal{C})$ from Figure 19 agrees with the relative velocities of the consecutive spaces as described in Remark 4.8.

Proof. We calculate that

$$\begin{aligned}
 (50) \quad & \Delta_{j,k}^n(\rho(\mathcal{C})) \\
 &= \sum_{i=j}^{k-1} d_{\mathcal{T}/\mathcal{C}}(\psi(u_i^n)) - d_{\mathcal{T}/\mathcal{C}}(\psi(u_{i+1}^n)) + 1 \\
 &= d_{\mathcal{T}/\mathcal{C}}(\psi(u_j^n)) - d_{\mathcal{T}/\mathcal{C}}(\psi(u_k^n)) + (k - j).
 \end{aligned}$$

Thus $\Delta_{j,k}^n(\rho(\mathcal{C})) = k - j$ if and only if $d_{\mathcal{T}/\mathcal{C}}(\psi(u_j^n)) = d_{\mathcal{T}/\mathcal{C}}(\psi(u_k^n))$, and $\Delta_{j,k}^n(\rho(\mathcal{C})) > k - j$ if and only if $d_{\mathcal{T}/\mathcal{C}}(\psi(u_k^n)) < d_{\mathcal{T}/\mathcal{C}}(\psi(u_j^n))$, which occurs if and only if $A(u_k^n) \widehat{<}_{\mathcal{C}} A(u_j^n)$ in the extended height partial order for \mathcal{C} . Finally if u_j^n, u_k^n are not descended from the root vertex of \mathcal{C} , then $d_{\mathcal{T}/\mathcal{C}}(\psi(u_j^n)) - d_{\mathcal{T}/\mathcal{C}}(\psi(u_k^n)) = j - k$. \square

As remarked previously, we will use the notation π to indicate several different projection maps. Given a rooted plane tree \mathcal{T} of depth n , we let $\pi(\mathcal{T})$ be the rooted plane tree obtained from \mathcal{T} by deleting the vertices $V^n(\mathcal{T})$. Let $\pi(\mathcal{K}(\mathcal{T}))$ be the $(n - 1)$ -associahedron $\mathcal{K}(\pi(\mathcal{T}))$. Given a point $\mathbf{v} = (v_1^1, \dots, v_{t_1}^1, \dots, v_1^n, \dots, v_{t_n}^n)$, we let $\pi(\mathbf{v}) = (v_1^1, \dots, v_{t_1}^1, \dots, v_1^{n-1}, \dots, v_{t_{n-1}}^{n-1})$. Given $Y \subseteq \mathbb{R}^n$ we set $\pi(Y) = \{\pi \mathbf{v} : \mathbf{v} \in Y\}$. Given a family \mathcal{F} of subsets of \mathbb{R}^n , we define the projection $\pi(\mathcal{F}) = \{\pi(\tau) : \tau \in \mathcal{F}\}$.

Lemma 4.10. *Suppose that $\mathcal{C} \in \widehat{\mathfrak{X}}(\mathcal{T})$.*

- If \mathcal{C} is type 2 or 3, then $\pi(\rho(\mathcal{C})) = \rho(\pi(\mathcal{C}))$.
- If \mathcal{C} is type 1, then $\pi(\rho(\mathcal{C})) = \mathbf{0}$ while $\rho(\pi(\mathcal{C})) = \mathbf{1}$.

In particular, if $\{\mathcal{C}_i : 1 \leq i \leq k\} \subseteq \widehat{\mathfrak{X}}(\mathcal{T})$ is a collection of compatible extended collisions which are all not type 1, and $\mathbf{v} = \sum_{i=1}^k \lambda_i \rho(\mathcal{C}_i)$ with $\lambda_i \in \mathbb{R}$ for $1 \leq i \leq k$, then $\pi(\mathbf{v}) = \sum_{i=1}^k \lambda_i \rho(\pi(\mathcal{C}_i))$.

Proof. This is clear from the definition of $\rho(\mathcal{C})$. \square

Proposition 4.11. *For any rooted plane tree \mathcal{T} , we have $\pi(\mathcal{F}(\mathcal{T})) = \mathcal{F}(\pi(\mathcal{T}))$.*

Proof. By definition

$$(51) \quad \pi(\mathcal{F}(\mathcal{T})) = \{\pi(\tau(\mathcal{B})) : \mathcal{B} \in \mathcal{K}(\mathcal{T})\},$$

and

$$(52) \quad \mathcal{F}(\pi(\mathcal{T})) = \{\tau(\mathcal{B}) : \mathcal{B} \in \mathcal{K}(\pi(\mathcal{T}))\}.$$

Let $\mathcal{B} \in \mathcal{K}(\mathcal{T})$, then $\pi(\mathcal{B}) \in \mathcal{K}(\pi(\mathcal{T}))$. Applying Lemma 4.10, we observe that for any $\mathcal{C} \in \widehat{\mathfrak{X}}(\mathcal{T})$ with $\mathcal{C} \leq \mathcal{B}$

- if \mathcal{C} is type 1, then $\pi(\rho(\mathcal{C})) = \mathbf{0}$
- if \mathcal{C} is type 2, then $\pi(\rho(\mathcal{C}))$ is a ray generator for $\tau(\pi(\mathcal{B}))$, and
- if \mathcal{C} is type 3, then $\pi(\rho(\mathcal{C})) = \mathbf{1}$ lies in the lineality space of $\tau(\pi(\mathcal{B}))$.

By Scholium 2.59, for every \mathcal{C} an extended collision with $\mathcal{C} \leq \pi(\mathcal{B})$ there exists some extended collision $\mathcal{C}' \leq \mathcal{B}$ such that $\pi(\mathcal{C}') = \mathcal{C}$. So, the ray and lineality space generators of $\tau(\mathcal{B})$ surject onto the ray and lineality space generators for $\tau(\pi(\mathcal{B}))$. By linearity of the projection map, $\pi(\tau(\mathcal{B})) = \tau(\pi(\mathcal{B}))$. Moreover, by Lemma 2.60, for any $\mathcal{B} \in \mathcal{K}(\pi(\mathcal{T}))$ there exists some $\mathcal{B}' \in \mathcal{K}(\mathcal{T})$ such that $\pi(\mathcal{B}') = \mathcal{B}$, and the desired statement follows. \square

4.2. Metric n -bracketings and the velocity fan.

Our proof that the velocity fan $\mathcal{F}(\mathcal{T})$ associated to an n -associahedron $\mathcal{K}(\mathcal{T})$ is a fan will proceed by induction on n . Thus we will assume in what follows that every statement being proven for n -associahedra holds for all $(n-1)$ -associahedra. The base case of this induction is when $n=0$ and the only 0-associahedron is the singleton poset with velocity fan a point.¹⁶

Definition 4.12. We define a map $\Gamma : \mathcal{K}^{\text{met}}(\mathcal{T}) \rightarrow \mathcal{F}(\mathcal{T})$. Let $\mathcal{C}_0, \dots, \mathcal{C}_k$ be extended collisions with $\mathcal{C}_0 = \mathcal{B}_{\min}$ such that $\mathcal{C}_i \leq \mathcal{B}$ for all i . Let $\lambda_i \in \mathbb{R}$ with $\lambda_i \geq 0$ for $i > 0$. Given a metric n -bracketing $\ell_{\mathcal{B}}$ such that $\ell_{\mathcal{B}} = \sum_{i=0}^k \lambda_i \ell(\mathcal{C}_i)$, we define

$$(53) \quad \Gamma(\ell_{\mathcal{B}}) := \sum_{i=0}^k \lambda_i \rho(\mathcal{C}_i).$$

\triangle

Equivalently, for $\mathcal{C} \in \widehat{\mathfrak{X}}(\mathcal{T})$, take $\Gamma(\ell(\mathcal{C})) = \rho(\mathcal{C})$, then Γ is obtained by extending this map conically on the conical sets in $\mathcal{K}^{\text{met}}(\mathcal{T})$.

¹⁶The base case $n=0$ was chosen for aesthetic reasons: we would prefer to recover the special case of $n=1$ from our construction and arguments rather than build on it.

Proposition 4.13. *The map Γ is a piecewise-linear isomorphism.*

Remark 4.14. Because the velocity fan is typically nonsimplicial, the fact that Γ is an isomorphism when restricted to a single conical set in \mathcal{K}^{met} is already a nontrivial statement. \triangle

Theorem 4.15. *Given a rooted plane tree \mathcal{T} , the velocity fan $\mathcal{F}(\mathcal{T})$ is a fan whose face poset is $\mathcal{K}(\mathcal{T})$.*

Proof. Combine Lemma 3.21, Lemma 3.51, and Proposition 4.13. \square

Thus for proving Theorem 4.15, it suffices to establish Proposition 4.13. Proposition 4.13 is a direct consequence of the following lemma.

Lemma 4.16. *Let \mathcal{B} and \mathcal{B}' be n -bracketings in $\mathcal{K}(\mathcal{T})$. Let $\mathcal{C}_1, \dots, \mathcal{C}_k$ and $\mathcal{C}'_1 \dots \mathcal{C}'_l$ be collisions less than \mathcal{B} and \mathcal{B}' , respectively. Let $\mathcal{C}_0 = \mathcal{C}'_0 = \mathcal{B}_{\text{min}}$. There exist $\lambda_i, \gamma_i \in \mathbb{R}_{\geq 0}$ for $i > 0$, and $\lambda_0, \gamma_0 \in \mathbb{R}$ such that*

$$(54) \quad \sum_{i=0}^k \lambda_i \ell(\mathcal{C}_i) = \sum_{i=0}^l \gamma_i \ell(\mathcal{C}'_i)$$

if and only if

$$(55) \quad \sum_{i=0}^k \lambda_i \rho(\mathcal{C}_i) = \sum_{i=0}^l \gamma_i \rho(\mathcal{C}'_i).$$

Proof. (4.13) It is clear that the map Γ , if it is well-defined, is surjective. Furthermore, by Lemma 3.51 we know that $\mathcal{K}^{\text{met}}(\mathcal{T})$ is a conical set complex whose face poset is $\mathcal{K}(\mathcal{T})$, hence Γ agrees on the intersection of conical sets. What remains to be seen is that Γ is well-defined and injective. We observe that the well-definedness of Γ follows from (54) \Rightarrow (55) in Lemma 4.16. The injectivity of Γ follows from (55) \Rightarrow (54) in Lemma 4.16. \square

Corollary 4.17. *Let $\bar{\Gamma} : \bar{\mathcal{K}}^{\text{met}}(\mathcal{T}) \rightarrow \bar{\mathcal{F}}(\mathcal{T})$ be the map induced by Γ . It follows from Lemma 3.27 and Proposition 4.13 that $\bar{\Gamma}$ is an isomorphism.*

4.3. \mathcal{T} -shuffles and adjoint permutation transformations.

The vertices of \mathcal{T} can be permuted during a collision. For a 2-associahedron associated to a pair of lines, the permutations of the points which can occur during a collision are precisely the riffle shuffle permutations. Motivated by this special case, we define a \mathcal{T} -shuffle to be a permutation of the vertices of \mathcal{T} which can occur during a collision. More precisely,

Definition 4.18. Let \mathcal{T} be a rooted plane tree, and let

$$(56) \quad S_{\mathcal{T}} := \bigoplus_{i=1}^n S_{|V^k(\mathcal{T})|}$$

be a direct sum of permutation groups. Let $\sigma \in S_{\mathcal{T}}$ with $\sigma = (\sigma^1, \dots, \sigma^n)$. We say that σ is a \mathcal{T} -shuffle if $\sigma^k(j) < \sigma^k(i)$ and $i < j$, then $\pi(u_{\sigma(j)}^k) \neq \pi(u_{\sigma(i)}^k)$. For

simplicity, we may refer to \mathcal{T} -shuffles as shuffles. We refer to the process of shuffles acting on labels of vertices of \mathcal{T} as *shuffling*. \triangle

Remark 4.19. The above definition is geometrically reasonable: if we have initial affine spaces L_i^k and L_j^k in a tree arrangement which are being permuted during a collision, they should not lie on a common affine space L of dimension 1 greater, e.g. points on a line should not be permuted. \triangle

In this subsection, we will define and investigate certain linear transformations encoding permutations for understanding how shuffling is geometrically manifested in the velocity fan.

Definition 4.20. Let $n \in \mathbb{N}$. Let e_i for $0 \leq i \leq n$ be the standard basis vectors for \mathbb{R}^{n+1} . The *type A -root system* is the set of vectors $A_n = \{e_i - e_j : 0 \leq i, j \leq n\}$ ¹⁷ The *positive simple roots* are the elements of A_n of the form $e_{i+1} - e_i$ for $0 \leq i \leq n-1$. The *type- A_n root lattice* \mathbb{A}_n is the integer span of the type- A_n roots, equivalently $\mathbb{A}_n = \{x \in \mathbb{Z}^{n+1} : \sum_{i=0}^n x_i = 0\}$. Let $\mathbb{A}_n^{\mathbb{R}} = \{x \in \mathbb{R}^{n+1} : \sum_{i=0}^n x_i = 0\} = \mathbb{A}_n \otimes \mathbb{R}$. \triangle

Definition 4.21. Let S_n be the n th permutation group. Let $\sigma \in S_{n+1}$ be a permutation. Let $R_\sigma : \mathbb{R}^{n+1} \rightarrow \mathbb{R}^{n+1}$ be the linear transformation determined by $R_\sigma(e_i) = e_{\sigma(i)}$. We define $P_\sigma : \mathbb{R}^n \rightarrow \mathbb{R}^n$ to be the restriction of R_σ to $\mathbb{A}_n^{\mathbb{R}}$ written in the basis of the positive simple roots. We call P_σ a *permutation transformation*. We define the transpose P_σ^T to be an *adjoint permutation transformation*.¹⁸ \triangle

We note that $R_\sigma^T = R_\sigma^{-1} = R_{\sigma^{-1}}$. As a result, there is a lack of agreement in the literature about the definition of R_σ , which is sometimes taken to mean the transpose of what we describe here. In this paper, we will be primarily interested in the adjoint permutation transformations. We emphasize that $P_\sigma^T \neq P_\sigma^{-1}$. Moreover, P_σ^T is not itself a permutation transformation.

Observe that

$$(57) \quad R_\sigma(e_{i+1} - e_i) = e_{\sigma(i+1)} - e_{\sigma(i)}.$$

Utilizing the elementary fact

$$(58) \quad e_{\sigma(i+1)} - e_{\sigma(i)} = \begin{cases} \sum_{j=\sigma(i)}^{\sigma(i+1)-1} e_j - e_{j+1} & \text{if } \sigma(i) < \sigma(i+1) \\ \sum_{j=\sigma(i+1)}^{\sigma(i)-1} e_{j+1} - e_j & \text{if } \sigma(i) > \sigma(i+1), \end{cases}$$

we may write the map R_σ in the basis of the positive simple roots to obtain

$$(59) \quad (P_\sigma)_{i,j} = \begin{cases} 1 & \text{if } \sigma(j) \leq i < \sigma(j+1) \\ -1 & \text{if } \sigma(j) > i \geq \sigma(j+1) \\ 0 & \text{otherwise.} \end{cases}$$

¹⁷This notation conflicts with that of a bracket with subscript n , but the root system A_n will be discussed sparingly, and no confusion should arise.

¹⁸Explicit descriptions of permutation transformation matrices (not only for transpositions) are provided in the thesis of Stucky [Stu21].

This implies that the transpose can be written as

$$(60) \quad (P_\sigma^T)_{i,j} = \begin{cases} 1 & \text{if } \sigma(i) \leq j < \sigma(i+1) \\ -1 & \text{if } \sigma(i) > j \geq \sigma(i+1) \\ 0 & \text{otherwise.} \end{cases}$$

Example 4.22. An adjoint permutation transformation associated to $\sigma = 3142$:

$$(61) \quad P_{3142}^T = \begin{pmatrix} -1 & -1 & 0 \\ 1 & 1 & 1 \\ 0 & -1 & -1 \end{pmatrix}.$$

△

The following lemma describes the essential relevance of the adjoint permutation transformations in this article.

Lemma 4.23. *Suppose that $\mathbf{v} \in \mathbb{R}^{n+1}$ and let $\bar{\mathbf{v}} \in \mathbb{R}^n$ be the vector such that $\bar{\mathbf{v}}_i = v_i - v_{i+1}$. Then for each $\sigma \in S_{n+1}$,*

$$(62) \quad P_\sigma^T(\bar{\mathbf{v}})_i = v_{\sigma(i)} - v_{\sigma(i+1)}.$$

Additionally,

$$(63) \quad P_\sigma^T(\mathbf{1})_i = \sigma(i+1) - \sigma(i).$$

Proof. The image of a vector $\bar{\mathbf{v}} \in \mathbb{R}^n$ under P_σ^T is as follows:

$$(64) \quad P_\sigma^T(\bar{\mathbf{v}})_i = \begin{cases} \sum_{j=\sigma(i)}^{\sigma(i+1)-1} \bar{\mathbf{v}}_j & \text{if } \sigma(i) < \sigma(i+1) \\ \sum_{j=\sigma(i+1)}^{\sigma(i)-1} -\bar{\mathbf{v}}_j & \text{if } \sigma(i) > \sigma(i+1) \end{cases}$$

$$(65) \quad P_\sigma^T(\bar{\mathbf{v}})_i = \begin{cases} \sum_{j=\sigma(i)}^{\sigma(i+1)-1} v_j - v_{j+1} & \text{if } \sigma(i) < \sigma(i+1) \\ \sum_{j=\sigma(i+1)}^{\sigma(i)-1} v_{j+1} - v_j & \text{if } \sigma(i) > \sigma(i+1) \end{cases}$$

$$(66) \quad = v_{\sigma(i)} - v_{\sigma(i+1)}.$$

The verification of $P_\sigma^T(\mathbf{1})_i = \sigma(i+1) - \sigma(i)$ is similar. □

Observe that given a collision $\mathcal{C} \in \mathfrak{X}(\mathcal{T})$, the vector $\rho(\mathcal{C}) - \mathbf{1}$ is the concatenation of n vectors of the form $\bar{\mathbf{v}}$ described in Lemma 4.23. Various unimodularity, i.e. toric smoothness, results in this paper are built on the following fact.

Lemma 4.24. *For each $\sigma \in S_{n+1}$, $P_\sigma \in GL_n(\mathbb{Z})$.*

Proof. Let $\sigma_1, \sigma_2 \in S_{n+1}$, then one can check that $P_{\sigma_1} \circ P_{\sigma_2} = P_{\sigma_1 \circ \sigma_2}$. Therefore $P_\sigma \circ P_{\sigma^{-1}} = I_n$, so $P_\sigma^{-1} = P_{\sigma^{-1}}$, and $P_\sigma \in GL_n(\mathbb{Z})$. □

Remark 4.25. The *consecutive-ones property* for these matrices (ignoring signs) implies the stronger statement that P_σ is totally unimodular. △

Definition 4.26. Let \mathcal{C} be a collision and $\sigma = (\sigma^1, \dots, \sigma^n)$ be a \mathcal{T} -shuffle. We say that σ is a *compatible \mathcal{T} -shuffle for \mathcal{C}* , or simply a *compatible shuffle*, if the following holds: let $\psi_{\mathcal{T}/\mathcal{C}}^{\mathcal{T}}$ be the collision map from Def. 2.43 (see also Propositions 2.45 and 2.46). Then either

- $\psi_{\mathcal{T}/\mathcal{C}}^{\mathcal{T}}(u_{\sigma^k(i+1)}^k) = \psi_{\mathcal{T}/\mathcal{C}}^{\mathcal{T}}(u_{\sigma^k(i)}^k)$ or
- $\psi_{\mathcal{T}/\mathcal{C}}^{\mathcal{T}}(u_{\sigma^k(i+1)}^k)$ is the successor of $\psi_{\mathcal{T}/\mathcal{C}}^{\mathcal{T}}(u_{\sigma^k(i)}^k)$ in \mathcal{T}/\mathcal{C} .

We adopt the convention that any \mathcal{T} -shuffle is a compatible shuffle for \mathcal{B}_{\min} .

In the future, if k is clear from the context, we may denote $\sigma^k(i)$ by $\sigma(i)$.

It is easy to construct a compatible shuffle σ for a collision \mathcal{C} : take the order $<_{\mathcal{T}/\mathcal{C}}$ on $V^k(\mathcal{T}/\mathcal{C})$ and extend this to a total order σ_k of $V^k(\mathcal{T})$ by ordering the elements in the fibers of the map $\psi_{\mathcal{T}/\mathcal{C}}^{\mathcal{T}} : \mathcal{T} \rightarrow \mathcal{T}/\mathcal{C}$ so that the shuffle condition is preserved.

Definition 4.27. Given $\sigma \in S_{\mathcal{T}}$, we define $P_{\sigma} := \bigoplus_{i=0}^n P_{\sigma^k}$. △

Example 4.28. An adjoint permutation transformation associated to a compatible shuffle for the collision in Figure 18:

$$(67) \quad P_{(12,3142)}^T = \begin{pmatrix} 1 & 0 & 0 & 0 \\ 0 & -1 & -1 & 0 \\ 0 & 1 & 1 & 1 \\ 0 & 0 & -1 & -1 \end{pmatrix}.$$

△

The following Lemmas 4.29 and 4.30 are clear from inspection.

Lemma 4.29. Let $\mathcal{C} \in \mathfrak{X}(\mathcal{T})$ and let σ be a compatible shuffle for \mathcal{C} . Then for any vertex $u_i^k \in V^k(\mathcal{T})$ which is not descended from a vertex in the fusion bracket of \mathcal{C} , we have that $u_{\sigma^k(i)}^k = u_i^k$.

Lemma 4.30. Let \mathcal{C} and \mathcal{C}' be collisions such that \mathcal{C} and \mathcal{C}' have the same fusion bracket and $\mathcal{C} \rightarrow \mathcal{C}'$. Suppose σ is a compatible shuffle for \mathcal{C} , then σ is a compatible shuffle for \mathcal{C}' .

The following lemma will be utilized in the proof of Theorem 4.15.

Lemma 4.31. Suppose that \mathcal{C} is an extended collision and σ is a compatible shuffle for \mathcal{C} . Then $\sigma(\rho(\mathcal{C})) := P_{\sigma}^T((\rho(\mathcal{C}) - \mathbf{1}) + \mathbf{1})$ is a 0-1 vector, and the entry $\sigma(\rho(\mathcal{C}))_i^k = 1$ if and only if $u_{\sigma(i)}^k$ and $u_{\sigma(i+1)}^k$ belong to a common essential bracket in \mathcal{C} .

Proof. We first give a formal proof and then outline how we are thinking about things in terms of collisions of affine coordinate spaces. Recall that

$$(68) \quad \rho(\mathcal{C})_i^k = d_{\mathcal{T}/\mathcal{C}}(\psi_{\mathcal{T}/\mathcal{C}}^{\mathcal{T}}(u_i^k)) - d_{\mathcal{T}/\mathcal{C}}(\psi_{\mathcal{T}/\mathcal{C}}^{\mathcal{T}}(u_{i+1}^k)) + 1.$$

Therefore

$$(69) \quad (\rho(\mathcal{C}) - \mathbf{1})_i^k = d_{\mathcal{T}/\mathcal{C}}(\psi_{\mathcal{T}/\mathcal{C}}^{\mathcal{T}}(u_i^k)) - d_{\mathcal{T}/\mathcal{C}}(\psi_{\mathcal{T}/\mathcal{C}}^{\mathcal{T}}(u_{i+1}^k)).$$

By Lemma 4.23, we know that

$$(70) \quad P_\sigma^T(\rho(\mathcal{C}) - \mathbf{1})_i^k = d_{\mathcal{T}/\mathcal{C}}(\psi_{\mathcal{T}/\mathcal{C}}^T(u_{\sigma(i)}^k)) - d_{\mathcal{T}/\mathcal{C}}(\psi_{\mathcal{T}/\mathcal{C}}^T(u_{\sigma(i+1)}^k)),$$

hence

$$(71) \quad (P_\sigma^T(\rho(\mathcal{C}) - \mathbf{1}) + \mathbf{1})_i^k = d_{\mathcal{T}/\mathcal{C}}(\psi_{\mathcal{T}/\mathcal{C}}^T(u_{\sigma(i)}^k)) - d_{\mathcal{T}/\mathcal{C}}(\psi_{\mathcal{T}/\mathcal{C}}^T(u_{\sigma(i+1)}^k)) + 1.$$

Because σ is a compatible shuffle for \mathcal{C} , for every $1 \leq i \leq t_k$ we have that

$$(72) \quad d_{\mathcal{T}/\mathcal{C}}(\psi_{\mathcal{T}/\mathcal{C}}^T(u_{\sigma(i)}^k)) = d_{\mathcal{T}/\mathcal{C}}(\psi_{\mathcal{T}/\mathcal{C}}^T(u_{\sigma(i+1)}^k))$$

or

$$(73) \quad d_{\mathcal{T}/\mathcal{C}}(\psi_{\mathcal{T}/\mathcal{C}}^T(u_{\sigma(i)}^k)) = d_{\mathcal{T}/\mathcal{C}}(\psi_{\mathcal{T}/\mathcal{C}}^T(u_{\sigma(i+1)}^k)) - 1,$$

and the former case occurs if and only if $u_{\sigma(i)}^k$ and $u_{\sigma(i+1)}^k$ are contained in a common essential k -bracket in \mathcal{C} . \square

Recall that an entry in $\rho(\mathcal{C})$ encodes the relative change of distance between a consecutive pair of initial coordinate spaces during a collision. When we take the difference, $\rho(\mathcal{C}) - \mathbf{1}$, this vector encodes the relative change in distance between a consecutive pair of initial coordinate spaces starting at the arrangement where all initial spaces have collapsed to a single flag of linear coordinate spaces, and ending at the configuration associated to \mathcal{C} . When we apply the transformation P_σ^T we find that an entry in $P_\sigma^T(\rho(\mathcal{C}) - \mathbf{1})$ similarly encodes the relative change in distance between a consecutive pair of initial coordinate spaces starting at the arrangement where all spaces have collapsed to a single flag and ending at the configuration associated to \mathcal{C} , but now initial coordinate spaces are taken to be consecutive with respect to σ . When we add the vector $\mathbf{1}$ we find that an entry in $P_\sigma^T(\rho(\mathcal{C}) - \mathbf{1}) + \mathbf{1}$ encodes the relative change in distance between a consecutive pair of initial coordinate spaces starting at the arrangement where all spaces have been placed at positions according to σ and pass to the configuration associated to \mathcal{C} , and consecutivity is again taken with respect to σ . By our choice of σ , consecutive initial coordinate spaces are spaced one unit apart and either collide or remain one unit apart, establishing the lemma. See Figure 21 for an illustration.

The following technical Lemma 4.32 and its strengthening Lemma 4.33 are essential for understanding the recursive structure of the velocity fan, but will not be utilized until §5, after the velocity fan has been proven to be a fan which is complete. So, if the reader is primarily interested in understanding the proof of this main theorem, the following lemma can be skipped on an initial read.

Lemma 4.32. *Let $\mathcal{C} \in \mathfrak{X}(\mathcal{T})$ and $\mathcal{C}' \in \widehat{\mathfrak{X}}(\mathcal{T})$. Take σ a compatible shuffle for \mathcal{C} . Let $u_j^k \in V^k(\mathcal{T}/\mathcal{C})$ and $u_{\sigma(i)}^k \in V^k(\mathcal{T})$ be such that $\psi_{\mathcal{T}/\mathcal{C}}^T(u_{\sigma(i)}^k) = u_j^k$.*

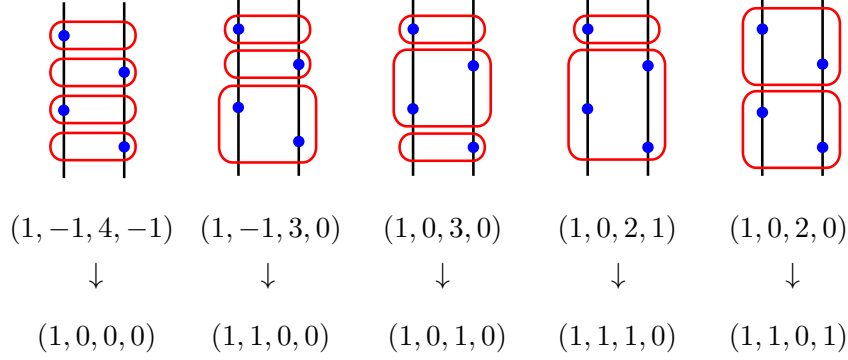

$$\begin{aligned}
 (74) \quad & P_{(12,3142)}^T \left(\left(\begin{pmatrix} 1 \\ -1 \\ 3 \\ 0 \end{pmatrix} - \begin{pmatrix} 1 \\ 1 \\ 1 \\ 1 \end{pmatrix} \right) + \begin{pmatrix} 1 \\ 1 \\ 1 \\ 1 \end{pmatrix} \right) \\
 &= \begin{pmatrix} 1 & 0 & 0 & 0 \\ 0 & -1 & -1 & 0 \\ 0 & 1 & 1 & 1 \\ 0 & 0 & -1 & -1 \end{pmatrix} \begin{pmatrix} 0 \\ -2 \\ 2 \\ -1 \end{pmatrix} + \begin{pmatrix} 1 \\ 1 \\ 1 \\ 1 \end{pmatrix} = \begin{pmatrix} 1 \\ 1 \\ 0 \\ 0 \end{pmatrix}.
 \end{aligned}$$

FIGURE 21. We illustrate the map $\rho \mapsto P_\sigma^T(\rho - \mathbf{1}) + \mathbf{1}$ from Lemma 4.31 using the transformation P_σ^T from Example 4.28, and we explicitly calculate this map for the collision second from the left on the top row. Observe that the points are placed at heights according to the permutation 3142.

If $\mathcal{C} \rightarrow \mathcal{C}'$ and $\mathcal{C}/\mathcal{C}' \in \mathfrak{X}(\mathcal{T}/\mathcal{C})$, then

$$(75) \quad (P_\sigma^T(\rho(\mathcal{C}') - \rho(\mathcal{C})))_i^k = \begin{cases} \rho(\mathcal{C}'/\mathcal{C})_j^k & \text{if } i = \max\{h : \psi_{\mathcal{T}/\mathcal{C}}^T(u_{\sigma(h)}^k) = u_j^k\} \\ 0 & \text{otherwise,} \end{cases}$$

and if $\mathcal{C} \sim \mathcal{C}'$ then

$$(76) \quad (P_\sigma^T(\rho(\mathcal{C}')))_i^k = \begin{cases} \rho(\mathcal{C}'/\mathcal{C})_j^k & \text{if } i = \max\{h : \psi_{\mathcal{T}/\mathcal{C}}^T(u_{\sigma(h)}^k) = u_j^k\} \\ 0 & \text{otherwise.} \end{cases}$$

Proof. Suppose that $\mathcal{C} \rightarrow \mathcal{C}'$ and $\mathcal{C}/\mathcal{C}' \in \mathfrak{X}(\mathcal{T}/\mathcal{C})$. We calculate $(P_\sigma^T(\rho(\mathcal{C}') - \rho(\mathcal{C})))_i^k$. Recall that

$$(77) \quad \rho(\mathcal{C})_i^k = d_{\mathcal{T}/\mathcal{C}}(\psi_{\mathcal{T}/\mathcal{C}}^T(u_i^k)) - d_{\mathcal{T}/\mathcal{C}}(\psi_{\mathcal{T}/\mathcal{C}}^T(u_{i+1}^k)) + 1.$$

Therefore

$$(78) \quad (\rho(\mathcal{C}') - \rho(\mathcal{C}))_i^k =$$

$$d_{\mathcal{T}/\mathcal{C}'}(\psi_{\mathcal{T}/\mathcal{C}'}^{\mathcal{T}}(u_i^k)) - d_{\mathcal{T}/\mathcal{C}'}(\psi_{\mathcal{T}/\mathcal{C}'}^{\mathcal{T}}(u_{i+1}^k)) - (d_{\mathcal{T}/\mathcal{C}}(\psi_{\mathcal{T}/\mathcal{C}}^{\mathcal{T}}(u_i^k)) - d_{\mathcal{T}/\mathcal{C}}(\psi_{\mathcal{T}/\mathcal{C}}^{\mathcal{T}}(u_{i+1}^k))),$$

$$(79) \quad \text{hence by Lemma 4.23 } (P_\sigma^{\mathcal{T}}(\rho(\mathcal{C}') - \rho(\mathcal{C})))_i^k =$$

$$(80) \quad \begin{aligned} & d_{\mathcal{T}/\mathcal{C}'}(\psi_{\mathcal{T}/\mathcal{C}'}^{\mathcal{T}}(u_{\sigma(i)}^k)) - d_{\mathcal{T}/\mathcal{C}'}(\psi_{\mathcal{T}/\mathcal{C}'}^{\mathcal{T}}(u_{\sigma(i+1)}^k)) \\ & - (d_{\mathcal{T}/\mathcal{C}}(\psi_{\mathcal{T}/\mathcal{C}}^{\mathcal{T}}(u_{\sigma(i)}^k)) - d_{\mathcal{T}/\mathcal{C}}(\psi_{\mathcal{T}/\mathcal{C}}^{\mathcal{T}}(u_{\sigma(i+1)}^k))). \end{aligned}$$

If $i \neq \max\{h : \psi_{\mathcal{T}/\mathcal{C}}^{\mathcal{T}}(u_{\sigma(h)}^k) = u_j^k\}$, then $\psi_{\mathcal{T}/\mathcal{C}}^{\mathcal{T}}(u_{\sigma(i)}^k) = \psi_{\mathcal{T}/\mathcal{C}}^{\mathcal{T}}(u_{\sigma(i+1)}^k)$ and $\psi_{\mathcal{T}/\mathcal{C}'}^{\mathcal{T}}(u_{\sigma(i)}^k) = \psi_{\mathcal{T}/\mathcal{C}'}^{\mathcal{T}}(u_{\sigma(i+1)}^k)$, thus $P_\sigma^{\mathcal{T}}(\rho(\mathcal{C}') - \rho(\mathcal{C}))_i^k = 0$. On the other hand, suppose that $i = \max\{h : \psi_{\mathcal{T}/\mathcal{C}}^{\mathcal{T}}(u_{\sigma(h)}^k) = u_j^k\}$. We would like to prove that

$$(81) \quad \begin{aligned} & d_{\mathcal{T}/\mathcal{C}'}(\psi_{\mathcal{T}/\mathcal{C}'}^{\mathcal{T}}(u_{\sigma(i)}^k)) - d_{\mathcal{T}/\mathcal{C}'}(\psi_{\mathcal{T}/\mathcal{C}'}^{\mathcal{T}}(u_{\sigma(i+1)}^k)) \\ & - (d_{\mathcal{T}/\mathcal{C}}(\psi_{\mathcal{T}/\mathcal{C}}^{\mathcal{T}}(u_{\sigma(i)}^k)) - d_{\mathcal{T}/\mathcal{C}}(\psi_{\mathcal{T}/\mathcal{C}}^{\mathcal{T}}(u_{\sigma(i+1)}^k))) \\ & = \rho(\mathcal{C}'/\mathcal{C})_j^k \\ & = d_{\mathcal{T}/\mathcal{C}'}(\psi_{(\mathcal{T}/\mathcal{C})/(\mathcal{C}'/\mathcal{C})}^{\mathcal{T}/\mathcal{C}}(u_j^k)) - d_{\mathcal{T}/\mathcal{C}'}(\psi_{(\mathcal{T}/\mathcal{C})/(\mathcal{C}'/\mathcal{C})}^{\mathcal{T}/\mathcal{C}}(u_{j+1}^k)) + 1. \end{aligned}$$

By construction,

$$(82) \quad d_{\mathcal{T}/\mathcal{C}}(\psi_{\mathcal{T}/\mathcal{C}}^{\mathcal{T}}(u_{\sigma(i)}^k)) - d_{\mathcal{T}/\mathcal{C}}(\psi_{\mathcal{T}/\mathcal{C}}^{\mathcal{T}}(u_{\sigma(i+1)}^k)) = -1$$

and it remains to check that

$$(83) \quad d_{\mathcal{T}/\mathcal{C}'}(\psi_{\mathcal{T}/\mathcal{C}'}^{\mathcal{T}}(u_{\sigma(i)}^k)) - d_{\mathcal{T}/\mathcal{C}'}(\psi_{\mathcal{T}/\mathcal{C}'}^{\mathcal{T}}(u_{\sigma(i+1)}^k))$$

$$(84) \quad = d_{\mathcal{T}/\mathcal{C}'}(\psi_{(\mathcal{T}/\mathcal{C})/(\mathcal{C}'/\mathcal{C})}^{\mathcal{T}/\mathcal{C}}(u_j^k)) - d_{\mathcal{T}/\mathcal{C}'}(\psi_{(\mathcal{T}/\mathcal{C})/(\mathcal{C}'/\mathcal{C})}^{\mathcal{T}/\mathcal{C}}(u_{j+1}^k)).$$

Because $\mathcal{C} \rightarrow \mathcal{C}'$, the map of rooted plane trees $\psi_{\mathcal{T}/\mathcal{C}'}$ factors as

$$(85) \quad \psi_{\mathcal{T}/\mathcal{C}'}^{\mathcal{T}} = \psi_{(\mathcal{T}/\mathcal{C})/(\mathcal{C}'/\mathcal{C})}^{\mathcal{T}/\mathcal{C}} \circ \psi_{\mathcal{T}/\mathcal{C}}^{\mathcal{T}}$$

and the desired equality follows.

We next assume that $\mathcal{C} \sim \mathcal{C}'$. In verifying the corresponding part of the statement of the lemma we employ (admittedly annoying) case analysis. Recall

$$(86) \quad \rho(\mathcal{C}')_i^k = d_{\mathcal{T}/\mathcal{C}'}(\psi_{\mathcal{T}/\mathcal{C}'}^{\mathcal{T}}(u_i^k)) - d_{\mathcal{T}/\mathcal{C}'}(\psi_{\mathcal{T}/\mathcal{C}'}^{\mathcal{T}}(u_{i+1}^k)) + 1$$

$$(87) \quad \text{hence by Lemma 4.23, } (P_\sigma^T(\rho(\mathcal{C}'))_i^k =$$

$$(88) \quad d_{\mathcal{T}/\mathcal{C}'}(\psi_{\mathcal{T}/\mathcal{C}'}^{\mathcal{T}}(u_{\sigma(i)}^k)) - d_{\mathcal{T}/\mathcal{C}'}(\psi_{\mathcal{T}/\mathcal{C}'}^{\mathcal{T}}(u_{\sigma(i+1)}^k)) + \sigma(i+1) - \sigma(i).$$

First, we note that u_i^k , respectively u_{i+1}^k , is descended from a vertex in the fusion bracket for \mathcal{C} if and only if $u_{\sigma(i)}^k$, respectively $u_{\sigma(i+1)}^k$, is descended from a vertex in the fusion bracket for \mathcal{C} .

Suppose $i \neq \max\{h : \psi_{\mathcal{T}/\mathcal{C}}^{\mathcal{T}}(u_{\sigma(h)}^k) = u_j^k\}$, it must be that u_i^k and u_{i+1}^k belong to a common essential k -bracket in \mathcal{C}^k , hence they are descended from vertices in the fusion bracket for \mathcal{C} . Then

$$(89) \quad d_{\mathcal{T}/\mathcal{C}'}(\psi_{\mathcal{T}/\mathcal{C}'}^{\mathcal{T}}(u_{\sigma(i)}^k)) - \sigma(i) = d_{\mathcal{T}/\mathcal{C}'}(\psi_{\mathcal{T}/\mathcal{C}'}^{\mathcal{T}}(u_{\sigma(i+1)}^k)) - \sigma(i+1), \text{ implying}$$

$$(90) \quad d_{\mathcal{T}/\mathcal{C}'}(\psi_{\mathcal{T}/\mathcal{C}'}^{\mathcal{T}}(u_{\sigma(i)}^k)) - d_{\mathcal{T}/\mathcal{C}'}(\psi_{\mathcal{T}/\mathcal{C}'}^{\mathcal{T}}(u_{\sigma(i+1)}^k)) + \sigma(i+1) - \sigma(i) = 0,$$

so $(P_\sigma^T(\rho(\mathcal{C}'))_i^k = 0$, as desired.

Next assume that $i = \max\{h : \psi_{\mathcal{T}/\mathcal{C}}^{\mathcal{T}}(u_{\sigma(h)}^k) = u_j^k\}$. Recall

$$(91) \quad \rho(\mathcal{C}'/\mathcal{C})_j^k = d_{(\mathcal{T}/\mathcal{C})/\mathcal{C}'}(\psi_{(\mathcal{T}/\mathcal{C})/\mathcal{C}'}^{\mathcal{T}/\mathcal{C}}(u_j^k)) - d_{(\mathcal{T}/\mathcal{C})/\mathcal{C}'}(\psi_{(\mathcal{T}/\mathcal{C})/\mathcal{C}'}^{\mathcal{T}/\mathcal{C}}(u_{j+1}^k)) + 1.$$

First suppose u_i^k and u_{i+1}^k are descended from vertices in the fusion bracket for \mathcal{C} . As observed above, $(P_\sigma^T(\rho(\mathcal{C}'))_i^k = 0$, so we must show that $\rho(\mathcal{C}'/\mathcal{C})_j^k = 0$ as well. We know that $\psi_{\mathcal{T}/\mathcal{C}}^{\mathcal{T}}(u_{\sigma(i)}^k) = u_j^k$ and $\psi_{\mathcal{T}/\mathcal{C}}^{\mathcal{T}}(u_{\sigma(i+1)}^k) = u_{j+1}^k$. Moreover, u_j^k and u_{j+1}^k are both not descended from the fusion bracket for \mathcal{C}'/\mathcal{C} in \mathcal{T}/\mathcal{C} , thus the image of u_{j+1}^k in $\mathcal{T}/\mathcal{C}/\mathcal{C}'$ is the successor of the image of u_j^k in $\mathcal{T}/\mathcal{C}/\mathcal{C}'$, i.e. $d_{(\mathcal{T}/\mathcal{C})/\mathcal{C}'}(\psi_{(\mathcal{T}/\mathcal{C})/\mathcal{C}'}^{\mathcal{T}/\mathcal{C}}(u_j^k)) - d_{(\mathcal{T}/\mathcal{C})/\mathcal{C}'}(\psi_{(\mathcal{T}/\mathcal{C})/\mathcal{C}'}^{\mathcal{T}/\mathcal{C}}(u_{j+1}^k)) = -1$ and so $\rho(\mathcal{C}'/\mathcal{C})_j^k = 0$, as desired.

For the remaining analysis we will assume that u_i^k and u_{i+1}^k are not both descended from vertices in the fusion bracket for \mathcal{C} (continuing to assume that $i = \max\{h : \psi_{\mathcal{T}/\mathcal{C}}^{\mathcal{T}}(u_{\sigma(h)}^k) = u_j^k\}$).

Next suppose that u_i^k and u_{i+1}^k are both not descended from vertices in the fusion bracket for \mathcal{C} . Because σ is a compatible shuffle for \mathcal{C} we can apply Lemma 4.29 to deduce that

$$(92) \quad P_\sigma^T(\rho(\mathcal{C}'))_i^k = d_{\mathcal{T}/\mathcal{C}'}(\psi_{\mathcal{T}/\mathcal{C}'}^{\mathcal{T}}(u_i^k)) - d_{\mathcal{T}/\mathcal{C}'}(\psi_{\mathcal{T}/\mathcal{C}'}^{\mathcal{T}}(u_{i+1}^k)) + 1.$$

One may check that

$$(93) \quad d_{\mathcal{T}/\mathcal{C}'}(\psi_{\mathcal{T}/\mathcal{C}'}^{\mathcal{T}}(u_i^k)) - d_{(\mathcal{T}/\mathcal{C})/\mathcal{C}'}(\psi_{(\mathcal{T}/\mathcal{C})/\mathcal{C}'}^{\mathcal{T}/\mathcal{C}}(u_j^k)) =$$

$$(94) \quad d_{\mathcal{T}/\mathcal{C}'}(\psi_{\mathcal{T}/\mathcal{C}'}^{\mathcal{T}}(u_{i+1}^k)) - d_{(\mathcal{T}/\mathcal{C})/\mathcal{C}'}(\psi_{(\mathcal{T}/\mathcal{C})/\mathcal{C}'}^{\mathcal{T}/\mathcal{C}}(u_{j+1}^k)),$$

thus $P_{\sigma}^{\mathcal{T}}(\rho(\mathcal{C}'))_i^k = \rho(\mathcal{C}'/\mathcal{C})_j^k$.

Next suppose that u_i^k is not descended from a vertex in the fusion bracket for \mathcal{C} , but u_{i+1}^k is descended from a vertex in the fusion bracket for \mathcal{C} . By Lemma 4.29, we have that $\sigma(i) = i = j$.

Suppose further that u_i^k is not descended from a vertex in the fusion bracket for \mathcal{C}' . In this case, because $\mathcal{C} \sim \mathcal{C}'$, u_i^k and u_{i+1}^k are both not descended from a vertex in the fusion bracket for \mathcal{C}' , and u_j^k and u_{j+1}^k are both not descended from a vertex in the fusion bracket for \mathcal{C}'/\mathcal{C} . Therefore

$$(95) \quad (P_{\sigma}^{\mathcal{T}}(\rho(\mathcal{C}'))_i^k = d_{\mathcal{T}/\mathcal{C}'}(\psi_{\mathcal{T}/\mathcal{C}'}^{\mathcal{T}}(u_{\sigma(i)}^k)) - d_{\mathcal{T}/\mathcal{C}'}(\psi_{\mathcal{T}/\mathcal{C}'}^{\mathcal{T}}(u_{\sigma(i+1)}^k)) + \sigma(i+1) - \sigma(i) = 0,$$

and

$$(96) \quad \rho(\mathcal{C}'/\mathcal{C})_j^k = d_{(\mathcal{T}/\mathcal{C})/\mathcal{C}'}(\psi_{(\mathcal{T}/\mathcal{C})/\mathcal{C}'}^{\mathcal{T}/\mathcal{C}}(u_j^k)) - d_{(\mathcal{T}/\mathcal{C})/\mathcal{C}'}(\psi_{(\mathcal{T}/\mathcal{C})/\mathcal{C}'}^{\mathcal{T}/\mathcal{C}}(u_{j+1}^k)) + 1 = 0.$$

Hence $(P_{\sigma}^{\mathcal{T}}(\rho(\mathcal{C}'))_i^k = \rho(\mathcal{C}'/\mathcal{C})_j^k$.

Next, suppose that u_i^k is descended from a vertex in the fusion bracket for \mathcal{C}' , and u_{i+1}^k is descended from a vertex in the fusion bracket for \mathcal{C} .

Because $\sigma(i) = i = j$, we see that

$$(97) \quad d_{\mathcal{T}/\mathcal{C}'}(\psi_{\mathcal{T}/\mathcal{C}'}^{\mathcal{T}}(u_{\sigma(i)}^k)) = d_{(\mathcal{T}/\mathcal{C})/\mathcal{C}'}(\psi_{(\mathcal{T}/\mathcal{C})/\mathcal{C}'}^{\mathcal{T}/\mathcal{C}}(u_j^k)).$$

So to prove that $(P_{\sigma}^{\mathcal{T}}(\rho(\mathcal{C}'))_i^k = \rho(\mathcal{C}'/\mathcal{C})_j^k$, we must show that

$$(98) \quad d_{(\mathcal{T}/\mathcal{C})/\mathcal{C}'}(\psi_{(\mathcal{T}/\mathcal{C})/\mathcal{C}'}^{\mathcal{T}/\mathcal{C}}(u_{j+1}^k)) - (j+1) = d_{\mathcal{T}/\mathcal{C}'}(\psi_{\mathcal{T}/\mathcal{C}'}^{\mathcal{T}}(u_{\sigma(i+1)}^k)) - \sigma(i+1).$$

This equality follows from the observations that

$$(99) \quad d_{\mathcal{T}/\mathcal{C}'}(\psi_{\mathcal{T}/\mathcal{C}'}^{\mathcal{T}}(u_{\sigma(i+1)}^k)) = \sigma(i+1) - (|V^k(\mathcal{T})| - |V^k(\mathcal{T}/\mathcal{C}')|)$$

and

$$(100) \quad d_{(\mathcal{T}/\mathcal{C})/\mathcal{C}'}(\psi_{(\mathcal{T}/\mathcal{C})/\mathcal{C}'}^{\mathcal{T}/\mathcal{C}}(u_{j+1}^k)) = j+1 - (|V^k(\mathcal{T}/\mathcal{C})| - |V^k((\mathcal{T}/\mathcal{C})/\mathcal{C}')|)$$

$$(101) \quad = j+1 - (|V^k(\mathcal{T})| - |V^k(\mathcal{T}/\mathcal{C}')|).$$

The remaining case to check when u_i^k is descended from a vertex in the fusion bracket for \mathcal{C} , but u_{i+1}^k is not descended from a vertex in the fusion bracket for \mathcal{C} (with subcases addressing whether or not u_{i+1}^k is descended from a vertex in the fusion bracket for \mathcal{C}'). This case is very similar to the previous case above and we leave the details to the reader. \square

We offer the following strengthening of the first part of Lemma 4.32 .

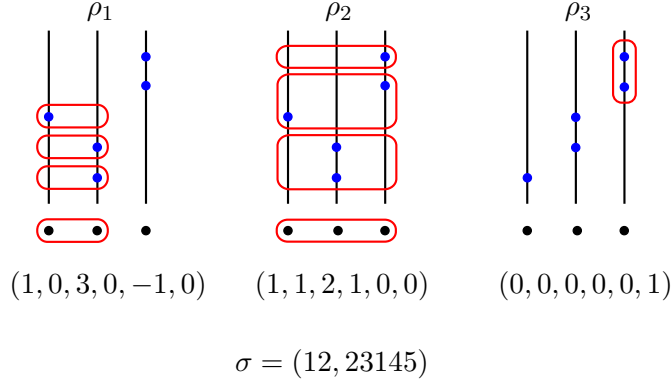

$$P_\sigma^T = \begin{pmatrix} 1 & 0 & 0 & 0 & 0 & 0 \\ 0 & 1 & 0 & 0 & 0 & 0 \\ 0 & 0 & 0 & 1 & 0 & 0 \\ 0 & 0 & -1 & -1 & 0 & 0 \\ 0 & 0 & 1 & 1 & 1 & 0 \\ 0 & 0 & 0 & 0 & 0 & 1 \end{pmatrix}$$

$$P_\sigma^T(\rho_2 - \rho_1) = (0, 1, 1, 0, 1, 0), \quad P_\sigma^T(\rho_3) = (0, 0, 0, 0, 0, 1)$$

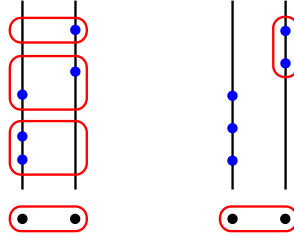

FIGURE 22. We illustrate the maps $\rho(\mathcal{C}') \rightarrow P^T(\rho(\mathcal{C}') - \rho(\mathcal{C}))$ and $\rho(\mathcal{C}') \rightarrow P^T(\rho(\mathcal{C}'))$ from Lemma 4.32.

Lemma 4.33. *Let $\mathcal{C} \in \mathfrak{X}(\mathcal{T})$ and $\mathcal{C}' \in \widehat{\mathfrak{X}}(\mathcal{T})$, and let σ be a compatible shuffle for \mathcal{C} . Let $u_{\sigma(i)}^k \in V^k(\mathcal{T})$ and $u_j^k \in V^k(\mathcal{T}/\mathcal{C})$ such that $\psi_{\mathcal{T}/\mathcal{C}}^{\mathcal{T}}(u_{\sigma(i)}^k) = u_j^k$. If $\mathcal{C} \rightarrow \mathcal{C}'$ and $\{(\mathcal{C}'/\mathcal{C})_r : 1 \leq r \leq t\}$ are the collisions whose union is \mathcal{C}'/\mathcal{C} , as is guaranteed by Lemma 2.69, then*

$$(102) \quad (P_\sigma^T(\rho(\mathcal{C}') - \rho(\mathcal{C})))_i^k = \begin{cases} (\sum_{r=1}^t \rho(\mathcal{C}'/\mathcal{C})_r)_j^k & \text{if } i = \max\{h : \psi_{\mathcal{T}/\mathcal{C}}^{\mathcal{T}}(u_{\sigma(h)}^k) = u_j^k\} \\ 0 & \text{otherwise.} \end{cases}$$

Proof. Recall that $r > 1$ only if \mathcal{C} and \mathcal{C}' have the same fusion bracket. Let \mathcal{C}'_r denote the preimage of $(\mathcal{C}'/\mathcal{C})_r$ in $\mathfrak{X}(\mathcal{T})$ provided by Lemma 2.67. By Lemma 4.32 we know that

$$(103) \quad (P_\sigma^T(\rho(\mathcal{C}'_r) - \rho(\mathcal{C})))_i^k = \begin{cases} \rho(\mathcal{C}'_r/\mathcal{C})_j^k & \text{if } i = \max\{h : \psi_{\mathcal{T}/\mathcal{C}}^T(u_{\sigma(h)}^k) = u_j^k\} \\ 0 & \text{otherwise} \end{cases}$$

Thus it suffices to prove that

$$(104) \quad P_\sigma^T(\rho(\mathcal{C}') - \rho(\mathcal{C})) = \sum_{i=1}^t P_\sigma^T(\rho(\mathcal{C}'_r) - \rho(\mathcal{C}))$$

Because P_σ^T is an invertible linear transformation this reduces to checking that

$$(105) \quad \rho(\mathcal{C}') + (t-1)\rho(\mathcal{C}) = \sum_{i=1}^t \rho(\mathcal{C}'_r)$$

At this point one can use the definition of ρ and calculate directly that this equation indeed holds, but this is a little technical and so we have chosen to go a different route. We invoke Proposition 4.13, which states that Γ is a piecewise-linear isomorphism.¹⁹ This allows us to apply Γ^{-1} and reduce the above equation to the observation that

$$(106) \quad \ell(\mathcal{C}') + (t-1)\ell(\mathcal{C}) = \sum_{i=1}^t \ell(\mathcal{C}'_r).$$

Let $\mathcal{B} = \mathcal{C}' \vee \mathcal{C} = \vee_{i=1}^t \mathcal{C}'_r$. Let $\ell_{\mathcal{B}}$ and $\ell'_{\mathcal{B}}$ be the metric n -bracketings associated to the left and right side of the above equation, respectively. We wish to show that for each k -bracket A , we have $\ell_{\mathcal{B}}(A) = \ell'_{\mathcal{B}}(A)$. By definition, if $A \notin \mathcal{B}^k$, or A is a singleton bracket, then $\ell_{\mathcal{B}}(A) = \ell'_{\mathcal{B}}(A) = 0$. Let $A \in \mathcal{B}^k$ be a nonsingleton bracket. If $A \in (\mathcal{C}')^k \setminus \mathcal{C}^k$, then $A \in \mathcal{C}'_r$ for a unique r , hence $\ell_{\mathcal{B}}(A) = \ell'_{\mathcal{B}}(A) = 1$. If $A \in (\mathcal{C}')^k$ and $A \in \mathcal{C}^k$, then $A \in \mathcal{C}'_r$ for all r , and $\ell_{\mathcal{B}}(A) = \ell'_{\mathcal{B}}(A) = t$. If $A \in \mathcal{C}^k \setminus (\mathcal{C}')^k$ then there exists a k -bracket $A' \in (\mathcal{C}')^k$ such that $A \subsetneq A'$, and there exists a unique r such that $A' \in \mathcal{C}'_r$. It follows that $A \in \mathcal{C}'_s$ for all $s \neq r$, and $\ell_{\mathcal{B}}(A) = \ell'_{\mathcal{B}}(A) = t-1$. \square

4.4. The main lemma for the velocity fan.

In this section we establish Lemma 4.34 which will later be employed for inductively proving (55) \Rightarrow (54) in Lemma 4.16. The motivating idea of this section is rather simple, even if the resulting argument is not: given a vector \mathbf{v} in the velocity fan, we aim to find a collision \mathcal{C} , which is a function of \mathbf{v} , such that for any metric n -bracketing $\ell_{\mathcal{B}}$ with $\Gamma(\ell_{\mathcal{B}}) = \mathbf{v}$, we have $\mathcal{C} \leq \mathcal{B}$. Given such a \mathcal{C} , we hope to subtract some multiple of $\rho(\mathcal{C})$ from \mathbf{v} to get a “smaller” vector to which we can apply induction for demonstrating (55) \Rightarrow (54).

¹⁹Although we invoke the fact that Γ is a piecewise-linear isomorphism, we emphasize that Lemma 4.33 will not be utilized until §5 after we have proven Proposition 4.13.

Lemma 4.34. *Let $\mathbf{v} \in \mathcal{F}(\mathcal{T})$. There exists an extended collision $\mathcal{C}_{\mathbf{v}}$, which is a function of \mathbf{v} alone, such that given any compatible collection $\{\mathcal{C}_i \in \widehat{\mathcal{X}}(\mathcal{T}) : 0 \leq i \leq k\}$ with $\mathcal{C}_0 = \mathcal{B}_{\min}$ and $\lambda_i \in \mathbb{R}$ with $\lambda_i > 0$ for $i > 0$ such that $\mathbf{v} = \sum_{i=1}^k \lambda_i \rho(\mathcal{C}_i)$, we have that $\mathcal{C}_{\mathbf{v}}$ is containment-minimal in $\bigvee_{i=1}^k \mathcal{C}_i$.*

The proof of Lemma 4.34 requires us to assume Proposition 4.13 holds for all $(n-1)$ -associahedra. We will establish Lemma 4.34 as consequence of Lemma 4.36, which allows us to identify containment-minimal collisions. Lemma 4.36 requires the following technical Definition 4.35.

Recall that we denote a vector $\mathbf{v} \in \mathbb{R}^m$ as $\mathbf{v} = (v_1^1, \dots, v_{t_1}^1, \dots, v_1^n, \dots, v_{t_n}^n)$, and for $j < k$, we have the following notation:

$$(107) \quad \Delta_{j,k}^i(\mathbf{v}) := \sum_{h=j}^{k-1} v_h^i.$$

In particular, $\Delta_{j,j+1}^i(\mathbf{v}) = v_j^i$.

Definition 4.35. Given a rooted plane tree \mathcal{T} of depth n and a vector in $\mathbf{v} \in \mathcal{F}(\mathcal{T})$, we define a collection of extended collisions $\Xi(\mathbf{v})$ associated to \mathbf{v} . This set is the union of two other sets $\Xi_1(\mathbf{v})$ and $\Xi_2(\mathbf{v})$. Let \mathcal{B} be the $(n-1)$ -bracketing in $\mathcal{K}(\pi(\mathcal{T}))$ such that $\ell_{\mathcal{B}} = \Gamma^{-1}(\pi(\mathbf{v}))$ ²⁰. To simplify notation, let $\ell = \ell_{\mathcal{B}}$. Given an $(n-1)$ -bracket $A \in \mathcal{B}^{n-1}$, we define

$$(108) \quad \gamma(\ell, A) := \sum_{\substack{A' \in \mathcal{B}^{n-1} \\ A \subsetneq A'}} \ell(A').$$

Let $\mathcal{C} \in \widehat{\mathcal{X}}(\mathcal{T})$ then

- (1) $\mathcal{C} \in \Xi_1(\mathbf{v})$ if
 - (a) \mathcal{C} is type 1, with unique nontrivial n -bracket A .
 - (b) There exists some real number $w(\mathbf{v}, \mathcal{C})$ with $w(\mathbf{v}, \mathcal{C}) > \gamma(\ell, \pi(A))$ such that if $u_j^n, u_k^n \in A^n$ with $j < k$, then $\Delta_{j,k}^n(\mathbf{v}) = w(\mathbf{v}, \mathcal{C})(k-j)$.
 - (c) For any n -bracket A' with $A \subsetneq A'$ and $\pi(A') = \pi(A)$, there exists $u_j^n \in A'^n$ with $v_j^n < w(\mathbf{v}, \mathcal{C})$.
- (2) $\mathcal{C} \in \Xi_2(\mathbf{v})$ if
 - (a) \mathcal{C} is not type 1.
 - (b) There exists no $\mathcal{C}' \in \Xi_1(\mathbf{v})$ such that $\mathcal{C}' \rightarrow \mathcal{C}$.
 - (c) $\pi(\mathcal{C})$ is containment-minimal in \mathcal{B} .
 - (d) Let $A \in \mathcal{C}^{n-1}$, and $u_j^n, u_k^n \in V^n(\mathcal{T})$ with $j < k$ and $\pi(u_j^n), \pi(u_k^n) \in A$.
 - (i) If $\Delta_{j,k}^n(\mathbf{v}) = \gamma(\ell, A)(k-j)$, there exists $\tilde{A} \in \mathcal{C}^n$ such that $\pi(\tilde{A}) = A$ with $u_j^n, u_k^n \in \tilde{A}^n$.

²⁰ The existence of $\ell_{\mathcal{B}}$ is afforded by Proposition 4.11 combined with our inductive hypothesis that 4.13 holds for all $(n-1)$ -associahedra.

- (ii) If $\Delta_{j,k}^n(\mathbf{v}) > \gamma(\ell, A)(k - j)$, there exists $A_1, A_2 \in \mathcal{C}^n$ such that $\pi(A_1) = \pi(A_2) = A$, $A_2 <_{\mathcal{C}} A_1$ in the height partial order for \mathcal{C} , and $u_j^n \in A_1^n$, $u_k^n \in A_2^n$.
- (iii) If $\Delta_{j,k}^n(\mathbf{v}) < \gamma(\ell, A)(k - j)$, there exists $A_1, A_2 \in \mathcal{C}^n$ such that $\pi(A_1) = \pi(A_2) = A$, $A_1 <_{\mathcal{C}} A_2$ in the height partial order for \mathcal{C} , and $u_j^n \in A_1^n$, $u_k^n \in A_2^n$.

We define

$$(109) \quad \Xi(\mathbf{v}) := \Xi_1(\mathbf{v}) \cup \Xi_2(\mathbf{v}).$$

△

Lemma 4.36. *Let $\mathcal{C}_i \in \widehat{\mathfrak{X}}(\mathcal{T})$ for $0 \leq i \leq k$ with $\mathcal{C}_0 = \mathcal{B}_{\min}$. Let $\lambda_i \in \mathbb{R}$ with $\lambda_i > 0$ for $i > 0$. Suppose that the \mathcal{C}_i are compatible and let*

$$(110) \quad \ell_{\widetilde{\mathcal{B}}} = \sum_{i=1}^k \lambda_i \ell(\mathcal{C}_i).$$

For $\mathbf{v} = \sum_{i=1}^k \lambda_i \rho(\mathcal{C}_i)$ and $\mathcal{C} \in \widehat{\mathfrak{X}}(\mathcal{T})$, we have that \mathcal{C} is containment-minimal in $\widetilde{\mathcal{B}}$ if and only if $\mathcal{C} \in \Xi(\mathbf{v})$.

Proof. (4.34) By Lemma 4.36 we may take $\mathcal{C}_{\mathbf{v}}$ to be any collision in $\Xi(\mathbf{v})$ and observe that $\Xi(\mathbf{v}) = \emptyset$ if and only if $\mathbf{v} = 0$. □

Remark 4.37. Let $M(\widetilde{\mathcal{B}})$ denote the collection of extended collisions which are containment-minimal in $\widetilde{\mathcal{B}}$. For proving Lemma 4.16 we will only need the “if” direction of the statement of Lemma 4.36 ($\mathcal{C} \in \Xi(\mathbf{v}) \Rightarrow \mathcal{C} \in M(\widetilde{\mathcal{B}})$), but this part of the argument naturally builds on the “only if” direction ($\mathcal{C} \in M(\widetilde{\mathcal{B}}) \Rightarrow \mathcal{C} \in \Xi(\mathbf{v})$). △

Proof. (4.36) Let $\mathcal{C} \in \widehat{\mathfrak{X}}(\mathcal{T})$. Recall that Scholium 2.57 clarifies that \mathcal{C} is containment-minimal in $\widetilde{\mathcal{B}}$ if and only if for each i , either $\mathcal{C} \rightarrow \mathcal{C}_i$ or $\mathcal{C} \sim \mathcal{C}_i$. We let $\mathcal{B} = \pi(\widetilde{\mathcal{B}})$ and $\ell = \ell_{\mathcal{B}}$ aligning our notation with that of Definition 4.35.

Suppose that \mathcal{C} is containment-minimal in $\widetilde{\mathcal{B}}$ and that \mathcal{C} is type 1 with unique nontrivial bracket $A \in \mathcal{C}^n$ (condition (1a)). We wish to show that \mathcal{C} satisfies conditions (1b) and (1c). Observe that because \mathcal{C} is containment-minimal in $\widetilde{\mathcal{B}}$, and \mathcal{C} is type 1, we must have that $\mathcal{C} = \mathcal{C}_j$ for some j . Let $R \subseteq \{\mathcal{C}_i\}$ be the set of extended collisions such that $\mathcal{C} \rightarrow \mathcal{C}_i$, and let $S \subseteq R$ be those \mathcal{C}_i in R which are not type 1. We claim that $\gamma(\ell, \pi(A)) = \sum_{\mathcal{C}_i \in S} \lambda_i$. The n -bracketing condition (NESTED) and Lemma 2.32 (2) combined imply that for each $\mathcal{C}_i \in S$ there exists a unique nonsingleton $(n - 1)$ -bracket $A' \in \mathcal{C}_i^{n-1}$ with $\pi(A) \subsetneq A'$. In the other direction, if A' is a nonsingleton $(n - 1)$ -bracket with $A' \in \mathcal{B}^{n-1}$ and $\pi(A) \subsetneq A'$, it follows from Lemma 2.38 and Scholium 2.59 that there exists some $\mathcal{C}_i \in S$ such that $A' \in \mathcal{C}_i^{n-1}$. Because \mathcal{C} is containment-minimal in $\widetilde{\mathcal{B}}$, and $\pi(\mathcal{C}) \subseteq A'$, we know that \mathcal{C} and \mathcal{C}_i are not disjoint, hence it must be that $\mathcal{C} \rightarrow \mathcal{C}_i$. The claim follows.

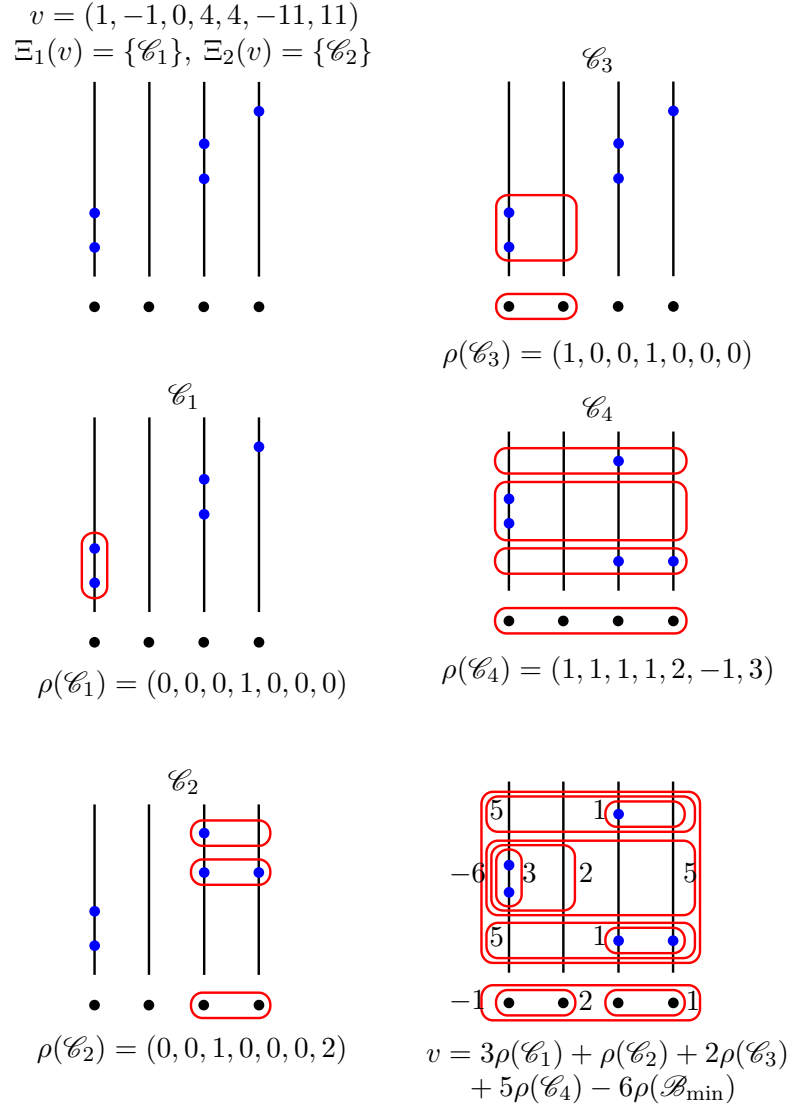

FIGURE 23. In the left column, we have depicted an arrangement for a 2-associahedron, a vector $\mathbf{v} \in \mathbb{R}^7$, and the sets $\Xi_1(\mathbf{v})$ and $\Xi_2(\mathbf{v})$. In the right column, we have depicted an expression of \mathbf{v} as a point in $\mathcal{F}(\mathcal{T})$ and the metric n -bracketing $\ell_{\mathcal{B}}$ such that $\Gamma(\ell_{\mathcal{B}}) = \mathbf{v}$.

Let $u_j^n, u_k^n \in A$ with $j < k$, and let $w(\mathbf{v}, \mathcal{C}) = \sum_{\mathcal{C}_i \in R} \lambda_i$. Because $\mathcal{C} \in R \setminus S$, we have that $w(\mathbf{v}, \mathcal{C}) > \gamma(\ell, \pi(A))$. Lemma 4.9 states that if $\mathcal{C} \rightarrow \mathcal{C}_i$ then $\Delta_{j,k}^n(\rho(\mathcal{C}_i)) = k-j$, and if $\mathcal{C}_i \sim \mathcal{C}$ then $\Delta_{j,k}^n(\rho(\mathcal{C}_i)) = 0$. Thus $\Delta_{j,k}^n(\mathbf{v}) = w(\mathbf{v}, \mathcal{C})(k-j)$ establishing condition (1b). Let A' be an n -bracket with $A \subsetneq A'$ and $\pi(A) = \pi(A')$. Suppose there exists $u_j^n, u_{j+1}^n \in A'^n$ with $u_j^n \in A^n$, and $u_{j+1}^n \in A'^n \setminus A^n$. Let $Q \subseteq \{\mathcal{C}_i\}$ be the collection of extended collisions which are either equal to \mathcal{B}_{\min} or have a

nontrivial n -bracket $\tilde{A} \in \mathcal{C}_i$ such that $u_j^n, u_{j+1}^n \in \tilde{A}$. It follows by the n -bracketing condition (NESTED) and the containment-minimality of \mathcal{C} that $Q \subseteq R$. For each \mathcal{C}_i we have that $\rho(\mathcal{C})_j^n$ is an integer at most 1, and is equal to 1 if and only if $\mathcal{C}_i \in Q$, hence $v_j^n \leq \sum_{\mathcal{C}_i \in Q} \lambda_i$. Because $\mathcal{C} \in R \setminus Q$, we have $\sum_{\mathcal{C}_i \in Q} \lambda_i < w(\mathbf{v}, \mathcal{C})$ implying $v_j^n < w(\mathbf{v}, \mathcal{C})$ (condition (1c)). The case where $u_j^n \in A^n$ and $u_{j-1}^n \in \tilde{A} \setminus A$ is similar.

Conversely, suppose that \mathcal{C} satisfies conditions (1), but \mathcal{C} is not containment-minimal in $\tilde{\mathcal{B}}$. Either \mathcal{C} is not compatible with $\tilde{\mathcal{B}}$, or \mathcal{C} is compatible with $\tilde{\mathcal{B}}$ but not containment-minimal in $\tilde{\mathcal{B}}$. Suppose first that \mathcal{C} is compatible with $\tilde{\mathcal{B}}$, but not containment-minimal in $\tilde{\mathcal{B}}$. In what follows, for \mathcal{C}_i a type 1 collision, we will take A_i to be the fusion bracket for \mathcal{C}_i , i.e. the unique nontrivial n -bracket in \mathcal{C}_i . Let \mathcal{C}_i be a type 1 collision which is containment-minimal in $\tilde{\mathcal{B}}$ with $\mathcal{C}_i \rightarrow \mathcal{C}$. By the “only if” direction above, we know that \mathcal{C}_i satisfies the conditions in (1). Let $w(\mathbf{v}, \mathcal{C}_i)$ be the constant in condition (1b) for \mathcal{C}_i . Suppose there exist vertices $u_{j-1}^n, u_j^n, u_{j+1}^n \in A^n$ with $u_{j+1}^n \in A^n \setminus A_i^n$. Take A' to be the n -bracket obtained from A_i by adding u_{j+1}^n to A_i^n . Then condition (1c) for \mathcal{C}_i with A' as described implies that $v_j^n < v_{j-1}^n = w(\mathbf{v}, \mathcal{C}_i)$. On the other hand, condition (1b) for \mathcal{C} implies that $v_j^n = v_{j-1}^n = w(\mathbf{v}, \mathcal{C})$, a contradiction. The case where $u_{j-1}^n, u_j^n, u_{j+1}^n \in A^n$ with $u_{j-1}^n \in A^n \setminus A_i^n$ is similar. Therefore we may assume that \mathcal{C} is not compatible with $\tilde{\mathcal{B}}$. We claim that there exists some type 1 collision \mathcal{C}_i such that \mathcal{C} and \mathcal{C}_i are not compatible. Because there exist $u_j^n, u_k^n \in A^n$ such that $\Delta_{j,k}^n(\mathbf{v}) = w(\mathbf{v}, \mathcal{C})(k-j)$ and $w(\mathbf{v}, \mathcal{C}) > \gamma(\ell, A)$, the argumentation of the “only if” direction above implies there must exist some type 1 collision \mathcal{C}_i with $u_j^n, u_k^n \in A_i^n$. If \mathcal{C}_i is not compatible with \mathcal{C} , the claim is verified. Assume instead $\mathcal{C}_i \rightarrow \mathcal{C}$, then there exists some $\mathcal{C}_j \rightarrow \mathcal{C}_i$ with \mathcal{C}_j containment-minimal in $\tilde{\mathcal{B}}$. We see that $\mathcal{C}_j \rightarrow \mathcal{C}$, but this situation was excluded previously.

Suppose instead that $\mathcal{C} \rightarrow \mathcal{C}_i$. If there exists some $\mathcal{C}_j \rightarrow \mathcal{C}_i$, such that \mathcal{C}_j and \mathcal{C} are not compatible, we have verified the claim, so we may assume that for each \mathcal{C}_j with $\mathcal{C}_j \rightarrow \mathcal{C}_i$, we have \mathcal{C}_j and \mathcal{C} are compatible. But, this implies that \mathcal{C} and $\tilde{\mathcal{B}}$ are compatible as any other collision \mathcal{C}_j which is not compatible with \mathcal{C} would also need to contain \mathcal{C}_i , and this is impossible, hence the claim is also verified.

Now take \mathcal{C}_i type 1 such that \mathcal{C} and \mathcal{C}_i are not compatible. Suppose there exist some vertices $u_{j-1}^n, u_j^n, u_{j+1}^n$ with $u_{j-1}^n \in A^n \setminus A_i^n$, $u_j^n \in A_i^n \cap A^n$ and $u_{j+1}^n \in A_i^n$. Let $U \subseteq \{\mathcal{C}_i\}$ be the extended collisions which are equal to \mathcal{B}_{\min} or contain a nontrivial n -bracket \tilde{A} with $\{u_{j-1}^n, u_j^n\} \in \tilde{A}^n$, and let $W \subseteq \{\mathcal{C}_i\}$ be the extended collisions which are equal to \mathcal{B}_{\min} or contain a nontrivial n -bracket \tilde{A} with $\{u_j^n, u_{j+1}^n\} \in \tilde{A}^n$. Because $u_j^n, u_{j+1}^n \in A_i^n$ and $u_{j-1}^n \notin A_i^n$, the condition (NESTED) for n -bracketings implies that $U \subsetneq W$. Again applying Lemma 4.9, we calculate $v_{j-1}^n \leq \sum_{\mathcal{C}_i \in U} \lambda_i$ and $v_j^n = \sum_{\mathcal{C}_i \in W} \lambda_i$. It follows that $v_{j-1}^n < v_j^n$. If $u_{j+1}^n \in A^n$, the inequality $v_{j-1}^n < v_j^n$ violates condition (1b) for \mathcal{C} . If $u_{j+1}^n \notin A^n$, the inequality $v_{j-1}^n < v_j^n$ violates condition (1c) for \mathcal{C} , with A' taken to be the n -bracket obtained from A by adding u_{j+1}^n to A^n . The remaining case where there exist vertices $u_{j-1}^n, u_j^n, u_{j+1}^n$

with $u_{j+1}^n \in A^n \setminus A_i^n$, $u_j^n \in A_i^n \cap A^n$, and $u_{j-1}^n \in A_i^n$ is similar. We conclude that \mathcal{C} is containment-minimal in $\tilde{\mathcal{B}}$.

Next, suppose that \mathcal{C} is containment-minimal in $\tilde{\mathcal{B}}$ and \mathcal{C} is not type 1 (condition (2a)). We will show that \mathcal{C} satisfies conditions (2b), (2c), and (2d). By containment-minimality, there exists no $\mathcal{C}' \in \Xi_1(\mathbf{v})$ such that $\mathcal{C}' \rightarrow \mathcal{C}$, which is condition (2b). Condition (2c) follows from Lemma 2.61.

Let $A \in \mathcal{C}^{n-1}$ and $u_j^n, u_k^n \in V^n(\mathcal{T})$ with $j < k$ such that $\pi(u_j^n), \pi(u_k^n) \in A$. Suppose that $\mathcal{C} \rightarrow \mathcal{C}_i$. By containment-minimality of \mathcal{C} , if there exists $\tilde{A} \in \mathcal{C}^n$ such that $\pi(\tilde{A}) = A$ with $u_j^n, u_k^n \in \tilde{A}^n$, then for any $A_i \in \mathcal{C}_i^n$ with $u_j^n \in A_i$, we have $u_k^n \in A_i$. On the other hand, suppose there exists $A, A' \in \mathcal{C}^n$ such that $\pi(A) = \pi(A')$ with $u_j^n \in A^n$, $u_k^n \in (A')^n$, and $A' <_{\mathcal{C}} A$. Let $A_i, A'_i \in \mathcal{C}_i^n$ such that $A \subseteq A_i$ and $A' \subseteq A'_i$. By condition (HEIGHT PARTIAL ORDERS) of an n -bracketing, either $A'_i <_{\mathcal{C}_i} A_i$ or $A_i = A'_i$. A symmetric implication holds: if $A' >_{\mathcal{C}} A$, then $A'_i >_{\mathcal{C}_i} A_i$ or $A_i = A'_i$. Combining these observations with Lemma 4.9, we have the following implications:

- If $\Delta_{j,k}^n(\rho(\mathcal{C})) = k - j$ then $\Delta_{j,k}^n(\rho(\mathcal{C}_i)) = k - j$.
- If $\Delta_{j,k}^n(\rho(\mathcal{C})) > k - j$ then $\Delta_{j,k}^n(\rho(\mathcal{C}_i)) \geq k - j$.
- If $\Delta_{j,k}^n(\rho(\mathcal{C})) < k - j$ then $\Delta_{j,k}^n(\rho(\mathcal{C}_i)) \leq k - j$.

By Lemma 4.9, $\Delta_{j,k}^n(\rho(\mathcal{C}_i)) = 0$ if $\mathcal{C} \sim \mathcal{C}_i$. Thus, letting $R \subseteq \{\mathcal{C}_i\}$ be the set of extended collisions with $\mathcal{C} \rightarrow \mathcal{C}_i$, we know that $\Delta_{j,k}^n(\mathbf{v}) = \sum_{\mathcal{C}_i \in R} \lambda_i \Delta_{j,k}^n(\rho(\mathcal{C}_i))$ and $\gamma(\ell, A) = \sum_{\mathcal{C}_i \in R} \lambda_i$. Therefore

- If $\Delta_{j,k}^n(\mathbf{v}) = \gamma(\ell, A)(k - j)$ then $\Delta_{j,k}^n(\rho(\mathcal{C})) = k - j$.
- If $\Delta_{j,k}^n(\mathbf{v}) > \gamma(\ell, A)(k - j)$ then $\Delta_{j,k}^n(\rho(\mathcal{C})) > k - j$.
- If $\Delta_{j,k}^n(\mathbf{v}) < \gamma(\ell, A)(k - j)$ then $\Delta_{j,k}^n(\rho(\mathcal{C})) < k - j$.

Condition (2d) now follows by reinterpreting these implications using Lemma 4.9.

Conversely, suppose that \mathcal{C} satisfies the conditions of (2). We wish to prove that \mathcal{C} is containment-minimal in $\tilde{\mathcal{B}}$. By Scholium 2.59 combined with Lemma 2.63, there exists some $\mathcal{C}' \in \tilde{\mathcal{X}}(\mathcal{T})$ which is containment-minimal in $\tilde{\mathcal{B}}$, and $\pi(\mathcal{C}') \rightarrow \pi(\mathcal{C})$ or \mathcal{C}' is type 1. We will demonstrate that $\mathcal{C} = \mathcal{C}'$. By condition (2b) for \mathcal{C} , we know that \mathcal{C}' is not type 1. By Lemma 2.61, $\pi(\mathcal{C}')$ is containment-minimal in $\pi(\tilde{\mathcal{B}})$. Combined with condition (2b) for \mathcal{C} and the fact that $\pi(\mathcal{C}') \rightarrow \pi(\mathcal{C})$, we conclude that $\pi(\mathcal{C}') = \pi(\mathcal{C})$.

By the ‘‘only if’’ direction verified above, we know that \mathcal{C}' also satisfies the conditions of (2). We claim that the conditions (2d) determine \mathcal{C} uniquely, implying $\mathcal{C} = \mathcal{C}'$. Indeed, we can use condition (2d)i) to determine the n -brackets in \mathcal{C}' , and we can use conditions (2d)ii) and (2d)iii) to determine the height partial order on these n -brackets. \square

4.5. The velocity fan is a fan.

We are now ready to prove Theorem 4.15, which has been reduced to Proposition 4.16.

Proof. (4.16) We will first prove that (54) \Rightarrow (55). Let

$$(111) \quad \ell_{\mathcal{B}} = \sum_{i=0}^k \lambda_i \ell(\mathcal{C}_i) = \sum_{i=0}^l \gamma_i \ell(\mathcal{C}'_i),$$

and set $\mathbf{u} = \sum_{i=0}^k \lambda_i \rho(\mathcal{C}_i)$ and $\mathbf{v} = \sum_{i=0}^l \gamma_i \rho(\mathcal{C}'_i)$. We will show that $\mathbf{u} = \mathbf{v}$.

By Lemmas 3.48 and 3.49, it suffices to prove (54) \Rightarrow (55) when $\ell_{\mathcal{B}}$ has a single fusion bracket A . Let \mathcal{C} be a containment minimal collision in \mathcal{B} and take σ to be a compatible shuffle for \mathcal{C} . For each i , we know that $\mathcal{C} \approx \mathcal{C}_i$, as they have the same fusion bracket, hence $\mathcal{C} \rightarrow \mathcal{C}_i$. By Lemma 4.30, σ is a compatible shuffle for each \mathcal{C}_i . Let

$$(112) \quad \sigma(\mathbf{u}) = \sum_{i=0}^l \gamma_i (P_{\sigma}^T(\rho(\mathcal{C}_i) - \mathbf{1}) + \mathbf{1}),$$

$$(113) \quad \sigma(\mathbf{v}) = \sum_{i=0}^k \lambda_i (P_{\sigma}^T(\rho(\mathcal{C}'_i) - \mathbf{1}) + \mathbf{1}).$$

We remark that $\sigma(\mathbf{u})$ is, *a priori*, not determined by \mathbf{u} alone; it is determined by the given expression for \mathbf{u} . By Lemma 4.31, we have that for a particular index i , the coordinate $\sigma(\mathbf{v})_i^k$ is equal to

$$(114) \quad \sum_{\substack{A' \in \mathcal{B}^k \\ (A')^n \ni u_{\sigma(i)}^n, u_{\sigma(i+1)}^n}} \ell_{\mathcal{B}}(A').$$

This is an invariant of the metric n -bracketing $\ell_{\mathcal{B}}$. In particular, $\sigma(\mathbf{v}) = \sigma(\mathbf{u})$. Furthermore,

$$(115) \quad \sigma(\mathbf{v}) = P_{\sigma}^T\left(\sum_{i=0}^k \lambda_i \rho(\mathcal{C}'_i)\right) - P_{\sigma}^T\left(\sum_{i=0}^k \lambda_i \mathbf{1}\right) + \sum_{i=0}^k \lambda_i \mathbf{1}.$$

By Lemma 3.50, we have that $\sum_{i=0}^k \lambda_i = \sum_{i=0}^l \gamma_i = \ell_{\mathcal{B}}(A)$, hence

$$(116) \quad (P_{\sigma}^T)^{-1}(\sigma(\mathbf{v}) + P_{\sigma}^T(\ell_{\mathcal{B}}(A)\mathbf{1}) + \ell_{\mathcal{B}}(A)\mathbf{1}) = \mathbf{v}.$$

$$(117) \quad (P_{\sigma}^T)^{-1}(\sigma(\mathbf{u}) + P_{\sigma}^T(\ell_{\mathcal{B}}(A)\mathbf{1}) + \ell_{\mathcal{B}}(A)\mathbf{1}) = \mathbf{u}.$$

Because $\sigma(\mathbf{v}) = \sigma(\mathbf{u})$, it follows that $\mathbf{v} = \mathbf{u}$ as desired.

Next we will prove (55) \Rightarrow (54).

Let

$$(118) \quad \mathbf{v} = \sum_{i=1}^k \lambda_i \rho(\mathcal{C}_i) = \sum_{i=1}^l \gamma_i \rho(\mathcal{C}'_i),$$

$$(119) \quad \ell_{\mathcal{B}_1} = \sum_{i=0}^k \lambda_i \ell(\mathcal{C}_i) \quad \text{and} \quad \ell_{\mathcal{B}_2} = \sum_{i=1}^l \gamma_i \ell(\mathcal{C}'_i).$$

Given $\mathcal{B} \in \mathcal{K}(\mathcal{T})$, let $|\mathcal{B}| := \sum_{i=1}^n |\mathcal{B}^k|$. We proceed by induction on $|\mathcal{B}_1| + |\mathcal{B}_2|$. By Lemma 4.34 we can always find an extended collision $\mathcal{C}_{\mathbf{v}}$, which is a function of \mathbf{v} alone, such that $\mathcal{C}_{\mathbf{v}}$ is containment-minimal in both \mathcal{B}_1 and \mathcal{B}_2 . Let $\epsilon > 0$ be the minimum value of $\ell_{\mathcal{B}_1}(A)$ and $\ell_{\mathcal{B}_2}(A)$, where A ranges over all nontrivial brackets in $\mathcal{C}_{\mathbf{v}}$. By Scholium 3.47 we know that there exist metric n -bracketings $\underline{\ell}_{\mathcal{B}_1}$ and $\underline{\ell}_{\mathcal{B}_2}$ with underlying n -bracketings $\underline{\mathcal{B}}_1$ and $\underline{\mathcal{B}}_2$, respectively, such that

$$(120) \quad \begin{aligned} \ell_{\underline{\mathcal{B}}_1} &= \ell_{\mathcal{B}_1} - \epsilon \ell(\mathcal{C}_{\mathbf{v}}), \\ \ell_{\underline{\mathcal{B}}_2} &= \ell_{\mathcal{B}_2} - \epsilon \ell(\mathcal{C}_{\mathbf{v}}). \end{aligned}$$

By Lemma 3.45 there exist extended collisions $\underline{\mathcal{C}}_0, \underline{\mathcal{C}}_1, \dots, \underline{\mathcal{C}}_r$ and $\underline{\mathcal{C}}'_0, \underline{\mathcal{C}}'_1, \dots, \underline{\mathcal{C}}'_s$ such that $\underline{\mathcal{C}}_0 = \underline{\mathcal{C}}'_0 = \mathcal{B}_{\min}$, and $\underline{\lambda}_i, \underline{\gamma}_i \in \mathbb{R}$ with $\underline{\lambda}_i, \underline{\gamma}_i \geq 0$ for $i > 0$ such that

$$(121) \quad \begin{aligned} \ell_{\underline{\mathcal{B}}_1} &= \sum_{i=1}^r \underline{\lambda}_i \ell(\underline{\mathcal{C}}_i), \\ \ell_{\underline{\mathcal{B}}_2} &= \sum_{i=1}^s \underline{\gamma}_i \ell(\underline{\mathcal{C}}'_i). \end{aligned}$$

Because $\ell_{\mathcal{B}_1} = \ell_{\underline{\mathcal{B}}_1} + \epsilon \ell(\mathcal{C}_{\mathbf{v}})$ and $\ell_{\mathcal{B}_2} = \ell_{\underline{\mathcal{B}}_2} + \epsilon \ell(\mathcal{C}_{\mathbf{v}})$, we know by (54) \Rightarrow (55), verified above, that

$$(122) \quad \mathbf{v} = \sum_{i=0}^k \lambda_i \rho(\mathcal{C}_i) = \sum_{i=0}^r \underline{\lambda}_i \rho(\underline{\mathcal{C}}_i) + \epsilon \rho(\mathcal{C}_{\mathbf{v}}),$$

and

$$(123) \quad \mathbf{v} = \sum_{i=0}^l \gamma_i \rho(\mathcal{C}'_i) = \sum_{i=0}^s \underline{\gamma}_i \rho(\underline{\mathcal{C}}'_i) + \epsilon \rho(\mathcal{C}_{\mathbf{v}}).$$

Thus we can take

$$(124) \quad \mathbf{v}' = \sum_{i=0}^r \underline{\lambda}_i \rho(\underline{\mathcal{C}}_i) = \sum_{i=0}^s \underline{\gamma}_i \rho(\underline{\mathcal{C}}'_i).$$

By our choices of ϵ , we have that

$$(125) \quad |\underline{\mathcal{B}}_1| + |\underline{\mathcal{B}}_2| < |\mathcal{B}_1| + |\mathcal{B}_2|.$$

By induction, we can conclude that $\ell_{\underline{\mathcal{B}}_1} = \ell_{\underline{\mathcal{B}}_2}$, hence $\ell_{\mathcal{B}_1} = \ell_{\mathcal{B}_2}$ as desired. \square

4.6. **The velocity fan is complete.**

In this subsection we prove that the velocity fan is complete²¹ by demonstrating that it has no boundary. We proceed by combinatorial analysis of n -bracketings.

Lemma 4.38. *Let \mathcal{T} be a rooted plane tree of depth n , and let $\mathcal{B} \in \mathcal{K}(\mathcal{T})$ be a nonmaximal n -bracketing. There exist $\mathcal{B}_1, \mathcal{B}_2 \in \mathcal{K}(\mathcal{T})$ with $\mathcal{B}_1 \neq \mathcal{B}_2$ such that $\mathcal{B} < \mathcal{B}_1$ and $\mathcal{B} < \mathcal{B}_2$.*

Proof. We proceed by induction on $|V(\mathcal{T})|$. Let $\mathcal{C} \in \widehat{\mathfrak{X}}(\mathcal{T})$ be containment-minimal in \mathcal{B} . If \mathcal{C} is a minimal collision, then there is an isomorphism of poset intervals $[\mathcal{B}, \star\tau] \subseteq \widehat{\mathcal{K}}(\mathcal{T})$ and $[\mathcal{B}/\mathcal{C}, \star\tau/\mathcal{C}] \subseteq \widehat{\mathcal{K}}(\mathcal{T}/\mathcal{C})$, and we can apply induction. If \mathcal{C} is not a minimal collision, by Lemma 2.65 we can find two distinct minimal collisions \mathcal{C}_1 and \mathcal{C}_2 such that $\mathcal{C}_1 \rightarrow \mathcal{C}$ and $\mathcal{C}_2 \rightarrow \mathcal{C}$. Thus we can let $\mathcal{B} \vee \mathcal{C}_1 = \mathcal{B}_1$ and $\mathcal{B} \vee \mathcal{C}_2 = \mathcal{B}_2$. \square

The following is standard.

Lemma 4.39. *Let \mathcal{F} be a fan in \mathbb{R}^m , then \mathcal{F} is complete if and only if \mathcal{F} has no boundary.*

This is equivalent to the following statement.

Lemma 4.40. *Let \mathcal{F} be a fan in \mathbb{R}^m , then \mathcal{F} is complete if and only if \mathcal{F} is full-dimensional and for each codimension 1 cone $\tau \in \mathcal{F}$ there exist full-dimensional cones $\tau_1, \tau_2 \in \mathcal{F}$ with $\tau_1 \neq \tau_2$ such that $\tau < \tau_1$ and $\tau < \tau_2$.*

Definition 4.41. A fan is *pure* if each maximal cone has the same dimension. \triangle

Lemma 4.42. *The velocity fan $\mathcal{F}(\mathcal{T})$ is a full-dimensional pure fan in \mathbb{R}^m .*

Proof. We must prove that each maximal cone in $\mathcal{F}(\mathcal{T})$ has dimension m . From Theorem 4.15, it follows that $\mathcal{K}(\mathcal{T})$ is a ranked poset. Let $\text{rk}(\mathcal{B})$ denote the rank of $\mathcal{B} \in \mathcal{K}(\mathcal{T})$. We have that $\text{rk}(\mathcal{B}) = \dim(\tau(\mathcal{B})) - 1$, with the -1 accounting for the lineality space. Thus, it suffices to prove that any maximal n -bracketing $\mathcal{B} \in \mathcal{K}(\mathcal{T})$ has $\text{rk}(\mathcal{B}) = m - 1$. We proceed by induction on m . For $m = 1$, the statement is clear, so we assume $m > 1$. Next, let $\mathcal{B} \in \mathcal{K}(\mathcal{T})$ be a maximal n -bracketing, and observe that because $m > 1$ there must exist some $\mathcal{C} \in \mathfrak{X}(\mathcal{T})$ with $\mathcal{C} \leq \mathcal{B}$. Let $\mathcal{C} \in \mathfrak{X}(\mathcal{T})$ be containment-minimal in \mathcal{B} . We know that \mathcal{C} is a minimal collision, otherwise we would have some $\mathcal{C}' \in \mathfrak{X}(\mathcal{T})$ with $\mathcal{C}' \neq \mathcal{C}$, $\mathcal{C}' \rightarrow \mathcal{C}$, and $\mathcal{B} \vee \mathcal{C}' > \mathcal{B}$, contradicting maximality of \mathcal{B} . As described in Definition 2.49, $\mathcal{B}/\mathcal{C} \in \mathcal{K}(\mathcal{T}/\mathcal{C})$ and it is clear that $[\mathcal{C}, \mathcal{B}] \cong [\mathcal{B}_{\min}, \mathcal{B}/\mathcal{C}]$. Moreover, \mathcal{B}/\mathcal{C} is maximal in $\mathcal{K}(\mathcal{T}/\mathcal{C})$, otherwise if we had some $\mathcal{B}' > \mathcal{B}/\mathcal{C}$ we would be able to lift \mathcal{B}' to some $\widetilde{\mathcal{B}} \in \mathcal{K}(\mathcal{T})$ such that $\widetilde{\mathcal{B}} > \mathcal{B}$, e.g. by taking the joins of the preimages of the collisions less than \mathcal{B}' afforded by Lemma 2.67. As \mathcal{C} is a minimal collision, it satisfies the conditions of Lemma 2.65, therefore $|V(\mathcal{T}/\mathcal{C})| = |V(\mathcal{T})| - 1$. It follows by induction that $\text{rk}(\mathcal{B}/\mathcal{C}) = m - 2$, and $\text{rk}(\mathcal{C}) = 1$, hence $\text{rk}(\mathcal{B}) = (m - 2) + 1 = m - 1$. \square

²¹For this section, we take *complete* to mean having support all of \mathbb{R}^m .

Theorem 4.43. *The velocity fan $\mathcal{F}(\mathcal{T})$ is complete.*

Proof. We will verify the conditions of Lemma 4.40. By Lemma 4.42, we know that $\mathcal{F}(\mathcal{T})$ is full-dimensional, thus the set of all codimension 1 cones in $\mathcal{F}(\mathcal{T})$ is nonempty; we can take a facet of a full-dimensional cone. Let $\tau(\mathcal{B})$ be a codimension 1 cone in $\mathcal{F}(\mathcal{T})$. By Lemma 4.42, we know that \mathcal{B} is not maximal. By Lemma 4.38, there exists maximal n -bracketings \mathcal{B}_1 and \mathcal{B}_2 such that $\mathcal{B} < \mathcal{B}_1$ and $\mathcal{B} < \mathcal{B}_2$. Thus we can take $\tau_1 = \tau(\mathcal{B}_1)$ and $\tau_2 = \tau(\mathcal{B}_2)$. \square

5. TRIANGULATING n -ASSOCIAHEDRA

The velocity fan is not smooth, it is not even simplicial. In this section we describe a canonical smooth flag triangulation of the reduced velocity fan on the same set of rays. In the special case of the associahedron this triangulation is trivial; it agrees with the wonderful associahedral fan which is already simplicial. For concentrated n -associahedra such as the multiplihedron, this triangulation is a nestohedral fan (this will be elaborated upon in §8). In §6.3 we describe a general connection between our triangulation and nestohedra for all n -associahedra. We apply the triangulated velocity fan as a tool for giving a recursive calculation of the normal vectors for the walls of the velocity fan, and for proving the unimodularity of the map Γ . Additionally, we introduce a second, finer triangulation which generalizes the braid arrangement viewed as a triangulation of the wonderful associahedral fan.

5.1. Nested collisions and triangulated n -associahedra.

We begin by describing an abstract simplicial complex $\Delta_{\mathcal{T}}$ on the set of collisions $\mathfrak{X}(\mathcal{T})$. We will eventually show that this simplicial complex induces a smooth flag triangulation of the reduced velocity fan. Recall Definitions 2.50 and 2.52.

Definition 5.1. Let $\{\mathcal{C}_i : 1 \leq i \leq k\}$ be a collection of collisions. Suppose that for all $1 \leq i < j \leq k$ either

- (1) $\mathcal{C}_i \sim \mathcal{C}_j$ or
- (2) $\mathcal{C}_i \rightarrow \mathcal{C}_j$,

then we say that the collection $\{\mathcal{C}_i\}$ is *nested*. \triangle

Lemma 5.2. *Let $\{\mathcal{C}_i : 1 \leq i \leq k\}$ be a nested collection of extended collisions, then they are a compatible collection of collisions.*

Proof. This is a special case of Lemma 2.25 which says that if a collection of collisions are pairwise compatible, then they are compatible. \square

Definition 5.3. Let V be a finite set. An abstract simplicial complex Δ on V is a collection of subsets of V which contains all singletons of V and for any $Y \in \Delta$ and $Y' \subseteq Y$, then $Y' \in \Delta$. \triangle

Definition 5.4. Given a rooted plane tree \mathcal{T} of depth n , we define the *triangulated n -associahedron* $\Delta_{\mathcal{T}}$ to be the abstract simplicial complex whose faces are the nested collections of collisions. \triangle

Remark 5.5. Note that a nested collection of collisions may have more than one order for which it satisfies the conditions of Definition 5.1, but this collection only determines a single face of $\Delta_{\mathcal{T}}$. \triangle

We have a natural surjective poset morphism $\Omega : \Delta_{\mathcal{T}} \rightarrow \mathcal{K}(\mathcal{T})$. For $Y \in \Delta_{\mathcal{T}}$, we let

$$(126) \quad \Omega(Y) = \bigvee_{\mathcal{C} \in Y} \mathcal{C}.$$

We now use the triangulated n -associahedra to define triangulations of the reduced n -bracketing complex and the reduced velocity fan.

Definition 5.6. Given $Y \in \Delta_{\mathcal{T}}$, let

$$(127) \quad \tau^{\text{met}}(Y) = \text{cone}\{\ell(\mathcal{C}) : \mathcal{C} \in Y\} + \langle \ell(\mathcal{B}_{\min}) \rangle_{\mathbb{R}}.$$

The *triangulated n -bracketing complex* is the collection of conical sets

$$(128) \quad \mathcal{K}^{\text{met}}(\Delta_{\mathcal{T}}) = \{\tau^{\text{met}}(Y) : Y \in \Delta_{\mathcal{T}}\}.$$

The *reduced triangulated n -bracketing complex* is the quotient

$$(129) \quad \overline{\mathcal{K}}^{\text{met}}(\Delta_{\mathcal{T}}) = \{\tau^{\text{met}}(Y) / \langle \ell(\mathcal{B}_{\min}) \rangle_{\mathbb{R}} : Y \in \Delta_{\mathcal{T}}\}.$$

\triangle

Definition 5.7. Given $Y \in \Delta_{\mathcal{T}}$, let

$$(130) \quad \tau(Y) = \text{cone}\{\rho(\mathcal{C}) : \mathcal{C} \in Y\} + \langle \mathbf{1} \rangle_{\mathbb{R}}.$$

The *triangulated velocity fan*²² is the collection of cones

$$(131) \quad \mathcal{F}(\Delta_{\mathcal{T}}) = \{\tau(Y) : Y \in \Delta_{\mathcal{T}}\}.$$

The *reduced triangulated velocity fan* is the image of the triangulated velocity fan in tropical projective space

$$(132) \quad \overline{\mathcal{F}}(\Delta_{\mathcal{T}}) = \{\tau(Y) / \langle \mathbf{1} \rangle_{\mathbb{R}} : Y \in \Delta_{\mathcal{T}}\}.$$

\triangle

Definition 5.8. Given a simplicial fan \mathcal{F} we can associate an abstract simplicial complex $\Delta(\mathcal{F})$ with vertices corresponding to the rays of \mathcal{F} and a face $Y \in \Delta(\mathcal{F})$ if the corresponding rays generate a cone in \mathcal{F} . \triangle

Definition 5.9. An abstract simplicial complex Δ is a *flag simplicial complex* if for every set of vertices $Y \subseteq V$ such that for any $u_1, u_2 \in Y$, $\{u_1, u_2\} \in \Delta$, we have $Y \in \Delta$. \triangle

Definition 5.10. A simplicial fan \mathcal{F} is flag if its associated simplicial complex is flag. \triangle

²²Our use of the word “triangulated” is a bit dubious as this fan has a non trivial lineality space and thus is not simplicial. On the other hand, the reduced triangulated velocity fan is simplicial.

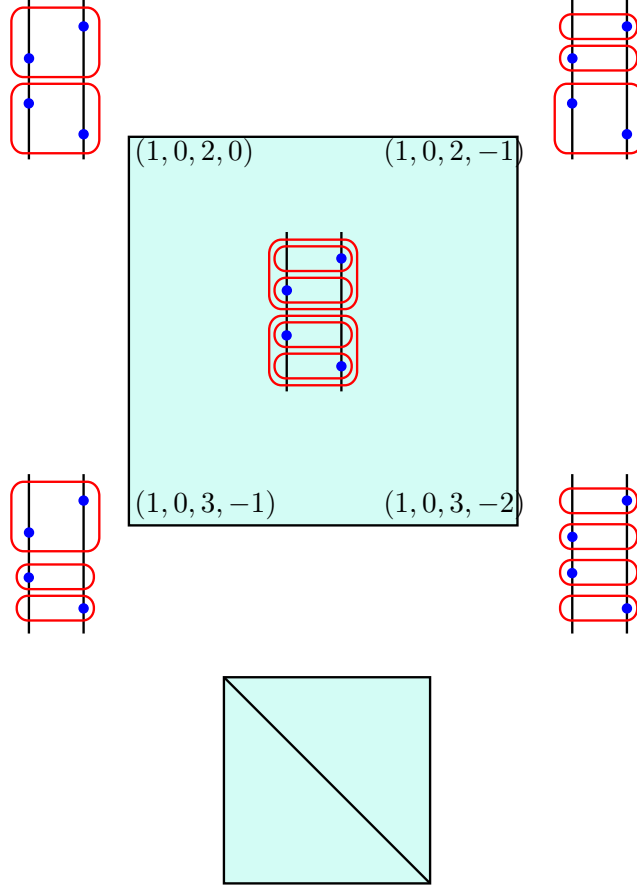

FIGURE 24. An example of a nonsimplicial chamber in a reduced velocity fan $\overline{\mathcal{F}}(\mathcal{T})$ (viewed from above) and its triangulation into two simplicial chambers in $\overline{\mathcal{F}}(\Delta_{\mathcal{T}})$.

Definition 5.11. Let N be a \mathbb{Z} -lattice. Let τ be a simplicial cone in $N \otimes \mathbb{R}$. We say that τ is *smooth* if there exist ray generators $\mathbf{v}^1, \dots, \mathbf{v}^k$ for τ such that $\mathbf{v}^1, \dots, \mathbf{v}^k$ can be extended to a basis $\mathbf{v}^1, \dots, \mathbf{v}^m$ for N . A fan \mathcal{F} in $N \otimes \mathbb{R}$ is *smooth* if each cone in \mathcal{F} is smooth. \triangle

The following is the main result of this section.

Theorem 5.12. *The reduced triangulated velocity fan $\overline{\mathcal{F}}(\Delta_{\mathcal{T}})$ is a canonical smooth flag triangulation of the reduced velocity fan $\overline{\mathcal{F}}(\mathcal{T})$ on the same set of rays.*

Our choice of the word *canonical* in Theorem 5.12 is intended to communicate that the definition of the triangulated velocity fan requires no input data beyond \mathcal{T} . We emphasize that $\overline{\mathcal{F}}(\Delta_{\mathcal{T}})$ and $\overline{\mathcal{F}}(\mathcal{T})$ have the same set of rays which, as we know, correspond to the collisions. At the level of toric varieties, this says that the toric

variety of $\overline{\mathcal{F}}(\Delta_{\mathcal{T}})$ defines a crepant resolution of singularities for the toric variety of $\overline{\mathcal{F}}(\mathcal{T})$. We note that a fan can only be considered simplicial, furthermore flag or smooth, if it is pointed, thus Theorem 5.12 would not make sense if stated for the nonreduced velocity and triangulated velocity fans.

5.2. The collision mixed graph.

In this section we establish that the the triangulated n -associahedron is flag by reinterpreting this simplicial complex as the clique complex of a graph. We note that the flagness of $\Delta_{\mathcal{T}}$ does not yet immediately follow from Lemma 2.25 because of the order required in Definition 5.1.

Definition 5.13. A *mixed graph* is a graph in which every edge is either directed or undirected. △

We will introduce a mixed graph on $\mathfrak{X}(\mathcal{T})$.

Definition 5.14. Given a rooted plane tree \mathcal{T} , we define the *collision mixed graph* $G_{\mathcal{T}}$ with vertex set $V(G_{\mathcal{T}}) = \mathfrak{X}(\mathcal{T})$. Let $\mathcal{C}_1, \mathcal{C}_2 \in \mathfrak{X}(\mathcal{T})$ with $\mathcal{C}_1 \neq \mathcal{C}_2$, then we have a directed edge $(\mathcal{C}_1, \mathcal{C}_2) \in E(G_{\mathcal{T}})$ if $\mathcal{C}_1 \rightarrow \mathcal{C}_2$ and an undirected edge $\{\mathcal{C}_1, \mathcal{C}_2\} \in E(G_{\mathcal{T}})$ if $\mathcal{C}_1 \sim \mathcal{C}_2$. △

Definition 5.15. Let $G_{\mathcal{T}}$ be the collision mixed graph associated to the rooted plane tree \mathcal{T} . We define the *undirected collision graph* to be the undirected graph, written $G_{\mathcal{T}}^{\circ}$, obtained from $G_{\mathcal{T}}$ by keeping the undirected edges, and replacing the directed edges with undirected edges. △

Definition 5.16. Let G be an undirected simple graph. The *clique complex* of G , denoted $\Delta(G)$, is the abstract simplicial complex with vertices indexed by vertices of G and a face for every complete subgraph, i.e. clique, in G . △

The following lemma is standard and straightforward to verify.

Lemma 5.17. *An abstract simplicial complex Δ is a flag simplicial complex if and only if there exists a graph G such that Δ is the clique complex of G .*

We will now investigate $\Delta(G_{\mathcal{T}}^{\circ})$.

Lemma 5.18. *The directed part of the collision mixed graph is transitive: if $\mathcal{C}_1, \mathcal{C}_2, \mathcal{C}_3 \in \widehat{\mathfrak{X}}(\mathcal{T})$ such that $\mathcal{C}_1 \rightarrow \mathcal{C}_2$ and $\mathcal{C}_2 \rightarrow \mathcal{C}_3$, then $\mathcal{C}_1 \rightarrow \mathcal{C}_3$.*

Proof. This is clear from Definition 2.50. □

Lemma 5.19. *The directed part of the collision mixed graph is acyclic.*

Proof. This is a corollary of Lemma 5.18 and the fact that it is impossible to have a pair of distinct collisions $\mathcal{C}, \mathcal{C}'$ such that $\mathcal{C} \rightarrow \mathcal{C}'$ and $\mathcal{C}' \rightarrow \mathcal{C}$. □

Proposition 5.20. *For a rooted plane tree \mathcal{T} , we have*

$$(133) \quad \Delta_{\mathcal{T}} = \Delta(G_{\mathcal{T}}^{\circ}),$$

hence $\Delta_{\mathcal{T}}$ is a flag simplicial complex.

Proof. For $Y \in \Delta_{\mathcal{T}}$, it is clear that $Y \in \Delta(G_{\mathcal{T}}^{\circ})$. For the reverse inclusion, let $Y \in \Delta(G_{\mathcal{T}}^{\circ})$. We wish to prove that there exists a total order on the collisions in Y so that they satisfy the conditions of being nested. By Lemmas 5.18 and 5.19 we may view the directed part of Y as the set of relations in a poset for which we can take a linear extension, and this linear extension is the desired total order. \square

5.3. Tree combinatorics of $\Delta_{\mathcal{T}}$.

In this section we will describe how the faces of $\Delta_{\mathcal{T}}$ (hence the conical sets in $\overline{\mathcal{K}}^{\text{met}}(\Delta_{\mathcal{T}})$, and the cones in $\overline{\mathcal{F}}(\Delta_{\mathcal{T}})$) can be identified with certain rooted trees. We remark that the main result of this section, Theorem 5.29, also follows from the results of §6.3 when combined with Postnikov's theory of \mathbb{B} -trees, although we find this approach awkwardly indirect, and unnecessarily local, as it must first pass through the ω_{σ} maps with σ varying over all \mathcal{T} -shuffles. Indeed the results of this subsection were obtained before the results of §6.3, and inspired the discovery of those results. We first define the extended collision mixed graph.

Definition 5.21. The *extended collision mixed graph* $\widehat{G}_{\mathcal{T}}$ is obtained from the collision mixed graph by adding a vertex corresponding to the minimum bracketing \mathcal{B}_{\min} with a directed edge $(\mathcal{C}, \mathcal{B}_{\min})$ for each $\mathcal{C} \in \mathfrak{X}(\mathcal{T})$. The *extended undirected collision graph* $\widehat{G}_{\mathcal{T}}^{\circ}$ is the undirected graph obtained from the extended collision mixed graph by undirecting the directed edges. The *extended triangulated n -associahedron* is defined as $\widehat{\Delta}_{\mathcal{T}} = \Delta(\widehat{G}_{\mathcal{T}}^{\circ})$.

Note that the above definition is consistent with our earlier definition that for each $\mathcal{C} \in \mathfrak{X}(\mathcal{T})$, $\mathcal{C} \rightarrow \mathcal{B}_{\min}$ and $\mathcal{C} \approx \mathcal{B}_{\min}$. The purpose of Definition 5.21 is that \mathcal{B}_{\min} will conveniently play the role of the root vertex for certain trees, which otherwise would be forests. This paradigm will be familiar to experts in associahedra, nestohedra, or nested set complexes.

Lemma 5.22. *Let $Y \in \widehat{\Delta}_{\mathcal{T}}$, and let $\mathcal{C}_1, \mathcal{C}_2, \mathcal{C}_3 \in Y$ such that $\mathcal{C}_1 \rightarrow \mathcal{C}_2$ and $\mathcal{C}_1 \rightarrow \mathcal{C}_3$, then either $\mathcal{C}_2 \rightarrow \mathcal{C}_3$ or $\mathcal{C}_3 \rightarrow \mathcal{C}_2$.*

Proof. Because $\mathcal{C}_2, \mathcal{C}_3 \in Y$, it must be that $\mathcal{C}_2 \sim \mathcal{C}_3$, $\mathcal{C}_2 \rightarrow \mathcal{C}_3$, or $\mathcal{C}_3 \rightarrow \mathcal{C}_2$. Because $\mathcal{C}_1 \rightarrow \mathcal{C}_2$ and $\mathcal{C}_1 \rightarrow \mathcal{C}_3$, it is not possible that $\mathcal{C}_2 \sim \mathcal{C}_3$, and the statement follows. \square

We will now discuss cover relations in faces of an extended triangulated n -associahedron.

Definition 5.23. Let $Y \in \widehat{\Delta}_{\mathcal{T}}$, and let $\mathcal{C}_1, \mathcal{C}_2 \in Y$ such that $(\mathcal{C}_1, \mathcal{C}_2)$ is a directed edge in the collision mixed graph. We say that \mathcal{C}_2 *covers* \mathcal{C}_1 in Y if there exists no $\mathcal{C}_3 \in Y$ for which there is a directed path $\mathcal{C}_1 \rightarrow \mathcal{C}_3 \rightarrow \mathcal{C}_2$ in Y . \triangle

Lemma 5.24. *Let Y be a maximal simplex in $\widehat{\Delta}_{\mathcal{T}}$, then for any collision $\mathcal{C} \in Y$, there are at most two collisions in Y which are covered by \mathcal{C} in Y .*

Proof. Let $\{\mathcal{C}_i : 1 \leq i \leq s\}$ be an enumeration of all of the collisions in Y which are covered by \mathcal{C} in Y . Suppose that $s \geq 2$. It is not possible to have \mathcal{C}_i and \mathcal{C}_j such

that, without loss of generality, $\mathcal{C}_i \rightarrow \mathcal{C}_j$, as \mathcal{C} would not cover \mathcal{C}_i , so it must be that $\mathcal{C}_i \sim \mathcal{C}_j$ for all $1 \leq i, j \leq s$. Because $\mathcal{C} \neq \mathcal{C}_i$ for all $1 \leq i \leq s$, there must exist a minimum integer k , which is a function of i , and a pair of k -brackets $A_i \in \mathcal{C}_i^k$ and $A'_i \in \mathcal{C}^k$ such that $A_i \subsetneq A'_i$. Because $s \geq 2$ and the \mathcal{C}_i are disjoint, we know that the fusion bracket for \mathcal{C} is distinct from the fusion brackets of the \mathcal{C}_i . Thus, by Lemma 2.68, we may simultaneously contract all of the collisions $\{\mathcal{C}_i : 1 \leq i \leq s\}$ and the image of \mathcal{C} will be a collision which we will denote $\overline{\mathcal{C}}$. After this contraction, for each i , we find that $\overline{A'_i}$, the image of each A'_i , will be a k -bracket in $\overline{\mathcal{C}}^k$ containing at least two vertices of depth k . We claim that the collision $\overline{\mathcal{C}}$, is a minimal collision in the resulting contracted n -associahedron. Suppose not and let $\overline{\mathcal{C}'}$ be a collision with $\overline{\mathcal{C}'} \rightarrow \overline{\mathcal{C}}$, then the preimage \mathcal{C}' of $\overline{\mathcal{C}'}$, as guaranteed by iterated application of Lemma 2.70, is a collision such that $\{\mathcal{C}'\} \cup Y \in \Delta$ contradicting the maximality of Y . Thus by Lemma 2.65 the fusion k -bracket A for $\overline{\mathcal{C}}$ contains two singleton k -brackets. It must be then that $\overline{A'_i} = A$ for all i , we have $s = 2$, and the two singleton k -brackets associated to the two vertices in A^k are the images of the A_i with $i \in \{1, 2\}$. \square

Definition 5.25. An abstract simplicial complex Δ is *pure* if each maximal simplex (facet) has the same number of vertices. \triangle

Lemma 5.26. *The extended triangulated n -associahedron $\widehat{\Delta}_{\mathcal{T}}$ is a pure complex of dimension $m - 1$.*

Let $Y = \{\mathcal{C}_i : 1 \leq i \leq l\}$ be a maximal nested collection of extended collisions. There are several ways to prove that $|Y| = m$. One natural way to attempt to prove this statement is to take a containment-minimal collision $\mathcal{C} \in Y$, contract \mathcal{C} and apply induction to the image of Y . The immediate obstacle to this approach is that the image of Y may not be a nested collection. This subtlety is addressed in Lemma 5.35, which is later utilized for proving smoothness of the triangulated velocity fan. One may use Lemma 5.35 to canonically replace the image of Y with a maximal nested set with the same cardinality, which by induction is equal to $|Y| - 1$ thus proving the desired statement. One may also derive Lemma 5.26 from Proposition 5.34 as we know that the dimension of $\overline{\mathcal{K}}^{\text{met}}(\mathcal{T})$ as an abstract fan is $m - 1$. We give another proof here which highlights some combinatorics not discussed elsewhere in this paper (and avoids forward referencing).

Proof. (5.26) By the proof of Lemma 5.24, for each $\mathcal{C}_i \in Y$, there exists a unique k -bracket $\tilde{A}_i \in \mathcal{C}_i^k$ such that for every k -bracket $A \in \mathcal{C}_j^k$ for $j < i$, $\tilde{A}_i^k \neq A^k$. Let \mathcal{B} be the join of the collisions in Y . The set of all \tilde{A}_i^k can be interpreted as forming a “1-bracketing” of the set $V^k(\mathcal{T})$, with vertices reordered to be compatible with the extended height partial for \mathcal{B} . If Y is maximal then each of these 1-bracketings is maximal. We know that a maximal 1-bracketing on a set with $t_k + 1$ elements must have t_k nonsingleton brackets, thus the total number of \tilde{A}_i is equal to $\sum_{k=1}^n t_k = m$, which is the cardinality of Y . \square

Remark 5.27. In the case of $n = 2$, the perspective offered in the previous proof is closely related to the *stable tree pairs* of the second author [Bot19a]. \triangle

Definition 5.28. Let D be a directed graph and q a vertex in D . Then D is a *q-rooted tree* if D is acyclic, each vertex other than q has exactly one outgoing edge, and q has no outgoing edges. A *q-rooted tree* is *binary* if each vertex has at most two incoming edges. \triangle

Theorem 5.29. Let Y be a simplex in $\Delta_{\mathcal{T}}$ with $\mathcal{B}_{\min} \in Y$, then the set of directed cover relations in Y form a q -rooted tree \mathcal{T}_Y where $q = \mathcal{B}_{\min}$. Moreover, if Y is maximal then \mathcal{T}_Y is a binary tree with precisely m vertices.

Proof. In order to prove that the cover relations \mathcal{T}_Y define a rooted tree, we observe that Lemma 5.19 implies the direct part of the (extended) collision mixed graph is acyclic, and Lemma 5.22 implies each vertex of \mathcal{T}_Y has out degree exactly one. Each vertex in \mathcal{T}_Y other than \mathcal{B}_{\min} is incident to at least one outgoing edge, and \mathcal{B}_{\min} has no outgoing edges, hence \mathcal{B}_{\min} is the root of \mathcal{T}_Y . Assuming further that Y is maximal, we see the statement that \mathcal{T}_Y is binary follows from Lemma 5.24, and the statement that \mathcal{T}_Y has m vertices is Lemma 5.26. \square

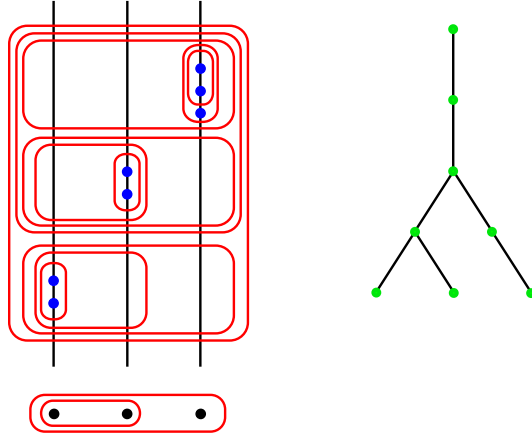

FIGURE 25. A maximal 2-bracketing, whose associated chamber in the velocity fan is already simplicial, and the associated rooted binary tree.

5.4. $\overline{\mathcal{K}}^{\text{met}}(\Delta_{\mathcal{T}})$ is a triangulation of $\overline{\mathcal{K}}^{\text{met}}(\mathcal{T})$.

In this subsection we prove Proposition 5.34, which states that $\overline{\mathcal{K}}^{\text{met}}(\Delta_{\mathcal{T}})$ is a triangulation of $\overline{\mathcal{K}}^{\text{met}}(\mathcal{T})$.

Lemma 5.30. Let $\ell_{\mathcal{B}}$ be a metric n -bracketing. There exists a unique expression

$$(134) \quad \ell_{\mathcal{B}} = \sum_{i=0}^s \lambda_i \ell(\mathcal{C}_i)$$

with $\lambda_i \in \mathbb{R}$ and $\lambda_i > 0$ for $i > 0$, where $\{\mathcal{C}_i : 1 \leq i \leq s\}$ is a collection of nested collisions, and $\mathcal{C}_0 = \mathcal{B}_{\min}$.

Proof. The existence of such an expression is demonstrated by a slightly refinement of the proof of Lemma 3.45: instead of picking a collision \mathcal{C} in the support of $l_{\mathcal{B}}$ arbitrarily, take \mathcal{C} containment-minimal in the support of $l_{\mathcal{B}}$ and again take t the minimum value of $l_{\mathcal{B}}(A)$ for A a nontrivial bracket in \mathcal{C} . By induction on the number of brackets in the support of a metric n -bracketing, we have that $l_{\mathcal{B}} - tl(\mathcal{C})$ admits an expression of the desired form, and by our choice of \mathcal{C} , it follows that $l_{\mathcal{B}}$ does as well.

Suppose that there exists two distinct expressions

$$(135) \quad l_{\mathcal{B}} = \sum_{i=1}^s \lambda_i l(\mathcal{C}_i) = \sum_{i=1}^t \gamma_i l(\underline{\mathcal{C}}_i)$$

with $\lambda_i, \gamma_i \in \mathbb{R}$, and $\lambda_i, \gamma_i > 0$ for $i > 0$, such that $\{\mathcal{C}_i : 1 \leq i \leq s\}$ and $\{\underline{\mathcal{C}}_i : 1 \leq i \leq t\}$ are collections of nested collisions, and $\mathcal{C}_0 = \underline{\mathcal{C}}_0 = \mathcal{B}_{\min}$. Let \mathcal{C} be an extended collision which is containment-minimal in \mathcal{B} . We claim that there exists some $1 \leq q \leq s$ and $1 \leq r \leq t$ such that $\mathcal{C}_q = \underline{\mathcal{C}}_r = \mathcal{C}$. Suppose for contradiction that there exists no q such that $\mathcal{C}_q = \mathcal{C}$. For each k with $1 \leq k \leq n$, and $A \in \mathcal{C}^k$ essential, there exists some i such that $A \in \mathcal{C}_i^k$. Let \mathcal{C}_i be a collision which maximizes the number of common brackets with \mathcal{C} . Because $\mathcal{C}_i \neq \mathcal{C}$ we know that there exists some k with $1 \leq k \leq n$, and $A_1 \in \mathcal{C}^k$ such that $A_1 \notin \mathcal{C}_i^k$. There exists some \mathcal{C}_j such that $A_1 \in \mathcal{C}_j^k$. By the maximality assumption on \mathcal{C}_i , we know that there exists some l with $1 \leq l \leq n$ and $A_2 \in \mathcal{C}^l$ such that $A_2 \in \mathcal{C}_i^l$, but $A_2 \notin \mathcal{C}_j^l$, otherwise \mathcal{C}_j would have more brackets in common with \mathcal{C} than \mathcal{C}_i .

Because \mathcal{C} is containment-minimal in \mathcal{B} , and $\mathcal{C} \rightsquigarrow \mathcal{C}_i, \mathcal{C} \rightsquigarrow \mathcal{C}_j$, we must have $\mathcal{C} \rightarrow \mathcal{C}_i, \mathcal{C} \rightarrow \mathcal{C}_j$. Hence there must exist some $A'_1 \in \mathcal{C}_i^k$ and $A'_2 \in \mathcal{C}_j^l$ such that $A_1 \subsetneq A'_1$ and $A_2 \subsetneq A'_2$. This implies that $\mathcal{C}_i \rightsquigarrow \mathcal{C}_j$ and $\mathcal{C}_j \rightsquigarrow \mathcal{C}_i$. We observe that A_1 and A_2 project to the fusion bracket for \mathcal{C} , hence $\mathcal{C}_i \rightsquigarrow \mathcal{C}_j$. This contradicts our assumption that the pair \mathcal{C}_i and \mathcal{C}_j are nested. It follows that there must exist indices q and r such that $\mathcal{C}_q = \underline{\mathcal{C}}_r = \mathcal{C}$. We may assume without loss of generality that $\lambda_q \leq \gamma_r$. We have by Scholium 3.47 that $l_{\mathcal{B}} - \lambda_q l(\mathcal{C}) = l_{\mathcal{B}'}$ is a metric n -bracketing, and we have the expression

$$(136) \quad l_{\mathcal{B}'} = \sum_{i=0, i \neq q}^s \lambda_i l(\mathcal{C}_i) = \left(\sum_{i=0, i \neq r}^t \gamma_i l(\underline{\mathcal{C}}_i) \right) + (\gamma_r - \lambda_q) l(\underline{\mathcal{C}}_r).$$

The total number of summands appearing in the above expression for $l_{\mathcal{B}'}$ is at least 1 less than the total number of summands appearing in the expression for $l_{\mathcal{B}}$. It follows by induction on $s + t$ that the two expressions for $l_{\mathcal{B}'}$ above are equal, hence the two expressions for $l_{\mathcal{B}}$ above are also equal. \square

Lemma 5.31. *The collection of conical sets $\mathcal{K}^{\text{met}}(\Delta_{\mathcal{T}})$ forms an abstract fan.*

Proof. For proving that $\mathcal{K}^{\text{met}}(\Delta_{\mathcal{T}})$ is an abstract fan, we first verify conditions (1) and (2) of Definition 3.11. Given a conical set τ in $\mathcal{K}^{\text{met}}(\Delta_{\mathcal{T}})$, it follows from Lemma 3.16 that each face of τ is generated by a subset of the ray generators of τ , together with the lineality space generated by $\ell(\mathcal{B}_{\min})$. By Lemma 5.30, each subset of the rays together with $\ell(\mathcal{B}_{\min})$ generate a face of τ . Because $\Delta_{\mathcal{T}}$ is a simplicial complex, any subset of the rays of τ together with $\ell(\mathcal{B}_{\min})$ generate a conical set in $\mathcal{K}^{\text{met}}(\Delta_{\mathcal{T}})$, thus condition (1) is satisfied.

We verify condition (2). Let $Y_1, Y_2 \in \Delta_{\mathcal{T}}$ with $Y_1 = \{\mathcal{C}_1, \dots, \mathcal{C}_k\}$ and $Y_2 = \{\underline{\mathcal{C}}_1, \dots, \underline{\mathcal{C}}_l\}$. Let $\tau_1, \tau_2 \in \mathcal{K}^{\text{met}}(\Delta_{\mathcal{T}})$ with $\tau_1 = \tau^{\text{met}}(Y_1)$ and $\tau_2 = \tau^{\text{met}}(Y_2)$. We claim that $\tau_1 \cap \tau_2 = \tau^{\text{met}}(Y_1 \cap Y_2)$ implying $\tau_1 \cap \tau_2 \in \mathcal{K}^{\text{met}}(\Delta_{\mathcal{T}})$. Clearly, $\tau_1 \cap \tau_2 \supseteq \tau^{\text{met}}(Y_1 \cap Y_2)$. For establishing opposite inclusion, let $\ell_{\mathcal{B}} \in \tau_1 \cap \tau_2$. There are expressions

$$(137) \quad \ell_{\mathcal{B}} = \sum_{i=0}^k \lambda_i \ell(\mathcal{C}_i) = \sum_{i=0}^l \gamma_i \ell(\underline{\mathcal{C}}_i)$$

with $\lambda_i, \gamma_i \geq 0$ for $i > 0$, and $\mathcal{C}_0 = \underline{\mathcal{C}}_0 = \mathcal{B}_{\min}$. Restricting to the support of these sums, we find ourselves in the setting of Lemma 5.30, which implies that the two expressions are the same. Hence, the ray generators which appear in the sums must belong to $\tau^{\text{met}}(Y_1 \cap Y_2)$, so $\ell_{\mathcal{B}} \in \tau^{\text{met}}(Y_1 \cap Y_2)$.

For verifying that each conical set in $\mathcal{K}^{\text{met}}(\Delta_{\mathcal{T}})$ is an abstract cone, we may apply Lemma 3.17. \square

Scholium 5.32. *Let $Y \in \Delta_{\mathcal{T}}$ with $Y = \{\mathcal{C}_1, \dots, \mathcal{C}_k\}$. Define $\tau_{\mathbb{Z}}^{\text{met}}(Y)$ to be the metric n -bracketings $\ell_{\mathcal{B}} \in \tau^{\text{met}}(Y)$ such that for each $A \in \mathcal{B}^k$, we have $\ell_{\mathcal{B}}(A) \in \mathbb{Z}$; these are the integer points of $\tau^{\text{met}}(Y)$. It follows from the above argumentation that each $\ell_{\mathcal{B}} \in \tau_{\mathbb{Z}}^{\text{met}}(Y)$ is uniquely expressible as*

$$(138) \quad \ell_{\mathcal{B}} = \sum_{i=0}^k \lambda_i \ell(\mathcal{C}_i)$$

with $\mathcal{C}_0 = \mathcal{B}_{\min}$, $\lambda_i \in \mathbb{Z}$, and $\lambda_i \geq 0$ for $i \neq 0$. \triangle

Lemma 5.33. *The conical set complex $\mathcal{K}^{\text{met}}(\Delta_{\mathcal{T}})$ is a refinement of $\mathcal{K}^{\text{met}}(\mathcal{T})$.*

Proof. Let $\mathcal{B} \in \mathcal{K}(\mathcal{T})$ so that $\tau^{\text{met}}(\mathcal{B}) \in \mathcal{K}^{\text{met}}(\mathcal{T})$. We must show that $\tau^{\text{met}}(\mathcal{B})$ is a union of conical sets in $\mathcal{K}^{\text{met}}(\Delta_{\mathcal{T}})$. Let $\ell_{\mathcal{B}'} \in \tau^{\text{met}}(\mathcal{B})$. We know by Lemma 5.30 that we can express

$$(139) \quad \ell_{\mathcal{B}'} = \sum_{i=0}^k \lambda_i \ell(\mathcal{C}_i),$$

where the set of collisions $Y = \{\mathcal{C}_i : 1 \leq i \leq k\}$ is nested and $\mathcal{C}_0 = \mathcal{B}_{\min}$, hence $\ell_{\mathcal{B}'} \in \tau^{\text{met}}(Y)$. For each i with $1 \leq i \leq k$, we have that $\mathcal{C}_i \leq \mathcal{B}$, thus $\ell(\mathcal{C}_i) \in \tau^{\text{met}}(\mathcal{B})$ and $\tau^{\text{met}}(Y) \subseteq \tau^{\text{met}}(\mathcal{B})$. Thus $\tau^{\text{met}}(\mathcal{B})$ is a union of conical sets in $\mathcal{K}^{\text{met}}(\Delta_{\mathcal{T}})$. \square

Proposition 5.34. *The conical set complex $\bar{\mathcal{K}}^{\text{met}}(\Delta_{\mathcal{T}})$ is a triangulation of $\bar{\mathcal{K}}^{\text{met}}(\mathcal{T})$.*

Proof. First observe that by Lemma 5.31 combined with Lemma 3.26, we have that $\overline{\mathcal{K}}^{\text{met}}(\Delta_{\mathcal{T}})$ is an abstract fan. Moreover, by Lemma 5.33 and Lemma 3.32, $\overline{\mathcal{K}}^{\text{met}}(\Delta_{\mathcal{T}})$ refines $\overline{\mathcal{K}}^{\text{met}}(\mathcal{T})$. It remains to check that every conical set in $\overline{\mathcal{K}}^{\text{met}}(\Delta_{\mathcal{T}})$ is simplicial. Let $\tau \in \overline{\mathcal{K}}^{\text{met}}(\Delta_{\mathcal{T}})$ and $\ell \in \tau$. By Lemma 5.30, we have that ℓ can be expressed uniquely as a conical combination of the rays of τ , thus τ is simplicial. \square

Building on the ideas of this subsection, we briefly describe an algorithm for expressing a vector \mathbf{v} as a conical combination of the rays of a cone in the velocity fan, moreover, the rays of a cone in the triangulated velocity fan. This algorithm can alternately be interpreted as providing a method for computing Γ^{-1} .

Let $\mathbf{v}^0 = \mathbf{v}$. At the k th step of the algorithm we have constructed a tuple $M^k = (\mathbf{v}^k, \mathcal{C}^k, \lambda_k)$ such that

$$(140) \quad \mathbf{v}^k + \lambda_k \rho(\mathcal{C}^k) = \mathbf{v}^{k-1}$$

so that

$$(141) \quad \mathbf{v} = \mathbf{v}^k + \sum_{i=1}^k \lambda_i \rho(\mathcal{C}_i)$$

and $\{\mathcal{C}_i : 1 \leq i \leq k\}$ is a nested collection of collisions.

We stop if $\mathbf{v}^k = \mathbf{0}$. Otherwise, take $\mathcal{C}^{k+1} \in \Xi(\mathbf{v}^k)$ and let

$$(142) \quad \lambda_{k+1} := \sup\{t \in \mathbb{R}_{\geq 0} : \mathcal{C}^{k+1} \in \Xi(\mathbf{v}^k - t\rho(\mathcal{C}^{k+1}))\}.$$

To prove that this algorithm works, one can apply Γ^{-1} to \mathbf{v} and check that the algorithm agrees with the one outlined at the beginning of Lemma 5.30. This assumes that the velocity fan is complete so that Γ surjects onto \mathbb{R}^m . It is, perhaps, surprisingly difficult to prove directly that this algorithm succeeds without first knowing that the velocity fan is complete.

5.5. $\overline{\mathcal{F}}(\Delta_{\mathcal{T}})$ is a smooth triangulation of $\overline{\mathcal{F}}(\mathcal{T})$.

In this subsection, we establish Theorem 5.12 which is the main result of §5. If $\{\mathcal{C}_i : 1 \leq i \leq k\}$ is a collection of nested collisions then it is tempting to expect that their image $\{\mathcal{C}_i/\mathcal{C}_1 : 1 \leq i \leq k\}$ in $\mathcal{T}/\mathcal{C}_1$ forms a collection of nested collisions. This is nearly true, except for the important fact that they may not form a collection of collisions! In particular, if \mathcal{C}_i and \mathcal{C}_1 have the same fusion bracket, then $\mathcal{C}_i/\mathcal{C}_1$ may not be a collision. The following lemma effectively addresses this subtlety in a way which will allow us to utilize induction for proving that the triangulated velocity fan is smooth.

Lemma 5.35. *Let $\{\mathcal{C}_i : 1 \leq i \leq k\}$ be a collection of nested collisions which all have the same fusion bracket and are maximal with this property. For each \mathcal{C}_i , we let $\{\mathcal{C}_{i,r} : 1 \leq r \leq s_i\}$ denote the collection of pairwise disjoint collisions in $\mathfrak{X}(\mathcal{T}/\mathcal{C}_1)$ such that*

$$(143) \quad \mathcal{C}_i/\mathcal{C}_1 = \bigvee_{r=1}^{s_i} \mathcal{C}_{i,r},$$

as is guaranteed by Lemma 2.69. Then there exists a unique r_i with $1 \leq r_i \leq s_i$ such that $\mathcal{C}_{i,r_i} \notin \{\mathcal{C}_{i-1,r} : 1 \leq r \leq s_{i-1}\}$, and $\{\mathcal{C}_{i,r_i} : 1 \leq i \leq k\}$ is a nested collection of collisions with

$$(144) \quad \bigvee_{i=1}^k \mathcal{C}_i / \mathcal{C}_1 = \bigvee_{i=1}^k \mathcal{C}_{i,r_i}.$$

Proof. Because $\{\mathcal{C}_i : 1 \leq i \leq k\}$ is a collection of nested collisions with the same fusion bracket, it follows that no pair are disjoint, hence $\mathcal{C}_i \rightarrow \mathcal{C}_j$ for all $1 \leq i < j \leq k$. Because $\mathcal{C}_{i-1} \neq \mathcal{C}_i$ there must exist some r_i such that $\mathcal{C}_{i,r_i} \notin \{\mathcal{C}_{i-1,r} : 1 \leq r \leq s_{i-1}\}$. Suppose that there exist $1 \leq r_i < r_j \leq s_i$ such that $\mathcal{C}_{i,r_i}, \mathcal{C}_{i,r_j} \notin \{\mathcal{C}_{i-1,r} : 1 \leq r \leq s_{i-1}\}$. Let $\bar{\mathcal{C}}$ be the collection $\{\mathcal{C}_{i,r_i}\} \cup \{\mathcal{C}_{i-1,r} : \mathcal{C}_{i,r_i} \sim \mathcal{C}_{i-1,r}, 1 \leq r \leq s_{i-1}\}$. Then we can apply Lemma 2.70 to conclude that $\bar{\mathcal{C}}$ is the image in $\mathfrak{X}(\mathcal{T}/\mathcal{C}_1)$ of a collision $\mathcal{C} \in \mathfrak{X}(\mathcal{T})$. Moreover, we have that $\mathcal{C} \neq \mathcal{C}_{i-1}$, $\mathcal{C} \neq \mathcal{C}_i$, and $\mathcal{C}_{i-1} \rightarrow \mathcal{C} \rightarrow \mathcal{C}_i$. Thus $\{\mathcal{C}\} \cup \{\mathcal{C}_i : 1 \leq i \leq k\}$ is a nested collection of collisions with the same fusion bracket which properly contains $\{\mathcal{C}_i : 1 \leq i \leq k\}$, but this contradicts the maximality of the nested collection $\{\mathcal{C}_i : 1 \leq i \leq k\}$. \square

The following two lemmas are by definition.

Lemma 5.36. *If a cone τ is smooth, then all of the faces of τ are smooth.*

Lemma 5.37. *Let $N = \mathbb{Z}^m / \langle \mathbf{1} \rangle_{\mathbb{Z}}$ so that $\mathbb{T}^{m-1} = N \otimes \mathbb{R}$. Let τ be an $m-1$ dimensional cone in \mathbb{T}^{m-1} , then τ is smooth if and only if the primitive ray generators $\rho_1, \dots, \rho_{m-1}$ for τ are such that the $m \times m$ matrix M_τ with columns $\rho_1, \dots, \rho_{m-1}$ and additional column $\mathbf{1}$ satisfies $M_\tau \in GL_m(\mathbb{Z})$.*

Lemma 5.38. *Each cone in $\bar{\mathcal{F}}(\Delta_{\mathcal{T}})$ is smooth.*

Proof. (5.38) Let $Y = \{\mathcal{C}_i : 1 \leq i \leq k\}$ be a maximal nested collection of collisions. For establishing the statement of the lemma, it suffices by Lemma 5.36 to prove that the cone $\tau = \tau(Y) \in \bar{\mathcal{F}}(\Delta_{\mathcal{T}})$ is smooth. By Lemma 5.26, we know that $k = m-1$. Construct the matrix M_τ described in Lemma 5.37 with $\rho_i = \rho(\mathcal{C}_i)$. For completing the proof, it suffices by Lemma 5.37 to prove that $M_\tau \in GL_m(\mathbb{Z})$, i.e. $\det(M_\tau) = 1$. The collision \mathcal{C}_1 is a minimal collision, otherwise we would be able to enlarge Y by adding a collision \mathcal{C} with $\mathcal{C} \rightarrow \mathcal{C}_1$. Subtract the column $\rho(\mathcal{C}_1)$ from the column $\rho(\mathcal{C}_i)$ for each i such that $\mathcal{C}_1 \rightarrow \mathcal{C}_i$. Additionally, subtract the column $\rho(\mathcal{C}_1)$ from to last column $\mathbf{1}$ and let the resulting matrix be M'_τ . Let σ be a compatible shuffle for \mathcal{C}_1 . Multiply M'_τ by P_σ^T on the left to obtain a matrix M''_τ . Then we may use Lemma 4.33, to calculate the column of M''_τ corresponding to each \mathcal{C}_i . Let $Y' = \{\mathcal{C}'_i : 1 \leq i \leq l\} \subsetneq \{\mathcal{C}_i : 1 \leq i \leq k\}$ be the collection of collisions such that for each $1 \leq i \leq l$ we have $\mathcal{C}_1 \rightarrow \mathcal{C}'_i$, $\mathcal{C}_1 \neq \mathcal{C}'_i$, and \mathcal{C}'_i has the same fusion bracket as \mathcal{C}_1 . Beginning with $i=1$ and proceeding to $i=l$, subtract the columns of M''_τ corresponding to \mathcal{C}'_j from the column of M''_τ corresponding to \mathcal{C}'_{i+1} if $j \leq i$ and $\mathcal{C}'_{i,r_i} = \mathcal{C}'_{j,r}$ for some $1 \leq r \leq s_i$. Let the resulting matrix be M'''_τ . We have performed only column subtractions to go from M_τ to M'_τ and from M''_τ to

M_τ'''' . Furthermore, by Lemma 4.24 we know that $P_\sigma^T \in GL_m(\mathbb{Z})$, thus we have the equality of determinants: $\det(M_\tau) = \det(M_\tau') = \det(M_\tau'') = \det(M_\tau''')$.

Let i be the row which corresponds to the pair of depth k vertices contained in the fusion of \mathcal{C}_1 as guaranteed by Lemma 2.65. By Lemmas 4.32 and 4.33, the matrix M_τ'''' is such that the (i, j) th entry is 1 for $j = 1$ and 0 for $j > 1$. Using the Laplace expansion calculation of $\det(M_\tau''')$ along the i th row, we find that $\det(M_\tau''')$ is equal to the determinant of the principal submatrix obtained by deleting the i th row and the first column. Let $\tilde{\tau}$ be the cone in $\mathcal{F}(\Delta_{\mathcal{T}/\mathcal{C}_1})$ which is generated by the rays associated to $\{\mathcal{C}_i/\mathcal{C}_1 : \mathcal{C}_i \in Y \setminus Y', i \neq 1\} \cup \{\mathcal{C}'_{i,r_i} : \mathcal{C}'_i \in Y'\}$ with \mathcal{C}'_{i,r_i} associated to \mathcal{C}'_i as in Lemma 5.35. By the arguments above, the principal submatrix in question is equal to $M_{\tilde{\tau}}$. By induction on the size the matrix, with base case $m = 1$, we have that $1 = \det(M_{\tilde{\tau}}) = \det(M_\tau''') = \det(M_\tau)$. \square

We are now ready to prove the main theorem of this section.

Proof. (5.12) To see that $\overline{\mathcal{F}}(\Delta_{\mathcal{T}})$ is a triangulation of $\overline{\mathcal{F}}(\mathcal{T})$, we utilize Corollary 4.17 for Proposition 5.34 combined with Lemma 3.24. Flagness is established in Proposition 5.20. It is clear from the definitions that these fans use the same set of rays. Smoothness follows from Lemma 5.38. \square

Remark 5.39. In our future work on projectivity for the velocity fan, we will investigate the triangulated velocity fan through the lens of smooth toric blowups, e.g. central stellar subdivisions. \triangle

Corollary 5.40. *For $\mathcal{B} \in \mathcal{K}(\mathcal{T})$, the map Γ induces a monoid isomorphism between the integer metric n -bracketings in a conical set $\tau^{\text{met}}(\mathcal{B}) \in \mathcal{K}^{\text{met}}(\mathcal{T})$ and the integer points of the corresponding cone $\tau(\mathcal{B}) \in \mathcal{F}(\mathcal{T})$.*

Proof. It suffices to prove this statement for Γ viewed as a map $\Gamma : \mathcal{K}^{\text{met}}(\Delta_{\mathcal{T}}) \rightarrow \mathcal{F}(\Delta_{\mathcal{T}})$. By Lemma 5.38, we see that each integer point in $\tau(Y)$ is an integer combination of the ray generators and the statement follows by combining this observation with Scholium 5.32, Proposition 4.13, and the fact that Γ maps the ray generators of $\mathcal{K}^{\text{met}}(\Delta_{\mathcal{T}})$ to the ray generators of $\mathcal{F}(\Delta_{\mathcal{T}})$. \square

5.6. The permutahedral n -associahedron.

In this subsection, we describe a finer triangulation of the triangulated velocity fan, which we call the permutahedral velocity fan. For the case of $n = 1$, the velocity fan and the triangulated velocity fan coincide and specialize to the wonderful associahedral fan, while the permutahedral velocity fan specializes to the braid arrangement. Thus, this triangulation can be viewed as providing a new family of generalizations of the braid arrangement associated to rooted plane trees. We note that several rooted plane trees can give the same permutahedral velocity fan, e.g. all of the concentrated n -associahedra presented in §8 have permutahedral velocity fan equal to the braid arrangement.

We begin by describing a certain simplicial complex which will form the underlying combinatorial object for our triangulation.

Definition 5.41. Let \mathcal{T} be a rooted plane tree and $\{\mathcal{C}_1, \dots, \mathcal{C}_k\}$ be a collection of collisions such that for every $1 \leq i < j \leq k$, we have $\mathcal{C}_i \sim \mathcal{C}_j$, then we define $\mathcal{D} = \{\mathcal{C}_1, \dots, \mathcal{C}_k\}$ to be a *generalized collision*. We denote the collection of all generalized collisions by $\mathfrak{P}(\mathcal{T})$. \triangle

Remark 5.42. We may identify a generalized collision $\mathcal{D} = \{\mathcal{C}_1, \dots, \mathcal{C}_k\}$ with the associated n -bracketing $\vee_{i=1}^k \mathcal{C}_i$.

We now introduce a partial order on $\mathfrak{P}(\mathcal{T})$.

Definition 5.43. Given $\mathcal{D}_1, \mathcal{D}_2 \in \mathfrak{P}(\mathcal{T})$. We say that $\mathcal{D}_1 \leq_{\mathfrak{P}} \mathcal{D}_2$ if for every $\mathcal{C}_1 \in \mathcal{D}_1$ there exists some $\mathcal{C}_2 \in \mathcal{D}_2$ such that $\mathcal{C}_1 \rightarrow \mathcal{C}_2$. \triangle

We recall the following construction from poset theory.

Definition 5.44. Given a partially ordered set \mathcal{P} , the *order complex* of \mathcal{P} , which we denote $\mathcal{O}(\mathcal{P})$, is the abstract simplicial complex whose vertices are the elements of \mathcal{P} and whose faces are flags, i.e. chains, in \mathcal{P} .

Definition 5.45. Let \mathcal{T} be a rooted plane tree of depth n . The *permutahedral n -associahedron* is $\mathcal{O}(\mathcal{T}) := \mathcal{O}(\mathfrak{P}(\mathcal{T}))$. \triangle

Given some $\mathcal{D} \in \mathfrak{P}(\mathcal{T})$ we assign a metric n -bracketing and a vector:

$$(145) \quad \ell(\mathcal{D}) = \sum_{\mathcal{C} \in \mathcal{D}} \ell(\mathcal{C}) \quad , \quad \rho(\mathcal{D}) = \sum_{\mathcal{C} \in \mathcal{D}} \rho(\mathcal{C}).$$

Given a face $Z \in \mathcal{O}(\mathcal{T})$, we assign a conical set and a cone:

$$(146) \quad \begin{aligned} \tau^{\text{met}}(Z) &= \text{cone}\{\ell(\mathcal{D}) : \mathcal{D} \in Z\} + \langle \ell(\mathcal{B}_{\min}) \rangle_{\mathbb{R}}, \\ \tau(Z) &= \text{cone}\{\rho(\mathcal{D}) : \mathcal{D} \in Z\} + \langle \mathbf{1} \rangle_{\mathbb{R}}. \end{aligned}$$

Definition 5.46. The *permutahedral metric n -bracketing complex* is

$$(147) \quad \mathcal{K}^{\text{met}}(\mathcal{O}(\mathcal{T})) = \{\tau^{\text{met}}(Z) : Z \in \mathcal{O}(\mathcal{T})\},$$

and the *reduced permutahedral metric n -bracketing complex* is

$$(148) \quad \bar{\mathcal{K}}^{\text{met}}(\mathcal{O}(\mathcal{T})) = \{\tau^{\text{met}}(Z) / \langle \ell(\mathcal{B}_{\min}) \rangle_{\mathbb{R}} : Z \in \mathcal{O}(\mathcal{T})\}.$$

\triangle

Definition 5.47. The *permutahedral velocity fan* is

$$(149) \quad \mathcal{F}(\mathcal{O}(\mathcal{T})) = \{\tau(Z) : Z \in \mathcal{O}(\mathcal{T})\},$$

and the *reduced permutahedral velocity fan* is

$$(150) \quad \bar{\mathcal{F}}(\mathcal{O}(\mathcal{T})) = \{\tau(Z) / \langle \mathbf{1} \rangle_{\mathbb{R}} : Z \in \mathcal{O}(\mathcal{T})\}.$$

\triangle

The following is the main result of this subsection.

Proposition 5.48. *The reduced permutahedral velocity fan $\bar{\mathcal{F}}(\mathcal{O}(\mathcal{T}))$ is a smooth flag triangulation of $\bar{\mathcal{F}}(\Delta_{\mathcal{T}})$.*

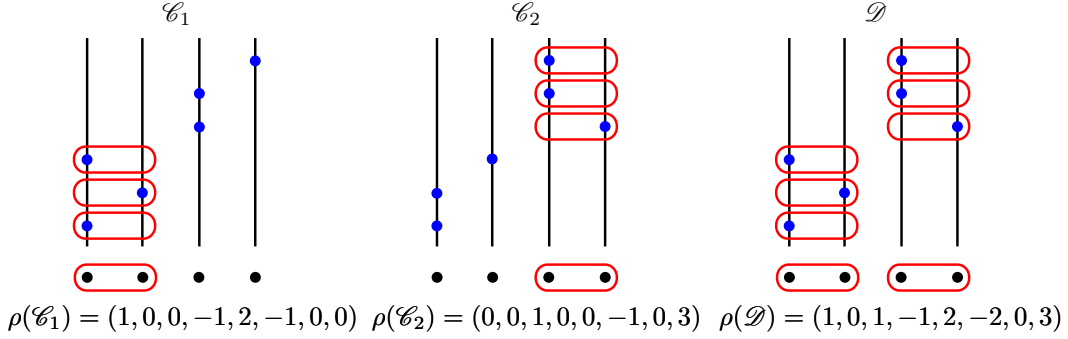

FIGURE 26. A pair of disjoint collisions, the generalized collision associated to the pair, and the corresponding ray generators.

The proof of Proposition 5.48 is very similar to, but easier than, the proof of Theorem 5.12. For this reason, we err on the side of concision.

We begin with a combinatorial observation about $\mathcal{O}(\mathcal{T})$ which, in the case $n = 1$, specializes to a well-know relationship between the wonderful associahedral fan and the braid arrangement (see [PRW08]). Let $Y \in \Delta_{\mathcal{T}}$ and let \mathcal{T}_Y be the corresponding rooted tree from Theorem 5.29. Let $\mathcal{P}(\mathcal{T}_Y)$ be the poset whose Hasse diagram is \mathcal{T}_Y . Let $L(Y)$ denote the collection of linear extensions of $\mathcal{P}(\mathcal{T}_Y)$. For a fixed linear extension $\prec \in L(Y)$ and $\mathcal{C} \in Y$, let

$$(151) \quad \max_{\prec}(\mathcal{C}) := \{\mathcal{C}' \in Y : \mathcal{C}' \preceq \mathcal{C}, \nexists \mathcal{C}'' \in Y \text{ s.th. } \mathcal{C}'' \preceq \mathcal{C}, \mathcal{C}' \neq \mathcal{C}'' \text{ and } \mathcal{C}' \rightarrow \mathcal{C}''\}.$$

Let $\mathcal{D}_{\mathcal{C}, \prec} \in \mathfrak{B}(\mathcal{T})$ be

$$(152) \quad \mathcal{D}_{\mathcal{C}, \prec} = \{\mathcal{C}' : \mathcal{C}' \in \max_{\prec}(\mathcal{C})\}.$$

Let

$$(153) \quad \Lambda : \bigsqcup_{Y \in \Delta_{\mathcal{T}}} L(Y) \rightarrow \mathcal{O}(\mathcal{T})$$

be defined by

$$(154) \quad \Lambda(\prec) = \{\mathcal{D}_{\mathcal{C}, \prec} : \mathcal{C} \in Y\}.$$

Proposition 5.49. *The map Λ is a bijection.*

Proof. First observe that the linear extensions of Y are those orders which allow Y to be described as in Definition 5.1. With this observation in hand, the proposition follows readily from the definitions. \square

The following Lemma is analogous to Lemma 5.30.

Lemma 5.50. *Let $\ell_{\mathcal{B}}$ be a metric n -bracketing. There exists a unique expression*

$$(155) \quad \ell_{\mathcal{B}} = \sum_{i=0}^k \lambda_i \ell(\mathcal{D}_i)$$

with $\mathcal{C}_0 = \mathcal{B}_{\min}$, $\lambda_i \in \mathbb{R}$, and $\lambda_i \geq 0$ for $i > 0$, where $\{\mathcal{D}_i : 1 \leq i \leq k\}$ is a flag of generalized collisions.

Proof. It is easy to extend the argument at the beginning of Lemma 5.30 to prove that an expression of the desired form exists for $\ell_{\mathcal{B}}$. To show uniqueness, suppose we have two expressions for $\ell_{\mathcal{B}}$ of the form in the statement of the lemma. Look at the minimal generalized collisions in the flags for each sum. Lemma 5.30 gives that each collision appears in both expressions with the same coefficient. We may apply this observation to show that the two minimal generalized collisions are the equal. We can then subtract a positive scalar multiple of the corresponding metric generalized collision from both sides of the sum so that the number of terms drops by one in at least one of the sums and apply induction. \square

The following propositions and their proofs are similar to Lemmas 5.31 and 5.33 and their proofs, respectively.

Proposition 5.51. *The permutahedral metric n -bracketing complex $\mathcal{K}^{\text{met}}(\mathcal{O}(\mathcal{T}))$ is an abstract fan.*

Proposition 5.52. *The abstract fan $\mathcal{K}^{\text{met}}(\mathcal{O}(\mathcal{T}))$ is a refinement of $\mathcal{K}^{\text{met}}(\Delta_{\mathcal{T}})$.*

We now complete the proof of Proposition 5.48.

Proof. (5.48) By Proposition 5.52 and Lemma 3.32, $\overline{\mathcal{K}}^{\text{met}}(\mathcal{O}(\mathcal{T}))$ is a refinement of $\overline{\mathcal{K}}^{\text{met}}(\Delta_{\mathcal{T}})$. By Corollary 4.17 and Lemma 3.24 we see that $\overline{\mathcal{F}}(\mathcal{O}(\mathcal{T}))$ is a fan which refines $\overline{\mathcal{F}}(\Delta_{\mathcal{T}})$, and $\overline{\mathcal{F}}(\mathcal{O}(\mathcal{T}))$ is simplicial by construction. The complex $\mathcal{O}(\mathcal{T})$ is flag as every order complex is flag. For smoothness, given $Z \in \mathcal{O}(\mathcal{T})$, one can construct the matrix $M_{\tau(Z)}$ of primitive ray generators together with $\mathbf{1}$ as in the statement of Lemma 5.37. Let $\prec = \Lambda^{-1}(Z) \in L(Y)$ as provided by Proposition 5.49. Take the matrix $M_{\tau(Y)}$ with its columns ordered according to the linear extension \prec . To prove that $M_{\tau(Z)}$ has determinant 1, we can observe that it is related to $M_{\tau(Y)}$ by multiplication by an integer matrix A , and Proposition 5.49 describes A as being uppertriangular with 1's on the diagonal, hence $\det(M_{\tau(Z)}) = \det(M_{\tau(Y)}) = 1$. \square

5.7. 1-dimensional n -associahedra and walls of the velocity fan.

In this section we provide a recursive calculation of the normal vectors for the walls of the velocity fan. Generalized permutahedra are characterized as those polytopes whose edge directions are type A roots, i.e. vectors of the form $e_i - e_j$. This is equivalent to saying the vectors normal to the walls of the normal fan of a generalized permutahedron are type A roots, which is in turn equivalent to saying that the normal fan should be a coarsening of the type A Coxeter arrangement (the braid arrangement). We refer the reader to [ACEP20] for a concise treatment of this story.

The complexity of a family of polytopes which in some way extends generalized permutahedra can very roughly be measured by the complexity of the edge directions, i.e. the vectors orthogonal to the walls of their normal fan. In this subsection, we will see that the normal vectors for the walls of the velocity fan have unbounded support.

For calculating these normal vectors we interpret them as normal vectors for walls of the triangulated velocity fan sitting inside walls of the nontriangulated velocity fan. We then utilize Lemma 4.32 and Lemma 5.35 for giving a recursive reduction to a simpler case where the normal vectors of walls can be read of directly from the combinatorics of the corresponding nested collisions utilizing a characterization of the 1-dimensional n -associahedra. This approach mimics the way in which one can understand the normal vectors for the walls of the wonderful associahedral fan by first characterizing these walls via the combinatorics of the unique 1-dimensional associahedron. For fixed n there is no longer a unique 1-dimensional n -associahedron, there are quadratically many combinatorial types, nonetheless they fall into two distinct categories.

Definition 5.53. Let \mathcal{T} be a rooted plane tree. We say that $\mathcal{K}(\mathcal{T})$ is 1-dimensional if $\mathcal{K}(\mathcal{T})$ has height 1 as a ranked poset, equivalently $\overline{\mathcal{F}}(\mathcal{T})$ is a 1-dimensional fan.

Lemma 5.54. Let \mathcal{T} be a rooted plane tree of depth n , and fix a path \mathcal{P} in \mathcal{T} of depth n . Suppose that $\mathcal{K}(\mathcal{T})$ is 1-dimensional, then either

- (1) \mathcal{T} is obtained by simultaneously adding two leaves to a pair of (not necessarily distinct) vertices of depth at most $n - 1$ in \mathcal{P} , so that \mathcal{T} has three leaves, or
- (2) \mathcal{T} is obtained by adding a path of length two to a vertex at depth at most $n - 2$ in \mathcal{P} , so that \mathcal{T} has two leaves.

Proof. If the reduced velocity fan is 1-dimensional, then $m = 2$, hence \mathcal{T} has exactly two pairs of consecutive vertices at the same depth. The only rooted plane trees of depth n with this property are those described in the statement of the lemma. \square

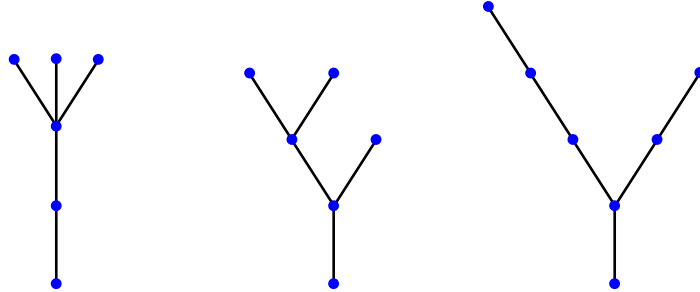

FIGURE 27. Three different rooted planes trees with 1-dimensional n -associahedra. The first two are of the form (1) in Lemma 5.54 and the third is of the form (2) in Lemma 5.54.

Proposition 5.55. The velocity fan of every 1-dimensional n -associahedron is the braid arrangement \mathcal{A}_2 .

Proof. Let \mathcal{T} be a rooted plane tree of depth n whose corresponding n -associahedron is 1-dimensional. We utilize the characterization given in Lemma 5.54. If \mathcal{T} has three

leaves, then the two corresponding collisions have ray generators $(1, 0)$ and $(0, 1)$, and lineality space generated by $(1, 1)$ as desired. On the other hand, if \mathcal{T} has two leaves, then the ray generators are $(1, 0)$ and $(1, 2)$ with lineality space generated by $(1, 1)$. We can subtract the lineality space generator $(1, 1)$ from the ray generator $(1, 2)$ to obtain the ray generator $(0, 1)$. \square

Remark 5.56. We highlight the curious fact that for 1-dimensional categorical n -associahedra associated to trees with two leaves, while the velocity fan is indeed the 1-dimensional braid arrangement, the velocity fan does not immediately give us the standard ray generators. This observation is related to the fact that these types of 1-dimensional n -associahedra are the reason why general velocity fans do not live in the braid arrangement. That is, suppose that $\mathcal{K}(\mathcal{T})$ is an n -associahedron with the rank of $\mathcal{K}(\mathcal{T})$ at least 2. Then $\mathcal{F}(\mathcal{T})$ is not a coarsening of the braid arrangement if and only if there exists a wall in $\mathcal{F}(\mathcal{T})$ such that the identification from Lemma 5.61 gives a k -bracket A associated to a tree with two leaves. \triangle

In order to give a calculation of the normal vectors for the walls of the velocity fan, it suffices to calculate the normal vectors for certain walls of the triangulated velocity fan which are contained in walls of the velocity fan. This simplifying observation is the reason why this calculation is presented in this section.

Definition 5.57. Let $W \in \Delta_{\mathcal{T}}$ with $W = \{\mathcal{C}_i : 1 \leq i \leq m - 2\}$, and let $\tau(W)$ be the corresponding wall of the triangulated velocity fan. Suppose that $\vee_{i=1}^{m-2} \mathcal{C}_i = \mathcal{B}$ and suppose for each \mathcal{C}_i which is containment-minimal in \mathcal{B} , \mathcal{C}_i is not a minimal collision, then we say that $\tau(W)$ is *reduced*. \triangle

Lemma 5.58. *If $\tau(W)$ is a reduced wall of the triangulated velocity fan, then the tree \mathcal{T}_W corresponding to W , as described in Theorem 5.29, is a path.*

Proof. If \mathcal{T}_W is not a path, then it has at least two leaves \mathcal{C}_1 and \mathcal{C}_2 , and if neither of these are minimal collisions, then the set of collisions $\{\mathcal{C}\}$ such that $\mathcal{C} \rightarrow \mathcal{C}_1$ or $\mathcal{C} \rightarrow \mathcal{C}_2$ has size greater than 2. Because $\mathcal{F}(\mathcal{T})$ is a complete fan, this implies the codimension of $\tau(W)$ is greater than 1, a contradiction. \square

Lemma 5.59. *Suppose that $\tau(W)$ is a reduced wall of the triangulated velocity fan, then $\tau(W)$ is contained in a wall of the velocity fan.*

Proof. Let \mathcal{C}_1 be a minimal collision in W , then because $\tau(W)$ is reduced, we know that \mathcal{C}_1 is not a minimal collision in $\mathcal{K}(\mathcal{T})$. Therefore the n -bracketing $\mathcal{B} = \vee_{\mathcal{C} \in W} \mathcal{C}$ is not a maximal n -bracketing. Because $\tau(W)$ is a wall of the triangulated velocity fan, $\tau(\mathcal{B})$ must be a wall of the velocity fan, and we know $\tau(W) \subseteq \tau(\mathcal{B})$. \square

For $W \in \Delta_{\mathcal{T}}$ with codimension 1, let $\mathbf{v}(W)$ denote a primitive vector orthogonal to $\tau(W)$ and for $\mathcal{B} \in \mathcal{K}(\mathcal{T})$ with codimension 1, let $\mathbf{v}(\mathcal{B})$ denote a primitive vector orthogonal to $\tau(\mathcal{B})$. We note that $\mathbf{v}(W)$ and $\mathbf{v}(\mathcal{B})$ are only determined up to sign, but this will be inconsequential for us. Let $\tau(\mathcal{B})$ be a wall of the velocity fan and let $\tau(W)$ be a wall of the triangulated velocity fan contained in $\tau(\mathcal{B})$. For calculating

$\mathbf{v}(\mathcal{B}) = \mathbf{v}(W)$, we provide a reduction to the case where $\tau(W)$ is reduced. We will need the following basic lemma from linear algebra.

Lemma 5.60. *Suppose that $\mathbf{u}, \mathbf{v}_1, \dots, \mathbf{v}_k \in \mathbb{R}^m$ such that $\mathbf{u} \perp \mathbf{v}_i$ for $1 \leq i \leq k$. Let $A : \mathbb{R}^m \rightarrow \mathbb{R}^m$ be an invertible linear transformation. Then $A^{-1}(\mathbf{u}) \perp A^T(\mathbf{v}_i)$.*

Let $\tau(W)$ be a nonreduced wall of the triangulated velocity fan associated to a nested collection of collisions $\{\mathcal{C}_i : 1 \leq i \leq m-2\}$. Suppose that $\tau(W)$ is contained in a wall of the velocity fan associated to the n -bracketing \mathcal{B} . Suppose that \mathcal{C}_1 is a minimal collision which is containment-minimal in \mathcal{B} .

We begin by taking the following transformation of the ray generators for $\tau(W)$:

$$(156) \quad \bar{\rho}(\mathcal{C}_i) = \begin{cases} P_\sigma^T(\rho(\mathcal{C}_i) - \rho(\mathcal{C}_1)) & \text{if } \mathcal{C}_1 \rightarrow \mathcal{C}_i \\ P_\sigma^T \rho(\mathcal{C}_i) & \text{if } \mathcal{C}_1 \sim \mathcal{C}_i. \end{cases}$$

Lemmas 4.32 and 4.33 allow us to reinterpret these vectors. We would like to invoke Lemma 5.35 to reorganize the image of the quotients of the collisions as a collection of nested collisions, but we should be careful because the nested collection is not maximal. We observe that if the $\mathcal{C}_{i,r_i} \notin \{\mathcal{C}_{i-1,r} : 1 \leq r \leq s_{i-1}\}$ from Lemma 5.35 is not unique, then $\bigvee_{i=1}^{m-2} \mathcal{C}_i$ is a maximal bracketing, and this would contradict the assumption that $\tau(W)$ is contained in a wall of the velocity fan. Reorganize the image of the quotients as a collection of collisions which form a wall $\tau(W')$ for $W' \in \Delta_{\mathcal{T}/\mathcal{C}_1}$. Note that if we delete the 0 entry in $\bar{\rho}(\mathcal{C}_i)$ corresponding to the pair of k -brackets which collided in \mathcal{C}_1 , then the span of the resulting vectors is equal to the span of $\tau(W')$.

By induction on the size of \mathcal{T} , we can calculate $\mathbf{v}(W')$. Extend $\mathbf{v}(W')$ by adding one extra entry x in the place corresponding to the pair of k -brackets which collided in \mathcal{C}_1 and let this new vector be \mathbf{v}_x . To complete the calculation of $\mathbf{v}(W)$ we apply Lemma 5.60 and see that $(P_\sigma^T)^T(\mathbf{v}_x) = P_\sigma(\mathbf{v}_x) = \mathbf{v}(W)$. We only need to solve for the value of x and to do this we can use the fact that $\mathbf{v}(W) \perp \mathbf{1}$, i.e. the sum of the coordinates of $\mathbf{v}(W)$ is zero. This is particularly easy: suppose the fusion bracket of \mathcal{C}_1 is a k -bracket, then σ is the identity permutation for all entries corresponding to pairs of consecutive j -brackets for $j \leq k$. This implies that there is a single entry in $P_\sigma(\mathbf{v}_x)$ equal to x and this variable is not present anywhere else in the vector $P_\sigma(\mathbf{v}_x)$, so we take x equal to the negative of the sum of the remaining entries of $P_\sigma(\mathbf{v}_x)$.

It remains to calculate $\mathbf{v}(W)$ when $\tau(W)$ is reduced, which forms the base case of the inductive calculations described above.

Lemma 5.61. *Let $W = \{\mathcal{C}_1, \dots, \mathcal{C}_{m-2}\}$ be a collection of nested collisions such that $\tau(W)$ is a reduced wall of the triangulated velocity fan, and $\mathcal{C}_i \rightarrow \mathcal{C}_j$ for all $1 \leq i < j \leq m-2$. Then there exists a unique k -bracket $A \in \mathcal{C}_1^k$, with k taken minimum, such that $\mathcal{K}(A)$ is a 1-dimensional k -associahedron.*

Our argumentation here is closely related to that of Lemma 2.65.

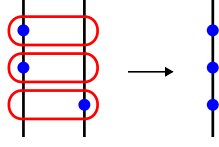

$$\rho(\mathcal{C}) = (1, 0, 3), \quad \sigma = (1, 312)$$

$$P_\sigma^T = \begin{pmatrix} 1 & 0 & 0 \\ 0 & -1 & -1 \\ 0 & 1 & 0 \end{pmatrix}, \quad (1, 1) \perp (1, -1)$$

$$\begin{pmatrix} 1 & 0 & 0 \\ 0 & -1 & 1 \\ 0 & -1 & 0 \end{pmatrix} \begin{pmatrix} x \\ 1 \\ -1 \end{pmatrix} = \begin{pmatrix} x \\ -2 \\ -1 \end{pmatrix}, \quad \begin{pmatrix} x \\ -2 \\ -1 \end{pmatrix} \perp (1, 1, 1) \Rightarrow x = 3.$$

$$\text{Observe } (3, -2, -1) \perp (1, 0, 3).$$

FIGURE 28. A recursive calculation of the normal vector for a wall of $W_{2,1}$.

Proof. Let \mathcal{C} be a minimal collision such that $\mathcal{C} \rightarrow \mathcal{C}_1$ and let $A \in \mathcal{C}^k$ such that there exists an $A' \in \mathcal{C}_1^k$ such that $A \subsetneq A'$, and we take k minimum by assuming that $\pi(A) = \pi(A')$. Then $\mathcal{K}(A)$ has dimension at least 1 and $\mathcal{C}|_A$ is a collision in $\mathcal{K}(A)$. Thus we can find some other collision in $\mathcal{K}(A)$ and extend it, using \mathcal{C}_1 outside of A , to obtain a collision $\mathcal{C}' \in \mathfrak{X}(\mathcal{T})$ such that $\mathcal{C}' \rightarrow \mathcal{C}_1$, $\mathcal{C}' \neq \mathcal{C}$ and $\mathcal{C}' \neq \mathcal{C}_1$. Therefore $\tau(W \cup \{\mathcal{C}\})$ and $\tau(W \cup \{\mathcal{C}'\})$ are two chambers of the triangulated velocity fan which contain $\tau(W)$, and thus are separated by $\tau(W)$ as a wall. Because $\mathcal{F}(\Delta\mathcal{T})$ is a complete fan, it must be that if $\mathcal{C}'' \in \mathfrak{X}(\mathcal{T})$ and $\mathcal{C}'' \rightarrow \mathcal{C}_1$ then $\mathcal{C}'' \in \{\mathcal{C}, \mathcal{C}'\}$. It follows that $\mathcal{K}(A)$ must be 1-dimensional with exactly two collisions corresponding to the restrictions of \mathcal{C} and \mathcal{C}' . Moreover, there is no other k -bracket in \mathcal{C}_1 with k minimum such that the restriction is positive dimensional. \square

Lemma 5.62. *Let $\tau(W)$ be a reduced wall of the triangulated velocity fan, and assume the notation of Definition 5.57. Let \mathcal{C}_1 be the unique collision which is minimal in W , and let A be the unique k -bracket in \mathcal{C}_1 , with k minimum, such that $\mathcal{K}(A)$ is a 1-dimensional n -associahedron.*

- (1) *Suppose the tree $\mathcal{T}(A)$ has three leaves. Let u_1 and u_2 be the vertices of degree at least three which are parents of these leaves (noting that u_1 and u_2 are potentially equal). Suppose the leftmost children of u_1, u_2 in $\mathcal{T}(A)$ correspond to $u_{i_1}^{k_1}, u_{i_2}^{k_2} \in V(\mathcal{T})$, respectively. Then $e_{i_1}^{k_1} - e_{i_2}^{k_2} \perp W$.*

(2) Suppose that $\mathcal{T}(A)$ has two leaves. Let u be the nearest common ancestor of these leaves in $\mathcal{T}(A)$, and suppose that $u_i^{k-2} \in V^{k-2}(\mathcal{T})$ corresponds to u . Let the $u_r^{k-1}, u_{r+1}^{k-1} \in V^{k-1}(\mathcal{T})$ correspond to the left and right children of u in $\mathcal{T}(A)$, respectively. Let $u_{s_1}^k, u_{s_2}^k \in V^k(\mathcal{T})$ correspond to the left and right grandchildren of u in $\mathcal{T}(A)$, respectively. Then

$$(157) \quad ((s_2 - s_1) e_r^{k-1} - \sum_{i=s_1}^{s_2-1} e_i^k) \perp W.$$

Before giving a proof, we note that in case (2), it must be that the vertices corresponding to the left and right children of u in $\mathcal{T}(A)$ are consecutive as the projection of $\mathcal{K}(\pi(A))$ must be zero dimensional and therefore the fusion bracket for \mathcal{C}_1 .

Proof. Let $W = \{\mathcal{C}_1, \dots, \mathcal{C}_{m-2}\}$ be a collection of nested collisions and assume that $\mathcal{C}_i \rightarrow \mathcal{C}_j$ for all $1 \leq i < j \leq m-2$. For verifying that statement we first observe that $\mathbf{v} \perp W$ if and only if $\mathbf{v} \perp \rho(\mathcal{C}_j)$ for $1 \leq j \leq m-2$. By Lemma 5.58, we know that the tree associated to W is a path. Hence for each j with $1 \leq j \leq m-2$, we have that there exists an essential k -bracket $A_j \in \mathcal{C}_j^k$ such that $A \subseteq A_j$. In particular, A_j contains all of the singleton brackets contained in A .

We employ Lemma 4.9 in what follows. If $\mathcal{T}(A)$ has three leaves as in case (1), then $\rho(\mathcal{C}_j)_{i_1}^{k_1} = \rho(\mathcal{C}_j)_{i_2}^{k_2} = 1$ for $1 \leq j \leq m-2$. On the other hand, if $\mathcal{T}(A)$ has two leaves as in case (2), then $\rho(\mathcal{C}_j)_r^{k-1} = 1$ and $\Delta_{s_1, s_2}^k(\rho(\mathcal{C}_j)) = s_2 - s_1$ for all $1 \leq j \leq m-2$. It follows that in both cases $\mathbf{v}(W)$ is equal to the vector described in the statement of the lemma. \square

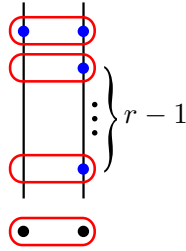

FIGURE 29. A collision \mathcal{C}_1 for a reduced wall in a triangulated velocity fan for a 2-associahedron with $A = (\{u_1^1, u_2^1\}, \{u_1^2, u_{r+1}^2\})$ depicted at the top. The associated normal vector is $r e_1^1 - \sum_{i=1}^r e_i^2$.

6. PIECEWISE-UNIMODULAR MAPS TO THE BRAID ARRANGEMENT

Categorical n -associahedra cannot be realized by generalized permutahedra, nor do they appear to be realizable in any of their known extensions (see footnote 7). On the other hand, our construction of the velocity fan generalizes the wonderful

associahedral fan, and the results of §5 are reminiscent of nestohedra, so it is quite natural to ask whether there exists an explicit connection between general velocity fans and the braid arrangement. In this section we give an affirmative answer to this question in two separate ways by constructing two different maps from the velocity fan to the braid arrangement. For the wonderful associahedral fan, both of these maps specialize to the identity map. For analyzing these maps, we view them as factoring through the isomorphism of the velocity fan with the metric n -bracketing complex.

The first map, addressed in subsection 6.1, will be a piecewise unimodular map from the velocity fan to the braid arrangement. This suggests an extension of the theory of generalized permutahedra which we call *permutahedroids*. The second map, addressed in subsection 6.2, will be a collection of piecewise unimodular maps ω_σ defined on local shuffle charts U_σ which cover the velocity fan. While the maps ω_σ do not glue to give a global piecewise-linear function on the velocity fan, they have other nice properties: each ω_σ is a piecewise unimodular isomorphism on the corresponding shuffle chart, and they provide a direct relationship to the theory of nestohedra via the triangulated velocity fan in subsection 6.3.

6.1. Piecewise-unimodular transformations and permutahedroids.

We begin by defining a new extension of coarsenings of the braid arrangement and generalized permutahedra. Recall the definition of the braid arrangement given in Definition 1.13.

Definition 6.1. Let \mathcal{F} be a fan. Suppose that there exists a piecewise-linear function f defined on \mathcal{F} such that for each cone $\tau \in \mathcal{F}$

- (1) the restricted function $f|_\tau$ is unimodular and invertible,
- (2) $f(\tau)$ is a union of cones in the braid arrangement.²³

Then we say that \mathcal{F} is a *locally-braid fan*. If P is a polytope whose normal fan is a locally-braid fan, then we say that P is a *permutahedroid*. △

Observe that when this f is restricted to be the identity map, locally-braid fans specialized to subfans of coarsenings of the braid arrangement, and permutahedroids specialize to generalized permutahedra. We now state the main result of this subsection.

Theorem 6.2. *Each velocity fan is a locally-braid fan.*

For a nontrivial example of a permutahedroid see Figure 5 depicting the 2-associahedron $W_{2,2}$. Note that this polytope is not combinatorially equivalent to a generalized permutahedron. In future work we aim to show that every velocity

²³Polyhedral cones which are unions of cones in the braid arrangement are sometimes called a *preposet cones* as they are in bijection with, and encode much of the combinatorial structure of, preposets. When the cones in question are full-dimensional, the corresponding preposets are honest posets, and by intersecting with standard cubes one recovers Stanley’s order polytopes. We refer the reader to the work of Postnikov-Reiner-Williams [PRW08] for further details.

HIGHER-CATEGORICAL ASSOCIAHEDRA

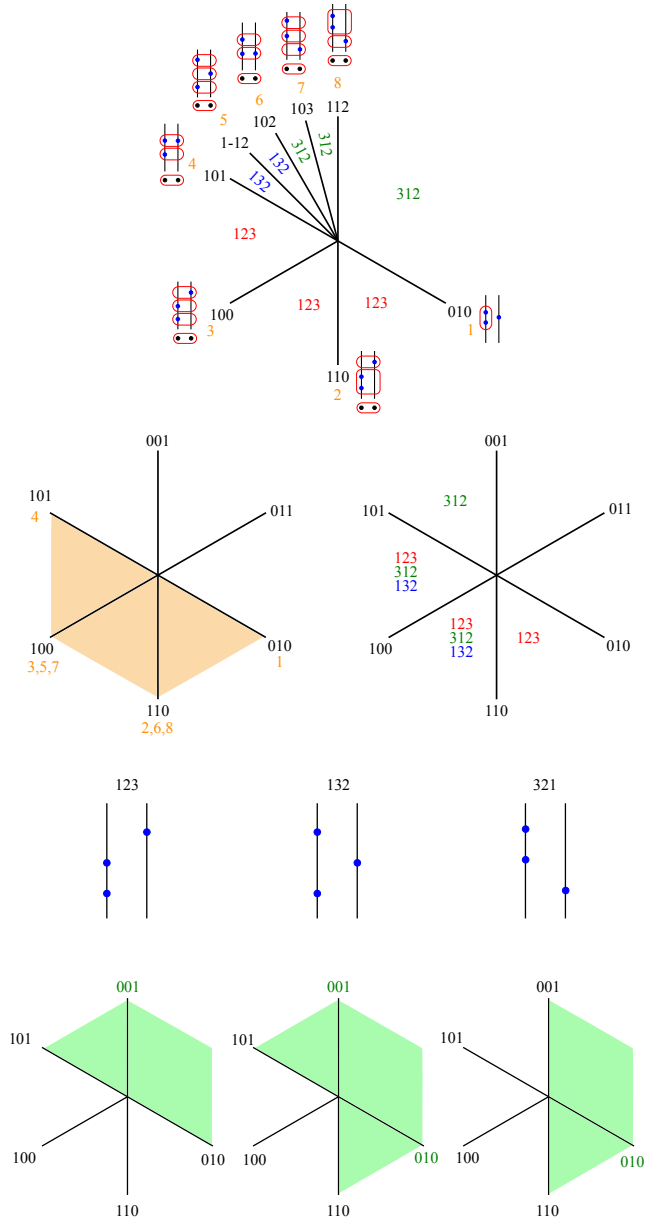

FIGURE 30. The top figure is the velocity fan of $W_{2,1}$ with a clockwise ordering on the rays, and a labeling of chambers by \mathcal{T} -shuffles. On the left of the second row is the image of the velocity fan under the map Γ_{ζ}^{ρ} ; on the right is the union of the images of shuffle charts under the maps $\Gamma_{\omega_{\sigma}}^{\rho}$. On the third and fourth rows are the three nestohedral fans associated to the images of the shuffle charts in $W_{2,1}$, and the stars of rays which are deleted.

fan is projective, thus settling Bottman's conjecture in the affirmative, and producing a large family of examples of permutahedroids. We are hopeful that the existence of these definitions may inspire researchers to discover other examples of such fans and polytopes.

In order to prove Theorem 6.2, we will first define for each collision \mathcal{C} a 0-1 vector $\zeta(\mathcal{C})$. We will then show that the map $\ell(\mathcal{C}) \mapsto \zeta(\mathcal{C})$ extends to a piecewise-linear function on all of $\mathcal{K}^{\text{met}}(\mathcal{T})$. By precomposing with Γ^{-1} we obtain a piecewise-linear map Γ_{ζ}^{ρ} defined on the velocity fan which satisfied the conditions from Definition 6.1.

Definition 6.3. Let $\mathcal{C} \in \mathfrak{X}(\mathcal{T})$. We take $\zeta(\mathcal{C})$ to be a vector of length m such that $\zeta(\mathcal{C})_i^k = 1$ if the vertex u_i^k belongs to an essential k -bracket $A \in \mathcal{C}^k$ with some u_j^k with $j > i$, and $\zeta(\mathcal{C})_i^k = 0$ otherwise. \triangle

Definition 6.4. Let $\{\mathcal{C}_i : 1 \leq i \leq k\}$ be a collection of compatible collisions. We define a cone associated to this collection:

$$(158) \quad \tau_{\zeta}\{\mathcal{C}_i\} = \text{cone}\{\zeta(\mathcal{C}_1), \dots, \zeta(\mathcal{C}_k)\} + \langle \mathbf{1} \rangle_{\mathbb{R}}.$$

Let \mathcal{B} be an n -bracketing and suppose $\{\mathcal{C}_i\}$ is the set of all collisions contained in \mathcal{B} . We define the cone $\tau_{\zeta}(\mathcal{B}) = \tau_{\zeta}\{\mathcal{C}_i\}$. Similarly, given a face $Y \in \Delta_{\mathcal{T}}$, or $Y \in \mathcal{O}(\mathcal{T})$, we define $\tau_{\zeta}(Y) = \tau_{\zeta}\{\mathcal{C}_i\}$ where $Y = \{\mathcal{C}_i\}$. \triangle

Definition 6.5. Let $\mathcal{C}_0, \dots, \mathcal{C}_k \in \widehat{\mathfrak{X}}(\mathcal{T})$ be such that $\mathcal{C}_0 = \mathcal{B}_{\min}$, and let $\lambda_i \in \mathbb{R}$ for $0 \leq i \leq k$ with $\lambda_i \geq 0$ for $i > 0$. Let $\ell_{\mathcal{B}} \in \mathcal{K}^{\text{met}}(\mathcal{T})$ such that

$$(159) \quad \ell_{\mathcal{B}} = \sum_{i=0}^k \lambda_i \ell(\mathcal{C}_i).$$

We define the map $\Gamma_{\zeta} : \mathcal{K}^{\text{met}}(\mathcal{T}) \rightarrow \mathbb{R}^m$ as

$$(160) \quad \Gamma_{\zeta}(\ell_{\mathcal{B}}) = \sum_{i=0}^k \lambda_i \zeta(\mathcal{C}_i).$$

Lemma 6.6. *The map Γ_{ζ} defines a piecewise-linear map which restricts to a linear injection on each conical set in $\mathcal{K}^{\text{met}}(\mathcal{T})$.*²⁴

We will prove Lemma 6.6 by an argument similar to the one used for proving Proposition 4.13, although this version of the argument will be easier because, for example, we do not need to prove that Γ_{ζ} is globally injective (as it is not). We will establish Lemma 6.6 by way of the following lemma.

Lemma 6.7. *Suppose that $\{\mathcal{C}_0, \dots, \mathcal{C}_{l_1}\}$ and $\{\underline{\mathcal{C}}_0, \dots, \underline{\mathcal{C}}_{l_2}\}$ are two sets of compatible extended collisions contained in \mathcal{B} . Let $\mathcal{C}^0 = \underline{\mathcal{C}}_0 = \mathcal{B}_{\min}$ and take $\lambda_i, \gamma_i \in \mathbb{R}$ for $0 \leq i \leq l_1$ and $0 \leq i \leq l_2$ and $\lambda_i, \gamma_i \geq 0$ for $i > 0$. Then*

$$(161) \quad \sum_{0 \leq i \leq l_1} \lambda_i \ell(\mathcal{C}_i) = \sum_{0 \leq i \leq l_2} \gamma_i \ell(\underline{\mathcal{C}}_i)$$

²⁴Equivalently, Γ_{ζ} is a weak embedding of the cone complex $\mathcal{K}^{\text{met}}(\mathcal{T})$.

if and only if

$$(162) \quad \sum_{0 \leq i \leq l_1} \lambda_i \zeta(\mathcal{C}_i) = \sum_{0 \leq i \leq l_2} \gamma_i \zeta(\underline{\mathcal{C}}_i).$$

Proof. (6.6) It is clear that if Γ_ω is well-defined, it is linear on the conical sets of $\mathcal{K}^{\text{met}}(\mathcal{T})$ and agrees on their intersections. It follows by Lemma 6.7 that Γ_ω is well-defined and injective on each conical set of $\mathcal{K}^{\text{met}}(\mathcal{T})$. \square

Lemma 6.8. *Let $\mathcal{B} \in \mathcal{K}(\mathcal{T})$, then $\pi(\tau_\zeta(\mathcal{B})) = \tau_\zeta(\pi(\mathcal{B}))$.*

Proof. The statement is clear from the definition of ζ and $\tau_\zeta(\mathcal{B})$ together with the fact that taking conical combinations commutes with applying projection maps. \square

Lemma 6.9. *Let $\mathbf{v} \in \tau_\zeta(\mathcal{B})$. There exists an extended collision $\mathcal{C}_{\mathcal{B}, \mathbf{v}}$, which is a function of \mathcal{B} and \mathbf{v} , such that for every set of compatible extended collisions $\{\mathcal{C}_i : 0 \leq i \leq k\}$ with $\mathcal{C}_0 = \mathcal{B}_{\min}$ such that $\mathcal{C}_i \leq \mathcal{B}$, and $\mathbf{v} = \sum_{i=0}^k \lambda_i \zeta(\mathcal{C}_i)$, with $\lambda_i > 0$ for $i > 0$, we have that $\mathcal{C}_{\mathcal{B}, \mathbf{v}}$ is containment-minimal in $\bigvee_{i=1}^k \mathcal{C}_i$.*

Lemma 6.7 is a direct consequence of Lemma 6.12, which allows us to identify containment-minimal collisions. Lemma 6.12 requires the following Definition 6.10.

Definition 6.10. Given $\mathbf{v} \in \tau_\zeta(\mathcal{B})$, we define a collection of collisions $\Xi(\mathcal{B}, \mathbf{v})$ associated to \mathbf{v} and \mathcal{B} . This set will be described as the union of two other sets $\Xi_1(\mathcal{B}, \mathbf{v})$ and $\Xi_2(\mathcal{B}, \mathbf{v})$. Let $\tilde{\mathcal{B}}$ be the $(n-1)$ -bracketing in $\mathcal{K}(\pi(\mathcal{T}))$ with $\tilde{\mathcal{B}} \leq \pi(\mathcal{B})$ and $\ell_{\tilde{\mathcal{B}}}$ the unique metric $(n-1)$ -bracketing supported on $\tilde{\mathcal{B}}$ with $\Gamma_\zeta(\ell_{\tilde{\mathcal{B}}}) = \pi(\mathbf{v})$.²⁵ Given an $(n-1)$ -bracket $A \in \tilde{\mathcal{B}}^{n-1}$, recall the notation

$$(163) \quad \gamma(\ell_{\tilde{\mathcal{B}}}, A) = \sum_{\substack{A' \in \tilde{\mathcal{B}}^{n-1} \\ A \subset A'}} \ell_{\tilde{\mathcal{B}}}(A').$$

Let \mathcal{C} be a collision such that $\mathcal{C} \leq \mathcal{B}$, then

- (1) $\mathcal{C} \in \Xi_1(\mathcal{B}, \mathbf{v})$ if
 - (a) \mathcal{C} is type 1 with fusion n -bracket A .
 - (b) There exists a real number $w_\zeta(\mathcal{B}, \mathbf{v}, \mathcal{C}) > \gamma(\ell_{\tilde{\mathcal{B}}}, \pi(A))$ such that $u_{j-1}^n, u_j^n \in A^n$, precisely when $v_{j-1}^n = w_\zeta(\mathcal{B}, \mathbf{v}, \mathcal{C})$.
 - (c) For any n -bracket $\tilde{A} \in \mathcal{B}^n$ with $A \subsetneq \tilde{A}$ and $\pi(A) = \pi(\tilde{A})$, there exists $u_{j-1}^n, u_j^n \in \tilde{A}^n$ with $v_{j-1}^n < w_\zeta(\mathcal{B}, \mathbf{v}, \mathcal{C})$.
- (2) $\mathcal{C} \in \Xi_2(\mathcal{B}, \mathbf{v})$ if
 - (a) \mathcal{C} is not type 1,
 - (b) There exists no $\mathcal{C}' \in \Xi_1(\mathcal{B}, \mathbf{v})$ such that $\mathcal{C}' \rightarrow \mathcal{C}$.
 - (c) $\pi(\mathcal{C})$ is containment-minimal in $\tilde{\mathcal{B}}$,
 - (d) For each $A \in \mathcal{C}^n$ and $u_j^n, u_k^n \in A^n$, with $j < k$, we have $v_j^n = \gamma(\ell_{\tilde{\mathcal{B}}}, \pi(A))$.

²⁵The existence and uniqueness of $\ell_{\tilde{\mathcal{B}}}$ is afforded by Lemma 6.8 together with induction on n applied to Lemma 6.6.

We define

$$(164) \quad \Xi(\mathcal{B}, \mathbf{v}) = \Xi_1(\mathcal{B}, \mathbf{v}) \cup \Xi_2(\mathcal{B}, \mathbf{v}).$$

△

Remark 6.11. Unlike Definition 4.35, we do not need a conditions like 2(d)ii or 2(d)iii above because the height partial order is inherited by from \mathcal{B} . △

Lemma 6.12. *Let $\{\mathcal{C}_i : 1 \leq i \leq k\}$ be a set of compatible collisions and let*

$$(165) \quad \mathcal{B} = \bigvee_{i=1}^k \mathcal{C}_i.$$

Let $\mathbf{v} = \sum_{i=0}^k \lambda_i \zeta(\mathcal{C}_i)$ with $\mathcal{C}_0 = \mathcal{B}_{\min}$, $\lambda_i \in \mathbb{R}$, and $\lambda_i > 0$ for $i > 0$. Then \mathcal{C} is containment-minimal in \mathcal{B} if and only if $\mathcal{C} \in \Xi(\mathcal{B}, \mathbf{v})$.

Proof. Suppose that \mathcal{C} is type 1 and containment-minimal in \mathcal{B} , then $\mathcal{C} \in \Xi_1(\mathcal{B}, \mathbf{v})$. Conversely, if $\mathcal{C} \in \Xi_1(\mathcal{B}, \mathbf{v})$, it is straightforward to verify that \mathcal{C} is containment-minimal in \mathcal{B} . Suppose that \mathcal{C} is not type 1 and is containment-minimal in \mathcal{B} , then it is clear that $\mathcal{C} \in \Xi_2(\mathcal{B}, \mathbf{v})$. The converse when \mathcal{C} is not type 1 is also straightforward. □

Proof. (6.7) Supposing the notational set up of Lemma 6.7, and

$$(166) \quad \ell_{\mathcal{B}} = \sum_{0 \leq i \leq l_1} \lambda_i \ell(\mathcal{C}_i) = \sum_{0 \leq i \leq l_2} \gamma_i \ell(\underline{\mathcal{C}}_i).$$

We claim that

$$(167) \quad \sum_{0 \leq i \leq l_1} \lambda_i \zeta(\mathcal{C}_i) = \sum_{0 \leq i \leq l_2} \gamma_i \zeta(\underline{\mathcal{C}}_i).$$

Let $\sum_{0 \leq i \leq l_1} \lambda_i \zeta(\mathcal{C}_i) = \mathbf{w}$ and $\sum_{0 \leq i \leq l_2} \gamma_i \zeta(\underline{\mathcal{C}}_i) = \mathbf{v}$. We observe that each coordinate v_i^k is an invariant of the metric n -bracketing $\ell_{\mathcal{B}} : v_i^k$ is the sum of $\ell_{\mathcal{B}}(A)$ where A ranges over all essential k -brackets which contain u_i^k and some other vertex u_j^k with $i < j$, thus $w_i^k = v_i^k$, and $\mathbf{w} = \mathbf{v}$.

For establishing the converse, suppose

$$(168) \quad \mathbf{v} = \sum_{0 \leq i \leq l_1} \lambda_i \zeta(\mathcal{C}_i) = \sum_{0 \leq i \leq l_2} \gamma_i \zeta(\underline{\mathcal{C}}_i).$$

We wish to prove that

$$(169) \quad \sum_{0 \leq i \leq l_1} \lambda_i \ell(\mathcal{C}_i) = \sum_{0 \leq i \leq l_2} \gamma_i \ell(\underline{\mathcal{C}}_i).$$

By Lemma 6.25 we can find a collision which is containment-minimal in the support of both metric n -bracketings $\sum_{0 \leq i \leq l_1} \lambda_i \ell(\mathcal{C}_i)$ and $\sum_{0 \leq i \leq l_2} \gamma_i \ell(\underline{\mathcal{C}}_i)$. The proof is completed by following the same inductive argument utilized in the proof of Lemma 4.16 when demonstrating that (55) implies (54). □

We conclude this section with a proof of the main Theorem 6.2.

Proof. (6.2) We will verify the conditions of Definition 6.1 with $f = \Gamma_\zeta^\rho$. The statement that Γ_ζ^ρ is a well-defined piecewise-linear map is clear as Γ and Γ_ζ are both piecewise-linear and Γ is invertible by Proposition 4.13. We will now focus on verifying condition (1). The injectivity, equivalently invertibility, of Γ_ζ^ρ on each cone follows as Γ_ζ is injective on conical sets by Lemma 6.6.

Next we will prove that Γ_ζ^ρ is unimodular on each cone in the velocity fan. It suffices to show that if we have a chamber $\tau(\mathcal{B}) \in \mathcal{F}(\mathcal{T})$, a linearly independent unimodular collection of vectors $B = \{v_1 \dots, v_{m-1}, \mathbf{1}\}$ contained in $\tau(\mathcal{B})$, then the image $\Gamma_\zeta^\rho(B)$ in $\tau_\zeta(\mathcal{B})$ is unimodular. To do so, we will utilize the permutahedral velocity fan introduced in subsection 5.6. Let $Z \in \mathcal{O}(\mathcal{T})$ with $Z = \{\mathcal{D}_1, \dots, \mathcal{D}_{m-1}\}$ such that $\tau(Z) \subseteq \tau(\mathcal{B})$, and take $B = \{\rho(\mathcal{D}_1), \dots, \rho(\mathcal{D}_{m-1}), \mathbf{1}\}$, the generators for $\tau(Z)$. By Proposition 5.48 combined with Theorem 5.12, we have that B is a linearly independent unimodular collection in $\tau(\mathcal{B})$. Hence it suffices to prove that $\{\Gamma_\zeta^\rho(\rho(\mathcal{D}_1)), \dots, \Gamma_\zeta^\rho(\rho(\mathcal{D}_{m-1}), \mathbf{1}\}$ form the columns of a unimodular matrix. In fact we claim that $\{\Gamma_\zeta^\rho(\rho(\mathcal{D}_1)), \dots, \Gamma_\zeta^\rho(\rho(\mathcal{D}_{m-1}), \mathbf{1}\}$ form the generators for a chamber in the braid arrangement, i.e. they form indicator vectors for a maximal chain of subsets of $[m]$. To see this simply observe that for $1 \leq i \leq m - 2$, when passing from $\Gamma_\zeta^\rho(\rho(\mathcal{D}_i))$ to $\Gamma_\zeta^\rho(\rho(\mathcal{D}_{i+1}))$ we increase a single entry from 0 to 1.

Condition (2) is now an immediate consequence of the above argument. We know by the injectivity of Γ_ζ^ρ on $\tau(\mathcal{B})$ that $\tau_\zeta(\mathcal{B})$ is equal to the union of all $\tau_\zeta(Z)$ where Z ranges over all flags of generalized collisions such that $\tau^{\text{met}}(Z) \subseteq \tau^{\text{met}}(\mathcal{B})$. \square

Remark 6.13. It follows that $\tau_\zeta(\mathcal{B})$ is a poset cone with face poset equal to $[\mathcal{B}_{\min}, \mathcal{B}]$. Moreover, in the above proof, we passed from the velocity fan to the permutahedral velocity fan, skipping over the triangulated velocity fan, but one can see that for $Y \in \Delta_{\mathcal{T}}$, the corresponding cone $\tau_\zeta(Y)$ is a tree poset cone associated to the tree \mathcal{T}_Y from Theorem 5.29. \triangle

6.2. The shuffle atlas for the velocity fan.

In this section we describe a family $\omega = \{\omega_\sigma\}$ of piecewise-unimodular maps defined on subsets of the metric n -bracketing complex, called *shuffle charts*, associated to linear extensions of the extended height partial order on the singleton brackets in an n -bracketing. We will see that each ω_σ is a piecewise-linear isomorphism and that the image of each conical set is a union of cones in the braid arrangement. Moreover, when we extend these maps to the velocity fan by precomposing with Γ^{-1} , we find that they are unimodular on each cone. In subsection 6.3 we show that for each σ , when ω_σ is applied to a shuffle chart in the triangulated metric n -bracketing complex, its image is a subfan of a nestohedral fan obtained by deleting the stars of certain coordinate rays.

Definition 6.14. Given a $\mathcal{B} \in \mathcal{K}(\mathcal{T})$ we define the *admissible \mathcal{T} -shuffles* of \mathcal{B} to be the set $\mathfrak{S}(\mathcal{B}) \subseteq S_{\mathcal{T}}$ where $\sigma = (\sigma_1, \dots, \sigma_n)$ satisfies $\sigma \in \mathfrak{S}(\mathcal{B})$ if each σ_k

linearly extends the extended height partial order $\widehat{<}_{\mathcal{B}}$ on $V^k(\mathcal{T})$, and if $A \in \mathcal{B}^k$ is a nontrivial bracket, and $a < b < c$, we disallow $u_{\sigma(a)}^k, u_{\sigma(c)}^k \in A^k$ and $u_{\sigma(b)}^k \notin A^k$. \triangle

Note that for $\mathcal{B}' \leq \mathcal{B}$, we have $\mathfrak{S}(\mathcal{B}') \subseteq \mathfrak{S}(\mathcal{B})$, and $\mathfrak{S}(\mathcal{B}_{\min}) = S_{\mathcal{T}}$.

Lemma 6.15. *Let $\mathcal{B} \in \mathcal{K}(\mathcal{T})$ be a maximal n -bracketing, then $|\mathfrak{S}(\mathcal{B})| = 1$.*

Proof. Suppose for contradiction that there exists $\sigma_1, \sigma_2 \in \mathfrak{S}(\mathcal{B})$ with $\sigma_1 \neq \sigma_2$. Because $\pi(\mathcal{B})$ is a maximal $(n-1)$ -bracketing in $\mathcal{K}(\pi(\mathcal{T}))$, we may apply induction on n to obtain $\pi(\sigma_1) = \pi(\sigma_2)$. Let $u_i^n, u_j^n \in V(\mathcal{T})^n$ such that $\sigma_1^n(i) < \sigma_1^n(j)$, but $\sigma_2^n(i) > \sigma_2^n(j)$. Let $A \in \mathcal{B}^n$ be such that A^n is the smallest n -bracket which contains both u_i^n and u_j^n , A_1 is the largest n -bracket which contains u_i^n , but not u_j^n , and A_2 is the largest n -bracket which contains u_j^n , but not u_i^n . By the assumption that u_i^n and u_j^n are incomparable with respect to $\widehat{<}_{\mathcal{B}}$ we must have $\pi(A_1) \cap \pi(A_2) = \emptyset$. We claim that we can add a pair of additional n -bracket to \mathcal{B} , contradicting its maximality. Let \widetilde{A}_1 be the n -bracket with $\pi(\widetilde{A}_1) = \pi(A)$ and $\widetilde{A}_1^n = \{u \in V(\mathcal{T})^n : u \in A, \pi(u) \in \pi(A_1)^{n-1}\}$ and \widetilde{A}_2 be the n -bracket with $\pi(\widetilde{A}_2) = \pi(A)$ and $\widetilde{A}_2^n = \{u \in V(\mathcal{T})^n : u \in A, \pi(u) \in (\pi(A)^{n-1} \setminus \pi(A_1)^{n-1})\}$. Then $\widetilde{\mathcal{B}}$ is the n -bracketing with $\widetilde{\mathcal{B}}^k = \mathcal{B}^k$ for $k < n$ and $\widetilde{\mathcal{B}}^n = \mathcal{B}^n \cup \{\widetilde{A}_1, \widetilde{A}_2\}$, equipped with the additional relation $\widetilde{A}_1 <_{\widetilde{\mathcal{B}}} \widetilde{A}_2$. It is straightforward to verify that $\widetilde{\mathcal{B}}$ is an n -bracketing. \square

Remark 6.16. For $\mathcal{B} \in \mathcal{K}(\mathcal{T})$, it can be shown that $\sigma \in \mathfrak{S}(\mathcal{B})$ if and only if there exists a maximal n -bracketing \mathcal{B}' with $\mathcal{B} \leq \mathcal{B}'$ such that $\{\sigma\} = \mathfrak{S}(\mathcal{B}')$.

Definition 6.17. Let \mathcal{C} be a collision such that $\sigma \in \mathfrak{S}(\mathcal{C})$. We take $\omega_{\sigma}(\mathcal{C})$ to be a vector of length m such that $\omega_{\sigma}(\mathcal{C})_i^k = 1$ if the vertices $u_{\sigma(i)}^k$ and $u_{\sigma(i+1)}^k$ belong to an essential k -bracket $A \in \mathcal{C}^k$, and $\omega_{\sigma}(\mathcal{C})_i^k = 0$ otherwise. \triangle

Definition 6.18. Let $\{\mathcal{C}_i : 1 \leq i \leq s\}$ be a collection of compatible collisions and $\sigma \in S_{\mathcal{T}}$ such that $\sigma \in \mathfrak{S}(\mathcal{C}_i)$ for each i with $1 \leq i \leq s$. We define a cone associated to this collection as

$$(170) \quad \tau_{\omega_{\sigma}}\{\mathcal{C}_i\} = \text{cone}\{\omega_{\sigma}(\mathcal{C}_1), \dots, \omega_{\sigma}(\mathcal{C}_k)\} + \langle \mathbf{1} \rangle_{\mathbb{R}}.$$

Let \mathcal{B} be an n -bracketing and suppose $\{\mathcal{C}_i\}$ is the set of all collisions contained in \mathcal{B} . We define the cone $\tau_{\omega_{\sigma}}(\mathcal{B}) = \tau_{\omega_{\sigma}}\{\mathcal{C}_i\}$. Similarly, given a face $Y \in \Delta_{\mathcal{T}}$, or $Y \in \mathcal{O}(\mathcal{T})$, we define $\tau_{\omega_{\sigma}}(Y) = \tau_{\omega_{\sigma}}\{\mathcal{C}_i\}$ where $Y = \{\mathcal{C}_i\}$. \triangle

Definition 6.19. Given $\sigma \in S_{\mathcal{T}}$, we define the *shuffle chart* of the metric n -bracketing complex associated to σ to be the pair $(U_{\sigma}, \Gamma_{\omega_{\sigma}})$ where

$$(171) \quad U_{\sigma} = \{\tau^{\text{met}}(\mathcal{B}) \in \mathcal{K}^{\text{met}}(\mathcal{T}) : \sigma \in \mathfrak{S}(\mathcal{B})\}$$

and $\Gamma_{\omega_{\sigma}} : U_{\sigma} \rightarrow \mathbb{R}^m$ is defined as follows. Let $\mathcal{C}_0, \dots, \mathcal{C}_k \in \widehat{\mathfrak{X}}(\mathcal{T})$ with $\mathcal{C}_0 = \mathcal{B}_{\min}$, and $\lambda_i \in \mathbb{R}$ for $0 \leq i \leq k$ with $\lambda_i \geq 0$ for $i > 0$. Let $\ell_{\mathcal{B}} \in U_{\sigma}$ be such that

$$(172) \quad \ell_{\mathcal{B}} = \sum_{i=0}^k \lambda_i \ell(\mathcal{C}_i).$$

We define the map $\Gamma_{\omega_\sigma} : U_\sigma \rightarrow \mathbb{R}^m$, as

$$(173) \quad \Gamma_{\omega_\sigma}(\ell_{\mathcal{B}}) = \sum_{i=0}^k \lambda_i \omega_\sigma(\mathcal{C}_i).$$

The *shuffle atlas for the metric n -bracketing complex* is the collection of all shuffle charts $\{(U_\sigma, \Gamma_{\omega_\sigma})\}$ where $\sigma = (\sigma_1, \dots, \sigma_n)$ ranges over all $\sigma \in S_{\mathcal{T}}$. We similarly define *the shuffle atlas for the velocity fan* as the collection of *shuffle charts* $\{\Gamma(U_\sigma), \Gamma_{\omega_\sigma}^\rho\}$ where $\Gamma_{\omega_\sigma}^\rho = \Gamma_{\omega_\sigma} \circ \Gamma^{-1}$. \triangle

We remark that at this stage, it is not clear that Γ_{ω_σ} is well-defined, but U_σ clearly is.

Proposition 6.20. *For each $\sigma \in S_{\mathcal{T}}$, the map $\Gamma_{\omega_\sigma}^\rho$ is an injective piecewise-unimodular map on $\Gamma(U_\sigma)$, and the image of each cone is a union of cones in the braid arrangement.*

Proof. The statement that $\Gamma_{\omega_\sigma}^\rho$ is an injective piecewise-linear map on $\Gamma(U_\sigma)$ reduces to the corresponding statement for Γ_{ω_σ} , which is a consequence of the following Lemma 6.21. That the image of each cone is a union of cones in the braid arrangement is established in Corollary 6.38, and that $\Gamma_{\omega_\sigma}^\rho$ is unimodular on each cone is Corollary 6.39. \square

Lemma 6.21. *Suppose that $\{\mathcal{C}_0, \dots, \mathcal{C}_{l_1}\}$ and $\{\underline{\mathcal{C}}_0, \dots, \underline{\mathcal{C}}_{l_2}\}$ are two sets of compatible extended collisions such that $\sigma \in \mathfrak{S}(\mathcal{C}_i)$ for $1 \leq i \leq l_1$ and $\sigma \in \mathfrak{S}(\underline{\mathcal{C}}_i)$ for $1 \leq i \leq l_2$. Let $\mathcal{C}_0 = \underline{\mathcal{C}}_0 = \mathcal{B}_{\min}$, take $\lambda_i, \gamma_i \in \mathbb{R}$ for $0 \leq i \leq l_1$ and $0 \leq i \leq l_2$, and $\lambda_i, \gamma_i \geq 0$ for $i > 0$. Then*

$$(174) \quad \sum_{0 \leq i \leq l_1} \lambda_i \ell(\mathcal{C}_i) = \sum_{0 \leq i \leq l_2} \gamma_i \ell(\underline{\mathcal{C}}_i)$$

if and only if

$$(175) \quad \sum_{0 \leq i \leq l_1} \lambda_i \omega_\sigma(\mathcal{C}_i) = \sum_{0 \leq i \leq l_2} \gamma_i \omega_\sigma(\underline{\mathcal{C}}_i).$$

We will follow an argument similar to the one used for proving Lemmas 6.7 and 4.16.

Lemma 6.22. *Let $\mathcal{B} \in \mathcal{K}(\mathcal{T})$ and $\sigma \in S_{\mathcal{T}}$, then $\pi(\tau_{\omega_\sigma}(\mathcal{B})) = \tau_{\omega_{\pi(\sigma)}}(\pi(\mathcal{B}))$.*

Proof. The statement is clear from the definitions of ω_σ and $\tau_{\omega_\sigma}(\mathcal{B})$ together with the fact that taking conical combinations commutes with applying projection maps. \square

Lemma 6.23. *Let $\sigma \in S_{\mathcal{T}}$ and $\mathbf{v} \in \omega_\sigma(U_\sigma)$. There exists a collision $\mathcal{C}_{(\sigma, \mathbf{v})}$, which is a function of σ and \mathbf{v} , such that for every set of compatible collisions $\{\mathcal{C}_i : 1 \leq i \leq k\}$ such that $\sigma \in \mathfrak{S}(\mathcal{C}_i)$, and $\mathbf{v} = \sum_{i=0}^k \lambda_i \omega_\sigma(\mathcal{C}_i)$ with $\mathcal{C}_0 = \mathcal{B}_{\min}$, $\lambda_i \in \mathbb{R}$ and $\lambda_i > 0$ for $i > 0$, we have that $\mathcal{C}_{(\sigma, \mathbf{v})}$ is containment-minimal in $\bigvee_{i=1}^k \mathcal{C}_i$.*

We will establish Lemma 6.23 as consequence of Lemma 6.25, which allows us to identify containment-minimal collisions. Lemma 6.25 requires the following Definition 6.24.

Definition 6.24. Given $\mathbf{v} \in \omega_\sigma(U_\sigma)$, we define a collection of collisions $\Xi(\sigma, \mathbf{v})$ associated to \mathbf{v} and σ . This set will be described as the union of sets $\Xi_1(\sigma, \mathbf{v})$ and $\Xi_2(\sigma, \mathbf{v})$. Let $\ell_{\tilde{\mathcal{B}}}$ be the unique metric $(n-1)$ -bracketing in $\pi(U_\sigma)$ such that $\Gamma_{\omega_{\pi(\sigma)}}(\ell_{\tilde{\mathcal{B}}}) = \pi(\mathbf{v})$.²⁶

Let \mathcal{C} be a collision such that $\sigma \in \mathfrak{S}(\mathcal{C})$, then

- (1) $\mathcal{C} \in \Xi_1(\sigma, \mathbf{v})$ if
 - (a) \mathcal{C} is type 1 with fusion n -bracket A ,
 - (b) There exists a constant $w_\omega(\sigma, \mathbf{v}, \mathcal{C}) > \gamma(\ell_{\tilde{\mathcal{B}}}, A)$ such that for $u_{\sigma(j)}^n$ and $u_{\sigma(j+1)}^n$ in A^n , we have $v_j^n = w_\omega(\sigma, \mathbf{v}, \mathcal{C})$.
 - (c) For any n -bracket A' with $A \subsetneq A'$ and $\pi(A') = \pi(A)$, there exists $u_{\sigma(j)}^n, u_{\sigma(j+1)}^n \in A'^n$ with $v_j^n < w_\omega(\sigma, \mathbf{v}, \mathcal{C})$.
- (2) $\mathcal{C} \in \Xi_2(\sigma, \mathbf{v})$ if
 - (a) \mathcal{C} is type 2
 - (b) There exists no $\mathcal{C}' \in \Xi_1(\sigma, \mathbf{v})$ such that $\mathcal{C}' \rightarrow \mathcal{C}$.
 - (c) $\pi(\mathcal{C})$ is containment-minimal in $\tilde{\mathcal{B}}$,
 - (d) For each $A \in \mathcal{C}^n$ and $u_{\sigma(j)}^n, u_{\sigma(j+1)}^n \in A^n$, we have $v_j^n = \gamma(\ell_{\tilde{\mathcal{B}}}, \pi(A))$.

We define

$$(176) \quad \Xi(\sigma, \mathbf{v}) = \Xi_1(\sigma, \mathbf{v}) \cup \Xi_2(\sigma, \mathbf{v}).$$

△

Lemma 6.25. Let $\{\mathcal{C}_i : 1 \leq i \leq k\}$ be a set of compatible collisions such that $\sigma \in \mathfrak{S}(\mathcal{C}_i)$ for $1 \leq i \leq k$, and let $\mathcal{B} = \bigvee_{i=1}^k \mathcal{C}_i$. Let $\mathbf{v} = \sum_{i=0}^k \lambda_i \omega_\sigma(\mathcal{C}_i)$ with $\mathcal{C}_0 = \mathcal{B}_{\min}$, $\lambda_i \in \mathbb{R}$, and $\lambda_i > 0$ for $i > 0$. Then \mathcal{C} is containment-minimal in \mathcal{B} if and only if $\mathcal{C} \in \Xi(\sigma, \mathbf{v})$.

Proof. Suppose that \mathcal{C} is type 1 and \mathcal{C} is containment-minimal in \mathcal{B} , then it is clear that $\mathcal{C} \in \Xi_1(\sigma, \mathbf{v})$. Conversely, if $\mathcal{C} \in \Xi_1(\sigma, \mathbf{v})$, it is a type 1 collision such that \mathcal{C} is containment-minimal in \mathcal{B} . Suppose that \mathcal{C} is not type 1 and \mathcal{C} is containment-minimal in \mathcal{B} , then it is clear that $\mathcal{C} \in \Xi_2(\sigma, \mathbf{v})$. The converse where $\mathcal{C} \in \Xi_2(\sigma, \mathbf{v})$ is also straightforward. □

Proof. (6.21) Supposing the notational setup of Theorem 6.21, let

$$(177) \quad \ell_{\mathcal{B}} = \sum_{0 \leq i \leq l_1} \lambda_i \ell(\mathcal{C}_i) = \sum_{0 \leq i \leq l_2} \gamma_i \ell(\underline{\mathcal{C}}_i).$$

²⁶The existence and uniqueness of $\ell_{\tilde{\mathcal{B}}}$ is afforded by Lemma 6.22 together with induction on n applied to Lemma 6.21, and the fact that $\pi(U_\sigma) = U_{\pi(\sigma)} \subseteq \mathcal{K}(\pi(\mathcal{T}))$.

We claim that

$$(178) \quad \sum_{0 \leq i \leq l_1} \lambda_i \omega_\sigma(\mathcal{C}_i) = \sum_{0 \leq i \leq l_2} \gamma_i \omega_\sigma(\underline{\mathcal{C}}_i).$$

Let $\sum_{0 \leq i \leq l_1} \lambda_i \omega_\sigma(\mathcal{C}_i) = \mathbf{w}$ and $\sum_{0 \leq i \leq l_2} \gamma_i \omega_\sigma(\underline{\mathcal{C}}_i) = \mathbf{v}$. We observe that a coordinate v_j^k of \mathbf{v} equal to the weighted sum of $\ell_{\mathcal{B}}(A)$ over the k -brackets A which contain $u_{\sigma(j)}^k$ and $u_{\sigma(j+1)}^k$. This is an invariant of the metric n -bracketing $\ell_{\mathcal{B}}$, thus $w_j^k = v_j^k$, and $\mathbf{w} = \mathbf{v}$.

For establishing the converse, suppose

$$(179) \quad \mathbf{v} = \sum_{0 \leq i \leq l_1} \lambda_i \omega_\sigma(\mathcal{C}_i) = \sum_{0 \leq i \leq l_2} \gamma_i \omega_\sigma(\underline{\mathcal{C}}_i).$$

We wish to prove that

$$(180) \quad \sum_{0 \leq i \leq l_1} \lambda_i \ell(\mathcal{C}_i) = \sum_{0 \leq i \leq l_2} \gamma_i \ell(\underline{\mathcal{C}}_i).$$

By Lemma 6.25 we can find a collision which is containment-minimal in the support of both metric n -bracketings $\sum_{0 \leq i \leq l_1} \lambda_i \ell(\mathcal{C}_i)$ and $\sum_{0 \leq i \leq l_2} \gamma_i \ell(\underline{\mathcal{C}}_i)$. The proof is completed by following the same inductive argument utilized in the proof of Lemma 4.16 when demonstrating that (55) implies (54). \square

Remark 6.26. While $\Gamma_{\omega_\sigma}^\rho$ is injective and piecewise-linear on all of $\Gamma(U_\sigma)$, it may not be linear on all of $\Gamma(U_\sigma)$. For example, in Figure 30 we see that in the chart $\Gamma(U_{312})$ ²⁷, we have $(1, 0, 1) = (0, 0, 1) + (1, 0, 0) = \Gamma_{\omega_{312}}^\rho(0, 1, 0) + \Gamma_{\omega_{312}}^\rho(1, 0, 3) \neq \Gamma_{\omega_{312}}^\rho((0, 1, 0) + (1, 0, 3))$ as by injectivity, $\Gamma_{\omega_{312}}^\rho(1, 1, 3) \neq \Gamma_{\omega_{312}}^\rho(1, 1, 2) = (1, 0, 1)$. \triangle

6.3. The nestohedral atlas for the triangulated velocity fan.

We now investigate the shuffle atlas for the triangulated n -bracketing complex.

Definition 6.27. Given $Y \in \Delta_{\mathcal{T}}$ and $\mathcal{B} = \vee_{\mathcal{C} \in Y} \mathcal{C}$, let $\mathfrak{S}(Y) := \{\sigma \in S_{\mathcal{T}} : \sigma \in \mathfrak{S}(\mathcal{B})\}$. We define the *nestohedral chart of the triangulated n -bracketing complex associated to σ* to be the pair $(U_\sigma, \Gamma_{\omega_\sigma})$ where $U_\sigma = \{\tau^{\text{met}}(Y) \in \mathcal{K}^{\text{met}}(\Delta_{\mathcal{T}}) : \sigma \in \mathfrak{S}(Y)\}$ and Γ_{ω_σ} , is the piecewise-linear map obtained by extending $\ell(\mathcal{C}) \mapsto \omega_\sigma(\mathcal{C})$ linearly on each conical set $\tau^{\text{met}}(Y)$. The *nestohedral atlas for the triangulated metric n -bracketing complex* is the collection of all nestohedral charts $\{(U_\sigma, \Gamma_{\omega_\sigma})\}$ where σ ranges over $S_{\mathcal{T}}$. We define the nestohedral charts and atlas for the triangulated velocity fan similarly by taking $\{\Gamma(U_\sigma), \Gamma_{\omega_\sigma}^\rho\}$ where $\Gamma_{\omega_\sigma}^\rho = \Gamma_{\omega_\sigma} \circ \Gamma^{-1}$. \triangle

The shuffle atlas is essentially the same as the nestohedral atlas except that the latter is defined on the triangulated velocity fan. Our choice to introduce new terminology for this essentially equivalent object will become clear shortly.

We begin by recalling the definition of building sets and their corresponding nested set complexes for the Boolean lattice following Postnikov. These definitions

²⁷Here we have simplified notation and denote $\sigma = (\sigma^1, \sigma^2) = (12, 312)$ by 312.

are derived from De Concini and Procesi's theory of wonderful compactifications of [DCP95] in the special case of the coordinate arrangement.²⁸

Definition 6.28. Let \mathbb{B} be a collection of subsets of $[n]$. We say that \mathbb{B} is a *building set* if

- (1) For all $i \in [n]$, $\{i\} \in \mathbb{B}$
- (2) For all $B_1, B_2 \in \mathbb{B}$, if $B_1 \cap B_2 \neq \emptyset$ then $B_1 \cup B_2 \in \mathbb{B}$. △

Definition 6.29. A set $N \subseteq \mathbb{B}$ is a *nested set* if

- (1) $B_1, B_2 \in N$, then $B_1 \subseteq B_2$, $B_2 \subseteq B_1$ or $B_1 \cap B_2 = \emptyset$,
- (2) when $B_1, \dots, B_k \in N$ are disjoint with $k \geq 2$, then

$$(181) \quad \bigcup_{i=1}^k B_i \notin \mathbb{B}.$$

The *nested set complex* $\Delta_{\mathbb{B}}$ associated to \mathbb{B} is the collection of all nested sets for \mathbb{B} . It is clear that $\Delta_{\mathbb{B}}$ is an abstract simplicial complex. △

Let $\mathfrak{X}(\mathcal{T})^\sigma = \{\mathcal{C} \in \mathfrak{X}(\mathcal{T}) : \sigma \in \mathfrak{S}(\mathcal{C})\}$ and $\widehat{\mathfrak{X}}(\mathcal{T})^\sigma = \{\mathcal{C} \in \widehat{\mathfrak{X}}(\mathcal{T}) : \sigma \in \mathfrak{S}(\mathcal{C})\}$. In the remainder of this section we will identify the 0-1 vectors $\omega_\sigma(\mathcal{C})$ for $\mathcal{C} \in \widehat{\mathfrak{X}}(\mathcal{T})^\sigma$, with indicator vectors for sets and hence allow discussion of their unions and intersections. Our ambient set will be $\bigsqcup_{k=1}^n [t_k]$, where $[t_k]$ indicates the set of the first t_k positive integers. We will let e_i^k denote the i th element of $[t_k]$.

Definition 6.30. Let $\sigma \in S_{\mathcal{T}}$. Let $W_\sigma = \{\omega_\sigma(\mathcal{C}) : \mathcal{C} \in \widehat{\mathfrak{X}}(\mathcal{T})^\sigma\}$. Let $V_\sigma = \{e_i^k : \pi(u_{\sigma(i)}^k) \neq \pi(u_{\sigma(i+1)}^k)\}$. The set $\mathbb{B}_\sigma = W_\sigma \sqcup V_\sigma$ is the *local σ -collision building set*. △

Our name for \mathbb{B}_σ is justified by the following Proposition 6.31.

Proposition 6.31. *The set \mathbb{B}_σ is a building set.*

We begin with a few lemmas.

Lemma 6.32. *Suppose that $\mathcal{C}_1, \mathcal{C}_2 \in \widehat{X}_{\mathcal{T}}^\sigma$ such that $\mathcal{C}_1 \approx \mathcal{C}_2$, then there exists a collision $\mathcal{C}_3 \in \widehat{X}_{\mathcal{T}}^\sigma$ such that $\omega_\sigma(\mathcal{C}_1) \cup \omega_\sigma(\mathcal{C}_2) = \omega_\sigma(\mathcal{C}_3)$.*

Proof. For k with $1 \leq k \leq n$, we define an equivalence relation \sim_{σ_k} as follows: if $A \in \mathcal{C}_1^k$ and $A' \in \mathcal{C}_2^k$ are essential brackets in \mathcal{C}_1 and \mathcal{C}_2 , respectively, such that $A^k \cap A'^k \neq \emptyset$, then we let $A^k \sim_{\sigma_k} A'^k$, and we take \sim_{σ_k} to be the transitive closure of this relation. Let x be an equivalence class of \sim_{σ_k} , and let $A_x^k = \{u_i^k \in V(\mathcal{T})^k : \exists A^k \in x, u_i^k \in A^k\}$. Suppose we have already constructed \mathcal{C}_3^{k-1} . For each equivalence class x , we extend A_x^k to a k -bracket in \mathcal{C}_3^k by appending it to the $(k-1)$ -bracket $A \in \mathcal{C}_3^{k-1}$ such that $\pi(A_x^k) \subseteq A^{k-1}$. It is straightforward to

²⁸Although not explained in Backman-Danner [BD24], one of the first author's primary motivations for that work was the desire to better understand the results of this subsection. In future work, we will utilize tropical geometry for contextualizing the results of this subsection.

verify that such an $A \in \mathcal{C}_3^{k-1}$ always exists. We must also include the singleton and maximum k -brackets in \mathcal{C}_3^k . To complete our description of \mathcal{C}_3^k , we give the height partial order on the k -brackets in \mathcal{C}_3^k induced by the total order σ_k : if $A_1, A_2 \in \mathcal{C}_3^k$ such that $\pi(A_1) = \pi(A_2)$ then we take $A_1 < A_2$ if there exists $u_{\sigma(i)}^k \in A_1^k$ and $u_{\sigma(j)}^k \in A_2^k$ such that $i < j$. It is straightforward to check that this partial order is well-defined.

We now verify that \mathcal{C}_3 is an extended collision in $\mathfrak{X}(\mathcal{T})^\sigma$ such that $\omega_\sigma(\mathcal{C}_1) \cup \omega_\sigma(\mathcal{C}_2) = \omega_\sigma(\mathcal{C}_3)$. The depth k -vertices in the k -brackets in \mathcal{C}_1^k and \mathcal{C}_2^k can be viewed as consecutive subsets of the vertices in $V(\mathcal{T})^k$ ordered as in σ_k . Thus, the equivalence classes defined above are also consecutive subsets of $V(\mathcal{T})^k$ ordered as in σ_k . Using this observation, one may verify that \mathcal{C}_3 is an extended collision in $\widehat{\mathfrak{X}}(\mathcal{T})^\sigma$.

We check $\omega_\sigma(\mathcal{C}_1) \cup \omega_\sigma(\mathcal{C}_2) = \omega_\sigma(\mathcal{C}_3)$. Induction affords us that $\omega_{\pi(\sigma)}(\pi(\mathcal{C}_1)) \cup \omega_{\pi(\sigma)}(\pi(\mathcal{C}_2)) = \omega_{\pi(\sigma)}(\pi(\mathcal{C}_3))$, thus we must simply check the desired statement for the last t_n entries of $\omega_\sigma(\mathcal{C}_3)$ encoding collisions of singleton n -brackets. If $\omega_\sigma(\mathcal{C}_1)_i^n = 1$ or $\omega_\sigma(\mathcal{C}_2)_i^n = 1$, then $u_{\sigma(i)}^n, u_{\sigma(i+1)}^n \in A^n$ for some n -bracket A belonging to either \mathcal{C}_1^n or \mathcal{C}_2^n . Let x be the equivalence class of \sim_σ containing A , then $u_{\sigma(i)}^n, u_{\sigma(i+1)}^n \in A_x^n$ and so $\omega_\sigma(\mathcal{C}_3)_i^n = 1$. Conversely, suppose that $\omega_\sigma(\mathcal{C}_3)_i^n = 1$, then there exists an equivalence class x of \sim_σ such that $u_{\sigma(i)}^n, u_{\sigma(i+1)}^n \in A_x^n$. Because A_x^n is a union of collection of vertices $V^n(\mathcal{T})$ which are consecutive with respect to σ_n , it must be that there is some n -bracket $A \in \mathcal{C}_1^n \cup \mathcal{C}_2^n$ such that $u_{\sigma(i)}^n, u_{\sigma(i+1)}^n \in A^n$, hence either $\omega_\sigma(\mathcal{C}_1)_i^n = 1$ or $\omega_\sigma(\mathcal{C}_2)_i^n = 1$. \square

The following lemma is immediate.

Lemma 6.33. *Let $\omega_\sigma(\mathcal{C}_1), \omega_\sigma(\mathcal{C}_2) \in \mathbb{B}_\sigma$ such that $\omega_\sigma(\mathcal{C}_1) \cap \omega_\sigma(\mathcal{C}_2) \neq \emptyset$, then $\mathcal{C}_1 \approx \mathcal{C}_2$.*

Proof. (6.31) It is clear by construction that for all $e_i^k \in \bigsqcup_{k=0}^n [t_k]$, $\{e_i^k\} \in \mathbb{B}_\sigma$ thus condition (1) of Definition 6.28 is satisfied. We now verify condition (2) of Definition 6.28. Let $\omega_\sigma(\mathcal{C}_1), \omega_\sigma(\mathcal{C}_2) \in \mathbb{B}_\sigma$ such that $\omega_\sigma(\mathcal{C}_1) \cap \omega_\sigma(\mathcal{C}_2) \neq \emptyset$. By Lemma 6.33 we know that $\mathcal{C}_1 \approx \mathcal{C}_2$, and it follows from Lemma 6.32 that $\omega_\sigma(\mathcal{C}_1) \cup \omega_\sigma(\mathcal{C}_2) \in \mathbb{B}_\sigma$. \square

Given a building set \mathbb{B} and its associated nested set complex $\Delta_{\mathbb{B}}$, Postnikov [Pos09] explicitly described how one can realize the nested set complex by a smooth projective fan $\mathcal{F}(\Delta_{\mathbb{B}})$ which coarsens the braid arrangement (see also Zelevinsky [Zel06] and Feichtner-Sturmfels [FS05]). The toric variety associated to this fan is De Concini-Procesi's associated wonderful compactification of the torus with respect to \mathbb{B} [DCP95]. Let N be a nested set for \mathbb{B} , then the corresponding cone in $\mathcal{F}(\Delta_{\mathbb{B}})$ is

$$(182) \quad \tau(N) = \text{cone}\{\chi_B : B \in N\} + \langle \mathbf{1} \rangle_{\mathbb{R}},$$

where χ_B is the indicator vector for B .

Definition 6.34. Give a simplicial complex Δ , and a face $\tau \in \Delta$, the star of τ is

$$(183) \quad \text{star}(\tau) = \{\tau' \in \Delta : \tau \subseteq \tau'\}.$$

△

Lemma 6.35. *Let $\Delta_{\mathcal{T}_\sigma} = \{Y \in \Delta_{\mathcal{T}} : \forall \mathcal{C} \in Y, \sigma \in \mathfrak{S}(\mathcal{C})\}$, and let $\Delta_{\mathbb{B}_\sigma}^\circ = \Delta_{\mathbb{B}_\sigma} \setminus \{\text{star}(\{e_i^k\}) : e_i^k \in V_\sigma\}$. Then*

$$(184) \quad \Delta_{\mathcal{T}_\sigma} \cong \Delta_{\mathbb{B}_\sigma}^\circ,$$

where \cong is an isomorphism of abstract simplicial complexes induced by the map $\mathcal{C} \mapsto \omega_\sigma(\mathcal{C})$.

Proof. Given $Y \in \Delta_{\mathcal{T}_\sigma}$, we let $\omega_\sigma(Y)$ denote $\{\omega_\sigma(\mathcal{C}) : \mathcal{C} \in Y\}$ where $\omega_\sigma(\mathcal{C})$ is identified with the set for which it is an indicator vector. We first show that given $Y \in \Delta_{\mathcal{T}_\sigma}$, $\omega_\sigma(Y) \in \Delta_{\mathbb{B}_\sigma}^\circ$. It is clear that for $e_i^k \in V_\sigma$, there exists no $\mathcal{C} \in Y$, such that $\omega_\sigma(\mathcal{C}) = e_i^k$, hence $\omega_\sigma(Y) \notin \text{star}(\{e_i^k\})$. It remains to check that $\omega_\sigma(Y)$ is a nested set, and we verify the conditions of Definition 6.29. For verifying condition (1), we let $\mathcal{C}_i, \mathcal{C}_j \in Y$ and observe that if $\mathcal{C}_i \rightarrow \mathcal{C}_j$ then $\omega_\sigma(\mathcal{C}_i) \subseteq \omega_\sigma(\mathcal{C}_j)$. On the other hand, if $\mathcal{C}_i \sim \mathcal{C}_j$, then $\omega_\sigma(\mathcal{C}_i) \cap \omega_\sigma(\mathcal{C}_j) = \emptyset$ by the contrapositive of Lemma 6.33.

For verifying condition (2), suppose that $N = \{\mathcal{C}_i : 1 \leq i \leq k\} \subseteq Y$ with $k \geq 2$, are such that the $\omega_\sigma(\mathcal{C}_i)$ are disjoint, then we must show that $\bigcup_{i=1}^k \omega_\sigma(\mathcal{C}_i) \notin \mathbb{B}_\sigma$. Suppose for contradiction that $\bigcup_{i=1}^k \omega_\sigma(\mathcal{C}_i) = \omega_\sigma(\mathcal{C}) \in \mathbb{B}_\sigma$. The collection of nonzero $\pi(\omega_\sigma(\mathcal{C}_i))$ are disjoint, and $\bigcup_{i=1}^k \pi(\omega_\sigma(\mathcal{C}_i)) = \pi(\omega_\sigma(\mathcal{C}))$. By induction on n , we can conclude that there is at most one \mathcal{C}_i which is not type 1, and $\pi(\omega_\sigma(\mathcal{C}_i)) = \pi(\omega_\sigma(\mathcal{C}))$. Let $\mathcal{C}_j \in N$ which is type 1, $A_j \in \mathcal{C}_j^n$ the corresponding fusion n -bracket, and $u_{\sigma(s)}^n, u_{\sigma(s+1)}^n \in A_j^n$ so that $\omega_\sigma(\mathcal{C}_j)_s^n = 1$. There must exist some $A \in \mathcal{C}^n$ such that $u_{\sigma(s)}^n, u_{\sigma(s+1)}^n \in A^n$ as $\omega_\sigma(\mathcal{C})_s^n = 1$. But we know that $\pi(A)$ is not a singleton $(n-1)$ -bracket thus there exists some $u_{\sigma(t)}^{n-1}, u_{\sigma(t+1)}^{n-1} \in A^{n-1}$ such that, without loss of generality, $\pi(u_{\sigma(s)}^n) = \pi(u_{\sigma(s+1)}^n) = u_{\sigma(t)}^{n-1}$. We have that $\omega_\sigma(\mathcal{C})_t^{n-1} = 1$, thus $\omega_\sigma(\mathcal{C}_i)_t^{n-1} = 1$ and $u_{\sigma(t)}^{n-1}, u_{\sigma(t+1)}^{n-1}$ belong to an essential bracket in \mathcal{C}_i^{n-1} , and there exists an essential bracket $A \in \mathcal{C}^n$ with $u_{\sigma(s)}^n \in A^n$. This contradicts the assumption that $\mathcal{C}_i \sim \mathcal{C}_j$.

It follows that all of the \mathcal{C}_i are type 1, and $\pi(\mathcal{C}_i) = \pi(\mathcal{C}_j)$ for i, j with $1 \leq i, j \leq k$. Thus \mathcal{C} must also be type 1. Take the minimum s such that the fusion bracket $A_1 \in \mathcal{C}^n$ has $u_{\sigma(s)}^n \in A_1^n$. Let \mathcal{C}_i be such that there exists some $A_2 \in \mathcal{C}_i^n$ with $u_{\sigma(s)}^n \in A_2$. Let $u_{\sigma(t)}^n \in A_2$ with t maximum. Because $\mathcal{C}_i \neq \mathcal{C}$, it must be that $u_{\sigma(t+1)}^n \in A_1$ implying $\omega_\sigma(\mathcal{C})_t^n = 1$. So, there exists some j such that $\omega_\sigma(\mathcal{C}_j)_t^n = 1$ implying there exists some $A_3 \in \mathcal{C}_j^n$ with $u_{\sigma(t)}^n, u_{\sigma(t+1)}^n \in A_3^n$, but then $\mathcal{C}_i \approx \mathcal{C}_j$, a contradiction. Hence $\bigcup_{i=1}^k \omega_\sigma(\mathcal{C}_i) \notin \mathbb{B}_\sigma$.²⁹

We have proven that the image of $\Delta_{\mathcal{T}_\sigma}$ is a subcomplex of $\Delta_{\mathbb{B}_\sigma}^\circ$. To show that the image is all of $\Delta_{\mathbb{B}_\sigma}^\circ$, we will take $\tau \in \Delta_{\mathbb{B}_\sigma}^\circ$ and show that the preimage of τ under the

²⁹This last step of this argument, considering the case when all \mathcal{C}_i are type 1, corresponds to the classical verification of the statement that the rays of the wonderful associahedral fan form the indicator vectors for a building set.

map induced by $\mathcal{C} \mapsto \omega_\sigma(\mathcal{C})$ is in $\Delta_{\mathcal{T}_\sigma}$. First note that the preimage is well-defined: if $\mathcal{C}, \mathcal{C}' \in \mathfrak{X}(\mathcal{T})^\sigma$ and $\omega_\sigma(\mathcal{C}) = \omega_\sigma(\mathcal{C}')$, then $\mathcal{C} = \mathcal{C}'$. Take $\omega_\sigma(\mathcal{C}_i), \omega_\sigma(\mathcal{C}_j) \in \tau$. If $\omega_\sigma(\mathcal{C}_i) \subseteq \omega_\sigma(\mathcal{C}_j)$ then $\mathcal{C}_i \rightarrow \mathcal{C}_j$. We claim that if $\omega_\sigma(\mathcal{C}_i) \cap \omega_\sigma(\mathcal{C}_j) = \emptyset$, then $\mathcal{C}_i \sim \mathcal{C}_j$. If $\mathcal{C}_i \approx \mathcal{C}_j$, then by Lemma 6.32 we know that there exists some $\mathcal{C}_3 \in \widehat{X}_\mathcal{T}^\sigma$ such that $\omega_\sigma(\mathcal{C}_1) \cup \omega_\sigma(\mathcal{C}_2) = \omega_\sigma(\mathcal{C}_3)$, but this contradicts the assumption that τ is a nested set. By Proposition 5.20, these conditions are sufficient to ensure that the preimage of τ is a nested collection of collisions in $\Delta_{\mathcal{T}_\sigma}$. \square

Proposition 6.36. *Let $\mathcal{F}^\circ(\mathbb{B}_\sigma) = \mathcal{F}(\mathbb{B}_\sigma) \setminus \{\text{star}(\{e_i\}) : i \in V_\sigma\}$. Then*

$$(185) \quad \Gamma_{\omega_\sigma} : \mathcal{K}^{\text{met}}(\Delta_{\mathcal{T}})|_{U_\sigma} \rightarrow \mathcal{F}^\circ(\mathbb{B}_\sigma)$$

and

$$(186) \quad \Gamma_{\omega_\sigma}^\rho : \mathcal{F}(\Delta_{\mathcal{T}})|_{\Gamma(U_\sigma)} \rightarrow \mathcal{F}^\circ(\mathbb{B}_\sigma)$$

are piecewise-linear isomorphisms, and $\Gamma_{\omega_\sigma}^\rho$ is unimodular on each cone of $\mathcal{F}(\Delta_{\mathcal{T}})|_{\Gamma(U_\sigma)}$.

We will need the following statement.

Lemma 6.37. [Pos09, Zel06, FS05] *Given a building set \mathbb{B} , the associated nestohedral fan $\mathcal{F}(\mathbb{B})$ is smooth.*

Proof. (6.36) It follows by Lemma 6.21 that these maps are indeed injective piecewise-linear maps defined on the charts of the shuffle atlas for the metric n -bracketing complex. It follows by Lemma 6.35 that when we apply these same maps to the nestohedral atlas the image is as described. It remains to check that $\Gamma_{\omega_\sigma}^\rho$ is unimodular on each cone. We know by Lemma 5.38 that each cone of $\mathcal{F}(\Delta_{\mathcal{T}})|_{U_\sigma}$ is smooth and by Lemma 6.37 each cone of $\mathcal{F}^\circ(\mathbb{B}_\sigma)$ is smooth. Because $\Gamma_{\omega_\sigma}^\rho$ maps the generators for unimodular cones to generators for unimodular cones, the desired statement follows. \square

Corollary 6.38. *For each n -bracketing \mathcal{B} and each $\sigma \in \mathfrak{S}(\mathcal{B})$, the cone $\tau_{\omega_\sigma}(\mathcal{B})$ is a union of cones in the braid arrangement.*

Proof. The cone $\tau_{\omega_\sigma}(\mathcal{B})$ is triangulated by the collection of cones from $\mathcal{F}(\mathbb{B}_\sigma)$ which it contains. Each cone in $\mathcal{F}(\mathbb{B}_\sigma)$ is itself a union of cones from the braid arrangement. By transitivity, $\tau_{\omega_\sigma}(\mathcal{B})$ is a union of cones in the braid arrangement. \square

As a direct application we have the following corollary.

Corollary 6.39. *The maps $\Gamma_{\omega_\sigma}^\rho$ is unimodular on each cone of the velocity fan in the shuffle chart $\Gamma(U_\sigma)$.*

Proof. Let $\mathcal{B} \in \mathcal{K}(\mathcal{T})$ such that $\sigma \in \mathfrak{S}(\mathcal{B})$. Let $Y \in \Delta_{\mathcal{T}}$ be a facet such that $\tau(Y) \subseteq \tau(\mathcal{B})$. By Proposition 6.36, $\Gamma_{\omega_\sigma}^\rho$ is unimodular on each cone of $\mathcal{F}(\Delta_{\mathcal{T}})|_{\Gamma(U_\sigma)}$, and by Lemma 6.21, we know that $\Gamma_{\omega_\sigma}^\rho$ is linear on all of $\tau(\mathcal{B})$. \square

Remark 6.40. The image of the permutahedral velocity fan restricted to $\Gamma(U_\sigma)$ under $\Gamma_{\omega_\sigma}^\rho$ is equal to the braid arrangement triangulation of $\mathcal{F}^\circ(\mathbb{B}_\sigma)$. \triangle

Remark 6.41. Postnikov’s \mathbb{B} -trees associated to $\Delta_{\mathbb{B}_\sigma}^\circ$ are precisely the trees obtained in Theorem 5.29. \triangle

Remark 6.42. In this section when proving that the image of a cone in the velocity fan is a union of cones in the braid arrangement, we did so by appealing either to the triangulated or permutahedral velocity fan highlighting the role of these structures. Alternately, we could have proven these statements directly by appealing to the defining inequalities of preposet cones described by Postnikov-Reiner-Williams [PRW08]. \triangle

Remark 6.43. The velocity fan always contains a distinguished chamber of the braid arrangement, which we now describe. For this remark, we will break with convention and denote the coordinates of a vectors $\mathbf{v} \in \mathbb{R}^m$ by $\mathbf{v} = (v_1, \dots, v_m)$, i.e. we will not use superscripts. There is a distinguished n -bracketing, which we will denote $\mathcal{B}_\mathcal{T}$, and distinct extended collisions $\mathcal{C}_{\mathcal{T},1}, \dots, \mathcal{C}_{\mathcal{T},m} \in \mathfrak{X}(\mathcal{T})$ such that for each i , $\mathcal{C}_{\mathcal{T},i} \leq \mathcal{B}_\mathcal{T}$ and

$$(187) \quad \rho(\mathcal{C}_{\mathcal{T},i})_k = \begin{cases} 1 & \text{if } k \leq i \text{ and} \\ 0 & \text{if } i < k. \end{cases}$$

In particular, we always take $\mathcal{C}_{\mathcal{T},m} = \mathcal{B}_{\min}(\mathcal{T})$. Let $u_{t_n}^n$ be the largest labeled vertex of depth n in \mathcal{T} . By induction, a bracketing $\mathcal{B}_{\mathcal{T}'}$ as described above exists for the tree $\mathcal{T}' = \mathcal{T} \setminus \{u_{t_n}^n\}$. For describing $\mathcal{B}_\mathcal{T}$, we construct a collision $\mathcal{C}_{\mathcal{T},i}$ from each extended collision $\mathcal{C}_{\mathcal{T}',i}$. For each $A' \in \mathcal{C}_{\mathcal{T}',i}^{n-1}$ with $\pi(u_{t_n}^n) \in A'^{n-1}$, we introduce an n -bracket $A \in \mathcal{C}_{\mathcal{T},i}^n$ with $A^n = \{u_{t_n}^n\}$. We extend the height partial order for $\mathcal{C}_{\mathcal{T}',i}$ by making A larger than any other n -bracket \tilde{A} with $\pi(\tilde{A}) = \pi(A)$. It is straightforward to check that the $\mathcal{C}_{\mathcal{T},i}$ are compatible, and have coordinates as described. \triangle

7. THE LOCAL NESTED FIBER PRODUCT STRUCTURE OF THE VELOCITY FAN

Combinatorially, each facet of an associahedron factors as a product of two smaller associahedra. This observation is essential for understanding the operadic structure of the associahedron. The second author characterized the recursive fiber product description of 2-associahedra: combinatorially, each facet in a 2-associahedron factors as a product of a smaller 2-associahedron with a fiber product of 2-associahedra over a 1-associahedron [Bot19a]. This description was utilized by the second author and Carmeli [BC21] for understanding the relative 2-operad structure of 2-associahedra. In this section, we extend this description to categorical n -associahedra via iterated fiber products³⁰, and we investigate the extent to which this recursive structure is realized geometrically by the velocity fan.

³⁰We expect this description to be an essential step in verifying that categorical n -associahedra form an example of a relative n -operad naturally viewed as an ω -operad in the sense of Batanin [Bat98].

The recursive structure of the associahedron is fully realized in the geometry of the wonderful associahedral fan \mathcal{F}_n : the star of a ray in \mathcal{F}_n factors as a product of two smaller the wonderful associahedral fans.³¹ We will see in Theorem 7.28 that this nice property partially extends to our velocity fans in an interesting way. We begin with some preliminary results on the theory of fiber products of sets, posets, cone complexes, and fans.

The primary reference for fiber products of fans and cone complexes, of which we are aware, is the relatively recent work of Molcho [Mol21] on universal stacky semistable reduction building on work of Abramovich-Karu [AK00]. Fiber products of polytopes have been investigated in [BW07][Sul07][HPPS21], and pullbacks of diagrams of polyhedral objects appear in [ALPT18, ALT18].

7.1. Fiber products of sets, posets, cone complexes, and fans.

Definition 7.1. Fiber products of sets. Let X_i for $1 \leq i \leq n$ and Y be sets with maps $f_i : X_i \rightarrow Y$, then the fiber product of the X_i over Y , written

$$(188) \quad \prod_{1 \leq i \leq n}^Y X_i$$

is the set

$$(189) \quad \{(y, x_1, \dots, x_n) \in Y \times \prod_{1 \leq i \leq n} X_i : \forall 1 \leq i \leq n, f_i(x_i) = y\},$$

△

Remark 7.2. Note that the fiber product of a collection of empty sets over a set X is equal to X . This consideration is relevant for fiber products of n -associahedra.

△

We review that fiber products exist in the categories of posets, cone complexes, and fans.

Definition 7.3. Let (P, \leq_P) and (Q, \leq_Q) be partially ordered sets. A morphism in the category of posets is a map $f : P \rightarrow Q$ such that if $x, y \in P$ and $x \leq_P y$ then $f(x) \leq_Q f(y)$. △

³¹It is perhaps an under-appreciated fact that it is impossible to realize this recursive structure via a polytopal realization of the associahedron. More precisely, it is impossible to construct a sequence of polytopes $\{P_i\}$ such that P_i realizes the i th associahedron and each facet of P_i factors as a product $P_j \times P_k$ with $j, k < i$. In fact, it is already impossible to do this in dimension 3 with polytopes P_0, P_1, P_2, P_3 . In recent work, Masuda–Thomas–Tonks–Vallette [MTTV21] showed that each facet of Loday’s associahedron factors as a product of weighted versions of smaller Loday associahedra. This refines the above observation each facet of Loday’s associahedron factors as a product of smaller polytopes which are normally equivalent to Loday associahedra.

Definition 7.4. Fiber products of partially ordered sets. Let (P_i, \leq_i) for $1 \leq i \leq n$ and (Q, \leq_Q) be posets with poset morphisms $f_i : P_i \rightarrow Q$, then the fiber product of the P_i over Q , written

$$(190) \quad \prod_{1 \leq i \leq n}^Q P_i$$

is the fiber product of the underlying sets equipped with the following partial order:

$$(191) \quad (q, p_1, \dots, p_n), (q', p'_1, \dots, p'_n) \in \prod_{1 \leq i \leq n}^Q P_i$$

then

$$(192) \quad (q, p_1, \dots, p_n) \leq (q', p'_1, \dots, p'_n)$$

if $p_i \leq p'_i$ for all $1 \leq i \leq n$. △

Note that because the f_i are morphisms in the definition above, the condition $p_i \leq p'_i$ ensures that $q \leq q'$.

Proposition 7.5 (Fiber products of conical sets). *For $0 \leq i \leq s$, let τ_i be a conical set. Suppose that $f_i : \tau_i \rightarrow \tau_0$ are linear transformations.*

Then the set theoretic fiber product of the τ_i over τ

$$(193) \quad \prod_{1 \leq i \leq s}^{\tau} \tau_i$$

is naturally equipped with the structure of a conical set.

Proof. Let $\mathbf{x} = \prod_{1 \leq i \leq s} \mathbf{x}_i$, $\mathbf{y} = \prod_{1 \leq i \leq s} \mathbf{y}_i$ be points in $\prod_{1 \leq i \leq s}^{\tau} \tau_i$ and $\mathbf{z}, \mathbf{w} \in \tau$ such that $f_i(\mathbf{x}_i) = \mathbf{z}$ and $f_i(\mathbf{y}_i) = \mathbf{w}$ for all $1 \leq i \leq s$. Let $\lambda, \mu \in \mathbb{R}_{\geq 0}$. Then for each i with $1 \leq i \leq s$, we have

$$(194) \quad f_i(\lambda \mathbf{x}_i + \mu \mathbf{y}_i) = \lambda f_i(\mathbf{x}_i) + \mu f_i(\mathbf{y}_i) = \lambda \mathbf{z} + \mu \mathbf{w}.$$

Therefore $\prod_{1 \leq i \leq s}^{\tau} \tau_i$ is closed under taking conical combinations. □

In the special case of cones, fiber products of conical sets have the following geometric description.

Definition 7.6 (Fiber products of cones). For $0 \leq i \leq s$, let τ_i be a cone in \mathbb{R}^{m_i} having coordinates $\mathbf{x}^i = (x_1^i, \dots, x_{m_i}^i)$. Suppose that for $0 \leq i \leq s$, we have linear transformations $f_i : \mathbb{R}^{m_i} \rightarrow \mathbb{R}^{m_0}$ are such that $f_i(\tau_i) \subseteq \tau_0$ and f_0 is the identity map. Let $T = (\tau_0, \tau_1, \dots, \tau_s)$ and $f = (f_0, f_1, \dots, f_s)$. Let V_f be the linear space in $\prod_{i=0}^s \mathbb{R}^{m_i}$ cut out by the equations $f_i(\mathbf{x}^i) = f_j(\mathbf{x}^j)$ for all $0 \leq i, j \leq s$.

Then we define the *fiber product of the τ_i over τ* is the cone

$$(195) \quad \prod_{1 \leq i \leq s}^{\tau} \tau_i := \left(\prod_{i=0}^s \tau_i \right) \cap V_f.$$

△

The following Lemma characterizes of the faces of a cone which is obtained as the intersection of another cone with a linear space.

Lemma 7.7. *Let $C_1 \subset \mathbb{R}^n$ be a polyhedral cone and $V \subset \mathbb{R}^n$ be a linear space. Suppose that $C_2 = C_1 \cap V$. Let \mathcal{F}_1 and \mathcal{F}_2 be the faces of C_1 and C_2 , respectively. Then*

$$(196) \quad \mathcal{F}_2 = \{\tau \cap V : \tau \in \mathcal{F}_1\}.$$

Moreover, there are bijections

$$(197) \quad \mathcal{F}_2 \longleftrightarrow \{\tau \cap V : \tau \in \mathcal{F}_1, V \text{ intersects } \tau \text{ in its relative interior}\}$$

$$(198) \quad \longleftrightarrow \{\tau \cap V : \tau \in \mathcal{F}_1, \forall \tau' \in \mathcal{F}_1, \tau' < \tau, \tau' \cap V \neq \tau \cap V\}.$$

Proof. This can be verified by appealing to polarity and linear programming. □

Lemma 7.8. *For $1 \leq i \leq s$, let \mathcal{F}_i be cone complexes. Then $\mathcal{G} = \prod_{1 \leq i \leq s} \mathcal{F}_i$ is a cone complex.*

Proof. This is straightforward to check. □

Definition 7.9 (Fiber products of cone complexes). For $1 \leq i \leq s$, let \mathcal{F}_i be cone complexes. Let \mathcal{F} be a cone complex. Suppose that $f_i : \mathcal{F}_i \rightarrow \mathcal{F}$ are morphisms of cone complexes, i.e. each f_i is a piecewise-linear transformation such that for each conical set $\tau_i \in \mathcal{F}_i$ there exists some conical set $\tau \in \mathcal{F}$ with $f_i(\tau_i) \subseteq \tau$.

Then we define the *fiber product of the \mathcal{F}_i over \mathcal{F}* as

$$(199) \quad \prod_{1 \leq i \leq s}^{\mathcal{F}} \mathcal{F}_i := \left\{ \prod_{1 \leq i \leq s}^{\tau} \tau_i : \tau \in \mathcal{F}, \tau_i \in \mathcal{F}_i, f_i(\tau_i) \subseteq \tau \right\}.$$

△

Proposition 7.10. *Cone complexes are closed under taking fiber products.*

Proof. Let $\mathcal{G} = \mathcal{F} \times \prod_{1 \leq i \leq s} \mathcal{F}_i$, and let $\mathcal{H} = \prod_{1 \leq i \leq s}^{\mathcal{F}} \mathcal{F}_i$ be a fiber product of cone complexes as in Definition 7.9. By Lemma 7.8, \mathcal{G} is a cone complex. We now verify the conditions of a cone complex for \mathcal{H} . Let $X(\mathcal{H})$ be the set of points in \mathcal{H} . Let

$$(200) \quad \phi : \mathcal{G} \rightarrow \mathcal{H}$$

be the natural surjection with $\phi(\tau) = \tau \cap X(\mathcal{H})$ for each $\tau \in \mathcal{G}$. By piecewise-linearity of the f_i , if we take $\tau = (\tau_0, \tau_1, \dots, \tau_s)$, then we can alternately describe $\phi(\tau) = \prod_{1 \leq i \leq s}^{\tau_0} \tau_i$. By the definition of a cone complex, there exists a linear isomorphism f_τ such that $f_\tau(\tau)$ is a polyhedral cone in some Euclidean space. We can take $f_\tau = (f_{\tau_0}, \dots, f_{\tau_s})$ to be the tuple of such maps for the constituent conical sets. Thus, given a conical set $\tau \in \mathcal{G}$, Definition 7.6 demonstrates that $f_\tau(\phi(\tau)) = f_\tau(\tau) \cap V_f$ for the linear space V_f described there, where $f = (id, f_{\tau_0} \circ f_1 \circ f_{\tau_1}^{-1}, \dots, f_{\tau_0} \circ f_s \circ f_{\tau_s}^{-1})$, and id is the identity map.

Let τ_1 be a conical set in \mathcal{H} . Let τ_2 be a face of τ_1 . We wish to show that $\tau_2 \in \mathcal{H}$. Let $\tau'_1 \in \mathcal{G}$ be a conical set such that $\phi(\tau'_1) = \tau_1$. By Lemma 7.7, and the observation of the previous paragraph (noting that we can take the same linear space V_f for both $f_{\tau'_1}(\tau'_1)$ and $f_{\tau'_2}(\tau'_2)$), we know that there exists some $\tau'_2 \in \mathcal{G}$ which is a face of τ'_1 such that $\phi(\tau'_2) = \tau_2$.

Next let $\tau_1, \tau_2 \in \mathcal{H}$. We wish to show that $\tau_3 = \tau_1 \cap \tau_2$ is a union of faces of both τ_1 and τ_2 . Let $\tau'_1, \tau'_2 \in \mathcal{G}$ be conical sets such that $\phi(\tau'_1) = \tau_1$ and $\phi(\tau'_2) = \tau_2$. The map ϕ commutes with taking unions and intersections, hence $\phi(\tau'_1 \cap \tau'_2) = \tau_1 \cap \tau_2 = \tau_3$. By Lemma 7.8, we see that $\tau'_1 \cap \tau'_2$ is a finite union of faces of both τ'_1 and τ'_2 , and the desired statement now follows from Lemma 7.7. \square

Definition 7.11. Let \mathcal{F} and \mathcal{G} be cone complexes and f a linear transformation such that for each conical set $\sigma \in \mathcal{F}$ there exists some conical set $\tau \in \mathcal{G}$ such that $f(\sigma) = \tau$, then f is *combinatorially weakly semistable*. \triangle

Molcho says that that a map of cone complexes is *weakly semistable* if in addition to being combinatorially weakly semistable, the map also induces a surjection of the underlying lattices, and notes that this definition is a slight weakening of the notion of weak semistability described by Abramovich-Karu [AK00]. We remark that the projection maps described in Definitions 7.24 and 7.30 do satisfy Molcho's lattice condition and thus are weakly semistable.

The following lemma is implicit in [Mol21] and was rediscovered by the authors. We note that this version applies to fiber products of nonrational fans, which might be of interested to polyhedral geometers.

Lemma 7.12. *Let \mathcal{F}_i for $1 \leq i \leq s$ and \mathcal{F} be cone complexes as in Definition 7.9, and $f_i : \mathcal{P}(\mathcal{F}_i) \rightarrow \mathcal{P}(\mathcal{F})$ is the induced map on face posets. If the f_i are all combinatorially weakly semistable then the face poset of the fiber product of cone complexes is the fiber product of the face posets of the cone complexes:*

$$(201) \quad \mathcal{P} \left(\prod_{1 \leq i \leq s}^{\mathcal{F}} \mathcal{F}_i \right) = \prod_{1 \leq i \leq s}^{\mathcal{P}(\mathcal{F})} \mathcal{P}(\mathcal{F}_i).$$

Proof. We implicitly identify individual conical sets with cones. By Lemma 7.7, there is a bijection between cones of the fiber product and cones in the product of the \mathcal{F}_i such that the linear space in question V_f intersects their relative interior. Thus, in order to determine the face poset of the fiber product, we should understand when V_f intersects the relative interior of a cone in the product of the \mathcal{F}_i .

Let $\tau_i \in \mathcal{F}_i$ for $1 \leq i \leq s$, and $\tau \in \mathcal{F}$ such that $f_i(\tau_i) \subseteq \tau$ for each i . Suppose further that $f_i(\tau_i) = \tau$ for each i . If this occurs then for any (some) point \mathbf{v} in the relative interior of τ there exists a point \mathbf{v}_i in the relative interior of τ_i such that $f_i(\mathbf{v}_i) = \mathbf{v}$. To see this, note that combinatorial weak semistability gives that f_i surjects the rays of τ_i to the rays of τ . A point is in the relative interior of a cone if and only if it can be expressed as a positive combination of all of the ray generators.

The relative interior of $(\tau, \tau_1, \dots, \tau_s)$ equal to the product of the relative interiors of each of these cones, and the statement follows.

Conversely, suppose there exist $1 \leq j, k \leq s$ with $f_j(\tau_j) \neq f_k(\tau_k)$, then the corresponding linear space V_f does not intersect the relative interior of a cone in the product of the \mathcal{F}_i as, without loss of generality, $f_j(\tau_j)$ does not contain a point in the relative interior of $f_k(\tau_k)$. \square

The geometric description of fiber products of cones from Definition 7.6 extends to the category of fans equipped with morphisms which are globally linear, and this has interesting consequences for fans, which don't apply to general cone complexes.

Definition 7.13 (Fiber products of fans). For $1 \leq i \leq s$, let \mathcal{F}_i be a fan in \mathbb{R}^{m_i} . Suppose that \mathcal{F}_i has coordinates $\mathbf{x}^i = (x_1^i, \dots, x_{m_i}^i)$. Let \mathcal{F} be a fan in \mathbb{R}^n and suppose that $f_i : \mathbb{R}^{m_i} \rightarrow \mathbb{R}^n$ are linear transformations such that for each cone $\tau_i \in \mathcal{F}_i$ there exists some cone $\tau \in \mathcal{F}$ such that $f_i(\tau_i) \subseteq \tau$. Let V_f be the linear space in $\prod_{i=1}^s \mathbb{R}^{m_i}$ cut out by the equations $f_i(\mathbf{x}^i) = f_j(\mathbf{x}^j)$ for all $1 \leq i, j \leq s$.

Then we define the *fiber product of the \mathcal{F}_i over \mathcal{F}* as

$$(202) \quad \prod_{1 \leq i \leq s}^{\mathcal{F}} \mathcal{F}_i := \left\{ \left(\prod_{i=1}^s \tau_i \right) \cap V_f : \tau_i \in \mathcal{F}_i \right\}.$$

\triangle

Corollary 7.14. *Let \mathcal{F}_i and \mathcal{F} be fans as in the statement of Definition 7.13. If each \mathcal{F}_i is a complete fan, then*

$$(203) \quad \prod_{1 \leq i \leq s}^{\mathcal{F}} \mathcal{F}_i$$

is a complete fan.

Proof. The fiber product above is the intersection of $\prod_{i=1}^s \mathcal{F}_i$ with a linear space, hence it is complete. \square

An application of Corollary 7.14 is described in Remark 7.26.

Remark 7.15. Fiber products of projective, i.e. polytopal, fans are projective. This will not be utilized. Furthermore, the fiber products of generalized permutahedra with respect to coordinate projection maps are again generalized permutahedra. This was independently observed in the work of Sanchez [San23], and a corresponding statement for Bergman fans was observed by Francois-Hampe [FH13]. \triangle

The following two lemmas are straightforward to verify.

Lemma 7.16. *Let \mathcal{F} be a fan in \mathbb{R}^m . Suppose that there exists some pair of indices $1 \leq i < j \leq m$ such that for every point $\mathbf{v} \in \mathcal{F}$, we have $\mathbf{v}_i = \mathbf{v}_j$. Let π_i be the map which projects away from the i th coordinate. Then $\pi_i : \mathbb{R}^m \rightarrow \mathbb{R}^{m-1}$ is a linear isomorphism from \mathcal{F} onto its image.*

Lemma 7.17. *Let $\mathcal{F}, \mathcal{G}, \mathcal{F}_i, \mathcal{G}_i$ be cone complexes with $1 \leq i \leq s$. Suppose that we have piecewise-linear isomorphisms $f_i : \mathcal{F}_i \rightarrow \mathcal{F}, g_i : \mathcal{G}_i \rightarrow \mathcal{G}, \psi_i : \mathcal{F}_i \rightarrow \mathcal{G}_i, \psi : \mathcal{F} \rightarrow \mathcal{G}$. Suppose that for each i we have $g_i \circ \psi_i = \psi \circ f_i$. Then the given maps induce a piecewise-linear isomorphism*

$$(204) \quad \prod_{1 \leq i \leq s}^{\mathcal{F}} \mathcal{F}_i \cong \prod_{1 \leq i \leq s}^{\mathcal{G}} \mathcal{G}_i.$$

7.2. Fiber products of n -associahedra.

In this subsection we define fiber products of categorical n -associahedra and use these fiber products to describe the local structure of categorical n -associahedra.

Recall, from Definition 2.17, we denote the n -associahedron $\mathcal{K}(\mathcal{T}|_A)$ for some k -bracket A as $\mathcal{K}(A)$.

Definition 7.18 (Fiber products of categorical n -associahedra). Let \mathcal{T} be a rooted plane tree and $\mathcal{C} \in \mathfrak{X}(\mathcal{T})$. We recursively define the iterated fiber product $\mathcal{K}(\mathcal{T}|_{\mathcal{C}})$. For $A \in \mathcal{C}^n$ essential³², let $\mathcal{K}(\mathcal{T}|_{\mathcal{C}, A}) = \mathcal{K}(A)$. Next, let A be an essential k -bracket in \mathcal{C}^k for $k < n$. We denote

$$(205) \quad \mathcal{K}(\mathcal{T}|_{\mathcal{C}, A}) := \prod_{\substack{A' \in \mathcal{C}^{k+1}, \\ A' \text{ essential}, \\ \pi(A') = A}}^{\mathcal{K}(A)} \mathcal{K}(\mathcal{T}|_{\mathcal{C}, A'})$$

with the maps from the factors to the base defined presently. Suppose by induction that we have defined maps $\Pi_{A'} : \mathcal{K}(\mathcal{T}|_{\mathcal{C}, A'}) \rightarrow \mathcal{K}(A')$ for each $A' \in \mathcal{C}^{k+1}$. We compose with the map $\pi : \mathcal{K}(A') \rightarrow \mathcal{K}(A)$ to get the desired map $\pi \circ \Pi_{A'} : \mathcal{K}(\mathcal{T}|_{\mathcal{C}, A'}) \rightarrow \mathcal{K}(A)$. Finally, in order to extend the induction, we define $\Pi_A : \mathcal{K}(\mathcal{T}|_{\mathcal{C}, A}) \rightarrow \mathcal{K}(A)$ to be the product of the maps $\pi \circ \Pi_{A'}$ over all $A' \in \mathcal{C}^{k+1}$ with A' essential, and $\pi(A') = A$.³³

Let A_{\bullet} be the fusion bracket for \mathcal{C} . We define

$$(206) \quad \mathcal{K}(\mathcal{T}|_{\mathcal{C}}) := \mathcal{K}(\mathcal{T}|_{\mathcal{C}, A_{\bullet}}).$$

△

We refer to elements of $\mathcal{K}(\mathcal{T}|_{\mathcal{C}})$ as *fiber products of n -bracketings*. By repeated application of Definition 7.4, $\mathcal{K}(\mathcal{T}|_{\mathcal{C}})$ is naturally equipped with the structure of a poset.

Definition 7.19. Let $\mathcal{C} \in \mathfrak{X}(\mathcal{T})$, then we define the *facet* associated to \mathcal{C} to be the interval $\mathcal{K}(\mathcal{T})_{\mathcal{C}} := [\mathcal{C}, \star] \subseteq \mathcal{K}(\mathcal{T})$. △

³²Recall from Definition 2.35 that $A \in \mathcal{C}^n$ is essential if and only if it is nontrivial, but for $k < n$, essential brackets may also be certain maximal brackets.

³³We remark that the map Π_A may not be a product of copies of the map π^{n-k} as there may exist some j -bracket A' with $j \geq k$ living over A such that there exist no $j+1$ bracket which projects to A' .

The following lemma describes the face poset of a facet of an n -associahedron.

Lemma 7.20. ³⁴ *Let $\mathcal{C} \in \mathfrak{X}(\mathcal{T})$, then the corresponding facet of the n -associahedron admits a canonical isomorphism*

$$(207) \quad \mathcal{K}(\mathcal{T})_{\mathcal{C}} \cong \mathcal{K}(\mathcal{T}/_{\mathcal{C}}) \times \mathcal{K}(\mathcal{T}|_{\mathcal{C}}).$$

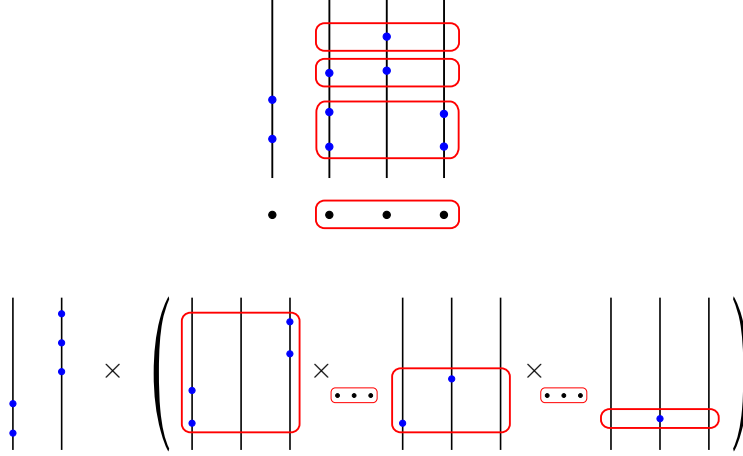

FIGURE 31. A collision \mathcal{C} in a 2-associahedron, and the corresponding factorization of interval $\mathcal{K}(\mathcal{T})_{\mathcal{C}} = [\mathcal{C}, \star] \subseteq \mathcal{K}(\mathcal{T})$ into a smaller 2-associahedron $\mathcal{K}(\mathcal{T}/_{\mathcal{C}})$ on the left times the fiber product of three 2-associahedra over a single 1-associahedron $\mathcal{K}(\mathcal{T}|_{\mathcal{C}})$ on the right.

Proof. We produce a poset isomorphism

$$(208) \quad \Psi : \mathcal{K}(\mathcal{T})_{\mathcal{C}} \rightarrow \mathcal{K}(\mathcal{T}/_{\mathcal{C}}) \times \mathcal{K}(\mathcal{T}|_{\mathcal{C}}).$$

Let $\mathcal{B} \in \mathcal{K}(\mathcal{T})_{\mathcal{C}}$, and let $A \in \mathcal{B}^k$ be nontrivial, then one of following mutually exclusive cases holds:

- (1) There exists $A' \in \mathcal{C}^k$ with $A' = A$.
- (2) For every essential bracket $A' \in \mathcal{C}^k$, we have that $A \cap A' = \emptyset$.
- (3) There exists some nontrivial $A' \in \mathcal{C}^k$ such that $A' \subsetneq A$.
- (4) There exists an essential bracket A' in \mathcal{C}^k , such that $A \subsetneq A'$.

Let \mathcal{B}^+ be the collection of k brackets A in \mathcal{B} from cases (1), (2), and (3) above for all $0 \leq k \leq n$, and height partial order inherited from \mathcal{B} . Let \mathcal{B}^- be the set of k brackets A in \mathcal{B} from cases (1) and (4) above for all $0 \leq k \leq n$, and height partial order inherited from \mathcal{B} . Then

- (1) The collections \mathcal{B}^+ and \mathcal{B}^- are both n -bracketings.
- (2) There exists a canonical map Ψ^+ from \mathcal{B}^+ to an n -bracketing in $\mathcal{K}(\mathcal{T}/_{\mathcal{C}})$.

³⁴To make things look nicer in this section, we have written $\mathcal{T}/_{\mathcal{C}}$ as $\mathcal{T}|_{\mathcal{C}}$.

- (3) There exists a canonical map Ψ^- from \mathcal{B}^- to a fiber product of n -bracketings in $\mathcal{K}(\mathcal{T}|\mathcal{C})$.

For verifying statement (1) above, one can check that the (NESTED) and (PARTITION) properties are preserved for \mathcal{B}^+ and \mathcal{B}^- . For statement (2), recall Definition 2.49. Statement (3) follows from the (PARTITION) property for \mathcal{B}^- .

Let D be the map which sends the n -bracketing \mathcal{B} to the ordered pair $(\mathcal{B}^+, \mathcal{B}^-)$ of n -bracketings, let $\tilde{\Psi} := \Psi^+ \times \Psi^-$, and let $\Psi := \tilde{\Psi} \circ D : \mathcal{K}(\mathcal{T})_{\mathcal{C}} \rightarrow \mathcal{K}(\mathcal{T}/\mathcal{C}) \times \mathcal{K}(\mathcal{T}|\mathcal{C})$. Then Ψ is a poset isomorphism. \square

Remark 7.21. The bracketings \mathcal{B}^+ and \mathcal{B}^- can alternately be defined using collisions:

$$(209) \quad \mathcal{B}^+ = \bigvee_{\substack{\tilde{\mathcal{C}} \in \mathfrak{X}(\mathcal{T}), \\ \tilde{\mathcal{C}} \leq \mathcal{B}, \\ \mathcal{C} \rightarrow \tilde{\mathcal{C}} \text{ or } \mathcal{C} \sim \tilde{\mathcal{C}}}} \tilde{\mathcal{C}} \quad \text{and} \quad \mathcal{B}^- = \bigvee_{\substack{\tilde{\mathcal{C}} \in \mathfrak{X}(\mathcal{T}), \\ \tilde{\mathcal{C}} \leq \mathcal{B}, \\ \tilde{\mathcal{C}} \rightarrow \mathcal{C}}} \tilde{\mathcal{C}}.$$

This perspective is further developed in Lemma 7.27. \triangle

Remark 7.22. By Lemma 7.20, the iterated fiber product $\mathcal{K}(\mathcal{T}|\mathcal{C})$ may be considered as the *restriction* of $\mathcal{K}(\mathcal{T})$ to \mathcal{C} , hence our choice of notation. \triangle

Remark 7.23. In order to extend the Lemma 7.20 to obtain a similar description of the full face lattice of an n -associahedron, we first observe what a ridge (facet of a facet) looks like. A facet of $\mathcal{K}(\mathcal{T}/\mathcal{C}) \times \mathcal{K}(\mathcal{T}|\mathcal{C})$ must be either a facet of $\mathcal{K}(\mathcal{T}/\mathcal{C})$ or $\mathcal{K}(\mathcal{T}|\mathcal{C})$. In the former case, we can apply Lemma 7.20. In the latter case, it can be shown that a facet of $\mathcal{K}(\mathcal{T}|\mathcal{C})$ factors as a product of two smaller fiber products of n -associahedra. Thus, while a facet of an n -associahedron does not factor as a product of two smaller n -associahedra, a facet of a fiber product of n -associahedra factors as a product of two smaller fiber products of n -associahedra. This suggests that the category of fiber products of n -associahedra may be more well-behaved than the category of n -associahedra. \triangle

7.3. Fiber products of velocity fans.

Definition 7.24 (Fiber products of velocity fans). Let \mathcal{T} be a rooted plane tree and $\mathcal{C} \in \mathfrak{X}(\mathcal{T})$. We recursively define the iterated fiber product $\mathcal{F}(\mathcal{T}|\mathcal{C})$. For $A \in \mathcal{C}^n$ essential, let $\mathcal{F}(\mathcal{T}|\mathcal{C}, A) = \mathcal{F}(A)$. Next, let A be an essential k -bracket in \mathcal{C}^k for $k < n$. We denote

$$(210) \quad \tilde{\mathcal{F}}(\mathcal{T}|\mathcal{C}, A) := \prod_{\substack{\mathcal{F}(A) \\ A' \in \mathcal{C}^{k+1}, \\ A' \text{ essential}, \\ \pi(A') = A}} \mathcal{F}(\mathcal{T}|\mathcal{C}, A')$$

We define maps from the factors to the base as in Definition 7.18, but replace the combinatorial maps π with the corresponding geometric projections. An element of

$\tilde{\mathcal{F}}(\mathcal{T}|_{\mathcal{C}, A})$ can be viewed as a tuple of vectors. The initial parts of the vectors in a tuple agree with the image in the base. Lemma 7.16 allows us to delete the initial parts of these vectors leaving the coordinates of the base $\mathcal{F}(A)$, and we define the resulting collection as $\mathcal{F}(\mathcal{T}|_{\mathcal{C}, A})$.³⁵

Let A_\bullet be the fusion bracket for \mathcal{C} . We define

$$(211) \quad \mathcal{F}(\mathcal{T}|_{\mathcal{C}}) := \mathcal{F}(\mathcal{T}|_{\mathcal{C}, A_\bullet})$$

△

Lemma 7.25. *The face poset of $\mathcal{F}(\mathcal{T}|_{\mathcal{C}})$ is equal to $\mathcal{K}(\mathcal{T}|_{\mathcal{C}})$.*

Proof. The maps from the factors to the base in Definition 7.24 are combinatorially weakly semistable, hence the statement follows by Theorem 4.15 and iterated application of Lemma 7.12. □

Recall the definition of the localization of a cone complex a face given in Definition 3.30.

Remark 7.26. We can utilize fiber products of fans to give an alternate proof of the completeness property for the velocity fan. A fan is complete if and only if the stars of all of its rays are complete. If \mathcal{F}_1 and \mathcal{F}_2 are fans of the same dimension with the same dimensional lineality spaces and the same face posets, then \mathcal{F}_1 is complete if and only if \mathcal{F}_2 is complete. The fans $\mathcal{F}(\mathcal{T})_{\rho(\mathcal{C})}$ and $\mathcal{F}(\mathcal{T}/_{\mathcal{C}}) \times \mathcal{F}(\mathcal{T}|_{\mathcal{C}})$ are indeed fans of the same dimension with the same dimensional lineality spaces, and by Lemmas 7.20 and 7.25 they have isomorphic face posets. Furthermore, we know by induction and Corollary 7.14 that $\mathcal{F}(\mathcal{T}/_{\mathcal{C}}) \times \mathcal{F}(\mathcal{T}|_{\mathcal{C}})$ is complete, thus $\mathcal{F}(\mathcal{T})_{\rho(\mathcal{C})}$ is complete, implying $\mathcal{F}(\mathcal{T})$ is complete. △

In the previous remark, it was important that we allow \mathcal{F}_1 and \mathcal{F}_2 have the same face poset, but not necessarily be equal. Indeed, $\mathcal{F}(\mathcal{T})_{\rho(\mathcal{C})}$ and $\mathcal{F}(\mathcal{T}/_{\mathcal{C}}) \times \mathcal{F}(\mathcal{T}|_{\mathcal{C}})$ are not equal (if \mathcal{T} is not concentrated). We proceed towards a description of the relationship between these fans. We begin with a lemma clarifying what are the rays of the localization $\mathcal{F}(\mathcal{T})_{\rho(\mathcal{C})}$ for $\mathcal{C} \in \mathfrak{X}(\mathcal{T})$. This is essentially a combinatorial result about $\mathcal{K}(\mathcal{T})_{\mathcal{C}}$ and potentially could have appeared in subsection 2.2, although we leverage Theorem 4.15 for simplifying our argumentation.

Lemma 7.27. *Let $\mathcal{C}, \tilde{\mathcal{C}} \in \mathfrak{X}(\mathcal{T})$. The poset interval $\mathcal{K}(\mathcal{T})_{\mathcal{C}}$ is atomic, and $\tilde{\mathcal{C}} \vee \mathcal{C}$ defines an atom of $\mathcal{K}(\mathcal{T})_{\mathcal{C}}$ if and only if*

- (1) $\mathcal{C} \sim \tilde{\mathcal{C}}$,
- (2) For $\{\mathcal{C}_1, \mathcal{C}_2\} = \{\mathcal{C}, \tilde{\mathcal{C}}\}$ with $\mathcal{C}_1 \rightarrow \mathcal{C}_2$,
 - (a) \mathcal{C}_1 and \mathcal{C}_2 have different fusion brackets, or

³⁵This choice to remove redundant coordinates does not seem strictly necessary, but has been done primarily for dimensionality reasons, e.g. as discussed in Remark 7.26, the dimension of $\mathcal{F}(\mathcal{T}|_{\mathcal{C}})$ will now be equal to the dimension of the ambient space.

- (b) \mathcal{C}_1 and \mathcal{C}_2 have the same fusion brackets, and the largest $k \leq n$ such that $\pi^{n-k}(\mathcal{C}_2) \neq \pi^{n-k}(\mathcal{C}_1)$, there exists a unique essential k -bracket $A \in \mathcal{C}_2^k$ such that $A \notin \mathcal{C}_1^k$.

Proof. The fact that $\mathcal{K}(\mathcal{T})_{\mathcal{C}}$ is atomic follows as it is the face poset of a fan $\mathcal{F}(\mathcal{T})_{\rho(\mathcal{C})}$. In order to determine the atoms, we see that by Lemma 3.36 they must correspond to the rays of $\mathcal{F}(\mathcal{T})_{\rho(\mathcal{C})}$. These rays correspond to rays $\rho(\tilde{\mathcal{C}})$ of $\mathcal{F}(\mathcal{T})$ which together with $\rho(\mathcal{C})$ and $\mathbf{1}$ generate a cone of $\mathcal{F}(\mathcal{T})$. This occurs precisely when $\tilde{\mathcal{C}}$ and \mathcal{C} are the unique collisions contained in $\tilde{\mathcal{C}} \vee \mathcal{C}$. It is straightforward to verify that this occurs precisely in the cases listed above. \square

The following is the main result of this section.

Theorem 7.28. *Let $\rho(\mathcal{C})$ be a ray of the velocity fan $\mathcal{F}(\mathcal{T})$. There exists a piecewise-unimodular isomorphism*

$$(212) \quad \Theta_{\mathcal{C}} : \mathcal{F}(\mathcal{T})_{\rho(\mathcal{C})} \rightarrow \mathcal{F}(\mathcal{T}/_{\mathcal{C}}) \times \mathcal{F}(\mathcal{T}|_{\mathcal{C}})$$

such that $\Theta_{\mathcal{C}}^{-1}$ restricted to $\mathcal{F}(\mathcal{T}/_{\mathcal{C}}) \times \mathbf{0}$ is linear and agrees with $(P_{\sigma}^T)^{-1} \times \mathbf{0}$ restricted to $\mathcal{F}(\mathcal{T}/_{\mathcal{C}}) \times \mathbf{0}$, for σ a compatible \mathcal{T} shuffle for \mathcal{C} , and with the coordinates ordered according to σ .

The map $\Theta_{\mathcal{C}}$ will be defined as the unique piecewise-linear function induced by a certain map sending ray and lineality space generators of $\mathcal{F}(\mathcal{T})_{\rho(\mathcal{C})}$ to ray and lineality space generators of $\mathcal{F}(\mathcal{T}/_{\mathcal{C}}) \times \mathcal{F}(\mathcal{T}|_{\mathcal{C}})$.

We begin by clarifying the standard ray and lineality space generators for $\mathcal{F}(\mathcal{T})_{\rho(\mathcal{C})}$, $\mathcal{F}(\mathcal{T}/_{\mathcal{C}})$, and $\mathcal{F}(\mathcal{T}|_{\mathcal{C}})$. We take the lineality space generators in $\mathcal{F}(\mathcal{T})_{\rho(\mathcal{C})}$ to be $\mathbf{1}$ and $\rho(\mathcal{C})$. We take the ray generators for $\mathcal{F}(\mathcal{T})_{\rho(\mathcal{C})}$ to be the set of ray generators $\rho(\mathcal{C}')$ from $\mathcal{F}(\mathcal{T})$ which satisfy the conditions from Lemma 7.27. The fan $\mathcal{F}(\mathcal{T}/_{\mathcal{C}})$ is a velocity fan so we take the standard ray and lineality space generators for this velocity fan. We denote the all-ones vector which generates its lineality space as $\mathbf{1}/_{\mathcal{C}}$.

The lineality space generator for $\mathcal{F}(\mathcal{T}|_{\mathcal{C}})$ will be $\mathbf{1}|_{\mathcal{C}}$, i.e. the all-ones vector on its coordinates. We utilize Lemma 7.27 for defining the ray generators for $\mathcal{F}(\mathcal{T}|_{\mathcal{C}})$: if $\tilde{\mathcal{C}} \in \mathfrak{X}(\mathcal{T})$ with $\tilde{\mathcal{C}} \rightarrow \mathcal{C}$ satisfies condition (2) from Lemma 7.27, then the restriction of $\tilde{\mathcal{C}}$ to any bracket $A \in \mathcal{C}^k$ either gives an extended collision there or is the collection of singleton brackets in A . In the former case, we take the corresponding ray or lineality space generator for $\mathcal{F}(A)$. In the latter case, we take $\mathbf{0}$. We define the ray generator associated to $\tilde{\mathcal{C}}$ to be the concatenation of these vectors. We extend the ray and lineality space generators of $\mathcal{F}(\mathcal{T}/_{\mathcal{C}})$ and $\mathcal{F}(\mathcal{T}|_{\mathcal{C}})$ to ray and lineality space generators of $\mathcal{F}(\mathcal{T}/_{\mathcal{C}}) \times \mathcal{F}(\mathcal{T}|_{\mathcal{C}})$ by taking the product with $\mathbf{0}$ on the appropriate side.

We define a map $\hat{\Theta}_{\mathcal{C}}$ from ray and lineality space generators of $\mathcal{F}(\mathcal{T})_{\rho(\mathcal{C})}$, described in Lemma 7.27, to the ray and lineality space generators of $\mathcal{F}(\mathcal{T}/_{\mathcal{C}}) \times \mathcal{F}(\mathcal{T}|_{\mathcal{C}})$

as

$$(213) \quad \widehat{\Theta}_{\mathcal{C}}(\rho(\mathcal{C}')) = \begin{cases} (\rho(\mathcal{C}'), 0) & \text{if } \mathcal{C} \sim \mathcal{C}', \\ (\rho(\mathcal{C}'/\mathcal{C}), \mathbf{1}_{\mathcal{C}}) & \text{if } \mathcal{C} \rightarrow \mathcal{C}', \\ (0, \rho(\mathcal{C}')) & \text{if } \mathcal{C}' \rightarrow \mathcal{C}. \end{cases}$$

We take the convention that if $\mathcal{C}' = \mathcal{C}$, then $\rho(\mathcal{C}'/\mathcal{C}) = \mathbf{0}$, so the second and third cases agree. Note that if $\mathcal{C}' = \mathcal{B}_{\min}$, then $\widehat{\Theta}_{\mathcal{C}}(\rho(\mathcal{B}_{\min})) = \widehat{\Theta}_{\mathcal{C}}(\mathbf{1}) = (\mathbf{1}/_{\mathcal{C}}, \mathbf{1}|_{\mathcal{C}})$. We define $\Theta_{\mathcal{C}}$ to be the unique piecewise-linear map which extends $\widehat{\Theta}_{\mathcal{C}}$. We will prove that $\Theta_{\mathcal{C}}$ is well-defined, bijective, and unimodular on cones. Following the paradigm of this paper, our analysis of these maps will go by way of metric n -bracketings.

7.4. Fiber products of metric n -bracketing complexes.

Recall Definition 3.57 and Lemma 3.58.

Lemma 7.29. *Let $\mathcal{B} \in \mathcal{K}(\mathcal{T})$, and let $\mathcal{C}_0, \dots, \mathcal{C}_k$ be extended collisions with $\mathcal{C}_i \leq \mathcal{B}$ for all i . Let $\mathcal{C}_0 = \mathcal{B}_{\min}$, $\mathcal{C}_1 = \mathcal{C}$, and take $\lambda_i \in \mathbb{R}$ with $\lambda_i \geq 0$ for $i \geq 2$. Given a \mathcal{C} -metric n -bracketing $\ell_{\mathcal{B}}$ such that $\ell_{\mathcal{B}} = \sum_{i=0}^k \lambda_i \ell(\mathcal{C}_i)$, we define*

$$(214) \quad \Gamma_{\mathcal{C}}(\ell_{\mathcal{B}}) := \sum_{i=0}^k \lambda_i \rho(\mathcal{C}_i).$$

Then $\Gamma_{\mathcal{C}} : \mathcal{K}^{\text{met}}(\mathcal{T})_{\mathcal{C}} \rightarrow \mathcal{F}(\mathcal{T})_{\rho(\mathcal{C})}$ is a piecewise-linear isomorphism.

Proof. This follows by adding and subtracting $\rho(\mathcal{C})$, one of the lineality space generators for $\mathcal{F}(\mathcal{T})_{\rho(\mathcal{C})}$, as in the proof of Lemma 3.58, and applying Proposition 4.13. \square

Given a k -bracket A on \mathcal{T} , let $\mathcal{K}^{\text{met}}(A) := \mathcal{K}^{\text{met}}(\mathcal{T}|_A)$.

Definition 7.30 (Fiber products of metric n -bracketing complexes). Let \mathcal{T} be a rooted plane tree and $\mathcal{C} \in \mathfrak{X}(\mathcal{T})$. We recursively define the iterated fiber product $\mathcal{K}^{\text{met}}(\mathcal{T}|_{\mathcal{C}})$. For $A \in \mathcal{C}^n$ essential, let $\mathcal{K}^{\text{met}}(\mathcal{T}|_{\mathcal{C}, A}) = \mathcal{K}^{\text{met}}(A)$. Next, let A be an essential k -bracket in \mathcal{C}^k for $k < n$. We denote

$$(215) \quad \mathcal{K}^{\text{met}}(\mathcal{T}|_{\mathcal{C}, A}) := \prod_{\substack{A' \in \mathcal{C}^{k+1}, \\ A' \text{ essential}, \\ \pi(A') = A}}^{\mathcal{K}^{\text{met}}(A)} \mathcal{K}^{\text{met}}(\mathcal{T}|_{\mathcal{C}, A'})$$

We define maps from the factors to the base as in Definition 7.18, but replace the combinatorial maps π with the corresponding metric n -bracketing projections.

Let A_{\bullet} be the fusion bracket for \mathcal{C} . We define

$$(216) \quad \mathcal{K}^{\text{met}}(\mathcal{T}|_{\mathcal{C}}) := \mathcal{K}^{\text{met}}(\mathcal{T}|_{\mathcal{C}, A_{\bullet}}).$$

We refer to elements of $\mathcal{K}^{\text{met}}(\mathcal{T}|_{\mathcal{C}})$ as *fiber products of metric n -bracketings*. \triangle

Lemma 7.31. *The face poset of $\mathcal{K}^{\text{met}}(\mathcal{T}|\mathcal{C})$ is equal to $\mathcal{K}(\mathcal{T}|\mathcal{C})$.*

Proof. The maps from the factors to the base in Definition 7.30 are combinatorially weakly semistable, hence the statement follows by iterated application of Lemma 7.12. \square

One can canonically produce ray and lineality space generators for $\mathcal{K}^{\text{met}}(\mathcal{T}|\mathcal{C})$ mimicking the construction for $\mathcal{F}(\mathcal{T}|\mathcal{C})$.

Lemma 7.32. *There is a piecewise-linear isomorphism $\Gamma_{\mathcal{T}|\mathcal{C}} : \mathcal{K}^{\text{met}}(\mathcal{T}|\mathcal{C}) \rightarrow \mathcal{F}(\mathcal{T}|\mathcal{C})$ induced by sending the ray and lineality space generators of $\mathcal{K}^{\text{met}}(\mathcal{T}|\mathcal{C})$ to the ray and lineality space generators of $\mathcal{F}(\mathcal{T}|\mathcal{C})$.*

Proof. The statement follows by iteratively applying Lemma 7.17. \square

Definition 7.33. Let $\mathcal{C}' \in \mathfrak{X}(\mathcal{T})$ be as in Lemma 7.27. We define a map $\widehat{\Psi}^{\text{met}}$ from the ray and lineality space generators of $\mathcal{K}^{\text{met}}(\mathcal{T})_{\mathcal{C}}$ to the ray and lineality space generators for $\mathcal{K}^{\text{met}}(\mathcal{T}/\mathcal{C}) \times \mathcal{K}^{\text{met}}(\mathcal{T}|\mathcal{C})$:

$$(217) \quad \widehat{\Psi}^{\text{met}}(\ell(\mathcal{C}')) := \begin{cases} (\ell(\mathcal{C}'), 0) & \text{if } \mathcal{C}' \sim \mathcal{C} \\ (\ell(\mathcal{C}'/\mathcal{C}), \ell(\mathcal{C})) & \text{if } \mathcal{C} \rightarrow \mathcal{C}' \\ (0, \ell(\mathcal{C}')) & \text{if } \mathcal{C}' \rightarrow \mathcal{C}, \end{cases}$$

where $(0, \ell(\mathcal{C}'))$ in the third case denotes the product of the restrictions of $\ell(\mathcal{C}')$ to each essential bracket in \mathcal{C} . \triangle

Lemma 7.34. *The map $\widehat{\Psi}^{\text{met}}$ extends to a piecewise-linear isomorphism*

$$(218) \quad \Psi^{\text{met}} : \mathcal{K}^{\text{met}}(\mathcal{T})_{\mathcal{C}} \rightarrow \mathcal{K}^{\text{met}}(\mathcal{T}/\mathcal{C}) \times \mathcal{K}^{\text{met}}(\mathcal{T}|\mathcal{C}).$$

Proof. Combining Lemma 3.58 and Lemma 3.36, we find that, given a \mathcal{C} -metric n -bracketing $\ell_{\mathcal{B}} \in \mathcal{K}^{\text{met}}(\mathcal{T})_{\mathcal{C}}$, there exists compatible $\mathcal{C}_0, \dots, \mathcal{C}_k \in \widehat{\mathfrak{X}}(\mathcal{T})$ such that $\mathcal{C}_0 = \mathcal{B}_{\min}$, $\mathcal{C}_1 = \mathcal{C}$, for each $i \geq 2$, \mathcal{C}_i satisfies the conditions of Lemma 7.27, and there exist $\lambda_i \in \mathbb{R}$ with $\lambda_i \geq 0$ for $i \geq 2$ such that

$$(219) \quad \ell_{\mathcal{B}} = \sum_{i=0}^k \lambda_i \ell(\mathcal{C}_i),$$

and we define

$$(220) \quad \Psi^{\text{met}}(\ell_{\mathcal{B}}) := \sum_{i=0}^k \lambda_i \widehat{\Psi}^{\text{met}}(\ell(\mathcal{C}_i)).$$

We prove that Ψ^{met} is linear on each conical set in $\mathcal{K}^{\text{met}}(\mathcal{T})_{\mathcal{C}}$. Let $\mathcal{C}_1, \dots, \mathcal{C}_k$ and $\mathcal{C}'_0, \dots, \mathcal{C}'_l$ be compatible collisions which satisfies the conditions of Lemma 7.27. Take $\mathcal{C}_0 = \mathcal{C}'_0 = \mathcal{B}_{\min}$, and $\mathcal{C}_1 = \mathcal{C}'_1 = \mathcal{C}$. We prove that there exist $\lambda_i, \gamma_i \in \mathbb{R}$ with $\lambda_i, \gamma_i \geq 0$ for $i \geq 2$ such that

$$(221) \quad \sum_{i=0}^k \lambda_i \ell(\mathcal{C}_i) = \sum_{i=0}^l \gamma_i \ell(\mathcal{C}'_i)$$

if and only if

$$(222) \quad \sum_{i=0}^k \lambda_i \Psi^{\text{met}}(\mathcal{C}_i) = \sum_{i=0}^l \gamma_i \Psi^{\text{met}}(\mathcal{C}'_i).$$

Using the characterization of \mathcal{C} -metric n -bracketings in Lemma 3.58, it is clear, as in Lemmas 3.48 and 3.49, that we can group the terms in the sums in equation (221) according to their fusion brackets and the resulting sums are \mathcal{C} -metric n -bracketings. Moreover we have an equality of \mathcal{C} -metric n -bracketings in the sum (221) if and only if the restricted sums for each fusion bracket agree. Thus it suffices to prove that the “if and only if” statement holds for \mathcal{C} -metric n -bracketings whose underlying n -bracketings have the same fusion bracket.

Let A be the fusion bracket for \mathcal{C} . Let A' be the fusion bracket for the sum in question. It must be that either

- (1) $\overline{D}(A) \cap \overline{D}(A') = \emptyset$,
- (2) there exists some $k \geq 0$ such that $\pi^k(A') \subsetneq A$,
- (3) there exists some $k \geq 0$ such that $\pi^k(A) \subsetneq A'$,
- (4) $A = A'$.

For the cases (1) and (2), the equivalence is trivial. Suppose we are in case (3). By Lemma 3.50, we have that $\sum_{i=0}^k \lambda_i = \sum_{i=0}^l \gamma_i$, and the equivalence follows.

Suppose we are in case (4). Here we further subdivide the sum into two parts. The first corresponding to collisions \mathcal{C}' with $\mathcal{C}' \rightarrow \mathcal{C}$, and the second corresponding to collisions \mathcal{C}' with $\mathcal{C} \rightarrow \mathcal{C}'$ and $\mathcal{C}' \neq \mathcal{C}$. It again suffices to establish the equivalence for the two sums separately. The case $\mathcal{C}' \rightarrow \mathcal{C}$ is straightforward; check each essential bracket in \mathcal{C} individually. For the case $\mathcal{C} \rightarrow \mathcal{C}'$ with $\mathcal{C}' \neq \mathcal{C}$, the equivalence is again clear as $\sum_{i=0}^k \lambda_i = \sum_{i=0}^l \gamma_i$. □

7.5. Proof of Theorem 7.28.

Lemma 7.35. *The map $\widehat{\Theta}_{\mathcal{C}}$ extends to a piecewise-linear isomorphism*

$$(223) \quad \Theta_{\mathcal{C}} : \mathcal{F}(\mathcal{T})_{\rho(\mathcal{C})} \rightarrow \mathcal{F}(\mathcal{T}/\mathcal{C}) \times \mathcal{F}(\mathcal{T}|\mathcal{C}).$$

Proof. To verify that $\widehat{\Theta}_{\mathcal{C}}$ indeed extends to a piecewise-linear function $\Theta_{\mathcal{C}}$, we claim that we can interpret $\Theta_{\mathcal{C}}$ as a composition of three piecewise-linear isomorphisms

$$(224) \quad (\Gamma_{\mathcal{T}/\mathcal{C}} \times \Gamma_{\mathcal{T}|\mathcal{C}}) \circ \Psi^{\text{met}} \circ \Gamma_{\mathcal{C}}^{-1},$$

where $\Gamma_{\mathcal{T}/\mathcal{C}}$ is the map Γ from Definition 4.12 associated to the n -associahedron $\mathcal{K}(\mathcal{T}/\mathcal{C})$. It is straightforward to verify that the above map agrees with $\widehat{\Theta}_{\mathcal{C}}$ at the level of ray and lineality space generators, and the claim follows. □

Lemma 7.36. *The map $\Theta_{\mathcal{C}}$ is unimodular on each cone of $\mathcal{F}(\mathcal{T})_{\rho(\mathcal{C})}$.*

Proof. Because the reduced permutahedral velocity fan $\overline{\mathcal{F}}(\mathcal{O}(\mathcal{T}))$ is a unimodular triangulation of $\overline{\mathcal{F}}(\mathcal{T})$, we know that $\overline{\mathcal{F}}(\mathcal{O}(\mathcal{T}))_{\rho(\mathcal{C})}$ induces a unimodular triangulation of $\overline{\mathcal{F}}(\mathcal{T})_{\rho(\mathcal{C})}$. The map $\Theta_{\mathcal{C}}$ applied to $\mathcal{F}(\mathcal{O}(\mathcal{T}))_{\rho(\mathcal{C})}$ induces a subdivision of

$\mathcal{F}(\mathcal{T}/\mathcal{C}) \times \mathcal{F}(\mathcal{T}|\mathcal{C})$. For checking that $\Theta_{\mathcal{C}}$ is unimodular, it suffices to check that given a cone $\tau \in \mathcal{F}(\mathcal{O}(\mathcal{T}))_{\rho(\mathcal{C})}$, its image $\Theta_{\mathcal{C}}(\tau)$ is unimodular.

We can see that $\Theta_{\mathcal{C}}(\tau)$ factors as the product of two cones $\tau_1 \times \tau_2$ in the subdivision of $\mathcal{F}(\mathcal{T}/\mathcal{C}) \times \mathcal{F}(\mathcal{T}|\mathcal{C})$. The subdivision of $\mathcal{F}(\mathcal{T}/\mathcal{C})$ is equal to $\mathcal{F}(\mathcal{O}(\mathcal{T}/\mathcal{C}))$, hence τ_1 is unimodular. It remains to prove that τ_2 is unimodular. Construct a matrix whose columns correspond to ray and lineality space generators for τ_2 as in Lemma 5.38 and Proposition 5.48. Order the columns corresponding to rays according to the order of their preimages in $\mathcal{F}(\mathcal{T})$, and order the rows so that the entries corresponding to any particular essential k -bracket $A \in \mathcal{C}^k$ form a consecutive set. When we restrict to such a set of rows, we find the ray and lineality space generators of a cone in the triangulated velocity fan of the k -associahedron $\mathcal{K}(A)$, although there may be repetitions of columns. We can now proceed as in the argument for Lemma 5.38 by first performing the corresponding column subtractions. The appropriate replacement for the adjoint permutation is a block matrix with blocks give by P_{σ}^T associated to the various $\mathcal{F}(A)$ where A ranges over all essential brackets in \mathcal{C} .

We have chosen to work with the permutahedral velocity fan in this argument, rather than the triangulated velocity fan, because the recursive structure is less complicated: after quotienting a generalized collision by another generalized collision, the image is again a generalized collision. With this observation in hand, we can perform the Laplace expansion along the desired row and apply induction. \square

Lemma 7.37. *The function $\Theta_{\mathcal{C}}$ is such that $\Theta_{\mathcal{C}}^{-1}$ restricted to $\mathcal{F}(\mathcal{T}/\mathcal{C}) \times \mathbf{0}$ is linear and agrees with $(P_{\sigma}^T)^{-1} \times \mathbf{0}$ for σ a compatible \mathcal{T} -shuffle for \mathcal{C} .*

Proof. In order to verify this statement, we note that at the level of rays, if \mathcal{C}' satisfied the conditions of Lemma 7.27 and $\mathcal{C} \rightarrow \mathcal{C}'$, then $\Theta_{\mathcal{C}}(\rho(\mathcal{C}') - \rho(\mathcal{C})) = \rho(\mathcal{C}'/\mathcal{C})$, and if $\mathcal{C} \sim \mathcal{C}'$, then $\Theta_{\mathcal{C}}(\rho(\mathcal{C}')) = \rho(\mathcal{C}'/\mathcal{C})$. By Lemma 4.32, $\Theta_{\mathcal{C}}^{-1}$ restricted to ray and lineality space generators of $\mathcal{F}(\mathcal{T}/\mathcal{C}) \times \mathbf{0}$ agrees with $(P_{\sigma}^T)^{-1} \times \mathbf{0}$, with the coordinates ordered according to σ . Because there is at most one piecewise-linear map which extends a given map on ray and lineality space generators of a fan, the two functions must agree. \square

8. CONCENTRATED n -ASSOCIAHEDRA AS GENERALIZED PERMUTAHEDRA

We investigate a natural class of categorical n -associahedra which we call *concentrated*. These are precisely the n -associahedra associated to trees which admit no nontrivial \mathcal{T} -shuffles. This section serves two primary purposes, first to show how various results from earlier sections specialize nicely for concentrated n -associahedra, and second to provide a polytopal realization of concentrated n -associahedra advertising future work on projectivity for velocity fans.

We observe that, for a concentrated n -associahedron, the velocity fan is a coarsening of the braid arrangement, the triangulated velocity fan is the normal fan of a nestohedron, and the permutahedral velocity fan is always the braid arrangement. We produce a combinatorially meaningful support function on the velocity fan of

any concentrated n -associahedron which gives a polyhedral realization of this n -associahedron as a generalized permutahedron. We reexpress these polyhedral realizations as positive Minkowski sums of standard simplices and we provide an explicit vertex presentation. We observe that the simplices in Postnikov's Minkowski sum description of a nestohedron, specialized to the case of the triangulated concentrated n -associahedra, form a super set of the simplices in our Minkowski sum description of the concentrated n -associahedra. We demonstrate that the constrainahedra of the second and third authors can be recovered as a Minkowski sum of concentrated n -associahedra ranging over all concentrated trees \mathcal{T} having a specified number of vertices at each depth. This suggests a theory of *hypershuffle products of generalized permutahedra* extending the shuffle products of Chapoton and Pilaud.

Definition 8.1. A depth n tree \mathcal{T} is *concentrated* if for every $k < n$, there exists a single $u \in V(\mathcal{T})$ of depth k with $D(u) \neq \emptyset$. An n -associahedron $\mathcal{K}_{\mathcal{T}}$ is *concentrated* if \mathcal{T} is concentrated. \triangle

Remark 8.2. For 2-associahedra, a tree \mathcal{T} is concentrated if all points are concentrated on a single line in the corresponding arrangement. The class of concentrated n -associahedra includes the 1-associahedra, which correspond to trees \mathcal{T} of depth 1, and multiplihedra, which correspond to concentrated trees of depth 2 with exactly two depth 1 vertices. \triangle

Remark 8.3. A tree \mathcal{T} is concentrated if and only if the identity permutation is the only \mathcal{T} -shuffle. \triangle

Lemma 8.4. Let $\mathcal{K}(\mathcal{T})$ be a concentrated n -associahedron, and let \mathcal{C} an extended collision in $\mathcal{K}(\mathcal{T})$ so that $\mathfrak{S}(\mathcal{C}) = \{e\}$, where e is the identity permutation. Then $\rho(\mathcal{C}) = \zeta(\mathcal{C}) = \omega_e(\mathcal{C})$.

Proof. Because \mathcal{T} admits no nontrivial shuffles, we know that $\rho(\mathcal{C})$ is a 0-1 vector. A vertex u_i^k belongs to a nontrivial k -bracket with another vertex u_j^k where $i < j$, i.e. $\zeta(\mathcal{C})_i^k = 1$, if and only if u_i^k belongs to a nontrivial k -bracket with u_{i+1}^k , i.e. $\rho(\mathcal{C})_i^k = 1$, if and only if $\omega_e(\mathcal{C})_i^k = 1$. \square

Lemma 8.5. Let $\mathcal{K}(\mathcal{T})$ be a concentrated n -associahedron. The velocity fan of $\mathcal{K}(\mathcal{T})$ is a coarsening of the braid arrangement, and the triangulated velocity fan of $\mathcal{K}(\mathcal{T})$ is the normal fan of a nestohedron.

Proof. There are various ways to see this. For example, by Lemma 8.4, we know that $\rho(\mathcal{B}) = \zeta(\mathcal{B})$, hence the piecewise-linear map from Theorem 6.2 is the identity map. This shows that each cone in the velocity fan is union of cones in the braid arrangement, i.e. the velocity fan is a coarsening of the braid arrangement. The corresponding statement for the triangulated velocity fan follows as the nestohedral atlas for the triangulated velocity fan consists of a single chart corresponding to the identity permutation e , the set $V_e = \emptyset$, and the map $\Gamma_{\omega_e}^{\rho}$ described in Proposition 6.36 is the identity map. \square

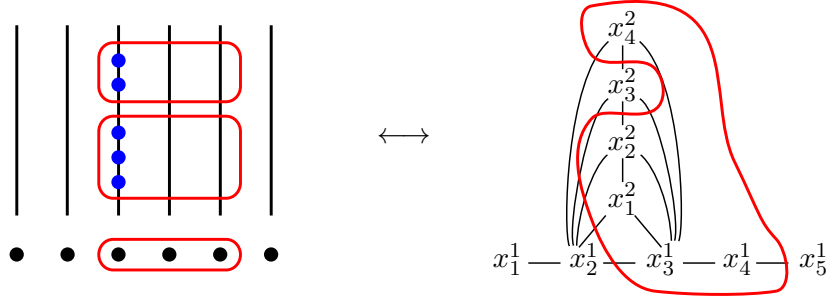

FIGURE 32. On the left: a collision in a concentrated 2-associahedron. On the right: the corresponding graph and tube.

We recall the definition of graph associahedra [CD06, Pos09], which form a special class of nestohedra.

Definition 8.6. Let $G = (V, E)$ be an undirected graph. A *tube* is a subset of $B \subseteq V$ such that the induced subgraph $G[B]$ is connected. The *graphical building set* of G is the collection of all tubes of G . \triangle

Definition 8.7. The *graph associahedron* for a graph G is the nestohedron associated to the graphical building set of G . \triangle

Lemma 8.8. *The triangulated velocity fans of concentrated n -associahedra are the normal fans of certain graph associahedra.*

Proof. Given concentrated tree \mathcal{T} , we first construct the desired graph $G(\mathcal{T})$ ³⁶ (see Figure 32 for an example). We identify the vertices of $G(\mathcal{T})$ with the coordinates x_i^k in the velocity fan for \mathcal{T} . Vertices of the same depth x_i^k and x_j^k are connected by an edge if $j = i + 1$, and for $k > l$ vertices x_i^k and x_j^l are connected by an edge if the vertex u_i^k is a descendant of u_j^l or u_{j-1}^l in \mathcal{T} . Graph associahedra are nestohedra, and triangulated concentrated n -associahedra are nestohedra by Lemma 8.5, where the building sets are described. Therefore, one is left to verify that the blocks of the two building sets are the same. Indeed, collisions, as presented by their 0-1 vectors, are in obvious bijection with the tubes on $G(\mathcal{T})$. \square

Recall, the permutahedral velocity fan defined in 5.47 is a finer triangulation of the velocity fan.

Lemma 8.9. *Permutahedral velocity fans for concentrated n -associahedra are braid arrangements.*

Proof. For a concentrated n -associahedron, the generalized collisions \mathcal{D} from Definition 5.41 have associated set of ray generators $\{\rho(\mathcal{D}) : \mathcal{D} \in \mathfrak{P}(\mathcal{T})\}$ equal to the

³⁶The notation $G_{\mathcal{T}}$ is used for the collision mixed graph.

set of all 0-1 vectors in \mathbb{R}^m different from $\mathbf{1}$. The partial order for generalized collisions described in Definition 5.43 specializes to the usual inclusion order on the 0-1 vectors, and the result follows. \square

Lemma 8.10. *The velocity fan of an n -associahedron $\mathcal{K}(\mathcal{T})$ is a coarsening of the braid arrangement if and only if $\mathcal{K}(\mathcal{T})$ is either concentrated or 1-dimensional.*

Proof. By Lemma 8.5 and Proposition 5.55, we know that velocity fans of concentrated and 1-dimensional n -associahedra are coarsenings of the braid arrangement. Conversely, suppose that $\mathcal{K}(\mathcal{T})$ is neither concentrated nor 1-dimensional. Then we can construct a collision \mathcal{C} such that $\rho(\mathcal{C})$ has three distinct values, and thus cannot be a ray of the braid arrangement. To see this, \mathcal{T} must have a vertex with two disjoint paths of length at least two leaving from it. We can use these paths to construct a collision \mathcal{C} such that $\rho(\mathcal{C})$ has a single entry 1, a single entry 2, and the nonempty set of remaining entries are all 0. \square

Remark 8.11. These are not the only categorical n -associahedra which can be realized as generalized permutahedra. For example, the 2-associahedron W_{110} is a hexagon and thus can be realized as a generalized permutahedron although not by one whose normal fan is the velocity fan. Asymptotically, the fraction of n -associahedra containing an octagonal face approaches 1, thus almost all n -associahedra cannot be realized as generalized permutahedra.

Remark 8.12. If $\mathcal{K}(\mathcal{T})$ is a concentrated n -associahedron and $\rho(\mathcal{C})$ is a ray of the velocity fan $\mathcal{F}(\mathcal{T})$, then the piecewise unimodular isomorphism afforded by Theorem 7.28 is the identity map. \triangle

Remark 8.13. Concentrated n -associahedra provide a natural generalization of the 2-associahedra where all the points are on the left-most line. (In the notation of [Bot19a], these are the 2-associahedra $W_{k0\dots 0}$.) These have an important interpretation in symplectic geometry. Recall that in [Bot17], the first author realized 2-associahedra as *witch curves*, which are the domains for the pseudoholomorphic quilts whose counts define the structure maps in the symplectic $(A_\infty, 2)$ -category Symp [AB22]. Symp is intended to be an implementation of functoriality of the Fukaya category with respect to Lagrangian correspondences. If we restrict ourselves to symplectic manifolds satisfying geometric conditions that are sufficient to exclude figure eight bubbling, it is possible to implement functoriality for the Fukaya category in a simpler fashion, using quilted disks with boundary marked points. Such quilted disks are exactly what these left-concentrated 2-associahedra parametrize. \triangle

8.1. Collision units for polytopes.

In this subsection we realize each concentrated n -associahedron as generalized permutahedron whose normal fan is the velocity fan. We proceed by constructing a support function on the velocity fan of a concentrated n -associahedron.

Let \mathcal{F} be a complete fan in \mathbb{R}^m , and $h : \mathbb{R}^m \rightarrow \mathbb{R}$ a piecewise-linear function on \mathcal{F} . We say that we say that h is *strongly convex* if, for any $\mathbf{u}, \mathbf{v} \in \mathbb{R}^m$ which do not

live in a common chamber of \mathcal{F} , we have

$$(225) \quad h(\mathbf{u} + \mathbf{v}) < h(\mathbf{u}) + h(\mathbf{v}).$$

Given a polytope $P \subseteq \mathbb{R}^m$ (not necessarily full-dimensional), its *support function* is $h_P : \mathbb{R}^m \rightarrow \mathbb{R}$, where for $\mathbf{v} \in \mathbb{R}^n$,

$$h_P(\mathbf{v}) := \min_{p \in P} \langle v, p \rangle.$$

The support function h_P is a piecewise-linear strongly convex function on the normal fan of P . Conversely, any strongly convex piecewise-linear function h on a complete fan \mathcal{F} is the support function of a polytope P with normal fan \mathcal{F} : every ray generator gives rise to a facet inequality, and generators of the lineality space give rise to equations. We call a fan \mathcal{F} *projective* if there exists a polytope P whose normal fan is \mathcal{F} .

Definition 8.14. Two polytopes are *normally equivalent* if their normal fans coincide. △

For a concentrated tree \mathcal{T} , we now introduce a collection $U(\mathcal{T})$ of combinatorial objects called *collision units* which will be utilized for defining support functions and vertex coordinates.

Definition 8.15. A *collision unit* \mathbf{c} is a list of length n , with entries \mathbf{c}_k such that

- (1) for each k , either $\mathbf{c}_k = \emptyset$ or $\mathbf{c}_k = \{u_i^k, u_j^k\}$, a pair of distinct vertices of depth k ,
- (2) \mathbf{c} has at least one nonempty entry, and
- (3) if \mathbf{c} has at least two nonempty entries, then each entry $\{u_i^k, u_j^k\}$ is of the form $\{u_i^k, u_{i+1}^k\}$. △

Definition 8.16. For a given concentrated tree \mathcal{T} , the collection $U(\mathcal{T})$ consists of all the collision units as defined above. △

Example 8.17. In a concentrated 2-associahedron, collision units are lists $(\{u_i^1, u_j^1\}, \emptyset)$ (pairs of lines), or lists $(\emptyset, \{u_i^2, u_j^2\})$ (pairs of points), or lists $(\{u_i^1, u_{i+1}^1\}, \{u_j^2, u_{j+1}^2\})$ (four-tuples of two lines and two points, where both the lines and the point are neighbors). △

Remark 8.18. Collision units are introduced for extending the classical realization of the associahedron as a generalized permutahedron: Shnider-Sternberg [SS93] describe the value of the support function on a ray of the wonderful associahedral fan corresponding to a single nontrivial 1-bracket A as the number of pairs of points contained in that bracket. Loday [Lod04] provides the vertex description, which we generalize in §8.4 also using collision units. △

Let $\mathbf{c}(\emptyset)$ denote the list having no nonempty entries. By the definition above, $\mathbf{c}(\emptyset)$ is not a collision unit, but it arises naturally when erasing entries in collision units.

Definition 8.19. For a collision unit $\mathbf{c} \in U(\mathcal{T})$, its *level* $l(\mathbf{c})$ is defined as the maximal index such that $\mathbf{c}_{l(\mathbf{c})} \neq \emptyset$. We let $\pi : U(\mathcal{T}) \rightarrow U(\pi(\mathcal{T})) \cup \{\mathbf{c}(\emptyset)\}$, denote the map which erases the last entry of a collision unit \mathbf{c} . \triangle

Definition 8.20. Let $A = (A^1, \dots, A^k)$ be a k -bracket. We say that a collision unit \mathbf{c} of level k is *contained* in A if $\mathbf{c}_i \subseteq A^i$ for all $i \leq k$. Let $U(A)$ denote the set of level k collision units contained in A . \triangle

Proposition 8.21. For a k -bracket $A = (A^1, \dots, A^k)$, the cardinality of the set $U(A)$ is equal to

$$(226) \quad \sum_{i=1}^k \binom{|A^i|}{2} + \prod_{i=1}^k |A^i| - \sum_{i=1}^k |A^i| + k - 1.$$

Proof. The summand $\sum_{i=1}^k \binom{|A^i|}{2}$ counts the collision units in A with exactly one nonempty entry, where there is no neighboring condition imposed on the entries. The number of other collision units in A is clearly equal to

$$\sum_{I \subseteq \{1, \dots, k\}, |I| \geq 2} \prod_{i \in I} (|A^i| - 1).$$

We thus need to verify the equality

$$\sum_{I \subseteq \{1, \dots, k\}, |I| \geq 2} \prod_{i \in I} (|A^i| - 1) = \prod_{i=1}^k |A^i| - \sum_{i=1}^k |A^i| + k - 1.$$

Moving $-\sum_{i=1}^k |A^i| + k - 1$ to the left, we obtain the sum over all the subsets including the empty one:

$$\sum_{I \subseteq \{1, \dots, k\}} \prod_{i \in I} (|A^i| - 1) = \prod_{i=1}^k |A^i|,$$

and the formula above follows immediately from the multinomial theorem. \square

We are now equipped to define the support function on the velocity fan. We first define it on metric n -bracketings, and then precompose with Γ , which is an isomorphism by Proposition 4.13.

Definition 8.22. Define $h_{\mathcal{T}}^{\text{met}} : \mathcal{K}^{\text{met}}(\mathcal{T}) \rightarrow \mathbb{R}$ as

$$(227) \quad h_{\mathcal{T}}^{\text{met}}(\ell_{\mathcal{B}}) := \sum_{\substack{1 \leq k \leq n \\ A \in \mathcal{B}^k}} \ell_{\mathcal{B}}(A) |U(A)|,$$

and define $h_{\mathcal{T}} : \mathcal{F}(\mathcal{T}) \rightarrow \mathbb{R}$ as $h_{\mathcal{T}} = h_{\mathcal{T}}^{\text{met}} \circ \Gamma^{-1}$. \triangle

Remark 8.23. Prop 8.21 allows us to write the definition of the support function by an explicit formula without referring to collision units. However, the framework of collision units will be very useful for establishing strong convexity in the following subsection. \triangle

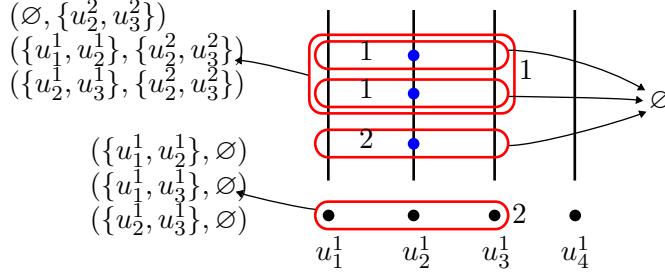

FIGURE 33. Here we depict a metric 2-bracketing and indicate the containment of collision units in individual brackets. The value of $h_{\mathcal{T}}$ is therefore equal to $1 \times 3 + 2 \times 3 = 9$.

Lemma 8.24. *For a concentrated n -associahedron $\mathcal{K}(\mathcal{T})$, the function $h_{\mathcal{T}}$ is piecewise-linear on the velocity fan $\mathcal{F}(\mathcal{T})$.*

Proof. By Proposition 4.15, it suffices to verify that $h_{\mathcal{T}}^{\text{met}}$ is piecewise-linear on $\mathcal{K}^{\text{met}}(\mathcal{T})$. It is clear that the function $h_{\mathcal{T}}^{\text{met}}$ agrees on the intersection of any two conical sets in $\mathcal{K}^{\text{met}}(\mathcal{T})$, so it remains to verify that $h_{\mathcal{T}}^{\text{met}}$ is linear on each conical set in $\mathcal{K}^{\text{met}}(\mathcal{T})$. By Definition 3.42, the addition of metric n -bracketings with compatible underlying bracketings is obtained by unioning bracket sets and adding weights on the same bracket. The above support function is defined as a sum of values, that are computed for individual k -brackets, regardless of the n -bracketing to which these k -brackets belong. The result follows. \square

Note that being defined individually on every bracket is a sufficient, but perhaps nonnecessary condition for a function to be linear on cones of the velocity fan.

Remark 8.25. Possible modifications of the support function include removing the condition of vertices being neighbors in the Definition 8.15 of a collision unit, or assigning a positive integral weight to every individual collision unit and counting it with such a weight. These modifications would give other integral functions, that are linear on the cones of the velocity fan in the concentrated case, and strictly convex. The function $h_{\mathcal{T}}$ described in this section is the minimal one having values in positive integers. \triangle

We now prove the following lemma.

Lemma 8.26. *The function $h_{\mathcal{T}}$, introduced in Definition 8.22, is strongly convex, that is, for \mathbf{u} and \mathbf{v} from different chambers of the velocity fan,*

$$(228) \quad h_{\mathcal{T}}(\mathbf{u} + \mathbf{v}) < h_{\mathcal{T}}(\mathbf{u}) + h_{\mathcal{T}}(\mathbf{v})$$

We need the following technical definition.

Definition 8.27. Let \mathbf{c} be a collision unit with $\{u_a^k, u_b^k\} \in \mathbf{c}$. Say that x_i^k is a \mathbf{c} -coordinate if $i \in [a, b]$. \triangle

Let $\mathcal{C} \in \mathfrak{X}(\mathcal{T})$. From Lemma 8.4, we know that \mathbf{c} is contained in some bracket of \mathcal{C} as in Definition 8.20 whenever $\rho(\mathcal{C})_i^k = 1$ for all \mathbf{c} -coordinates x_i^k . Since the velocity fan for a concentrated n -associahedron $\mathcal{K}(\mathcal{T})$ is a refinement of the braid arrangement by Lemma 8.10, it suffices to prove supermodularity of $h_{\mathcal{T}}$, which we now recall (see [ACEP20, CL15]). Let ρ_S and ρ_T be ray generators, that are indicator vectors for some sets S and T which are subsets in the set of all the coordinates of the fan. We denote by $\rho_{S \cup T}$ and $\rho_{S \cap T}$ the indicator vectors of, respectively, union and intersection of these sets and note that $\rho_S + \rho_T = \rho_{S \cup T} + \rho_{S \cap T}$. For any rays ρ_S and ρ_T , the vectors $\rho_{S \cup T}$ and $\rho_{S \cap T}$ belong to a common chamber of the braid arrangement, hence by Lemma 8.10, they belong to a common chamber of the velocity fan.

Remark 8.28. We emphasize that it is possible to have two collisions \mathcal{C}_1 and \mathcal{C}_2 with some nontrivial brackets $A_1 \in \mathcal{C}_1^k$ and $A_2 \in \mathcal{C}_2^k$ such that $A_1^k \cap A_2^k \neq \emptyset$, and $\rho_S = \rho(\mathcal{C}_1)$, $\rho_T = \rho(\mathcal{C}_2)$ with $S \cap T = \emptyset$. For example, take the 1-associahedron, and \mathcal{C}_1 and \mathcal{C}_2 determined by the brackets $\{u_i, u_{i+1}\}$ and $\{u_{i+1}, u_{i+2}\}$, respectively. \triangle

In the proof of the Lemma below, we let $\mathcal{C}(\rho)$ denote the collision corresponding to a ray generator $\rho \in \mathcal{F}(\mathcal{T})$.

Lemma 8.29. *For ρ_S and ρ_T ray generators from different chambers of the velocity fan,*

$$(229) \quad h_{\mathcal{T}}(\rho_S) + h_{\mathcal{T}}(\rho_T) < h_{\mathcal{T}}(\rho_{S \cup T}) + h_{\mathcal{T}}(\rho_{S \cap T})$$

Proof. Both sides count some collision units, once or twice. We show that every collision unit counted on the left is also counted on the right at least as many times, and there exists a collision unit counted on the right that does not appear on the left.

Let \mathbf{c} be a collision unit counted twice on the left. This means that all \mathbf{c} -coordinates are 1 in both ρ_S and ρ_T , thus also in $\rho_{S \cup T}$ and $\rho_{S \cap T}$, so \mathbf{c} is also counted twice on the right. Now let \mathbf{c} be a collision unit counted at least once on the left. This means that either all \mathbf{c} -coordinates are 1 in ρ_S , or in ρ_T , so also in $\rho_{S \cup T}$, so \mathbf{c} is also counted on the right.

We now construct a collision unit counted on the right but not on the left, working by induction. Case $n = 0$ is trivial. Assume the lemma for $(n - 1)$ -bracketings. If $\pi(\mathcal{C}(\rho_S))$ and $\pi(\mathcal{C}(\rho_T))$ are incompatible, then in particular they are collisions in $\mathcal{K}(\pi(\mathcal{T}))$ (note that it is not true for general projections of collisions). Then by induction there exists a collision unit in $\mathbf{c}^- \in U(\pi(\mathcal{T}))$ counted only on the right of the inequality

$$(230) \quad h_{\pi(\mathcal{T})}(\pi(\rho_S)) + h_{\pi(\mathcal{T})}(\pi(\rho_T)) < h_{\pi(\mathcal{T})}(\pi(\rho_{S \cup T})) + h_{\pi(\mathcal{T})}(\pi(\rho_{S \cap T}))$$

We lift it to the desired collision unit in $\mathbf{c} \in U(\mathcal{T})$ by appending \emptyset .

Now let $\pi(\mathcal{C}(\rho_S))$ and $\pi(\mathcal{C}(\rho_T))$ be compatible. Then there exist two incompatible n -brackets $A_S = (A_S^1, \dots, A_S^n) \in \mathcal{C}^n(\rho_S)$ and $A_T = (A_T^1, \dots, A_T^n) \in \mathcal{C}^n(\rho_T)$.

There are two possibilities: either A_S^n and A_T^n are not nested, or $A_S^n \subsetneq A_T^n$, while $\pi(A_T) \subsetneq \pi(A_S)$ (or vice versa). In the first case, there exists a pair of depth n vertices u_a^n and u_b^n with $u_a^n \in A_S^n$, $u_a^n \notin A_T^n$ and $u_b^n \in A_T^n$, $u_b^n \notin A_S^n$, and the desired collision unit consists of this pair and \emptyset elsewhere.³⁷

Suppose we are in the second case so that $A_S^n \subsetneq A_T^n$, while $\pi(A_T) \subsetneq \pi(A_S)$, and take \mathbf{c}^- some collision unit inside $U(\pi(A_S)) \sqcup U(\pi^2(A_S)) \dots \sqcup U(\pi^{n-1}(A_S))$ but not in $U(\pi(A_T)) \sqcup U(\pi^2(A_T)) \dots \sqcup U(\pi^{n-1}(A_T))$. Let (u_a^n, u_{a+1}^n) be a neighboring pair of points such that both are in A_T^n and at least one of them is not in A_S^n . Extending \mathbf{c}^- by sufficiently many \emptyset and this pair, we obtain the desired collision unit \mathbf{c} . \square

Remark 8.30. In the proof above we use the fact that for a concentrated n -associahedron, incompatibility of two collisions implies existence of two incompatible brackets. This statement is false for a general n -associahedron. \triangle

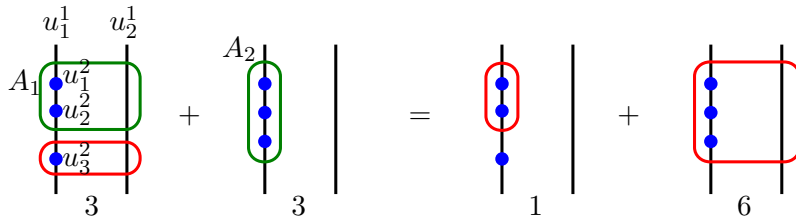

FIGURE 34. This picture illustrates the procedure in the proof above. We are in the case $A_1^2 \subsetneq A_2^2$, $\pi(A_2) \subsetneq \pi(A_1)$, so $\mathbf{c}^- = (\{u_1^1, u_2^1\})$, $\mathbf{c} = (\{u_1^1, u_2^1\}, \{u_2^2, u_3^2\})$.

We have thus proved the following.

Theorem 8.31. *Velocity fans for concentrated n -associahedra are projective.*

Given a concentrated rooted plane tree \mathcal{T} , we let $P(\mathcal{T})$ denote the polytope determined by the support function $h_{\mathcal{T}}$.

Remark 8.32. Loday’s associahedron [Lod04] is a special case of $P(\mathcal{T})$, as is Forcey’s multiplihedron [For08] (to be precise, a realization of the multiplihedron due to [AD13] is a special case – Forcey’s realization is a projection of this realization). \triangle

³⁷Note that this argument is the reason why we needed to allow nonneighboring vertices in collision units with only one nonempty entry.

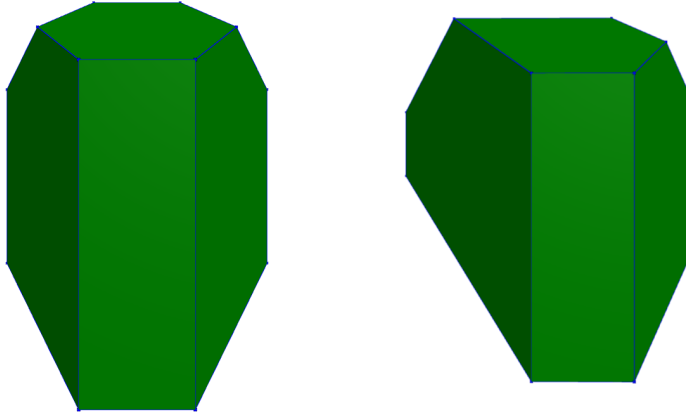

FIGURE 35. On the left: the polytope $P(3, 0, 0)$, which is also isomorphic to $P(0, 2, 0, 0)$. On the right: the polytope $P(2, 0, 0, 0)$.

We will refine our description of this realization by expressing it as a Minkowski sums of simplices, and by providing vertex coordinates.

8.2. Minkowski sums of simplices.

Any generalized permutahedron P admits a description as a signed Minkowski sum of the standard simplices (see [DK00, Pos09, ABD10]):

$$(231) \quad P = \sum_S \mathbf{y}_S(P) \Delta(S),$$

where S ranges over all the subsets of the ground set $[n]$, $\mathbf{y}_S(P) \in \mathbb{R}$, and $\Delta(S)$ denotes the convex hull of the standard basis vectors indicating elements of S . The class of Y -generalized permutahedra, also known as *hypergraph polytopes*, are those generalized permutahedra for which the coefficients in the sum satisfy $\mathbf{y}_S(P) \geq 0$, i.e. they are positive Minkowski sums of simplices. In this subsection, we describe concentrated n -associahedra as hypergraph polytopes: for a concentrated tree \mathcal{T} , we associate a simplex to every collision unit and take the sum of all such simplices.

Definition 8.33. For a collision unit \mathbf{c} , let $A(\mathbf{c})$ be the smallest bracket containing \mathbf{c} , and let $\mathcal{C}(\mathbf{c})$ be the smallest collision containing $A(\mathbf{c})$. The set $S(\mathbf{c})$ is defined as the support of the ray of $\mathcal{C}(\mathbf{c})$. The simplex associated to \mathbf{c} is thus $\Delta(S(\mathbf{c}))$. \triangle

Note that the smallest collision containing a bracket is well-defined in the concentrated case, but not in general.

Theorem 8.34. *The realized concentrated n -associahedron $P(\mathcal{T})$ has $\mathbf{y}_S(P(\mathcal{T})) = 1$ when $S = S(\mathbf{c})$ for some collision unit, and 0 otherwise.*

Proof. The polytope $P(\mathcal{T})$ is a generalized permutahedron. The Minkowski sum of simplices as described above is also a generalized permutahedron. To compare two

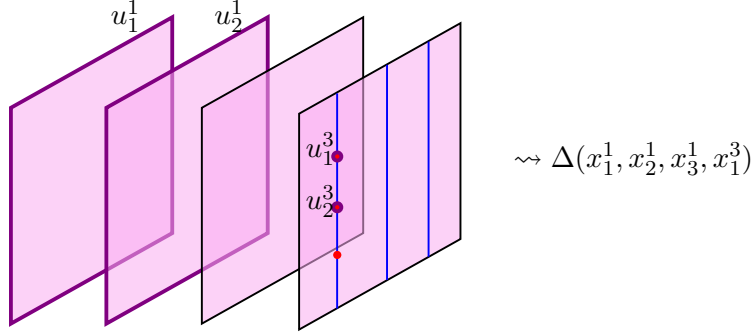

FIGURE 36. Here we depict a collision unit $\mathbf{c} = (\{u_1^1, u_2^1\}, \emptyset, \{u_1^3, u_2^3\})$ in a concentrated 3-associahedron, and a simplex associated to it by the above construction.

generalized permutahedra, it suffices to compare their support functions on all the 0-1-vectors. Any 0-1 vector ρ can be written as a sum of 0-1 vectors $\rho_1 + \dots + \rho_r$, where ρ_i are ray generators in the same chamber of the velocity fan. One then observes that a simplex $\Delta(S(\mathbf{c}))$ is contained in the support of ρ if and only if the collision unit \mathbf{c} is contained in a bracket of a collision corresponding to one of the ρ_i . \square

Proposition 8.35. *The realized concentrated n -associahedron $P(\mathcal{T})$ is a Minkowski-summand of the nestohedron associated to $\mathcal{K}(\Delta_{\mathcal{T}})$.*

Proof. The simplices in the Minkowski sum realization of a concentrated n -associahedron $\mathcal{K}(\mathcal{T})$ are a subset of the simplices in the Minkowski sum realization of the nestohedron whose normal fan is, by Lemma 8.5, the triangulated velocity fan $\mathcal{F}(\Delta_{\mathcal{T}})$: indeed, the latter set has a simplex for every collision, while the first set has simplices only for collisions of the form $\mathcal{C} = \mathcal{C}(\mathbf{c})$. \square

Remark 8.36. One can associate a simplex to *every* bracket just as in Definition 8.33, and sum these simplices. By doing so, one would obtain another realization of $\mathcal{K}(\mathcal{T})$ with the same fan, but with a nonminimal support function. \triangle

8.3. Recovering the constrainahedra.

We now describe the precise relationship between families of concentrated n -associahedra, and constrainahedra. Constrainahedra were envisioned by the second author, informally described in [Tie16] and formally defined in [BP22]. When realized in terms of “flappy trees”, the constrainahedra will be a key ingredient in equipping the Fukaya category with a monoidal A_{∞} -structure, in the context of SYZ mirror symmetry. (See [AB22, §5.4].) In [CP22] a normally equivalent presentation was given as shuffle products of associahedra, that is, as Minkowski sums of Cartesian products of associahedra with zonotopes associated to complete bipartite

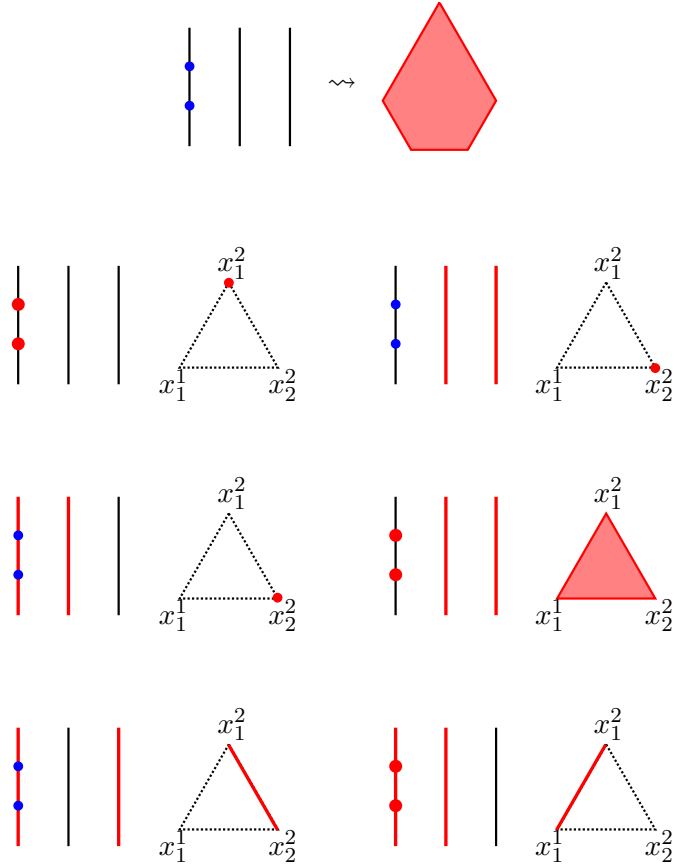

FIGURE 37. This is how the pentagon $\mathcal{K}_{2,0,0}$ is obtained as a Minkowski sum of simplices that correspond to its six collision units.

graphs, thus giving explicit Minkowski coefficients.³⁸ For the purposes of this subsection, we take this Minkowski sum description as the starting point for defining constrainahedron.

Definition 8.37. Fix a sequence of nonnegative integers $\mathbf{t} = (t_1, \dots, t_n)$. We define a polytope $C(\mathbf{t})$ in the space with coordinates x_i^k with $1 \leq k \leq n$ and $1 \leq i \leq t_k$. The polytope is defined as having Minkowski coordinates $\mathbf{y}_S(C(\mathbf{t})) = 1$ when $S = \{(k, i) \dots, (k, j)\}$ for some $1 \leq k \leq n$ and $1 \leq i < j \leq t_k$ (these correspond to associahedral summands) or when $S = \{(k, i), (k', j)\}$ for some $1 \leq k \neq k' \leq n$, $1 \leq i \leq t_k$, $1 \leq j \leq t_{k'}$ (these correspond to zonotopal summands), and 0 otherwise. We define a *constrainahedron of profile \mathbf{t}* to be any polytope which is normally equivalent to $C(\mathbf{t})$. \triangle

³⁸In the recent work of Black-Lütjeharms-Sanyal [BLS24], a rather different realization of constrainahedra is provided as pivot rule polytopes of products of simplices.

Combinatorially, faces of constrainahedra correspond to iterated collisions in a grid of orthogonal hyperplanes, as explained in [BP22]. Similarly to the velocity fan, a facet normal indicates which hyperplanes collided.

The value of the support function on such a ray is equal to the number of *constrainahedral collision units* participating in this collision, where the definition of a collision unit is repeated verbatim with vertices of \mathcal{T} replaced by labels of hyperplanes.

Definition 8.38. Fix a sequence of nonnegative integers $\mathbf{t} = (t_1, \dots, t_n)$. A tree \mathcal{T} (and the corresponding n -associahedron) is said to have profile \mathbf{t} if it has $t_k + 1$ vertices of depth k . \triangle

In the proof of the next theorem, we utilize the criterion for when the normal fan of a generalized permutahedron P coarsens the normal fan of a generalized permutahedron Q . The criterion combines the interpretation of chambers in the normal fan as domains of linearity for the support function, and the fact that face normals of generalized permutahedra are 0-1 vectors.

Proposition 8.39. *Let P and Q be generalized permutahedra with support functions f_P and f_Q , respectively. The normal fan of P coarsens the normal fan of Q , when for any pair of 0-1-vectors \mathbf{v} and \mathbf{w} the strict inequality $f_P(\mathbf{v}) + f_P(\mathbf{w}) < f_P(\mathbf{v} \vee \mathbf{w}) + f_P(\mathbf{v} \wedge \mathbf{w})$ implies the strict inequality $f_Q(\mathbf{v}) + f_Q(\mathbf{w}) < f_Q(\mathbf{v} \vee \mathbf{w}) + f_Q(\mathbf{v} \wedge \mathbf{w})$.*

The following theorem demonstrates how we can recover constrainahedra in our setting. The theorem is perhaps surprising as there are rays in constrainahedra which are not present in any of the concentrated n -associahedra of the same profile.

Theorem 8.40. *Fix a tuple $\mathbf{t} = (t_1, \dots, t_n)$ of nonnegative integers. The polytope*

$$C'(\mathbf{t}) = \sum_{\mathcal{T}} P(\mathcal{T}),$$

where \mathcal{T} ranges over all the concentrated trees of profile \mathbf{t} , is a constrainahedron of profile \mathbf{t} .

Proof. We prove that $C'(\mathbf{t})$ is normally equivalent to $C(\mathbf{t})$. The simplices appearing in $C'(\mathbf{t})$ are described by 8.33. The simplices appearing in $C(\mathbf{t})$, as described in 8.37, are a subset of those; they can be realized as $\Delta(S(\mathbf{c}))$ for appropriately chosen \mathcal{T} and \mathbf{c} . It suffices to show that the extra simplices added to obtain $C'(\mathbf{t})$ do not change the normal equivalence class, that is, that their normal fans are coarsenings of the normal fan of $C(\mathbf{t})$. In the notation of Proposition 8.39, take $Q = C(\mathbf{t})$, and take $P = \Delta(S(\mathbf{c}))$ one of those extra simplices, corresponding to a collision unit \mathbf{c} as in 8.33. For a 0-1 vector \mathbf{v} , the value $f_P(\mathbf{v})$ is 1 if S is included in the support set of \mathbf{v} , and 0 otherwise. The strict inequality $f_P(\mathbf{v}) + f_P(\mathbf{w}) < f_P(\mathbf{v} \vee \mathbf{w}) + f_P(\mathbf{v} \wedge \mathbf{w})$ means that S is in the support of $\mathbf{v} \vee \mathbf{w}$, but not \mathbf{v} or \mathbf{w} independently. Then the inequality $f_Q(\mathbf{v}) + f_Q(\mathbf{w}) < f_Q(\mathbf{v} \vee \mathbf{w}) + f_Q(\mathbf{v} \wedge \mathbf{w})$ holds, because \mathbf{c} viewed as a constrainahedral collision unit contributes only to the right-hand side, namely to the summand $f_Q(\mathbf{v} \vee \mathbf{w})$. \square

Example 8.41. In the setting of the previous proof, let \mathbf{c} be the collision unit $(\{u_1^1, u_2^1\}, \emptyset, \{u_1^3, u_2^3\})$ from the 3-associahedron from Figure 36 so that $P = \Delta(x_1^1, x_2^1, x_3^1, x_1^3, x_2^3)$. The coordinates for the whole fan are $x_1^1, x_2^1, x_3^1, x_1^2, x_2^2, x_1^3, x_2^3$. The inequality $f_P(\mathbf{v}) + f_P(\mathbf{w}) < f_P(\mathbf{v} \vee \mathbf{w}) + f_P(\mathbf{v} \wedge \mathbf{w})$ is strict, for example, for $\mathbf{v} = (1, 1, 1, 1, 0, 0, 0)$ and $\mathbf{w} = (1, 0, 0, 0, 0, 1, 0)$, as $S(\mathbf{c})$ is only included in the support of $\mathbf{v} \vee \mathbf{w}$. Then for $Q = C(3, 2, 2)$ the inequality $f_Q(\mathbf{v}) + f_Q(\mathbf{w}) < f_Q(\mathbf{v} \vee \mathbf{w}) + f_Q(\mathbf{v} \wedge \mathbf{w})$ is strict (namely it is $10 + 3 < 18 + 1$), and if we read u_i^k as labels of hyperplanes for $C(3, 2, 2)$, then the same \mathbf{c} contributes only to $f_Q(\mathbf{v} \vee \mathbf{w})$. \triangle

The above construction indicates that concentrated n -associahedra can be obtained from Cartesian products of usual associahedra by Minkowski-adding certain *hypergraph polytopes* [BBM19]. Indeed, the simplices not from associahedra — those of the form $\Delta(S(\mathbf{c}))$ for \mathbf{c} having more than one nonempty entry — correspond to some hyperedges. Chapoton and Pilaud in [CP22] introduced an operation of taking *shuffle products* of generalized permutahedra, which consists of taking Cartesian product and then adding a graphical zonotope associated to the complete bipartite graph. Shuffle products of associahedra are constrainahedra. The results of this section indicate that the operation of shuffling could be generalized to a certain operation of *hypershuffling*, to be described and studied elsewhere.

8.4. Vertex presentation.

In this section we discuss explicit formulas for vertex coordinates, generalizing Loday’s vertex description for associahedra [Lod04] and, a bit less directly, Forcey’s vertex description for multiplihedra [For08].

Consider a maximal n -bracketing \mathcal{B} . We now define what it means for a collision unit to *contribute* to a certain coordinate for the corresponding vertex.

Definition 8.42. Let x_i^k be a coordinate in the velocity fan. Denote by $\mathcal{B}_{x_i^k}$ the collection of l -brackets for all $l \geq k$ that contain u_i^k and u_{i+1}^k and do not contain any other bracket containing u_i^k and u_{i+1}^k (i.e. are containment-minimal among such). A collision unit \mathbf{c} *contributes* to x_i^k in \mathcal{B} if it is contained in some l -bracket $A \in \mathcal{B}_{x_i^k}$ in the sense of 8.20 and is not contained in any other l -bracket $A' \subsetneq A$. \triangle

We now provide an informal rephrasing of the definition above for the reader’s convenience. Suppose that the consecutive affine spaces in our concentrated tree arrangement are identified one by one until we reach a single complete flag. Then we can associate a maximal n -bracketing \mathcal{B} which encodes this process of identifying affine spaces, up to order of disjoint identifications. A collision unit \mathbf{c} contributes to x_i^k in \mathcal{B} if the moment when the corresponding consecutive pair of spaces L_i^k and L_{i+1}^k are identified is the moment when all of the affine spaces present in \mathbf{c} are contracted to a single flag of affine spaces.

Denote by X_i^k the set of collision units contributing to x_i^k .

Definition 8.43. The point $\mathbf{v}(\mathcal{B}) \in \mathbb{R}^m$ corresponding to the maximal bracketing \mathcal{B} is defined as having the coordinates

$$(232) \quad \mathbf{v}(\mathcal{B})_i^k = |X_i^k|$$

△

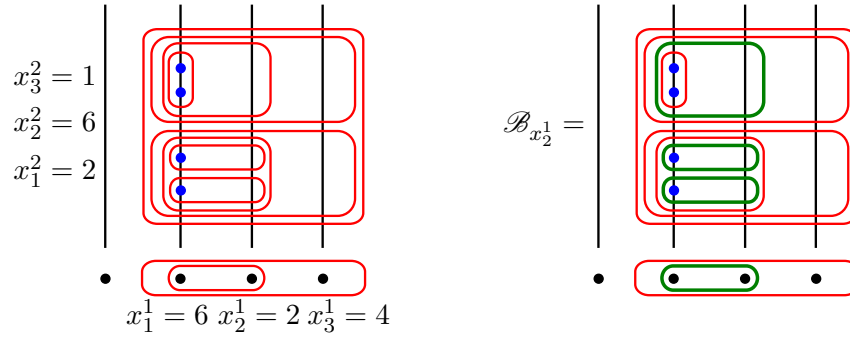

FIGURE 38. Here is an illustration of the above formula for a particular maximal 2-bracketing in $\mathcal{K}_{0,4,0,0}$.

We now prove the following theorem.

Theorem 8.44. *The convex hull of the points $\mathbf{v}(\mathcal{B})$ for all maximal n -bracketings \mathcal{B} is the polytope $P(\mathcal{T})$.*

Proof. The proof is provided by Lemmas 8.46-8.50. □

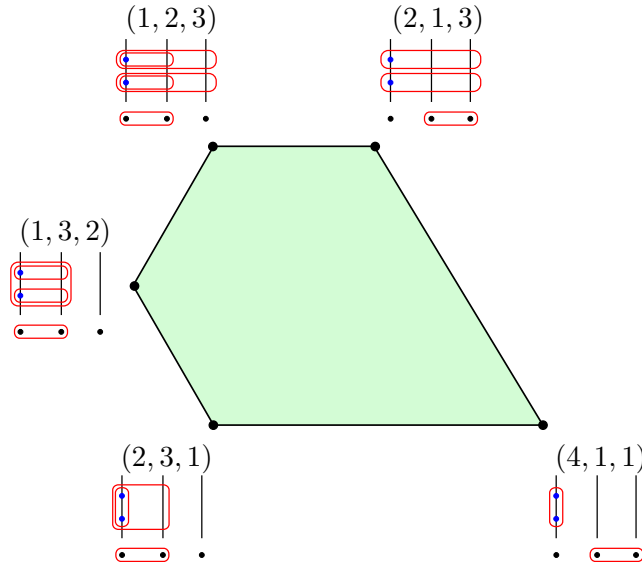

FIGURE 39. The vertex coordinates for the pentagon $\mathcal{K}_{2,0,0}$.

We begin with a general lemma on the structure of maximal n -bracketings in a concentrated n -associahedra. See also Remark 8.47 for a connection with the second author's dimension formula for 2-bracketings.

Definition 8.45. Let \mathcal{B} be a maximal n -bracketing. For $A \in \mathcal{B}^k$, we say that $A' \in \mathcal{B}^k$ is its *child* if $A' \subsetneq A$ and there does not exist $A'' \in \mathcal{B}^k$ with $A' \subsetneq A'' \subsetneq A$. \triangle

Lemma 8.46. *Let \mathcal{B} be a maximal n -bracketing in a concentrated n -associahedron. Consider a nonsingleton bracket $A = (A^1, \dots, A^k) \in \mathcal{B}^k$ for some $k \leq n$. Then one of the following holds:*

- (1) *A has one child subbracket $A_{thin} = (A_{thin}^1, \dots, A_{thin}^k)$, and $A_{thin}^m \neq A^m$ for exactly one $m < k$.*
- (2) *A has two children subbrackets $A_1 = (A_1^1, \dots, A_1^k)$ and $A_2 = (A_2^1, \dots, A_2^k)$, and $A^i = A_1^i = A_2^i$ for all $i < k$ and $A^k = A_1^k \sqcup A_2^k$.*

Proof. For a k -bracket A , let us consider its children and rule out all the possibilities except for the ones listed above.

- If A has three or more children, then there exists $\mathcal{B}' > \mathcal{B}$ obtained by adding a bracket that joins two or more of these children.
- Suppose A has two children, $A_1 = (A_1^1, \dots, A_1^k)$ and $A_2 = (A_2^1, \dots, A_2^k)$. Then $A^k = A_1^k \sqcup A_2^k$ by (PARTITION) in 2.10. If $A^i \neq A_1^i$ for some $i < k$, then there exists $\mathcal{B}' > \mathcal{B}$, obtained by adding a bracket that joins A_1 and A_2 but is still smaller than A on depth i .
- Suppose A has one child, $A_{thin} = (A_{thin}^1, \dots, A_{thin}^k)$. Then $A_{thin}^k = A^k$ by (PARTITION) in 2.10. Suppose there are two indices $i_1, i_2 < k$ such that $A_{thin}^{i_j} \neq A^{i_j}$. Then there exists $\mathcal{B}' > \mathcal{B}$ obtained by adding a bracket A_{thick} , where $A_{thick}^i = A_{thin}^i$ for all i except for i_1 , and $A_{thick}^{i_1} = A^{i_1}$. \square

Remark 8.47. In [Bot19a, Lemma 3.5(a)], the second author proved a dimension formula for tree-pairs, which are equivalent data to 2-bracketings. In the notation of that paper, this formula reads:

(233)

$$d(2T) = \sum_{\alpha \in V_{\text{comp}}^1(T_b) \text{ in}(\alpha)=(\beta)} (\#\text{in}(\beta) - 2) + \sum_{\alpha \in V_{\text{comp}}^{\geq 2}(T_b)} \left(\left(\sum_{\beta \in \text{in}(\alpha)} \#\text{in}(\beta) \right) - 1 \right) + \sum_{\rho \in (T_s)_{\text{int}}} (\#\text{in}(\rho) - 2).$$

A tree-pair corresponds to a maximum 2-bracketing exactly when $d(2T) = 0$. Each of the summands in (233) is nonnegative, so if $d(2T) = 0$, each of these summands must be zero. The first two sums cannot both be empty, hence there must be at least one zero summand in either the first or second sum. This zero summand

corresponds to either case (1) or (2) in Lemma 8.46, depending whether it appears in the second or first sum, respectively. \triangle

Basing on the cases and the notation of Lemma 8.46, we define centers of brackets.

Definition 8.48. Let A be a k -bracket as in case (1) in 8.46. Then its *center* is the coordinate x_i^r such that, of the pair u_i^r and u_{i+1}^r , both are in A^r , but only one is in A_{thin}^r . Let A be a k -bracket as in case (2) in 8.46. Then its *center* is the coordinate x_i^k , where the pair u_i^k and u_{i+1}^k has $u_i^k \in A_1^k$ and $u_{i+1}^k \in A_2^k$. \triangle

Lemma 8.49. *The point $\mathbf{v}(\mathcal{B})$ for any maximal n -bracketing $\mathcal{B} \in \mathcal{K}(\mathcal{T})$ belongs to the affine hyperplane, where the sum of all coordinates equals $|U(\mathcal{T})|$.*

Proof. We show that the sum of all coordinates counts every collision unit once. If a collision unit \mathbf{c} is contained in two different k -brackets of the n -bracketing \mathcal{B} , then these brackets intersect, and by the (NESTED) condition, one of these brackets contains another. Therefore, for every \mathbf{c} there exists a unique containment-minimal bracket of \mathcal{B} in which \mathbf{c} is contained. The collision unit \mathbf{c} then contributes to the center of this bracket. \square

Now let $\mathcal{C} \in \mathfrak{X}(\mathcal{T})$. Denote by $U(\mathcal{C})$ the set of collision units contained in all brackets of \mathcal{C} , and denote by S the support of the 0-1 vector $\rho(\mathcal{C})$.

Lemma 8.50. *For all maximal n -bracketings \mathcal{B} it holds that*

$$(234) \quad \sum_{x_i^k \in S} \mathbf{v}(\mathcal{B})_i^k \geq |U(\mathcal{C})|$$

with equality if and only if $\mathcal{C} \leq \mathcal{B}$.

Proof. We show that the collision units of $U(\mathcal{C})$ always contributes to one of the coordinates in the left-hand side of above expression, and in case when \mathcal{B} refines \mathcal{C} , there are no other collision units contributing to these coordinates.

A collision unit \mathbf{c} can only contribute to one of \mathbf{c} -coordinates in the sense of 8.27. The left-hand side of the above expression lists all of \mathbf{c} -coordinates for collision units $\mathbf{c} \in U(\mathcal{C})$. Summing the values of the corresponding coordinates counts all the collision units contributing to these coordinates, and we have shown that in the very least these are all the collision units of $U(\mathcal{C})$, thus proving the inequality.

We now prove the equation. Assume first $\mathcal{C} \leq \mathcal{B}$. We need to see, that collision units from $U(\mathcal{T}) \setminus U(\mathcal{C})$ do not contribute to the coordinates listed on the left-hand side. Assume, to the contrary, there exists such a collision unit $\mathbf{c} \notin U(\mathcal{C})$. Any bracket to which it may contribute, as in Definition 8.42, intersects nontrivially with a bracket of \mathcal{C} , which cannot happen in an n -bracketing.

Assume now that \mathcal{C} is not compatible with \mathcal{B} ; we construct a collision unit $\mathbf{c} \notin U(\mathcal{C})$ contributing to one of the coordinates in S for $\mathbf{v}(\mathcal{B})$. Let $A \in \mathcal{B}^k$ be a k -bracket incompatible with some k -bracket in \mathcal{C}^k ; such an A necessarily exists because \mathcal{T} is concentrated. Let $A' \in \mathcal{B}^k$ be the smallest bracket having center $x_i^r \in S$ such that $A \subseteq A'$ (A' may or may not coincide with A). There are two cases

to consider. First assume that there exists $\mathbf{c}' \in U(A) \sqcup U(\pi(A)) \sqcup U(\pi^2(A)) \dots \sqcup U(\pi^{k-1}(A))$ which is not in $U(\mathcal{C})$ and has $\mathbf{c}'_r = \emptyset$. Then the collision unit \mathbf{c} , which is obtained by adding $\{u_i^r, u_{i+1}^r\}$ as the r th entry to \mathbf{c}' , is not in $U(\mathcal{C})$ and is contained in A' , thus contributing to x_i^r on the right-hand side. Now assume that all collision units which are in $U(A) \sqcup U(\pi(A)) \sqcup U(\pi^2(A)) \dots \sqcup U(\pi^{k-1}(A))$, but not in $U(\mathcal{C})$, have nonempty r th entry. This implies that there exists a collision unit $\mathbf{c}' \in U(A) \sqcup U(\pi(A)) \sqcup U(\pi^2(A)) \dots \sqcup U(\pi^{k-1}(A))$ with $\mathbf{c}' \notin U(\mathcal{C})$, which has only r th entry nonempty so that $\mathbf{c}'_r = \{u_j^r, u_l^r\}$. We either have $j < l < i$ or $i+1 < j < l$, and we assume the former order (the argument for the latter order is the similar). The desired collision unit \mathbf{c} is obtained from \mathbf{c}' by replacing $\{u_j^r, u_l^r\}$ with $\{u_i^r, u_{i+1}^r\}$. \square

REFERENCES

- [AA23] Marcelo Aguiar and Federico Ardila. Hopf monoids and generalized permutahedra. *Memoirs of the American Mathematical Society*, 289(1437), 2023.
- [AB22] Mohammed Abouzaid and Nathaniel Bottman. Functoriality in categorical symplectic geometry. *arXiv preprint arXiv:2210.11159*, 2022.
- [ABD10] Federico Ardila, Carolina Benedetti, and Jeffrey Doker. Matroid polytopes and their volumes. *Discrete & Computational Geometry*, 43:841–854, 2010.
- [ACEP20] Federico Ardila, Federico Castillo, Christopher Eur, and Alexander Postnikov. Coxeter submodular functions and deformations of Coxeter permutahedra. *Advances in Mathematics*, 365:107039, 2020.
- [AD13] Federico Ardila and Jeffrey Doker. Lifted generalized permutahedra and composition polynomials. *Adv. in Appl. Math.*, 50(4):607–633, 2013.
- [ADH23] Federico Ardila, Graham Denham, and June Huh. Lagrangian combinatorics of matroids. *Algebr. Comb.*, 6(2):387–411, 2023.
- [AHBHY18] Nima Arkani-Hamed, Yuntao Bai, Song He, and Gongwang Yan. Scattering forms and the positive geometry of kinematics, color and the worldsheet. *Journal of High Energy Physics*, 2018(5):1–78, 2018.
- [AHHL⁺21] Nima Arkani-Hamed, Song He, Thomas Lam, et al. Cluster configuration spaces of finite type. *SIGMA. Symmetry, Integrability and Geometry: Methods and Applications*, 17:092, 2021.
- [AHT14] Nima Arkani-Hamed and Jaroslav Trnka. The amplituhedron. *Journal of High Energy Physics*, 2014(10):1–33, 2014.
- [AK00] Dan Abramovich and Kalle Karu. Weak semistable reduction in characteristic 0. *Inventiones mathematicae*, 139(2):241–273, 2000.
- [AKW06] Federico Ardila, Caroline Klivans, and Lauren Williams. The positive Bergman complex of an oriented matroid. *European Journal of Combinatorics*, 27(4):577–591, 2006.
- [ALPT18] Karim Adiprasito, Gaku Liu, Igor Pak, and Michael Temkin. Log smoothness and polystability over valuation rings. *arXiv preprint arXiv:1806.09168*, 2018.
- [ALT18] Karim Adiprasito, Gaku Liu, and Michael Temkin. Semistable reduction in characteristic 0. *arXiv preprint arXiv:1810.03131*, 2018.
- [ARW05] Federico Ardila, Victor Reiner, and Lauren Williams. Bergman complexes, Coxeter arrangements, and graph associahedra. *Séminaire Lotharingien de Combinatoire [electronic only]*, 53, 2005.
- [Bat98] Michael A. Batanin. Monoidal globular categories as a natural environment for the theory of weak n -categories. *Advances in Mathematics*, 136(1):39–103, 1998.
- [BBM19] Carolina Benedetti, Nantel Bergeron, and John Machacek. Hypergraphic polytopes: combinatorial properties and antipode. *Journal of Combinatorics*, 10(3):515–544, 2019.

- [BC21] Nathaniel Bottman and Shachar Carmeli. $(A_\infty, 2)$ -categories and relative 2-operads. *Higher Structures*, 5(1):401–421, 2021.
- [BD24] Spencer Backman and Rick Danner. Convex geometry of building sets. *arXiv preprint arXiv:2403.05514*, 2024.
- [BDLLS23] Alexander E. Black, Jesús A. De Loera, Niklas Lütjeharms, and Raman Sanyal. The polyhedral geometry of pivot rules and monotone paths. *SIAM Journal on Applied Algebra and Geometry*, 7(3):623–650, 2023.
- [BGW03] Alexandre V. Borovik, Israel M. Gelfand, and Neil White. *Coxeter matroids*. Springer, 2003.
- [BHLT09] Nantel Bergeron, Christophe Hohlweg, Carsten Lange, and Hugh Thomas. Isometry classes of generalized associahedra. *Séminaire Lotharingien de Combinatoire [electronic only]*, 61:B61Aa–13, 2009.
- [BLS24] Alexander E. Black, Niklas Lütjeharms, and Raman Sanyal. From linear programming to colliding particles. *arXiv preprint arXiv:2405.08506*, 2024.
- [BM19] Nathaniel Bottman and Dylan Mavrides. The 2-associahedra are Eulerian. *arXiv preprint arXiv:1910.09672*, 2019.
- [BO19] Nathaniel Bottman and Alexei Oblomkov. A compactification of the moduli space of marked vertical lines in \mathbb{C}^2 . *arXiv preprint arXiv:1910.02037*, 2019.
- [Bot17] Nathaniel Bottman. Moduli spaces of witch curves topologically realize the 2-associahedra. *arXiv preprint arXiv:1712.01194*, 2017.
- [Bot19a] Nathaniel Bottman. 2-associahedra. *Algebraic & Geometric Topology*, 19(2):743–806, 2019.
- [Bot19b] Nathaniel Bottman. Moduli spaces of witch curves topologically realize the 2-associahedra. *Journal of Symplectic Geometry*, 17(6):1649–1682, 2019.
- [Bot21] Nathaniel Bottman. A simplicial version of the 2-dimensional Fulton-MacPherson operad. *arXiv preprint arXiv:2101.03211*, 2021.
- [BP22] Nathaniel Bottman and Daria Poliakova. Constrainahedra. *arXiv preprint arXiv:2208.14529*, 2022.
- [BS92] Louis J. Billera and Bernd Sturmfels. Fiber polytopes. *Annals of Mathematics*, 135(3):527–549, 1992.
- [Buc08] Victor M. Buchstaber. Lectures on toric topology. In *Proc. of The Toric Topology Workshop, KAIST2008*, pages 1–64, 2008.
- [BW07] Weronika Buczynska and Jaroslaw A. Wisniewski. On the geometry of binary symmetric models of phylogenetic trees. *Journal of the European Mathematical Society*, 9(3):609–635, 2007.
- [CD06] Michael P. Carr and Satyan L. Devadoss. A generalization of manifolds with corners. *Topology Appl*, 299(12):2155–2168, 2006.
- [CFZ02] Frédéric Chapoton, Sergey V. Fomin, and Andrei V. Zelevinsky. Polytopal realizations of generalized associahedra. *Canadian Mathematical Bulletin*, 45(4):537–566, 2002.
- [CL15] Federico Castillo and Fu Liu. Ehrhart positivity for generalized permutohedra. *Discrete Mathematics & Theoretical Computer Science*, DMTCS Proceedings, 27th..., 01 2015.
- [CL22] Federico Castillo and Fu Liu. Deformation cones of nested braid fans. *Int. Math. Res. Not. IMRN*, pages 1973–2026, 2022.
- [CP22] Frédéric Chapoton and Vincent Pilaud. Shuffles of deformed permutahedra, multiplihedra, constrainahedra, and biassociahedra. *arXiv preprint arXiv:2201.06896*, 2022.
- [CPS19] Cesar Ceballos, Arnau Padrol, and Camilo Sarmiento. Geometry of ν -Tamari lattices in types A and B. *Transactions of the American Mathematical Society*, 371(4):2575–2622, 2019.
- [CSZ15] Cesar Ceballos, Francisco Santos, and Günter M. Ziegler. Many non-equivalent realizations of the associahedron. *Combinatorica*, 35(5):513–551, 2015.

- [DCP95] Corrado De Concini and Claudio Procesi. Wonderful models of subspace arrangements. *Selecta Mathematica*, 1:459–494, 1995.
- [DFLM21] David Damgaard, Livia Ferro, Tomasz Lukowski, and Robert Moerman. Momentum amplituhedron meets kinematic associahedron. *Journal of High Energy Physics*, 2021(2):1–25, 2021.
- [DFRS15] Satyan L. Devadoss, Stefan Forcey, Stephen Reisdorf, and Patrick Showers. Convex polytopes from nested posets. *European Journal of Combinatorics*, 43:229–248, 2015.
- [DJL21] Tobias Dyckerhoff, Gustavo Jasso, and Yankı Lekili. The symplectic geometry of higher Auslander algebras: Symmetric products of disks. In *Forum of Mathematics, Sigma*, volume 9, page e10. Cambridge University Press, 2021.
- [DK00] Vladimir I. Danilov and Gleb A. Koshevoy. Cores of cooperative games, superdifferentials of functions, and the Minkowski difference of sets. *Journal of Mathematical Analysis and Applications*, 247(1):1–14, 2000.
- [Dri88] Vladimir G. Drinfeld. Quantum groups. *Journal of Soviet Mathematics*, 41:898–915, 1988.
- [Dri89] Vladimir G. Drinfeld. Quasi-Hopf algebras and Knizhnik-Zamolodchikov equations. In *Problems of Modern Quantum Field Theory: Invited Lectures of the Spring School held in Alushta USSR, April 24–May 5, 1989*, pages 1–13. Springer, 1989.
- [DS23] Satyan L. Devadoss and Mia Smith. Colorful graph associahedra. *Journal of Combinatorics*, 14(3):369–398, 2023.
- [EDM70] J EDMONDS. Submodular functions, matroids, and certain polyhedra. In *Proc. Calgary Int. Conference on Combinatorial Structures and Their Applications, 1970*. Gordon and Breach, 1970.
- [Esc16] Laura Escobar. Brick manifolds and toric varieties of brick polytopes. *The Electronic Journal of Combinatorics*, 23(2):P2–25, 2016.
- [FH13] Georges Francois and Simon Hampe. Universal families of rational tropical curves. *Canadian Journal of Mathematics*, 65(1):120–148, 2013.
- [For08] Stefan Forcey. Convex hull realizations of the multiplihedra. *Topology Appl*, 156(2):326–347, 2008.
- [FS05] Eva Maria Feichtner and Bernd Sturmfels. Matroid polytopes, nested sets and Bergman fans. *Portugaliae Mathematica. Nova Série*, 62(4):437–468, 2005.
- [FZ03] Sergey V. Fomin and Andrei V. Zelevinsky. Y-systems and generalized associahedra. *Annals of Mathematics*, 158(3):977–1018, 2003.
- [Gal21] Pavel Galashin. P -associahedra. *arXiv preprint arXiv:2110.07257*, 2021.
- [Gel91] Israel M. Gelfand. Discriminants of polynomials in several variables and triangulations of Newton polyhedra. *Leningrad Math.*, 2:449–505, 1991.
- [GKZ94] Israel M. Gelfand, Mikhail M. Kapranov, and Andrei V. Zelevinsky. *Discriminants, resultants, and multidimensional determinants*. Mathematics: Theory & Applications. Birkhäuser Boston, Inc., Boston, MA, 1994.
- [Gol03] Jonathan S. Golan. *Semirings and affine equations over them: theory and applications*, volume 556 of *Mathematics and its Applications*. Kluwer Academic Publishers Group, Dordrecht, 2003.
- [GPW22] Pavel Galashin, Alexander Postnikov, and Lauren Williams. Higher secondary polytopes and regular plabic graphs. *Adv. Math.*, 407:Paper No. 108549, 52, 2022.
- [Gro18] Andreas Gross. Intersection theory on tropicalizations of toroidal embeddings. *Proceedings of the London Mathematical Society*, 116(6):1365–1405, 2018.
- [GS87] Israel M. Gelfand and Vera Serganova. Combinatorial geometries and torus strata on compact homogeneous spaces. *Uspekhi Mat. Nauk*, 42:107–134, 1987.
- [GT24] Michael Gekhtman and Hugh Thomas. Associahedra as moment polytopes. *arXiv preprint arXiv:2402.03437*, 2024.

- [GZK89] Israel M. Gelfand, Andrei V. Zelevinsky, and Mikhail M. Kapranov. Newton polyhedra of principal A -determinants. *Dokl. Akad. Nauk SSSR*, 308(1):20–23, 1989.
- [Hai84] Mark Haiman. Constructing the associahedron. www.math.berkeley.edu/~mhaiman/ftp/assoc/manuscript.pdf, 1984.
- [HL07] Christophe Hohlweg and Carsten Lange. Realizations of the associahedron and cyclohedron. *Discrete & Computational Geometry*, 37:517–543, 2007.
- [HLT11] Christophe Hohlweg, Carsten Lange, and Hugh Thomas. Permutohedra and generalized associahedra. *Advances in Mathematics*, 226(1):608–640, 2011.
- [HPPS21] Christian Haase, Andreas Paffenholz, Lindsey Piechnik, and Francisco Santos. *Existence of unimodular triangulations—positive results*. Memoirs of the American Mathematical Society, 2021.
- [HT78] Danièle Huguet and Dov Tamari. La structure polyédrale des complexes de paranthésages. *J. Combin. Inform. System Sci*, 3(2):69–81, 1978.
- [Hua24] Jingyin Huang. Cycles in spherical Deligne complexes and application to $K(\pi, 1)$ -conjecture for Artin groups. *arXiv preprint arXiv:2405.12068*, 2024.
- [Jon03] Jakob Jonsson. Generalized triangulations of the n -gon. *Unpublished manuscript*, 2003.
- [Joy16] Dominic Joyce. A generalization of manifolds with corners. *Advances in Mathematics*, 299:760–862, 2016.
- [Kap93] Mikhail M. Kapranov. The permutoassociahedron, Mac Lane’s coherence theorem and asymptotic zones for the KZ equation. *Journal of Pure and Applied Algebra*, 85(2):119–142, 1993.
- [Kat94] Kazuya Kato. Toric singularities. *American Journal of Mathematics*, 116(5):1073–1099, 1994.
- [KKMSD73] G Kempf, F Knudsen, D Mumford, and B Saint-Donat. Toroidal embeddings i. *Lect. Notes in Math vol. 339*, 1973.
- [Lee89] Carl W. Lee. The associahedron and triangulations of the n -gon. *European Journal of Combinatorics*, 10(6):551–560, 1989.
- [Lod04] Jean-Louis Loday. Realization of the Stasheff polytope. *Arch. Math. (Basel)*, 83(3):267–278, 2004.
- [LTV10] Pascal Lambrechts, Victor Turchin, and Ismar Volić. Associahedron, cyclohedron and permutohedron as compactifications of configuration spaces. *Bull. Belg. Math. Soc. Simon Stevin*, 17(2):303–332, 2010.
- [May72] J. Peter May. *The geometry of iterated loop spaces*, volume Vol. 271 of *Lecture Notes in Mathematics*. Springer-Verlag, Berlin-New York, 1972.
- [Mol21] Sam Molcho. Universal stacky semistable reduction. *Israel Journal of Mathematics*, 242:55–82, 2021.
- [MS06] Martin Markl and Steve Shnider. Associahedra, cellular W -construction and products of A_∞ -algebras. *Trans. Amer. Math. Soc.*, 358(6):2353–2372, 2006.
- [MS12] Dusa McDuff and Dietmar Salamon. *J-holomorphic curves and symplectic topology*, volume 52 of *American Mathematical Society Colloquium Publications*. American Mathematical Society, Providence, RI, second edition, 2012.
- [MTTV21] Naruki Masuda, Hugh Thomas, Andy Tonks, and Bruno Vallette. The diagonal of the associahedra. *Journal de l’École polytechnique—Mathématiques*, 8:121–146, 2021.
- [OT12] Steffen Oppermann and Hugh R. Thomas. Higher-dimensional cluster combinatorics and representation theory. *Journal of the European Mathematical Society*, 14(6):1679–1737, 2012.
- [Pay09] Sam Payne. Toric vector bundles, branched covers of fans, and the resolution property. *Journal of Algebraic Geometry*, 18(1):1–36, 2009.
- [Pil22] Vincent Pilaud. Pebble trees. *arXiv preprint arXiv:2205.06686*, 2022.
- [Pos09] Alexander Postnikov. Permutohedra, associahedra, and beyond. *International Mathematics Research Notices*, 2009(6):1026–1106, 2009.

HIGHER-CATEGORICAL ASSOCIAHEDRA

- [Pos18] Alexander Postnikov. Positive Grassmannian and polyhedral subdivisions. In *Proceedings of the International Congress of Mathematicians: Rio de Janeiro 2018*, pages 3181–3211. World Scientific, 2018.
- [PPP21] Yann Palu, Vincent Pilaud, and Pierre-Guy Plamondon. Non-kissing complexes and tau-tilting for gentle algebras. *Mem. Amer. Math. Soc.*, 274(1343):vii+110, 2021.
- [PPPP23] Arnau Padrol, Yann Palu, Vincent Pilaud, and Pierre-Guy Plamondon. Associahedra for finite-type cluster algebras and minimal relations between g-vectors. *Proceedings of the London Mathematical Society*, 127(3):513–588, 2023.
- [PRW08] Alex Postnikov, Victor Reiner, and Lauren Williams. Faces of generalized permutohedra. *Documenta Mathematica*, 13:207–273, 2008.
- [PS12] Vincent Pilaud and Francisco Santos. The brick polytope of a sorting network. *European Journal of Combinatorics*, 33(4):632–662, 2012.
- [PSZ23] Vincent Pilaud, Francisco Santos, and Günter M. Ziegler. Celebrating Loday’s associahedron. *Archiv der Mathematik*, 121(5):559–601, 2023.
- [Rea06] Nathan Reading. Cambrian lattices. *Advances in Mathematics*, 205(2):313–353, 2006.
- [RSS03] Günter Rote, Francisco Santos, and Ileana Streinu. Expansive motions and the polytope of pointed pseudo-triangulations. *Discrete and Computational Geometry: The Goodman-Pollack Festschrift*, pages 699–736, 2003.
- [RZ94] Victor Reiner and Günter M. Ziegler. Coxeter-associahedra. *Mathematika*, 41(2):364–393, 1994.
- [San04] Francisco Santos. Catalan many associahedra, lecture at the “Kolloquium über Kombinatorik (KolKom04)”. *Magdeburg, November*, 2004.
- [San23] Mario Sanchez. Derived categories of permutahedral and stellahedral varieties. *arXiv preprint arXiv:2311.04203*, 2023.
- [Sei08] Paul Seidel. *Fukaya categories and Picard-Lefschetz theory*. Zurich Lectures in Advanced Mathematics. European Mathematical Society (EMS), Zürich, 2008.
- [SS93] Steven Shnider and Shlomo Sternberg. Quantum groups: from coalgebras to Drinfeld algebras: a guided tour. (*No Title*), 1993.
- [SSW17] Francisco Santos, Christian Stump, and Volkmar Welker. Noncrossing sets and a Grassmann associahedron. In *Forum of Mathematics, Sigma*, volume 5, page e5. Cambridge University Press, 2017.
- [Sta63a] James D. Stasheff. Homotopy associativity of H-spaces. i. *Transactions of the American Mathematical Society*, 108(2):275–292, 1963.
- [Sta63b] James D. Stasheff. Homotopy associativity of H-spaces. ii. *Transactions of the American Mathematical Society*, 108(2):293–312, 1963.
- [Sta97] Jim Stasheff. From operads to ‘physically’ inspired theories. In *Operads: Proceedings of Renaissance Conferences: Proceedings of Renaissance Conferences*, volume 202, page 53. American Mathematical Soc., 1997.
- [Ste13] Salvatore Stella. Polyhedral models for generalized associahedra via Coxeter elements. *Journal of Algebraic Combinatorics*, 38:121–158, 2013.
- [Stu21] Eric Nathan Stucky. *Cyclic Actions in Combinatorial Invariant Theory*. PhD thesis, University of Minnesota, 2021.
- [Sul07] Seth Sullivant. Toric fiber products. *Journal of Algebra*, 316(2):560–577, 2007.
- [SW05] David Speyer and Lauren Williams. The tropical totally positive Grassmannian. *Journal of Algebraic Combinatorics*, 22:189–210, 2005.
- [Tie16] Patrick N. Tierney. Realizing the 2-associahedron. *HMC Senior Theses*, 77, 2016.
- [Uli17] Martin Ulirsch. Functorial tropicalization of logarithmic schemes: the case of constant coefficients. *Proceedings of the London Mathematical Society*, 114(6):1081–1113, 2017.
- [Zel06] Andrei Zelevinsky. Nested complexes and their polyhedral realizations. *Pure and Applied Mathematics Quarterly*, 2(3):655–671, 2006.