

Constraints on the fuzzy dark matter mass window from high-redshift observables

Hovav Lazare,^{1,*} Jordan Flitter,^{1,†} and Ely D. Kovetz^{1,‡}

¹*Department of Physics, Ben-Gurion University of the Negev, Be'er Sheva 84105, Israel*

We use a combination of high-redshift observables to extract the strongest constraints to date on the fraction of axion fuzzy dark matter (FDM) in the mass window $10^{-26} \text{ eV} \lesssim m_{\text{FDM}} \lesssim 10^{-23} \text{ eV}$. These observables include ultraviolet luminosity functions (UVLFs) at redshifts 4 – 10 measured by the Hubble Space Telescope, a constraint on the neutral hydrogen fraction from high-redshift quasar spectroscopy, the cosmic microwave background optical depth to reionization measurement from Planck and upper bounds on the 21cm power spectrum from HERA. In order to calculate these signals for FDM cosmology, we use the `21cmFirstCLASS` code to interface between `AxiCLASS` and `21cmFAST` and consistently account for the full cosmic history from recombination to reionization. To facilitate a full Bayesian likelihood analysis, we developed a machine-learning based pipeline, which is both accurate, and enables a swift statistical inference, orders of magnitude faster than a brute force approach. We find that FDM of mass $m_{\text{FDM}} = 10^{-23} \text{ eV}$ is bound to less than 16% of the total dark matter, where the constraints strengthen towards smaller masses, reaching down to 1% for $m_{\text{FDM}} = 10^{-26} \text{ eV}$, both at 95% confidence level. In addition, we forecast that a future detection of the 21cm power spectrum with HERA will lower the upper bound at $m_{\text{FDM}} = 10^{-23} \text{ eV}$ to $\lesssim 1\%$.

I. INTRODUCTION

While on large scales the behavior of dark matter (DM) is well understood, its small-scale characteristics remain a riddle. One of the most studied models with distinct small scale properties is that of ultra-light axions, also known as fuzzy dark matter (FDM) [1–31]. The particle mass landscape of FDM spans the range $10^{-27} \text{ eV} \lesssim m_{\text{FDM}} \lesssim 10^{-20} \text{ eV}$, for which the matching de-Broglie wavelengths reach Galactic scales. The quantum pressure exerted by a DM fluid made up of such tiny particles acts to suppress small scale fluctuations [8–12], where the smaller the mass, the stronger the suppression. This provides some of the theoretical appeal of this model, as it can help solve a number of issues that cast doubt on the cold DM model when its simulations were confronted with observations, such as the core-cusp problem, the missing satellites problem and the too-big-to-fail problem [32, 33] (although these have alternative explanations via selection effects, baryon feedback, etc.). Moreover, recent studies have shown that specific values of the FDM mass and fraction can potentially relax the H_0 [34] and S8 [35–37] tensions. Since the FDM feature of suppressing small-scale fluctuations has a major impact on structure formation, many studies have used cosmological and astrophysical observables to constrain the FDM mass m_{FDM} and fraction f_{FDM} parameter space.

Such observables include cosmic microwave background (CMB) and large scale structure (LSS) measurements from Planck [7, 36] and the Dark Energy Survey (DES) [38]; the Ly α -forest [39–42]; the high-redshift ultraviolet (UV) luminosity functions and the CMB optical depth to reionization [43–47]. The above limits, alongside the results of this work, are summarized in Fig. 1.

Importantly, our new constraints rule out a limited but significant mass range, $10^{-25} \text{ eV} \lesssim m_{\text{FDM}} \lesssim 10^{-23} \text{ eV}$, in which FDM was hitherto allowed to exist in significant portions. This specific region in the FDM parameter space is referred to below as the *FDM mass window* [48].

The signatures of FDM we investigate in this work are its effect on the UV luminosity functions (UVLFs), the Thomson scattering optical depth to reionization τ , the average neutral hydrogen fraction x_{HI} and the power spectrum of 21cm brightness temperature fluctuations from the cosmic dawn and reionization epochs. At present, the most dominant among these are the UVLFs.

While recent studies have shown that it should be possible to close the FDM window using future 21cm measurements [48, 55, 56] from the Hydrogen Epoch of Reionization Array (HERA) [57], current HERA measurements [58, 59] have only yielded upper bounds on the 21cm power spectrum in a limited range of redshifts z and wavenumbers k , and here we find that the constraining power those upper bounds have on FDM is not competitive with other current observations. Future detection of the 21cm power spectrum, however, will produce even stronger bounds than we derive here from UVLFs + τ + x_{HI} , as we demonstrate using mock data.

Constraints on FDM using past measurements of the UVLFs, the CMB optical depth and the neutral fraction were achieved to some extent in Refs. [43–45]. However, these studies used simulations and semi-analytic calculations to obtain the observables, an approach that hinders complete Bayesian statistical inference, due to the expensive computational time of the predicted signals.

Here we use updated Hubble Space Telescope (HST) observations of the UVLFs [60] and the Planck optical depth (relative to [43–45]), which enables us to probe smaller FDM fractions compared to Refs. [43–45]. In addition, we make use of a new machine-learning (ML) based pipeline we have developed that allows us to complete a statistical inference in just a few hours. In the traditional Bayesian markov-chain parameter-inference

* hovavl@post.bgu.ac.il

† yflitter@gmail.com

‡ kovetz@bgu.ac.il

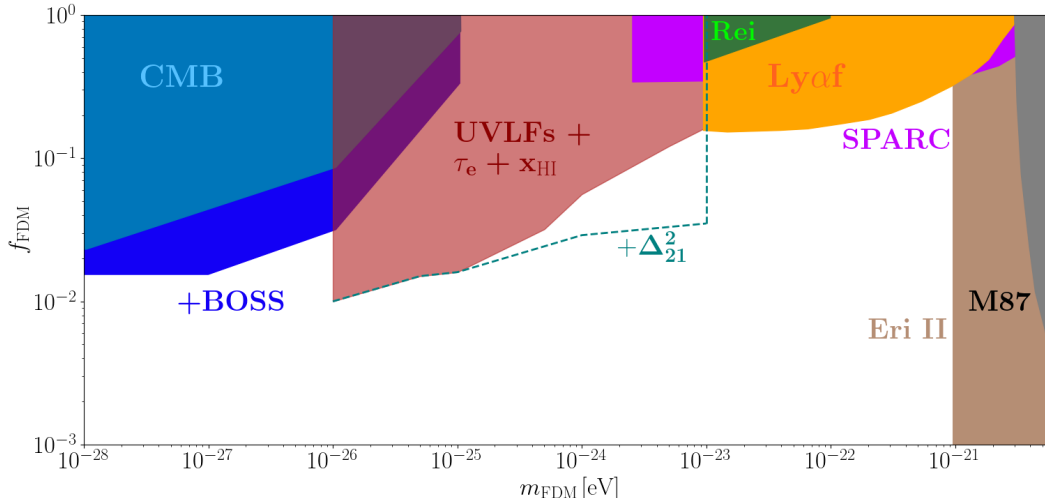

FIG. 1. Constraints on FDM from this study, achieved using UVLFs, the CMB optical depth τ , and the neutral hydrogen fraction x_{HI} at $z=5.9$. For comparison, we include constraints from previous studies. In blue, CMB bounds from Planck [7, 19], with LSS bounds from galaxy clustering combined with Planck (+BOSS) [36]. In orange, bounds from the Ly α -forest (Ly α f) [39–42]. In green, previous bounds from the UV luminosity function and optical depth to reionization (Rei.) [43]. In purple, bounds from galaxy rotation curves (SPARC) [49]. $f_{\text{FDM}} = 1$ is ruled out by DES for $10^{-25} \text{ eV} \lesssim m_{\text{FDM}} \lesssim 10^{-23} \text{ eV}$ [50]. In grey, bounds from the M87 black hole spin, derived from the non-observation of superradiance [51–53]. In brown, bounds from the half-light radius of the central star cluster in the dwarf galaxy Eridanus-II [54]. New constraints using UVLFs + τ + x_{HI} is shown in maroon, and the turquoise dashed line is a forecast for bounds that can be derived from future 21cm power spectrum observations. The last two are the main results of this work. All the bounds presented here are with 95% confidence level.

pipeline, realizations of the observables under examination are generated at each step, according to the likelihood of the former step. A consistent calculation of the 21cm signal, the neutral hydrogen fraction at the EoR, and the CMB optical depth to reionization, requires simulating the evolution of the Universe from the dark ages to the EoR [61–78], which can be computationally expensive (although estimates can be achieved using fast analytical prescriptions [75]). Such simulations can take $\mathcal{O}(1 \text{ hour})$ even for fast semi-numerical codes such as the public 21cmFAST [79] and 21cmFirstCLASS [48] codes.

Calculating the UVLFs at various redshifts can be done in $\mathcal{O}(1 \text{ sec})$ when assuming a Λ CDM cosmology, but when probing axion cosmology, the calculation of the matter transfer function has to be done for each set of cosmological+FDM parameters, which can take $\mathcal{O}(1 \text{ minute})$ when small scales ($k > 10 \text{ Mpc}$) are considered, using a Boltzmann solver such as AxiCLASS [19]. The consequences of sequentially generating realizations for the observables we examine via this method is that a traditional Markov Chain Monte Carlo (MCMC) inference can take a significant amount of time to converge.

For that reason we have developed a machine-learning (ML) based pipeline that can overcome this obstacle. ML techniques have emerged as powerful tools for emulating the EoR and cosmic dawn observables [80–88]. Training, validating and testing a ML model requires to precompute a large set of simulations, but once those are in hand it is possible to generate fast and accurate emulators that given a set of cosmological and astrophysi-

cal parameters can efficiently predict the observables the model was trained on. In this work we have generated a combined emulator for all of the above-mentioned observables, and used it to evaluate the constraints they can impose on FDM (and the FDM window in particular).

While we were finalizing a draft to summarize our results, Ref. [47] came out, where UVLFs were also used to derive bounds on FDM. In order to be able to directly compare and discuss the differences between our work and that of Ref. [47] (see Section V), we carefully revised our analysis to minimize the differences in the assumptions taken in both modeling and data selection. The consistency between our findings is encouraging given the very different analysis methods adopted. Using additional datasets, namely the neutral hydrogen fraction and the CMB optical depth, the constraints we derive here are stronger than those reported in Ref. [47].

Our paper is organized as follows. In Section II we describe the computation of the different observables used in this work, and demonstrate the impact of FDM on each of them. In Section III we describe the artificial neural network architecture our emulator is based on, explain how the training, validation and testing sets were built, and show the emulator performance for each of the outputs. Section IV describes the details of our Bayesian inference scheme, presents the bounds on FDM we derived using current UVLFs, τ_e and x_{HI} data, and conducts a forecast for constraints that can be achieved from future 21cm power spectra measurements. In Section V we discuss our results and compare them to other works.

II. COMPUTING AND SIMULATING THE OBSERVABLES

To probe FDM, we combine four separate observables: (i) the faint galaxy UVLFs from high redshifts, as measured by HST [60, 89]; (ii) the Planck [90] bound on the Thomson scattering optical depth of CMB photons, $\tau_e = 0.0569_{-0.0066}^{+0.0081}$, taken from Ref. [91]; (iii) the neutral hydrogen fraction measured by the dark (zero-flux) fraction in high redshift quasar spectra, $x_{\text{HI}} < 0.06 + 0.05 (1\sigma)$ at redshift $z = 5.9$ [92]; and (iv) the 21cm power spectrum measured by HERA [59]. In the following, we will explain how each of them is computed, given a set of astrophysical, cosmological and FDM parameters.

The computation is done using `21cmFirstCLASS` [48, 93], an extended version of `21cmFAST` that among other useful features, enables the user to compute all of the `21cmFAST` summary statistics, while consistently accounting for an exotic dark matter model such as FDM. `21cmFAST` is a semi-numerical simulation, that enables a relatively quick generation of cosmic dawn and EoR quantities such as the baryon and dark matter density fields; the gas, spin and 21cm brightness temperature fluctuations; the neutral hydrogen fraction; and the UVLFs at various redshifts. It can account for various radiation fields, heating mechanisms and galaxy populations when computing the intergalactic medium (IGM) evolution. In the case of FDM, `21cmFirstCLASS` computes the matter transfer function using `AxiCLASS` [19, 94], and then passes it on to `21cmFAST` to generate the initial conditions (more details can be found in Ref. [95]).

A. UV luminosity functions

The UVLF describes the comoving number density of galaxies per unit absolute magnitude, $\Phi_{\text{UV}} \equiv \frac{dn_{\text{gal}}}{dM_{\text{UV}}}$, where typically, the magnitude is measured at 1500 Å in the rest frame. Following Ref. [96], the UVLF can be decomposed into three quantities: (i) dn/dM_h , the halo mass function (HMF); (ii) f_{duty} , the galaxy duty cycle, which accounts for inefficient galaxy formation in small halos; and (iii) dM_h/dM_{UV} , the conversion from halo mass to magnitude. These then combine to give

$$\Phi_{\text{UV}} = f_{\text{duty}} \frac{dn}{dM_h} \frac{dM_h}{dM_{\text{UV}}}. \quad (1)$$

The UVLF in `21cmFAST` is calculated as a product of these three quantities, but here, following the approach presented in `GALLUMI` [97, 98], we account for the measured magnitude bin width ΔM_{UV} , and for scattering in the M_h to M_{UV} relation caused by the unique formation history of each galaxy. Accounting for these effects requires integrating over the magnitude bin size, and over a range of possible halo masses for each magnitude bin:

$$\Phi_{\text{UV}}(M_{\text{UV}}) = \frac{1}{\Delta M_{\text{UV}}} \int_0^\infty dM_h \times \left[\frac{dn_h}{dM_h} f_{\text{duty}}(M_h) \int_{M_{\text{UV}} - \frac{\Delta M_{\text{UV}}}{2}}^{M_{\text{UV}} + \frac{\Delta M_{\text{UV}}}{2}} dM'_{\text{UV}} P(M'_{\text{UV}}, M_h) \right]. \quad (2)$$

We now elaborate on the computation of each of the components that goes into Eq.(2): (i) In our calculations, we use the Sheth-Tormen HMF [99, 100]

$$\frac{dn}{dM_h} = \frac{\bar{\rho}_m}{M_h} \frac{d \ln \sigma_{M_h}^{-1}}{dM_h} f_{\text{ST}}(\sigma_{M_h}), \quad (3)$$

where σ_{M_h} is the standard deviation of the density field, smoothed over a mass scale M_h , $\bar{\rho}_m$ is the average matter energy density and the function $f_{\text{ST}}(\sigma_{M_h})$ is defined as

$$f_{\text{ST}}(\sigma_{M_h}) = A \sqrt{\frac{2a}{\pi}} \left[1 + \left(\frac{\sigma_{M_h}^2}{\delta_c^2} \right)^p \right] \frac{\delta_c}{\sigma_{M_h}} \exp \left(-\frac{a\delta_c^2}{2\sigma_{M_h}^2} \right), \quad (4)$$

where the values of the free parameters $A = 0.3222$, $a = 0.707$ and $p = 0.3$ were fit using numerical simulations, and $\delta_c = 1.686$ is the linear density field critical collapse threshold.

The effect of FDM on our model of the UVLFs enters through the computation of σ_{M_h} , which can be obtained by

$$\sigma_{M_h}^2(z) = \int \frac{d^3k}{(2\pi)^3} W_{M_h}^2(k) T_\zeta^2(k, z) P_\zeta(k), \quad (5)$$

where W_{M_h} is the Fourier transform of the spherical top hat filter, $T_\zeta(k, z)$ is the matter transfer function, obtained using `AxiCLASS` as we mentioned earlier, and $P_\zeta(k)$ is the primordial power spectrum. The matter transfer function depends on the values of the cosmological parameters, H_0 , Ω_m , Ω_b and the primordial power spectrum depends on A_s - the primordial fluctuations amplitude, and n_s - the primordial power index. We set all the parameters mentioned here, except Ω_b , as free parameters in our model, letting them vary within the 2σ bounds achieved by the Planck collaboration [90]. Ω_b is left out at this point since reducing the dimension of the parameter space improves the emulator accuracy (see section III), and Ω_b has the weakest imprint on the observables from all the cosmological parameters.

(ii) We model f_{duty} as an exponential cutoff at a turnover mass M_{turn} below which galaxy formation is suppressed by feedback mechanisms, or inefficient gas accretion [101–108],

$$f_{\text{duty}}(M_h) = \exp\left(-\frac{M_{\text{turn}}}{M_h}\right). \quad (6)$$

(iii) Finally, the probability density of the UV magnitude, $P(M_{\text{UV}}, M_{\text{h}})$, is modeled as a Gaussian distribution with width σ_{UV} and mean \overline{M}_{UV} . In order to evaluate $\overline{M}_{\text{UV}}(M_{\text{h}})$, we first note that the AB magnitude is related to the UV luminosity through [109],

$$\log_{10} \left(\frac{L_{\text{UV}}}{\text{erg s}^{-1}} \right) = 0.4 (51.63 - M_{\text{UV}}) . \quad (7)$$

The UV luminosity in turn is assumed to be proportional to the star formation rate (SFR) via the conversion factor $\kappa_{\text{UV}} = 1.15 \times 10^{-28} M_{\odot} \text{ s erg}^{-1} \text{ yr}^{-1}$ [110, 111] such that

$$\dot{M}_{*} = \kappa_{\text{UV}} L_{\text{UV}} . \quad (8)$$

The average SFR is modeled as the total stellar mass, $M_{*}(M_{\text{h}})$, divided by a characteristic time scale,

$$\dot{M}_{*}(M_{\text{h}}, z) = \frac{M_{*}(M_{\text{h}})}{t_{*} H(z)^{-1}} , \quad (9)$$

where $H(z)$ is the Hubble parameter, and the star formation timescale t_{*} is a model parameter that can take a value between 0 and 1. Following former works we set [58] $t_{*} = 0.5$.

For the total stellar mass, rather than using the default prescription in 21cmFAST, which is not designed to be computed at the bright end of the observed luminosity function (the stellar to halo mass ratio can reach unity for massive halos that populate the bright end), we modify the 21cmFAST code and implement instead the prescription introduced in GALLUMI [97, 98],

$$M_{*} = \frac{\epsilon_{*}}{\left(\frac{M_{\text{h}}}{M_{\text{p}}} \right)^{\alpha_{*}} + \left(\frac{M_{\text{h}}}{M_{\text{p}}} \right)^{\beta_{*}}} M_{\text{h}} , \quad (10)$$

where $\alpha_{*} > 0$, $\beta_{*} < 0$, and ϵ_{*} , M_{c} are redshift dependent amplitude and pivot mass respectively, with redshift pivoting at $z = 6$, $\log_{10} \epsilon_{*}(z) = \epsilon_{*}^{\text{i}} + \epsilon_{*}^{\text{s}} \times \log_{10} \left(\frac{1+z}{1+6} \right)$, $\log_{10} \frac{M_{\text{p}}(z)}{M_{\odot}} = M_{\text{p}}^{\text{i}} + M_{\text{p}}^{\text{s}} \times \log_{10} \left(\frac{1+z}{1+6} \right)$. The major difference between the 21cmFAST and GALLUMI parameterizations, is that GALLUMI's involves a double power law with different slopes for the bright and faint ends of the luminosity function. On the other hand the 21cmFAST model has a single power law and is thus restricted to a single slope for all masses. We will use our modified 21cmFAST prescription for all the calculations involving the SFR.

The effect of different values in the FDM parameter space on the UVLFs is demonstrated in Figs. 2, alongside the HST measurements. It is clear from this figure that the small scale suppression of FDM has a major effect on the UVLFs, and has the possibility to push it beyond the observed limits. The left panel indicates that at a fixed FDM mass, increasing the FDM fraction has a stronger effect on lower luminosities (higher magnitude). The right panel shows that decreasing the FDM mass for

fixed FDM fraction constant decreases the galaxy number density with stronger impact at high luminosity.

Before we proceed to execute the parameter inference, the UVLF HST measurements need to be modified by taking into account a few physical effects that can impact the relation between the physical UVLF and the measured one. All of the data corrections listed here are implemented in the same manner as in GALLUMI [97]:

(i) Cosmic variance - as the sky patches covered by HST at high redshifts are relatively small [112], the fluctuations in the matter density field can lead to a bias in the measured LF. To account for this, we impose a conservative minimal error of 20% on all the data points.

(ii) Dust attenuation - the UV flux of a galaxy can be absorbed by dust inhabiting the interstellar medium (ISM), while the outgoing emission from the dust is in the infrared. This effect can bias downwards the measured luminosity. Since dust accumulates mostly in massive galaxies, the impact is more dominant on the bright end of the LFs, at low redshifts. The dust extinction can be modeled using the IRX- β relation [113]; our implementation follows Ref. [97] (see there for further details).

(iii) Alcock-Paczynski effect - the definition of the luminosity function is the number of galaxies in a magnitude bin, divided by the survey volume, where some cosmological model and parameters are assumed when calculating the volume. This implies that when one varies the cosmological parameters, or differs from Λ CDM Cosmology, the data points and their errors should be reevaluated [114]. In our case, FDM does not affect the cosmological volume, but the variation of the cosmological parameters does affect the inference.

B. Neutral fraction and optical depth

The average Hydrogen neutral fraction, \bar{x}_{HI} , at redshifts 5 – 35, is one of the 21cmFAST summary statistics, and as such, it can also be obtained using 21cmFirstCLASS (at even higher redshifts). The simulated value of \bar{x}_{HI} is influenced by the SFR parameters, defined in Eq. 10, but also by the galaxies UV escape fraction, which is parameterized similarly to the original 21cmFAST stellar to halo mass ratio, as a power law

$$f_{\text{esc}}(M_{\text{h}}) = f_{\text{esc},10} \left(\frac{M_{\text{h}}}{10^{10} M_{\odot}} \right)^{\alpha_{\text{esc}}} , \quad (11)$$

where the normalization factor $f_{\text{esc},10}$ and the power law index α_{esc} are free parameters.

Following Ref. [115], we calculate the optical depth to reionization analytically, using the output from 21cmFirstCLASS: x_{HI} mentioned above, and the baryon density field δ_{b} . It is important to note that we do not use the simulation-averaged quantities, but the value at each simulated cell. Here, we skip some parts of the derivation and present the final form for the optical depth (for more details the reader is referred to, e.g., Refs. [115, 116]):

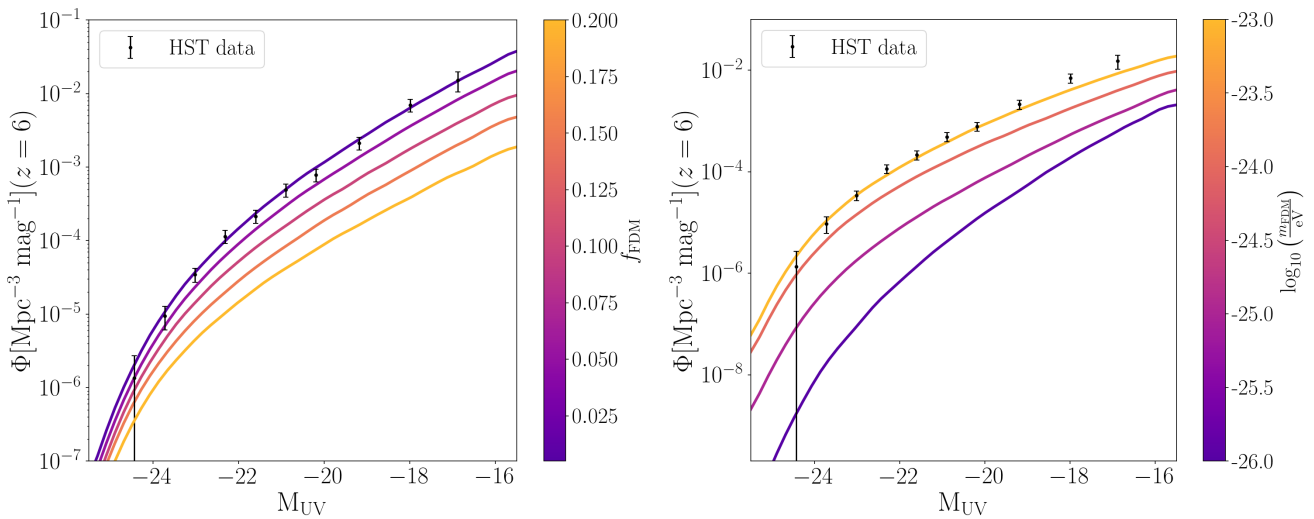

FIG. 2. The HST UVLFs at redshift $z = 6$. *Left*: Here we set $m_{\text{FDM}} = 10^{-24}\text{eV}$ and vary f_{FDM} , taking the median values for the UVLF model parameters from the MCMC posterior distribution shown further below. Increasing the FDM fraction decreases the UVLF amplitude, with a stronger effect on the faint end of the UVLF. *Right*: Here we set $f_{\text{FDM}} = 0.1$ and vary m_{FDM} . Decreasing the FDM mass decreases the UVLF amplitude, with a stronger effect on the bright end of the UVLF.

C. The 21cm power spectrum

$$\tau = \frac{3H_0\Omega_b\sigma_Tc}{8\pi Gm_p} \left[1 + \frac{Y_p^{\text{BBN}}}{4} \left(\frac{m_{\text{He}}}{m_{\text{H}}} - 1 \right) \right]^{-1} \times \int_0^{z_{\text{CMB}}} \frac{dz(1+z)^2}{\sqrt{\Omega_\Lambda + \Omega_m(1+z)^3}} x_{\text{HII}}(1+\delta_b) \quad (12)$$

where σ_T is the Thomson cross section, m_i is the i 'th species mass, $Y_p^{\text{BBN}} = n_{\text{He}}/n_b$ is the Helium fraction, and $x_{\text{HII}} = 1 - x_{\text{HI}}$ is the ionized fraction. Since 21cmFAST simulates the evolution of the IGM down to redshift $z = 5$, the integral in Eq. 12 cannot be evaluated directly for $z < 5$. In order to calculate it, we assume that at redshift $z = 5$ the universe is already completely ionized, which implies that $x_{\text{HII}}(1+\delta_b) \approx 1$. This is a reasonable assumption, since the neutral fraction is already constrained to be less than 0.11 at $z = 5.9$ [92], however, in rare scenarios, this calculation is somewhat inaccurate. Such a scenario can be caused for significant fraction of FDM with a very small mass, but this will not bias our inference, since the optical depth will already be too small to fit the Planck [90] CMB bounds on τ .

In Figs. 3,4 we demonstrate the implications of FDM on τ_e and x_{HI} . In a similar manner to the effects on the UVLFs, we see here that FDM has noticeable imprints on these observables, and can be constrained using them. The source of these imprints is the small scale suppression that FDM generates at early times. This suppression delays the formation of heavy DM halos, which in turn delays the formation of galaxies. The UV flux from those galaxies is responsible for the reionization of the IGM, which means that this delay can be measured using the neutral hydrogen fraction [92, 117], and with the optical depth to reionization.

Emission and absorption of the 21cm line in the IGM are characterized by the spin temperature, T_s , which models the population ratio between the two hyperfine states. It is usually measured as the differential brightness temperature, δT_{21} , with respect to the brightness temperature of the low-frequency radio background, T_{rad} . In the standard scenario, T_{rad} is taken to be the CMB temperature $T_{\text{cmb}} = 2.7254 \times (1+z)$ K. The differential brightness temperature, δT_{21} , is given by [118–120]

$$\delta T_{21}(\nu) = \frac{T_s - T_{\text{rad}}}{1+z} (1 - e^{-\tau_{\nu_0}}), \quad (13)$$

where $(1 - e^{-\tau_{\nu_0}})$ takes into account the effect of propagation through a medium, and τ_{ν_0} is the optical depth. Most of the astrophysical and cosmological information is captured in T_s , whereas the state of the medium is encoded in the optical depth τ_{ν_0} . Measurements of the 21cm signal include both the sky direction averaged signal $\langle \delta T_{21}(z) \rangle$, known as the global signal, and its fluctuations that can be interpreted in terms of statistics like the power spectrum, bispectrum, etc. Here, we work with the power spectrum defined as

$$\langle \delta \tilde{T}_{21}(\mathbf{k}_1) \delta \tilde{T}_{21}(\mathbf{k}_2) \rangle = (2\pi)^3 \delta^D(\mathbf{k}_1 - \mathbf{k}_2) P_{21}(\mathbf{k}_1), \quad (14)$$

where $\langle \dots \rangle$ denotes an ensemble average, $\delta \tilde{T}_{21}(\mathbf{k})$ is the Fourier transform of $\delta T_{21}(\mathbf{x})$ and δ^D is the Dirac delta function. Specifically, the quantity of interest for us is $\Delta_{21}^2(\mathbf{k}) \equiv k^3 P_{21}(\mathbf{k}) / (2\pi^2)$, which is the output of HERA [59] measurements. Needless to say, realizations of the 21cm global signal and spatial fluctuations can also be generated using 21cmFirstCLASS, where the SFR and escape fraction parameters affect the output signal.

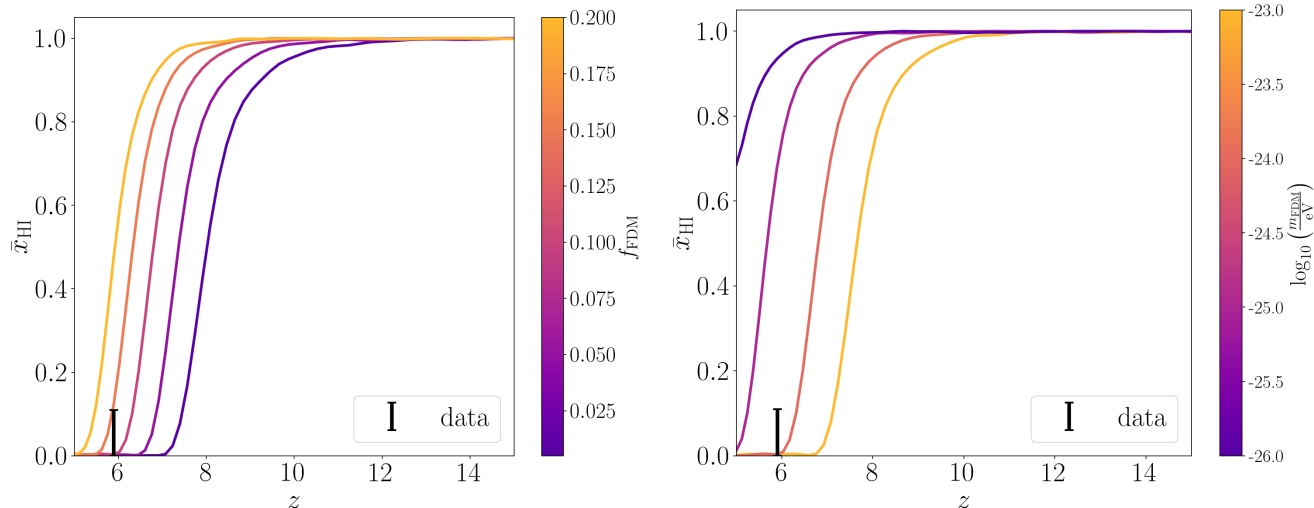

FIG. 3. The neutral hydrogen fraction redshift evolution when varying the FDM fraction or mass, calculated using our emulator. The datapoint is $x_{\text{HI}} < 0.11$ at $z = 5.9$ [92]. *Left:* Here we take $m_{\text{FDM}} = 10^{-24}$ eV and set the model parameters to their median values from the MCMC posterior distribution shown below. The effect of FDM is to delay structure formation which in turn translates into a delayed reionization. Large fractions delay reionization beyond the current limits. *Right:* Varying the mass, while fixing $f_{\text{FDM}} = 0.1$. We see that small masses delay reionization beyond known limits, even for small FDM fractions.

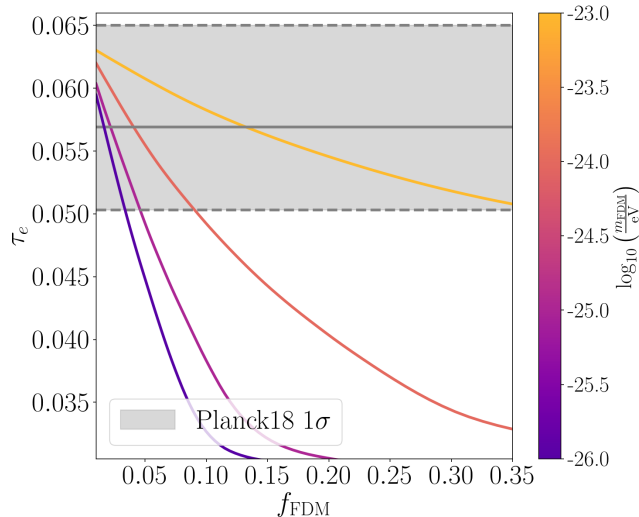

FIG. 4. The Thomson scattering optical depth to reionization when varying the FDM fraction, achieved using an emulator. The figure was obtained median parameters from the MCMC posterior distribution shown below. Here the effect of FDM is delaying structure formation which in turn translates into a delayed reionization, and a larger neutral hydrogen fraction at low redshifts. Eq. 12 implies that $\tau_e \propto 1 - x_{\text{HI}}$, which means that a larger a neutral fraction at low redshifts, will result in a decreasing optical depth.

As demonstrated in Ref. [48], the delay in structure formation that FDM incurs, will result in a delay in the 21cm signal. This delay is clearly demonstrated by the global signal as shown in Figs. 5. Since the global signal experiments [121–124] are not yet sensitive enough

to detect this effect, we can try to use the 21cm power spectrum measurement by HERA [59]. The results of this experiment are currently treated as upper bounds on the power spectra, since the systematic noise is not yet modeled reliably [58, 125]. The likelihood for the HERA upper bounds can be found in Refs [88, 125]. In practice, it turns out that the current upper bounds do not have any constraining power over the model parameters we use in this work, since all of them are already bound by the other observables. In section IV this will be demonstrated for a specific FDM mass. Future power spectrum detection by HERA should improve the constraints achieved in this work. In Section IV B this will be demonstrated using a mock observation of the power spectra, assuming a future HERA noise specification.

III. ARTIFICIAL NEURAL NETWORK (ANN)

Since the semi-numerical computation of τ_e , x_{HI} and $\Delta_{21}^2(k, z)$ requires running a complete 21cmFirstCLASS simulation, the computational time for each set of parameters, can take up to O(1 hour) even on a high performance computing environment (HPC). The traditional MCMC pipeline requires generating a large number of simulations in a sequential manner in order to construct the final posterior. This can result in a few weeks for each inference, and can be prohibitive, and not scalable. In order to address this problem, we turn to use the developing field of artificial neural networks (ANNs) to construct an EoR summaries emulator which we describe below. Our work here is based on our previous work presented in Ref. [88], and on the 21cm emulator 21cmEMU [87].

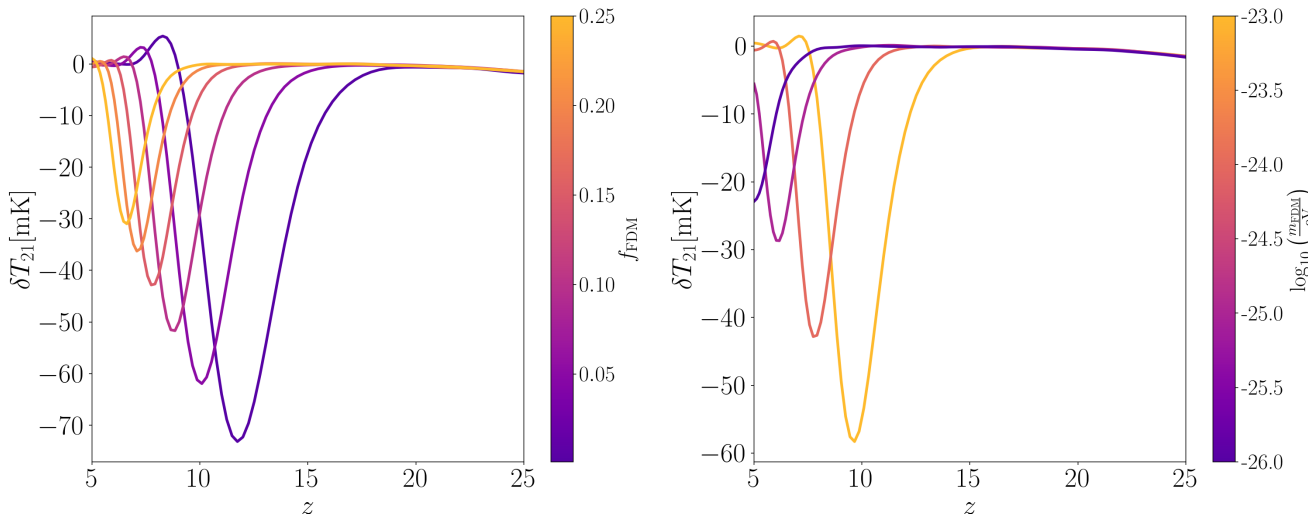

FIG. 5. The 21cm global signal redshift evolution when varying the FDM fraction (*Left*) or FDM mass (*Right*), calculated using our emulator. The delay of structure formation delays all the phases of the 21cm signal, from cosmic dawn to reionization. *Left*: Here we take $m_{\text{FDM}} = 10^{-24}$ eV and set the global signal parameters to their median values from the MCMC posterior distribution shown below. *Right*: Here we fix $f_{\text{FDM}} = 0.15$.

A. Building the dataset

In this section, we discuss the method of composing a dataset which will then be used to train and test our emulator. Training a reliable emulator in a high dimensional parameter space, can require a very large number of simulations. For that reason we set some of the model parameters to a constant value, determined by a prior MCMC run with UVLFs only, and without FDM. Such MCMC does not require an emulator since the realizations can be produced rapidly. The parameters we set to constants are: $\epsilon_*^s = 0.82$, $M_p^s = 2.37$ and $\sigma_{\text{UV}} = 0.45$. We also set Ω_b to the best-fit value from Planck [90].

The free parameters and their ranges are summarized in Table I. Next, we sample the parameter space using a Latin hypercube (LH) sampler which aims to produce uniform sampling when all points are marginalized onto any one dimension [126]. In this work, we are training our emulator, without varying the axion mass. This means that we have to train a separate emulator on a separate data set, for each axion mass. We examine 7 different values for the axion mass varying from 10^{-23} eV to 10^{-26} eV, and for each of them we generate ~ 10000 different parameter sets. Then, for each of the parameter sets obtained, we compute the luminosity functions, the neutral hydrogen fraction, the optical depth to reionization, and the 21cm global signal and power spectrum using 21cmFirstCLASS, and save them together. The UV luminosity function is then interpolated over 50 magnitude bins, ranging from -25.5 to -15.5 magnitudes. Finally, the samples are split into a training set (10%), validation set (10%) and testing set (80%). Before the training process begins, the parameter sets are normalized to lie in the range $[-1, 1]$, and we use the \log_{10} of the

corresponding UVLFs and 21cm power spectra to train the ANN, as former publications had suggested that this accelerates the learning process and increases accuracy.

B. ANN architecture

A schematic diagram of the emulator is shown in Fig. 6. The emulator is implemented using the TensorFlow [127] and Keras [128] libraries defined in PYTHON3. For all of the emulator outputs except the 21cm power spectra, we use fully connected (Dense) layers, where the number of layers and the number neurons in each layer are specified in Fig. 6. For the power spectrum, we exploit the power of convolutional neural networks (CNNs) [129, 130], and use convolution layers, together with transpose convolution layers, and up-sampling layers, that reshape the output until the required form is achieved. For each of the predicted observables, we use a mean squared error (MSE) loss function, to model the difference between the predictions for the Ground Truth (GT) data, and an exponential linear unit (ELU) [131] activation function, in order to insert non-linearity into the network. We have examined different conventional choices for the activation, such as ReLU [132], LeakyReLU, tanh and more, and concluded that ELU delivers the most accurate results. The training process is performed using mini batches of size 256 samples, so that the trainable parameters are updated using the gradients of the loss function, after forward propagating each batch. The training process was done using the Adam [133] optimizer, where the initial learning rate is 0.001, and is reduced by a factor of 2 when the prediction on the validation set does not improve over

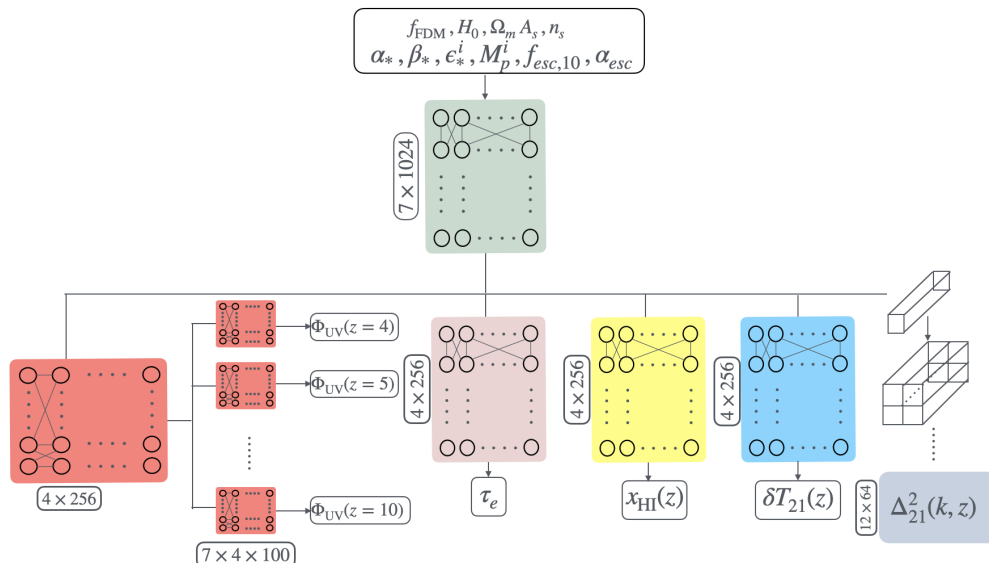

FIG. 6. A schematic diagram of the emulator architecture. The astrophysical and cosmological parameters are inserted to a large block of fully-connected layers. The output from this shared block is then passed on to four fully connected blocks, and one convolutional block for the 21cm power spectrum. The pink block predicts the Thomson scattering optical depth, the yellow block is responsible for the neutral fraction, the blue block is for the 21cm global signal, and the red block is a shared block for the luminosity functions. The output of the shared UVLF block is then passed on to seven smaller fully connected blocks, each predicts the luminosity function at a different redshift.

more than 5 epochs. The training phase ends when there is no improvement over more than 15 epochs, and the best weights are stored at that moment.

C. ANN performance

The emulator performance is tested on a 1000 sample test set, which was generated together with the training and validation samples. The metric we choose to examine is the fractional error (FE) defined for each emulator prediction as

$$\text{FE}(y_{\text{pred}}) = \frac{1}{N_{\text{bins}}} \sum_{n=1}^{N_{\text{bins}}} \frac{|y_{\text{true}}(n) - y_{\text{pred}}(n)|}{y_{\text{true}}(n)} \times 100, \quad (15)$$

where N_{bins} is the number of bins (redshift for x_{HI} magnitude for Φ_{UV} etc.) at which we measure the observable. It is important to note that the evaluation of the FE metric for x_{HI} and $\Delta_{21}^2(k, z)$ is not possible naively, since their value can go down to zero for some sets of parameters. For that reason, we force a lower bound on the GT values of the neutral fraction, $x_{\text{HI},\text{min}} = 10^{-3}$, and the 21cm power spectra, $\log_{10} \Delta_{21,\text{min}}^2 = 10^{-1} \text{mk}^2$.

In Fig. 7, the UVLF testing set errors statistics is presented. Our results are similar to the ones achieved in Ref [87] (see table 1 there) for the same order of magnitude dataset size. This result is reassuring since the dataset 21cmEMU [87] was trained on, was drawn from the MCMC posteriors of Ref. [59], and as such, most of the samples are centered in the same region of the parameter space. This makes the training process simpler since

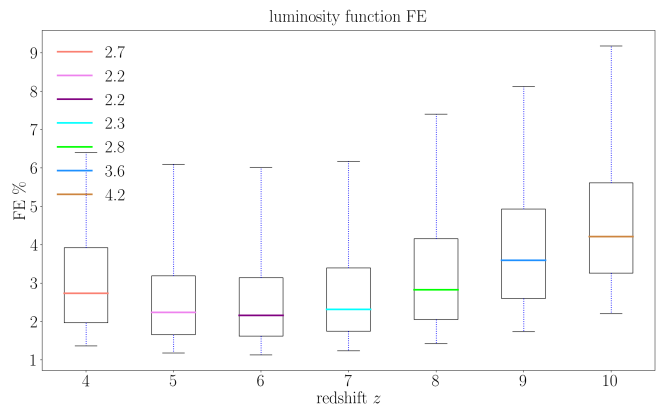

FIG. 7. UVLF accuracy statistics of the testing set, for $m_{\text{FDM}} = 10^{-24} \text{eV}$. The error is averaged over the magnitude bins. The boxes represents all the samples that fall between the 25th and the 75th FE percentile, and the line in the middle of it is the median. The UVLFs errors statistics of the other FDM masses examined here, distributes similarly.

most of the training samples look alike. This is not the case in our emulator, since the LH sampler draws samples evenly from all around the parameter space. This runs the risk of making the learning process difficult since the variation between different samples can be significant.

We note that 1σ uncertainty in the HST datapoints ranges from $\sim 20\%$ to $\sim 100\%$. This implies that an average emulator error of 2-3% will not affect the inference at all. Fig. 8 shows the same fractional error distributions for x_{HI} and τ_e . In a similar manner to the UVLFs,

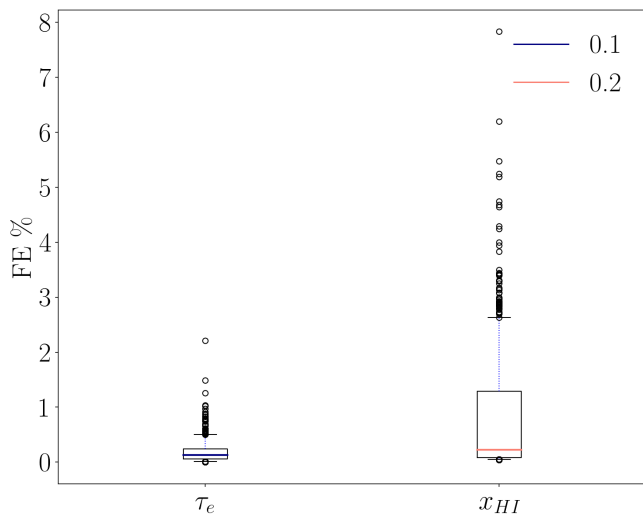

FIG. 8. x_{HI} and τ_e accuracy statistics of the testing set, for $m_{\text{FDM}} = 10^{-24}$ eV. The neutral fraction errors are averaged over redshift. The boxes represent all the samples that fall between the 25th and the 75th FE percentile, and the line in the middle of it is the median. The black circles are outliers that extend beyond the 95th percentile. The error statistics of the other FDM masses examined here, distributes similarly.

we conclude that the average errors for these observables is as least one order of magnitude smaller than the standard deviation values quoted in Section II, ensuring that those errors will not bias our inference results.

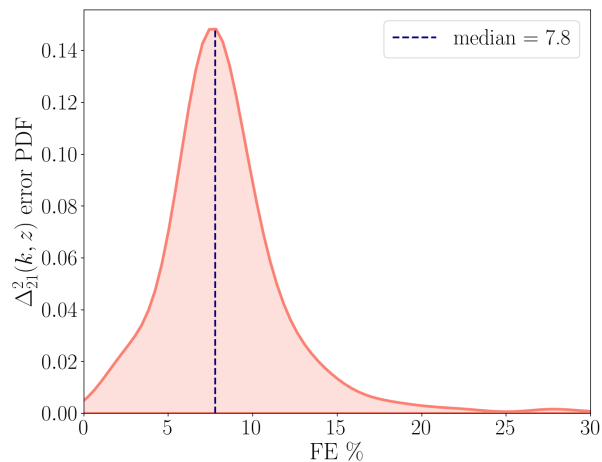

FIG. 9. The 21cm power spectrum emulator accuracy statistics of the testing set, averaged over wavenumber and redshift for $m_{\text{FDM}} = 10^{-23}$ eV. The error statistics of the other FDM masses we examined here have similar distributions.

The emulator errors for the 21cm power spectrum are shown in Fig. 9. Since the current measurements of the power spectrum yield only loose upper bounds, a median error of $\sim 8\%$ will not effect our current study. Future

experiments will probably deliver tighter bounds on the signal, which will require a more accurate emulator. This can be achieved, e.g., using resampling and retraining methods, as described in Ref. [88]. The 21cm global signal error are not presented here since we do not use them in our inference, but their median error does not exceed 1% for each of the FDM masses examined here. Overall, we conclude that our emulator errors are small enough for all the observables in this work, and so they will not compromise the parameter inference results.

IV. RESULTS

A. Bayesian inference

Our main goal in this Section is to perform a MCMC analysis for each of the FDM masses we consider using our emulator pipeline described in Section III, to set an upper bound on the FDM fraction for each mass. To compute the likelihood function we use a Gaussian likelihood for τ_e and the UVLFs, and a one-sided Gaussian for the neutral hydrogen fraction. For the 21cm power spectrum, we use the likelihood defined in Ref. [58], which treats the current datapoints as upper bounds.

Priors		
Parameter name	Lower bound	Upper bound
f_{FDM}	0.005	0.350
H_0	66.82	68.50
Ω_m	0.3000	0.3223
$10^{10} \ln A_s$	3.019	3.075
n_s	0.9589	0.9741
$\log_{10} f_{\text{esc},10}$	-3.0	0.0
α_{esc}	-1.0	1.0
α_*	0.1	1.0
β_*	-1.0	-0.1
c_*^i	-1.0	0
M_p^i	11.0	13.0

TABLE I. Prior range summary for all the astrophysical and cosmological parameters used in the MCMC runs.

The prior distributions for each of the cosmological and astrophysical parameters, which are summarized in Table I, are all taken to be flat. The priors ranges for the cosmological parameters, except f_{FDM} are taken to be the 2σ limits set by the Planck collaboration [90]. The MCMC part in our pipeline is implemented using the Python Emcee [134] sampler, and the corner plots for the posteriors are generated using the corner [135] package.

We first examine the constraints imposed by the different observables. The posteriors for f_{FDM} when using the observables separately and together for $m_{\text{FDM}} = 10^{-24}$ eV are presented in Fig. 10. We note that the UVLFs have most of the constraining power, and adding the other observables does not change the allowed values for f_{FDM} for this mass. The same result is obtained for other masses as well. This is reasonable, since UVLFs have many more data points than τ_e and x_{HI} which con-

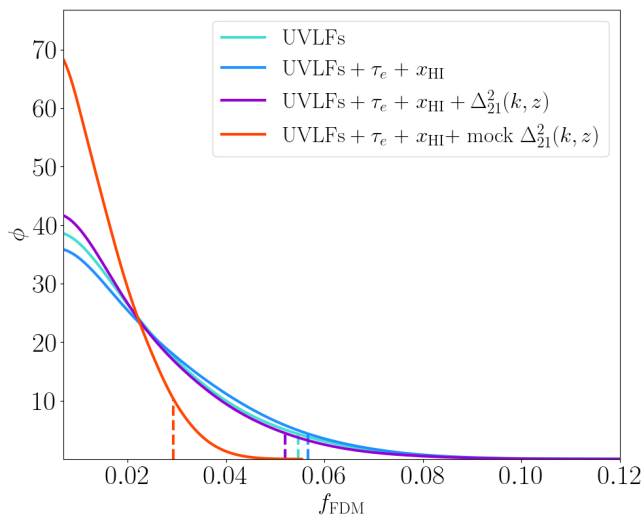

FIG. 10. Posterior distribution for f_{FDM} when using UVLFs separately or together with other observables, for $m_{\text{FDM}} = 10^{-24}$ eV. The dashed lines represent the 95% highest posterior density region. The red curve represents the posteriors when using mock data for the 21cm power spectrum as described in section IV B.

tribute only one data point each, and the bounds on $\Delta_{21}^2(k, z)$ are loose at the moment, and do not have much constraining power over the other observables, as was shown in Refs. [58, 88]. We can also see that with future 21cm measurements, as we elaborate on below, the bound on f_{FDM} in this mass range is expected to improve.

When using only τ_e and x_{HI} data, the constraints are 4 times weaker and the upper bound on the FDM fraction is 20%, which is an improvement from current constraints at $m_{\text{FDM}} = 10^{-24}$ eV. The reason for this weaker bound, besides the fact that this dataset contains only 2 points, is the degeneracy between the stellar to halo mass ratio ϵ_*^i , the escape fraction amplitude $f_{\text{esc},10}$ and f_{FDM} as shown in Fig. 11. The source of this degeneracy is the fact that reducing ϵ_*^i and increasing the FDM fraction both result in a smaller star formation rate density (SFRD) (see Ref. [136]), which decreases the number of sources that emit ionizing radiation into the IGM. This can be compensated by a larger ionizing escape fraction, which can be achieved by increasing $f_{\text{esc},10}$. This is reflected by a wider valid range for the FDM fraction. This degeneracy is broken when accounting for UVLFs, since ϵ_*^i is well constrained by the UVLFs, which leads to constraints on the escape fraction through τ_e and x_{HI} .

Fig. 12 shows the constraints achieved using all the observables in the mass-fraction parameter space examined in this work. These results, summarized in Table II, are a significant improvement over current bounds in this mass range (see comparison in Fig. 1). The main driver of these new limits are the UVLFs at redshifts $z = 4-10$.

As mentioned above, although the current 21cm power spectrum upper bounds have almost no influence on the derived constraints, results from ongoing and future ex-

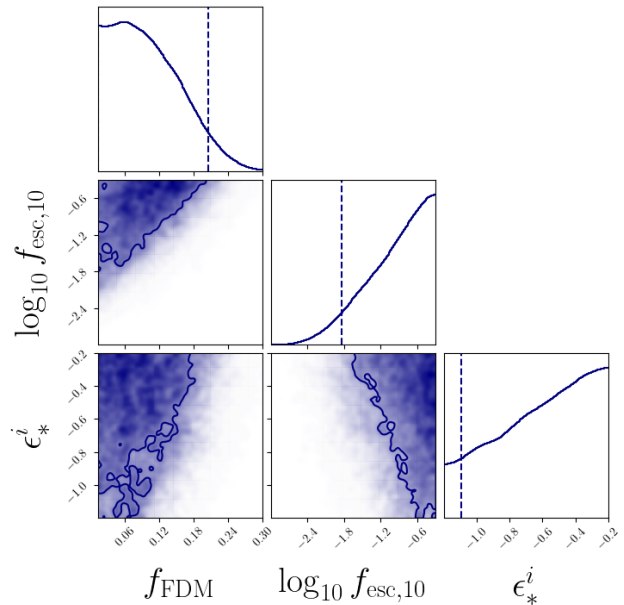

FIG. 11. Posteriors for $\{f_{\text{FDM}}, f_{\text{esc},10}, \epsilon_*^i\}$. The marginalized 2D posteriors show the degeneracy between the parameters. Dashed lines mark the 95% highest posterior density region.

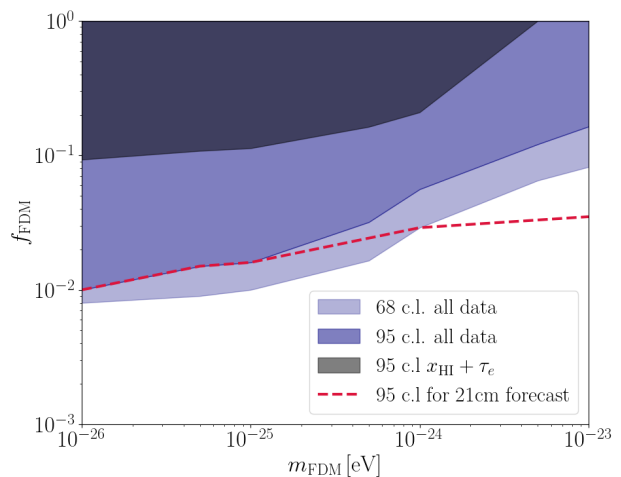

FIG. 12. Constraints from this work in the two dimensional FDM parameter space. The light and medium blue shaded regions match constraints with 95% confidence and 68% confidence levels. The darkest shade corresponds to our constraints using only x_{HI} and τ_e . The red solid line is our forecast for constraints that can be achieved via a future 21cm power spectrum detection with HERA (see text for details). A future HERA observation can help reduce the upper bound on the FDM fraction for $m_{\text{FDM}} = 10^{-23}$ eV from $\sim 15\%$ to $\sim 3\%$.

periments aiming to detect it, can improve the limits we presented here. In the following we conduct a forecast for the limits that can be achieved using those experiments.

m_{FDM} [eV]	68% c.l.	95% c.l.
10^{-23}	0.082	0.164
$5 \cdot 10^{-24}$	0.070	0.141
10^{-24}	0.0288	0.056
$5 \cdot 10^{-25}$	0.016	0.030
10^{-25}	0.010	0.016
$5 \cdot 10^{-26}$	0.009	0.015
10^{-26}	0.008	0.010

TABLE II. New constraints on FDM for different mass values with 68% and 95% confidence level.

B. Future bounds using a HERA forecast

In the following we forecast limits on the FDM fraction that could be achieved using a future HERA detection of the 21cm power spectra. We should mention that additional observations beyond those used to derive the upper bounds above were already conducted in HERA sixth season (2022-2023) [87], but are not available publicly so far. This observation spans a wider frequency range, and expands the coverage to cosmic dawn redshifts. Future experiments will use the full HERA survey design, which has 330 antennas that will observe the sky for ~ 540 nights. Here we generate a mock observation for HERA, using our 21cmFirstCLASS simulation, with an initial parameter set that is taken to be the median of the MCMC posteriors for the run shown in Section IV A.

In order to generate noise for our mock observation, we use 21cmSense [137], a Python open source repository that forecasts the noise given the antennae configuration and the signal, for the HERA experiment.

With the goal of demonstrating the power of 21cm detections to constrain FDM in mind, we choose to use only 3 wavenumber bins (0.16 Mpc^{-1} , 0.32 Mpc^{-1} , 0.48 Mpc^{-1}) as measured signals, and to adopt conservative assumptions for the experimental configuration and observation time. We assume that the experiment has only 216 functioning antennae that observed the sky for 100 nights, 6 hours per night. The noise for such a configuration is expected to be smaller than in HERA's sixth season, but larger than full HERA.

For this pipeline, we use the τ_e , x_{HI} and UVLFs likelihoods as was done so far, but we alter the 21cm power spectra treatment. The likelihood for the mock data no longer treats the 21cm measurements as upper bounds, and is now defined as a Gaussian likelihood. Our emulator predictions can contain a few percentage error, as noted in Fig. 9, that can have some impact on the inferred constraints. But since this part of our work is merely a forecast, we ignore these errors, and leave the goal of generating a more accurate emulator to future work.

Fig. 12 shows the forecast constraints on the FDM fraction for all the masses when using the 21cm power spectrum likelihood (red curve). This result implies that future 21cm observations have the ability to further constrain the FDM parameter space, beyond what

we achieved with UVLFs, x_{HI} and τ_e , at least for respectively high FDM mass. The constraints forecast for a detected 21cm power spectrum do not feature the same FDM mass dependence as the other observables. The reason that bounds on the FDM fraction do not scale strongly with mass for the 21cm power spectrum, is that the halos that govern the behavior 21cm signal are smaller than the ones that dominate the UVLFs used here. These halos are already affected by FDM with particle masses as low as $\sim 10^{-23}$ eV. This is not the case for UVLFs, as the halos that control the bright end become more sensitive to lighter axions. This behavior of the fraction limits was already predicted in the study of Ref. [95], based on a simple Fisher analysis.

V. CONCLUSIONS

This work presents a machine learning based pipeline for emulating the outputs of 21cmFirstCLASS, that can account a presence of ultra light axions. This pipeline includes a modified version of the SFR, based on the prescription introduced in GALLUMI [97, 98]. This emulator achieves accurate results for the UVLFs, the optical depth to reionization and the neutral hydrogen fraction, and its errors are at least an order of magnitude smaller than the standard deviations of the measurements. The error for the 21cm power spectra are $\sim 10\%$ which does not affect the inference when using the currently available measurements. Future and on-going experiments will have the ability to reduce the noise and deliver tighter bounds on the power spectra, and so may require a more accurate emulator. This can be achieved using retraining methods, as was demonstrated in Ref. [88] and Ref. [138].

We used our emulator together with measurements for UVLFs [60, 89], the CMB optical depth [90], the neutral hydrogen fraction [92] and the 21cm power spectrum [59] and performed an MCMC inference with the objective of constraining the FDM fraction for a given axion mass. Figs. 2–5 present the impact of FDM on all the observables used here and demonstrate their power to limit the FDM fraction. The result of this inference is the strongest bounds to date on axion DM in the FDM mass window, limiting its fraction to less than 16% for $m_{\text{FDM}} = 10^{-23}$ eV, and less than 1% for $m_{\text{FDM}} = 10^{-26}$ eV with 95% confidence level, as shown in Table II. This bound shrinks the available regions in the FDM parameter space and help direct the study of this model to its plausible areas. Finally, we conduct a forecast for the bounds that can be achieved with a future detection from 21cm power spectra experiments such as HERA. We find that such observations can reduce the bound on f_{FDM} by a noticeable amount, for relatively heavier axions, while the lower mass range would be still dominated by the UVLFs.

During the final steps of this work, we encountered Ref. [47] that reached similar conclusions regarding constraints on the FDM parameter space. The main observ-

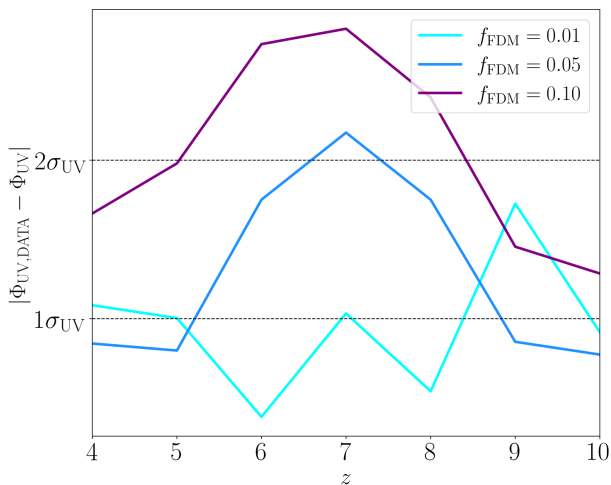

FIG. 13. The discrepancy between the data and the best fit model with varying f_{FDM} , per z , averaged over the magnitude bins, for $m_{\text{FDM}} = 10^{-24}$ eV. The difference is presented in units of the standard deviation of the HST measurements.

ables used in Ref. [47] are the CMB temperature power spectrum and the HST UV luminosity functions. Here we do not use the CMB temperature power spectrum likelihood, but the prior range of the cosmological parameters is taken to be the 2σ limits from Planck [90], which has similar impact. In both inferences the main driver of the constraints are the UVLFs. A significant difference between the studies is that we use an emulator instead of the direct approach used in Ref. [47]. The emulator pipeline can introduce small accuracy errors to the inference, but those are shadowed by the advantages of this method. First, the ANN-based MCMC is significantly accelerated with respect to a computation-based one. This makes our pipeline robust, and drastically simplifies accounting for different, more complicated cosmological models. Furthermore, it enables to take into account in greater detail the observables affected by astrophysics, such as the 21cm power spectrum, the optical depth to reionization and the neutral hydrogen fraction. This is important since those are impacted by the SFR, which is also constrained by the UVLFs. It is crucial to check that the SFR model and parameters that fit the HST UVLFs, do not contradict the other observations, and this can be done easily using an emulator-based MCMC. Our work also forecasts bounds that can be derived using future detections of the 21cm signal, e.g. by HERA. This is possible thanks to the emulator-based approach, since a direct computation of the 21cm power spectrum can take up to $\mathcal{O}(1 \text{ hour})$, which leads to weeks-to-months-long runtime for MCMC analyses. Ref. [47] also examined the impact of UVLFs from JWST. It showed that JWST detections are not yet significant enough to overcome the constraining power of HST. Another difference between our work and Ref. [47], is that we chose to set a constant value for some of the astrophysical parameters varied in Ref. [47]. The reason for that is that training an emu-

lator on a high-dimensional parameter space requires a large amount of training samples, and each added parameter contributes exponentially to the number of samples needed for an adequate accuracy. The parameters we decided to keep constant (see Section III) have the smallest impact on the luminosity function form, and their influence can be partially compensated by other parameters. Nevertheless this can source some of the differences between our results and that of Ref. [47] (see Appendix A).

Overall, our results and those published in Ref. [47] agree that FDM is strongly constrained by the HST UVLFs, although there is some difference in the allowed fraction of FDM for each axion mass. Fig. 13 shows the discrepancy between the data and our best fit model, with different values of FDM fraction averaged over M_{UV} , for $m_{\text{FDM}} = 10^{-24}$ eV. While considering this plot, one must take into account that at redshifts $z = 9, 10$, there are much fewer datapoints than in the later redshifts. With this in mind, one can intuit why our inference prohibits $f_{\text{FDM}} \gtrsim 0.05$ for $m_{\text{FDM}} = 10^{-24}$ eV. While for $z = 4, 5$, $f_{\text{FDM}} = 0.05$ is slightly more likely, for $z = 6, 7, 8$ the difference between the models fit to the data exceeds 1σ . This will result in a strong favoring of smaller FDM fractions, which provides a visual justification for the results presented in Table II, and further validates our pipeline and conclusions. Based on our findings, it seems safe to conclude that FDM cannot make up more than $\sim 10\%$ of DM for any axion mass smaller than 10^{-23} eV.

Lastly, in Fig. 14 we plot our final constraints alongside the preferred region found in a joint analysis of CMB and Ly α -forest measurements using data from the Extended Baryon Oscillation Spectroscopic Survey (eBOSS [139]), which found that a non-zero fraction of axion FDM in the 10^{-26} eV $\lesssim m_{\text{FDM}} \lesssim 10^{-23}$ eV mass window can ameliorate the S8 tension (see Ref. [140]). Most of this region remains allowed by our limits. Future UVLF and 21cm data should allow to fully test this hypothesis.

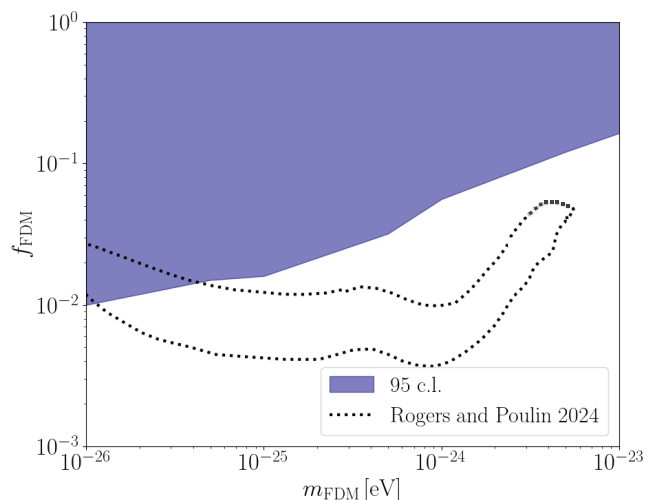

FIG. 14. 95% c.l. constraints from this work alongside the highest preference region for axion FDM reported in Ref. [140], which used Planck CMB and eBOSS Ly α -forest data. Our constraints start to push into this preferred region.

ACKNOWLEDGMENTS

The authors wish to thank Daniela Breitman and Sarah Libanore for useful discussions. JF is supported by a Negev PhD Fellowship from Ben-Gurion University. EDK acknowledges joint support from the U.S.-Israel Binational Science Foundation (BSF, grant No. 2022743) and the U.S. National Science Foundation (NSF, grant No. 2307354), and support from the ISF-NSFC joint research program (grant No. 3156/23).

Appendix A: MCMC posteriors

Here for completion we present the posterior distribution of the inference described in Section IV A, for all the astrophysical and cosmological parameters. Fig. 16 shows the posterior distribution for $m_{\text{FDM}} = 10^{-23}$ eV with all the observables together. We note that most of the astrophysical parameters are well constrained by the UVLFs and by τ_e , x_{HI} .

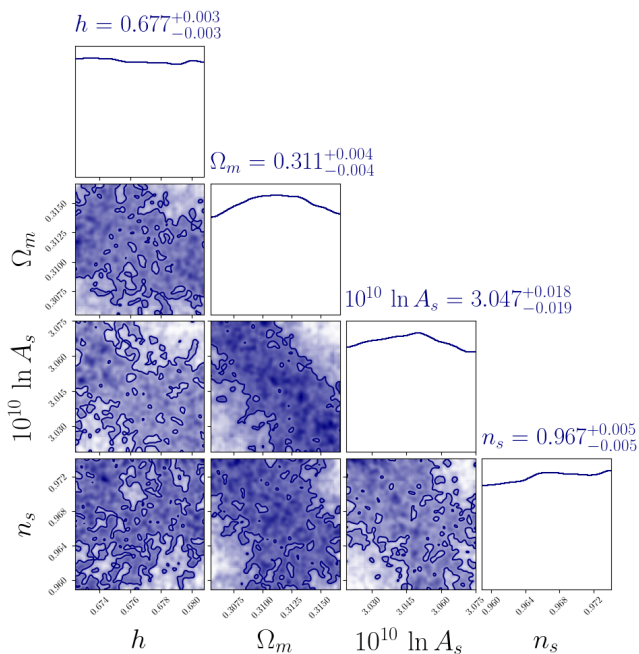

FIG. 15. Posterior distribution of the cosmological parameters when not accounting for the Alcock-Paczynski effect, for $m_{\text{FDM}} = 10^{-23}$ eV. All the posterior features of these parameters vanish when this effect is not considered. The posteriors for all the other parameters remain the same.

The cosmological parameters exhibit some non-trivial behavior, as smaller or larger values are slightly preferred depending on the parameter. As shown in Fig. 15. This behavior does not occur when the Alcock-Paczynski effect is not taken into account. The Hubble parameter h and dark matter energy density Ω_m are free parameters that impact the data correction this effect generates (see

Ref. [97]), so naturally they experience some constraining power when it is considered. The amplitude A_s and spectral index n_s of primordial fluctuations are degenerate with h and Ω_m through the luminosity function, so a weak preference of some values of the former, results in a similar effect on the latter. We do not treat these as new constraints, as they are not prominent enough to rule out certain values. In addition, the high likelihood combinations must be considered against the CMB power spectrum likelihood, as some of them might be ruled out. This fact does not impair the derived constraints on FDM, as exploring a wider parameter space in principle can only lower the bounds.

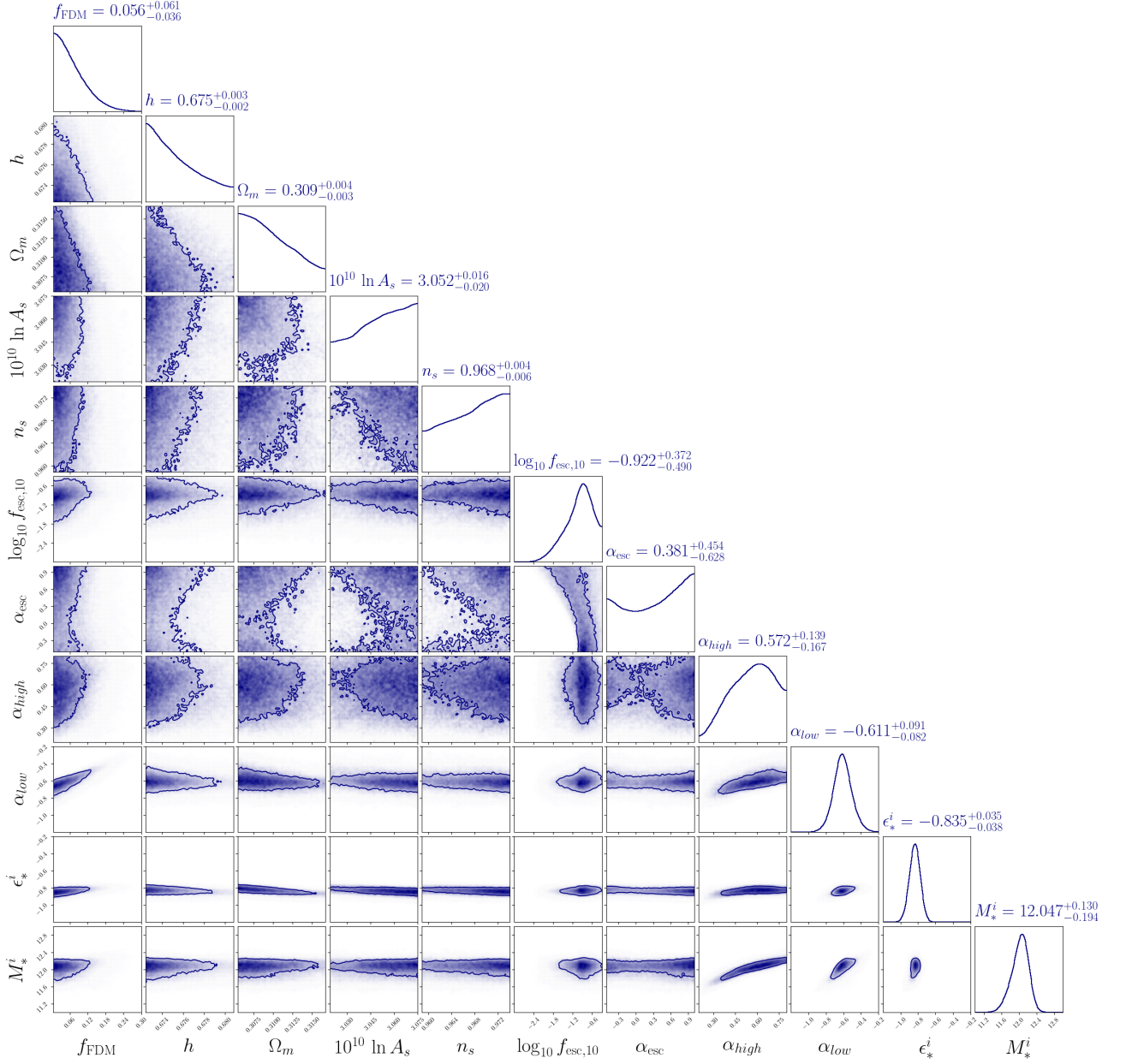

FIG. 16. Posterior distribution for all the model initial parameters, both cosmological and astrophysical, for $m_{\text{FDM}} = 10^{-23} \text{eV}$.

- [1] J. Preskill, M. B. Wise and F. Wilczek, “Cosmology of the Invisible Axion,” *Phys. Lett. B* **120**, 127-132 (1983)
- [2] L. F. Abbott and P. Sikivie, “A Cosmological Bound on the Invisible Axion,” *Phys. Lett. B* **120**, 133-136 (1983)
- [3] M. Dine and W. Fischler, “The Not So Harmless Axion,” *Phys. Lett. B* **120**, 137-141 (1983)
- [4] M. Y. Khlopov, B. A. Malomed, I. B. Zeldovich and Y. B. Zeldovich, “Gravitational instability of scalar fields and formation of primordial black holes,” *Mon. Not. Roy. Astron. Soc.* **215**, no.4, 575-589 (1985)
- [5] P. H. Chavanis, “Mass-radius relation of Newtonian self-gravitating Bose-Einstein condensates with short-range interactions: I. Analytical results,” *Phys. Rev. D* **84**, 043531 (2011) [arXiv:1103.2050 [astro-ph.CO]].
- [6] M. Kawasaki and K. Nakayama, “Axions: Theory and Cosmological Role,” *Ann. Rev. Nucl. Part. Sci.* **63**, 69-95 (2013) [arXiv:1301.1123 [hep-ph]].
- [7] R. Hlozek, D. Grin, D. J. E. Marsh and P. G. Ferreira, “A search for ultralight axions using precision cosmological data,” *Phys. Rev. D* **91**, no.10, 103512 (2015) [arXiv:1410.2896 [astro-ph.CO]].
- [8] D. J. E. Marsh, “Axion Cosmology,” *Phys. Rept.* **643**, 1-79 (2016) [arXiv:1510.07633 [astro-ph.CO]].
- [9] D. J. E. Marsh, “Nonlinear hydrodynamics of axion dark matter: Relative velocity effects and quantum forces,” *Phys. Rev. D* **91**, no.12, 123520 (2015) [arXiv:1504.00308 [astro-ph.CO]].
- [10] J. C. Niemeyer, “Small-scale structure of fuzzy and axion-like dark matter,” [arXiv:1912.07064 [astro-ph.CO]].
- [11] E. G. M. Ferreira, “Ultra-light dark matter,” *Astron. Astrophys. Rev.* **29**, no.1, 7 (2021) [arXiv:2005.03254 [astro-ph.CO]].
- [12] L. Hui, “Wave Dark Matter,” *Ann. Rev. Astron. Astrophys.* **59**, 247-289 (2021) [arXiv:2101.11735 [astro-ph.CO]].
- [13] L. Hui, J. P. Ostriker, S. Tremaine and E. Witten, “Ultralight scalars as cosmological dark matter,” *Phys. Rev. D* **95**, no.4, 043541 (2017) [arXiv:1610.08297 [astro-ph.CO]].
- [14] D. J. E. Marsh, “WarmAndFuzzy: the halo model beyond CDM,” [arXiv:1605.05973 [astro-ph.CO]].
- [15] V. Desjacques, A. Kehagias and A. Riotto, “Impact of ultralight axion self-interactions on the large scale structure of the Universe,” *Phys. Rev. D* **97**, no.2, 023529 (2018) [arXiv:1709.07946 [astro-ph.CO]].
- [16] R. Hlozek, D. J. E. Marsh and D. Grin, “Using the Full Power of the Cosmic Microwave Background to Probe Axion Dark Matter,” *Mon. Not. Roy. Astron. Soc.* **476**, no.3, 3063-3085 (2018) [arXiv:1708.05681 [astro-ph.CO]].
- [17] S. Fraser, A. Hektor, G. Hütsi, K. Kannike, C. Marzo, L. Marzola, C. Spethmann, A. Racioppi, M. Raidal and V. Vaskonen, *et al.* “The EDGES 21 cm Anomaly and Properties of Dark Matter,” *Phys. Lett. B* **785**, 159-164 (2018) [arXiv:1803.03245 [hep-ph]].
- [18] A. Lidz and L. Hui, “Implications of a preionization 21-cm absorption signal for fuzzy dark matter,” *Phys. Rev. D* **98**, no.2, 023011 (2018) [arXiv:1805.01253 [astro-ph.CO]].
- [19] V. Poulin, T. L. Smith, D. Grin, T. Karwal and M. Kamionkowski, “Cosmological implications of ultralight axionlike fields,” *Phys. Rev. D* **98**, no.8, 083525 (2018) [arXiv:1806.10608 [astro-ph.CO]].
- [20] W. Yang, S. Pan, S. Vagnozzi, E. Di Valentino, D. F. Mota and S. Capozziello, “Dawn of the dark: unified dark sectors and the EDGES Cosmic Dawn 21-cm signal,” *JCAP* **11**, 044 (2019) [arXiv:1907.05344 [astro-ph.CO]].
- [21] J. B. Bauer, D. J. E. Marsh, R. Hlozek, H. Padmanabhan and A. Laguë, “Intensity Mapping as a Probe of Axion Dark Matter,” *Mon. Not. Roy. Astron. Soc.* **500**, no.3, 3162-3177 (2020) [arXiv:2003.09655 [astro-ph.CO]].
- [22] M. Kawasaki, W. Nakano, H. Nakatsuka and E. Sonomoto, “Probing Oscillons of Ultra-Light Axion-like Particle by 21cm Forest,” [arXiv:2010.13504 [astro-ph.CO]].
- [23] K. Schutz, “Subhalo mass function and ultralight bosonic dark matter,” *Phys. Rev. D* **101**, no.12, 123026 (2020) [arXiv:2001.05503 [astro-ph.CO]].
- [24] C. G. Sabiu, K. Kadota, J. Asorey and I. Park, “Probing ultra-light axion dark matter from 21 cm tomography using Convolutional Neural Networks,” *JCAP* **01**, no.01, 020 (2022) [arXiv:2108.07972 [astro-ph.CO]].
- [25] G. S. Farren, D. Grin, A. H. Jaffe, R. Hlozek and D. J. E. Marsh, “Ultralight axions and the kinetic Sunyaev-Zel’dovich effect,” *Phys. Rev. D* **105**, no.6, 063513 (2022) [arXiv:2109.13268 [astro-ph.CO]].
- [26] D. J. E. Marsh and S. Hoof, “Astrophysical Searches and Constraints,” [arXiv:2106.08797 [hep-ph]].
- [27] M. Kawasaki, K. Miyazaki, K. Murai, H. Nakatsuka and E. Sonomoto, “Anisotropies in cosmological 21 cm background by oscillons/I-balls of ultra-light axion-like particle,” *JCAP* **08**, 066 (2022) [arXiv:2112.10464 [astro-ph.CO]].
- [28] F. Chadha-Day, J. Ellis and D. J. E. Marsh, “Axion dark matter: What is it and why now?,” *Sci. Adv.* **8**, no.8, abj3618 (2022) [arXiv:2105.01406 [hep-ph]].
- [29] K. K. Boddy, M. Lisanti, S. D. McDermott, N. L. Rodd, C. Weniger, Y. Ali-Haïmoud, M. Buschmann, I. Cholis, D. Croon and A. L. Erickcek, *et al.* “Snowmass2021 theory frontier white paper: Astrophysical and cosmological probes of dark matter,” *JHEAp* **35**, 112-138 (2022) [arXiv:2203.06380 [hep-ph]].
- [30] J. L. Bernal and E. D. Kovetz, “Line-intensity mapping: theory review with a focus on star-formation lines,” *Astron. Astrophys. Rev.* **30**, no.1, 5 (2022) [arXiv:2206.15377 [astro-ph.CO]].
- [31] A. Laroche, D. Gilman, X. Li, J. Bovy and X. Du, “Quantum fluctuations masquerade as halos: Bounds on ultra-light dark matter from quadruply-imaged quasars,” [arXiv:2206.11269 [astro-ph.CO]].
- [32] W. Hu, R. Barkana and A. Gruzinov, “Cold and fuzzy dark matter,” *Phys. Rev. Lett.* **85**, 1158-1161 (2000) [arXiv:astro-ph/0003365 [astro-ph]].
- [33] J. S. Bullock and M. Boylan-Kolchin, “Small-Scale Challenges to the Λ CDM Paradigm,” *Ann. Rev. Astron. Astrophys.* **55**, 343-387 (2017) [arXiv:1707.04256 [astro-ph.CO]].
- [34] K. Blum and L. Teodori, “Gravitational lensing H0 tension from ultralight axion galactic cores,” *Phys. Rev.*

- D **104**, no.12, 123011 (2021) [arXiv:2105.10873 [astro-ph.CO]].
- [35] I. J. Allali, M. P. Hertzberg and F. Rompineve, “Dark sector to restore cosmological concordance,” Phys. Rev. D **104**, no.8, L081303 (2021) [arXiv:2104.12798 [astro-ph.CO]].
- [36] A. Laguë, J. R. Bond, R. Hložek, K. K. Rogers, D. J. E. Marsh and D. Grin, “Constraining ultralight axions with galaxy surveys,” JCAP **01**, no.01, 049 (2022) [arXiv:2104.07802 [astro-ph.CO]].
- [37] G. Ye, J. Zhang and Y. S. Piao, “Alleviating both H0 and S8 tensions: Early dark energy lifts the CMB-lockdown on ultralight axion,” Phys. Lett. B **839**, 137770 (2023) [arXiv:2107.13391 [astro-ph.CO]].
- [38] E. J. Baxter *et al.* [DES], “Dark Energy Survey Year 1 Results: Methodology and Projections for Joint Analysis of Galaxy Clustering, Galaxy Lensing, and CMB Lensing Two-point Functions,” Phys. Rev. D **99**, no.2, 023508 (2019) [arXiv:1802.05257 [astro-ph.CO]].
- [39] V. Iršič, M. Viel, M. G. Haehnelt, J. S. Bolton and G. D. Becker, “First constraints on fuzzy dark matter from Lyman- α forest data and hydrodynamical simulations,” Phys. Rev. Lett. **119**, no.3, 031302 (2017) [arXiv:1703.04683 [astro-ph.CO]].
- [40] E. Armengaud, N. Palanque-DeLabrouille, C. Yèche, D. J. E. Marsh and J. Baur, “Constraining the mass of light bosonic dark matter using SDSS Lyman- α forest,” Mon. Not. Roy. Astron. Soc. **471**, no.4, 4606-4614 (2017) [arXiv:1703.09126 [astro-ph.CO]].
- [41] K. K. Rogers and H. V. Peiris, “Strong Bound on Canonical Ultralight Axion Dark Matter from the Lyman-Alpha Forest,” Phys. Rev. Lett. **126**, no.7, 071302 (2021) [arXiv:2007.12705 [astro-ph.CO]].
- [42] T. Kobayashi, R. Murgia, A. De Simone, V. Iršič and M. Viel, “Lyman- α constraints on ultralight scalar dark matter: Implications for the early and late universe,” Phys. Rev. D **96**, no.12, 123514 (2017) [arXiv:1708.00015 [astro-ph.CO]].
- [43] B. Bozek, D. J. E. Marsh, J. Silk and R. F. G. Wyse, “Galaxy UV-luminosity function and reionization constraints on axion dark matter,” Mon. Not. Roy. Astron. Soc. **450**, no.1, 209-222 (2015) [arXiv:1409.3544 [astro-ph.CO]].
- [44] H. Y. Schive, T. Chiueh, T. Broadhurst and K. W. Huang, “Contrasting Galaxy Formation from Quantum Wave Dark Matter, ψ DM, with Λ CDM, using Planck and Hubble Data,” Astrophys. J. **818**, no.1, 89 (2016) [arXiv:1508.04621 [astro-ph.GA]].
- [45] P. S. Corasaniti, S. Agarwal, D. J. E. Marsh and S. Das, “Constraints on dark matter scenarios from measurements of the galaxy luminosity function at high redshifts,” Phys. Rev. D **95**, no.8, 083512 (2017) [arXiv:1611.05892 [astro-ph.CO]].
- [46] J. Sipple, A. Lidz, D. Grin and G. Sun, “Fuzzy Dark Matter Constraints from the Hubble Frontier Fields,” [arXiv:2407.17059 [astro-ph.CO]].
- [47] H. Winch, K. K. Rogers, R. Hložek and D. J. E. Marsh, “High-redshift, small-scale tests of ultralight axion dark matter using Hubble and Webb galaxy UV luminosities,” [arXiv:2404.11071 [astro-ph.CO]].
- [48] J. Flitter and E. D. Kovetz, “New tool for 21-cm cosmology. I. Probing Λ CDM and beyond,” Phys. Rev. D **109**, no.4, 043512 (2024) [arXiv:2309.03942 [astro-ph.CO]].
- [49] N. Bar, K. Blum and C. Sun, “Galactic rotation curves versus ultralight dark matter: A systematic comparison with SPARC data,” Phys. Rev. D **105**, no.8, 083015 (2022) [arXiv:2111.03070 [hep-ph]].
- [50] M. Dentler, D. J. E. Marsh, R. Hložek, A. Laguë, K. K. Rogers and D. Grin, “Fuzzy dark matter and the Dark Energy Survey Year 1 data,” Mon. Not. Roy. Astron. Soc. **515**, no.4, 5646-5664 (2022) [arXiv:2111.01199 [astro-ph.CO]].
- [51] F. Tamburini, B. Thidé and M. Della Valle, “Measurement of the spin of the M87 black hole from its observed twisted light,” Mon. Not. Roy. Astron. Soc. **492**, no.1, L22-L27 (2020) [arXiv:1904.07923 [astro-ph.HE]].
- [52] H. Davoudiasl and P. B. Denton, “Ultralight Boson Dark Matter and Event Horizon Telescope Observations of M87*,” Phys. Rev. Lett. **123**, no.2, 021102 (2019) [arXiv:1904.09242 [astro-ph.CO]].
- [53] C. Ünal, F. Pacucci and A. Loeb, “Properties of ultralight bosons from heavy quasar spins via superradiance,” JCAP **05**, 007 (2021) [arXiv:2012.12790 [hep-ph]].
- [54] D. J. E. Marsh and J. C. Niemeyer, “Strong Constraints on Fuzzy Dark Matter from Ultrafaint Dwarf Galaxy Eridanus II,” Phys. Rev. Lett. **123**, no.5, 051103 (2019) [arXiv:1810.08543 [astro-ph.CO]].
- [55] D. Jones, S. Palatnick, R. Chen, A. Beane and A. Lidz, “Fuzzy Dark Matter and the 21 cm Power Spectrum,” Astrophys. J. **913**, no.1, 7 (2021) [arXiv:2101.07177 [astro-ph.CO]].
- [56] D. Sarkar, J. Flitter and E. D. Kovetz, “Exploring delaying and heating effects on the 21-cm signature of fuzzy dark matter,” Phys. Rev. D **105**, no.10, 103529 (2022) [arXiv:2201.03355 [astro-ph.CO]].
- [57] D. R. DeBoer, A. R. Parsons, J. E. Aguirre, P. Alexander, Z. S. Ali, A. P. Beardsley, G. Bernardi, J. D. Bowman, R. F. Bradley and C. L. Carilli, *et al.* “Hydrogen Epoch of Reionization Array (HERA),” Publ. Astron. Soc. Pac. **129**, no.974, 045001 (2017) [arXiv:1606.07473 [astro-ph.IM]].
- [58] Z. Abdurashidova *et al.* [HERA], “HERA Phase I Limits on the Cosmic 21 cm Signal: Constraints on Astrophysics and Cosmology during the Epoch of Reionization,” Astrophys. J. **924**, no.2, 51 (2022) [arXiv:2108.07282 [astro-ph.CO]].
- [59] Z. Abdurashidova *et al.* [HERA], “Improved Constraints on the 21 cm EoR Power Spectrum and the X-Ray Heating of the IGM with HERA Phase I Observations,” Astrophys. J. **945**, no.2, 124 (2023) [arXiv:2210.04912 [astro-ph.CO]].
- [60] Bouwens R. J., Oesch P. A., Stefanon M., Illingworth G., Labbé I., Reddy N., Atek H., *et al.*, 2021, AJ, 162, 47.
- [61] B. Ciardi, A. Ferrara, S. Marri and G. Raimondo, “Cosmological reionization around the first stars: Monte Carlo radiative transfer,” Mon. Not. Roy. Astron. Soc. **324**, 381 (2001) [arXiv:astro-ph/0005181 [astro-ph]].
- [62] M. G. Santos, L. Ferramacho, M. B. Silva, A. Amblard and A. Cooray, “Fast and Large Volume Simulations of the 21 cm Signal from the Reionization and pre-Reionization Epochs,” Mon. Not. Roy. Astron. Soc. **406**, 2421-2432 (2010) [arXiv:0911.2219 [astro-ph.CO]].
- [63] P. R. Shapiro, I. T. Iliev, G. Mellema, K. Ahn, Y. Mao, M. Friedrich, K. Datta, H. Park, E. Komatsu and E. Fernandez, *et al.* “Simulating Cosmic Reionization

- and the Radiation Backgrounds from the Epoch of Reionization,” AIP Conf. Proc. **1480**, no.1, 248-260 (2012) [arXiv:1211.0583 [astro-ph.CO]].
- [64] S. Hassan, R. Davé, K. Finlator and M. G. Santos, “Simulating the 21 cm signal from reionization including non-linear ionizations and inhomogeneous recombinations,” Mon. Not. Roy. Astron. Soc. **457**, no.2, 1550-1567 (2016) [arXiv:1510.04280 [astro-ph.CO]].
- [65] D. Sarkar, S. Bharadwaj and S. Anathpindika, “Modelling the post-reionization neutral hydrogen ($H\text{ i}$) bias,” Mon. Not. Roy. Astron. Soc. **460**, no.4, 4310-4319 (2016) [arXiv:1605.02963 [astro-ph.CO]].
- [66] R. Ghara, G. Mellema, S. K. Giri, T. R. Choudhury, K. K. Datta and S. Majumdar, “Prediction of the 21-cm signal from reionization: comparison between 3D and 1D radiative transfer schemes,” Mon. Not. Roy. Astron. Soc. **476**, no.2, 1741-1755 (2018) [arXiv:1710.09397 [astro-ph.CO]].
- [67] A. Mesinger, “Reionization and Cosmic Dawn: theory and simulations,” IAU Symp. **333**, 3-11 (2017) [arXiv:1801.02649 [astro-ph.CO]].
- [68] D. Sarkar and S. Bharadwaj, “Modelling redshift space distortion in the post-reionization $H\text{ i}$ 21-cm power spectrum,” Mon. Not. Roy. Astron. Soc. **476**, no.1, 96-108 (2018) [arXiv:1801.07868 [astro-ph.CO]].
- [69] P. Ocvirk, D. Aubert, J. G. Sorce, P. R. Shapiro, N. Deparis, T. Dawoodbhoy, J. Lewis, R. Teyssier, G. Yepes and S. Gottlöber, *et al.* “Cosmic Dawn II (CoDa II): a new radiation-hydrodynamics simulation of the self-consistent coupling of galaxy formation and reionization,” Mon. Not. Roy. Astron. Soc. **496**, no.4, 4087-4107 (2020) [arXiv:1811.11192 [astro-ph.GA]].
- [70] S. Majumdar, G. Mellema, K. K. Datta, H. Jensen, T. R. Choudhury, S. Bharadwaj and M. M. Friedrich, “On the use of seminumerical simulations in predicting the 21-cm signal from the epoch of reionization,” Mon. Not. Roy. Astron. Soc. **443**, no.4, 2843-2861 (2014) [arXiv:1403.0941 [astro-ph.CO]].
- [71] D. Sarkar and S. Bharadwaj, “Redshift-space distortions of the $H\text{ i}$ 21-cm intensity mapping signal due to the internal motions within galaxies,” Mon. Not. Roy. Astron. Soc. **487**, no.4, 5666-5678 (2019) [arXiv:1906.07032 [astro-ph.CO]].
- [72] M. Molaro, R. Davé, S. Hassan, M. G. Santos and K. Finlator, “ARTIST: Fast radiative transfer for large-scale simulations of the epoch of reionisation,” Mon. Not. Roy. Astron. Soc. **489**, no.4, 5594-5611 (2019) [arXiv:1901.03340 [astro-ph.CO]].
- [73] R. Kannan, E. Garaldi, A. Smith, R. Pakmor, V. Springel, M. Vogelsberger and L. Hernquist, “Introducing the thesan project: radiation-magnetohydrodynamic simulations of the epoch of reionization,” Mon. Not. Roy. Astron. Soc. **511**, no.3, 4005-4030 (2022) [arXiv:2110.00584 [astro-ph.GA]].
- [74] A. K. Shaw, A. Chakraborty, M. Kamran, R. Ghara, S. Choudhuri, S. S. Ali, S. Pal, A. Ghosh, J. Kumar and P. Dutta, *et al.* “Probing early Universe through redshifted 21-cm signal: Modeling and observational challenges,” J. Astrophys. Astron. **44**, no.1, 4 (2023) [arXiv:2211.05512 [astro-ph.CO]].
- [75] J. B. Muñoz, “An Effective Model for the Cosmic-Dawn 21-cm Signal,” [arXiv:2302.08506 [astro-ph.CO]].
- [76] B. Maity and T. R. Choudhury, “Efficient exploration of reionization parameters for the upcoming 21 cm observations using a photon-conserving seminumerical model SCRIPT,” Mon. Not. Roy. Astron. Soc. **521**, no.3, 4140-4155 (2023) [arXiv:2211.12909 [astro-ph.CO]].
- [77] J. B. Muñoz, “Standard Ruler at Cosmic Dawn,” Phys. Rev. Lett. **123**, no.13, 131301 (2019) [arXiv:1904.07868 [astro-ph.CO]].
- [78] J. B. Muñoz, “Robust Velocity-induced Acoustic Oscillations at Cosmic Dawn,” Phys. Rev. D **100**, no.6, 063538 (2019) [arXiv:1904.07881 [astro-ph.CO]].
- [79] A. Mesinger, S. Furlanetto and R. Cen, “21cmFAST: A Fast, Semi-Numerical Simulation of the High-Redshift 21-cm Signal,” Mon. Not. Roy. Astron. Soc. **411**, 955 (2011) [arXiv:1003.3878 [astro-ph.CO]].
- [80] N. S. Kern, A. Liu, A. R. Parsons, A. Mesinger and B. Greig, “Emulating Simulations of Cosmic Dawn for 21 cm Power Spectrum Constraints on Cosmology, Reionization, and X-Ray Heating,” Astrophys. J. **848**, no.1, 23 (2017) [arXiv:1705.04688 [astro-ph.CO]].
- [81] W. D. Jennings, C. A. Watkinson, F. B. Abdalla and J. D. McEwen, “Evaluating machine learning techniques for predicting power spectra from reionization simulations,” Mon. Not. Roy. Astron. Soc. **483**, no.3, 2907-2922 (2019) [arXiv:1811.09141 [astro-ph.CO]].
- [82] A. Cohen, A. Fialkov, R. Barkana and R. Monsalve, “Emulating the Global 21-cm Signal from Cosmic Dawn and Reionization,” [arXiv:1910.06274 [astro-ph.CO]].
- [83] C. H. Bye, S. K. N. Portillo and A. Fialkov, “21cmVAE: A Very Accurate Emulator of the 21 cm Global Signal,” Astrophys. J. **930**, no.1, 79 (2022) [arXiv:2107.05581 [astro-ph.CO]].
- [84] H. T. J. Bevins, W. J. Handley, A. Fialkov, E. d. Acedo and K. Javid, “globalemu: a novel and robust approach for emulating the sky-averaged 21-cm signal from the cosmic dawn and epoch of reionization,” Mon. Not. Roy. Astron. Soc. **508**, no.2, 2923-2936 (2021) [arXiv:2104.04336 [astro-ph.CO]].
- [85] M. Choudhury, A. Datta and S. Majumdar, “Extracting the 21-cm power spectrum and the reionization parameters from mock data sets using artificial neural networks,” Mon. Not. Roy. Astron. Soc. **512**, no.4, 5010-5022 (2022) [arXiv:2112.13866 [astro-ph.CO]].
- [86] S. Sikder, R. Barkana, I. Reis and A. Fialkov, “Emulation of the cosmic dawn 21-cm power spectrum and classification of excess radio models using an artificial neural network,” Mon. Not. Roy. Astron. Soc. **527**, no.4, 9977-9998 (2023) [arXiv:2201.08205 [astro-ph.CO]].
- [87] D. Breitman, A. Mesinger, S. G. Murray, D. Prelogovic, Y. Qin and R. Trotta, “21cmemu: an emulator of 21cm-fast summary observables,” Mon. Not. Roy. Astron. Soc. **527**, no.4, 9833-9852 (2023) [arXiv:2309.05697 [astro-ph.CO]].
- [88] H. Lazare, D. Sarkar and E. D. Kovetz, “HERA bound on x-ray luminosity when accounting for population III stars,” Phys. Rev. D **109**, no.4, 043523 (2024) [arXiv:2307.15577 [astro-ph.CO]].
- [89] N. J. F. Gillet, A. Mesinger and J. Park, “Combining high-z galaxy luminosity functions with Bayesian evidence,” Mon. Not. Roy. Astron. Soc. **491**, no.2, 1980-1997 (2020) [arXiv:1906.06296 [astro-ph.GA]].
- [90] N. Aghanim *et al.* [Planck], “Planck 2018 results. VI. Cosmological parameters,” Astron. Astrophys. **641**, A6 (2020) [erratum: Astron. Astrophys. **652**, C4 (2021)] [arXiv:1807.06209 [astro-ph.CO]].
- [91] Y. Qin, V. Poulin, A. Mesinger, B. Greig, S. Murray

- and J. Park, “Reionization inference from the CMB optical depth and E-mode polarization power spectra,” *Mon. Not. Roy. Astron. Soc.* **499**, no.1, 550-558 (2020) [arXiv:2006.16828 [astro-ph.CO]].
- [92] I. McGreer, A. Mesinger and V. D’Odorico, “Model-independent evidence in favour of an end to reionization by $z \approx 6$,” *Mon. Not. Roy. Astron. Soc.* **447**, no.1, 499-505 (2015) [arXiv:1411.5375 [astro-ph.CO]].
- [93] J. Flitter and E. D. Kovetz, “New tool for 21-cm cosmology. II. Investigating the effect of early linear fluctuations,” *Phys. Rev. D* **109**, no.4, 043513 (2024) [arXiv:2309.03948 [astro-ph.CO]].
- [94] T. L. Smith, V. Poulin and M. A. Amin, “Oscillating scalar fields and the Hubble tension: a resolution with novel signatures,” *Phys. Rev. D* **101**, no.6, 063523 (2020) [arXiv:1908.06995 [astro-ph.CO]].
- [95] J. Flitter and E. D. Kovetz, “Closing the window on fuzzy dark matter with the 21-cm signal,” *Phys. Rev. D* **106**, no.6, 063504 (2022) [arXiv:2207.05083 [astro-ph.CO]].
- [96] J. Park, A. Mesinger, B. Greig and N. Gillet, “Inferring the astrophysics of reionization and cosmic dawn from galaxy luminosity functions and the 21-cm signal,” *Mon. Not. Roy. Astron. Soc.* **484**, no.1, 933-949 (2019) [arXiv:1809.08995 [astro-ph.GA]].
- [97] N. Sabti, J. B. Muñoz and D. Blas, “Galaxy luminosity function pipeline for cosmology and astrophysics,” *Phys. Rev. D* **105**, no.4, 043518 (2022) [arXiv:2110.13168 [astro-ph.CO]].
- [98] N. Sabti, J. B. Muñoz and M. Kamionkowski, “Insights from HST into Ultramassive Galaxies and Early-Universe Cosmology,” *Phys. Rev. Lett.* **132**, no.6, 061002 (2024) [arXiv:2305.07049 [astro-ph.CO]].
- [99] R. K. Sheth and G. Tormen, “Large scale bias and the peak background split,” *Mon. Not. Roy. Astron. Soc.* **308**, 119 (1999) [arXiv:astro-ph/9901122 [astro-ph]].
- [100] R. K. Sheth and G. Tormen, “An Excursion Set Model of Hierarchical Clustering : Ellipsoidal Collapse and the Moving Barrier,” *Mon. Not. Roy. Astron. Soc.* **329**, 61 (2002) [arXiv:astro-ph/0105113 [astro-ph]].
- [101] P. R. Shapiro, M. L. Giroux and A. Babul, “Reionization in a cold dark matter universe: The Feedback of galaxy formation on the intergalactic medium,” *Astrophys. J.* **427**, 25 (1994)
- [102] L. Hui and N. Y. Gnedin, “Equation of state of the photoionized intergalactic medium,” *Mon. Not. Roy. Astron. Soc.* **292**, 27 (1997) [arXiv:astro-ph/9612232 [astro-ph]].
- [103] R. Barkana and A. Loeb, “In the beginning: The First sources of light and the reionization of the Universe,” *Phys. Rept.* **349**, 125-238 (2001) [arXiv:astro-ph/0010468 [astro-ph]].
- [104] V. Springel and L. Hernquist, “The history of star formation in a Λ CDM universe,” *Mon. Not. Roy. Astron. Soc.* **339**, 312 (2003) [arXiv:astro-ph/0206395 [astro-ph]].
- [105] T. Okamoto, L. Gao and T. Theuns, “Massloss of galaxies due to a UV-background,” *Mon. Not. Roy. Astron. Soc.* **390**, 920 (2008) [arXiv:0806.0378 [astro-ph]].
- [106] A. Mesinger and M. Dijkstra, “UV Radiative Feedback During the Advanced Stages of Reionization,” *Mon. Not. Roy. Astron. Soc.* **390**, 1071 (2008) [arXiv:0806.3090 [astro-ph]].
- [107] E. Sobacchi and A. Mesinger, “Inhomogeneous recombinations during cosmic reionization,” *Mon. Not. Roy. Astron. Soc.* **440**, no.2, 1662-1673 (2014) [arXiv:1402.2298 [astro-ph.CO]].
- [108] E. Sobacchi and A. Mesinger, “The clustering of Lyman α emitters at $z \approx 7$: implications for reionization and host halo masses,” *Mon. Not. Roy. Astron. Soc.* **453**, no.2, 1843-1854 (2015) [arXiv:1505.02787 [astro-ph.CO]].
- [109] J. B. Oke and J. E. Gunn, “Secondary standard stars for absolute spectrophotometry,” *Astrophys. J.* **266**, 713 (1983)
- [110] P. Madau, L. Pozzetti and M. Dickinson, “The Star formation history of field galaxies,” *Astrophys. J.* **498**, 106 (1998) [arXiv:astro-ph/9708220 [astro-ph]].
- [111] R. C. Kennicutt, Jr., “Star formation in galaxies along the Hubble sequence,” *Ann. Rev. Astron. Astrophys.* **36**, 189-231 (1998) [arXiv:astro-ph/9807187 [astro-ph]].
- [112] Trapp A. C., Furlanetto S. R., 2020, *MNRAS*, 499, 2401.
- [113] G. R. Meurer, T. M. Heckman and D. Calzetti, “Dust absorption and the ultraviolet luminosity density at $z \sim 3$ as calibrated by local starburst galaxies,” *Astrophys. J.* **521**, 64 (1999) [arXiv:astro-ph/9903054 [astro-ph]].
- [114] C. Alcock and B. Paczynski, “An evolution free test for non-zero cosmological constant,” *Nature* **281**, 358-359 (1979)
- [115] G. Shmueli, D. Sarkar and E. D. Kovetz, “Mitigating the optical depth degeneracy in the cosmological measurement of neutrino masses using 21-cm observations,” *Phys. Rev. D* **108**, no.8, 083531 (2023) [arXiv:2305.07056 [astro-ph.CO]].
- [116] A. Liu, J. R. Pritchard, R. Allison, A. R. Parsons, U. Seljak and B. D. Sherwin, “Eliminating the optical depth nuisance from the CMB with 21 cm cosmology,” *Phys. Rev. D* **93**, no.4, 043013 (2016) [arXiv:1509.08463 [astro-ph.CO]].
- [117] B. Spina, S. E. I. Bosman, F. B. Davies, P. Gaikwad and Y. Zhu, “Damping wings in the Lyman- α forest: a model-independent measurement of the neutral fraction at $5.4 < z < 6.1$,” [arXiv:2405.12273 [astro-ph.CO]].
- [118] S. Bharadwaj and S. S. Ali, “The CMBR fluctuations from HI perturbations prior to reionization,” *Mon. Not. Roy. Astron. Soc.* **352**, 142 (2004) [arXiv:astro-ph/0401206 [astro-ph]].
- [119] S. Furlanetto, A. Lidz, A. Loeb, M. McQuinn, J. Pritchard, J. Aguirre, M. Alvarez, D. Backer, J. Bowman and J. Burns, *et al.* “Astrophysics from the Highly-Redshifted 21 cm Line,” [arXiv:0902.3011 [astro-ph.CO]].
- [120] P. Madau and F. Haardt, “Cosmic Reionization after Planck: Could Quasars Do It All?,” *Astrophys. J. Lett.* **813**, no.1, L8 (2015) [arXiv:1507.07678 [astro-ph.CO]].
- [121] S. Singh, J. Nambissan T., R. Subrahmanyam, N. Udaya Shankar, B. S. Girish, A. Raghunathan, R. Somashekar, K. S. Srivani and M. Sathyanarayana Rao, “On the detection of a cosmic dawn signal in the radio background,” *Nature Astron.* **6**, no.5, 607-617 (2022) [arXiv:2112.06778 [astro-ph.CO]].
- [122] R. A. Monsalve, A. E. E. Rogers, J. D. Bowman and T. J. Mozdzen, “Results from EDGES High-Band: I. Constraints on Phenomenological Models for the Global 21 cm Signal,” *Astrophys. J.* **847**, no.1, 64 (2017) [arXiv:1708.05817 [astro-ph.CO]].
- [123] R. A. Monsalve, B. Greig, J. D. Bowman, A. Mesinger, A. E. E. Rogers, T. J. Mozdzen, N. S. Kern and N. Mahesh, “Results from EDGES High-Band: II. Constraints

- on Parameters of Early Galaxies,” *Astrophys. J.* **863**, no.1, 11 (2018) [arXiv:1806.07774 [astro-ph.CO]].
- [124] R. A. Monsalve, A. Fialkov, J. D. Bowman, A. E. E. Rogers, T. J. Mozdzen, A. Cohen, R. Barkana and N. Mahesh, “Results from EDGES High-Band: III. New Constraints on Parameters of the Early Universe,” *Astrophys. J.* **875**, no.1, 67 (2019) [arXiv:1901.10943 [astro-ph.CO]].
- [125] Z. Abdurashidova *et al.* [HERA], “First Results from HERA Phase I: Upper Limits on the Epoch of Reionization 21 cm Power Spectrum,” *Astrophys. J.* **925**, no.2, 221 (2022) [arXiv:2108.02263 [astro-ph.CO]].
- [126] McKay, M. D., Beckman, R. J., & Conover, W. J. 1979, *Technometrics*, 21, 239
- [127] M. Abadi, A. Agarwal, P. Barham, E. Brevdo, Z. Chen, C. Citro, G. S. Corrado, A. Davis, J. Dean, M. Devin, S. Ghemawat, I. Goodfellow *et al.*, “TensorFlow: Large-Scale Machine Learning on Heterogeneous Systems.” (2015), Software available from: <https://www.tensorflow.org/>.
- [128] F. Chollet *et al.*, “Keras.” (2015), Software available from: <https://keras.io>.
- [129] D. C. Ciresan, U. Meier, J. Masci, L. M. Gambardella, J. Schmidhuber, “Proceedings of the 22nd International Joint Conference on Artificial Intelligence,” Vol. 22 (2011), pp. 1237–1242
- [130] C. Szegedy, W. Liu, Y. Jia, P. Sermanet, S. Reed, D. Anguelov, D. Erhan, V. Vanhoucke and A. Rabinovich, “Going deeper with convolutions,” [arXiv:1409.4842 [cs.CV]].
- [131] Clevert, D.-A., Unterthiner, T., Hochreiter, S. 2015. “Fast and Accurate Deep Network Learning by Exponential Linear Units (ELUs)”. arXiv e-prints.
- [132] K. Fukushima. “Visual Feature Extraction by a Multilayered Network of Analog Threshold Elements”, *IEEE Transactions on Systems Science and Cybernetics*, **5**, no. 4, pp. 322-333 (1969).
- [133] D. P. Kingma and J. Ba, “Adam: A Method for Stochastic Optimization,” [arXiv:1412.6980 [cs.LG]].
- [134] D. Foreman-Mackey, D. W. Hogg, D. Lang and J. Goodman, “emcee: The MCMC Hammer,” *Publ. Astron. Soc. Pac.* **125**, 306-312 (2013) [arXiv:1202.3665 [astro-ph.IM]].
- [135] Foreman-Mackey D., 2016, *JOSS*, 1, 24.
- [136] J. B. Muñoz, Y. Qin, A. Mesinger, S. G. Murray, B. Greig and C. Mason, “The impact of the first galaxies on cosmic dawn and reionization,” *Mon. Not. Roy. Astron. Soc.* **511**, no.3, 3657-3681 (2022) [arXiv:2110.13919 [astro-ph.CO]].
- [137] S. G. Murray, J. Pober and M. Kolopanis, “21cm-Sense v2: A modular, open-source 21cm sensitivity calculator,” *J. Open Source Softw.* **9**, 6501 (2024) [arXiv:2406.02415 [astro-ph.CO]].
- [138] A. Nygaard, E. B. Holm, S. Hannestad and T. Tram, “CONNECT: a neural network based framework for emulating cosmological observables and cosmological parameter inference,” *JCAP* **05**, 025 (2023) [arXiv:2205.15726 [astro-ph.IM]].
- [139] S. Alam *et al.* [eBOSS], “Completed SDSS-IV extended Baryon Oscillation Spectroscopic Survey: Cosmological implications from two decades of spectroscopic surveys at the Apache Point Observatory,” *Phys. Rev. D* **103**, no.8, 083533 (2021) [arXiv:2007.08991 [astro-ph.CO]].
- [140] K. K. Rogers and V. Poulin, “ 5σ tension between Planck cosmic microwave background and eBOSS Lyman-alpha forest and constraints on physics beyond Λ CDM,” [arXiv:2311.16377 [astro-ph.CO]].