

---

# WindsorML - High-Fidelity Computational Fluid Dynamics Dataset For Automotive Aerodynamics

---

**Neil Ashton\***

Amazon Web Services  
60 Holborn Viaduct  
London, EC1A 2FD  
neashton@amazon.com

**Jordan B. Angel**

Volcano Platforms Inc.  
Stanford Research Park, 3240 Hillview Ave  
Palo Alto, CA 94304

**Aditya S. Ghatge**

Volcano Platforms Inc.  
Stanford Research Park, 3240 Hillview Ave  
Palo Alto, CA 94304

**Gaetan K. W. Kenway**

Volcano Platforms Inc.  
Stanford Research Park, 3240 Hillview Ave  
Palo Alto, CA 94304

**Man Long Wong**

Volcano Platforms Inc.  
Stanford Research Park, 3240 Hillview Ave  
Palo Alto, CA 94304

**Cetin Kiris**

Volcano Platforms Inc.  
Stanford Research Park, 3240 Hillview Ave  
Palo Alto, CA 94304

**Astrid Walle**

Siemens Energy  
Huttenstraße 12, 10553  
Berlin, Germany

**Danielle C. Maddix**

AWS AI Labs  
2795 Augustine Dr.,  
Santa Clara, CA 95054, United States

**Gary Page**

Loughborough University  
Epinal Way, Loughborough  
LE11 3TU, United Kingdom

## Abstract

This paper presents a new open-source high-fidelity dataset for Machine Learning (ML) containing 355 geometric variants of the Windsor body, to help the development and testing of ML surrogate models for external automotive aerodynamics. Each Computational Fluid Dynamics (CFD) simulation was run with a GPU-native high-fidelity Wall-Modeled Large-Eddy Simulations (WMLES) using a Cartesian immersed-boundary method using more than 280M cells to ensure the greatest possible accuracy. The dataset contains geometry variants that exhibits a wide range of flow characteristics that are representative of those observed on road-cars. The dataset itself contains the 3D time-averaged volume & boundary data as well as the geometry and force & moment coefficients. This paper discusses the validation of the underlying CFD methods as well as contents and structure of the dataset. To the authors knowledge, this represents the first, large-scale high-fidelity CFD dataset for the Windsor body with a permissive open-source license (CC-BY-SA).

## Introduction

The use of Machine Learning (ML) to augment Computational Fluid Dynamics (CFD) is gaining the attention of academia and industry because of its potential to offer an additional tool to explore new designs in near real-time compared to traditional CFD simulations [1–5]. Whilst these methods

---

\*Corresponding Author

are still in their infancy, there have been promising results that show their ability to predict surface, volume and/or forces and moments on unseen geometries or boundary conditions [6, 7, 1, 8, 9]. However the majority of these examples have been for 2D cases [6] with limited examples on more complex 3D cases [1, 9, 7, 8]. One of the reasons for the limited dissemination of 3D examples is the lack of publicly available 3D training data. Unlike Large-Language Models (LLMs) where the training data is readily available, public training data for CFD, based upon 3D realistic geometries is limited and where such examples exist they are often using lower-fidelity CFD methods [8, 6] that are not representative of industry state of the art. Generating such datasets also requires a combination of large-scale High-Performance Computing (HPC) resources, human time to build an efficient workflow and in-depth knowledge of the underlying test-case to ensure rigour and correlation to the corresponding experimental data.

To help to address this lack of 3D training data, Ashton et al. [10] recently created the AhmedML dataset, that contains 500 different geometry variants of the Ahmed car body, simulated using a high-fidelity hybrid RANS-LES approach using OpenFOAM on meshes of approximately 20M cells. This open-source dataset contains time-averaged volume & boundary flow-field variables as well forces and moment data to provide a rich dataset to aid ML model development. Whilst this dataset enables the development and testing of ML methods, there are a number of limitations to this dataset that have motivated the creation of the WindsorML dataset.

Firstly, in order to thoroughly assess an ML method, more than one dataset is required. Just as traditional CFD approaches are validated on a number of cases to ensure general applicability. Secondly, the AhmedML dataset is based upon mesh sizes of approximately 20M cells which is below the industry standard of  $> 100M$  cells for scale-resolving simulations of road-cars [11] and limits the ability to test out the scaling of ML methods using realistic mesh sizes. This is an important point as some ML methods that work well for cases at 20M cells may become inefficient as you scale beyond 300M points [1] and/or require the use of downsampling and data reduction techniques. Moreover from a flow physics point of view, the Windsor body [12, 13] is closer to modern road-cars compared to the Ahmed car body and contains more detailed and up to date experimental data e.g tomographic 3D PIV data.

Finally, the choice of the Windsor body is also motivated by its use within the Automotive CFD Prediction Workshops (AutoCFD)<sup>2</sup> that aim to bring the fluid dynamics and automotive community together to improve the state of the art for CFD prediction of road vehicles. The dataset described in this paper was used as a test-case during the 4th AutoCFD workshop, for which future papers will discuss the resulting comparisons from a range of different ML methods. Concurrently the DrivAerML dataset [14] based upon the open-source Drivaer has been created, that is described in it's own paper. Used together, the AhmedML [10], WindsorML and DrivAerML [14] datasets, provide ML developers with a broad set of data to use that has been formatted in a consistent fashion and is openly available to download and use with a permissive license (CC-BY-SA).

## Main Contributions

This paper's novel contributions are summarized as follows:

- 355 variations in the windsor body geometry that cover a broad range of pressure and geometry induced flow separation;
- the use of high-fidelity wall-modeled Large-Eddy Simulation (WMLES) CFD method which ensures the best possible correlation to the ground truth;
- first ever, freely available, open-source (CC-BY-SA) large-scale dataset based upon the windsor body that can be used to train ML methods for automotive aerodynamics use cases.

The paper is organised as follows: first, the Windsor test-case is described together with the available experimental data. Next, the validation of the baseline geometry and test-case are described. The results section focuses on both global force coefficients and also selected off-body quantities such as planes in the wake of the car. Next, the dataset itself is detailed, including the choice of the geometry variations and the specific outputs that are included in the dataset. Finally, conclusions are drawn and future work is described. The Supplementary Information (SI) contains additional details on the dataset and validation.

---

<sup>2</sup><https://autocfd.org>

## Test-Case Description

The Windsor body was created by Steve Windsor and Jeff Howell of Rover and later Jaguar Land Rover (JLR) [12, 13] to improve upon the well studied Ahmed car body [15–18] by creating a geometry whose flow features more closely a road vehicle. Whilst the Ahmed car body has been used in many experimental and CFD studies, the long flat surface between the front and rear of the body decouples the aerodynamic behaviour of these two regions and makes it more relevant to commercial vehicles. Two variants of the Windsor body were experimentally tested at the Loughborough University wind-tunnel [12] and have been the subject of numerous CFD studies - that most recently have taken place within the 2nd, 3rd and 4th Automotive CFD Prediction Workshops [13]. The Windsor body was tested in numerous configurations but for this study we follow the 4th AutoCFD4 setup, where the vehicle has no wheels (which simplifies a common source of uncertainty) and the squareback rear shape is used, as the baseline geometry. As discussed later, this baseline geometry is then adapted according to 7 parameters to generate 355 different geometries.

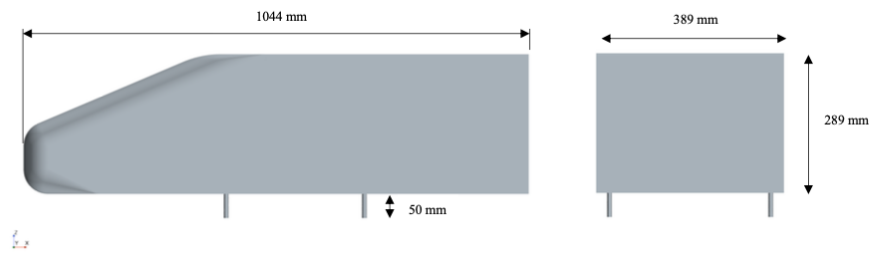

Figure 1: Windsor Geometry

### Geometry

The model geometry is shown in Figure 1. The reference frontal area is defined by the vehicle height and width and for the baseline geometry is  $0.112 \text{ m}^2$ . The reference length used for pitching moment is the wheelbase  $0.6375 \text{ m}$ . The CAD geometry of the model has its origin on the ground plane, in the symmetry plane midway between the wheels (which are not included in this particular geometry) i.e.  $x, y, z = (0, 0, 0)$ . This is also the moment reference center for the calculating of the moments.

The model is yawed by  $-2.5^\circ$  around the  $y$ -axis (please note that for all the simulations in this work,  $y$  is upwards, which differs to the original Windsor geometry where  $z$  is upwards), so generating a positive side force consistent with the experiment. The experimental forces and moments are in the coordinate system of the yawed model, whilst the PIV measurements are in the wind tunnel coordinate system. The choice of  $-2.5^\circ$  yaw was to avoid the well documented bi-stability that can often occur on these bluff bodies [19] that would cause unnecessary uncertainties (but nevertheless deserves future investigation).

The model is mounted in the wind tunnel with four pins at a ground clearance of  $50 \text{ mm}$  and zero pitch. In order to more closely match the underlying experimental data, the simulations themselves include a simplified wind tunnel domain i.e.  $3.2 \text{ m}$  long working section with a  $1.92 \text{ m} \times 1.32 \text{ m}$  (width by height) cross section. There is no moving ground plane so a boundary layer grows along the groundplane. Experimental measurements [12] at the centre of the working section quote a boundary layer thickness of  $60 \text{ mm}$ , displacement thickness of  $9.4 \text{ mm}$  and momentum thickness of  $5.5 \text{ mm}$ . The maximum turbulence intensity was measured to be approximately  $3\%$  at the edge of the boundary layer.

### Solver Setup

All simulations were run using the Volcano ScaLES code by Volcano Platforms, which solves the explicit compressible Navier–Stokes equations using a nominally 4th order spatially accurate finite difference discretization with favorable Kinetic Energy and Entropy Consistency properties making it suitable for Large Eddy Simulations (LES) over a range of flow regimes. The viscous flux discretization utilizes a mix of 4th order and 2nd order discretizations with high spectral bandwidth

thereby allowing further robustness for high Reynolds number flows without additional numerical dissipation via the inviscid flux numerical operator in turbulence resolving regions. Physics-based numerical sensors that are functions of local velocity gradients as well as pressure and density fluctuations allow for spatio-temporally localized use of limiters needed to capture flows with discontinuities such as shocks and steep density gradients. The Strong Stability Preserving (SSP) variant of the classical 3rd order Runge–Kutta scheme developed by Gottlieb & Shu[20] is utilized for all the work presented in this paper.

Geometries are represented in the numerical formulation using an immersed boundary algorithm capable of enforcing inviscid no-penetration boundary conditions as well as viscous skin friction with appropriate Reynolds number asymptotic properties using an equilibrium wall-model. The wall-model that provides a shear-stress constraint at the wall uses solution information interpolated via probing at a fixed distance of  $3\Delta/2$  into the fluid away from walls. Additional methods to damp generation of spurious numerical noise at walls as well as at coarse-fine interfaces are also utilized in the present work. All simulations presented in this work utilize the constant coefficient Vreman subgrid scale closure[21] to model the subgrid-scale stresses.

### Computational Mesh

The Volcano ScaLES solver uses Cartesian grids generated using a recursive octree approach. Grids around engineering-quality configurations consist of an unstructured tree-of-cubes with millions of leaf cubes each containing a structured grid of  $4^3$  or  $8^3$  cells.

Figure 3 depicts the nested refinements regions for the optimized mesh. Refinement is emphasized for the boundary layer development from the nose of the car and for the wake and off-body vorticity directly behind the body. Section 3 of this paper discusses in detail the validation of this code against experimental data for the baseline Windsor model and the rationale behind the choice of computational mesh.

### Boundary Conditions

To follow the setup of the AutoCFD 3 and 4 workshops, the Windsor body is yawed 2.5 degrees and the Reynolds number is  $Re = 2.9 \times 10^6$  based on the body length and the freestream velocity. A nominal inlet velocity of  $40 \text{ m s}^{-1}$  is given upstream of the car and a sensor is placed at  $(x, y, z) = (-2 \text{ m}, 1.3 \text{ m}, 0 \text{ m})$  to measure local static pressure and velocity. For the validation of the method against experimental data for the baseline geometry, these are used to normalize the simulation outputs, however for the dataset itself, the reference inlet velocity is used to normalize all outputs (see SI for further details). The remaining boundary conditions are shown in Figure 2.

The domain required for this case (see Figure 2) represents the wind tunnel confinement but with the following modifications:

1. The Windsor body sidewalls are aligned with the  $x$ -direction, the tunnel is yawed.
2. Only the ground plane has a no slip condition and hence has boundary layer growth; the top and side walls should be treated as a slip or ‘inviscid’ wall.
3. A long parallel inlet run is used in order to grow a boundary layer on the ground plane of approximately the correct thickness.
4. A parallel exit run is added downstream to avoid interactions with the wake. The domain extends upstream to  $x = -5 \text{ m}$  and downstream to  $x = +6 \text{ m}$  (the model is  $x = -0.56 \text{ m}$  nose to  $x = +0.48 \text{ m}$  base). The width and height of the CFD domain matches the wind tunnel.
5. The “outlet” for the tunnel is not a domain boundary for these simulations even though the volume data does not extend further. To minimize numerical reflections from the tunnel exit, the tunnel was allowed to vent into a large reservoir which is initialized with atmospheric conditions and given simple extrapolation boundary conditions far from the tunnel. This means there is no fixed pressure condition or any other boundary condition enforced at the tunnel exit.

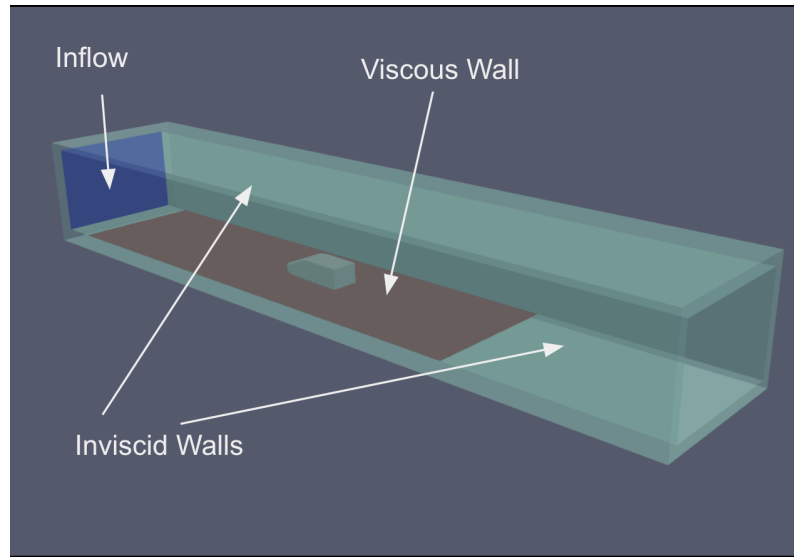

Figure 2: Depiction of the computational domain for the Windsor body simulations.

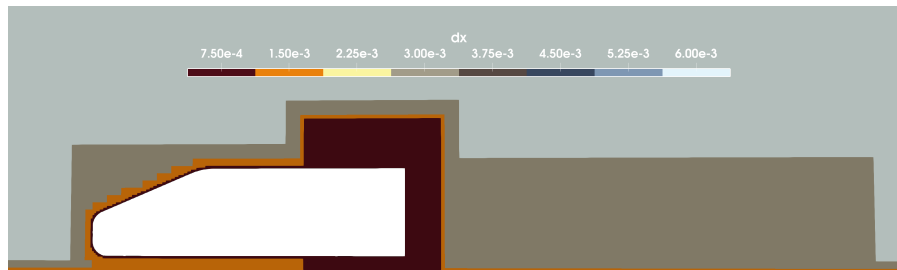

Figure 3: Grid spacing for a slice through  $z = 0$  m for the Windsor body.

### HPC setup

All simulations were run on Amazon Web Services, using a dynamic HPC cluster provisioned by AWS ParallelCluster v3.9. Amazon EC2 g5.48xlarge nodes were used for each case, which contain 8 Nvidia A10g GPU cards and a second generation AMD EPYC processor with 96 physical cores and 768GB of CPU memory. These are connected using a 100Gbit/s Elastic Fabric Adapter (EFA) interconnect [22]. A 300TB Amazon Fsx for Lustre parallel file-system was used as the main data location during the runs, which were later transferred to object storage in Amazon S3. Each simulation was run on a single g5.48xlarge node i.e 8 A10g GPUs, and each case took approximately 2mins to mesh and 28hrs to solve.

### Validation

For the design case study, we choose to keep the refinement regions fixed for all design cases. Using the fixed refinement topology, we consider a consistent grid refinement study for the Windsor body. An example of a grid in this family is depicted in Figure 3. The surface of the body is refined to the finest level with a large wake block immediately behind the body. The block is taller than

Table 1: Computational cost for the Windsor body.

Label	Min. $\Delta x$ [mm]	No. of Cells [ $10^6$ ]	Wall time / CTU [min]	$C_D$
$G_1$	1.00	151	6	0.31
$G_2$	0.75	275	15	0.34
$G_3$	0.625	468	27	0.33
Exp.	-	-	-	0.33

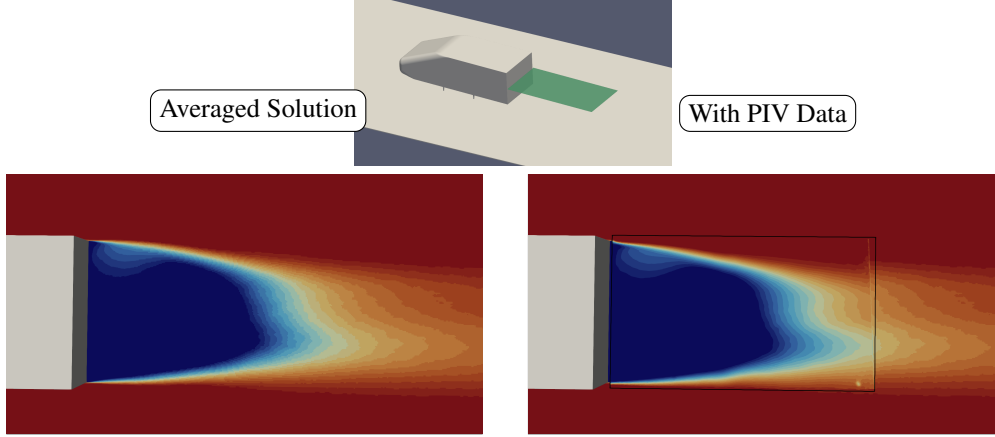

Figure 4: Time-averaged streamwise velocity at  $y = 0.195$  m with PIV data

necessary for the Windsor body but since we are choosing to keep the refinement regions fixed we define a region to accommodate all designs ride height. Table 1 shows results of a consistent grid refinement study using a sequence of grids  $\{G_j\}$  for  $j = 1, 2$  and  $3$ . The columns of the table show the minimum grid spacing used, the number of computational cells in the grid, the wall-clock time per convective time unit<sup>3</sup> (CTU) in minutes and the drag coefficient  $C_d$ . An additional row is included for the experimental drag coefficient value. Based on the results,  $G_2$  is chosen as a representative baseline case and the remainder of the experimental comparisons are carried out for the  $G_2$  grid. This was to achieve a balance between accuracy, computational cost and reach a mesh size that is typically used by the automotive industry for external aerodynamics.

**Velocity:** Typical of bluff-bodies, the Windsor body shows a large recirculation region at the base. The data for the  $y = 0.195$  m slice was taken with a freestream velocity of  $40 \text{ m s}^{-1}$  which is the same as our simulation but, in addition to this plane, tomographic PIV was taken for a 3D region behind the car. This data was recorded for a flow with a freestream velocity of  $30 \text{ m s}^{-1}$ . To make comparisons with the tomographic PIV data, we normalize the velocities by their freestream velocity. With that caveat, Figures 4 & 5 shows a comparison of the normalized time-averaged streamwise velocity for  $y = 0.195$  m compared with the PIV measurements and the same solution at  $z = 0$  m compared to the tomographic PIV data. The overall shape of the wake region is well captured as well as its interaction with the floor boundary layer which can be seen in the velocity contours. See SI for a detailed discussion on the validation of the underlying CFD method.

## Dataset description

### Geometry variations

The baseline geometry is transferred into a parameterized CAD model to allow for automated sampling in the design space. The chosen sampling algorithm is a Halton sequence, which results in a quasi-random low discrepancy sequence with the advantages of being deterministic and extendable. The parameters and respective ranges are shown in Figure 6 and Table 2. The parameters were chosen

<sup>3</sup>Nondimensional time is defined to be  $t^* = tU_\infty/L$  where  $L$  is the length of the Windsor body.

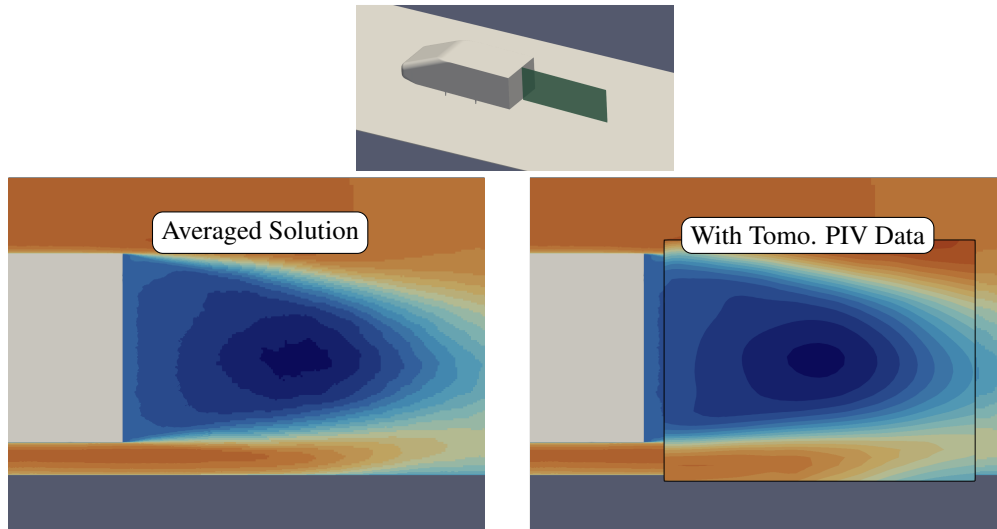

Figure 5: Time-averaged streamwise velocity at  $z = 0$  m with tomographic PIV data.

to provide a suitable range of geometries that would exhibit different flow patterns e.g pressure vs geometry induced separation. The min/max values of each value were based upon engineering judgement and to avoid completely unrealistic shapes as well as avoid invalid shapes during geometry creation. The choice of 355 geometries were also based upon a mixture of computational budget as well as matching what may be possible within industry i.e how many geometries would realistically be generated within an engineering company. Future work could be to expand this dataset further if required.

The geometry choice within the dataset results in a broad range of flow physics - that is partly illustrated in Figures 7c and 7d which show the large range of drag and lift coefficients across the dataset. Figures 7a and 7b take two examples from the dataset that shows the resulting flow-field (mean streamwise velocity) for a geometry producing a high drag coefficient and another one for a low drag coefficient (see SI for more detailed discussion of the dataset outputs).

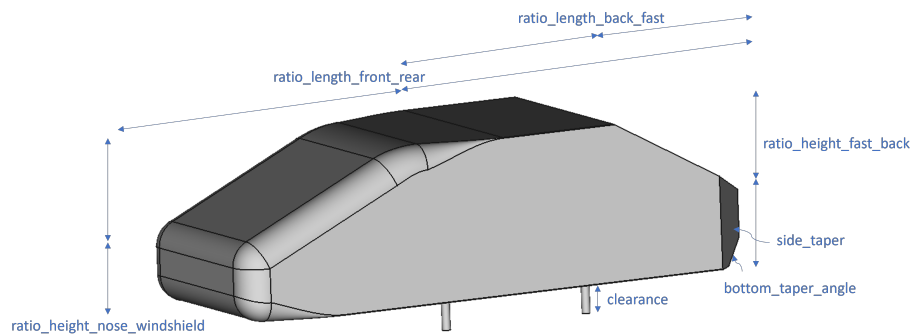

Figure 6: Parameterized CAD model

### How to access the dataset

The dataset is open-source under the CC-BY-SA license <sup>4</sup> and available to download via Amazon S3. In order to download, no AWS account is required and the full details are provided in the SI and the dataset README <sup>5</sup>.

<sup>4</sup><https://creativecommons.org/licenses/by-sa/4.0/>

<sup>5</sup><https://caemldatasets.s3.us-east-1.amazonaws.com/windsor/dataset/README.txt>

Table 2: Geometry variants of the Windsor body

Variable	Min	Max
ratio_length_front_rear	0	0.8
ratio_length_back_fast	0.08	0.5
ratio_height_nose_windshield	0.3	0.7
ratio_height_fast_back	0	0.9
side_taper [mm]	50	100
clearance [mm]	10	200
bottom_taper_angle [°]	1	50

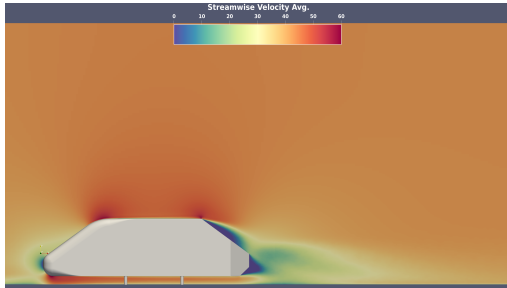

(a) Mean streamwise velocity for high drag geometry variant example

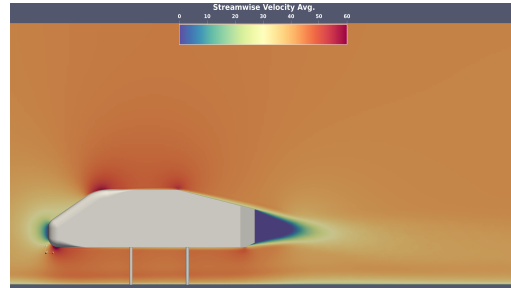

(b) Mean streamwise velocity for low drag geometry variant example

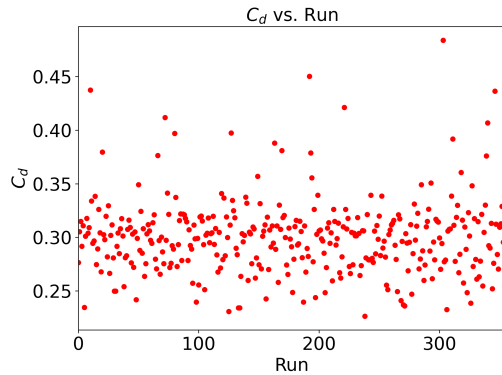

(c) Variation of drag coefficient against run number

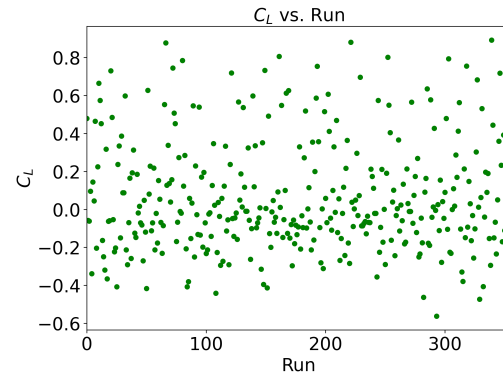

(d) Variation of lift coefficient against run number

Figure 7: Variation of mean streamwise velocity and force coefficients across a sample of the dataset

## Dataset description

The dataset follows the same structure as two concurrently developed datasets; AhmedML [10] and DrivAerML [14]. A summary of the dataset is provided in Table 3 (see SI for full details). The purpose of the dataset is to provide a rich dataset to support the development of a broad range of potential ML approaches. For this reason, we provide all possible outputs such as the full volume flow-field, the boundary surface, images of the flow-field as well as the time-averaged force and moment coefficients. All the outputs are provided in commonly used open-source formats (vtu, vtu etc) which allow for the the broadest compatibility and ease of use for developers.

## Limitations of the dataset

Whilst this high-fidelity, large-scale dataset has numerous benefits over prior work that was based upon lower-fidelity methods, there are a number of limitations:



- The dataset has purely geometrical differences with no variation in boundary conditions. Extending the dataset to include boundary condition changes, such as the inflow velocity, would help ML developers to use this dataset for more than just geometry prediction.
- Whilst the Windsor body improves over the Ahmed car body it lacks the complexity of a real-life vehicle (addressed by the upcoming related DrivAerML dataset [14])
- The dataset only includes time-averaged data rather than time-series. Future work could be to extend the dataset to also include a limited number of transient outputs i.e volume/boundary outputs at each time-step.

Table 3: Summary of the dataset contents

Output	Description
Per run (inside each run_i folder)	
windsor_i.stl	surface mesh of the windsor body geometry
windsor_i.stp	surface CAD of the windsor body geometry
boundary_i.vtu	time-averaged flow quantities (Pressure Coefficient, Skin-Friction Coefficient, $y^+$ ) on the Windsor car body surface
volume_i.vtu	time-averaged flow quantities (pressure, velocity, Reynolds Stresses, Turbulent Kinetic Energy) within the domain volume
force_mom_i.csv	time-averaged drag, & lift, side-force and pitching moment coefficients using constant $A_{ref}$ & $L_{ref}$
force_mom_varref_i.csv	time-averaged drag, & lift, side-force and pitching moment coefficients using case-dependant $A_{ref}$
geo_parameters_i.csv	parameters that define the shape (in mm)
images	folder containing .png images of Reynolds stresses, streamwise velocity and pressure in $X, Y, Z$ slices through the volume
Other	
force_mom_all.csv	time-averaged drag & lift for all runs
force_mom_varref_all.csv	time-averaged drag & lift using case-dependant $A_{ref}$ for all runs
geo_parameters_all.csv	parameters that define the shape for all runs

## Conclusions

In this paper, we present a new large-scale, open-source Computational Fluid Dynamics dataset based upon 355 geometry variants of the automotive Windsor body. The flow conditions are fixed and seven geometric parameters of interest to automotive designers are varied. The CFD simulations use a high-fidelity, time-accurate scale-resolving approach to ensure accurate prediction of the underlying flow structures. The dataset uses widely used open-source formats and contains the vehicle geometries, time averaged integrated forces, time averaged vehicle surface data and time average volumetric flowfield data. It is hoped that this open-source dataset will allow for faster development of data-driven and physics-driven ML approaches for vehicle aerodynamics prediction.

## Acknowledgments and Disclosure of Funding

Thank you to members of the AutoCFD4 AI/ML TFG for early feedback on the dataset. Thank you to Nate Chadwick, Peter Yu, Mariano Lizarraga, Pablo Hermoso Moreno, Shreyas Subramanian and Vidyasagar Ananthan from Amazon Web Services for the useful contributions and feedback as well as debugging of the dataset in preparation for release. Also, thank you to Bernie Wang for providing additional feedback on the paper itself.

## References

- [1] Ananthan, V., Ashton, N., Chadwick, N., Lizarraga, M., Maddix, D. C., Maheswaran, S., Moreno, P. H., Shabestari, P. M., Sovani, S., Subramanian, S., Tadepalli, S., and Yu, P., "Machine Learning for Road Vehicle Aerodynamics," *SAE World Congress*, 2024.
- [2] Vinuesa, R. and Brunton, S. L., "Emerging Trends in Machine Learning for Computational Fluid Dynamics," *Computing in Science & Engineering*, Vol. 24, No. 5, 2022, pp. 33–41.
- [3] El Haber, G., Viquerat, J., Larcher, A., Alves, J., Costes, F., Perchat, E., and Hachem, E., "Deep learning model for two-fluid flows," *Physics of Fluids*, Vol. 35, No. 2, 2023.
- [4] Lino, M., Fotiadis, S., Bharath, A. A., and Cantwell, C. D., "Current and emerging deep-learning methods for the simulation of fluid dynamics," *Proc. R. Soc. A.*, 2023.
- [5] Li, Z., Kovachki, N. B., Choy, C., Li, B., Kossaifi, J., Otta, S. P., Nabian, M. A., Stadler, M., Hundt, C., Azizzadenesheli, K., and Anandkumar, A., "Geometry-Informed Neural Operator for Large-Scale 3D PDEs," *Arxiv.org*, 2023.
- [6] Bonnet, F., Mazari, A. J., Cinnella, P., and Gallinari, P., "AirfRANS: High Fidelity Computational Fluid Dynamics Dataset for Approximating Reynolds-Averaged Navier-Stokes Solutions," *Arxiv.org*, 2022.
- [7] Jacob, S. J., Mrosek, M., Othmer, C., and Köstler, H., "Deep Learning for Real-Time Aerodynamic Evaluations of Arbitrary Vehicle Shapes," *SAE International Journal of Passenger Vehicle Systems*, Vol. 15, No. 2, 2022, pp. 15–15.
- [8] Elrefaie, M., Dai, A., and Ahmed, F., "DrivAerNet: A Parametric Car Dataset for Data-Driven Aerodynamic Design and Graph-Based Drag Prediction," *Arxiv.org*, 2024.
- [9] Baqué, P., Remelli, E., Fleuret, F., and Fua, P., "Geodesic Convolutional Shape Optimization," *Arxiv.org*, 2018.
- [10] Ashton, N., Maddix, D., Gundry, S., and Shabestari, P., "AhmedML - High-Fidelity Computational Fluid Dynamics Dataset for Incompressible, Low-Speed Bluff Body Aerodynamics," *Arxiv.org*, 2024.
- [11] Hupertz, B., Lewington, N., Mockett, C., Ashton, N., and Duan, L., "Towards a Standardized Assessment of Automotive Aerodynamic CFD Prediction Capability - AutoCFD 2: Ford DrivAer Test Case Summary," *SAE Technical Papers*, 2022.
- [12] Varney, M., *Base drag reduction for squareback road vehicles*, Ph.D. thesis, 2020.
- [13] Page, G. J. and Walle, A., "Towards a Standardized Assessment of Automotive Aerodynamic CFD Prediction Capability - AutoCFD 2: Windsor Body Test Case Summary," *SAE Technical Papers*, 2022.
- [14] Ashton, N., Mockett, C., Fuchs, M., Fliessbach, L., Hetmann, H., Knacke, T., Schonwald, N., Skaperdas, V., Fotiadis, G., Walle, A., Hupertz, B., and Maddix, D., "DrivAerML - High-Fidelity Computational Fluid Dynamics Dataset for Road-Car External Aerodynamics," *In Review*, 2024.
- [15] Lienhart, H. and Becker, S., "Flow and turbulent structure in the wake of a simplified car model," *SAE*, Vol. 01, 2003.

- [16] Ahmed, S. R., Ramm, G., and Faltin, G., “Some salient features of the time averaged ground vehicle wake,” *SAE-Paper 840300*, 1984.
- [17] Meile, W., Brenn, G., Reppenhagen, A., Lechner, B., and Fuchs, A., “Experiments and numerical simulations on the aerodynamics of the Ahmed body,” Tech. Rep. 1, 2011.
- [18] Ashton, N. and Revell, A., “Key factors in the use of DDES for the flow around a simplified car,” *International Journal of Heat and Fluid Flow*, Vol. 54, 2015, pp. 236–249.
- [19] Volpe, R., Devinant, P., and Kourta, A., “Experimental characterization of the unsteady natural wake of the full-scale square back Ahmed body: flow bi-stability and spectral analysis,” *Experiments in Fluids*, Vol. 56, No. 5, 2015, pp. 1–22.
- [20] Gottlieb, S. and Shu, C.-W., “Total variation diminishing Runge-Kutta schemes,” *Mathematics of computation*, Vol. 67, No. 221, 1998, pp. 73–85.
- [21] Vreman, A., “An eddy-viscosity subgrid-scale model for turbulent shear flow: Algebraic theory and applications,” *Physics of fluids*, Vol. 16, No. 10, 2004, pp. 3670–3681.
- [22] Shalev, L., Ayoub, H., Bshara, N., and Sabbag, E., “A Cloud-Optimized Transport Protocol for Elastic and Scalable HPC,” *IEEE Micro*, Vol. 40, No. 6, 2020, pp. 67–73.

---

## WindsorML - Supplementary Information

---

**Neil Ashton**  
Amazon Web Services  
60 Holborn Viaduct  
London, EC1A 2FD  
neashton@amazon.com

**Jordan B. Angel**  
Volcano Platforms Inc.  
Stanford Research Park, 3240 Hillview Ave  
Palo Alto, CA 94304

**Aditya S. Ghatge**  
Volcano Platforms Inc.  
Stanford Research Park, 3240 Hillview Ave  
Palo Alto, CA 94304

**Gaetan K. W. Kenway**  
Volcano Platforms Inc.  
Stanford Research Park, 3240 Hillview Ave  
Palo Alto, CA 94304

**Man Long Wong**  
Volcano Platforms Inc.  
Stanford Research Park, 3240 Hillview Ave  
Palo Alto, CA 94304

**Cetin Kiris**  
Volcano Platforms Inc.  
Stanford Research Park, 3240 Hillview Ave  
Palo Alto, CA 94304

**Astrid Walle**  
Siemens Energy  
Huttenstraße 12, 10553  
Berlin, Germany

**Danielle C. Maddix**  
AWS AI Labs  
2795 Augustine Dr.,  
Santa Clara, CA 95054, United States

**Gary Page**  
Loughborough University  
Epinal Way, Loughborough  
LE11 3TU, United Kingdom

# Contents

<b>A Numerical methodology</b>	<b>2</b>
A.1 Large Eddy Simulations . . . . .	2
A.2 Discretization . . . . .	3
<b>B Dataset</b>	<b>4</b>
B.1 Licensing terms . . . . .	4
B.2 Access to dataset . . . . .	4
B.3 Long-term hosting/maintenance plan . . . . .	4
B.4 Intended use . . . . .	4
B.5 DOI . . . . .	4
B.6 Dataset contents . . . . .	5
B.6.1 Cartesian to Unstructured output . . . . .	5
B.6.2 Time-Averaging . . . . .	5
B.6.3 Force Coefficients . . . . .	5
B.6.4 Boundary data . . . . .	6
B.6.5 Volume data . . . . .	6
B.6.6 Images . . . . .	6
B.6.7 Data formats . . . . .	6
B.7 Geometry variants . . . . .	8
<b>C Additional Validation details</b>	<b>15</b>
<b>D Datasheet</b>	<b>20</b>
D.1 Motivation . . . . .	20
D.2 Distribution . . . . .	20
D.3 Maintenance . . . . .	20
D.4 Composition . . . . .	21
D.5 Collection Process . . . . .	21
D.6 Preprocessing/cleaning/labeling . . . . .	21
D.7 Uses . . . . .	22

## A Numerical methodology

Volcano ScaLES, a GPU-based Large Eddy Simulation (LES) solver developed by Volcano Platforms Inc. is utilized to generate this database. Volcano ScaLES solves the compressible Navier-Stokes equations on Cartesian Octree grids with solid geometries discretized using an immersed boundary method suitable for high Reynolds number flows. In this section, we cover the basic formulation along with brief details about the closure modeling being employed.

### A.1 Large Eddy Simulations

Since a compressible Navier-Stokes formulation is utilized, Favre-averaged (density weighted) flow variables are solved

$$\tilde{f} = \frac{\overline{\rho f}}{\bar{\rho}} \quad (1)$$

where the  $\bar{\cdot}$  denotes the standard LES low-pass filtering operator (with a length scale proportional to the grid spacing,  $\Delta$ ), and  $\rho$  denotes the density field. Using this combination of Favre-averaging and low-pass filtering, the conservation of mass equation can be written as

$$\frac{\partial \bar{\rho}}{\partial t} + \frac{\partial}{\partial x_i} (\bar{\rho} \tilde{u}_i) = 0 \quad (2)$$

where  $\tilde{u}_i$  is the Favre-filtered velocity field. Similarly, the momentum equation is given by

$$\frac{\partial \bar{\rho} \tilde{u}_i}{\partial t} + \frac{\partial}{\partial x_j} (\bar{\rho} \tilde{u}_i \tilde{u}_j) + \frac{\partial \bar{p}}{\partial x_i} - \frac{\partial \hat{\sigma}_{ij}}{\partial x_j} = \frac{\partial R_{ij}}{\partial x_j} \quad (3)$$

where  $\bar{p}$  is the low-pass filtered static pressure and the resolved viscous stress tensor is given by:

$$\hat{\sigma}_{ij} = 2\mu(\tilde{T}) \left( \frac{1}{2} \left( \frac{\partial \tilde{u}_i}{\partial x_j} + \frac{\partial \tilde{u}_j}{\partial x_i} \right) - \frac{1}{3} \delta_{ij} \frac{\partial \tilde{u}_k}{\partial x_k} \right) \quad (4)$$

Note that the dynamic viscosity,  $\mu$  can be expressed as a function of Favre-filtered static temperature using an appropriate law (such as the Sutherland's law). However, in the present work, this dynamic viscosity has been assumed to a spatio-temporal constant with a value determined to achieve the required Reynolds number. Static temperature,  $\tilde{T}$  is a function of the local pressure and density in accordance to the ideal gas law using a gas constant,  $R$ :

$$\tilde{T} = \frac{\overline{\rho T}}{\bar{\rho}} = \frac{\bar{P}}{R\bar{\rho}} \quad (5)$$

The term on the right-hand side of Equation 3 is the un-closed LES term that needs to be modelled,

$$R_{ij} = \bar{\rho} (\tilde{u}_i \tilde{u}_j - \tilde{u}_i \tilde{u}_j) \quad (6)$$

Note that the residual stress given above assumes that  $\hat{\sigma}_{ij} - \tilde{\sigma}_{ij}$  is negligible; this is true in high-Reynolds number flows and is exact for constant viscosity flows. Vreman's constant coefficient algebraic model[1] is used to close residual stress tensor:

$$R_{ij} = f_{\text{vreman}} \left( c_{\text{vreman}}, \Delta, \bar{\rho}, \frac{\partial \tilde{u}_i}{\partial x_j} \right) \quad (7)$$

The governing equation for conservation of total energy is given as

$$\frac{\partial \hat{e}}{\partial t} + \frac{\partial}{\partial x_j} ((\hat{e} + \bar{p}) \tilde{u}_j) + \frac{\partial \hat{q}_j}{\partial x_j} - \frac{\partial}{\partial x_j} (\hat{\sigma}_{ij} u_i) = R_e \quad (8)$$

where the unclosed terms on the right hand side represent interactions between subgrid-scale energy and the resolved scale energy. Since these terms are only relevant at high Mach numbers, the residual terms in the energy equation are modelled via just a turbulent Prandtl number and the Vreman's eddy viscosity model used for the momentum equations. The positive definiteness of the SGS eddy viscosity ensures that the numerical model for the filtered energy equation is purely dissipative, i.e. it assumes that the energy is exclusively transferred from the large scales to the small scales of motion.

$$R_e = f_{\text{vreman}}^e \left( c_{\text{vreman}}, \text{Pr}_{\text{turb}}, \Delta, \bar{\rho}, \frac{\partial \tilde{u}_i}{\partial x_j}, \frac{\partial \tilde{T}}{\partial x_j} \right) \quad (9)$$

The resolved total energy,  $\hat{e}$  can be expressed exclusively in terms of other resolved field variables as

$$\hat{e} = \frac{\bar{p}}{\gamma - 1} + \frac{1}{2} \bar{\rho} \tilde{u}_i \tilde{u}_i \quad (10)$$

## A.2 Discretization

Volcano ScaLES solves the governing LES equations using a nominally 4th order spatially accurate finite difference discretization with favorable Kinetic Energy and Entropy Consistency properties making it suitable for Large Eddy Simulations (LES) over a vast range of flow regimes. The viscous flux discretization utilizes a mix of 4th order and 2nd order discretizations with high spectral bandwidth thereby allowing further robustness for high Reynolds number flows without additional numerical dissipation via the inviscid flux numerical operator in turbulence resolving regions. Physics-based numerical sensors that are functions of local velocity gradients as well as pressure and density fluctuations allow for spatio-temporally localized use of limiters needed to capture flows with discontinuities such as shocks and steep density gradients.

A key advantage of Cartesian grids with unit aspect ratio is the use of explicit time-stepping scheme even in flows involving highly complex geometries; the perfectly isotropic grid cells near the geometry do not introduce any numerical stiffness associated with complex grid topologies. There are other significant advantages of Cartesian meshes including significantly reduced memory requirements for storing the grid as well as efficient and high accuracy in the underlying numerical formulation. The popular Strong Stability Preserving (SSP) variant of the classical 3rd order Runge–Kutta scheme developed by Gottlieb & Shu[2] is utilized for all the work presented in this paper. Geometries are represented in the numerical formulation using a ghost-cell immersed boundary algorithm capable of enforcing inviscid no-penetration boundary conditions as well as viscous skin friction with appropriate Reynolds number asymptotic properties using an equilibrium wall-model. The wall-model that provides a shear-stress constraint at the wall uses solution information interpolated via probing at a fixed distance of  $3/2\Delta$  into the fluid away from walls.

## B Dataset

### B.1 Licensing terms

The dataset is provided with the Creative Commons CC-BY-SA v4.0 license<sup>6</sup>. A full description of the license terms is provided under the following URL:

```
https://caemldatasets.s3.us-east-1.amazonaws.com/windsor/dataset/LICENSE.txt
```

### B.2 Access to dataset

The dataset is hosted on Amazon Web Services (AWS) via an Amazon S3 bucket

```
s3://caemldatasets/windsor/dataset
```

The dataset README.txt will be kept up to date for any changes to the dataset and can be found at the following URL:

```
https://caemldatasets.s3.us-east-1.amazonaws.com/windsor/dataset/README.txt
```

The dataset itself can be downloaded via the AWS Command Line Interface (CLI) tool, which is free-of-charge. An instruction about how to install the AWS CLI tool is given here: <https://docs.aws.amazon.com/cli/latest/userguide/getting-started-install.html>. After installing AWS CLI, please follow the example instructions in the README.txt on ways to download the data from Amazon S3 e.g to download all the files you can run the following (however note the dataset size is more than 20TB in total) :

```
aws s3 cp --recursive s3://caemldatasets/windsor/dataset .
```

Note 1 : If you don't have an AWS account you will need to add `-no-sign-request` within your AWS command i.e `aws s3 cp -no-sign-request -recursive etc...`

Note 2 : If you have an AWS account, please note the bucket is in `us-east-1`, so you will have the fastest download if you have your AWS service or EC2 instance running in `us-east-1`.

### B.3 Long-term hosting/maintenance plan

The data is hosted on Amazon S3 as it provides high durability, fast connectivity and is accessible without first requesting an account or credentials (only AWS CLI tools, described above, which are free to download and use). A dedicated website is currently being created for this dataset and the two associated datasets; AhmedML [3] and DrivAerML datasets [4] to help further clarify where the data is hosted and to communicate any additional mirroring sites.

### B.4 Intended use

The dataset was created with the following intended uses:

- Development and testing of data-driven or physics-driven ML surrogate models for the prediction of surface, volume and/or force coefficients
- a stepping stone dataset between the simpler AhmedML [3] and more complex DrivAerML dataset [4]
- Large-scale dataset to study bluff-body flow physics

### B.5 DOI

At present there is no specific DOI for the dataset (only for this associated paper) - however the authors are investigating ways of assigning DOI to this Amazon S3 hosted dataset.

---

<sup>6</sup><https://creativecommons.org/licenses/by-sa/4.0/deed.en>



## B.6 Dataset contents

For each geometry there is a separate folder (e.g run\_1, run\_2, ..., run\_i, etc.) , where "i" is the run number that ranges from 0 to 354. All run folders contain the same time-averaged data which is summarized in Table 4.

Table 4: Summary of the dataset contents

Output	Description
Per run (inside each run_i folder)	
windsor_i.stl	surface mesh of the windsor body geometry
windsor_i.stp	surface CAD of the windsor body geometry
boundary_i.vtu	time-averaged flow quantities (Pressure Coefficient, Skin-Friction Coefficient, $y^+$ ) on the Windsor car body surface
volume_i.vtu	time-averaged flow quantities (pressure, velocity, Reynolds Stresses, Turbulent Kinetic Energy) within the domain volume
force_mom_i.csv	time-averaged drag, & lift, side-force and pitching moment coefficients using constant $A_{ref}$ & $L_{ref}$
force_mom_varref_i.csv	time-averaged drag, & lift, side-force and pitching moment coefficients using case-dependant $A_{ref}$
geo_parameters_i.csv	parameters that define the shape (in mm)
images	folder containing .png images of Reynolds stresses, streamwise velocity and pressure in $X, Y, Z$ slices through the volume
Other	
force_mom_all.csv	time-averaged drag & lift for all runs
force_mom_varref_all.csv	time-averaged drag & lift using case-dependant $A_{ref}$ for all runs
geo_parameters_all.csv	parameters that define the shape for all runs

### B.6.1 Cartesian to Unstructured output

In order to simplify the reading of the dataset into existing tools, the Cartesian data was converted into a fully unstructured VTK mesh made of hexahedra. Solution data at cell centers of the hexahedra are averaged to cell corners accounting for block neighbor's data. This change makes the data easier to consume since VTK is widely used in the scientific community and tools to read and process these files are readily available (e.g. ParaView).

### B.6.2 Time-Averaging

The dataset only includes time-averaged data rather than time-series due to the extremely large number of time-steps that would be required to output i.e  $> 100,000$ . However future work could be to include this for a limited number of runs to help develop models to capture the time-history.

### B.6.3 Force Coefficients

The drag, lift and side-force coefficients are defined as follows (please note that for all the simulations in this work  $y$  is upwards, which differs to the original windsor work where  $z$  is upwards):

$$C_D = \frac{F_x}{0.5 \rho_\infty |U_\infty|^2 A_{ref}}, \quad C_L = \frac{F_y}{0.5 \rho_\infty |U_\infty|^2 A_{ref}}, \quad C_S = \frac{F_z}{0.5 \rho_\infty |U_\infty|^2 A_{ref}}, \quad (11)$$

Where  $F$  is the integrated force,  $A$  is the frontal area of the geometry, and  $\rho_\infty$  is the reference density (see Table 5 for reference values).

The pitching moment is defined as:

$$C_{My} = \frac{M_y}{0.5 \rho_\infty |U_\infty|^2 A_{ref} L_{ref}}, \quad (12)$$

Where  $M$  is the integrated moment,  $A_{ref}$  is the frontal area of the geometry,  $L_{ref}$  is the reference length, and  $\rho_\infty$  is the reference density (see Table 5 for reference values).

Two outputs are provided for the forces; one in which the reference area is kept constant across all details (force\_mom\_i.csv), and secondly one where it based upon the frontal-area of each different geometry variant (force\_mom\_varref\_i.csv).

#### B.6.4 Boundary data

Time-averaged surface data for nondimensional force coefficients are provided. The surface pressure coefficient  $C_p = (p - p_{ref})/q_{ref}$  where the "freestream" dynamic pressure is  $q_{ref} = \frac{1}{2} \rho_{ref} |U_{ref}|^2$  and  $p_{ref}$  is the "freestream" pressure. Similarly,  $cf_x$ ,  $cf_y$  and  $cf_z$  correspond to the wall-strear-stress tensor (units Pascal) projections in the three coordinate directions normalized by  $q_{ref}$ . Lift and drag coefficients can be computed via surface integration of the local  $C_p$ ,  $cf_x$ , etc. using a simple surface quadrature rule (rectangle-rule in the present case). Note that lift and drag use the "reference area" to normalize the differential area that shows up for surface integration.

As previously mentioned, the time-averaged quantities from the numerical sensor (measured at  $(x, y, z) = (-2 \text{ m}, 1.3 \text{ m}, 0 \text{ m})$ ) are used to normalize the force and pressure coefficients for the baseline experimental setup, but not for this particular dataset (given there is no wind-tunnel data for the geometries).

Table 5: Nominal freestream conditions and reference dimensions.

$U_{ref}$	40 m/s
$\rho_{ref}$	1.31 kg/m <sup>3</sup>
$p_{ref}$	37330.4 Pa
$A_{ref}$	0.112 m <sup>2</sup>
$L_{ref}$	0.6375 m

#### B.6.5 Volume data

The "outlet" for the tunnel is not a domain boundary for these simulations even though the volume data does not extend further. To minimize numerical reflections from the tunnel exit, the tunnel was allowed to vent into a large reservoir which is initialized with atmospheric conditions and given simple extrapolation boundary conditions far from the tunnel. This means there is no fixed pressure condition or any other boundary condition enforced at the tunnel exit.

#### B.6.6 Images

Table 7 describes the .png images that are created in  $x$ ,  $y$  and  $z$  directions to either enable ML methods to directly predict them and/or provide a quick way to inspect the flow fields.

#### B.6.7 Data formats

All provided data is in the open source format VTK (i.e. \*.vtp and \*.vtu) to ensure the broadest compatibility.

Table 6: List of output quantities in the provided dataset files, all quantities are time-averaged.

<b>volume_i.vtu</b>			
Symbol	Units	Field name	Description
$\overline{p^*}$	[m <sup>2</sup> /s <sup>2</sup> ]	pressureavg	relative kinematic pressure
$\overline{U_x}$	[m/s]	velocityxavg	velocity component in $x$
$\overline{U_y}$	[m/s]	velocityyavg	velocity component in $y$
$\overline{U_z}$	[m/s]	velocityzavg	velocity component in $z$
$\overline{u'_x u'_x}$	[m <sup>2</sup> /s <sup>2</sup> ]	reynoldsstressxx	resolved Reynolds stress xx
$\overline{u'_y u'_y}$	[m <sup>2</sup> /s <sup>2</sup> ]	reynoldsstressyy	resolved Reynolds stress yy
$\overline{u'_z u'_z}$	[m <sup>2</sup> /s <sup>2</sup> ]	reynoldsstresszz	resolved Reynolds stress zz
$\overline{u'_x u'_y}$	[m <sup>2</sup> /s <sup>2</sup> ]	reynoldsstressxy	resolved Reynolds stress xy
$\overline{u'_x u'_z}$	[m <sup>2</sup> /s <sup>2</sup> ]	reynoldsstressxz	resolved Reynolds stress xz
$\overline{u'_y u'_z}$	[m <sup>2</sup> /s <sup>2</sup> ]	reynoldsstressyz	resolved Reynolds stress yz
$\overline{k}$	[m <sup>2</sup> /s <sup>3</sup> ]	tke	turbulent kinetic energy
<b>boundary_i.vtu</b>			
Symbol	Unit	Field name	Description
$\overline{y^+}$	[-]	yplusavg	$y^+$
$\overline{C_{fx}}$	[-]	cfxavg	skin-friction coefficient in $x$
$\overline{C_{fy}}$	[-]	cfyavg	skin-friction coefficient in $y$
$\overline{C_{fz}}$	[-]	cfzavg	skin-friction coefficient in $z$
$\overline{C_p}$	[-]	cpavg	static pressure coefficient
$\overline{C_p^2}$	[-]	cpvar	static pressure variance coefficient

Table 7: Description of files within the images folder

Name	Description
pressureavg (folder)	time-averaged pressure
velocityxavg (folder)	time-averaged $x$ -component of the velocity
rstress_xx (folder)	time-averaged $xx$ -component of the Reynolds stress tensor
rstress_yy (folder)	time-averaged $yy$ -component of the Reynolds stress tensor
rstress_zz (folder)	time-averaged $zz$ -component of the Reynolds stress tensor
windsor_i.png	picture of the geometry itself
view1_constz_scan_0000-0009.png	10 slices of the above variables in $z$ from $z = -0.4$ to $0.4$
view2_constx_scan_0000-0079.png	80 slices of the above variables in $x$ from $x = -0.5$ to $1.0$
view3_consty_scan_0000-0019.png	20 slices of the above variables in $y$ from $y = 0.03$ to $0.55$

## B.7 Geometry variants

The baseline geometry is transferred into a parameterized CAD model to allow for automated sampling in the design space. The chosen sampling algorithm is a Halton sequence, which results in a quasi-random low discrepancy sequence with the advantages of being deterministic and extendable. The parameters and respective ranges are shown in Figure 8 and Table 8. The parameters were chosen to provide a suitable range of geometries that would exhibit different flow patterns e.g pressure vs geometry induced separation. The min/max values of each value were based upon engineering judgement and to avoid completely unrealistic shapes as well as avoid invalid shapes during geometry creation. The choice of 355 geometries were also based upon a mixture of computational budget as well as matching what may be possible within industry i.e how many geometries would realistically be generated within an engineering company. Future work could be to expand this dataset further if required.

The geometry choice within the dataset results in a broad range of flow physics - that is partly illustrated in Figures 11 and 12 which show the large range of drag and lift coefficients across the dataset. Figures 9 and 10 take two examples from the dataset that shows the resulting flow-field (mean streamwise velocity) for a geometry producing a high drag coefficient and another one for a low drag coefficient.

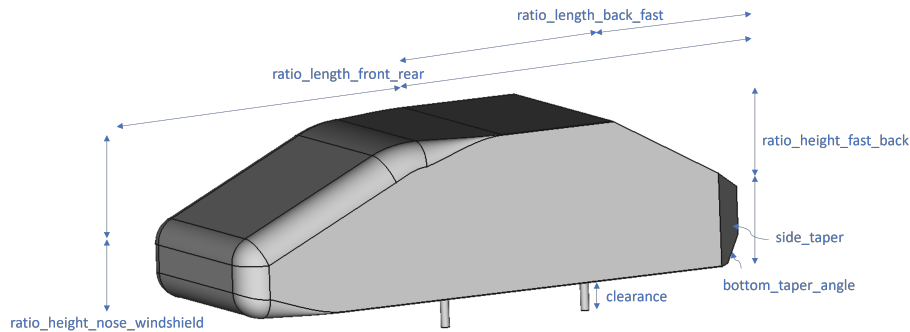

Figure 8: Parameterized CAD model

Table 8: Geometry variants of the Windsor body

Variable	Min	Max
ratio_length_front_rear	0	0.8
ratio_length_back_fast	0.08	0.5
ratio_height_nose_windshield	0.3	0.7
ratio_height_fast_back	0	0.9
side_taper [mm]	50	100
clearance [mm]	10	200
bottom_taper_angle [°]	1	50

Figures 13, 14, 15, & 16 are provided to give an illustration of the range of flow features and post-processing that makes this a rich dataset for the development and testing of ML methods.

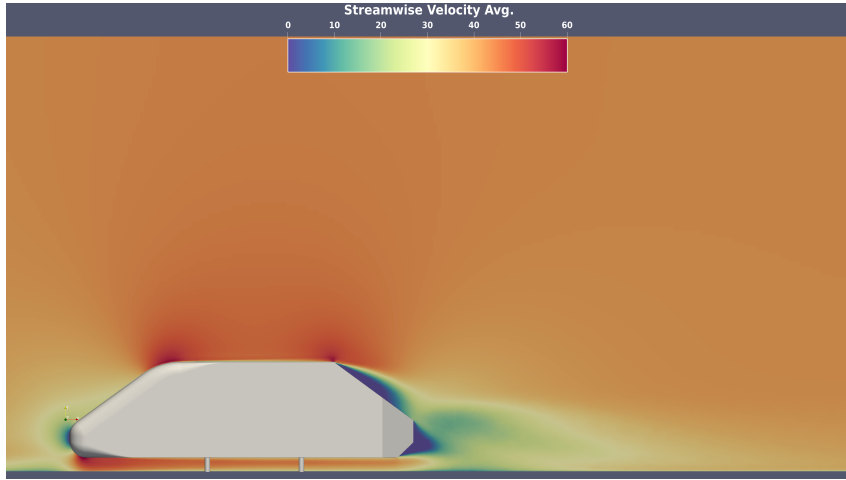

Figure 9: Mean streamwise velocity for high drag geometry variant example

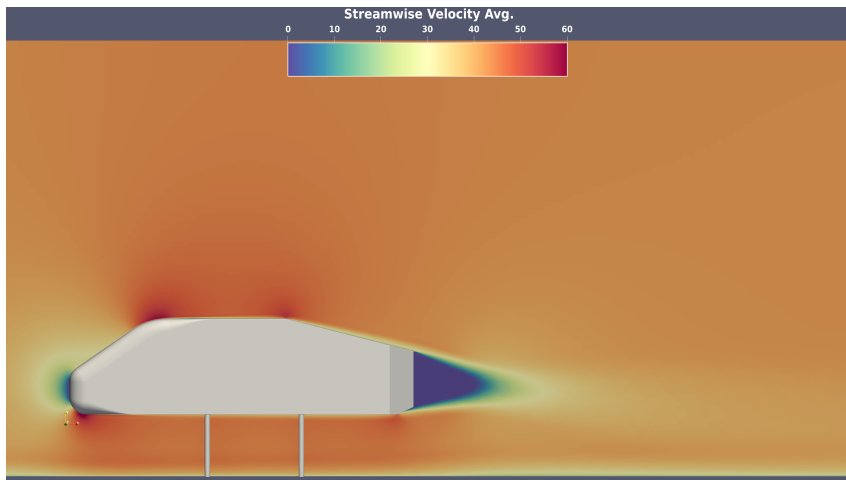

Figure 10: Mean streamwise velocity for low drag geometry variant example

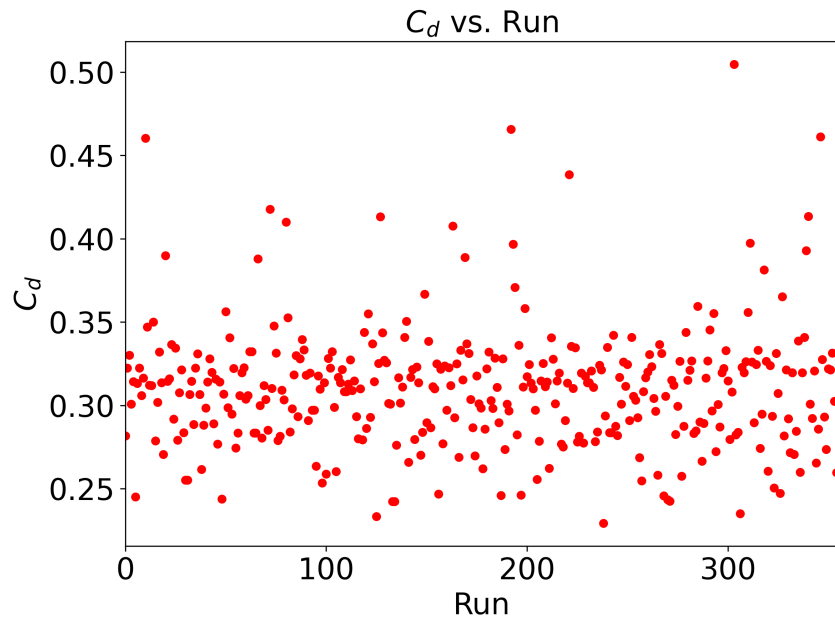

Figure 11: Variation of drag coefficient against run number

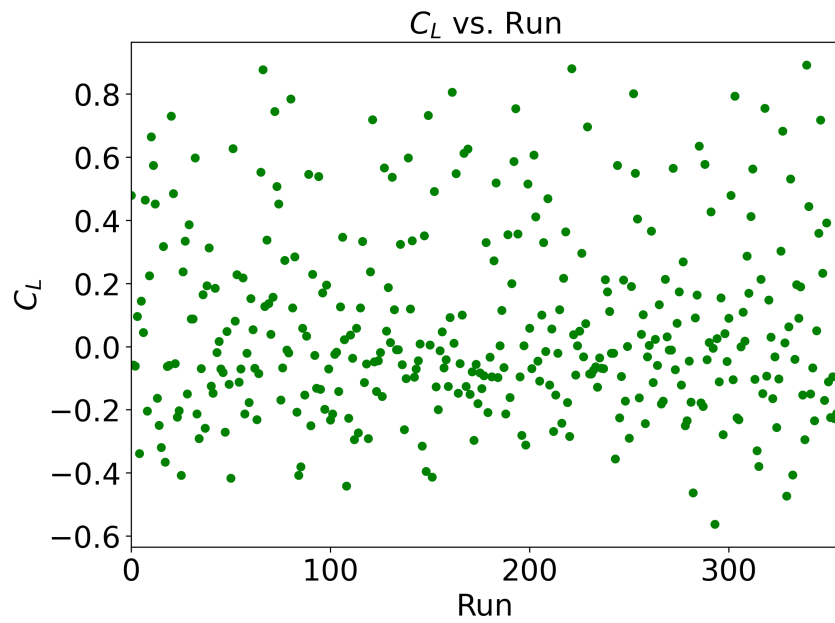

Figure 12: Variation of lift coefficient against run number

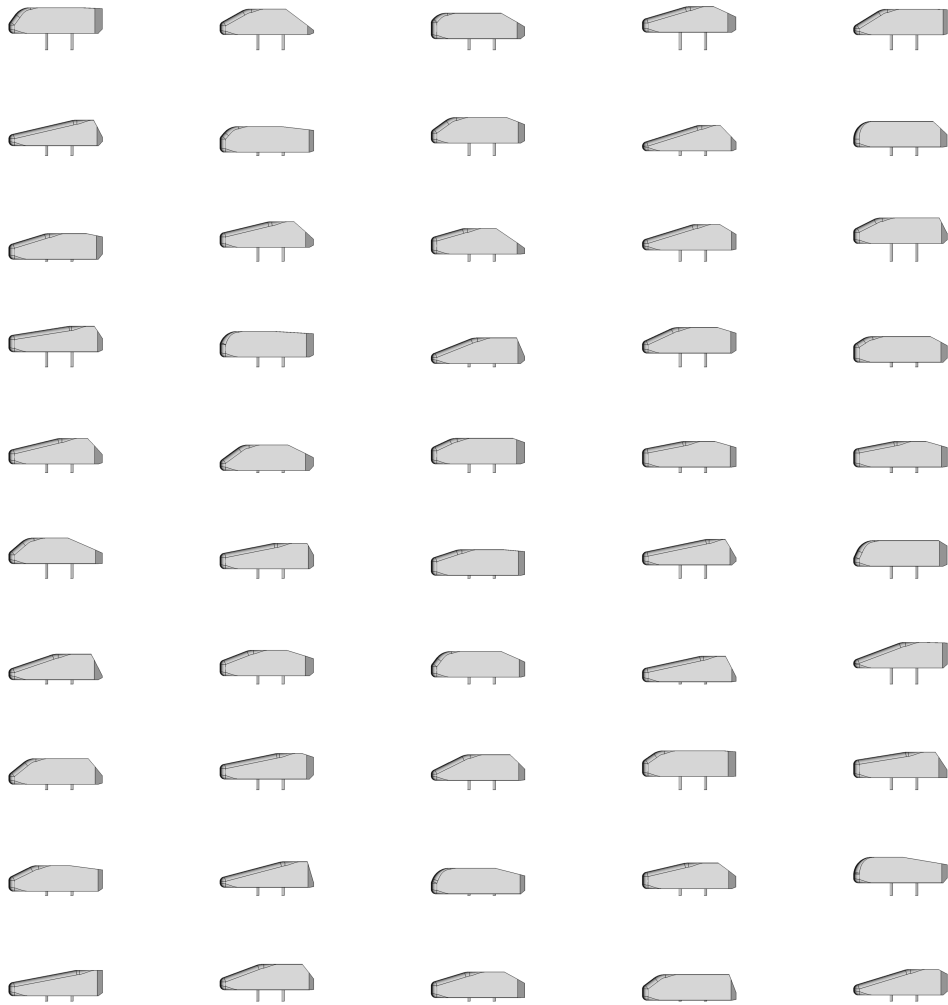

Figure 13: Image of the geometry for runs 1 to 50

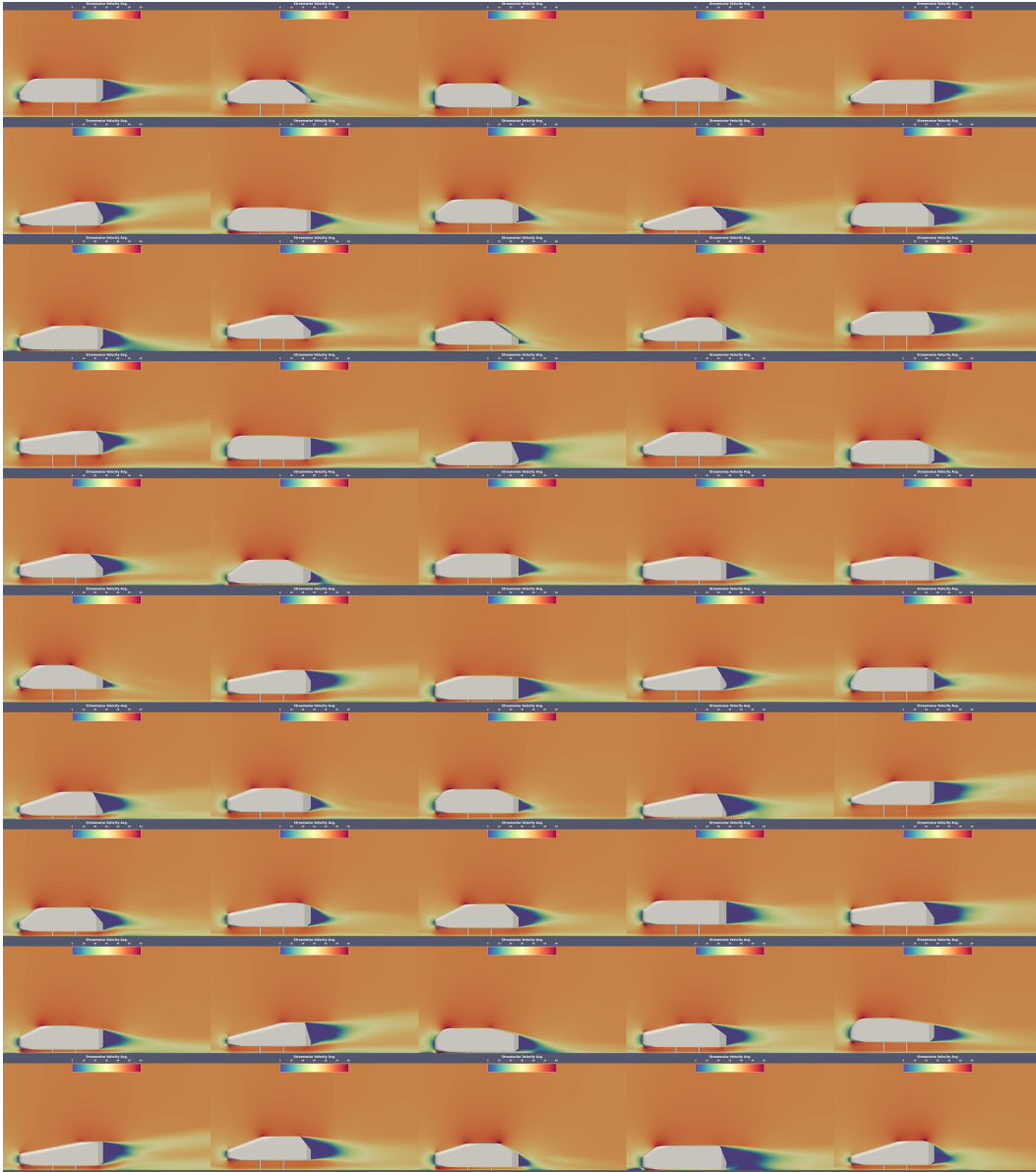

Figure 14: Mean Streamwise velocity for runs 1 to 50 at  $z = 0$



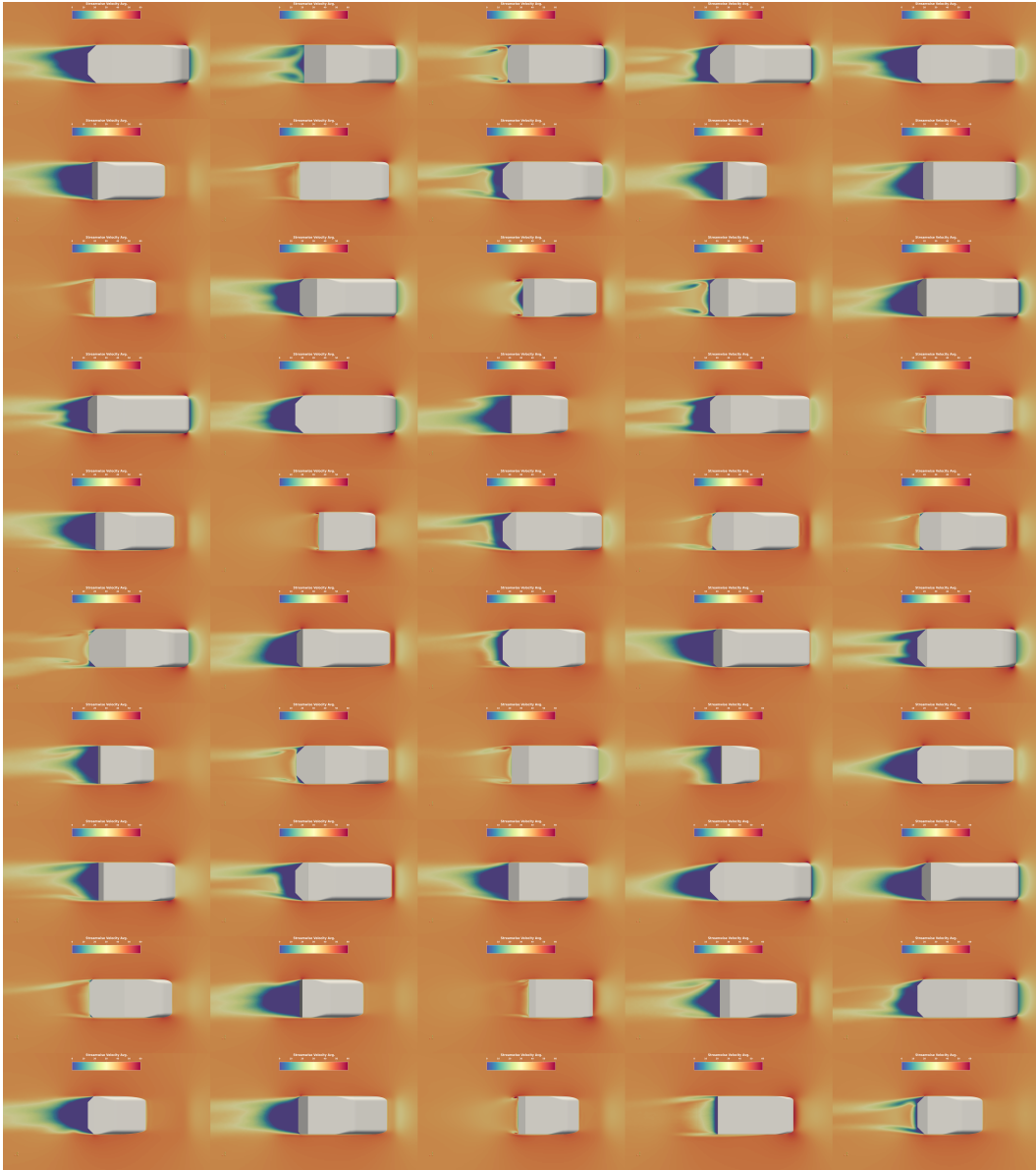

Figure 15: Mean Streamwise velocity for runs 1 to 50 at  $y = 0$

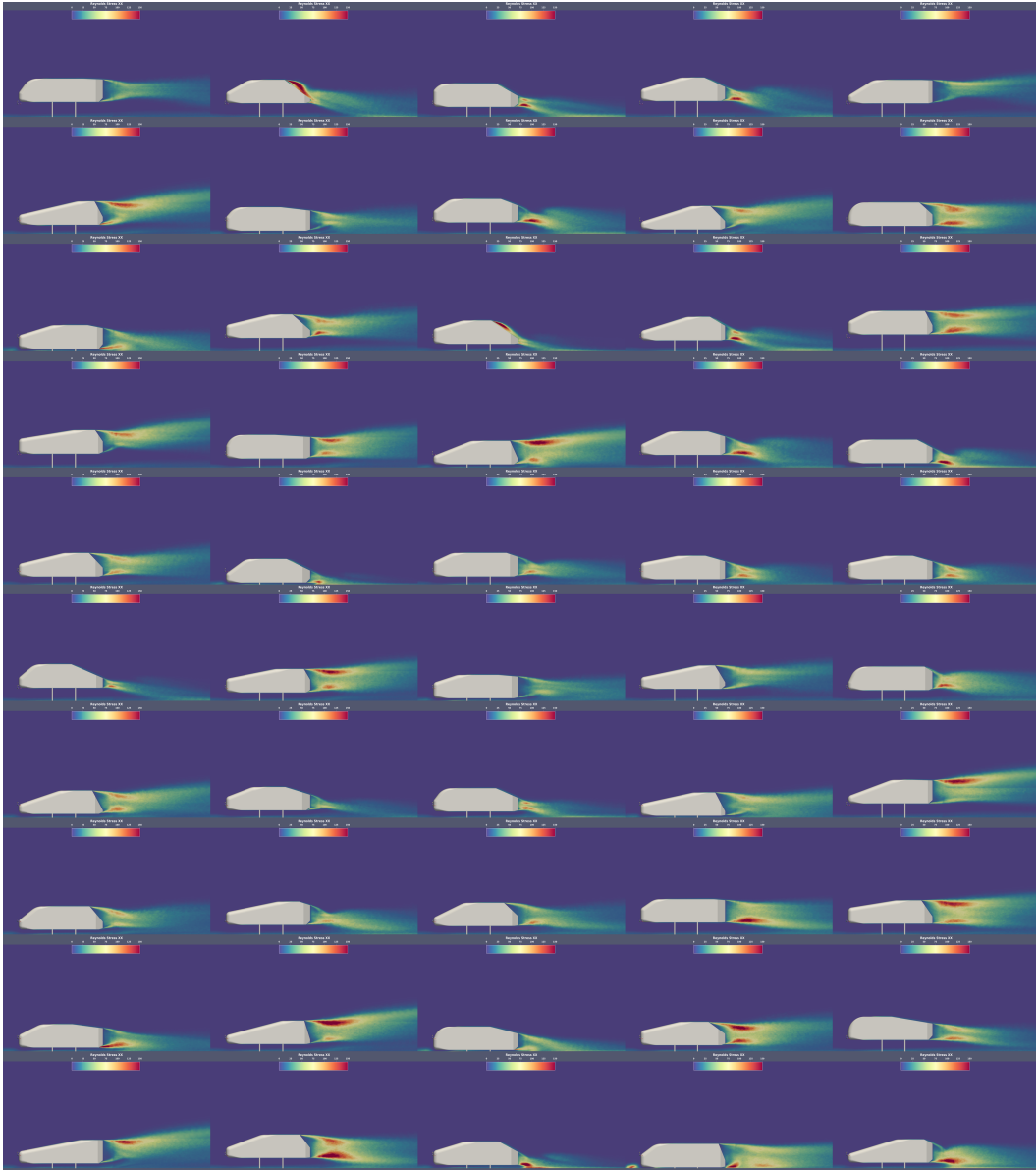

Figure 16: Mean Reynolds Stress (xx) for runs 1 to 50 at  $z = 0$

## C Additional Validation details

This sections provide some additional validation details for the Windsor body case left out of the main paper. The main paper showed grid convergence results for the drag coefficient which motivated our choice of the  $G_2$  mesh as our baseline grid. Here we consider local experimental data in the form of surface pressure measurements and velocity PIV data.

We consider an additional modification to the problem to improve efficiency. The Mach number of the problem is not actually specified but is implied for some temperature that must be assumed. This degree of freedom can be chosen to artificially increase the Mach number while keeping the Reynolds number fixed. Assuming standard atmospheric conditions implies a freestream Mach number  $M \approx 0.11$ . By instead taking the ambient temperature to be  $T \approx 100$  K, the Mach number increases to  $M = 0.2$  which increases the maximum stable timestep by 55%. Figure 23 shows the pressure coefficient comparisons for  $y = 0.2595$  m and  $z = 0$  m with the original Mach number, the increased Mach number case and the experimental data. Increasing the Mach number did not degrade the quality of the solution but significantly reduces the turn around time for each simulation considered in the dataset. Comparisons of base pressure and PIV data are shown below for the  $G_2$  grid at  $M = 0.2$ . As defined in the AutoCFD3 Case 1 problem description, a numerical sensor is placed in the tunnel and average flow quantities from this probe are used to normalize the pressure and velocities from the simulation.

**Pressure:** In Figure 17 and Figure 18, we show experimental and computed surface pressure coefficient values,  $C_p$ , for the cut planes  $z = 0$  m and  $y = 0.2595$  m respectively. For the  $z = 0$  m plane we observe stronger suction in the CFD compared to the experiment near  $x = -0.5$  m where the flow transitions, which is typical in other CFD simulations for this problem. Otherwise, there is good agreement for the upper and lower sections. For the  $y = 0.2595$  m cut, the CFD again shows a stronger suction peak this time in the A-pillar area. Small variations in the data suggest a longer averaging could be done but it would not be expected to change the agreement. Overall, the agreement is reasonably good and similar to other results seen in the AutoCFD3 results. A comparative view of the base pressure is shown in Figure 19 where similar pressure distributions are seen with a low pressure region on the leeward side of the vehicle associated with the recirculation region. The simulation results show a higher pressure that the experiment which is most evident on the  $-z$  side, however the spatial distribution of the pressure and thus the shape of the contours match well.

**Velocity:** Time-averaged streamlines colored by normalized mean streamwise velocity at  $y = 0.195$  m are shown in Figure 20 compared with experimental data from the thesis by Varney [5]. The streamlines show the large recirculation region behind the vehicle and the correct flow topology. The data for the  $y = 0.195$  m slice was taken with a freestream velocity of  $40 \text{ m s}^{-1}$  which is the same as our nominal freestream velocity but, in addition to this plane, tomographic PIV was taken for a 3D region behind the car. This data was recorded for a flow with a freestream velocity of  $30 \text{ m s}^{-1}$ . To make comparisons with the tomographic PIV data, we normalize the velocities by their freestream velocity. Figures 21 and 22 show progressive cuts through the wake going downstream. Starting nearest the car, the experiment shows a thicker shear layer but as we move downstream the predicted and experimental flow have essentially the same shear layer thickness. The overall shape of the wake region is well captured as well as its interaction with the floor boundary layer which can be seen in the velocity contours.

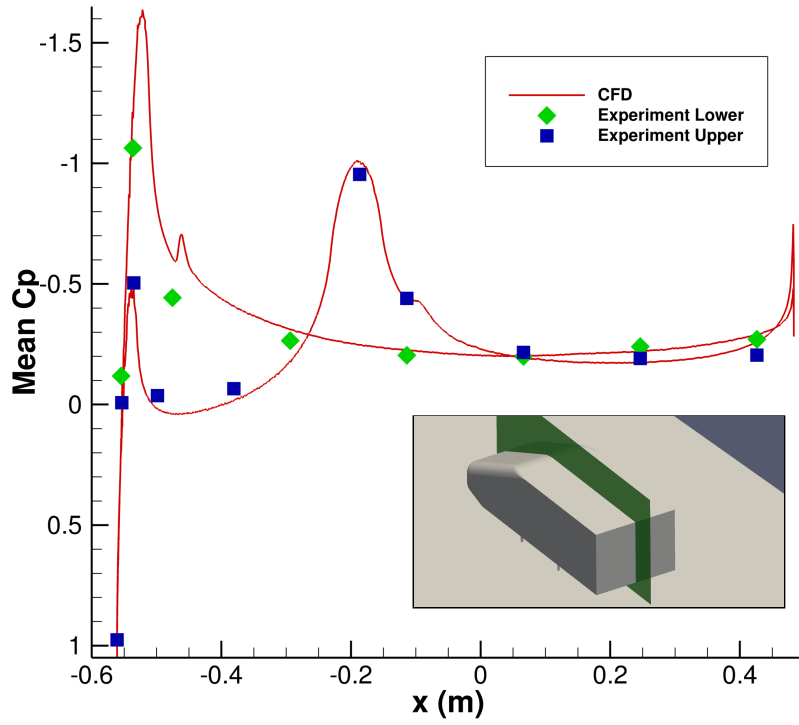

Figure 17: Comparison of mean pressure coefficient at  $z = 0$  m for the Windsor body.

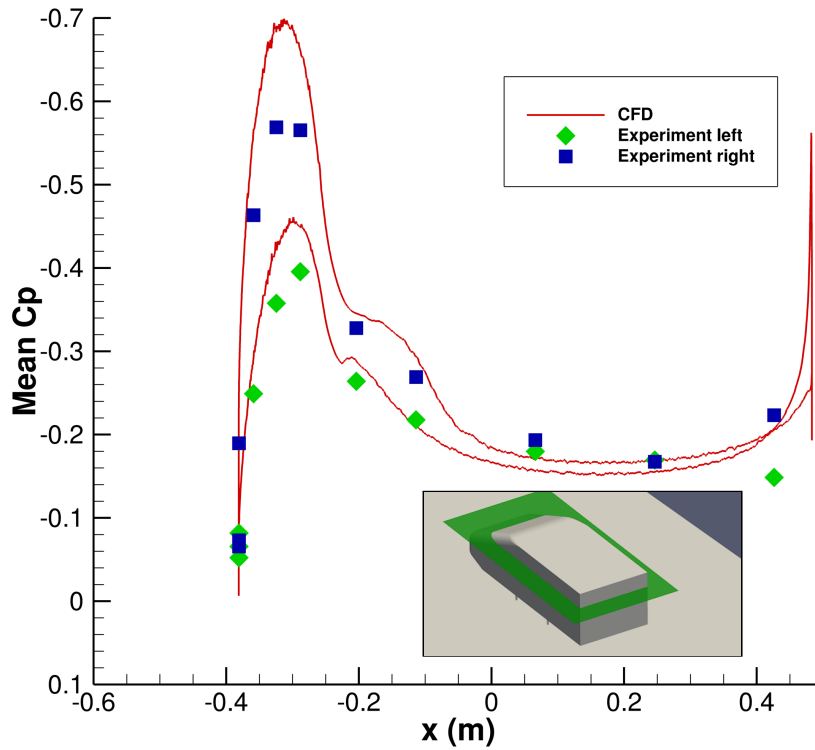

Figure 18: Comparison of pressure coefficient at  $y = 0.2595$  m for the Windsor body.

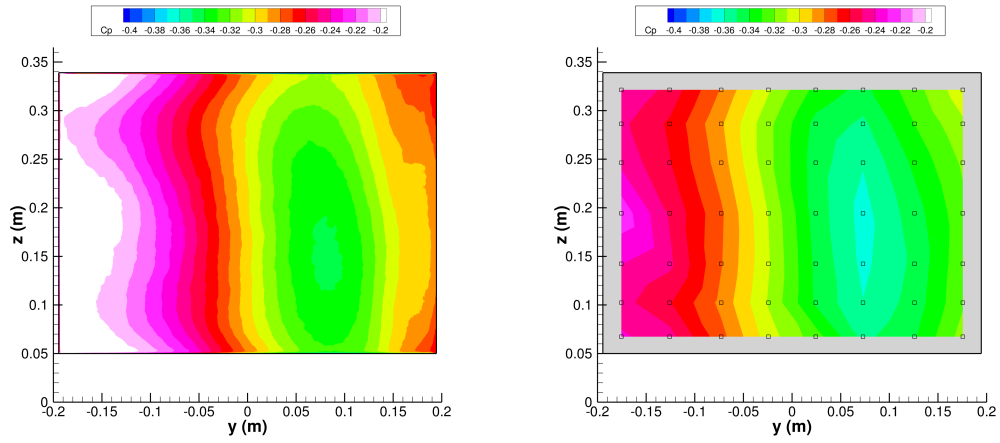

Figure 19: Left: Time-averaged pressure coefficient at the base of the Windsor body. Right: Comparison of time-averaged pressure coefficient at the base of the Windsor body.

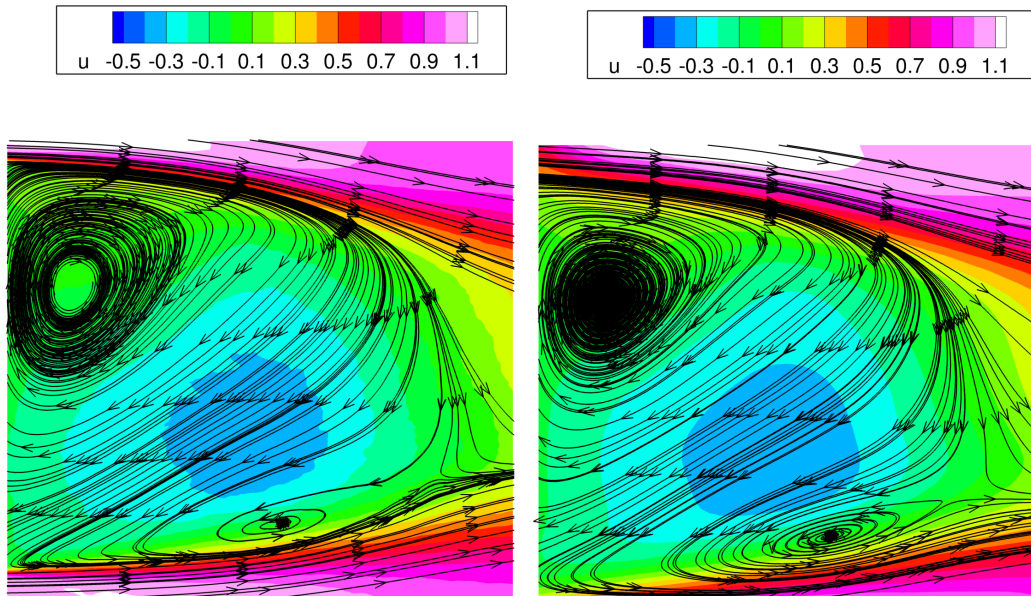

Figure 20: Comparison of mean velocity streamlines colored by normalized streamwise velocity at  $y = 0.195$  m for the Windsor body. CFD results are shown on the left and the experiment data is plotted on the right.

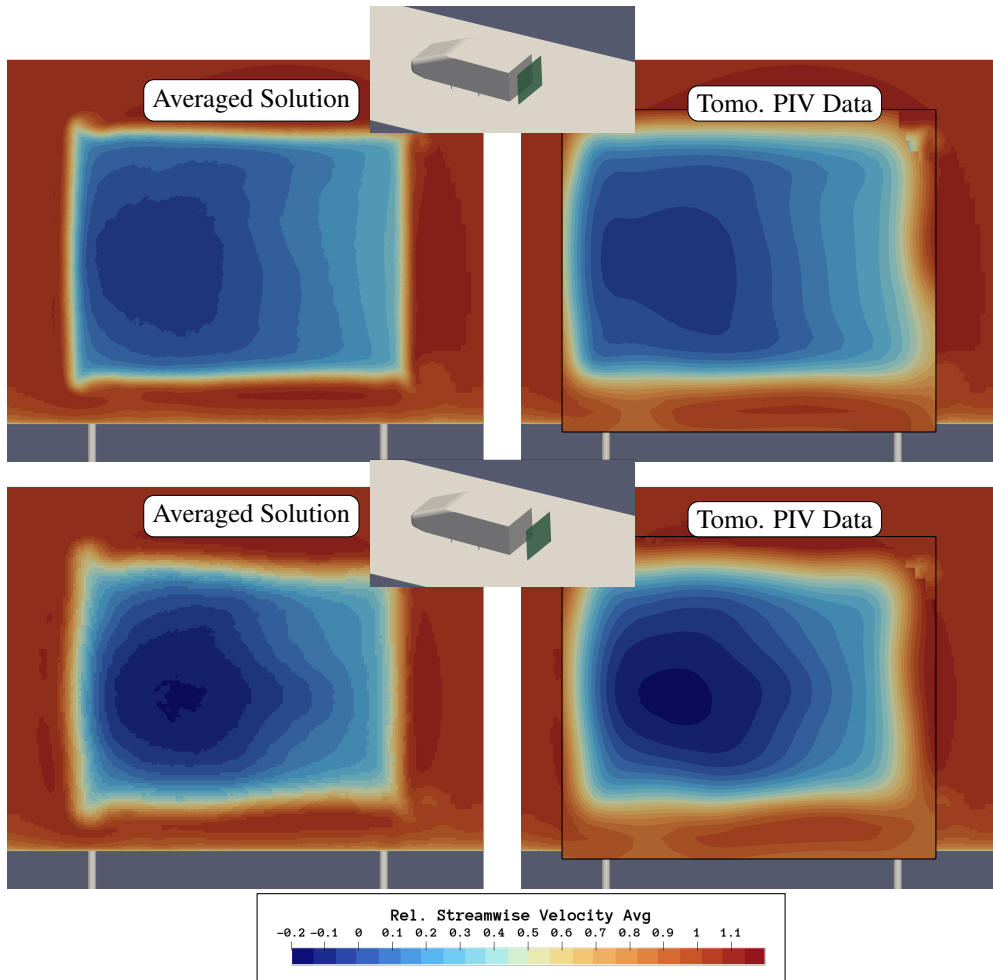

Figure 21: Time-averaged streamwise velocity at  $x = 0.578$  m (top) and  $x = 0.67048$  m (bottom).

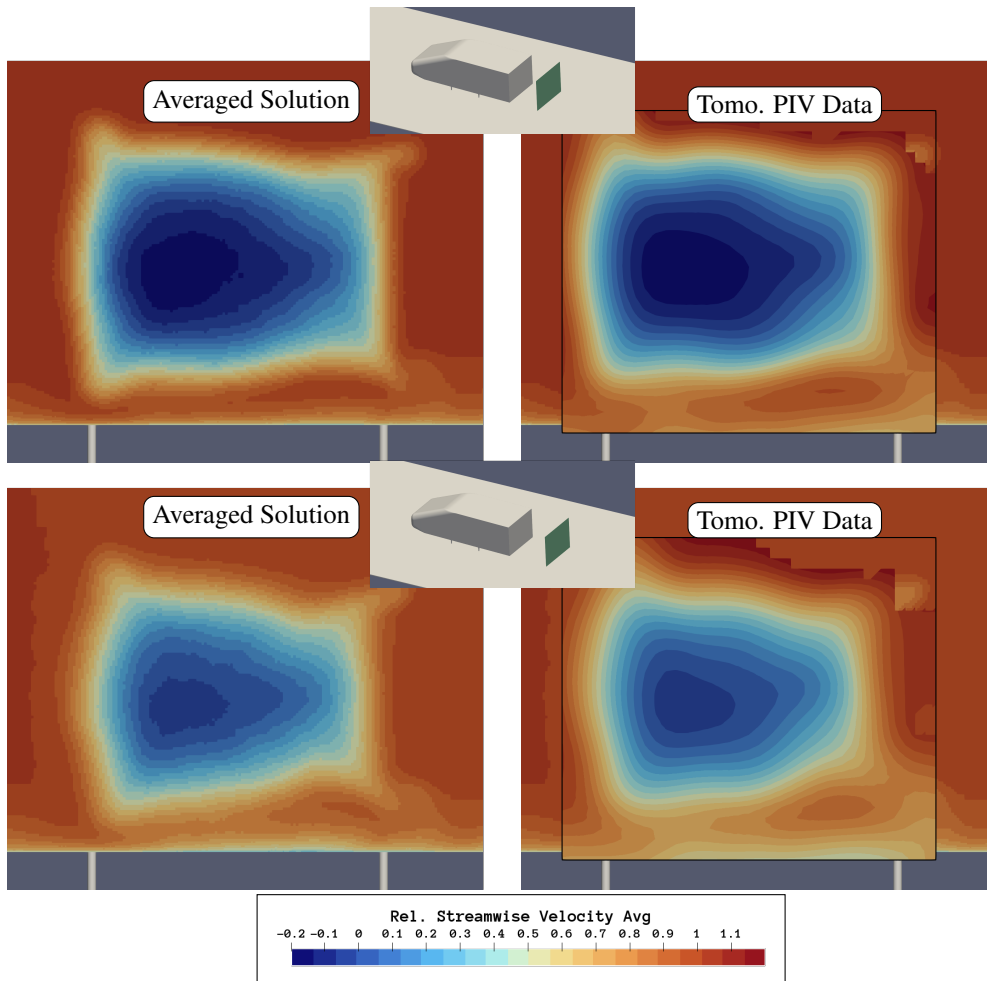

Figure 22: Time-averaged streamwise velocity at  $x = 0.774\ 52\text{ m}$  (top) and  $x = 0.867\text{ m}$  (bottom).

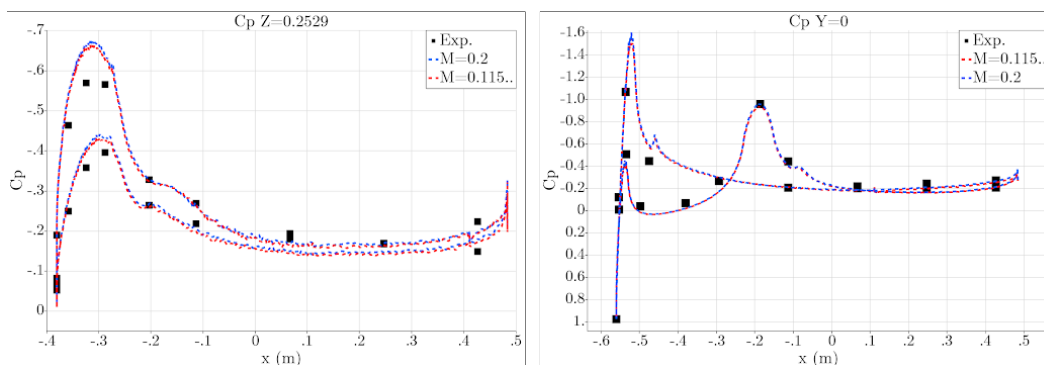

Figure 23: Comparison of pressure coefficient cuts on the Windsor body for two simulations on the same grid with different Mach numbers but the same Reynolds number. The solution is not degraded and the maximum stable time step is increased by 55% for the higher Mach number case.

## D Datasheet

### D.1 Motivation

- **For what purpose was the dataset created?** The dataset was created to address the current limitations of a lack of high-fidelity training data for the development and testing of machine learning methods for Computational Fluid Dynamics. In addition, it was created to be used as a dataset for the 4th Automotive CFD Prediction Workshop <sup>7</sup>
- **Who created the dataset (e.g., which team, research group) and on behalf of which entity (e.g., company, institution, organization)?** The dataset was created by a consortium of developers and scientists from academia and industry.
- **Who funded the creation of the dataset?** The project was internally funded within each author organisation i.e no external grants.

### D.2 Distribution

- **Will the dataset be distributed to third parties outside of the entity (e.g., company, institution, organization) on behalf of which the dataset was created?** Yes, the dataset is open to the public
- **How will the dataset will be distributed (e.g., tarball on website, API, GitHub)?** The dataset will be free to download from Amazon S3 (without the need for an AWS account).
- **When will the dataset be distributed?** The dataset is already available to download via Amazon S3.
- **Will the dataset be distributed under a copyright or other intellectual property (IP) license, and/or under applicable terms of use (ToU)?** The dataset is licensed under CC-BY-SA license.
- **Have any third parties imposed IP-based or other restrictions on the data associated with the instances?** No
- **Do any export controls or other regulatory restrictions apply to the dataset or to individual instances?** No

### D.3 Maintenance

- **Who will be supporting/hosting/maintaining the dataset?** AWS are hosting the dataset on Amazon S3
- **How can the owner/curator/manager of the dataset be contacted (e.g., email address)?** The owner/curator/manager of the dataset can be contacted at neashton@amazon.com (these are also provided in the dataset README and paper).
- **Is there an erratum?** No, but if we find errors we will provide updates to the dataset and note any changes in the dataset README.
- **Will the dataset be updated (e.g., to correct labeling errors, add new instances, delete instances)?** Yes the dataset will be updated to address errors or provided extra functionality. The README of the dataset will be updated to reflect this.
- **If the dataset relates to people, are there applicable limits on the retention of the data associated with the instances (e.g., were the individuals in question told that their data would be retained for a fixed period of time and then deleted)?** N/A
- **Will older versions of the dataset continue to be supported/hosted/maintained?** Yes, if there are substantial changes or additions, older versions will still be kept.
- **If others want to extend/augment/build on/contribute to the dataset, is there a mechanism for them to do so?** We will consider this on a case by case basis and they can contact neashton@amazon.com to discuss this further.

---

<sup>7</sup><https://autocfd.org>



#### D.4 Composition

- **What do the instances that comprise the dataset represent (e.g., documents, photos, people, countries)?** Computational Fluid Dynamics simulations.
- **How many instances are there in total (of each type, if appropriate)?** Table 3 details the specific outputs that are contained in the dataset for each of the 355 geometric variations of the windsor body.
- **Does the dataset contain all possible instances or is it a sample (not necessarily random) of instances from a larger set?** The dataset is complete collection of simulations run to date.
- **What data does each instance consist of?** Table 3 details the specific outputs that are contained in the dataset for each of the 355 geometric variations of the windsor body.
- **Is there a label or target associated with each instance?** N/A
- **Is any information missing from individual instances?** No, the dataset is fully described.
- **Are relationships between individual instances made explicit (e.g., users’ movie ratings, social network links)?** N/A
- **Are there recommended data splits (e.g., training, development/validation, testing)?** We don’t provide explicit recommendations.
- **Are there any errors, sources of noise, or redundancies in the dataset?** The errors associated with the Computational Fluid Dynamics method is discussed in the validation section of the main paper and SI.
- **Is the dataset self-contained, or does it link to or otherwise rely on external resources (e.g., websites, tweets, other datasets)?** It is self-contained.
- **Does the dataset contain data that might be considered confidential (e.g., data that is protected by legal privilege or by doctor patient confidentiality, data that includes the content of individuals’ non-public communications)?** The data is fully open-source and not considered confidential.
- **Does the dataset contain data that, if viewed directly, might be offensive, insulting, threatening, or might otherwise cause anxiety?** No

#### D.5 Collection Process

- **How was the data associated with each instance acquired?** The data was obtained through Computational Fluid Dynamics (CFD) simulations and then post-processed to extract only the required quantities.
- **What mechanisms or procedures were used to collect the data (e.g., hardware apparatus or sensor, manual human curation, software program, software API)?** The main paper discusses the HPC hardware used
- **If the dataset is a sample from a larger set, what was the sampling strategy (e.g., deterministic, probabilistic with specific sampling probabilities)?** N/A
- **Who was involved in the data collection process (e.g., students, crowdworkers, contractors) and how were they compensated (e.g., how much were crowdworkers paid)?** N/A
- **Over what timeframe was the data collected?** Simulation were run over the year of 2024.
- **Were any ethical review processes conducted (e.g., by an institutional review board)?** N/A

#### D.6 Preprocessing/cleaning/labeling

- **Was any preprocessing/cleaning/labeling of the data done (e.g., discretization or bucketing, tokenization, part-of-speech tagging, SIFT feature extraction, removal of instances, processing of missing values)?** N/A

## D.7 Uses

- **Has the dataset been used for any tasks already?** Yes, limited testing with various ML approaches has been undertaken by the author team to ensure that the data provided in the dataset is suitable for ML training and inference.
- **Is there a repository that links to any or all papers or systems that use the dataset?** No
- **What (other) tasks could the dataset be used for?** The primary focus is for ML development and testing but it could also be used for the study of turbulent flows over bluff bodies.
- **Is there anything about the composition of the dataset or the way it was collected and preprocessed/cleaned/labeled that might impact future uses?** Not to the knowledge of the authors.
- **Are there tasks for which the dataset should not be used?** No

## References

- [1] Vreman, A., “An eddy-viscosity subgrid-scale model for turbulent shear flow: Algebraic theory and applications,” *Physics of fluids*, Vol. 16, No. 10, 2004, pp. 3670–3681.
- [2] Gottlieb, S. and Shu, C.-W., “Total variation diminishing Runge-Kutta schemes,” *Mathematics of computation*, Vol. 67, No. 221, 1998, pp. 73–85.
- [3] Ashton, N., Maddix, D., Gundry, S., and Shabestari, P., “AhmedML - High-Fidelity Computational Fluid Dynamics Dataset for Incompressible, Low-Speed Bluff Body Aerodynamics,” *Arxiv.org*, 2024.
- [4] Ashton, N., Mockett, C., Fuchs, M., Fliessbach, L., Hetmann, H., Knacke, T., Schonwald, N., Skaperdas, V., Fotiadis, G., Walle, A., Hupertz, B., and Maddix, D., “DrivAerML - High-Fidelity Computational Fluid Dynamics Dataset for Road-Car External Aerodynamics,” *In Review*, 2024.
- [5] Varney, M., Passmore, M., Wittmeier, F., and Kuthada, T., “Experimental Data for the Validation of Numerical Methods: DrivAer Model,” *Fluids*, Vol. 5, No. 4, 2020, pp. 236.