MetaLLM: A High-performant and Cost-efficient Dynamic Framework for Wrapping LLMs

Quang H. Nguyen¹, Duy C. Hoang¹, Juliette Decugis¹, Saurav Manchanda²,
Nitesh V. Chawla³, Khoa D. Doan¹

¹College of Engineering and Computer Science, VinUniversity, Vietnam

²Amazon, USA

³University of Notre Dame

{quang.nh, duy.hc, juliette.d}@vinuni.edu.vn,
sauravm.kgp@gmail.com, nchawla@nd.edu, khoa.dd@vinuni.edu.vn

Abstract

The rapid progress in machine learning (ML) has brought forth many large language models (LLMs) that excel in various tasks and areas. These LLMs come with different abilities and costs in terms of computation or pricing. Since the demand for each query can vary, e.g., because of the queried domain or its complexity, defaulting to one LLM in an application is not usually the best choice, whether it is the biggest, priciest, or even the one with the best average test performance. Consequently, picking the right LLM that is both accurate and cost-effective for an application remains a challenge. In this paper, we introduce MetaLLM, a framework that dynamically and intelligently routes each query to the optimal LLM (among several available LLMs) for classification tasks, achieving significantly improved accuracy and cost-effectiveness. By framing the selection problem as a multi-armed bandit, MetaLLM balances prediction accuracy and cost efficiency under uncertainty. Our experiments, conducted on popular LLM platforms such as OpenAI’s GPT models, Amazon’s Titan, Anthropic’s Claude, and Meta’s LLaMa, showcase MetaLLM’s efficacy in real-world scenarios, laying the groundwork for future extensions beyond classification tasks¹.

1 Introduction

Large language models have shown extraordinary zero-shot capabilities in various tasks and domains, such as text classification, summarization, question answering, and chatbot [22, 1, 25, 32, 21, 29]. Recent works [13, 5, 10] suggest exhaustively scaling the model size and training data size to improve the performance of language models and provoke their emergent abilities; for example, GPT-4, with over 1.74 trillion parameters, achieves superior performance in several tasks but also incur high economic costs. While this trend of scaling language models will continue in the future, there is also a growing diversification in recent models in terms of task or (sub-)domain specialization and computational costs. Consequently, for model users, identifying which LLM is best suited for their applications has become a daunting task. When factoring in the cost constraints, either computational resources or API service pricing, this task becomes even more complex.

In this paper, we imagine a world with several LLM providers, such as OpenAI² or Amazon’s Bedrock³; each provides service access to a diverse suite of LLMs with heterogeneous capabilities and cost structures. Here, an LLM user asks an important question: *How do I select an LLM i (out of k LLMs) for optimal performance and usage cost in my application?* One option is combining

¹Our code will be published soon at <https://github.com/mail-research/MetaLLM-wrapper/>.

²<https://platform.openai.com/docs/models>

³<https://aws.amazon.com/bedrock>

multiple LLMs as seen in existing ensemble methods [12, 30], but this approach will yield significantly higher service costs; another option is cascading over a set of LLMs [4], but such an approach still requires querying the LLMs until we could find the best one. On the other hand, defaulting to a single LLM to avoid the extra cost of querying multiple models – by predicting the performance of LLMs [27, 17] – may not also be optimal; for some queries, a less expensive model may also provide correct answers. Furthermore, as different LLMs exhibit very distinctive abilities on different tasks and data distribution [12, 30], for a query, it is possible for LLM i to perform better than LLM j even though the cost of LLM i is noticeably lower than the cost of j .

In this work, we introduce a framework that wraps around a set of LLMs with diverse capabilities and brings the best performance at a more affordable cost to a user’s application. The underlying component of this framework is a multi-arm bandit algorithm that routes each query to the least expensive LLM with the correct answer for the zero-shot classification task. Essentially, we formulate the problem of selecting the “best” LLM for a query as a decision-making problem under uncertainty: when a new query arrives, the proposed framework picks an LLM to answer and observe whether the LLM provides a correct answer; the goal is to maximize the total reward – a specific trade-off between the overall performance and usage cost. Intuitively, our method prefers the LLM that has a high probability of answering a query at a low cost. Our contributions can be summarized as follows:

- We propose MetaLLM, a versatile wrapper around a suite of any off-the-shelf LLMs, for zero-shot text classification tasks. MetaLLM can intelligently choose the target LLM for each query to achieve optimal performance and cost.
- We propose an algorithm based on multi-armed bandit to tackle the routing problem in MetaLLM. This algorithm is efficient since it makes the routing decision without needing to query any LLMs.
- Our experimental results on benchmark datasets and popular API services, including OpenAI and Amazon’s Bedrock, demonstrate the ability of MetaLLM in identifying the optimal LLM in terms of cost and performance. Specifically, MetaLLM improves the accuracy of the best model by around 1% while saving up to 60% and 40% of the total price on OpenAI and Bedrock APIs, respectively.

The zero-shot text classification is an important task in many NLP applications, and LLMs are increasingly used as the predictive models for this task. Employing LLMs removes the users from several challenges when creating a text classification model from scratch, including imbalanced data, missing data, corrupted data, or zero-shot capability. While our work focuses on zero-shot classification problems, the MetaLLM framework can be extended to arbitrary language tasks by modifying the reward function to incorporate suitable metrics assessing the quality of the responses. However, we leave it for future work.

2 Related Works

Large Language Models. The emergence of large language models (LLMs) has fundamentally transformed several domains, including natural language processing, computer vision, and e-commerce, and on diverse tasks such as (zero-shot) classification, question-answering, and recommendation [20, 15, 16]. The impressive effectiveness and versatility of these LLMs have come at the price of a drastic increase in LLM sizes, along with significant computational costs and data required to train, and expensive computational resources to perform inference with them. Consequently, several companies or services are now offering users access to LLMs with diverse capabilities and heterogeneous cost structures. For instance, the costs for processing 10 million tokens are \$15, \$30, \$75, and \$80 for Titan Lite, Cohere Command-Light, Llama 2 7B, and Claude Instant, respectively, using Amazon Bedrock APIs. This abundance of API choices significantly burdens their users with the decision “*which LLM should I use?*”, as different LLM APIs are known for their diverse capabilities for the prediction tasks [14, 18, 19].

Prompt Optimization and Mixture of Experts. Fine-tuning is a standard option to improve the performance of LLMs for specific tasks. Mixture-of-Experts (MoE) [8, 26, 7, 28] trains a routing operator within the large model to enhance its performance; essentially, MoE assumes the model as a collection of “experts” (modules) and learn to route the input to the best expert. These approaches require training the LLMs, which is challenging for many users, while their single-LLM enhancements

are usually model and scenario specific. Prompting reasoning like Chain-of-Thought [32, 31, 34] or Tree of Thoughts [33] could improve the LLM performance without additional training. Both MoE and prompt-based reasoning, however, could not benefit from the large number of available LLMs, some of which could be significantly less expensive to use.

Model Ensemble. LLMs have been shown to yield diverse capabilities due to their architecture and dataset [12, 30]. Jiang et al. [12] observe that over 5000 instructions, the optimal LLM for each query significantly varies, and there is no single optimal model regardless of their size. Therefore they recommend ensembling to combine the strength of multiple LLMs for a better performance. FrugalML [2, 3] cascades multiple machine learning models by querying sequentially until getting a response with a high confidence score. Motivated by FrugalML, Chen et al. [4] exploit the full potential of LLMs by applying multiple techniques, including prompt engineering, caching, and cascading, for higher-quality answers.

Model Selection. Different from previous approaches that combine the strength of multiple models, there are some attempts to query a single LLM for each task. Hari and Thomson [9] suggest training a language model to predict the performance of LLMs and route to the model with the highest performance, which incorporates the high cost of the router. Šakota et al. [24] formulate the cost-performance trade-off as an integer linear programming (ILP) problem and use existing ILP solvers to assign appropriate LLMs for each input query. Lu et al. [17] distill the preference of off-the-shelf reward models to select the LLM that achieves the best performance, ignoring its cost. Ding et al. [6] train a router that maps easy queries to small models and hard queries to large models; however, their framework is only applicable when we have two LLMs. Recently, Hu et al. [11] proposed a benchmark to evaluate routing models by their cost and performance on downstream tasks.

Commercialized Foundation Model Services. Recently, many companies have commercialized their LLM models so that customers can apply or even fine-tune LLMs for their own use cases without heavy technical knowledge. In 2023, OpenAI released many language models, such as text-ada-001, text-babbage-001, text-curie-001, and text-davinci-002⁴, with various prices and capabilities. Their users can use these models as a chatbot, extract text embedding, or even ask them to write code. Recently, Amazon also brought forth their Bedrock APIs that allow access to several foundation generative models, including text generation, image generation, and multimodal models. Bedrock provides Amazon’s Titan models and also models from other companies, such as Anthropic, Cohere, Meta, Mistral, and Stability.

3 MetaLLM Framework

3.1 Preliminaries

Zero-shot Classification. In this paper, we employ LLMs for text classifications without additional training. Given an input sentence $x \in \mathcal{X}$, we create a prompt to ask a language model M for a label. The model gives a correct prediction if the answer $M(x)$ matches the corresponding ground-truth label y .

LLM APIs. We consider the case where the user has access to a set K of k different LLM APIs; each LLM M_i has a different capability, determined by how well M_i can answer a query x , and a cost c_i . For zero-shot classification, we represent the capability $a_i(x) \in \{0, 1\}$ of an LLM M_i on a sample x by comparing the answer to its corresponding ground-truth label: $a_i(x) = 1$ if $M_i(x) = y$. Usually, the model with a higher cost has better capability. If the user has a limited budget, they can choose less expensive models for their application. In contrast, if they require better performance, more expensive models will be more desirable. However, in general, the more expensive model is *not always* the best-performing choice for all queries [12, 30]

Problem Formulation. The goal of MetaLLM is to learn a routing function $f : \mathcal{X} \rightarrow K$ that dispatches a query x to an appropriate LLM to achieve a good response with a lower cost. For example, given a subset of LLMs, $K' \subseteq K$, that can give good responses for x , MetaLLM’s objective is to return $\arg \min_{l \in K'} c_l$. In practice, the user wants the ability to balance the performance and the usage cost, depending on the needs of their application. More specifically, given a budget b , the user

⁴These models have been deprecated since 2024-01-04.

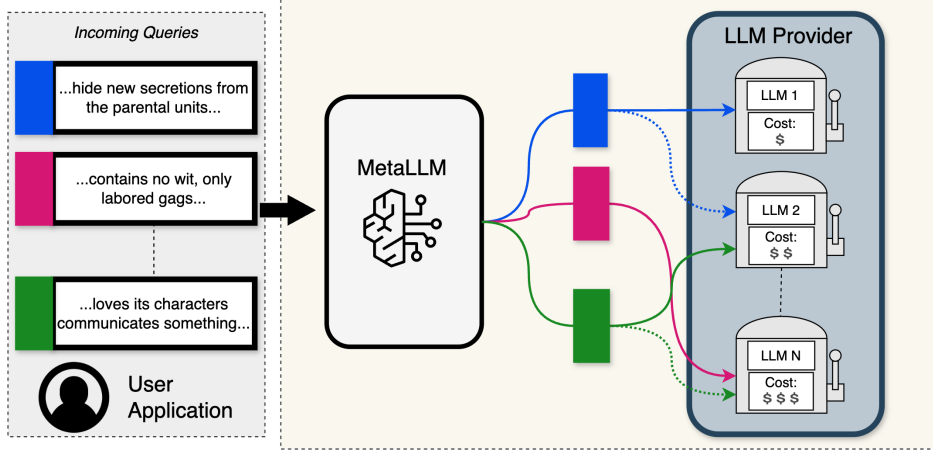

Figure 1: **The general process of serving queries in MetaLLM.** MetaLLM wraps around an existing LLM Provider, inspects each query, and then routes it to the least expensive LLM that can provide an accurate response. As an example, the **blue query** can be answered accurately by LLM 1 and LLM 2, but MetaLLM will route it to LLM 1 since it is less expensive; similarly in another example, the **green query** is routed to the least expensive LLM 2 even though LLMs 2 and 3 both can accurately answer it. The entire process is lightweight and can be performed without accessing in LLMs.

wants to maximize the performance while spending less than b to query the APIs.

$$\arg \max_f \sum_{i=1}^N a_{f(x_i)}(x_i) \quad \text{s.t.} \quad \sum_{i=1}^N c_{f(x_i)} \leq b \quad (1)$$

3.2 The optimal solution of routing objective

Let $S \in \{0, 1\}^{N \times k}$, $A \in \mathbb{R}^{N \times k}$, where S is a matrix that has $S_{i,j} = 1$ if and only if $f(x_i) = j$, and $A_{i,j} = a_j(x_i)$ is the performance of the j -th API on the sample x_i . The objective in 1 can be reformulated as follows:

$$\arg \max_S \sum_{i=1}^N \sum_{j=1}^k A_{i,j} S_{i,j} \quad \text{s.t.} \quad \sum_{i=1}^N c_{f(x_i)} \leq b. \quad (2)$$

We can relax the constraint of S to $S \in \mathbb{R}^{N \times k}$ and $\sum_{j=1}^k S_{i,j} = 1$, and its dual problem can be derived as

$$\arg \min_{p \in \mathbb{R}, q \in \mathbb{R}^N} p + \sum_i q_i \quad \text{s.t.} \quad pc_j + q_i \geq a_j(x_i) + 1. \quad (3)$$

Chen et al. [3] study similar formulation for model cascading and suggest solving the dual form 3. In the case where we have an exact accuracy matrix A , we can optimize 2 to find the optimal S and choose the suitable API j such that $S_{i,j} = 1$.

3.3 The Proposed MetaLLM

When deploying an application, we cannot know the exact accuracy of an LLM's API on a test sample before sending the test sample through this LLM. Previous works [3, 2] learn a model to predict the performance of each API. These methods cascade multiple machine learning models and query them iteratively until the response has high confidence; consequently, they are highly expensive, especially when there are a substantial number of queries.

In this work, we approach this problem from a different perspective. Instead of training an accuracy predictor, we reformulate this problem as a multi-armed bandit. Specifically, for each input query, we

define an LLM as an “arm”, and obtain a reward expressing the performance of the LLM and the cost for that query. The benefit of this formulation is twofold: first, it allows the modeler to focus on designing the reward function to capture their application needs, making the framework more versatile; second, we can take advantage of the extensive and well-developed research on multi-arm bandit, including their rigorous theoretical foundations and practical solutions. The MetaLLM framework is depicted in Figure 1.

The remaining question will discuss our design of the reward function for the zero-shot classification task. Chen et al. [3] prove that if a cost scaling $p \in \mathbb{R}$ is the solution of 3, the routing function $f(x) = \arg \max_i a_i(x) - pc_i$ will be the optimal solution of 1. Intuitively, this strategy prefers the LLM with high performance and low-cost value. Motivated by that theoretical result, we propose the following reward function for training the multi-armed bandit:

$$r(x, i) = a_i(x) - pc_i. \tag{4}$$

During training, we compute the expected reward $Q_{j'}(x; \theta)$ of each arm j' for a training sample x and choose the arm j with the highest expected reward and minimize the objective

$$\theta = \arg \min_{\theta'} \|Q_j(x_i, \theta') - (a_j(x_i) - p(c_j))\|_2^2. \tag{5}$$

During inference, MetaLLM returns the expected reward of each arm for a query and dispatches that query to the LLM with the highest reward. The training and inference algorithm for MetaLLM is illustrated in Algorithm 1.

Algorithm 1 Our MetaLLM framework

```

input k LLMs, each has cost  $c_j$  and accuracy function  $a_j(\cdot)$ , cost scaling  $p$ , parameters  $\theta$ , training
sample  $\{x_1, \dots, x_N\}$ , test query  $x$ .
output The optimal LLM for the query  $x$ .
### Training step
for s in 1..step do
  for i in 1..N do
     $j \leftarrow \arg \max_{j'} Q_{j'}(x_i; \theta)$ 
     $\theta \leftarrow \arg \min_{\theta'} \|Q_j(x_i, \theta') - (a_j(x_i) - pc_j)\|_2^2$ 
  end for
end for
### Inference step
return  $\arg \max_j Q_j(x; \theta)$ 

```

4 Experiments

In this section, we provide empirical results of MetaLLM on popular APIs and benchmark datasets.

4.1 Experimental Setup

LLM Services. We conduct our experiments with LLMs provided by popular API services, including OpenAI and Amazon’s Bedrock. We chose four models from OpenAI: text-ada-001, text-babbage-001, text-curie-001, and text-davinci-002. These models have different costs and different capabilities, giving the users diverse options. The costs of these models are shown in Table 1.

Table 1: Price of OpenAI APIs.

Model	Cost
text-ada-001	\$0.0004 / 1K tokens
text-babbage-001	\$0.0005 / 1K tokens
text-curie-001	\$0.0020 / 1K tokens
text-davinci-002	\$0.0200 / 1K tokens

Given a sample SENT, we query OpenAI models with the following prompt:

For the sentence: SENT, is the sentiment in this sentence positive or negative?

For Amazon’s Bedrock APIs, we evaluate MetaLLM with four different LLMs: Titan Lite, Cohere Command-Light, Llama 2 7B, and Claude Instant. Since these models come from different families, this evaluation setting exhibits more heterogeneity than in the setting with the OpenAI models. We summarize the cost of each APIs in Table 2.

Table 2: Price of Bedrock APIs.

Model	Cost
Titan Lite	\$0.00015 / 1K tokens
Cohere Command-Light	\$0.00030 / 1K tokens
Llama 2 7B	\$0.00075 / 1K tokens
Claude Instant	\$0.00080 / 1K tokens

Given a sample SENT, we query Bedrock APIs with the following prompt:

For the paragraph: 'SENT', is the sentiment in this paragraph positive or negative?
 Answer in one word.

Datasets. We conduct experiments on two text classification datasets: SST-2 and IMDB. SST-2 is a binary sentiment analysis dataset consisting of movie reviews; the task here is to classify whether a review is positive or negative. This dataset has 67, 439 training samples and 872 test samples; we select 100 samples from the test set to form the validation set. IMDB dataset has 25, 000 training samples and 25, 000 test samples. We also extract 2, 000 samples from the test set to build the validation set.

Table 3: The cost and accuracy of each LLM on OpenAI APIs

Method	Test cost	Test accuracy
text-ada-001	0.096	80.57
text-babbage-001	0.119	82.12
text-curie-001	0.478	90.54
text-davinci-002	4.779	90.93
MetaLLM $p = 0.03$	0.111	84.02
MetaLLM $p = 0.001$	0.325	90.98
MetaLLM $p = 0$	1.901	91.87

Training MetaLLM. For each input query, we utilize Sentence-BERT [23] model to extract an embedding vector. MetaLLM is a linear model that maps the embedding vector to the reward expectation, which is optimized with the true reward 4 and mean square loss. For a budget b , we train MetaLLM with the scaling p five times such that the cost of MetaLLM on the validation set is not higher than b and compute the accuracy of the text classification task. We normalize the cost of each LLM in the reward function such that the highest value is 1.

Evaluation. To evaluate, we compute the cost and the accuracy of MetaLLM on the test set of the classification task and compare them to each LLM candidate. We report the average cost per 10, 000 queries in all experiments.

4.2 Performance of MetaLLM on OpenAI Models

Table 3 shows the accuracy and cost of each OpenAI LLM and MetaLLM with different p on SST-2. As can be observed, the LLM with higher cost has better accuracy. Noticeably, the differences in cost between LLMs can be very high; for example, text-davinci-002 is ten times more expensive than text-curie-001 but only has 0.4% better performance in terms of accuracy. Consequently, querying only the most expensive LLM is not an optimal choice, unless the usage budget of the application is sufficiently high.

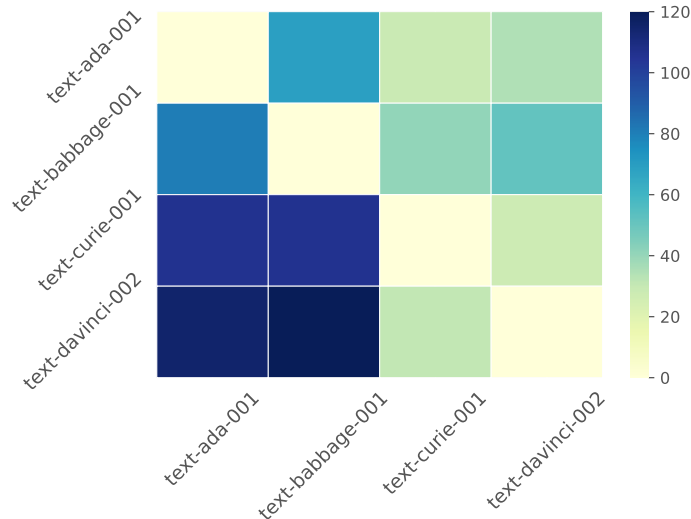

Figure 2: The number of samples can be answered by one model but not other models. Cheaper models can answer many queries that more expensive models cannot.

Performance of MetaLLM. For each LLM, except text-ada-001, we compute the cost of choosing that model only, fine-tune the scaling p on the validation set such that the cost is not higher than that budget, train MetaLLM with the found p five times and report the mean accuracy of the text classification task with LLMs selected by MetaLLM. We can observe that MetaLLM can achieve better accuracy at a lower cost. Specifically, with $p = 0.03$, MetaLLM’s performance is 2% better than that of defaulting all queries to text-babbage-001, while having a slightly less expensive cost. When $p = 0.001$, MetaLLM’s performance is better at that of defaulting to text-curie-001, with a 32% cost reduction. More importantly, MetaLLM can reach a higher performance than that of defaulting to text-davinci-002, the best LLM, while spending 60% less.

4.3 The Heterogeneous Capabilities of Different LLMs

The fact that MetaLLM can achieve better accuracy than even the most expensive OpenAI model means that an LLM’s performance can vary across queries, and cannot always determined by its usage cost (or the size of the LLM). We provide a more rigorous analysis of this observation in this section. In Figure 2, the value at position (i, j) is the number of samples that are correctly classified by the i -th model but not the j -th model. As we can observe, there are many queries that can be answered by smaller models such as text-ada-001 and text-babbage-001, while text-curie-001 and text-davinci-002 give incorrect answers. If MetaLLM can learn this property and determine the suitable LLM for a query, it will boost the accuracy of using a single model. Our analysis in Section 4.6 confirms this hypothesis.

4.4 Reward Function With Dynamic Cost

The cost of an LLM is not fixed for every input; for the zero-shot classification task, it primarily depends on the length of the query. We perform an experiment where we use the exact cost of each training input in the reward function 4 and train MetaLLM with different p . The results for this dynamic cost setting and the fixed cost are provided in Figure 3. As we can observe, using dynamic costs does not lead to significant improvements, although both strategies can achieve better accuracies and lower costs than defaulting to a single LLM. When we set a high budget, dynamic cost setting can even has lower accuracy. We hypothesize that using dynamic cost imposes greater penalties on long queries, thereby encouraging MetaLLM to route them to cheaper models; these queries are, however, more complicated and may not be effectively solved by these cheaper models. Therefore, we recommend training MetaLLM with a fixed cost in the reward function for every training query.

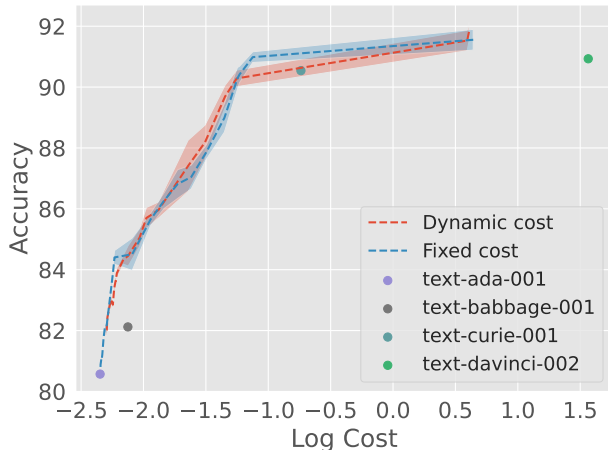

Figure 3: The cost-accuracy trade-off of MetaLLM with the cost in log scale for better visualization. MetaLLM with dynamic cost in the reward function slightly decreases the accuracy with a high budget; however both approaches can perform better than a single LLM.

4.5 Performance of MetaLLM on Bedrock APIs

This section studies the scenario where the LLMs are heterogeneous, i.e., the less expensive models can perform better on some queries than the more expensive ones. We perform this experiment using the LLMs provided by Amazon’s Bedrock and the IMDB dataset. Table 4 provides the accuracy and the cost of each approach, including defaulting to the same LLM (the first four rows) and our MetaLLM. As we can observe, when defaulting to a single LLM, a more expensive option does not guarantee a better performance; for example, defaulting to Claude Instant, the most expensive LLM, results in lower accuracies compared to other single-LLM options.

On the other hand, training MetaLLM with $p = 0$ yields the best performance on the text classification task. Setting a positive value to p decreases the cost substantially while having a minor degradation in the accuracy. Notably, MetaLLM with $p = 0.5$ achieves better performance than the best LLM, Llama 2 7B, but only incurs a minimal cost (42% less expensive). Compared to the cheapest defaulting option, i.e., Titan Lite, MetaLLM achieves more than 3% better accuracy while having comparable cost.

Table 4: The cost and accuracy of each LLM on Bedrock APIs

Method	Test cost	Test accuracy
Titan Lite	0.472	88.10
Cohere Command-Light	0.945	90.65
Llama 2 7B	2.362	91.50
Claude Instant	2.520	87.55
MetaLLM $p = 0.5$	0.485	91.59
MetaLLM $p = 0$	1.376	92.76

4.6 Analysis of MetaLLM’s Cost Scaling Parameter

In this section, we study the characteristics of MetaLLM with different values of p in the reward function. First, we consider the scenario where the user only optimizes for the performance (i.e., $p = 0$). Figure 4 shows the histogram or the frequency each OpenAI’s LLM is selected by MetaLLM, separated by the number of correct and incorrect predictions, in the SST-2 dataset. As we can observe, MetaLLM indeed can learn whether an LLM can accurately answer a query. As discussed in Section 4.3, there exist many queries that can be correctly answered by less expensive models such

as text-babbage-001, and MetaLLM chooses text-babbage-001 more often than choosing text-curie-001 or text-davinci-002 .

Figure 5 shows the histogram When putting a small regularization $p = 0.001$ on the cost component in the reward function. In this scenario, MetaLLM rarely picks text-davinci-002, while still being able to achieve 90.98% accuracy; as a reminder, this is still better than defaulting to the most expensive model, as previously observed in Table 3.

Similar observations can be made with Amazon’s Bedrock APIs (Figures 6 and 7). These experiments suggest that even when the application prioritizes performance, putting a small penalty on the cost component can still bring a financial benefit without minimal impact on performance, showing the robustness of using MetaLLM.

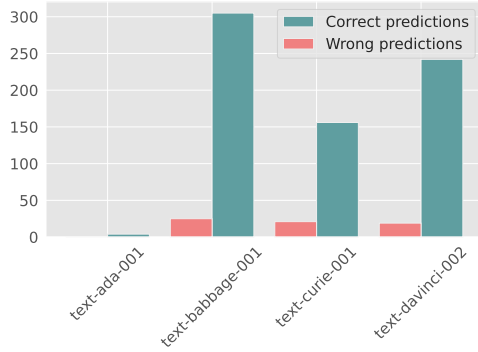

Figure 4: The histogram of OpenAI LLMs selected by MetaLLM with $p = 0$.

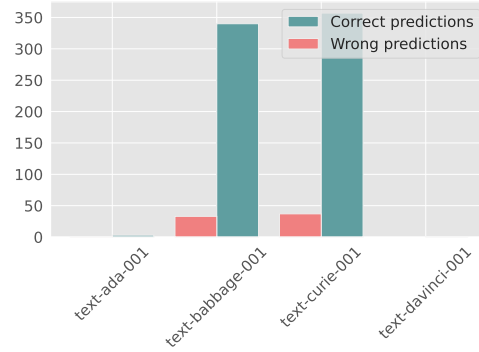

Figure 5: The histogram of OpenAI LLMs selected by MetaLLM with $p = 0.001$.

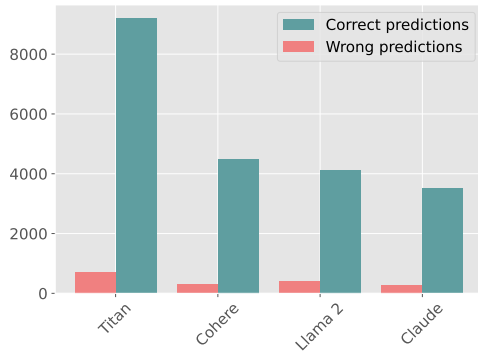

Figure 6: The histogram of Bedrock APIs selected by MetaLLM with $p = 0$.

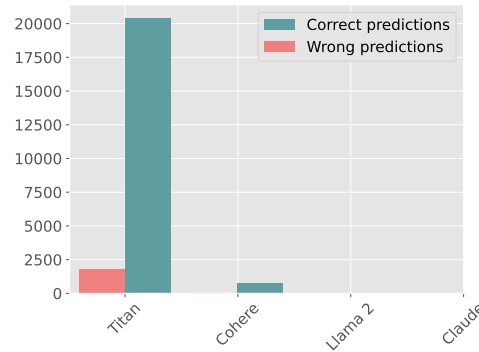

Figure 7: The histogram of Bedrock APIs selected by MetaLLM with $p = 0.5$.

5 Conclusion

In this paper, we study the problem of selecting a model in a set of LLMs for optimal performance with cost efficiency. We propose MetaLLM that employs the multi-armed bandit algorithm to learn the reward of querying the correct model with a low price. Our approach is lightweight and applicable to any set of off-the-shelf LLMs and thus versatile in practical use cases. Empirical results show that MetaLLM can improve the accuracy of the best API by around 1% while reducing the cost of zero-shot text classification tasks by 60% and 40% on OpenAI and Bedrock APIs, respectively.

6 Limitations and Societal Impacts

6.1 Limitations

As mentioned in the previous sections, we only study MetaLLM’s framework on zero-shot text classification tasks as these are important in NLP applications and increasingly utilize LLMs as the base predictors. Another reason is that it is straightforward to determine the correct LLM outputs and set up the reward function accordingly. As our paper aims to demonstrate the potential of the MetaLLM’s framework, this is sufficient.

However, the MetaLLM framework can be extended to arbitrary language tasks, such as question answering or text generation, by modifying the reward function to incorporate suitable metrics assessing the quality of the responses. Due to the complexities of designing such reward function, these directions deserve independent studies. We leave them to future work.

MetaLLM also only trains a simple linear model whose input is the extracted feature of the query, which can ignore more fine-grained features. Building a more complex reward model and utilizing other information from the query, such as the domain of the input and the demand of the user, may further facilitate better the needs of the applications and improve the performance of MetaLLM.

Finally, we optimize MetaLLM with two values in the reward function: the performance and the cost of querying the API. However, several aspects to evaluate the model in practice could be incorporated into the reward, such as the inference time, the robustness of the model, emergent abilities, or even the information on the training distribution. Combining those factors can help build a more powerful and reliable AI system for diverse purposes.

6.2 Societal Impacts

Large language models, with their emergent abilities, have transformed our lives by assisting in several tasks. However, large models come with high inference costs; therefore they are very expensive to deploy and may cause harmful effects to the environment by high power consumption. Our framework helps reduce the cost of querying LLMs substantially by routing the input to cheaper models that may return the correct answer and can even improve performance by utilizing the combination of many LLMs. MetaLLM is applicable to any set of off-the-shelf LLMs, being useful for future AI systems with more modern language models.

References

- [1] Tom Brown, Benjamin Mann, Nick Ryder, Melanie Subbiah, Jared D Kaplan, Prafulla Dhariwal, Arvind Neelakantan, Pranav Shyam, Girish Sastry, Amanda Askell, et al. Language models are few-shot learners. *Advances in neural information processing systems*, 33:1877–1901, 2020.
- [2] Lingjiao Chen, Matei Zaharia, and James Y Zou. Frugalml: How to use ml prediction apis more accurately and cheaply. *Advances in neural information processing systems*, 33:10685–10696, 2020.
- [3] Lingjiao Chen, Matei Zaharia, and James Zou. Efficient online ml api selection for multi-label classification tasks. In *International conference on machine learning*, pages 3716–3746. PMLR, 2022.
- [4] Lingjiao Chen, Matei Zaharia, and James Zou. Frugalgpt: How to use large language models while reducing cost and improving performance. *arXiv preprint arXiv:2305.05176*, 2023.
- [5] Aakanksha Chowdhery, Sharan Narang, Jacob Devlin, Maarten Bosma, Gaurav Mishra, Adam Roberts, Paul Barham, Hyung Won Chung, Charles Sutton, Sebastian Gehrmann, et al. Palm: Scaling language modeling with pathways. *Journal of Machine Learning Research*, 24(240): 1–113, 2023.
- [6] Dujian Ding, Ankur Mallick, Chi Wang, Robert Sim, Subhabrata Mukherjee, Victor Ruhle, Laks VS Lakshmanan, and Ahmed Hassan Awadallah. Hybrid llm: Cost-efficient and quality-aware query routing. In *International Conference on Learning Representations*, 2024.

- [7] Nan Du, Yanping Huang, Andrew M Dai, Simon Tong, Dmitry Lepikhin, Yuanzhong Xu, Maxim Krikun, Yanqi Zhou, Adams Wei Yu, Orhan Firat, et al. Glam: Efficient scaling of language models with mixture-of-experts. In *International Conference on Machine Learning*, pages 5547–5569. PMLR, 2022.
- [8] David Eigen, Marc’Aurelio Ranzato, and Ilya Sutskever. Learning factored representations in a deep mixture of experts. *arXiv preprint arXiv:1312.4314*, 2013.
- [9] Surya Narayanan Hari and Matt Thomson. Tryage: Real-time, intelligent routing of user prompts to large language model. *arXiv preprint arXiv:2308.11601*, 2023.
- [10] Jordan Hoffmann, Sebastian Borgeaud, Arthur Mensch, Elena Buchatskaya, Trevor Cai, Eliza Rutherford, Diego de Las Casas, Lisa Anne Hendricks, Johannes Welbl, Aidan Clark, et al. Training compute-optimal large language models. *arXiv preprint arXiv:2203.15556*, 2022.
- [11] Qitian Jason Hu, Jacob Bieker, Xiuyu Li, Nan Jiang, Benjamin Keigwin, Gaurav Ranganath, Kurt Keutzer, and Shriyash Kaustubh Upadhyay. Routerbench: A benchmark for multi-llm routing system. *arXiv preprint arXiv:2403.12031*, 2024.
- [12] Dongfu Jiang, Xiang Ren, and Bill Yuchen Lin. Llm-blender: Ensembling large language models with pairwise ranking and generative fusion. In *Proceedings of the 61st Annual Meeting of the Association for Computational Linguistics (Volume 1: Long Papers)*, pages 14165–14178, 2023.
- [13] Jared Kaplan, Sam McCandlish, Tom Henighan, Tom B Brown, Benjamin Chess, Rewon Child, Scott Gray, Alec Radford, Jeffrey Wu, and Dario Amodei. Scaling laws for neural language models. *arXiv preprint arXiv:2001.08361*, 2020.
- [14] Percy Liang, Rishi Bommasani, Tony Lee, Dimitris Tsipras, Dilara Soylu, Michihiro Yasunaga, Yian Zhang, Deepak Narayanan, Yuhuai Wu, Ananya Kumar, et al. Holistic evaluation of language models. *Transactions on Machine Learning Research*, 2023.
- [15] Peng Liu, Lemei Zhang, and Jon Atle Gulla. Pre-train, prompt, and recommendation: A comprehensive survey of language modeling paradigm adaptations in recommender systems. *Transactions of the Association for Computational Linguistics*, 11:1553–1571, 2023.
- [16] Pengfei Liu, Weizhe Yuan, Jinlan Fu, Zhengbao Jiang, Hiroaki Hayashi, and Graham Neubig. Pre-train, prompt, and predict: A systematic survey of prompting methods in natural language processing. *ACM Computing Surveys*, 55(9):1–35, 2023.
- [17] Keming Lu, Hongyi Yuan, Runji Lin, Junyang Lin, Zheng Yuan, Chang Zhou, and Jingren Zhou. Routing to the expert: Efficient reward-guided ensemble of large language models. *arXiv preprint arXiv:2311.08692*, 2023.
- [18] Ian McKenzie, Alexander Lyzhov, Alicia Parrish, Ameya Prabhu, Aaron Mueller, Najoung Kim, Sam Bowman, and Ethan Perez. Inverse scaling prize: First round winners, 2022b. URL <https://irmckenzie.co.uk/round1>.
- [19] Ian McKenzie, Alexander Lyzhov, Alicia Parrish, Ameya Prabhu, Aaron Mueller, Najoung Kim, Sam Bowman, and Ethan Perez. Inverse scaling prize: Second round winners. *Fund for Alignment Research (FAR)*, 2022.
- [20] Gaurav Menghani. Efficient deep learning: A survey on making deep learning models smaller, faster, and better. *ACM Computing Surveys*, 55(12):1–37, 2023.
- [21] Long Ouyang, Jeffrey Wu, Xu Jiang, Diogo Almeida, Carroll Wainwright, Pamela Mishkin, Chong Zhang, Sandhini Agarwal, Katarina Slama, Alex Ray, et al. Training language models to follow instructions with human feedback. *Advances in neural information processing systems*, 35:27730–27744, 2022.
- [22] Alec Radford, Jeffrey Wu, Rewon Child, David Luan, Dario Amodei, Ilya Sutskever, et al. Language models are unsupervised multitask learners. *OpenAI blog*, 1(8):9, 2019.

- [23] Nils Reimers and Iryna Gurevych. Sentence-bert: Sentence embeddings using siamese bert-networks. In *Proceedings of the 2019 Conference on Empirical Methods in Natural Language Processing and the 9th International Joint Conference on Natural Language Processing (EMNLP-IJCNLP)*, pages 3982–3992, 2019.
- [24] Marija Šakota, Maxime Peyrard, and Robert West. Fly-swat or cannon? cost-effective language model choice via meta-modeling. In *Proceedings of the 17th ACM International Conference on Web Search and Data Mining*, pages 606–615, 2024.
- [25] Timo Schick and Hinrich Schütze. Exploiting cloze-questions for few-shot text classification and natural language inference. In *Proceedings of the 16th Conference of the European Chapter of the Association for Computational Linguistics: Main Volume*, pages 255–269, 2021.
- [26] Noam Shazeer, Azalia Mirhoseini, Krzysztof Maziarz, Andy Davis, Quoc Le, Geoffrey Hinton, and Jeff Dean. Outrageously large neural networks: The sparsely-gated mixture-of-experts layer. *arXiv preprint arXiv:1701.06538*, 2017.
- [27] Tal Shnitzer, Anthony Ou, Mirian Silva, Kate Soule, Yuekai Sun, Justin Solomon, Neil Thompson, and Mikhail Yurochkin. Large language model routing with benchmark datasets. In *Annual Conference on Neural Information Processing Systems, 2023*.
- [28] Chenglei Si, Weijia Shi, Chen Zhao, Luke Zettlemoyer, and Jordan Boyd-Graber. Getting more out of mixture of language model reasoning experts. In *Findings of the Association for Computational Linguistics: EMNLP 2023*, pages 8234–8249, 2023.
- [29] Harsh Trivedi, Niranjan Balasubramanian, Tushar Khot, and Ashish Sabharwal. Interleaving retrieval with chain-of-thought reasoning for knowledge-intensive multi-step questions. In *Proceedings of the 61st Annual Meeting of the Association for Computational Linguistics (Volume 1: Long Papers)*, pages 10014–10037, 2023.
- [30] Hongyi Wang, Felipe Maia Polo, Yuekai Sun, Souvik Kundu, Eric Xing, and Mikhail Yurochkin. Fusing models with complementary expertise. In *The Twelfth International Conference on Learning Representations*, 2023.
- [31] Xuezhi Wang, Jason Wei, Dale Schuurmans, Quoc V Le, Ed H Chi, Sharan Narang, Aakanksha Chowdhery, and Denny Zhou. Self-consistency improves chain of thought reasoning in language models. In *The Eleventh International Conference on Learning Representations*, 2022.
- [32] Jason Wei, Xuezhi Wang, Dale Schuurmans, Maarten Bosma, Fei Xia, Ed Chi, Quoc V Le, Denny Zhou, et al. Chain-of-thought prompting elicits reasoning in large language models. *Advances in neural information processing systems*, 35:24824–24837, 2022.
- [33] Shunyu Yao, Dian Yu, Jeffrey Zhao, Izhak Shafran, Tom Griffiths, Yuan Cao, and Karthik Narasimhan. Tree of thoughts: Deliberate problem solving with large language models. *Advances in Neural Information Processing Systems*, 36, 2024.
- [34] Denny Zhou, Nathanael Schärli, Le Hou, Jason Wei, Nathan Scales, Xuezhi Wang, Dale Schuurmans, Claire Cui, Olivier Bousquet, Quoc V Le, et al. Least-to-most prompting enables complex reasoning in large language models. In *The Eleventh International Conference on Learning Representations*, 2022.