

Bridging the Gap in Drug Safety Data Analysis: Large Language Models for SQL Query Generation

Jeffery Painter^{1*}, Venkateswara Rao Chalamalasetti^{1,2},
Raymond Kassekert³, Andrew Bate^{4,5}

^{1*}GlaxoSmithKline, Durham, NC, USA.

²Tech Mahindra, Plano, TX, USA.

³GlaxoSmithKline, Upper Providence, PA, USA.

⁴GlaxoSmithKline, Brentford, Middlessex, UK.

⁵London School of Hygiene and Tropical Medicine, London, UK.

*Corresponding author(s). E-mail(s): jeffery.l.painter@gsk.com;
Contributing authors: venkateswararao.x.chalamalasetti@gsk.com;
raymond.x.kassekert@gsk.com; andrew.x.bate@gsk.com;

Abstract

Pharmacovigilance (PV) is essential for drug safety, primarily focusing on adverse event monitoring. Traditionally, accessing safety data required database expertise, limiting broader use. This paper introduces a novel application of Large Language Models (LLMs) to democratize database access for non-technical users. Utilizing OpenAI's GPT-4, we developed a chatbot that generates structured query language (SQL) queries from natural language, bridging the gap between domain knowledge and technical requirements. The proposed application aims for more inclusive and efficient data access, enhancing decision making in drug safety. By providing LLMs with plain language summaries of expert knowledge, our approach significantly improves query accuracy over methods relying solely on database schemas. The application of LLMs in this context not only optimizes PV data analysis, ensuring timely and precise drug safety reporting—a crucial component in adverse drug reaction monitoring—but also promotes safer pharmacological practices and informed decision making across various data intensive fields.

Keywords: Pharmacovigilance, SQL Query Generation, Large Language Models (LLMs), Drug Safety, Natural Language Processing (NLP)

1 Introduction

Drug safety, or pharmacovigilance (PV), encompasses the rigorous and ongoing assessment of the safety of medications and vaccines given to individuals as part of standard healthcare practices. It plays a crucial role in safeguarding patient well being and in deepening our comprehension of any issues that arise during the development and regular use of pharmaceuticals in healthcare settings. PV is fundamental in identifying, assessing, and minimizing the risks associated with the use of drugs, aiming to ensure that their benefits significantly outweigh any risks.

Central to PV are extensive databases that compile individual case safety reports (ICSRs), crucial for assessing drug safety and reporting to regulatory bodies. Beninger elucidates PV’s role in risk identification and the development of strategies to mitigate these risks, highlighting its intricate and multidimensional nature [1].

However, navigating these databases to generate precise SQL queries is a complex task, requiring specialized expertise due to their intricate structure. This complexity, as noted by Brass and Goldberg, arises from the mismatch between the graph-based nature of ontologies and the tabular structure of relational databases [2], often leaving users struggling to precisely articulate their search criteria. The prevalence of SQL misapplication, especially in healthcare, underscores the pressing need for enhanced query generation methods [3].

Query development in PV is further complicated by the highly regulated nature of data, which imposes strict access controls and demands significant computational resources for querying. Moreover, translating the requirements of safety scientists into SQL involves not just technical skill, but also a deep understanding of the scientific context, with potential for errors even among experts [4].

Addressing these challenges, this study explores the application of Large Language Models (LLMs), specifically OpenAI’s GPT-4[5], to facilitate database querying through natural language. This novel approach leverages a *retrieval-augmented generation* (RAG) framework, combined with a business context document, to enhance the LLM’s ability to produce SQL queries that meet specific business constraints, thus improving query accuracy and domain-specific requirement compliance. Our methodology significantly advances PV data analysis by improving the timeliness and precision of drug safety reporting, a crucial component in adverse drug reaction surveillance.

LLMs, particularly those developed on the transformative Transformer model introduced in 2017, have significantly influenced artificial intelligence and natural language processing [6]. These models offer a promising solution to the enduring challenges of database interaction in PV. By making complex database queries accessible to a broader audience, our work not only streamlines the PV data analysis process, but potentially facilitates wider access to data across various domains.

2 Background

The process of developing queries within PV databases illustrates the intricate blend of technical expertise and scientific acumen required. Translating the nuanced requests of safety scientists into precise SQL queries poses a notable challenge, with a considerable

margin for error even among seasoned professionals [4]. Historically, tools like *Query-by-Example* (QBE) have offered simplified means for crafting queries [7], yet they fall short when faced with complex or nuanced querying needs [8].

The rise and increasing recognition of LLMs in text-to-SQL generation have significantly propelled their use in database management, notably enhancing the generation of efficient and accurate SQL code [9–11]. Building upon our previous exploration into utilizing LLMs for safety documentation searches, which utilized a RAG framework alongside a Chat-GPT interface, we’ve set a foundation for this current study [12]. In this research, we introduce an innovative approach aimed at refining text-to-SQL conversions for PV databases through the integration of a *business context document*. This document distills complex database knowledge from PV systems experts into accessible, plain language and, when combined with LLMs, markedly enhances the models’ capacity to craft SQL queries that adhere closely to specific business needs. This method addresses and surmounts the challenges associated with relying solely on database metadata for query generation.

Recent assessments have cast a critical eye on the effectiveness of LLMs in text-to-SQL tasks, noting performance gaps between proprietary models like GPT-4 and open-source alternatives, especially in processing complex queries and semantic understanding [10, 13, 14]. This observation underscores the importance of supplementing LLMs with detailed contextual information to enhance query precision within the PV sector.

Central to PV are extensive safety databases, crucial for regulatory compliance and monitoring drug safety [15]. Relying on technical teams for query formulation can introduce delays, underscoring the urgency for innovative solutions that empower safety scientists with direct data access. Our work builds on the advancements in LLM technology, providing an intuitive interface that enables non-technical users to perform database queries, potentially enhancing PV data analysis and reporting processes.

While LLMs enhanced by business context documents hold promise for improving SQL query generation, the need for database experts remains crucial. They are essential for monitoring system performance, addressing errors, and managing non-systematic changes, such as updates to the database schema. In fields like PV, where accuracy is paramount, these experts play a vital role in ensuring the LLM’s outputs align with the database’s actual structure. Their involvement is indispensable for adapting to and mitigating the impacts of dynamic changes within the database environment.

In summary, our study leverages the progressive capabilities of LLMs, presenting a novel approach to address the challenges in PV database querying. By integrating LLM technology with a business context document, we aim to narrow the divide between technical complexity and domain expertise, democratizing access to crucial drug safety information.

3 Methods

Our study aims to transform natural language queries (NLQs) into syntactically precise OracleTM SQL queries, leveraging LLMs within a RAG framework, enriched by

a detailed business context. Our study unfolded in three distinct phases to assess the capability of an LLM in SQL query generation under varying conditions of database knowledge provision.

3.1 Experimental Phases

This study was conducted in three phases, each designed to assess different aspects of LLM performance in translating NLQs into SQL. The details of each phase will be elaborated below. **Phase 1** established baseline performance metrics using an exhaustive database schema. **Phase 2** evaluated the effectiveness of a business context document, which provided plain language summaries of the database structure. **Phase 3** examined whether refining the approach from Phase 1 by focusing only on essential tables could enhance or match the effectiveness demonstrated in Phase 2, thereby assessing the added value of using a business context document in the process.

Phase 1 aimed to assess the LLM’s performance when provided with exhaustive background knowledge of the database schema. This was implemented using a detailed 290-page PDF that included every table and column definition within the database, complemented by database comments that explained the function and significance of each column.

Phase 2 introduced a novel approach by utilizing a plain language summary of the database structure, rather than the comprehensive 290-page PDF used in Phase 1. This *business context document*, prepared by a database expert, not only detailed the structural elements like tables, columns, and fields but also provided contextual insights into their relevance within the operational framework of the PV database system.

Phase 3 further honed the LLM’s input by strategically narrowing down the original 290-page document used in Phase 1 to include only the tables that were identified as essential in the business context document. This refinement aimed at eliminating potential confusion caused by irrelevant or conflicting schema information from the comprehensive database documentation. This focused approach was designed to enhance the LLM’s ability to concentrate on the most pertinent data, thereby improving the effectiveness of query generation. The resultant streamlined document, reduced to a concise 29-page PDF, contained only 36 table definitions and represented about 10% of the original Phase 1 document’s size. It included all necessary data elements to comprehensively answer test set of NLQs. This phase underscored the effectiveness of using a curated subset of the database schema to optimize query accuracy and relevancy. Additionally, by comparing the performance of this refined subset with the results obtained using the business context document from Phase 2, we aimed to evaluate whether a more focused schema could perform comparably or better in generating precise SQL queries. Preliminary results indicated that while the refined Phase 3 approach did reduce confusion and streamline query processing, the business context document still provided superior context and guidance, leading to more accurate SQL generation to be addressed in the results below.

3.2 NLQ Selection

Before the experimental investigation commenced, we curated 60 NLQs from the historical user request logs, ensuring a broad representation of query complexity for a thorough assessment of the LLM’s performance. This set of queries, maintained consistently across all experimental phases, spans from simple inquiries to more complex data retrieval tasks.

To facilitate a uniform testing environment for each phase, a structured prompt was introduced to guide the LLM towards generating syntactically accurate SQL queries while minimizing the generation of unfounded responses. This approach aimed to standardize the query generation process, allowing for a fair comparison of the LLM’s performance under different conditions of database knowledge provision. The prompt provided to the chatbot was as follows:

“You are an Oracle SQL expert. Given a question, generate a syntactically correct Oracle SQL query. Avoid querying non-existent columns and pay close attention to column-table associations. For keywords in the WHERE clause, ensure case-insensitive data comparison, for example, ‘upper(STATE_NAME) = upper(‘deleted’)’. If you are unable to generate the SQL query, please state that you cannot create the query without additional information or context, do not attempt to make anything up.”

A vector-based retrieval strategy was consistently applied across all phases, leveraging embeddings from the text-embedding-ada-002 model¹. The database knowledge provided to the LLM varied across the phases: Phase 1 involved a comprehensive database schema, Phase 2 utilized a concise business context document, and Phase 3 incorporated a refined schema focusing on the essential tables identified in Phase 2. Each phase employed a character text splitter (chunk size: 1,000 characters; overlap: 200 characters; separator: ‘\n’) to facilitate the processing of input text through the GPT-4 model, as shown in Figure 1.

This structured approach ensured that each phase of the experiment was initiated with a clear, consistent framework, allowing us to evaluate the LLM’s SQL generation capabilities across a variety of informational contexts and database knowledge levels. The distinctions between each phase are elaborated upon in the sections that follow.

3.3 Phase 1 Design Details

Phase 1 of our study, outlined in the process flowchart in Figure 2, initiated with the extraction of the Oracle database schema. This extraction included details such as tables, columns, and their descriptive comments, which were compiled into a context document. Subsequently, this document was converted into a PDF to act as a comprehensive reference material. To prepare for the experiment’s execution phase, the context document underwent a process to create vector embeddings from the database schema definitions.

For the experiment, each NLQ was processed by the chatbot, supplemented with our specifically crafted prompt to guide the LLM’s response generation. The outcomes were then cataloged for a detailed evaluation by our database expert.

¹<https://platform.openai.com/docs/guides/embeddings/embedding-models>

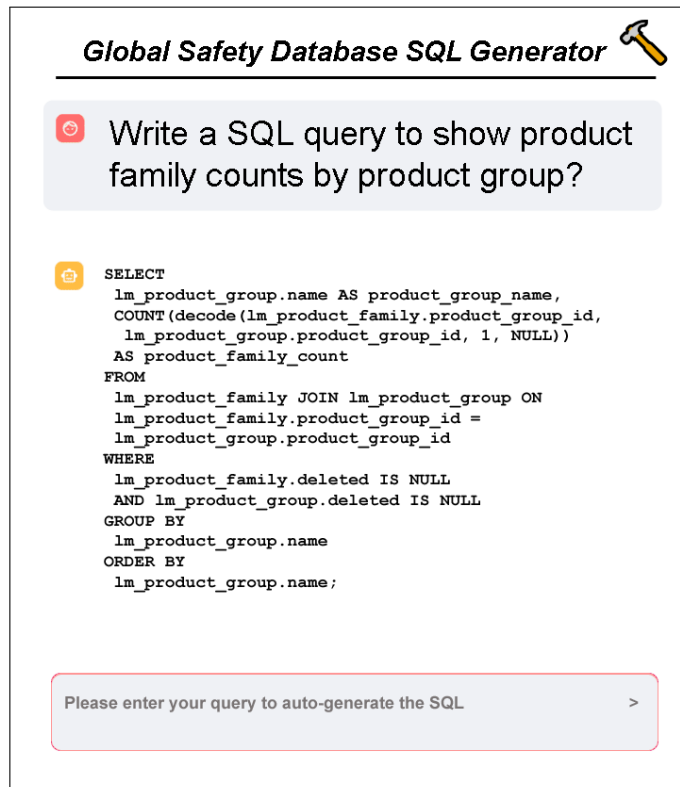

Fig. 1 LLM chatbot User Interface

The SQL queries generated during this phase were subject to a thorough review by SQL administrators, who assessed their precision and relevance. Based on this evaluation, each query's outcome was categorized as Passed, Partial, or Fail, reflecting the degree of accuracy in addressing the intended query requirements.

3.4 Phase 2 Design Details

Phase 2 closely paralleled the first, with key modifications illustrated in Figure 3. Notably, this phase integrated a newly created business context document, a resource developed by a database expert. This document, absent before this experiment, encapsulated the expert's understanding of the database's structure and its relevance to user queries, honed through years of experience. Following an initial draft, the document was iteratively refined, informed by a review of the NLQs designated for LLM processing, as delineated in Steps 1-3 of the accompanying diagram. After its completion, the business context document was processed in a manner analogous to the database schema PDF utilized in Phase 1, with the chatbot subsequently evaluating each NLQ and the resultant SQL outputs undergoing expert review and classification (Passed, Failed, or Partial Pass) as detailed in Steps 4-7.

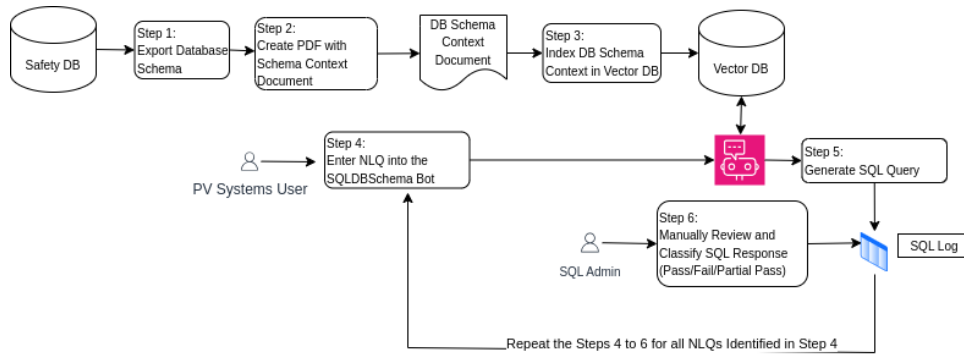

Fig. 2 Phase 1 Experimental Design

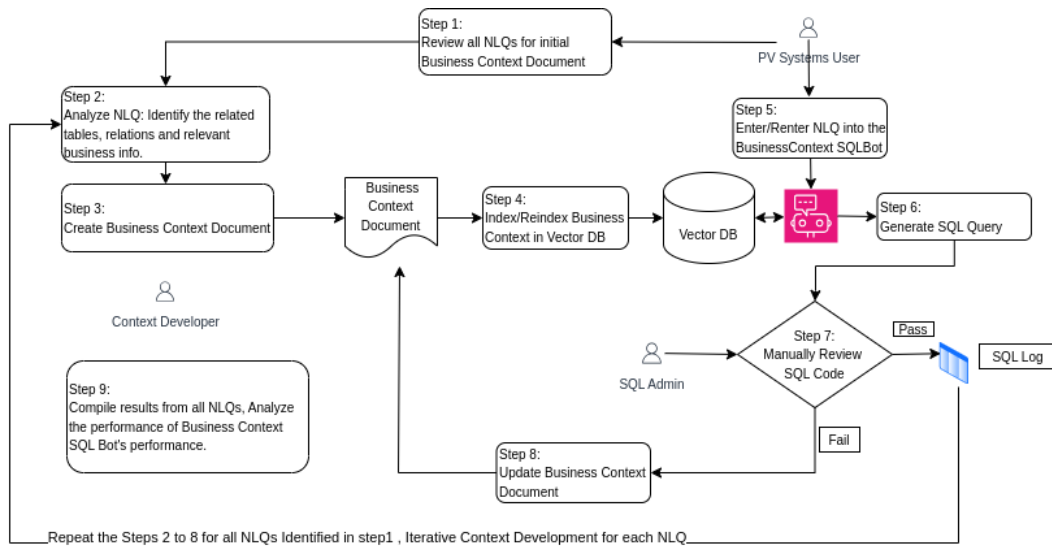

Fig. 3 Phase 2 Experimental Design

A distinctive feature of this phase, introduced in Step 8, was the provision for iterative refinement of the business context document. This step was activated when the LLM failed to generate accurate SQL for a given NLQ, leveraging feedback from the chatbot to progressively enhance the document’s accuracy and comprehensiveness. This iterative loop, executed approximately 10 times, was instrumental in evolving the business context document, ultimately culminating in a refined version poised for presentation in our final results. The iterative enhancement of the business context document emerged as a pivotal component, with each iteration targeting the bridging of knowledge gaps identified through benchmark query assessments.

3.5 Phase 3 Design Details

Phase 3 closely mirrored the setup of Phase 1, with the primary distinction being the utilization of a significantly condensed set of tables for the database schema export, as delineated in the initial steps of the Phase 1 methodology. This adjustment aimed to refine the LLM’s focus and potentially enhance its query generation accuracy by limiting the scope to only the tables outlined within the business context document. Beyond this strategic reduction in schema complexity, the approach to processing NLQs and the subsequent evaluation of the generated SQL code remained consistent. Each query’s outcome was documented and analyzed by a database expert, ensuring a consistent assessment of the LLM’s performance under these modified conditions.

3.6 Classification of Generated SQL Code

Each NLQ processed through our chatbot was evaluated by a database expert who categorized the resultant SQL code into one of three classes: pass, fail, or partial pass. A “pass” indicated that the LLM-generated SQL code was valid and executable by the Oracle SQL interpreter without modifications, and it produced the anticipated results akin to those of a manually crafted query. A “fail” was noted when the LLM explicitly stated its inability to generate a query given the context, produced unexecutable SQL code, or generated syntactically correct SQL that did not yield the expected results.

A “partial pass” was assigned based on the expert’s judgment that the SQL code needed only minor modifications to become valid or to address minor issues, such as incorrect table names used in scenarios where tables had similarly named columns, leading to ambiguity.

This classification approach, particularly the identification of specific errors such as misidentified table names, led us to the development of the Phase 3 part of this study . This phase aimed to assess whether focusing the LLM’s scope exclusively on the tables essential for our test set of NLQs would enhance its performance, compared to the broader database schema used in Phase 1.

3.7 Constructing the Business Context Document

As noted above, the creation of the business context document was initiated during phase 2 of our experiment. This document requires capturing the domain specialist knowledge in unstructured text form. While there is not yet a benchmark of the best approach to accomplishing this, for our experiment we focused on the tables most frequently required to answer a scientific question of the global safety database.

This process helps to extricate the necessary tables and business logic that must be described to create a generalizable LLM based database expert capable of answering any new queries.

An example of the contents of our business context document is highlighted below.

This process was repeated for 36 database tables which encompass primary features of a case safety report, along with supporting tables related to code sets and dictionaries and system configuration tables necessary for supporting a wide range of example queries for testing.

In addition, specific instructions and definitional statements known to the PV systems experts were added to the business context document such as:

Definition “New case”: A new case includes cases that have not yet been assigned to any database user (e.g., Intake Specialist or Data Entry Specialist) as well as cases that have been assigned, but not yet accepted by the user.

The development of the business context document is an iterative process, and as such, the level of effort spent on the creation of this document, we believe, will yield more positive results from the LLMs capability in effectively converting NLQs into valid and executable SQL code. The iterative process helps to highlight knowledge gaps, prompting successive refinements. This process can be repeated until a set of benchmark queries when prompted to the LLM attain satisfactory performance levels. It is noted that this is potentially a limiting factor in deploying a similar solution for other databases, as it requires one with expert knowledge of the system to help develop such a document. Updates to database structures or schemas in the future could also affect the utility of such a system, and should be considered as to their impact in a production system for reliability.

Excerpt of the Safety Database Context Document

Purpose: The purpose of this context document is to equip the Large Language Model (LLM) with the knowledge and intricacies of the global Safety Database. This will enable accurate and efficient SQL generation for data retrieval and analysis.

Database Overview: The global Safety Database is a comprehensive pharmacovigilance software solution that stores and manages data related to drug safety and adverse event reporting.

Introduction:

This document provides guidance on generating SQL related to business configurations in the Global Safety database system. It emphasizes the tables, relationships, and common querying patterns associated with these configurations.

Data Tables and Relationships:

The global safety database contains the following tables:

1. Table name PRODUCT_FAMILY contains company product data, where the column identified as FAMILY_ID is the primary key, the column identified as NAME contains the product family name, and the column identified as DELETED contains the date a record was deleted.

If the DELETED column is NULL, then the record is not deleted.

The column PRODUCT_GROUP_ID is a foreign key to link records matching on the same column from the table PRODUCT_GROUP.

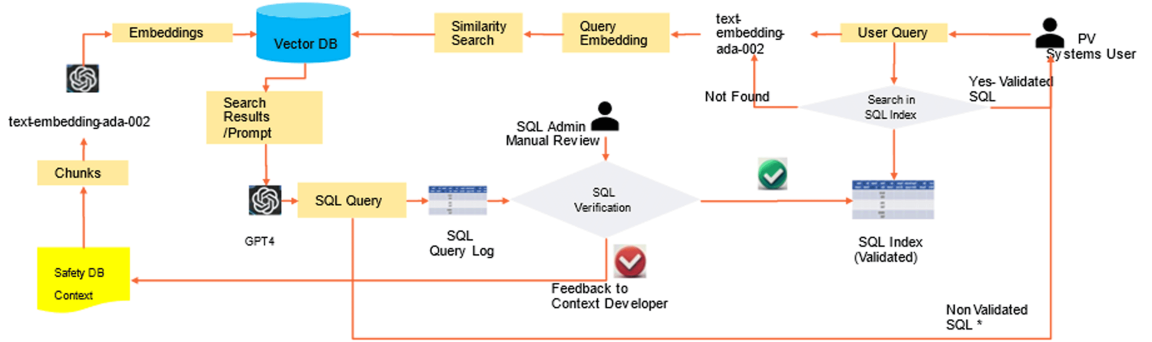

Fig. 4 System Architectural Diagram

3.8 System Design and Implementation

LLMs demonstrate proficiency in answering queries, but they face challenges when required to extract and interpret information from specific contextual or business documents. Priming, or training, LLMs with document-specific knowledge can significantly improve their ability to provide informed and contextually relevant responses. Research by Brown et al. [16] and Xie et al. [17] highlights LLMs’ adaptability through fine-tuning processes [18], underscoring their versatility across a range of applications.

To leverage this adaptability, we implemented a framework using the RAG model, which employs vectorization techniques to enhance LLMs’ capacity for accurate, data-validated responses [19] [20]. The RAG model enriches LLMs by integrating vector-based data representations, augmenting their understanding and response generation [21]. While Text-to-SQL generation is a niche area within RAG applications [22], our focus is on generating contextually informed SQL statements.

Our system utilizes OpenAI’s GPT-4, hosted on the Azure cloud² platform in a secure, sandboxed environment, and is designed to seamlessly integrate with the LLM APIs and supporting libraries such as LangChain³. This ensures the generated SQL queries from natural language inputs are not only accurate and efficient but also contextually relevant, facilitating a bridge between complex database systems and users lacking SQL expertise.

Central to our framework is the business context document, visualized in the bottom left of Figure 4 and highlighted in yellow. It is segmented and processed through the text-embedding-ada-002 model to produce vector embeddings. These vectors enable the GPT-4 model to access a database of contextually pertinent information, enhancing response accuracy.

User queries undergo a similar processing routine (top right of the figure), supporting a similarity search against the vector database to guide SQL generation. When a

²<https://azure.microsoft.com/>

³<https://www.langchain.com/>

user submits a natural language query (NLQ), a similar embedding process is applied to convert the query into vector embeddings, which are used to search for relevant data chunks in the vector database. The search results, in conjunction with the user query, are then forwarded to the GPT-4 model, which auto generates the SQL query. Following this, the generated SQL queries undergo thorough expert review and validation before being systematically cataloged in the “SQL Index” for future reference.

By employing advanced LLMs and the RAG framework, our system aims to improve the efficiency of data retrieval, making database interactions more straightforward and accessible for non-technical users within the PV domain.

4 Results

Our experiment sought to understand the impact of leveraging LLMs with a business context document on the complexity of SQL queries generated from NLQs. We developed a complexity scoring algorithm to provide an objective measure of SQL query complexity. This method, while straightforward, offers a reproducible way to evaluate SQL complexity, acknowledging that complexity assessment can vary widely in methodology [23].

The scoring algorithm outlined in Algorithm 1 assigns points based on several criteria: time estimated to manually create the query, the number of tables involved, the presence of joins, group by clauses, order by clauses, and aggregation functions. This scoring system aims to quantify the inherent complexity of each SQL query in an unbiased manner.

Algorithm 1 Compute the SQL Complexity Score

```
1: score  $\leftarrow$  0
2: score  $\leftarrow$  time_to_create
3: score  $\leftarrow$  score + number_of_tables
4: score  $\leftarrow$  score + number_of_joins
5: score  $\leftarrow$  score + number_of_where_clauses
6: if has_group_by = True then
7:   score  $\leftarrow$  score + 1
8: end if
9: if has_order = True then
10:  score  $\leftarrow$  score + 1
11: end if
12: if has_aggregation = True then
13:  score  $\leftarrow$  score + 1
14: end if
15: return score
```

Following the application of our scoring algorithm to the SQL queries generated for each NLQ, we performed a distribution analysis of the resulting complexity scores. Figure 5 illustrates this distribution. We employed a systematic approach to categorize

the complexity of SQL queries into “low”, “medium”, or “high”. This categorization was based on their scoring percentile: “low” for scores beneath the 25th percentile, “medium” for scores within the interquartile range (IQR), and “high” for scores above the 75th percentile. This method provides a clear, objective means to classify SQL query complexity, incorporating both the subjective expertise of a database professional regarding time to manually craft the query and objective measures like the count of tables required.

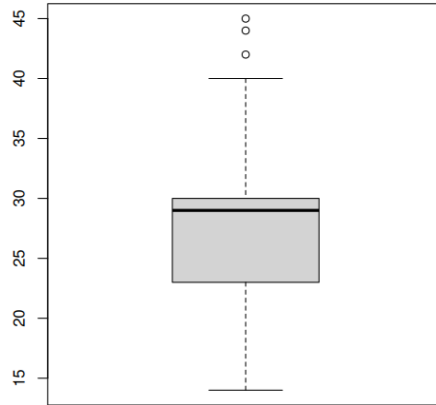

Fig. 5 Boxplot of SQL Complexity Scores

Incorporating the complexity scoring algorithm, our analysis of the 60 NLQs resulted in the following classifications: 17 queries were deemed “low” complexity, 31 were categorized as “medium”, and 12 fell into the “high” complexity category.

As detailed in the methods section, we categorized the LLM’s SQL code generation into three outcomes: ‘pass’ for accurate SQL production, ‘partial success’ for codes requiring slight modifications, and ‘fail’ for incorrect or absent responses. Initially, with the database schema alone, the LLM showed an 8.3% pass rate⁴, with 78.3% failures, demonstrating a significant challenge in generating queries without additional context (Table 1).

Integrating the business context document markedly improved the LLM’s performance, achieving a pass rate above 78%, as shown in Table 2. This underscores

⁴“Pass rate” refers to the proportion of natural language queries (NLQs) that were successfully translated into SQL queries by the LLM, as manually classified by a database expert. The expert tested each generated SQL query directly within the database system. If the output was equivalent to that of a manually crafted SQL query, the query was classified as “pass.” The pass rate thus represents the percentage of NLQs that resulted in accurately generated SQL queries by the LLM. Similarly, the “partial pass” and “fail” rates are computed using the same method, indicating the proportion of NLQs that resulted in SQL queries needing minor adjustments or failing to produce correct results, respectively.

Table 1 LLM Performance with DB Schema Only

Result	NLQ Complexity			Total	Percent
	Low	Medium	High		
Pass	3	2	0	5	(8.3%)
Fail	11	13	23	47	(78.3%)
Partial Pass	3	2	3	8	(13.3%)
Total	17	42	1	60	

the significant role of the business context in enhancing query accuracy for complex inquiries.

Table 2 LLM Performance with Business Context Document

Result	NLQ Complexity			Total	Percent
	Low	Medium	High		
Pass	16	16	15	47	(78.3%)
Fail	0	0	5	5	(8.3%)
Partial Pass	1	1	6	8	(13.3%)
Total	17	17	26	60	

Statistical analysis via Fisher’s Exact Test highlighted a substantial improvement, with a shift from a p-value of 0.2163 without the business context to 0.0186 with it, indicating a statistically significant performance boost when queries are enriched with contextual information.

The enhancements were evident across all query complexities, suggesting the effectiveness of contextual priming in optimizing LLM SQL query generation. Despite some remaining challenges with complex queries, these findings strongly support further development and refinement of business context documents for intuitive database interactions and broader LLM applications in data-centric fields.

Phase 3 showed slight improvements over Phase 1 by limiting the LLM’s focus to only essential tables, reducing the failure rate from 78% to 50% and slightly increasing the pass rate. However, a significant number of queries still required additional adjustments, as seen in Table 3.

A Fisher’s Exact Test in Phase 3 yielded a p-value of 0.1063, suggesting that narrowing the database schema to essential tables modestly improved outcomes but did not match the success achieved with the business context document. This result emphasizes that while schema optimization can yield some benefits, the comprehensive insights provided by the business context document are more critical in enhancing LLM’s query generation accuracy.

These findings underscore the importance of developing detailed business context documents for LLM frameworks, not only to enhance SQL query accuracy but also to extend the application of LLMs in complex, data-rich environments.

Table 3 Phase 3 LLM Performance with Narrowed Schema Definition

Result	NLQ Complexity			Total	Percent
	Low	Medium	High		
Pass	4	2	0	6	(10%)
Fail	6	8	16	30	(50%)
Partial Pass	7	7	10	24	(40%)
Total	17	17	26	60	

5 Discussion

This study underscores the potential of context-enriched LLMs in facilitating SQL query generation from NLQs within PV and other data-intensive domains. By integrating OpenAI’s GPT-4 model with a business context document, we have enhanced the model’s ability to generate syntactically precise and contextually relevant SQL queries. This approach demonstrates a promising path towards democratizing access to complex databases and improving the process’s intuitiveness and efficiency for data querying.

Our findings reveal a marked improvement in SQL query generation accuracy when the LLM is augmented with contextual knowledge. The introduction of a business context document led to a notable increase in performance, achieving a success rate exceeding 78% for a broad spectrum of query complexities. This stark enhancement, from an initial 8.3% success rate with the database schema alone to over 78% with the business context document, underscores the critical role of context in bridging the gap between natural language and SQL code. Despite some improvements in phase 3 with a narrowed database schema, the comprehensive context provided by the business document proved indispensable for achieving higher accuracy.

While our research marks a significant stride in making SQL querying more accessible, thereby enabling non-technical users to harness data-driven insights for more inclusive and efficient decision-making, it’s essential to interpret our findings with caution. Our approach, characterized by its adaptability and ease of use, undeniably democratizes data access, especially in fields where the complexity of data and the diversity of users present formidable challenges. However, the efficacy of the business context document has been assessed with a relatively small set of NLQs and within the confines of a single, albeit intricate, enterprise database. The scalability and applicability of our findings to other databases remain uncertain. The creation and integration of a business context document are critical factors that could influence the reproducibility and effectiveness of our method in varied database environments. Future research should aim to validate these results across broader datasets and diverse database architectures to fully understand the potential and limitations of our approach.

However, further advancements are necessary. While our system demonstrates substantial capabilities, it also identifies key areas for additional research and development. Handling complex queries and resolving ambiguous user intents continue to pose challenges, indicating the necessity for continued efforts to refine the model’s understanding and adaptability. Moreover, concerns related to scalability and the

implementation of such systems within large, dynamic enterprise environments highlight the need for future investigations to strengthen the robustness and applicability of our methodology.

In conclusion, this study offers a novel paradigm for employing LLMs in database management, showcasing significant advancements in making PV data analysis more intuitive and accessible. The integration of LLMs with a business context document not only streamlines the SQL query generation process but also opens the door to broader applications in various sectors. As we continue to harness the burgeoning capabilities of LLMs, the horizon for data interaction and analysis widens, promising a future where insights from complex databases are within reach for a more extensive array of users, thereby enhancing our collective ability to make informed decisions in an increasingly data-driven world.

6 Acknowledgments

This research was supported in part by additional team members who helped with testing and development of the architectural framework to support context based LLMs, including Marcin Karwowski (GSK, Poland), Christie Roshan (GSK, UK) and Richard Barlow (GSK, USA), all members of the PV Systems team in Global Safety.

7 Declarations

Data availability The datasets generated during and/or analyzed during the current study are available from the corresponding author upon reasonable request.

Competing interests The authors have no competing interests to declare that are relevant to the content of this article.

Conflict of interests This manuscript has not been submitted to, nor is under review at, another journal or other publishing venue.

Funding GlaxoSmithKline Biologicals SA covered all costs associated with the conduct of the study and the development of the manuscript and the decision to publish the manuscript. JP, RK and AB are employees, and VC is a contractor, of the GSK group of companies. JP, RK and AB hold shares and/or options in the GSK group of companies.

References

- [1] Beninger, P.: Pharmacovigilance: an overview. *Clinical therapeutics* **40**(12), 1991–2004 (2018)
- [2] Brass, S., Goldberg, C.: Semantic errors in SQL queries: A quite complete list. *Journal of Systems and Software* **79**(5), 630–644 (2006)

- [3] Sivarajkumar, S., Mohammad, H.A., Oniani, D., Roberts, K., Hersh, W., Liu, H., He, D., Visweswaran, S., Wang, Y.: Clinical information retrieval: A literature review. *Journal of Healthcare Informatics Research*, 1–40 (2024)
- [4] Taipalus, T., Siponen, M., Vartiainen, T.: Errors and complications in SQL query formulation. *ACM Transactions on Computing Education (TOCE)* **18**(3), 1–29 (2018)
- [5] OpenAI: GPT-4 Technical Report (2024). <https://arxiv.org/abs/2303.08774>
- [6] Vaswani, A., Shazeer, N., Parmar, N., Uszkoreit, J., Jones, L., Gomez, A.N., Kaiser, L., Polosukhin, I.: Attention is all you need. *Advances in neural information processing systems* **30** (2017)
- [7] Zloof, M.M.: Query-by-example: A data base language. *IBM systems Journal* **16**(4), 324–343 (1977)
- [8] Ramakrishnan, R., Gehrke, J.: *Database Management Systems*. McGraw-Hill, Inc., New York, NY (2002)
- [9] Dauphin, Y.N., Fan, A., Auli, M., Grangier, D.: Language modeling with gated convolutional networks. In: *International Conference on Machine Learning*, pp. 933–941 (2017). PMLR
- [10] Li, J., Hui, B., Qu, G., Li, B., Yang, J., Li, B., Wang, B., Qin, B., Cao, R., Geng, R., et al.: Can LLM Already Serve as A Database Interface? A Big Bench for Large-Scale Database Grounded Text-to-SQLs. *arXiv preprint arXiv:2305.03111* (2023)
- [11] Gao, D., Wang, H., Li, Y., Sun, X., Qian, Y., Ding, B., Zhou, J.: Text-to-SQL Empowered by Large Language Models: A Benchmark Evaluation. *arXiv preprint arXiv:2308.15363* (2023)
- [12] Painter, J.L., Mahaux, O., Vanini, M., Kara, V., Roshan, C., Karwowski, M., Chalamalasetti, V.R., Bate, A.: Enhancing Drug Safety Documentation Search Capabilities with Large Language Models: A User-Centric Approach. *2023 International Conference on Computational Science and Computational Intelligence (CSCI)* (2023). CSCI
- [13] Roberson, R., Kaki, G., Trivedi, A.: Analyzing the Effectiveness of Large Language Models on Text-to-SQL Synthesis. *arXiv preprint arXiv:2401.12379* (2024)
- [14] Zhang, Q., Dong, J., Chen, H., Li, W., Huang, F., Huang, X.: Structure Guided Large Language Model for SQL Generation. *arXiv preprint arXiv:2402.13284* (2024)

- [15] Bhangale, R., Vaity, S., Kulkarni, N.: A day in the life of a pharmacovigilance case processor. *Perspectives in Clinical Research* **8**(4), 192 (2017)
- [16] Brown, T., Mann, B., Ryder, N., Subbiah, M., Kaplan, J.D., Dhariwal, P., Neelakantan, A., Shyam, P., Sastry, G., Askell, A., *et al.*: Language models are few-shot learners. *Advances in neural information processing systems* **33**, 1877–1901 (2020)
- [17] Xie, S.M., Raghunathan, A., Liang, P., Ma, T.: An explanation of in-context learning as implicit bayesian inference. *arXiv preprint arXiv:2111.02080* (2021)
- [18] Radford, A., Wu, J., Child, R., Luan, D., Amodei, D., Sutskever, I., *et al.*: Language models are unsupervised multitask learners. *OpenAI blog* **1**(8), 9 (2019)
- [19] Lewis, P., Perez, E., Piktus, A., Petroni, F., Karpukhin, V., Goyal, N., Küttler, H., Lewis, M., Yih, W.-t., Rocktäschel, T., *et al.*: Retrieval-augmented generation for knowledge-intensive NLP tasks. *Advances in Neural Information Processing Systems* **33**, 9459–9474 (2020)
- [20] Topsakal, O., Akinci, T.C.: Creating large language model applications utilizing langchain: A primer on developing LLM apps fast. In: *International Conference on Applied Engineering and Natural Sciences*, vol. 1, pp. 1050–1056 (2023)
- [21] IBM: What is retrieval-augmented generation? <https://research.ibm.com/blog/retrieval-augmented-generation-RAG>. [Online; accessed 01-Apr-2024] (2023)
- [22] Zhao, P., Zhang, H., Yu, Q., Wang, Z., Geng, Y., Fu, F., Yang, L., Zhang, W., Cui, B.: Retrieval-Augmented Generation for AI-Generated Content: A Survey. *arXiv preprint arXiv:2402.19473* (2024)
- [23] Simon, M., Pataki, N.: SQL Code Complexity Analysis. In: *Proceedings of the 8th International Conference of Applied Informatics* (2010)