

# LGR2: Language Guided Reward Relabeling for Accelerating Hierarchical Reinforcement Learning

**Utsav Singh**

Department of Computer Science and Engineering  
IIT Kanpur, India  
utsavz@iitk.ac.in

**Pramit Bhattacharyya**

Department of Computer Science and Engineering  
IIT Kanpur, India  
pramitb@cse.iitk.ac.in

**Vinay P Namboodiri**

Department of Computer Science and Engineering  
University of Bath, bath, UK  
vpn22@bath.ac.uk

**Abstract:** Developing interactive systems that leverage natural language instructions to solve complex robotic control tasks has been a long-desired goal in the robotics community. Large Language Models (LLMs) have demonstrated exceptional abilities in handling complex tasks, including logical reasoning, in-context learning, and code generation. However, predicting low-level robotic actions using LLMs poses significant challenges. Additionally, the complexity of such tasks usually demands the acquisition of policies to execute diverse subtasks and combine them to attain the ultimate objective. Hierarchical Reinforcement Learning (HRL) is an elegant approach for solving such tasks, which provides the intuitive benefits of temporal abstraction and improved exploration. However, HRL faces the recurring issue of non-stationarity due to unstable lower primitive behaviour. In this work, we propose LGR2, a novel HRL framework that leverages language instructions to generate a stationary reward function for the higher-level policy. Since the language-guided reward is unaffected by the lower primitive behaviour, LGR2 mitigates non-stationarity and is thus an elegant method for leveraging language instructions to solve robotic control tasks. To analyze the efficacy of our approach, we perform empirical analysis and demonstrate that LGR2 effectively alleviates non-stationarity in HRL. Our approach attains success rates exceeding 70% in challenging, sparse-reward robotic navigation and manipulation environments where the baselines fail to achieve any significant progress. Additionally, we conduct real-world robotic manipulation experiments and demonstrate that LGR2 shows impressive generalization in real-world scenarios.

**Keywords:** Hierarchical Reinforcement Learning (HRL), Large Language Models (LLM), Robot Navigation, Robot Manipulation

## 1 Introduction

While deep reinforcement learning (RL) has achieved notable advancements in executing complex robotic tasks [1, 2, 3, 4], its success is often hindered by challenges such as ineffective exploration and long-term credit assignment, especially in sparse-reward scenarios [5]. Hierarchical reinforcement learning (HRL) [6, 7, 8, 9, 10] presents an elegant framework that offers the benefits of temporal

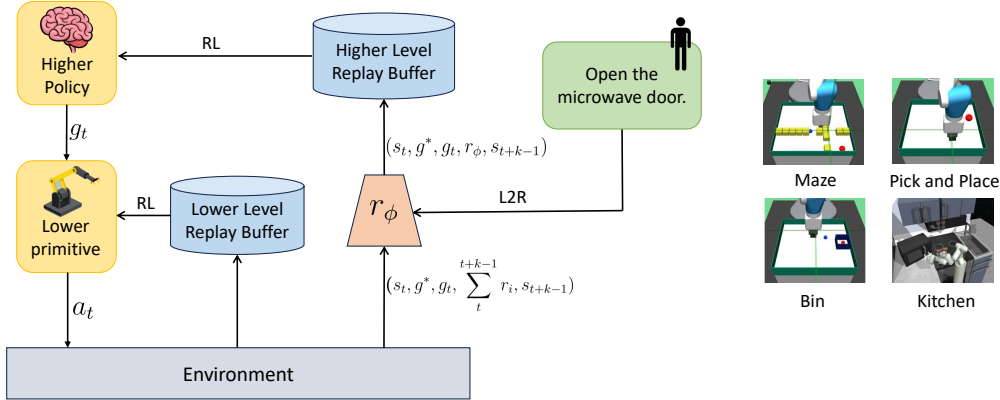

Figure 1: **LGR2 overview (left)**: The higher-level policy predicts subgoals  $g_t$  for the lower-level policy, which executes primitive actions  $a_t$  on the environment. The lower-level replay buffer is populated by environment interactions, and RL is subsequently used to optimize the lower-level policy. L2R is used to translate human instructions to reward function parameters, and is subsequently used to relabel higher-level replay buffer transitions. Finally, RL is used to optimize the higher-level policy.

**Training environments (right)**: (i) maze navigation, (ii) pick and place, (iii) bin, and (iv) franka kitchen.

abstraction and enhanced exploration [11] to address these issues. In goal-conditioned RL setting [7, 8], the lower-level policy executes primitive actions to achieve the subgoals provided by the higher-level policy. However, the performance in off-policy HRL is often impeded by issues like non-stationarity, and therefore, developing more sophisticated techniques for solving HRL are essential.

Large Language Models (LLMs) trained on internet data [12] have shown remarkable capabilities to solve complex tasks ranging from logical reasoning [13, 14] and code generation [15]. Considerable advancement have also been made in utilizing LLMs to guide robotic behaviours [16, 17, 18]. Using natural language instructions to directly solve complex robotic tasks is a crucial step towards building interactive robots. Recently, language instructions have been employed to generate parameters for reward function in L2R [19], which is subsequently optimized using MPC controllers [20]. This raises the following question: *can we utilize reward generation capabilities of LLMs to build an HRL approach, that leverages natural language instructions to solve complex robotic control tasks, while simultaneously addressing the non-stationarity issue in HRL?*

In this work, we provide an affirmative answer to the above question by proposing LGR2: **L**anguage **G**uided **R**eward **R**elabeling for **A**ccelerating **H**ierarchical **R**einforcement **L**earning. In LGR2, we first translate language instructions to reward function parameters using L2R approach, and then subsequently leverage the reward function parameters to relabel higher-level replay buffer transitions. The key insight behind the HRL component of LGR2 is that the higher-level policy is decoupled from the non-stationary lower-level primitive, which effectively alleviates the non-stationarity problem encountered in off-policy HRL. Additionally, since the relabeled rewards might be too sparse for the lower primitive to show any significant progress, we employ hindsight experience replay [21] to densify the higher-level rewards. To the best of our knowledge, ours is the first approach that effectively combines language-guided reward generation and HRL to learn effective policies for solving complex robotic control tasks. In order to assess the efficacy of the proposed method, we perform experiments across a range of complex robotic tasks. Our experiments demonstrate that DIPPER achieves remarkable performance and consistently outperforms existing baselines. We provide LGR2 overview in Figure 1.

We summarize the main contributions of LGR2 as follows:

- (i) we propose a novel HRL framework for solving robotic control tasks from language instructions (Section 4),
- (ii) we show that LGR2 is able to mitigate non-stationarity in off-policy HRL (Section 5),
- (iii) we utilize hindsight relabeling to enhance sample efficiency and address the issue of sparsity in

scenarios with sparse rewards, (Section 4.2), and (iv) we experimentally demonstrate that LGR2 achieves greater than 70% success rates in complex robotic control tasks where other baselines typically fail to show significant progress (Section 5).

## 2 Related Work

**Hierarchical Reinforcement Learning** The development of effective hierarchies of policies has attracted considerable research interest in reinforcement learning (RL) community [22, 23, 24, 25]. The options framework [23, 26, 27, 28, 29, 30] focuses on learning temporally extended macro actions and termination functions to tackle long-horizon tasks. However, without proper regularization, these methods can often result in degenerate solutions. In goal-conditioned learning, previous approaches have narrowed the search space by solving for specific goals in a greedy manner [31, 32], and this strategy has been adapted to hierarchical RL (HRL) as well [33, 34, 35]. Methods such as HIRO [36] and HAC [37] address the non-stationarity issue in hierarchical learning by relabeling subgoals within the replay buffer. In contrast, LGR2 addresses non-stationarity in HRL by utilizing LLMs to define reward parameters, which are optimized using HRL to solve complex robotic control tasks.

Other works have attempted to pre-train policies on related tasks to develop behaviour skill priors [38, 39], followed by fine-tuning using RL. However, these approaches may struggle to generalize when there is a distributional shift between the initial and target task distributions, and they may also fail to learn effective policies due to sub-optimal priors. Some methods rely on hand-designed action primitives [40, 41] to determine how to solve sub-tasks and subsequently predict what to do by selecting the appropriate primitives. The design of these action primitives can be labour-intensive, limiting the applicability of such approaches to complex real-world tasks. LGR2 avoids these limitations by learning hierarchical policies in parallel, thus eliminating the need for hand-designed action primitives and enhancing the ability to handle more complex tasks.

**Language to Actions** The earliest work of this paradigm studied mapping templated language to controllers with temporal logic [42] or learning a parser to motion primitives [43]. Recent studies have focussed on utilizing end-to-end models that produce actions based on natural language descriptions. Ku et al. [44] have used natural language descriptions for instructions for the navigation methods of robots. However, they suffer from the assumption of low-dimensional actions navigating from one graph node to another [44, 45]. Utilization of latent embeddings of language commands as multiple input text is a commonly used approach to extend the end-to-end approaches for navigation manipulation. These embeddings are either trained with behavioural cloning [46, 47, 48], offline reinforcement learning [49], goal-conditioned reinforcement learning [50], or in a shared autonomy paradigm [51] to translate the natural language descriptions into robot navigation methods. End-to-end policies can be very effective, but they require a large amount of training data. [19] proposed a less data-centric method in which an optimal controller generates low-level actions. In contrast, we employ an HRL based approach that leverages temporal abstraction to induce training efficiency.

**Language to Code** Large Language Models (LLMs) like Llama [52], GPT-4 [53], and Gemini [54] have been extensively used for code generation both in and outside the robotics context [15, 55, 56]. These models are highly efficient in solving coding competition questions [57], drawing figures [58], generating policies to solve 2D tasks [59], and complex instruction tasks [16]. In this work, we use LLMs to generate language-guided higher-level rewards.

**Language to Rewards** Several works have explored the idea of translating natural language instructions to rewards [60, 61, 62, 63, 64, 65, 66]. Prior works have gone into training domain-specific reward models to map language instructions to reward values [60, 61, 62] or constraints [60]. These models can perform efficiently for challenging robotic tasks such as object pushing [60] and drawer opening [62] but are hindered by the requirement of a large amount of language-labelled data. Recent research has focused on employing LLMs as a reward function to infer user intents in negotiation games or collaborative human-AI interaction games [65, 64]. All these works impeded utilizing the LLMs to assign reward values during RL training. Nevertheless, in training RL rules, these works get reward values of rollouts, necessitating a high volume of inquiries to LLMs. AutoRL [67] proposed

an automated parameterization of reward functions, but they did not provide a language interface. We leverage reward generated from of language instructions to mitigate non-stationarity in HRL, and thus propose an effective framework for translating language instructions to robot actions.

### 3 Problem Formulation

In this paper, we explore the Markov decision process (MDP) framework denoted as  $(S, A, p, r, \gamma)$ . Here,  $S$  represents the state space, and  $A$  denotes the action space. The transition probability function,  $p : S \times A \rightarrow \Delta(S)$ , maps state-action pairs to probability distributions over the state space. The reward function,  $r : S \times A \rightarrow R$ , assigns rewards based on state-action pairs, and  $\gamma \in (0, 1)$  is the discount factor. At each timestep  $t$ , the agent occupies state  $s_t$  and selects an action  $a_t$  based on a policy  $\pi : S \rightarrow \Delta(A)$ , which maps states to probability distributions over the action space. The action  $a_t$  is sampled from this distribution,  $a_t \sim \pi(\cdot|s_t)$ . Following the action, the agent receives a reward  $r_t = r(s_t, a_t)$ , and the system transitions to a new state  $s_{t+1}$ , sampled according to the transition function,  $s_{t+1} \sim p(\cdot|s_t, a_t)$ . In the traditional RL setup, we optimize the following objective:  $\pi^* := \arg \max_{\pi} J(\pi) = \mathbb{E}_{\pi} [\sum_{t=0}^{\infty} \gamma^t r_t]$ . In the following discussion, we will focus on the standard goal-conditioned setting as described in [21], where the agent’s policy is conditioned on both the current state and a specified goal. Specifically, at each timestep  $t$ , the policy  $\pi$  determines actions  $a_t$  based on both the current state  $s_t$  and the desired goal  $g_t$ , such that  $a_t \sim \pi(\cdot|s_t, g_t)$ .

#### 3.1 Hierarchical Reinforcement Learning

In our goal-conditioned hierarchical framework, the higher-level policy sets subgoals for the lower-level policy to which in turn executes primitive actions on the environment. Specifically, the higher-level policy, denoted as  $\pi^H : S \rightarrow \Delta(G)$ , selects subgoals  $g_t$  from the set of possible goals  $G \subset S$ . At each timestep  $t$ , the higher-level policy predicts a subgoal  $g_t \sim \pi^H(\cdot|s_t)$  every  $k$  timesteps, maintaining the subgoal as  $g_t = g_{k \cdot \lfloor t/k \rfloor}$  in the intervals between these updates. Consequently, the higher-level policy updates the subgoals at regular intervals of  $k$  timesteps, while the lower-level policy focuses on executing primitive actions to accomplish these subgoals in the meantime. Moreover, at each timestep  $t$ , the lower-level policy  $\pi^L : S \times G \rightarrow \Delta(A)$  selects primitive actions  $a_t$  based on the current state  $s_t$  and the subgoal  $g_t$  provided by the higher-level policy. The action  $a_t$  is sampled as  $a_t \sim \pi^L(\cdot|s_t, g_t)$ , leading to a state transition  $s_{t+1} \sim p(\cdot|s_t, a_t)$ . The lower-level policy receives a reward  $r_t^L = r^L(s_t, g_t, a_t)$ , defined as  $-\mathbf{1}_{\{\|s_t - g_t\|_2 > \epsilon\}}$ , where  $\mathbf{1}_G$  is the indicator function for set  $G$ .

In our goal-conditioned HRL framework, we represent the  $k$ -length trajectories of lower-level primitive behavior as sequences denoted by  $\Delta$ , defined as  $\Delta = ((s_t, a_t), (s_{t+1}, a_{t+1}), \dots, (s_{t+k-1}, a_{t+k-1}))$ . Similarly, the  $n$ -length trajectories of higher-level behavior are represented as sequences denoted by  $\sigma$ , which consist of states and subgoal predictions, expressed as  $\sigma = ((s_t, g_t), (s_{t+k}, g_{t+k}), \dots, (s_{t+(n-1)k}, g_{t+(n-1)k}))$ . In the vanilla HRL setup, where both levels are simultaneously trained using RL, the higher-level policy receives a reward  $r_t^H = r^H(s_t, g^*, g_t)$ , where  $g^* \in G$  is the ultimate goal and  $r^H : S \times G \times G \rightarrow \mathbb{R}$  is the higher-level reward function. The lower-level policy stores samples in its replay buffer in the form  $(s_t, g_t, a_t, r_t^L, s_{t+1})$ . Meanwhile, after every  $k$  timesteps, the higher-level policy stores samples of the form  $(s_t, g^*, g_t, r_t^H = \sum_{i=t}^{t+k-1} r_i^L, s_{t+k})$  in its buffer, where  $r_t^H$  is the sum of environment rewards encountered by the lower policy for  $k$  timesteps.

##### 3.1.1 Limitations of standard HRL approaches

Although HRL offers notable benefits over traditional non-hierarchical RL, including enhanced sample efficiency through temporal abstraction and improved exploration [68, 11], it still suffers from serious limitations. As highlighted in [68] and [69], off-policy HRL suffers from non-stationarity due to the non-stationary lower-level policy behavior. Specifically, the transitions in the higher-level replay buffer collected using previous versions of the lower-level policy, become outdated as the lower-level policy changes. Consequently, despite the theoretical advantages of HRL, it often performs poorly in practice [68, 69, 70]. In this work, we focus on developing a novel HRL approach that leverages the advancements in LLMs to mitigate the recurring issue of non-stationarity in HRL.

### 3.2 Language to Rewards

In prior work [60, 71, 65], natural language instructions have been translated to rewards using domain specific reward models. In this work, we consider the work L2R [19], which uses the language instructions to generate reward parameters. These reward parameters act as an interface between high-level language instructions and lower-level primitive actions to accomplish a variety of robotic tasks. In L2R, a reward translator module translates the natural language instructions into reward parameters, which are further optimized using Mujoco MPC controller [20]. In this work, instead of the MPC controller, we use RL to optimize higher and lower level policies. The reward translator consists of two pre-defined templates: the motion descriptor and the reward coder, which are shown to successfully generate reward parameters for complex tasks. However, it faces two limitations:

**L1:** In complex long horizon tasks, learning a single-level policy may prove overly challenging.

**L2:** The generated reward function might be too sparse for any significant lower primitive progress. To resolve these limitations, our novel LGR2 approach harnesses the benefits of temporal abstraction provided by HRL to deal with **L1**, and employs hindsight relabeling to deal with **L2**.

## 4 Methodology

In this section, we introduce LGR2: **L**anguage **G**uided **R**eward **R**elabeling for Accelerating Hierarchical Reinforcement Learning, a novel HRL approach that leverages natural language instructions to solve complex sparse reward robotic tasks. The main idea behind our approach is to translate language instructions to parameters for the higher-level reward function  $r_\phi$ , which is subsequently used to relabel higher-level replay buffer transitions. Since  $r_\phi$  is independent of lower primitive behaviour, this mitigates reward non-stationarity (Section 3.1.1). However, in sparse reward environments,  $r_\phi$  may fail to generate a meaningful reward signal. To resolve this issue, we additionally incorporate hindsight relabeling to reduce reward sparsity and enhance the informativeness of the language-generated reward function. Thus, LGR2 is an efficient language-guided HRL framework that translates language instructions to robot actions, while mitigating non-stationarity in HRL.

The remainder of this section is organized as follows. First, we present our language-guided reward relabeling procedure to mitigate non-stationarity in HRL. We then explain our goal-conditioned hindsight relabeling approach for reducing reward sparsity. Finally, we conclude by introducing the practical implementation and an overview of our algorithm LGR2.

### 4.1 Language Guided Reward Relabeling

In our goal-conditioned HRL framework, the higher-level policy  $\pi^H$  executes for  $n$  timesteps, and provides subgoals  $g_t$  to the lower-level policy  $\pi^L$ , which executes for  $k$  timesteps between each consecutive pair of subgoal predictions. The higher-level policy  $\pi^H$  stores samples of the form  $(s_t, g^*, g_t, r_t^H = \sum_{i=t}^{t+k-1} r_i^L, s_{t+k})$  in its replay buffer, where higher level reward  $r_t^H$  is the sum of environment rewards encountered by the lower level policy for  $k$  timesteps. Due to the non-stationary behaviour of the lower primitive, the higher level reward  $r_t^H$  might become outdated. The key underlying idea of our approach is to relabel the reward function  $r_t^H$  using the reward parameters  $r_\phi$  generated using language instructions. Concretely, first the language instructions are translated to parameters of the higher level reward function  $r_\phi$  using L2R [19] and subsequently, the higher level replay buffer transitions are relabeled using  $r_\phi$ , to yield the following form:  $(s_t, g^*, g_t, r_\phi, s_{t+k})$ . Note that it is straightforward to extract the final goal parameters from  $r_\phi$  using L2R motion descriptor, since the parameters specify the final goal configuration in goal-conditioned RL. We formulate the motion descriptor and reward coder prompts in the reward translator module in L2R according to our robotic navigation and manipulation tasks. The reward translator prompts are provided in detail in the Appendix A.3. Since  $r_\phi$  remains unaffected by lower primitive behaviour, this helps alleviate the reward non-stationarity discussed in Section 3.1.1.

Although, combining the advancements in L2R and HRL does provide the benefits of language-guided robotic control, temporal abstraction, and non-stationarity mitigation, however, in our HRL setup, we found in practice that the higher level reward function  $r_\phi$  generated by L2R is too sparse

for the lower primitive to make any substantial progress. To this end, we next propose an approach for densifying higher level rewards generated from L2R from language instructions.

---

**Algorithm 1** LGR2

---

```

1: Initialize higher level replay buffer  $R^H = \{\}$  and lower level replay buffer  $R^L = \{\}$ 
2: for  $i = 1 \dots N$  do
3:   // Collect experience using  $\pi^H$  and  $\pi^L$  and store transitions in  $R^H$  and  $R^L$ 
4:   for each timestep  $t$  do
5:      $d^H \leftarrow d^H \cup \{(s_t, g^*, g_t, \sum_{i=t}^{t+k-1} r_i, s_{t+k-1})\}$ 
6:      $d^L \leftarrow d^L \cup \{(s_t, g_t, a_t, r_t, s_{t+1})\}$ 
7:    $R^H \leftarrow R^H \cup d^H$ 
8:    $R^L \leftarrow R^L \cup d^L$ 
9:   // Sample and relabel higher-level behaviour trajectories
10:  for  $i = 1 \dots M$  do
11:     $\sigma \sim R^H$  where  $\sigma = \{(s_t, g^*, g_t, \sum_{i=t}^{t+k-1} r_i, s_{t+k-1})\}_{t=1}^{n-1}$ 
12:    // Relabel the reward using language-guided reward  $r_\phi$ , and store the transition in  $R^H$ 
13:     $R^H \leftarrow R^H \cup \{(s_t, g^*, g_t, r_\phi, s_{t+k-1})\}_{t=1}^{n-1}$ 
14:    // Sample a set of additional goals for HER ( $\hat{G}$ )
15:    for  $\hat{g} \in \hat{G}$  do
16:      // Relabel  $g$  by  $\hat{g}$  and  $r_\phi$  by  $\hat{r}_\phi$  in  $\sigma$  to generate  $\hat{\sigma} = \{(s_t, \hat{g}, g_t, \hat{r}_\phi, s_{t+k-1})\}_{t=1}^{n-1}$ 
17:      Store in replay buffer  $R^H \leftarrow R^H \cup \hat{\sigma}$ 
18:    // Policy Learning
19:    for each gradient step do
20:      Sample  $\{(\sigma_j)\}_{j=1}^m$  from  $R^H$ 
21:      Sample  $\{(\delta_j)\}_{j=1}^m$  from  $R^L$ 
22:      Optimize higher policy  $\pi^H$  using SAC
23:      Optimize lower policy  $\pi^L$  using SAC

```

---

## 4.2 Goal-conditioned Hindsight Relabeling

Although the language-guided higher-level reward  $r_\phi$  presented in Section 4.1 is intuitively appealing for relabeling higher-level replay buffer transitions, its sparsity significantly undermines its ability to produce a meaningful reward signal. To address this issue, we employ hindsight relabeling (HER) [21] for densifying the language-guided rewards. Concretely, we employ HER to generate additional replay buffer transitions by relabeling the goal and rewards.

In goal-conditioned HRL, the language-guided reward relabeling approach produces parameters for higher-level rewards. Let the final reward parameters generated by language-guided higher-level reward be denoted as  $r_\phi$ . Based on the discussion in Section 4.1, the higher level replay buffer transitions are of the form  $(s_t, g^*, g_t, r_\phi, s_{t+k})$ , where  $r_\phi$  is the language-guided reward. Let the higher level trajectory for an episode be denoted as  $\sigma = \{(s_t, g^*, g_t, r_\phi, s_{t+k-1})\}_{t=1}^{n-1}$ . In HER, we randomly sample a new goal  $\hat{g}$  from the set  $\sigma$  of states in the higher-level trajectory. The goal in the replay buffer transitions is then relabeled to the new goal  $\hat{g}$ . Additionally, the reward in replay buffer transitions is relabeled to  $\hat{r}_\phi$ , according to the new goal  $\hat{g}$ . Hence, the replay buffer transition is relabeled to generate  $\hat{\sigma} = \{(s_t, \hat{g}, g_t, \hat{r}_\phi, s_{t+k-1})\}_{t=1}^{n-1}$ . Using hindsight relabeling, we are able to generate significantly denser rewards, resulting in improved sample efficiency and performance during training. We show in Figure 3 that this simple hindsight relabeling approach significantly boosts performance in complex sparsely-rewarded tasks.

## 4.3 LGR2 Implementation

We explain our approach in detail in Algorithm 1. The higher and lower-level policies undergo training using SAC [72]. The rewards in higher level transitions are relabeled using the language-



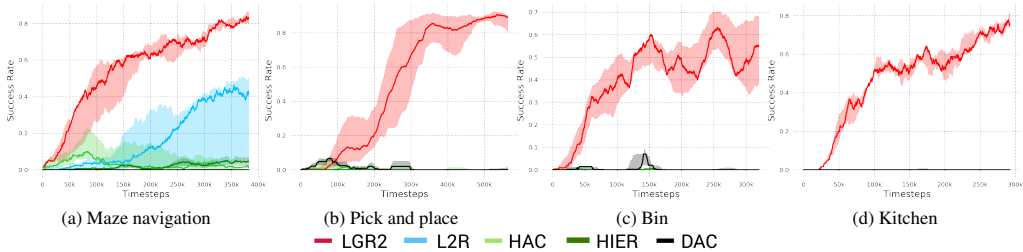

Figure 2: **Success rate comparison** This figure compares the success rate performances on four sparse maze navigation and robotic manipulation environments. The solid line and shaded regions represent the mean and standard deviation, across 5 seeds. We compare our approach LGR2 against multiple baselines. PIPER shows impressive performance and significantly outperforms the baselines.

guided reward  $r_\phi$ . Rather than relabeling all transitions in the replay buffer, we selectively relabel transitions from the higher-level replay buffer as they are sampled during training.

## 5 Experiments

In this section, we perform experimental analysis to answer the following questions: **(1)** How effectively does LGR2 perform in sparse maze navigation and robotic manipulation tasks? **(2)** Can LGR2 address the recurring issue of non-stationarity in HRL? **(3)** Does LGR2 outperform single level L2R approach? **(4)** Does LGR2 improve sample efficiency and training stability? **(5)** What is the impact of using HER on the performance in LGR2?

**Implementation details** We evaluate PIPER on four robotic navigation and manipulation tasks with continuous state and action spaces: *(i)* maze navigation, *(ii)* pick and place [21], *(iii)* bin, and *(iv)* franka kitchen [73]. We provide a video depicting qualitative results and the implementation code in the supplementary. We also provide extensive details about the environments and implementation in the Appendix A.1. For our RL algorithm, we utilize the off-policy SAC [72] with Adam [74] optimizer. To ensure fair comparisons, we maintain consistent training conditions across all baselines, and we empirically tune the hyper-parameters for our method and all other baselines. Additionally, since the pick and place, push and kitchen task environments are difficult, in order to speedup training, we assume access to a single human demonstration, and use an additional imitation learning objective at the lower level. We do not assume access to any demonstration in the maze navigation task. We keep this assumption consistent among all baselines to ascertain fair comparisons.

**Evaluation and Results** To analyze our design choices, we consider several baselines: L2R [19], HAC (Hierarchical Actor Critic [69]), HIER (vanilla hierarchical SAC), and DAC (Discriminator Actor Critic [75]). In the original L2R approach [19], the language instructions are translated to the parameters of reward function via a reward translator module, and the reward function is optimized using a Mujoco MPC controller [20]. In order to ascertain fair comparisons, we implement the original reward translator module in our L2R implementation, but we replace the MPC controller by an RL agent implemented using SAC [72]. Hence, the reward translator module generates reward function parameters, which are optimized using RL. We compare our approach with this baseline to demonstrate the importance of our hierarchical formulation. As seen in Figure 2, our approach significantly outperforms this baseline, which shows that our hierarchical formulation is crucial for solving complex robotic control tasks that require long term planning. We also compare our approach with HAC baseline, which deals with the non-stationarity issue by assuming the lower-level primitive to be optimal. Concretely, HAC augments the higher-level replay buffer with additional transitions by relabeling the subgoals in the replay buffer while assuming an optimal lower primitive. As seen in Figure 2, our approach surpasses HAC, indicating that our language-guided reward relabeling approach is able to better mitigate non-stationarity issue in HRL. Further, we consider HIER baseline, which is a vanilla hierarchical SAC implementation, where the higher level reward is the sum over  $k$ -step environment rewards. Since LGR2 significantly outperforms this baseline, this demonstrates that language-guided reward generation is indeed able to mitigate non-stationarity in HRL. Finally, we also consider DAC baseline with access to a single demonstration. DAC failed to show any significant

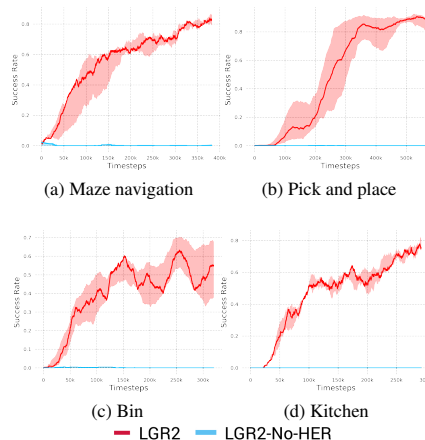

Figure 3: **Hindsight Relabeling ablation** This figure compares the performance of LGR2 with LGR2-No-HER ablation (LGR2 without hindsight relabeling). The plots clearly demonstrate that HER is crucial for good performance in all the tasks.

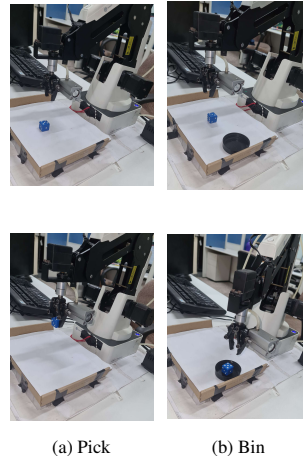

Figure 4: **Real world experiments** in pick and place and bin environments. Row 1 depicts initial and Row 2 depicts goal configuration.

progress, as seen in Figure 2, which shows that LGR2 is even able to outperform single-level baselines which have access to privileged information like expert demonstrations.

**Ablation Analysis** Here, we analyse the importance of using hindsight experience replay (HER) for densifying rewards, when dealing with sparse reward tasks. We compare LGR2 with LGR2-No-HER baseline, which is LGR2 baseline without HER. As seen in Figure 3, HER is crucial for good performance, since language-guided rewards are too sparse to generate any meaningful reward signal.

**Real World Experiments** We perform real world experiments in real pick and place and bin and environments (Fig 4). We use Realsense D435 depth camera to extract the robotic arm, block and bin positions. We train the hierarchical policies in simulation and deploy on real robotic arm. Additionally, we found that assigning small hard-coded values to the linear and angular velocities shows good performance, when deploying on the real robot. *LGR2* achieves an accuracy of 0.6 and 0.5 on pick and place and bin environments respectively. We also deployed the next best performing baseline *L2R* on the two tasks, but it was unable to achieve the goal in any of the tasks.

## 6 Conclusion

**Discussion** In this work, we propose LGR2, a novel HRL based approach that employs language-guided reward generation to address non-stationarity in HRL. LGR2 effectively leverages natural language instructions to directly solve complex robotic control tasks. We empirically show that LGR2 is able to demonstrate impressive performance on complex robotic control tasks, and is able to significantly outperform the baselines. Additionally, our hierarchical formulation is able to outperform single-level L2R formulation. We therefore believe that LGR2 is a promising step towards building practical robotic systems that use language instructions to solve complex real-world tasks.

**Limitations and future work** Although we demonstrate that LGR2 is able to solve complex robotic control tasks through natural language instructions, it faces certain limitations. Firstly, designing prompts for the reward translator module requires additional manual effort. Alternatively, if we neglect designing the prompts, the LLMs might hallucinate the parameters for reward function. An interesting direction for future work is to automatically generate the prompts, or even disregard the prompts altogether. Further, LGR2 first employs LLMs to relabel higher level rewards, and then subsequently optimizes the rewards using RL. This two-step approach adds an additional layer of complexity. A possible solution is to combine the higher-level policy and reward translator module, where the higher-level policy uses natural language instructions to generate subgoals. However, it is challenging to design subgoals that are not easily expressible using natural language. An interesting



research direction is to design efficient intermediate subgoal representations for the lower primitive, which we plan to analyse in the future.

## References

- [1] A. Rajeswaran, V. Kumar, A. Gupta, J. Schulman, E. Todorov, and S. Levine. Learning complex dexterous manipulation with deep reinforcement learning and demonstrations. *CoRR*, abs/1709.10087, 2017. URL <http://arxiv.org/abs/1709.10087>.
- [2] D. Kalashnikov, A. Irpan, P. Pastor, J. Ibarz, A. Herzog, E. Jang, D. Quillen, E. Holly, M. Kalakrishnan, V. Vanhoucke, and S. Levine. Qt-opt: Scalable deep reinforcement learning for vision-based robotic manipulation. *CoRR*, abs/1806.10293, 2018. URL <http://arxiv.org/abs/1806.10293>.
- [3] S. Gu, E. Holly, T. P. Lillicrap, and S. Levine. Deep reinforcement learning for robotic manipulation. *CoRR*, abs/1610.00633, 2016. URL <http://arxiv.org/abs/1610.00633>.
- [4] S. Levine, C. Finn, T. Darrell, and P. Abbeel. End-to-end training of deep visuomotor policies. *CoRR*, abs/1504.00702, 2015. URL <http://arxiv.org/abs/1504.00702>.
- [5] A. Nair, B. McGrew, M. Andrychowicz, W. Zaremba, and P. Abbeel. Overcoming exploration in reinforcement learning with demonstrations. *CoRR*, abs/1709.10089, 2017. URL <http://arxiv.org/abs/1709.10089>.
- [6] R. S. Sutton, D. Precup, and S. Singh. Between mdps and semi-mdps: A framework for temporal abstraction in reinforcement learning. *Artificial intelligence*, 112(1-2):181–211, 1999.
- [7] P. Dayan and G. E. Hinton. Feudal reinforcement learning. In *Advances in Neural Information Processing Systems 5, [NIPS Conference]*, pages 271–278, San Francisco, CA, USA, 1993. Morgan Kaufmann Publishers Inc. ISBN 1-55860-274-7.
- [8] A. S. Vezhnevets, S. Osindero, T. Schaul, N. Heess, M. Jaderberg, D. Silver, and K. Kavukcuoglu. Feudal networks for hierarchical reinforcement learning. *CoRR*, abs/1703.01161, 2017.
- [9] M. Klissarov, P.-L. Bacon, J. Harb, and D. Precup. Learnings options end-to-end for continuous action tasks. *arXiv preprint arXiv:1712.00004*, 2017.
- [10] J. Harb, P.-L. Bacon, M. Klissarov, and D. Precup. When waiting is not an option: Learning options with a deliberation cost. In *Proceedings of the AAAI Conference on Artificial Intelligence*, volume 32, 2018.
- [11] O. Nachum, H. Tang, X. Lu, S. Gu, H. Lee, and S. Levine. Why does hierarchy (sometimes) work so well in reinforcement learning? *arXiv preprint arXiv:1909.10618*, 2019.
- [12] T. Brown, B. Mann, N. Ryder, M. Subbiah, J. D. Kaplan, P. Dhariwal, A. Neelakantan, P. Shyam, G. Sastry, A. Askell, et al. Language models are few-shot learners. *Advances in neural information processing systems*, 33:1877–1901, 2020.
- [13] J. Wei, X. Wang, D. Schuurmans, M. Bosma, F. Xia, E. Chi, Q. V. Le, D. Zhou, et al. Chain-of-thought prompting elicits reasoning in large language models. *Advances in neural information processing systems*, 35:24824–24837, 2022.
- [14] T. Kojima, S. S. Gu, M. Reid, Y. Matsuo, and Y. Iwasawa. Large language models are zero-shot reasoners. *Advances in neural information processing systems*, 35:22199–22213, 2022.
- [15] M. Chen, J. Tworek, H. Jun, Q. Yuan, H. P. d. O. Pinto, J. Kaplan, H. Edwards, Y. Burda, N. Joseph, G. Brockman, et al. Evaluating large language models trained on code. *arXiv preprint arXiv:2107.03374*, 2021.

- [16] J. Liang, W. Huang, F. Xia, P. Xu, K. Hausman, B. Ichter, P. Florence, and A. Zeng. Code as policies: Language model programs for embodied control, 2023.
- [17] W. Huang, F. Xia, T. Xiao, H. Chan, J. Liang, P. Florence, A. Zeng, J. Tompson, I. Mordatch, Y. Chebotar, et al. Inner monologue: Embodied reasoning through planning with language models. *arXiv preprint arXiv:2207.05608*, 2022.
- [18] M. Ahn, A. Brohan, N. Brown, Y. Chebotar, O. Cortes, B. David, C. Finn, C. Fu, K. Gopalakrishnan, K. Hausman, et al. Do as i can, not as i say: Grounding language in robotic affordances. *arXiv preprint arXiv:2204.01691*, 2022.
- [19] W. Yu, N. Gileadi, C. Fu, S. Kirmani, K.-H. Lee, M. G. Arenas, H.-T. L. Chiang, T. Erez, L. Hasenclever, J. Humplik, et al. Language to rewards for robotic skill synthesis. *arXiv preprint arXiv:2306.08647*, 2023.
- [20] T. Howell, N. Gileadi, S. Tunyasuvunakool, K. Zakka, T. Erez, and Y. Tassa. Predictive sampling: Real-time behaviour synthesis with mujoco. *arXiv preprint arXiv:2212.00541*, 2022.
- [21] M. Andrychowicz, F. Wolski, A. Ray, J. Schneider, R. H. Fong, P. Welinder, B. McGrew, J. Tobin, P. Abbeel, and W. Zaremba. Hindsight experience replay. In *NIPS*, 2017.
- [22] A. G. Barto and S. Mahadevan. Recent advances in hierarchical reinforcement learning. *Discrete Event Dynamic Systems*, 13:341–379, 2003.
- [23] R. S. Sutton, D. Precup, and S. Singh. Between mdps and semi-mdps: A framework for temporal abstraction in reinforcement learning. *Artificial Intelligence*, 112(1):181–211, 1999. ISSN 0004-3702. doi:[https://doi.org/10.1016/S0004-3702\(99\)00052-1](https://doi.org/10.1016/S0004-3702(99)00052-1). URL <https://www.sciencedirect.com/science/article/pii/S0004370299000521>.
- [24] R. Parr and S. Russell. Reinforcement learning with hierarchies of machines. In M. Jordan, M. Kearns, and S. Solla, editors, *Advances in Neural Information Processing Systems*, volume 10. MIT Press, 1998.
- [25] T. G. Dietterich. Hierarchical reinforcement learning with the MAXQ value function decomposition. *CoRR*, cs.LG/9905014, 1999. URL <https://arxiv.org/abs/cs/9905014>.
- [26] P. Bacon, J. Harb, and D. Precup. The option-critic architecture. *CoRR*, abs/1609.05140, 2016.
- [27] A. Harutyunyan, P. Vrancx, P. Bacon, D. Precup, and A. Nowé. Learning with options that terminate off-policy. *CoRR*, abs/1711.03817, 2017. URL <http://arxiv.org/abs/1711.03817>.
- [28] J. Harb, P. Bacon, M. Klissarov, and D. Precup. When waiting is not an option : Learning options with a deliberation cost. *CoRR*, abs/1709.04571, 2017. URL <http://arxiv.org/abs/1709.04571>.
- [29] A. Harutyunyan, W. Dabney, D. Borsa, N. Heess, R. Munos, and D. Precup. The termination critic. *CoRR*, abs/1902.09996, 2019. URL <http://arxiv.org/abs/1902.09996>.
- [30] M. Klissarov, P. Bacon, J. Harb, and D. Precup. Learnings options end-to-end for continuous action tasks. *CoRR*, abs/1712.00004, 2017. URL <http://arxiv.org/abs/1712.00004>.
- [31] L. P. Kaelbling. Learning to achieve goals. In *IN PROC. OF IJCAI-93*, pages 1094–1098. Morgan Kaufmann, 1993.
- [32] D. Foster and P. Dayan. Structure in the space of value functions. *Machine Learning*, 49(2-3): 325–346, 2002.

- [33] M. Wulfmeier, A. Abdolmaleki, R. Hafner, J. T. Springenberg, M. Neunert, T. Hertweck, T. Lampe, N. Y. Siegel, N. Heess, and M. A. Riedmiller. Regularized hierarchical policies for compositional transfer in robotics. *CoRR*, abs/1906.11228, 2019. URL <http://arxiv.org/abs/1906.11228>.
- [34] M. Wulfmeier, D. Rao, R. Hafner, T. Lampe, A. Abdolmaleki, T. Hertweck, M. Neunert, D. Tirumala, N. Y. Siegel, N. Heess, and M. A. Riedmiller. Data-efficient hindsight off-policy option learning. *CoRR*, abs/2007.15588, 2020. URL <https://arxiv.org/abs/2007.15588>.
- [35] Y. Ding, C. Florensa, P. Abbeel, and M. Phielipp. Goal-conditioned imitation learning. In H. Wallach, H. Larochelle, A. Beygelzimer, F. d'Alché-Buc, E. Fox, and R. Garnett, editors, *Advances in Neural Information Processing Systems*, volume 32. Curran Associates, Inc., 2019. URL <https://proceedings.neurips.cc/paper/2019/file/c8d3a760ebab631565f8509d84b3b3f1-Paper.pdf>.
- [36] O. Nachum, S. Gu, H. Lee, and S. Levine. Data-efficient hierarchical reinforcement learning. *CoRR*, abs/1805.08296, 2018.
- [37] A. Levy, R. P. Jr., and K. Saenko. Hierarchical actor-critic. *CoRR*, abs/1712.00948, 2017.
- [38] K. Pertsch, Y. Lee, and J. J. Lim. Accelerating reinforcement learning with learned skill priors. *CoRR*, abs/2010.11944, 2020. URL <https://arxiv.org/abs/2010.11944>.
- [39] A. Singh, H. Liu, G. Zhou, A. Yu, N. Rhinehart, and S. Levine. Parrot: Data-driven behavioral priors for reinforcement learning. *CoRR*, abs/2011.10024, 2020. URL <https://arxiv.org/abs/2011.10024>.
- [40] M. Dalal, D. Pathak, and R. Salakhutdinov. Accelerating robotic reinforcement learning via parameterized action primitives. *CoRR*, abs/2110.15360, 2021. URL <https://arxiv.org/abs/2110.15360>.
- [41] S. Nasiriany, H. Liu, and Y. Zhu. Augmenting reinforcement learning with behavior primitives for diverse manipulation tasks. *CoRR*, abs/2110.03655, 2021. URL <https://arxiv.org/abs/2110.03655>.
- [42] H. Kress-Gazit, G. Fainekos, and G. Pappas. Translating structured english to robot controllers. *Advanced Robotics*, 22:1343 – 1359, 2008. URL <https://api.semanticscholar.org/CorpusID:7457220>.
- [43] C. Matuszek, E. V. Herbst, L. Zettlemoyer, and D. Fox. Learning to parse natural language commands to a robot control system. In *International Symposium on Experimental Robotics*, 2012. URL <https://api.semanticscholar.org/CorpusID:1658890>.
- [44] A. Ku, P. Anderson, R. Patel, E. Ie, and J. Baldrige. Room-across-room: Multilingual vision-and-language navigation with dense spatiotemporal grounding, 2020.
- [45] A. Kamath, P. Anderson, S. Wang, J. Y. Koh, A. Ku, A. Waters, Y. Yang, J. Baldrige, and Z. Parekh. A new path: Scaling vision-and-language navigation with synthetic instructions and imitation learning, 2023.
- [46] O. Mees, J. Borja-Diaz, and W. Burgard. Grounding language with visual affordances over unstructured data, 2023.
- [47] E. Jang, A. Irpan, M. Khansari, D. Kappler, F. Ebert, C. Lynch, S. Levine, and C. Finn. Bc-z: Zero-shot task generalization with robotic imitation learning, 2022.
- [48] C. Lynch, A. Wahid, J. Tompson, T. Ding, J. Betker, R. Baruch, T. Armstrong, and P. Florence. Interactive language: Talking to robots in real time, 2022.

- [49] F. Ebert, Y. Yang, K. Schmeckpeper, B. Bucher, G. Georgakis, K. Daniilidis, C. Finn, and S. Levine. Bridge data: Boosting generalization of robotic skills with cross-domain datasets, 2021.
- [50] J. Fu, A. K. Balan, S. Levine, and S. Guadarrama. From language to goals: Inverse reinforcement learning for vision-based instruction following. *ArXiv*, abs/1902.07742, 2019. URL <https://api.semanticscholar.org/CorpusID:67788344>.
- [51] S. Karamcheti, M. Srivastava, P. Liang, and D. Sadigh. Lila: Language-informed latent actions. In *Conference on Robot Learning*, 2021. URL <https://api.semanticscholar.org/CorpusID:243832934>.
- [52] H. Touvron, T. Lavril, G. Izacard, X. Martinet, M.-A. Lachaux, T. Lacroix, B. Rozière, N. Goyal, E. Hambro, F. Azhar, A. Rodriguez, A. Joulin, E. Grave, and G. Lample. Llama: Open and efficient foundation language models, 2023.
- [53] OpenAI, J. Achiam, S. Adler, S. Agarwal, L. Ahmad, I. Akkaya, F. L. Aleman, D. Almeida, J. Altenschmidt, S. Altman, S. Anadkat, R. Avila, and I. B. et al. Gpt-4 technical report, 2024.
- [54] G. Team, R. Anil, S. Borgeaud, J.-B. Alayrac, J. Yu, R. Soricut, J. Schalkwyk, A. M. Dai, A. Hauth, and K. M. et al. Gemini: A family of highly capable multimodal models, 2024.
- [55] K. Ellis, C. Wong, M. Nye, M. Sable-Meyer, L. Cary, L. Morales, L. Hewitt, A. Solar-Lezama, and J. B. Tenenbaum. Dreamcoder: Growing generalizable, interpretable knowledge with wake-sleep bayesian program learning, 2020.
- [56] J. Austin, A. Odena, M. Nye, M. Bosma, H. Michalewski, D. Dohan, E. Jiang, C. Cai, M. Terry, Q. Le, and C. Sutton. Program synthesis with large language models, 2021.
- [57] Y. Li, D. Choi, J. Chung, N. Kushman, J. Schrittwieser, R. Leblond, T. Eccles, J. Keeling, F. Gimeno, A. Dal Lago, T. Hubert, P. Choy, C. de Masson d’Autume, I. Babuschkin, X. Chen, P.-S. Huang, J. Welbl, S. Gowal, A. Cherepanov, J. Molloy, D. J. Mankowitz, E. Sutherland Robson, P. Kohli, N. de Freitas, K. Kavukcuoglu, and O. Vinyals. Competition-level code generation with alphacode. *Science*, 378(6624):1092–1097, Dec. 2022. ISSN 1095-9203. doi:10.1126/science.abq1158. URL <http://dx.doi.org/10.1126/science.abq1158>.
- [58] L. Tian, K. Ellis, M. Kryven, and J. Tenenbaum. Learning abstract structure for drawing by efficient motor program induction. In H. Larochelle, M. Ranzato, R. Hadsell, M. Balcan, and H. Lin, editors, *Advances in Neural Information Processing Systems*, volume 33, pages 2686–2697. Curran Associates, Inc., 2020. URL [https://proceedings.neurips.cc/paper\\_files/paper/2020/file/1c104b9c0accfca52ef21728eaf01453-Paper.pdf](https://proceedings.neurips.cc/paper_files/paper/2020/file/1c104b9c0accfca52ef21728eaf01453-Paper.pdf).
- [59] D. Trivedi, J. Zhang, S.-H. Sun, and J. J. Lim. Learning to synthesize programs as interpretable and generalizable policies, 2022.
- [60] P. Sharma, B. Sundaralingam, V. Blukis, C. Paxton, T. Hermans, A. Torralba, J. Andreas, and D. Fox. Correcting robot plans with natural language feedback. *arXiv preprint arXiv:2204.05186*, 2022.
- [61] P. Goyal, S. Niekum, and R. J. Mooney. Using natural language for reward shaping in reinforcement learning, 2019.
- [62] S. Nair, E. Mitchell, K. Chen, b. ichter, S. Savarese, and C. Finn. Learning language-conditioned robot behavior from offline data and crowd-sourced annotation. In A. Faust, D. Hsu, and G. Neumann, editors, *Proceedings of the 5th Conference on Robot Learning*, volume 164 of *Proceedings of Machine Learning Research*, pages 1303–1315. PMLR, 08–11 Nov 2022. URL <https://proceedings.mlr.press/v164/nair22a.html>.

- [63] D. Bahdanau, F. Hill, J. Leike, E. Hughes, S. Hosseini, P. Kohli, and E. Grefenstette. Learning to understand goal specifications by modelling reward. In *International Conference on Learning Representations*, 2018. URL <https://api.semanticscholar.org/CorpusID:52911374>.
- [64] H. Hu and D. Sadigh. Language instructed reinforcement learning for human-ai coordination. ICML'23. JMLR.org, 2023.
- [65] M. Kwon, S. M. Xie, K. Bullard, and D. Sadigh. Reward design with language models. *arXiv preprint arXiv:2303.00001*, 2023.
- [66] J. Lin, D. Fried, D. Klein, and A. Dragan. Inferring rewards from language in context. In S. Muresan, P. Nakov, and A. Villavicencio, editors, *Proceedings of the 60th Annual Meeting of the Association for Computational Linguistics (Volume 1: Long Papers)*, pages 8546–8560, Dublin, Ireland, May 2022. Association for Computational Linguistics. doi:10.18653/v1/2022.acl-long.585. URL <https://aclanthology.org/2022.acl-long.585>.
- [67] H.-T. L. Chiang, A. Faust, M. Fiser, and A. Francis. Learning navigation behaviors end-to-end with autorl. *IEEE Robotics and Automation Letters*, 4:2007–2014, 2018. URL <https://api.semanticscholar.org/CorpusID:59600008>.
- [68] O. Nachum, S. S. Gu, H. Lee, and S. Levine. Data-efficient hierarchical reinforcement learning. *Advances in neural information processing systems*, 31, 2018.
- [69] A. Levy, G. Konidaris, R. Platt, and K. Saenko. Learning multi-level hierarchies with hindsight. In *International Conference on Learning Representations*, 2018.
- [70] E. Chane-Sane, C. Schmid, and I. Laptev. Goal-conditioned reinforcement learning with imagined subgoals. In *International Conference on Machine Learning*, pages 1430–1440. PMLR, 2021.
- [71] J. Lin, D. Fried, D. Klein, and A. Dragan. Inferring rewards from language in context. *arXiv preprint arXiv:2204.02515*, 2022.
- [72] T. Haarnoja, A. Zhou, P. Abbeel, and S. Levine. Soft actor-critic: Off-policy maximum entropy deep reinforcement learning with a stochastic actor. *CoRR*, abs/1801.01290, 2018. URL <http://arxiv.org/abs/1801.01290>.
- [73] A. Gupta, V. Kumar, C. Lynch, S. Levine, and K. Hausman. Relay policy learning: Solving long horizon tasks via imitation and reinforcement learning. *Conference on Robot Learning (CoRL)*, 2019.
- [74] D. P. Kingma and J. Ba. Adam: A method for stochastic optimization, 2014. URL <http://arxiv.org/abs/1412.6980>. cite arxiv:1412.6980Comment: Published as a conference paper at the 3rd International Conference for Learning Representations, San Diego, 2015.
- [75] I. Kostrikov, K. K. Agrawal, D. Dwibedi, S. Levine, and J. Tompson. Discriminator-actor-critic: Addressing sample inefficiency and reward bias in adversarial imitation learning. *arXiv preprint arXiv:1809.02925*, 2018.
- [76] J. Fu, A. Kumar, O. Nachum, G. Tucker, and S. Levine. D4RL: datasets for deep data-driven reinforcement learning. *CoRR*, abs/2004.07219, 2020. URL <https://arxiv.org/abs/2004.07219>.

## A Appendix

### A.1 Implementation details

We conduct our experiments on two systems, each equipped with Intel Core i7 processors, 48GB of RAM, and Nvidia GeForce GTX 1080 GPUs. We also report the timesteps required for running the experiments. In our experiments, the actor and critic networks are designed as three-layer, fully connected neural networks with 512 neurons per layer. In the maze navigation task, a 7-degree-of-freedom (7-DoF) robotic arm navigates a four-room maze, with its closed gripper (fixed at table height) moving through the maze to reach the goal position. For the pick and place task, the 7-DoF robotic arm’s gripper locates a square block, picks it up, and delivers it to the goal position. In bin environment, the gripper has to pick up the block and place it in a specific bin. In the kitchen task, a 9-DoF Franka robot executes a pre-defined complex task, specifically opening the microwave door, to achieve the final goal. To ensure fair comparisons, we maintain consistency across all baselines by keeping parameters such as neural network layer width, number of layers, choice of optimizer, and SAC implementation parameters the same wherever possible.

```
activation: tanh [activation for hierarchical policies]
layers: 3 [number of layers in the critic/actor networks]
hidden: 512 [number of neurons in each hidden layers]
Q.lr: 0.001 [critic learning rate]
pi.lr: 0.001 [actor learning rate]
buffer.size: int(1E7) [for experience replay]
tau: 0.8 [polyak averaging coefficient]
clip_obs: 200 [clip observation]
n.cycles: 1 [per epoch]
n.batches: 10 [training batches per cycle]
batch.size: 1024 [batch size hyper-parameter]
random.eps: 0.2 [percentage of time a random action is taken]
alpha: 0.05 [weightage parameter for SAC]
noise.eps: 0.05 [std of gaussian noise added to not-completely-random actions]
norm.eps: 0.01 [epsilon used for observation normalization]
norm.clip: 5 [normalized observations are cropped to this values]
adam.beta1: 0.9 [beta 1 for Adam optimizer]
adam.beta2: 0.999 [beta 2 for Adam optimizer]
```

### A.2 Environment details

In this subsection, we provide the environment and implementation details for all the tasks:

**Maze navigation environment** In this environment, a 7-DOF robotic arm gripper navigates through randomly generated four-room mazes to reach the goal position. The gripper remains closed and fixed at table height, with the positions of walls and gates randomly determined. The table is divided into a rectangular  $W \times H$  grid, and the vertical and horizontal wall positions,  $W_P$  and  $H_P$ , are randomly selected from  $(1, W - 2)$  and  $(1, H - 2)$ , respectively. In the constructed four-room environment, the four gate positions are randomly chosen from  $(1, W_P - 1)$ ,  $(W_P + 1, W - 2)$ ,  $(1, H_P - 1)$ , and  $(H_P + 1, H - 2)$ .

In the maze environment, the state is represented as the vector  $[dx, M]$ , where  $dx$  denotes the current gripper position and  $M$  is the sparse maze array. The higher-level policy input is a concatenated vector  $[dx, M, g]$ , where  $g$  is the target goal position. The lower-level policy input is a concatenated vector  $[dx, M, s_g]$ , where  $s_g$  is the sub-goal provided by the higher-level policy.  $M$  is a discrete 2D one-hot vector array, with 1 indicating the presence of a wall block. The lower primitive action  $a$  is a 4-dimensional vector, with each dimension  $a_i \in [0, 1]$ . The first three dimensions provide offsets to



be scaled and added to the gripper position for movement. The last dimension controls the gripper, with 0 indicating a closed gripper and 1 indicating an open gripper.

**Pick and place and bin environments** In this subsection, we describe the environment details for the pick and place and bin tasks. The state is represented as the vector  $[dx, o, q, e]$ , where  $dx$  is the current gripper position,  $o$  is the position of the block object on the table,  $q$  is the relative position of the block with respect to the gripper, and  $e$  includes the linear and angular velocities of both the gripper and the block object. The higher-level policy input is a concatenated vector  $[dx, o, q, e, g]$ , where  $g$  is the target goal position. The lower-level policy input is a concatenated vector  $[dx, o, q, e, s_g]$ , where  $s_g$  is the sub-goal provided by the higher-level policy. In our experiments, the sizes of  $dx$ ,  $o$ ,  $q$ , and  $e$  are set to 3, 3, 3, and 11, respectively. The lower primitive action  $a$  is a 4-dimensional vector with each dimension  $a_i \in [0, 1]$ . The first three dimensions provide gripper position offsets, and the last dimension controls the gripper. During training, the positions of the block object and the goal are randomly generated (the block is always initialized on the table, and the goal is always above the table at a fixed height).

**Franka kitchen environment** For this environment please refer to the D4RL environment [76]. In this environment, the franka robot has to perform a complex multi-stage task in order to achieve the final goal.

### A.3 Full Prompts

In this section, we provide detailed prompts for motion description and reward translator for all the environments.

#### Motion Descriptor Prompt for Maze Navigation environment

We want you to generate a random position for an object within the table following the description and rules.

[Description]

1. There is a table which can be represented as a matrix of (num\_1, num\_2).
2. Generate walls within the table by choosing a random row and random column and blocking all of (num\_1+num\_2) cells.
3. Generate four random cells from the (num\_1+num\_2) marked as walls. Remove the blocks from these cells and mark them as gates.
4. Generate final position for the object like CHOICE:[cuboid,apple,ball] with the (x,y) co-ordinates between (num\_4,num\_5) and height is at table height in the bottom right room and bottom right corner.

Rules

1. The robot is a 7-DOF robotic arm gripper.
2. The height of the table is table\_height=0.42 cm.
3. If you see num\_1 replace it with an integer within 10 and 20.
4. If you see num\_2 replace it with an integer within 10 and 20.
5. If you see phrases like CHOICE: [choice1, choice2, ...], it means you should replace the entire phrase with one of the choices listed.
6. Please remember that the final position cannot coincide with gates, walls or starting position location.
7. The starting position of the location is (1,3)

### Reward Generator Prompt for Maze Navigation maze environment

We have a description of a robot's motion and we want you to turn that into the corresponding program with following functions:

```
def reset_environment()
def set_Gripper_Pos(x_pos, y_pos, z_pos)
x_pos: position of x-coordinate of the gripper of robot arm.
y_pos: position of y-coordinate of the gripper of robot arm.
z_pos: position of z-coordinate (height) of the gripper of robot arm.
generate_maze()
do_simulation()
```

Example answer code:

```
import numpy as np reset_environment()
#This is a new task so reset environment else we do not need it.
set_Gripper_Pos(3.0,2.0,0.56)
set_Gripper_Pos(4.45,3.56,0.48)
set_Gripper_Pos(6.85,7.36,0.64)
generate_maze()
#generate maze with all the constarints
do_simulation()
#run the simulation
```

### Motion Descriptor Prompt for Pick and Place Environment

We want you to generate a random position for an object within the table following the description and rules.

[ Description]

1. There is a table which can be represented as a matrix of (num\_1, num\_2) and height (num\_3).
2. Generate final position for the object like CHOICE:[cuboid,apple,ball] with the (x,y) co-ordinates between (num\_4,num\_5) and height (num\_6).

Rules:

1. The robot is a 7-DOF robotic arm gripper.
2. The height of the table is table\_height=0.42 cm.
3. The max height the arm can reach is max\_height=0.66 cm.
4. If you see num\_1 replace it with an integer within 10 and 20.
5. If you see num\_2 replace it with an integer within 10 and 20.
6. If you see num\_3 replace it with 0.42.
7. If you see phrases like CHOICE: [choice1, choice2, ...], it means you should replace the entire phrase with one of the choices listed.
8. Please remember that there is an object on the table.
9. The block is light enough for the robot to pick up and hold in the air for a long time, like 4 seconds.

## Reward Generator Prompt for Pick and Place Environment

We have a description of a robot's motion and we want you to turn that into the corresponding program with following functions:

```
def reset_environment()
```

```
def set_Gripper_Pos(x_pos, y_pos, z_pos)
```

x\_pos: position of x-coordinate of the gripper of robot arm.

y\_pos: position of y-coordinate of the gripper of robot arm.

z\_pos: position of z-coordinate (height) of the gripper of robot arm.

```
def generate_Object_Pos()
```

```
def do_simulation()
```

Example answer code:

```
import numpy as np
```

```
reset_environment()
```

```
#This is a new task so reset environment else we do not need it.
```

```
set_Gripper_Pos(3.0,2.0,0.56)
```

```
set_Gripper_Pos(4.45,3.56,0.48)
```

```
set_Gripper_Pos(6.85,7.36,0.64)
```

```
do_simulation()
```

```
#run the simulation
```

## Motion descriptor prompt for Bin environment

We want you to generate a random position for a bin and an object within the bin following the description and rules. [Description]

1. There is a table which can be represented as a matrix of (num\_1, num\_2) and height (num\_3).
2. There is a bin on the table.
3. Generate a random position for the bin within the table.
4. Generate a final position (x,y) for placing the object like CHOICE:[cuboid,apple,ball] within the bin

[Rules]

1. The robot is a 7-DOF robotic arm gripper.
2. The height of the table is table\_height=0.42 cm.
3. The max height the arm can reach is max\_height=0.66 cm.
4. If you see num\_1 replace it with an integer within 10 and 20.
5. If you see num\_2 replace it with an integer within 10 and 20.
6. If you see num\_3 replace it with 0.42.
7. The bin has to be completely within the table. No part of the bin can be outside of the table.
8. The height, width and length of the table are 0.1 cm, respectively.
9. The final position of the object should be continuous and at the centre of the bin.
10. If you see phrases like CHOICE: [choice1, choice2, ...], then you should be replacing the entire phrase with one of the choices listed.
11. Please remember that there is always a bin on the table.
12. The object is light enough for the robot to pick up and hold in the air for a long time, like 4 seconds.

### Reward generator prompt for Bin environment

We have a description of a robot's motion and we want you to turn that into the corresponding program with following functions:

```
def reset_environment()
def set_Gripper_Pos(x_pos, y_pos, z_pos)
x_pos: position of x-coordinate of the gripper of robot arm.
y_pos: position of y-coordinate of the gripper of robot arm.
z_pos: position of z-coordinate (height) of the gripper of robot arm.
def generate_Bin()
def do_simulation()
Example answer code:
import numpy as np
reset_environment()
#This is a new task so reset environment else we do not need it.
set_Gripper_Pos(3.0,2.0,0.56)
set_Gripper_Pos(4.45,3.56,0.48)
set_Gripper_Pos(6.85,7.36,0.64)
generate_Bin()
#generate bin with all the constraints
do_simulation()
#run the simulation
```

### Motion descriptor prompt for Franka kitchen environment

We want you to generate a random position for the door of a microwave and gas-knob following the description and rules.

[Description]

1. There is a microwave and gas knob.
2. Open the microwave door to a certain point num\_1.
3. Turn the gas knob to co-ordinates (num\_2, num\_3).

[Rules]

1. The robot is a 7-DOF robotic arm gripper.
2. The height of the table is table\_height=0.42 cm.
3. The max height the arm can reach is max\_height=0.66 cm.
4. If you see num\_1 replace it with a continuous number -0.75.
5. If you see num\_2 replace it with a continuous number -0.88.
6. If you see num\_2 replace it with a continuous number -0.01.

**Reward generator prompt for Franka kitchen environment** We have a description of a robot's motion and we want you to turn that into the corresponding program with following functions:

```
def reset_environment()
def set_microwave_Pos(joint_1_Pos)
joint_1_Pos: Position of joint to determine whether microwave door is open or not.
def set_gas_Knob_Pos(joint_1_Pos, joint_2_Pos)
joint_1_Pos: x co-ordinate of the gas knob.
joint_2_pos: y co-ordinate of the gas knob.
def do_simulation()
Example answer code:
import numpy as np
reset_environment()
#This is a new task so reset environment else we do not need it.
set_microwave_Pos(-0.75)
set_microwave_Pos(-0.55)
set_gas_Knob_Pos(-0.88, -0.01)
set_gas_Knob_Pos(-0.75, -0.1)
do_simulation()
#run the simulation
```



## A.4 Sample Codes

In this section, we show sampled responses for all four environments mentioned in this paper for a better understanding of the LGR2 method. We sample 2-3 responses for each method to show both successful and failed results. **Sample Code for Maze Navigation environment** This section provides the sample code for the Maze Navigation environment generated by GPT-3.5.

```
import numpy as np
def reset_environment():
    print("Environment reset.")
def set_Gripper_Pos(x_pos, y_pos, z_pos):
    print(f"Setting gripper position to x: x_pos, y: y_pos, z: z_pos.")
def generate_maze():
    print("Generating maze...")
def do_simulation():
    print("Running simulation...")
reset_environment()
# Set the gripper positions for linear motion
set_Gripper_Pos(3.0, 2.0, 0.56)
set_Gripper_Pos(4.45, 3.56, 0.48)
set_Gripper_Pos(6.85, 7.36, 0.64)
# Generate maze
generate_maze()
# Run simulation
do_simulation()
```

### Sample Code for Pick and Place environment

This section provides the sample code for the Pick and Place environment generated by GPT-3.5.

```
import numpy as np
def reset_environment():
    print("Environment reset.")
def set_Gripper_Pos(x_pos, y_pos, z_pos):
    print(f"Setting gripper position to x: x_pos, y: y_pos, z: z_pos.")
def generate_Object_Pos(): print("Generating object position.")
def do_simulation():
    print("Simulation started.")
reset_environment()
set_Gripper_Pos(3.0, 2.0, 0.56)
set_Gripper_Pos(4.45, 3.56, 0.48)
set_Gripper_Pos(6.85, 7.36, 0.64)
generate_Object_Pos()
do_simulation()
```

### Sample Code for Bin environment

This section provides the sample code for the Bin environment generated by GPT-3.5.

```
import numpy as np
def reset_environment():
    print("Environment reset.")
def set_Gripper_Pos(x_pos, y_pos, z_pos):
    print(f"Setting gripper position to x: x_pos, y: y_pos, z: z_pos.")
def generate_Bin():
    print("Generating bin with all constraints.")
def do_simulation():
    print("Simulation started.")
reset_environment()
set_Gripper_Pos(3.0, 2.0, 0.56)
set_Gripper_Pos(4.45, 3.56, 0.48)
set_Gripper_Pos(6.85, 7.36, 0.64)
generate_Bin()
do_simulation()
```

## Sample Code for Franka kitchen environment

This section provides the sample code for the Franka kitchen environment generated by GPT-3.5.

```
import numpy as np
def reset_environment():
    print("Environment reset")
def set_microwave_Pos(joint_1_Pos):
    print(f"Setting microwave door position to joint_1_Pos.")
def set_gas_Knob_Pos(joint_1_Pos, joint_2_Pos):
    print(f"Setting gas knob position to x: joint_1_Pos, y: joint_2_Pos.")
def do_simulation():
    print("Simulation started.")
reset_environment()
set_microwave_Pos(-0.75)
set_microwave_Pos(-0.55)
set_gas_Knob_Pos(-0.88, -0.01)
set_gas_Knob_Pos(-0.75, -0.1)
do_simulation()
```

### A.5 Impact Statement

Our proposed approach and algorithm are not expected to bring about immediate technological breakthroughs. Instead, our primary contributions are conceptual, emphasizing fundamental aspects of Hierarchical Reinforcement Learning (HRL). This foundational work sets the stage for future research and could foster advancements in HRL and its associated areas.

### A.6 Qualitative visualizations

We provide qualitative visualizations for all the environments:

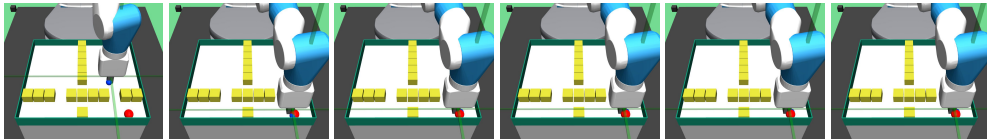

Figure 5: **Successful visualization:** The visualization is a successful attempt at performing maze navigation task

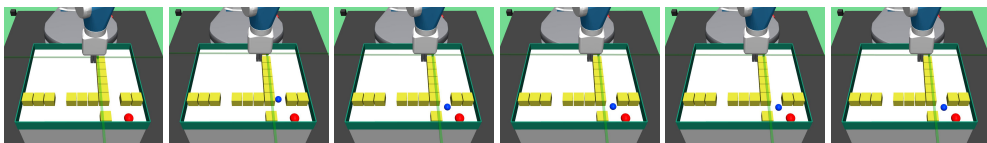

Figure 6: **Failed visualization:** The visualization is a failed attempt at performing maze navigation task.

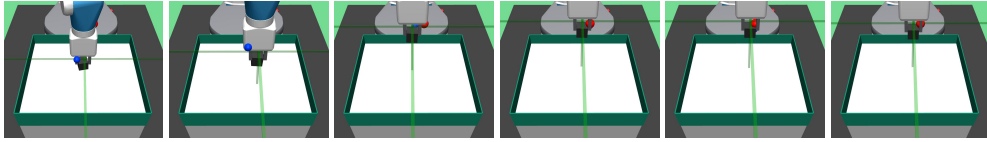

Figure 7: **Successful visualization:** The visualization is a successful attempt at performing pick and place task.

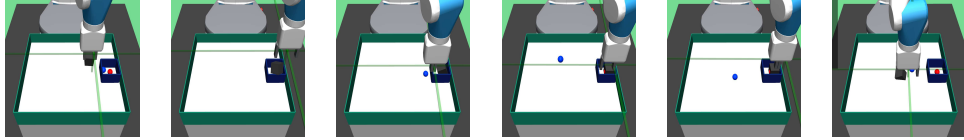

Figure 8: **Successful visualization:** The visualization is a successful attempt at performing bin task.

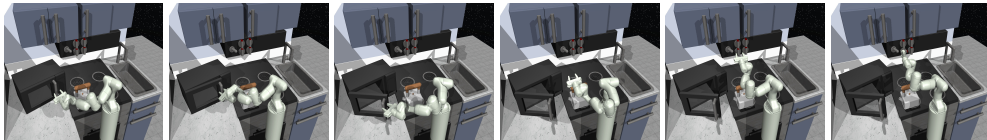

Figure 9: **Successful visualization:** The visualization is a successful attempt at performing kitchen task.

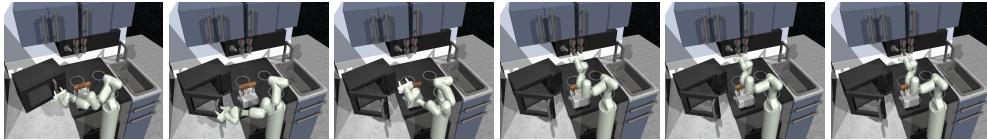

Figure 10: **Failed visualization:** The visualization is a failed attempt at performing kitchen task.