

V²A-Mark: Versatile Deep Visual-Audio Watermarking for Manipulation Localization and Copyright Protection

Xuanyu Zhang*
Peking University
Shenzhen Graduate School
Shenzhen, China
2201212868@stu.pku.edu.cn

Youmin Xu
Peking University
Shenzhen Graduate School
Shenzhen, China
youmin.xu@stu.pku.edu.cn

Runyi Li
Peking University
Shenzhen Graduate School
Shenzhen, China
lirunyi@stu.pku.edu.cn

Jiwen Yu
Peking University
Shenzhen Graduate School
Shenzhen, China
yujiwen@stu.pku.edu.cn

Weiqi Li
Peking University
Shenzhen Graduate School
Shenzhen, China
liweiqi@stu.pku.edu.cn

Zhipei Xu
Peking University
Shenzhen Graduate School
Shenzhen, China
2401212880@stu.pku.edu.cn

Jian Zhang[†]
Peking University
Shenzhen Graduate School
Shenzhen, China
zhangjian.sz@pku.edu.cn

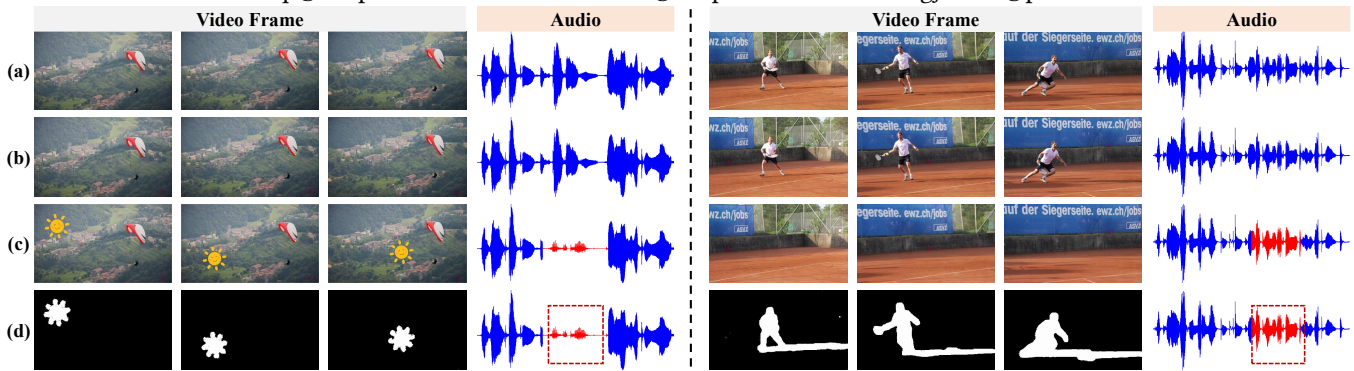

Figure 1: Two application instances of V²A-Mark. (a): Original video, (b): Watermarked video, (c) Tampered video, (d) Tampered visual areas and audio period. We propose a versatile deep visual-audio proactive forensics framework, dubbed V²A-Mark. Our method can embed an invisible cross-modal watermark into the original video frames and audio (a), producing watermarked video frames and audio (b). If they are tampered by object removal, copy-and-paste, or any editing methods during network transmission (c), we can accurately get the predicted visual tampered areas, audio tampered periods, and the copyright (d).

Abstract

AI-generated video has revolutionized short video production, film-making, and personalized media, making video local editing an essential tool. However, this progress also blurs the line between reality and fiction, posing challenges in multimedia forensics. To solve this urgent issue, V²A-Mark is proposed to address the limitations of current video tampering forensics, such as poor generalizability, singular function, and single modality focus. Combining the fragility of video-into-video steganography with deep robust watermarking, our method can embed invisible visual-audio localization watermarks and copyright watermarks into the original

video frames and audio, enabling precise manipulation localization and copyright protection. We also design a temporal alignment and fusion module and degradation prompt learning to enhance the localization accuracy and decoding robustness. Meanwhile, we introduce a sample-level audio localization method and a cross-modal copyright extraction mechanism to couple the information of audio and video frames. The effectiveness of V²A-Mark has been verified on a visual-audio tampering dataset, emphasizing its superiority in localization precision and copyright accuracy, crucial for the sustainable development of video editing in the AIGC video era.

CCS Concepts

• Computing methodologies → Computer vision.

Keywords

Manipulation Localization, Copyright Protection, Watermarking

ACM Reference Format:

Xuanyu Zhang, Youmin Xu, Runyi Li, Jiwen Yu, Weiqi Li, Zhipei Xu, and Jian Zhang. 2024. V²A-Mark: Versatile Deep Visual-Audio Watermarking for Manipulation Localization and Copyright Protection. In *Proceedings of the 32nd ACM International Conference on Multimedia (MM '24)*, October 28–November 1, 2024, Melbourne, VIC, Australia. ACM, New York, NY, USA, 10 pages. <https://doi.org/10.1145/3664647.3680801>

*Also with Peking University Shenzhen Graduate School-Rabbitpre AIGC Joint Research Laboratory.

[†]Corresponding author.

Permission to make digital or hard copies of all or part of this work for personal or classroom use is granted without fee provided that copies are not made or distributed for profit or commercial advantage and that copies bear this notice and the full citation on the first page. Copyrights for components of this work owned by others than the author(s) must be honored. Abstracting with credit is permitted. To copy otherwise, or republish, to post on servers or to redistribute to lists, requires prior specific permission and/or a fee. Request permissions from permissions@acm.org.

MM '24, October 28–November 1, 2024, Melbourne, VIC, Australia

© 2024 Copyright held by the owner/author(s). Publication rights licensed to ACM.

ACM ISBN 979-8-4007-0686-8/24/10

<https://doi.org/10.1145/3664647.3680801>

1 Introduction

2024 is regarded as a boom year of AI-generated video. Benefited from diffusion models and the influx of extensive video data, a large amount of video generation models and editing methods [3, 9, 12, 14, 25, 46, 62] have emerged, offering convenience in the production of short videos, film-making, advertising, and customized media. Specifically, local editing [36, 37, 45, 50, 64, 67] has become a vital feature of AI video generation tools. For instance, AI dubbing software, capable of altering the facial expressions, lip movements, and voices of characters in a video, is extensively used in simultaneous interpretation and movie dubbing. However, this powerful editing capability is a double-edged sword. It not only facilitates video editors and creators but also blurs the boundaries between reality and forgery, posing new challenges for tamper forensics. Therefore, it is urgent to develop a method for visual-audio tamper localization and copyright protection, which can be widely used in court evidence, rumor verification, and beyond.

Most visual-audio manipulation localization methods [30, 31, 35, 41, 51, 61] are passive, which mainly rely on excavating the temporal and spatial anomalous traces from the suspect videos themselves to predict tampered regions. However, these methods often prove ineffective against AIGC-based video tampering, which exhibits fewer artifacts and more realistic texture details. Additionally, most passive black-box localization networks typically require the introduction of specific types of manipulation during training, rendering them ineffective against previously unseen editing methods. Therefore, these methods have obvious shortcomings in generalization ability and accuracy of manipulation localization.

Given the inherent drawbacks of passive detection and localization, visual-audio watermarking has become a consensus technology for proactive forensics. However, existing video watermarking methods are fraught with some issues. **1) Poor Accuracy:** Although traditional fragile watermarking methods [15, 28] can achieve block-wise manipulation location via hash verification, their accuracy is unsatisfactory and difficult to reach the pixel-wise localization. **2) Singular Function:** Video manipulation localization and copyright protection tend to be treated as two distinct and separate tasks. Tampering forensic methods lack the capability for copyright protection, limiting the applicative value of their prediction results. Simultaneously, robust deep video watermarking methods [33, 66] can only provide copyright protection and are unable to precisely pinpoint the locations of tampering within videos. **3) Single Modality:** Most current forensic methods often only focus on a single visual [68] or audio modality [44] and have not established effective cross-modal interaction mechanisms. How to effectively utilize cross-modal information [7, 8] for manipulation localization and cross-verification of copyrights is an urgent issue.

To address the above-mentioned issues, we propose an innovative multi-functional and multi-modal watermarking method, dubbed **V²A-Mark**. In the visual section, integrating the fragility of video-into-video steganography and the robustness of bit-into-video watermarking, we simultaneously embed both localization and copyright watermarks into the video frames, enabling the decoding network to independently extract tampered areas and copyright information. In the audio section, we insert a versatile watermark into the host audio and use it to assist in the reconstruction

of visual copyright information, while identifying the tampered periods in the audio. Thus, our contributions are as follows.

□ (1) We design an innovative deep versatile, cross-modal video watermarking framework, dubbed **V²A-Mark**, for visual-audio manipulation localization and copyright protection. It can embed invisible localization and copyright watermarks into video frames and audio samples simultaneously, and then obtain visual tampered area, audio tampered period, and exact copyright information in the decoding end.

□ (2) In the visual section, we develop a **temporal alignment and fusion module** (TAFM) and a **degradation prompt learning** (DPL) mechanism, enabling the network to fully leverage temporal information for high-fidelity concealment and robust prediction of localization and copyright results.

□ (3) In the audio section, we embed sample-level versatile watermarks into the pristine audio to identify the tampered samples and extract the copyright information. Furthermore, a cross-modal extraction mechanism is proposed to obtain the final copyright from the information of audio and video frames.

□ (4) The effectiveness of our method has been verified on our constructed visual-audio tampering dataset. Compared to other approaches, our method has notable merits in localization accuracy, generalization abilities, and copyright precision without any labeled data or additional training required for specific tampering types.

2 Related Works

2.1 Manipulation Localization

Prevalent image forensic techniques have focused on localizing specific types of manipulations via exploring artifacts and anomalies in tampered images [6, 16, 22, 24, 26, 31, 47, 52, 54, 59–61]. Recently, HiFi-Net [13] used multi-branch feature extractor and localization modules for AIGC-synthesized and edited images. SAFL-Net [47] designed a feature extraction approach to learn semantic-agnostic features with specific modules and auxiliary tasks. IML-ViT [35] firstly introduced vision transformer for image manipulation localization and modified ViT components to address three unique challenges in high resolution, multi-scale, and edge supervision. MaLP [2] introduced a large number of forgery images to learn the matched template and localization network. Targeted at video tamper localization, [51] exploited the spatial and temporal traces left by inpainting and guided the extraction of inter-frame residual with optical-flow-based frame alignment. UVL [41] designed a novel hybrid multi-stage architecture that combines CNNs and ViTs to effectively capture both local and global video features. However, the above-mentioned passive localization methods are often limited in terms of generalization and localization accuracy, which usually work on known tampering types that have been trained.

2.2 Video Watermarking and Steganography

Video watermarking is a widely accepted forensic method, which can be broadly utilized for the verification, authenticity, and traceability of images. In terms of robustness levels for extraction, video watermarking can be divided into fragile and robust watermarking [23, 58, 68]. Although classical fragile watermarking [15, 17, 20, 28, 29, 39, 40, 48] can achieve block-wise tamper localization, their

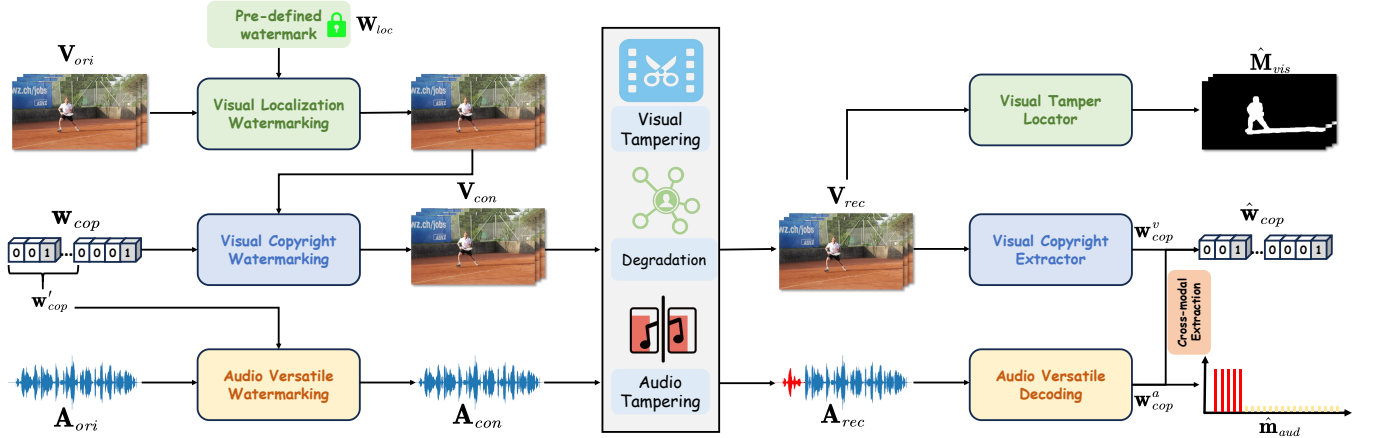

Figure 2: Overall Framework of our proposed V²A-Mark. We embed pre-defined visual localization watermark W_{loc} , copyright watermark w_{cop} and audio versatile watermark w'_{cop} into the original video frames and audio to produce V_{con} and A_{con} . If undergoing malicious tampering, we can still extract exact copyright \hat{w}_{cop} , visual tampered masks \hat{M}_{vis} and audio tampered periods \hat{m}_{aud} . Note that \hat{w}_{cop} is obtained via our cross-modal extraction mechanism, combining w_{cop}^a and w_{cop}^v .

localization accuracy and flexibility are unsatisfactory. Therefore, how to realize joint pixel-level tamper localization and copyright protection has still a lot of room for research.

Thanks to the development of deep learning, learning-based video watermarking has attracted increased attention. For deep robust video watermarking, an intuitive approach is to apply image watermarking methods [18, 34, 56, 63, 69] frame by frame. For instance, HiDDen [69] firstly designed a deep encoder-decoder network to hide and recover bitstream. Moreover, many differentiable distortion layers such as JPEG compression, screen-shooting, and face swapping [1, 10, 32, 53] were incorporated to enhance the robustness of the encoder-decoder watermarking framework. Meanwhile, CIN [34] and FIN [11] utilized flow-based models to further improve the fidelity of container images. However, these deep watermarking methods have a singular function and cannot accurately localize the tampered areas. Moreover, there are other explorations to address video degradation and temporal correlations. For instance, DVMark [33] used an end-to-end trainable multi-scale network for robust watermark embedding and extraction across various spatial-temporal clues. REVMark [66] focused on improving the robustness against H.264/AVC compression via the temporal alignment module and DiffH264 distortion layer. LF-VSN [38] utilized invertible blocks and the redundancy prediction module to realize large-capacity and flexible video steganography.

3 Methods

3.1 Overall Framework of V²A-Mark

To achieve multimodal, versatile, and proactive manipulation localization and copyright protection, as shown in Fig. 2, the proposed V²A-Mark consists of two key sections, namely the visual hiding and decoding (Sec. 3.3), and the audio hiding and decoding (Sec. 3.4). In the visual hiding section, we sequentially embed pre-defined visual localization watermarks $W_{loc} \in \mathbb{R}^{H \times W \times T \times C}$ and the copyright watermark $w_{cop} \in \{0, 1\}^k$ into the original video sequences $V_{ori} \in \mathbb{R}^{H \times W \times T \times C}$ to get the container video $V_{con} \in \mathbb{R}^{H \times W \times T \times C}$. In the audio hiding section, we add versatile watermark $w'_{cop} \in \{0, 1\}^n$

to the original audio $A_{ori} \in \mathbb{R}^L$ in a sample-level manner to obtain the $A_{con} \in \mathbb{R}^L$. Note that T and L denote the number of video frames and length of the audio, respectively. “Versatile” means that this audio watermarking and decoding module can achieve audio manipulation localization and copyright protection at the same time. Moreover, the potential impacts on container videos during network transmission can be divided into two types, namely malicious tampering and common degradation. Thus, the network transmission pipeline of video frames and audio is modeled as follows.

$$V_{rec} = \mathcal{D}_v(V_{con} \odot (1 - M) + \mathcal{T}_v(V_{con}) \odot M), \quad (1)$$

$$A_{rec} = \mathcal{D}_a(A_{con} \odot (1 - m) + \mathcal{T}_a(A_{con}) \odot m), \quad (2)$$

where $\mathcal{T}_v(\cdot)$ and $\mathcal{T}_a(\cdot)$ respectively denote the video and audio manipulation function. $\mathcal{D}_v(\cdot)$ and $\mathcal{D}_a(\cdot)$ respectively denote the video and audio degradation operation. $M \in \mathbb{R}^{H \times W \times T}$ and $m \in \mathbb{R}^L$ respectively denote the tempered visual masks and audio periods.

Upon receiving the video V_{rec} and audio A_{rec} , we attempt to recover the previously embedded watermarks on different robustness levels and conduct corresponding forensics based on the extracted watermarks. In the visual decoding section, our framework precisely extracts the tampered video masks \hat{M}_{vis} and copyright information w_{cop}^v . Concurrently, as shown in Fig. 2, the tampered periods \hat{m}_{aud} and the copyright w_{cop}^a in the audio will be extracted from the audio versatile decoding module. The final restored copyright information of the video \hat{w}_{cop} will be obtained via cross-modal combination of w_{cop}^a and w_{cop}^v (Sec. 3.5). Finally, the visual-audio tamper forensics process of V²A-Mark can be categorized into several scenarios.

- (1) $\hat{w}_{cop} \neq w_{cop}$: Suspicious V_{rec} was not processed via our V²A-Mark, and we are also unable to ascertain the authenticity of the corresponding audio A_{rec} . They cannot be used as evidence.
- (2) $\hat{w}_{cop} \approx w_{cop} \wedge (\hat{M}_{vis} \neq \mathbf{0} \vee \hat{m}_{aud} \neq \mathbf{0})$: Suspicious V_{rec} or A_{rec} has undergone tampering, disqualifying it as valid evidence.
- (3) $\hat{w}_{cop} \approx w_{cop} \wedge \hat{M}_{vis} \approx \mathbf{0} \wedge \hat{m}_{aud} \approx \mathbf{0}$: Suspicious V_{rec} and A_{rec} are both credible and have not been tampered with. V²A-Mark ensures the authenticity and integrity of this video.

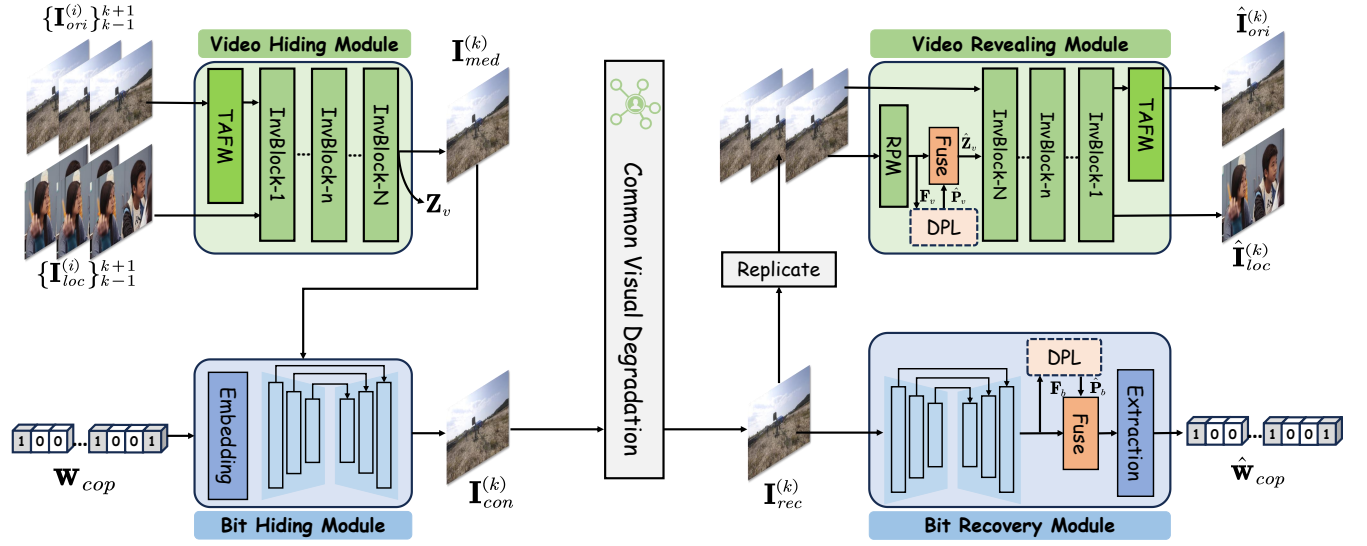

Figure 3: Details of the network structure and training process of the proposed V^2A -Mark. We design the temporal alignment and fusion module (TAFM) and degradation prompt learning (DPL) to enhance the robustness and fidelity of our method.

3.2 Preliminaries and Motivations

Previous work EditGuard [65] has validated the feasibility of using the fragility and locality of image-into-image steganography for proactive image tamper localization. Specifically, **fragility** means the damage to the container image results in corresponding damage to the revealed secret image. **Locality** indicates that damage to the container image and the revealed secret image is essentially pixel-level and directly correlated. These two properties can also be effectively applied in proactive video localization. Meanwhile, EditGuard [65] adopts a “sequential embedding and parallel decoding” structure to realize united tamper localization and copyright protection. Clearly, one direct approach is to watermark each video frame via EditGuard. However, this method overlooks the exploitation of temporal correlation, making it challenging to ensure the robustness of the reconstructed watermarks and the temporal consistency of the watermarked videos. Therefore, the key issues addressed in this paper are: **1)** How to utilize the auxiliary information from supporting frames for watermark embedding and decoding in reference frames; **2)** How to improve the robustness of existing frameworks to video degradation; **3)** How to employ the watermarks embedded in video frames for audio tamper localization and copyright protection. To address the above issues, we design the visual hiding module (VHM), visual revealing module (VRM), bit hiding module (BHM), and bit recovery module (BRM). Meanwhile, we design an efficient cross-modal extraction mechanism and introduce the advanced audio versatile watermarking and decoding method [44] to achieve cross-modal tamper localization and copyright protection.

3.3 Visual Hiding and Decoding

3.3.1 Input and Output Design of Visual Section. To achieve memory-efficient hiding and decoding, our V^2A -Mark employs a multi-frame input, single-frame output structure. As shown in Fig. 3, the visual hiding is operated group-by-group via a sliding window, traversing each video frame from head to tail. We set the

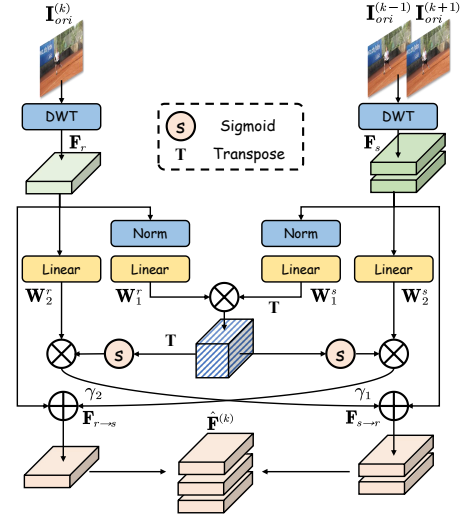

Figure 4: Details of the proposed temporal alignment and fusion module (TAFM). It aligns the supporting frames $I_{ori}^{(k-1)}$, $I_{ori}^{(k+1)}$ to the reference frame $I_{ori}^{(k)}$.

length of a sliding window to 3. Given the original video group $\{I_{ori}^{(i)}\}_{k-1}^{k+1}$ and localization watermark group $\{I_{loc}^{(i)}\}_{k-1}^{k+1}$, we firstly use the TAFM to preprocess $\{I_{ori}^{(i)}\}_{k-1}^{k+1}$ and adopt N invertible blocks to generate $I_{med}^{(k)}$ and its by-product Z_v . The copyright watermark w_{cop} is then embedded into $I_{med}^{(k)}$ via a U-Net [53], producing the final container frame $I_{con}^{(k)}$. For all video frames, we embed the same copyright watermark. After network transmission, V^2A -Mark decodes each received video frame $I_{rec}^{(k)}$ individually. On one hand, \hat{w}_{cop} is extracted from $I_{rec}^{(k)}$ via a U-Net and an MLP extractor. On the other hand, we replicate $I_{rec}^{(k)}$ threefold and feed it into the residual

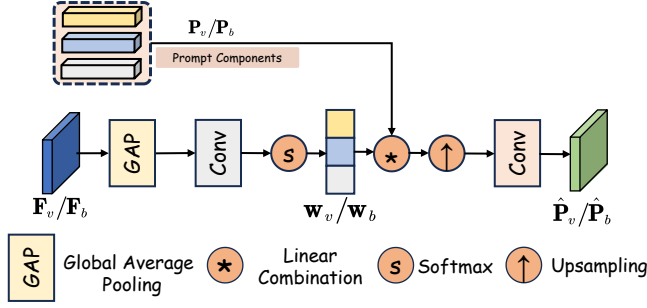

Figure 5: Details of the proposed degradation prompt learning mechanism. It fuses the intrinsic image features F_v/F_b with the learnable prompt components P_v/P_b adaptively.

prediction module (RPM) [38] to produce the missing component \hat{Z}_v . Then, N invertible blocks and the TAFM are used to reconstruct the video groups and only select the intermediate frames as the result, namely $\hat{I}_{ori}^{(k)}$ and $\hat{I}_{loc}^{(k)}$. Note that we introduce learned degradation prompts P_v, P_b in video revealing and bit recovery modules and fuse them with intrinsic features to further enhance the robustness of our method against common video and audio degradations.

3.3.2 Temporal Alignment and Fusion Module. To further enhance the temporal consistency of the container videos, we design a temporal alignment and fusion module (TAFM) to align the supporting frames $\{I_{ori}^{(i)}\}_{i \neq k}$ to the reference frame $I_{ori}^{(k)}$. As shown in Fig. 4, we resort to bidirectional cross-attention mechanisms between the supporting frames and the reference frame. Specifically, we define the scaled dot production operation as follows.

$$\text{Attention}(\mathbf{Q}, \mathbf{K}, \mathbf{V}) = \text{softmax}\left(\frac{\mathbf{Q}\mathbf{K}^T}{\sqrt{D}}\right)\mathbf{V}, \quad (3)$$

where $\mathbf{Q} \in \mathbb{R}^{H \times W \times D}$ is the query matrix projected by the reference frame $I_{ori}^{(k)}$, and $\mathbf{K}, \mathbf{V} \in \mathbb{R}^{H \times W \times D}$ are the key and value matrix produced from the supporting frames $\{I_{ori}^{(i)}\}_{i \neq k}$. Given the reference feature F_r and the supporting feature F_s , they are firstly layer normalized into $\bar{F}_r = \text{Norm}(F_r)$ and $\bar{F}_s = \text{Norm}(F_s)$. Then, we use linear layers to project \bar{F}_r, \bar{F}_s into D -dimension embedding space and calculate the cross-attention maps between reference and supporting frames as follows.

$$F_{r \rightarrow s} = \text{Attention}\left(W_1^r \bar{F}_r, W_1^s \bar{F}_s, W_2^s F_s\right), \quad (4)$$

$$F_{s \rightarrow r} = \text{Attention}\left(W_1^s \bar{F}_s, W_1^r \bar{F}_r, W_2^r F_r\right), \quad (5)$$

where W_1^r, W_2^r, W_1^s and W_2^s respectively denote the projection matrices. Finally, we perform temporal fusion between the reference frame and supporting frames via the residual connection and concatenation operation.

$$\hat{F}^{(k)} = \text{Concat}(\gamma_1 F_{s \rightarrow r} + F_r, \gamma_2 F_{r \rightarrow s} + F_s), \quad (6)$$

where γ_1 and γ_2 respectively denote the learnable parameters. With our TAFM, V²A-Mark can better exploit temporal correlations, thus achieving more effective concealment and more robust decoding.

3.3.3 Degradation Prompt Learning. To further improve the robustness of V²A-Mark in decoding both visual localization and copyright watermarks, we embed learnable degradation prompts

$P_v \in \mathbb{R}^{h_1 \times w_1 \times c_1 \times e_1}, P_b \in \mathbb{R}^{h_2 \times w_2 \times c_2 \times e_2}$ into features of the bit recovery and video revealing modules, where c_1, c_2 respectively denote the channels of prompt, e_1, e_2 respectively denote the number of degradation prompt. The degradation prompt pool comprises a series of learnable embeddings, with each corresponding to a type of potential degradation. Supposing that F_v and F_b are the outputs of the RPM in the video revealing module and the U-Net in the bit recovery module in Fig. 3 respectively, we utilize a channel attention mechanism (as shown in Fig. 5) to better encourage the interaction between the input features F_v/F_b and the degradation prompt P_v/P_b . Specifically, the features F_v/F_b are passed to a global average pooling (GAP) layer, a 1×1 convolution, and a softmax operator to produce a set of dynamic weight coefficients w_v/w_b , which is inspired by [43]. These coefficients are used to fuse each degradation prompt, resulting in degradation-enhanced features. Then, we utilize convolution and concatenation operations to fuse the degradation-enhanced features with the features extracted from RPM or the U-Net in BRM. Note that we learned two distinct sets of degradation prompts for visual and bit decoding, since we aim for the BRM to be absolutely robust against degradation, while the VRM should retain some fragility against tampering.

3.4 Audio Hiding and Decoding

Considering that video tampering is often accompanied by corresponding changes in the audio, we try to simultaneously identify the tampered areas of the audio, and utilize the extracted audio copyright to cross-verify the copyright in the video frame. To ensure the correspondence between video and audio, we set the audio versatile copyright watermark w'_{cop} as part of the copyright w_{cop} in the video frames. For instance, w_{cop} is a 32-bit watermark, and w'_{cop} is the first 16 bits of w_{cop} . Inspired by the advanced proactive tamper localization tool Audioseal [44], we introduce an audio watermark generator and detector to achieve audio versatile watermarking and decoding shown in Fig. 2. Specifically, we utilize the watermark generator to predict an additive watermark waveform from the audio input A_{ori} , and use a detector to output the probability \hat{m}_{aud} of the presence of a watermark at each sample of the container audio A_{con} . The detector is trained with mask augmentation strategy to ensure its accuracy and robustness. Meanwhile, we add a message embedding layer [44] in the middle of the watermark generator to embed w'_{cop} into A_{ori} . In the decoding end, the detector will robustly decrypt w_{cop}^a , which will be used to combine with w_{cop}^v to get the final copyright \hat{w}_{cop} .

3.5 Training and Inference Details

Training: The training process of the visual section of the proposed V²A-Mark can be divided into two steps. Given an arbitrary original image $I_{med}^{(k)}$ and watermark w_{cop} , we first train the bit hiding and recovery module via the ℓ_2 loss.

$$\ell_{cop} = \|I_{con}^{(k)} - I_{med}^{(k)}\|_2^2 + \lambda \| \hat{w}_{cop} - w_{cop} \|_2^2, \quad (7)$$

where λ is set to 10. Furthermore, we freeze the weights of BHM and BRM and jointly train the VHM and VRM. Given a video group $\{I_{ori}^{(i)}\}_{k-1}^{k+1}$, localization watermark group $\{I_{loc}^{(i)}\}_{k-1}^{k+1}$ and copyright

Method	ProPainter [67]				E ² FGVI [27]				Video Slicing			
	F1-Score	AUC	IoU	BA(%)	F1-Score	AUC	IoU	BA(%)	F1-Score	AUC	IoU	BA(%)
OSN [52]	0.164	0.404	0.125	-	0.170	0.410	0.126	-	0.382	0.830	0.262	-
PSCC-Net [30]	0.275	0.757	0.186	-	0.273	0.742	0.174	-	0.559	0.876	0.419	-
HiFi-Net [13]	0.517	0.699	0.123	-	0.573	0.763	0.198	-	0.668	0.906	0.347	-
IML-ViT [35]	0.174	0.521	0.112	-	0.162	0.516	0.107	-	0.137	0.509	0.098	-
EditGuard [65]	<u>0.924</u>	<u>0.950</u>	<u>0.866</u>	<u>99.41</u>	<u>0.923</u>	<u>0.950</u>	<u>0.865</u>	<u>99.43</u>	<u>0.922</u>	<u>0.949</u>	<u>0.861</u>	<u>99.73</u>
V ² A-Mark (Ours)	0.944	0.990	0.897	99.73	0.943	0.981	0.895	99.61	0.941	0.972	0.891	99.76

Table 1: Comparison with other competitive tamper forensics methods under different AIGC-based video editing methods, such as ProPainter, E²FGVI, and naive slicing. Clearly, our method achieves the best localization and copyright restoration accuracy.

watermark \mathbf{w}_{cop} , the loss is:

$$\ell_{loc} = \|\hat{\mathbf{I}}_{ori}^{(k)} - \mathbf{I}_{ori}^{(k)}\|_1 + \alpha \|\mathbf{I}_{con}^{(k)} - \mathbf{I}_{ori}^{(k)}\|_2^2 + \beta \|\hat{\mathbf{I}}_{loc}^{(k)} - \mathbf{I}_{loc}^{(k)}\|_1, \quad (8)$$

where α and β are respectively set to 100 and 1. In the audio section, we use a pre-trained audio watermarking tool [44] to realize audio hiding and decoding.

Inference: As shown in Fig. 2 and 3, we can conduct forensics via the pre-trained components. To extract tampered masks, we compare the pre-defined watermark \mathbf{W}_{loc} with the decoded one $\hat{\mathbf{W}}_{loc}$ to obtain a binary mask $\hat{\mathbf{M}}_{vis} \in \mathbb{R}^{H \times W \times T}$:

$$\hat{\mathbf{M}}_{vis}[i, j, t] = \theta_\tau(\max(|\hat{\mathbf{W}}_{loc}[i, j, t, :] - \mathbf{W}_{loc}[i, j, t, :]|)), \quad (9)$$

where $i \in [0, H)$, $j \in [0, W)$ and $t \in [0, T)$. $\theta_\tau(z) = 1 (z \geq \tau)$. τ is set to 0.2. $|\cdot|$ is an absolute value operation. The audio tampered period $\hat{\mathbf{m}}_{aud}$ is directly extracted via the audio versatile decoder. To extract precise visual copyright, we conduct bitwise voting on the copyright extracted from each frame and select the most frequently occurring 0 or 1 as the final result \mathbf{w}_{cop}^v . Meanwhile, we extract audio copyright $\mathbf{w}_{cop}^a \in \{0, 1\}^n$ and use it to cross-verify with $\mathbf{w}_{cop}^v \in \{0, 1\}^k$, getting the final result $\hat{\mathbf{w}}_{cop} \in \{0, 1\}^k$. Considering that the audio copyright watermark can often be extracted more robustly and is not easily destroyed, we directly use it as the first n bits in the final multimedia copyright $\hat{\mathbf{w}}_{cop}$, which typically represents the ownership of the entire multimedia asset. The remaining $k - n$ bits are taken from the extracted visual watermark \mathbf{w}_{cop}^v , which will be related to the information of video frames such as resolution, time length, and frame rate. The **cross-modal extraction process** is:

$$\hat{\mathbf{w}}_{cop} = \text{Concat}(\mathbf{w}_{cop}^a, \mathbf{w}_{cop}^v[n:]). \quad (10)$$

4 Experiments

4.1 Implementation Details

We trained our V²A-Mark in the Vimeo-90K [57] **without any tampered data**. We test our method on 30 testing videos of Davis dataset [42]. All video frames have a resolution of 448×256 and consist of 50 to 100 frames. To synthesize audio, we manually extract the video captions and use them as prompts with the VALLE-E-X audio synthesis tool [49]. The Adam [21] is used for training 250K iterations with $\beta_1=0.9$ and $\beta_2=0.5$. The learning rate is initialized to 1×10^{-4} and decreases by half for every 30K iterations, with the batch size set to 8. N in Video hiding and revealing module is set to 16. The shape of two degradation prompts \mathbf{P}_v and \mathbf{P}_b are $36 \times 36 \times 72 \times 2$ and $36 \times 36 \times 16 \times 6$. We embed 32-bit copyright watermarks \mathbf{w}_{cop} and pure blue visual localization watermarks \mathbf{W}_{loc}

to original videos. We use replication padding to process the first and last frame of the original video. Meanwhile, we also embed a versatile watermark \mathbf{w}'_{cop} into the original audio.

4.2 Comparison with Localization Methods

To evaluate the visual localization and copyright recovery accuracy, we compared our method with some SOTA passive methods OSN [52], PSCC-Net [30], HiFi-Net [13], IML-ViT [35] and a proactive forensics method EditGuard [65]. Despite previous research on video tamper localization [41], we can not find methods with publicly available code. Therefore, our comparative methods primarily rely on image-based tamper localization methods on a frame-by-frame prediction. For visual tamper localization, F1-score, AUC, and IoU are used to evaluate localization accuracy. For copyright protection, bit accuracy (BA) is used to assess the copyright recovery performance. We use two SOTA deep video inpainting methods, ProPainter [67] and E²FGVI [27], and a naive slicing approach to simulate malicious tampering.

As reported in Tab. 1, our V²A-Mark achieves 0.95 F1-Score, 0.99 AUC, and 0.9 IoU. However, other passive localization methods, which rely solely on tampered video clues, perform poorly in localizing unseen types of manipulation. Furthermore, when using EditGuard to watermark each video frame, although it achieves satisfactory localization results, it falls short in effectively utilizing temporal information. Consequently, the IoU of the predicted masks in various tampering methods is generally about 0.03 lower than that achieved by our V²A-Mark. Additionally, our V²A-Mark achieves an over 99.5% bit accuracy across various tampering methods, which is also marginally higher than that of EditGuard. Furthermore, as shown in Fig. 6, our method has very obvious advantages over SOTA passive localization method PSCC-Net [30], which can be attributed to our proactive tamper localization mechanism. Meanwhile, since we adopted a more effective temporal alignment and fusion method, we found that in some scenes where EditGuard can only locate the rough outline of the tampering area, our V²A-Mark can still clearly predict the tampered traces.

4.3 Comparison with Watermarking Methods

To evaluate the visual quality of \mathbf{V}_{con} , we compared our V²A-Mark with other watermarking methods on 30 testing videos from DAVIS [42]. For a fair comparison, we also retrained our EditGuard on 448×256 original videos and 32 bits. Our comparison methods include the SOTA bit-hiding watermarking method [10, 18, 34, 53], large-capacity steganography method [19, 38], and a versatile image

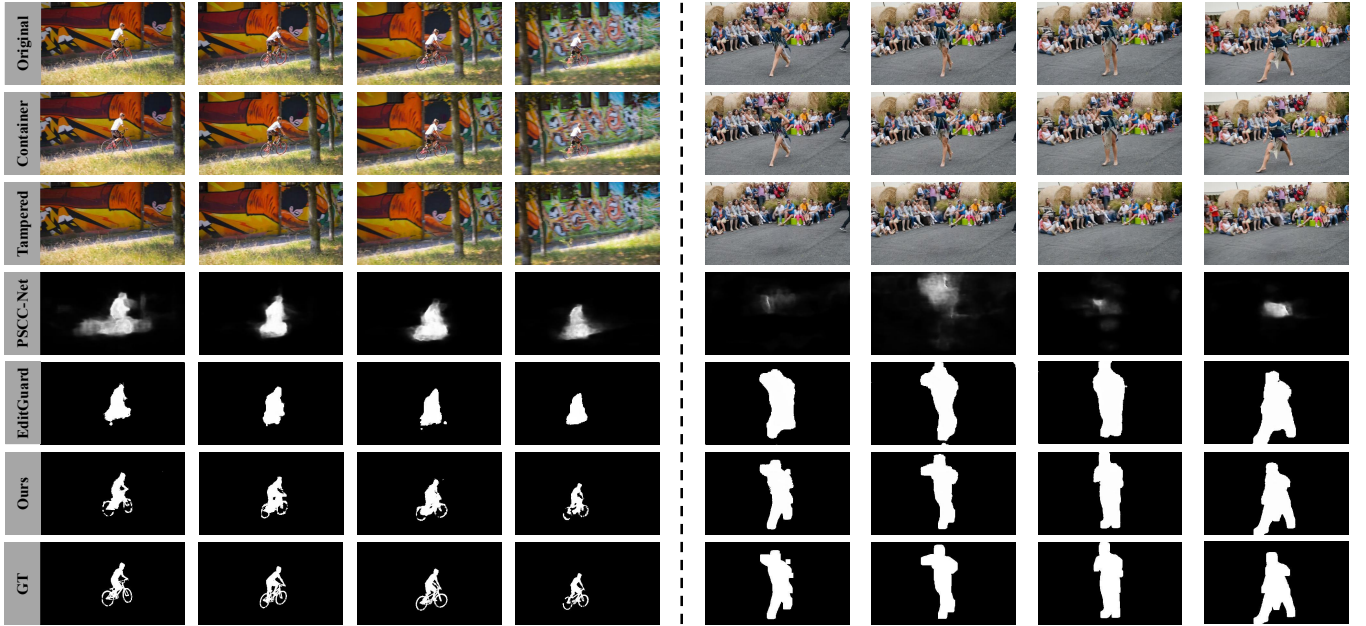

Figure 6: Localization accuracy comparison with our V²A-Mark and other localization methods PSCC-Net [30], EditGuard [65]. Our method can predict more accurate and clearer tampered masks. We also present our container and tampered videos.

Method	Message	PSNR (dB)	SSIM	NIQE (↓)
MBRS [18]	30 bits	26.57	0.908	6.473
CIN [34]	30 bits	42.41	<u>0.983</u>	5.858
PIMoG [10]	30 bits	37.71	0.971	8.129
SepMark [53]	30 bits	34.86	0.914	5.321
HiNet [19]	an image	36.46	0.940	6.271
LF-VSN [38]	an image	39.93	0.967	<u>3.827</u>
EditGuard [65]	an image	38.53	0.977	4.919
V ² A-Mark	an image	<u>40.83</u>	0.983	3.484

Table 2: The comparisons with other watermarking methods on the visual quality of the container video V_{con} .

watermarking method [65]. As shown in Tab. 2, the PSNR and SSIM of our container videos far outperform most watermarking methods such as MBRS, PIMoG, and SepMark, but is close or slightly inferior to CIN. Note that these methods only hide 30 bits in the videos, but our V²A-Mark hides both an RGB image and 32 bits. Compared with high-capacity steganography methods EditGuard, LF-VSN, and HiNet, our method also has clear advantages in visual quality. Meanwhile, the perceptual quality (NIQE) of our watermarked videos surpasses all other methods. To verify the security of our method, we perform anti-steganography detection via StegExpose [4] on container videos of various steganography methods. All the methods concealed pure blue videos into the original videos. Note that the detection set is built by mixing container and original video frames with equal proportions. We vary the detection thresholds in a wide range in StegExpose [4] and draw the ROC curve in Fig. 7. The ideal case represents that the detector has a 50% probability of detecting container videos from an equally mixed detection test, the same as a random guess. Evidently, the security of our method exhibits a significant advantage compared to all competitive methods.

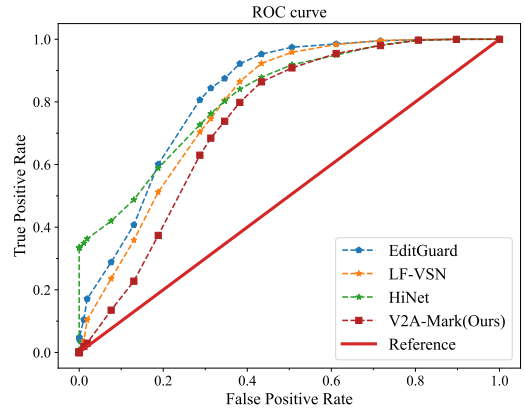

Figure 7: ROC curve of different methods under StegExpose. The closer the curve is to the reference central axis (which means random guess), the method is better in security.

4.4 Audio Tamper Localization

To evaluate the accuracy of V²A-Mark for audio tamper localization, we randomly insert 1s - 2s tampered audio into our constructed 30 original audio. SNR and PESQ are used to evaluate the quantitative and perceptual quality of watermarked audio. Bit accuracy is used to evaluate the bit error rate of the pre-defined w'_{cop} and extracted w_{cop}^a . AUC is used to calculate the localization accuracy between the predicted audio tampered period m_{aud} and the ground truth of the tampered area m . We observed from Tab. 3 that the watermarked audio maintains high SNR/PESQ on 28.29 dB/4.50 with the original audio, indicating that our V²A-Mark has little impact on the semantic fidelity of the audio. Meanwhile, our method can accurately localize the tampered areas with 99.63% AUC and obtain 100% bit accuracy under “Clean” degradation, which shows that our audio localization watermark is sensitive enough to malicious

Degradation	SNR (dB)	PESQ (\uparrow)	Bit. Acc.	AUC
Clean	28.29	4.50	100%	99.63%
Resample	-	-	100%	98.58%
Lowpass	-	-	99.72%	99.41%

Table 3: Watermarked audio quality and tamper localization performance of our method under different degradations.

Methods	Metrics	Clean	Gaussian Noise		H.264		Poisson
			$\sigma=5$	$\sigma=10$	QP=5	QP=10	
EditGuard	F1	0.924	0.891	0.872	0.900	0.881	0.896
	AUC	0.950	0.945	0.922	0.946	0.941	0.947
	IoU	0.866	0.835	0.812	0.830	0.828	0.842
	BA(%)	99.41	99.01	96.90	95.16	92.23	99.31
V ² A-Mark	F1	0.944	0.904	0.900	0.915	0.909	0.913
	AUC	0.990	0.979	0.963	0.978	0.967	0.980
	IoU	0.897	0.842	0.833	0.858	0.850	0.856
	BA(%)	99.73	99.35	98.51	99.34	99.18	99.71

Table 4: Localization and bit recovery performance of our V²A-Mark and EditGuard under different degradations.

tampering. Furthermore, we adopt two classical degradations on the container audio A_{con} , namely Resample and Lowpass. “Resample” denotes resampling the container audio at a 90% sampling rate (16000Hz \rightarrow 14400Hz). “Lowpass” means applying low-pass filter to container audio A_{con} , cutting frequencies above a cutoff frequency (1000Hz). As plotted in Tab. 3, although the container audio A_{con} has undergone different degradations, our V²A-Mark still maintains over 98% localization accuracy and nearly 100% bit accuracy, proving its robustness against common audio corruptions.

4.5 Robustness Analysis

To analyze the robustness of our V²A-Mark, we compare our method with EditGuard, the best comparative method in the clean case. We selected three types of video degradation, including Gaussian noise, H.264 video coding, and Poisson noise. As reported in Tab. 4, we found that our V²A-Mark has only slight performance degradation under various degradations compared to the clean scene, and both surpass EditGuard in localization accuracy and copyright reconstruction. Specifically, since we use a multi-frame input, single-frame output structure, which better explores temporal information, our method performs better in handling inter-frame degradation (such as H.264 video coding) than EditGuard which adds watermarks frame by frame. As reported in Tab. 4, the recovered bit accuracy of our method far surpasses EditGuard by 4.18% and 6.95% in QP=5 and QP=10. Meanwhile, our V²A-Mark also outperforms EditGuard by 0.028 and 0.022 in localization accuracy (IoU), which proves its superiority in decoding robustness.

4.6 Ablation Studies

To evaluate the contribution of each component, we mainly conduct ablation studies on the temporal alignment and fusion module (TAFM) and degradation prompt learning (DPL). Our results are reported on Tab. 5, where “random degradation” denotes that we randomly select one degradation from Gaussian noise, H.264, and Poisson noise. Comparing case (a) and ours in the “clean” scene, it demonstrates that the proposed TAFM can enhance the localization accuracy and achieve 0.012 gains in IoU, which proves that

Case	Degradation $\mathcal{D}_o(\cdot)$	TAFM	DPL	F1	AUC	IoU	BA(%)
(a)	Clean	✗	✓	0.935	0.962	0.885	99.47
(b)	Random Degradations	✓	✗	0.901	0.961	0.832	98.45
Ours	Clean	✓	✓	0.944	0.990	0.897	99.73
	Random Degradations	✓	✓	0.912	0.975	0.849	99.43

Table 5: Ablation studies on the core parts of V²A-Mark.

the proposed TAFM can boost the temporal interaction and realize effective temporal alignment. Comparing case (b) and ours in the “random degradation” scene, due to the learned degradation representations, we find that our method achieves significant gains on localization accuracy and copyright precision.

4.7 Applications

Our V²A-Mark can provide focused protection for videos based on user-defined areas. This allows our V²A-Mark to apply to some global tampering such as visual-audio deepfake. Specifically, we use EfficientSAM [55] to segment the facial regions that need focused protection, and add localization watermarks only to these parts, while still embedding a global copyright watermark. As shown in Fig. 8, we manipulate the identity in the container video frames via SimSwap [5], and alter the first 0.5s of this audio from “there are many jobs for American” to “there are few jobs for American.” Subsequently, our V²A-Mark is capable of effectively detecting tampered areas in the face region as well as alterations in the audio. For the audio portion, we determine whether each sample point has been tampered with by evaluating the probability of alteration.

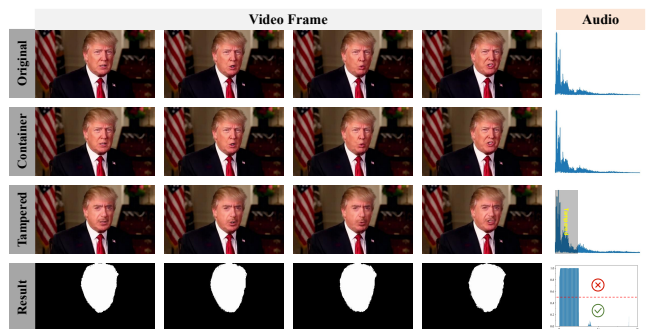

Figure 8: Application scene of the proposed V²A-Mark on the Deepfake tampering [5]. Our V²A-Mark can accurately predict visual tampered masks and the tampered probability of audio samples.

5 Conclusion

To address the challenges of AI-generated visual-audio forensics, an innovative deep watermarking method with strong generalizability, versatile function, and cross-modal properties dubbed V²A-Mark is proposed. It embeds invisible visual-audio localization and copyright watermarks into the original video frames and audio. If encountering malicious tampering on visual or audio information, we can get accurate tampered visual masks, video copyright, and tampered audio periods in the decoding end via our V²A-Mark. Facing the imminent explosive growth of the AIGC video industry, our V²A-Mark has the potential to safeguard the sustainable development of the AIGC industry, and also establish a clean and transparent information environment.

Acknowledgments

This work was supported by National Natural Science Foundation of China under Grant 62372016.

References

- [1] Mahdi Ahmadi, Alireza Norouzi, Nader Karimi, Shadrokh Samavi, and Ali Emami. 2020. ReDMark: Framework for residual diffusion watermarking based on deep networks. *Expert Systems with Applications* 146 (2020), 113157.
- [2] Vishal Asnani, Xi Yin, Tal Hassner, and Xiaoming Liu. 2023. Malp: Manipulation localization using a proactive scheme. In *Proceedings of the IEEE/CVF Conference on Computer Vision and Pattern Recognition (CVPR)*.
- [3] Andreas Blattmann, Tim Dockhorn, Sumith Kulal, Daniel Mendelevitch, Maciej Kilian, Dominik Lorenz, Yam Levi, Zion English, Vikram Voleti, Adam Letts, et al. 2023. Stable video diffusion: Scaling latent video diffusion models to large datasets. *arXiv preprint arXiv:2311.15127* (2023).
- [4] Benedikt Boehm. 2014. Stegexpose-A tool for detecting LSB steganography. *arXiv preprint arXiv:1410.6656* (2014).
- [5] Renwang Chen, Xuanhong Chen, Bingbing Ni, and Yanhao Ge. 2020. Simswap: An efficient framework for high fidelity face swapping. In *Proceedings of the 28th ACM international conference on multimedia*. 2003–2011.
- [6] Xinru Chen, Chengbo Dong, Jiaqi Ji, Juan Cao, and Xirong Li. 2021. Image manipulation detection by multi-view multi-scale supervision. In *Proceedings of the IEEE/CVF International Conference on Computer Vision (ICCV)*.
- [7] Xuxin Cheng, Bowen Cao, Qichen Ye, Zhihong Zhu, Hongxiang Li, and Yuexian Zou. 2023. ML-LMCL: Mutual Learning and Large-Margin Contrastive Learning for Improving ASR Robustness in Spoken Language Understanding. In *Findings of the Association for Computational Linguistics: ACL 2023*. 6492–6505.
- [8] Xuxin Cheng, Zhihong Zhu, Hongxiang Li, Yaowei Li, Xianwei Zhuang, and Yuexian Zou. 2024. Towards Multi-Intent Spoken Language Understanding via Hierarchical Attention and Optimal Transport. In *Proceedings of the AAAI Conference on Artificial Intelligence*, Vol. 38. 17844–17852.
- [9] Patrick Esser, Johnathan Chiu, Parmida Atighehchian, Jonathan Granskog, and Anastasis Germanidis. 2023. Structure and content-guided video synthesis with diffusion models. In *Proceedings of the IEEE/CVF International Conference on Computer Vision*. 7346–7356.
- [10] Han Fang, Zhaoyang Jia, Zehua Ma, Ee-Chien Chang, and Weiming Zhang. 2022. PIMoG: An effective screen-shooting noise-layer simulation for deep-learning-based watermarking network. In *Proceedings of the 30th ACM International Conference on Multimedia (MM)*.
- [11] Han Fang, Yupeng Qiu, Kejiang Chen, Jiyi Zhang, Weiming Zhang, and Ee-Chien Chang. 2023. Flow-based robust watermarking with invertible noise layer for black-box distortions. In *Proceedings of the AAAI Conference on Artificial Intelligence (AAAI)*.
- [12] Rohit Girdhar, Mannat Singh, Andrew Brown, Quentin Duval, Samaneh Azadi, Sai Saketh Rambhatla, Akbar Shah, Xi Yin, Devi Parikh, and Ishan Misra. 2023. Emu Video: Factorizing Text-to-Video Generation by Explicit Image Conditioning. *arXiv preprint arXiv:2311.10709* (2023).
- [13] Xiao Guo, Xiaohong Liu, Zhiyuan Ren, Steven Grosz, Iacopo Masi, and Xiaoming Liu. 2023. Hierarchical fine-grained image forgery detection and localization. In *Proceedings of the IEEE/CVF Conference on Computer Vision and Pattern Recognition (CVPR)*.
- [14] Yuwei Guo, Ceyuan Yang, Anyi Rao, Yaohui Wang, Yu Qiao, Dahua Lin, and Bo Dai. 2023. Animatediff: Animate your personalized text-to-image diffusion models without specific tuning. *arXiv preprint arXiv:2307.04725* (2023).
- [15] Amal Hammami, Amal Ben Hamida, Chokri Ben Amar, and Henri Nicolas. 2024. Blind Semi-fragile Hybrid Domain-Based Dual Watermarking System for Video Authentication and Tampering Localization. *Circuits, Systems, and Signal Processing* 43, 1 (2024), 264–301.
- [16] Xiaoxiao Hu, Qichao Ying, Zhenxing Qian, Sheng Li, and Xinpeng Zhang. 2023. DRAW: Defending Camera-shooted RAW against Image Manipulation. In *Proceedings of the IEEE/CVF International Conference on Computer Vision (ICCV)*.
- [17] Nasir N Hurreh, Shabir A Parah, Nazir A Loan, Javaid A Sheikh, Mohammad Elhoseny, and Khan Muhammad. 2019. Dual watermarking framework for privacy protection and content authentication of multimedia. *Future generation computer systems* 94 (2019), 654–673.
- [18] Zhaoyang Jia, Han Fang, and Weiming Zhang. 2021. Mbrs: Enhancing robustness of dnn-based watermarking by mini-batch of real and simulated jpeg compression. In *Proceedings of the 29th ACM International Conference on Multimedia (MM)*.
- [19] Junpeng Jing, Xin Deng, Mai Xu, Jianyi Wang, and Zhenyu Guan. 2021. HiNet: Deep Image Hiding by Invertible Network. In *Proceedings of the IEEE/CVF International Conference on Computer Vision (ICCV)*.
- [20] Asra Kamili, Nasir N Hurreh, Shabir A Parah, Ghulam Mohiuddin Bhat, and Khan Muhammad. 2020. DWFCAT: Dual watermarking framework for industrial image authentication and tamper localization. *IEEE Transactions on Industrial Informatics* 17, 7 (2020), 5108–5117.
- [21] Diederik P Kingma and Jimmy Ba. 2014. Adam: A method for stochastic optimization. *arXiv preprint arXiv:1412.6980* (2014).
- [22] Myung-Joon Kwon, In-Jae Yu, Seung-Hun Nam, and Heung-Kyu Lee. 2021. CAT-Net: Compression artifact tracing network for detection and localization of image splicing. In *Proceedings of the IEEE/CVF Winter Conference on Applications of Computer Vision (WACV)*.
- [23] Guobiao Li, Sheng Li, Zicong Luo, Zhenxing Qian, and Xinpeng Zhang. 2024. Purified and Unified Steganographic Network. In *Proceedings of the IEEE/CVF conference on computer vision and pattern recognition*.
- [24] Haodong Li and Jiwu Huang. 2019. Localization of deep inpainting using high-pass fully convolutional network. In *Proceedings of the IEEE/CVF International Conference on Computer Vision (ICCV)*.
- [25] Weiqi Li, Shijie Zhao, Bin Chen, Xinhua Cheng, Junlin Li, Li Zhang, and Jian Zhang. 2024. ResVR: Joint Rescaling and Viewport Rendering of Omnidirectional Images. *arXiv preprint arXiv:2404.16825* (2024).
- [26] Yue Li, Dong Liu, Houqiang Li, Li Li, Zhu Li, and Feng Wu. 2018. Learning a convolutional neural network for image compact-resolution. *IEEE Transactions on Image Processing* 28, 3 (2018), 1092–1107.
- [27] Zhen Li, Cheng-Ze Lu, Jianhua Qin, Chun-Le Guo, and Ming-Ming Cheng. 2022. Towards an end-to-end framework for flow-guided video inpainting. In *Proceedings of the IEEE/CVF conference on computer vision and pattern recognition*. 17562–17571.
- [28] Siau-Chuin Liew, Siau-Way Liew, and Jasni Mohd Zain. 2013. Tamper localization and lossless recovery watermarking scheme with ROI segmentation and multilevel authentication. *Journal of digital imaging* 26 (2013), 316–325.
- [29] Chia-Chen Lin, Ting-Lin Lee, Ya-Fen Chang, Pei-Feng Shiu, and Bohan Zhang. 2023. Fragile Watermarking for Tamper Localization and Self-Recovery Based on AMBTC and VQ. *Electronics* 12, 2 (2023), 415.
- [30] Xiaohong Liu, Yaojie Liu, Jun Chen, and Xiaoming Liu. 2022. PSCC-Net: Progressive spatio-channel correlation network for image manipulation detection and localization. *IEEE Transactions on Circuits and Systems for Video Technology* 32, 11 (2022), 7505–7517.
- [31] Xuntao Liu, Yuzhou Yang, Qichao Ying, Zhenxing Qian, Xinpeng Zhang, and Sheng Li. 2024. PROMPT-IML: Image Manipulation Localization with Pre-trained Foundation Models Through Prompt Tuning. *arXiv preprint arXiv:2401.00653* (2024).
- [32] Yang Liu, Mengxi Guo, Jian Zhang, Yuesheng Zhu, and Xiaodong Xie. 2019. A novel two-stage separable deep learning framework for practical blind watermarking. In *Proceedings of the ACM International Conference on Multimedia (MM)*.
- [33] Xiyang Luo, Yinxiao Li, Huiwen Chang, Ce Liu, Peyman Milanfar, and Feng Yang. 2023. DVMark: a deep multiscale framework for video watermarking. *IEEE Transactions on Image Processing* (2023).
- [34] Rui Ma, Mengxi Guo, Yi Hou, Fan Yang, Yuan Li, Huizhu Jia, and Xiaodong Xie. 2022. Towards Blind Watermarking: Combining Invertible and Non-invertible Mechanisms. In *Proceedings of the ACM International Conference on Multimedia (MM)*.
- [35] Xiaochen Ma, Bo Du, Xianggen Liu, Ahmed Y Al Hammadi, and Jizhe Zhou. 2023. IML-ViT: Image Manipulation Localization by Vision Transformer. *arXiv preprint arXiv:2307.14863* (2023).
- [36] Chong Mou, Xintao Wang, Jiechong Song, Ying Shan, and Jian Zhang. 2023. Dragondiffusion: Enabling drag-style manipulation on diffusion models. *arXiv preprint arXiv:2307.02421* (2023).
- [37] Chong Mou, Xintao Wang, Jiechong Song, Ying Shan, and Jian Zhang. 2024. Diffeditor: Boosting accuracy and flexibility on diffusion-based image editing. In *Proceedings of the IEEE/CVF Conference on Computer Vision and Pattern Recognition*. 8488–8497.
- [38] Chong Mou, Youmin Xu, Jiechong Song, Chen Zhao, Bernard Ghanem, and Jian Zhang. 2023. Large-capacity and flexible video steganography via invertible neural network. In *Proceedings of the IEEE/CVF Conference on Computer Vision and Pattern Recognition (CVPR)*.
- [39] Neena Raj NR and R Shreelekshmi. 2022. Fragile watermarking scheme for tamper localization in images using logistic map and singular value decomposition. *Journal of Visual Communication and Image Representation* 85 (2022), 103500.
- [40] Rupali D Patil and Shilpa Metkar. 2015. Fragile video watermarking for tampering detection and localization. In *2015 International Conference on Advances in Computing, Communications and Informatics (ICACCI)*. 1661–1666.
- [41] Pengfei Pei, Xianfeng Zhao, Jinchuan Li, and Yun Cao. 2023. UVL: A Unified Framework for Video Tampering Localization. *arXiv preprint arXiv:2309.16126* (2023).
- [42] Federico Perazzi, Jordi Pont-Tuset, Brian McWilliams, Luc Van Gool, Markus Gross, and Alexander Sorkine-Hornung. 2016. A benchmark dataset and evaluation methodology for video object segmentation. In *Proceedings of the IEEE conference on computer vision and pattern recognition*. 724–732.
- [43] Vaishnav Potlapalli, Syed Waqas Zamir, Salman Khan, and Fahad Shahbaz Khan. 2023. PromptIR: Prompting for All-in-One Blind Image Restoration. *arXiv preprint arXiv:2306.13090* (2023).
- [44] Robin San Roman, Pierre Fernandez, Alexandre Défossez, Teddy Furon, Tuan Tran, and Hady Elsahar. 2024. Proactive Detection of Voice Cloning with Localized

- Watermarking. *arXiv preprint arXiv:2401.17264* (2024).
- [45] Shelly Sheynin, Adam Polyak, Uriel Singer, Yuval Kirstain, Amit Zohar, Oron Ashual, Devi Parikh, and Yaniv Taigman. 2023. Emu edit: Precise image editing via recognition and generation tasks. *arXiv preprint arXiv:2311.10089* (2023).
- [46] Uriel Singer, Adam Polyak, Thomas Hayes, Xi Yin, Jie An, Songyang Zhang, Qiyuan Hu, Harry Yang, Oron Ashual, Oran Gafni, et al. 2022. Make-a-video: Text-to-video generation without text-video data. *arXiv preprint arXiv:2209.14792* (2022).
- [47] Zhihao Sun, Haoran Jiang, Danding Wang, Xirong Li, and Juan Cao. 2023. SAFL-Net: Semantic-Agnostic Feature Learning Network with Auxiliary Plugins for Image Manipulation Detection. In *Proceedings of the IEEE/CVF International Conference on Computer Vision (ICCV)*.
- [48] Yuliya Vybornova. 2020. A new watermarking method for video authentication with tamper localization. In *Computer Vision and Graphics: International Conference, ICCVG 2020, Warsaw, Poland, September 14–16, 2020, Proceedings*, 201–213.
- [49] Chengyi Wang, Sanyuan Chen, Yu Wu, Ziqiang Zhang, Long Zhou, Shujie Liu, Zhuo Chen, Yanqing Liu, Huaming Wang, Jinyu Li, et al. 2023. Neural codec language models are zero-shot text to speech synthesizers. *arXiv preprint arXiv:2301.02111* (2023).
- [50] Qian Wang, Weiqi Li, Chong Mou, Xinhua Cheng, and Jian Zhang. 2024. 360dvd: Controllable panorama video generation with 360-degree video diffusion model. In *Proceedings of the IEEE/CVF Conference on Computer Vision and Pattern Recognition*. 6913–6923.
- [51] Shujin Wei, Haodong Li, and Jiwu Huang. 2022. Deep Video Inpainting Localization Using Spatial and Temporal Traces. In *IEEE International Conference on Acoustics, Speech and Signal Processing (ICASSP)*. 8957–8961.
- [52] Haiwei Wu, Jiantao Zhou, Jinyu Tian, and Jun Liu. 2022. Robust image forgery detection over online social network shared images. In *Proceedings of the IEEE/CVF Conference on Computer Vision and Pattern Recognition (CVPR)*.
- [53] Xiaoshuai Wu, Xin Liao, and Bo Ou. 2023. SepMark: Deep Separable Watermarking for Unified Source Tracing and Deepfake Detection. In *Proceedings of the ACM international conference on Multimedia (MM)*.
- [54] Yue Wu, Wael AbdAlmageed, and Premkumar Natarajan. 2019. Mantra-net: Manipulation tracing network for detection and localization of image forgeries with anomalous features. In *Proceedings of the IEEE/CVF Conference on Computer Vision and Pattern Recognition (CVPR)*.
- [55] Yunyang Xiong, Bala Varadarajan, Lemeng Wu, Xiaoyu Xiang, Fanyi Xiao, Chenchen Zhu, Xiaoliang Dai, Dilin Wang, Fei Sun, Forrest Iandola, et al. 2023. EfficientSAM: Leveraged masked image pretraining for efficient segment anything. *arXiv preprint arXiv:2312.00863* (2023).
- [56] Youmin Xu, Chong Mou, Yujie Hu, Jingfen Xie, and Jian Zhang. 2022. Robust invertible image steganography. In *Proceedings of the IEEE/CVF Conference on Computer Vision and Pattern Recognition (CVPR)*.
- [57] Tianfan Xue, Baian Chen, Jiajun Wu, Donglai Wei, and William T Freeman. 2019. Video enhancement with task-oriented flow. *International Journal of Computer Vision* 127 (2019), 1106–1125.
- [58] Guanhui Ye, Jiashi Gao, Yuchen Wang, Liyan Song, and Xuetao Wei. 2023. ItoV: Efficiently Adapting Deep Learning-based Image Watermarking to Video Watermarking. *arXiv preprint arXiv:2305.02781* (2023).
- [59] Qichao Ying, Xiaoxiao Hu, Xiangyu Zhang, Zhenxing Qian, Sheng Li, and Xinpeng Zhang. 2022. RWN: Robust Watermarking Network for Image Cropping Localization. In *Proceedings of the IEEE International Conference on Image Processing (ICIP)*.
- [60] Qichao Ying, Zhenxing Qian, Hang Zhou, Haisheng Xu, Xinpeng Zhang, and Siyi Li. 2021. From image to image: Immune image generation. In *Proceedings of the ACM international conference on Multimedia (MM)*.
- [61] Qichao Ying, Hang Zhou, Zhenxing Qian, Sheng Li, and Xinpeng Zhang. 2023. Learning to Immunize Images for Tamper Localization and Self-Recovery. *IEEE Transactions on Pattern Analysis and Machine Intelligence* (2023).
- [62] Jiwen Yu, Xiaodong Cun, Chenyang Qi, Yong Zhang, Xintao Wang, Ying Shan, and Jian Zhang. 2023. AnimateZero: Video Diffusion Models are Zero-Shot Image Animators. *arXiv preprint arXiv:2312.03793* (2023).
- [63] Jiwen Yu, Xuanyu Zhang, Youmin Xu, and Jian Zhang. 2024. Cross: Diffusion model makes controllable, robust and secure image steganography. *Advances in Neural Information Processing Systems* 36 (2024).
- [64] Yanhong Zeng, Jianlong Fu, and Hongyang Chao. 2020. Learning joint spatial-temporal transformations for video inpainting. In *Computer Vision—ECCV 2020: 16th European Conference, Glasgow, UK, August 23–28, 2020, Proceedings, Part XVI 16*. Springer, 528–543.
- [65] Xuanyu Zhang, Runyi Li, Jiwen Yu, Youmin Xu, Weiqi Li, and Jian Zhang. 2024. EditGuard: Versatile Image Watermarking for Tamper Localization and Copyright Protection. In *Proceedings of the IEEE/CVF conference on computer vision and pattern recognition*.
- [66] Yulin Zhang, Jiangqun Ni, Wenkang Su, and Xin Liao. 2023. A Novel Deep Video Watermarking Framework with Enhanced Robustness to H. 264/AVC Compression. In *Proceedings of the 31st ACM International Conference on Multimedia*. 8095–8104.
- [67] Shangchen Zhou, Chongyi Li, Kelvin CK Chan, and Chen Change Loy. 2023. ProPainter: Improving propagation and transformer for video inpainting. In *Proceedings of the IEEE/CVF International Conference on Computer Vision*. 10477–10486.
- [68] Yangming Zhou, Qichao Ying, Yifei Wang, Xiangyu Zhang, Zhenxing Qian, and Xinpeng Zhang. 2022. Robust Watermarking for Video Forgery Detection with Improved Imperceptibility and Robustness. In *2022 IEEE 24th International Workshop on Multimedia Signal Processing (MMSP)*.
- [69] Jiren Zhu, Russell Kaplan, Justin Johnson, and Li Fei-Fei. 2018. Hidden: Hiding data with deep networks. In *European Conference on Computer Vision (ECCV)*.