

**Nishan Parvez**

Department of Mechanical Aerospace and  
Nuclear Engineering,  
Rensselaer Polytechnic Institute,  
110 8th Street,  
Troy, NY, USA

**Jacob S. Merson<sup>1</sup>**

Department of Mechanical Aerospace and  
Nuclear Engineering,  
Rensselaer Polytechnic Institute,  
110 8th Street,  
Troy, NY, USA  
email: mersoj2@rpi.edu

# A Physics Preserving Neural Network Based Approach for Constitutive Modeling of Isotropic Fibrous Materials

*We develop a new neural network based material model for discrete fibrous materials that strictly enforces constitutive constraints such as polyconvexity, frame-indifference, and the symmetry of the stress and material stiffness. Additionally, we show that the accuracy of the stress and material stiffness predictions is significantly improved for this neural network by using a Sobolev minimization strategy that includes derivative terms. We obtain a normalized mean square error of 0.15% for the strain energy density, 0.815% averaged across the components of the stress, and 5.4% averaged across the components of the stiffness tensor. This machine-learned constitutive model was deployed in a finite element simulation of a facet capsular ligament. The displacement fields and stress-strain curves were compared to a multiscale simulation that required running on a GPU-based supercomputer. The new approach maintained upward of 85% accuracy in stress up to 70% strain while reducing the computation cost by orders of magnitude.*

*Keywords: multiscale analysis, facet capsular ligament, machine learning, constitutive relation, surrogate model*

## 1 Introduction

Biological materials are among the most complex materials to model due to their microstructural heterogeneity, innate length-scale spanning orders of magnitude, and affinity for large deformation. Alongside traditional analytical formulation of hyperelastic material models, these complexities have led to the emergence of various multiscale methodologies that enable a greater understanding of the interplay between scales. They are gaining particular traction in modeling biological tissues with a network-like microstructure made of collagen fibers [1–3].

An upscaling multiscale approach is typical for modeling biological tissues due to a strong scale separation between the macroscale (e.g., model) and the subscale (e.g., fiber) length scales. In these methods, the subscale material behavior is homogenized to provide the constitutive properties for the macroscale analysis. This homogenization can either be done concurrently with the macroscale solution or a priori.

In a priori homogenization, numerical procedures such as the finite element method are typically used to perform a standard set of computational experiments (e.g., uniaxial displacement, biaxial displacement, pure shear, etc.) on a discrete material model to calibrate an analytical constitutive model, such as the neo-Hookean, HGO, or Fung model [4,5]. These constitutive models generally contain a small number of free parameters that need to be calibrated. As a result, this approach is computationally inexpensive because the needed set of numerical experiments is kept to a minimum.

Another option is to use an upscaling multiscale method where the microstructure is homogenized concurrently with the macroscale solution. One example of this scheme is the FE<sup>2</sup> method developed by [6] and others. In this procedure, the representative microstructures are simulated concurrently using the deformation gradient informed by the macroscale problem (i.e., the deformation gradient experienced by the finite elements of

the macroscale model). This mitigates the need for an analytical constitutive response function and can handle a broader range of emergent behaviors. The microstructure may be a continuum or a discrete model, with the latter being the case for soft fibrous materials.

Both a priori and concurrent hierarchical methods require strong scale separation and homogenization over a large enough domain that has representative material properties (i.e., the representative volume element (RVE)). The homogenization literature typically describes this as the size where the constitutive response remains unchanged under equivalent loading conditions (e.g., the Voigt and Reuss bounds converge). In 3D Voronoi networks, a common proxy for collagen networks, the RVE size is  $\gg 40$  times the mean fiber length [7]. However, microscale simulations of this size are not tractable in the context of concurrent upscaling multiscale analysis without the use of supercomputers and specialized solution procedures such as MuMFiM described in [8].

Due to this cost, the most common approach is to use a priori homogenization methods. The analytical material models for fibrous structures are based on the affine assumption that the fiber's end-to-end vector will deform according to a global deformation gradient. However, many authors have shown that the non-affine behavior of stochastic networks is critical to the overall response [9–13]. Consequently, traditional analytical constitutive response functions cannot capture behaviors that stem from micromechanical details such as dynamic realignment of fibers and non-locality, which are prominent in biological and polymeric materials and lead to emergent properties. One such observed emergent behavior is that networks exhibit Poisson's ratios over the thermodynamic limit for homogeneous elastic materials [14]. This behavior is modified when fibers are embedded into a matrix and is a strong function of the ratio of the fiber and matrix stiffnesses [15,16]. Fortunately, data-driven techniques such as neural network-based models present an alternative pathway to develop material models without these limiting assumptions, which is the topic of the current study.

Over the past decade, machine learning models have become an increasingly important part of the engineering design process, due

<sup>1</sup>Corresponding Author.

Version 1.18, July 23, 2024

to promising accuracy in predicting complex deformation fields and in constitutive modeling of nonlinear materials [17–22]. Mathematically, a neural network is generally an involved composite function that contains controlled nonlinearity and a large number of free parameters that are calibrated to model a plethora of phenomena. The mathematical formulation is generally discussed in terms of ‘neural network architecture’ and can be chosen so that the underlying functional form is convex (e.g., Input Convex Neural Network (ICNN) [23], which is particularly conducive to continuum mechanics based material model formulation). Once trained, these surrogate models have computational efficiency comparable to traditional hyperelastic models while being more capable of handling nuances of complex microstructural deformations. In this paper, we adopt this framework to model fibrous network material using an extensive dataset obtained using MuMFIM.

The primary contribution of this work is a comprehensive numerical material model describing the constitutive response of fibrous material without limiting assumptions such as affine deformation or incompressibility. The model maps the deformation gradient to the strain energy density function from which other relevant quantities, such as stress and stiffness tensor, are obtained. The particular choice of the neural network ensures the resulting model is compatible with the continuum mechanics framework. We further augment the material model’s accuracy through the so-called Sobolev training protocol that considers stress and/or stiffness during ICNN training to obtain noticeably better predictions than ICNN trained using strain energy information only.

The overall computational framework we adopt here targets the finite element-based analysis of problems of practical interest. As a demonstration, we replace the computationally expensive microscale simulation of MuMFIM package with the trained model to analyze the deformation of facet capsule ligament (FCL) and compare the result to that obtained using a concurrently homogenized approach that requires modern GPU-based supercomputers. The new paradigm reduces the computational costs by orders of magnitude while maintaining upward of 85% accuracy in stress response up to 70% uniaxial strain. Thus, we expect that the present work will enable researchers without access to specialized resources to investigate engineering problems involving fibrous materials with ease.

## 2 Methods

The numerical constitutive model developed here is purposefully designed to work with numerical procedures such as finite element methods. Thus, we describe the model’s merits and place in a typical workflow involving fibrous materials by summarizing the relevant components of the overall analysis trajectory.

For macroscale problems of practical interest, a multiscale method such as FE<sup>2</sup>[6] is generally necessary due to the microstructural complexities of the fibrous material. A simplified schematic of this approach is shown in Figure 1a. In this workflow, two finite-element solution modules are utilized. The first module analyzes the discretized macroscale problem, hereafter denoted as the macroscale module. The deformation gradient experienced by a macroscale element is applied to a representative volume element (RVE) by a second finite element solver, hereafter referred to as a microscale module. The output of this module is used to compute material response in the form of stress and stiffness tensor and passed back to the macroscale solver. The process is repeated for all finite elements in the macroscale problem to complete one iteration/step in the macroscale module. A set of GPU-accelerated solvers may be used for the microscale module to solve multiple RVEs concurrently [1].

For multiscale analysis involving fibrous material in MuMFIM-implementation, the RVE is a discrete fiber network model such as 3D Delaunay shown in Figure 1b. The material response required at the integration point of a macroscale element is obtained through numerical simulation of the discrete models. Thus, the macroscale procedure does not require any explicit material model of RVE or

assumptions regarding the deformation of the fibers. However, as a consequence, the microscale module is computationally expensive for problems of practical interest. The current study aims to develop a surrogate model to replace this module.

To develop the numerical constitutive model, we first systematically sample the deformation gradient landscape and use the GPU-accelerated solvers (microscale module) to produce a large dataset that relates the deformation gradients to corresponding stress and stiffness tensors (i.e., the response of discrete RVEs). We then use a part of the dataset to train an input convex neural network (ICNN) that maps the deformation gradient to strain energy density. The remaining data is used as a test set for model verification purposes. The trained model, along with methods to compute stress and stiffness tensor, forms a complete framework that replaces the microscale module in Figure 1a. The merit is realized as an exceptional gain in computational efficiency with an acceptable margin of error, which is discussed in later sections.

For the remainder of this section, we describe in greater detail the key aspects of the overall solution procedure, sampling method, and certain choices associated with the neural network framework, ensuring that all interacting parts are compatible and theoretically sound.

**2.1 Multiscale Finite Element Method.** Here, we present the outline of an upscaling multiscale finite analysis scheme that was originally developed by the authors in [1]. In our multiscale scheme, the Cauchy stress ( $\sigma$ ), and tangent material stiffness ( $\mathbb{C}$ ) are computed from a set of concurrent subscale problems through computational homogenization. This can be contrasted against analytical constitutive models that may have been constructed from a priori homogenization, such as the HGO Model [4]. The inclusion of this subscale problem is what distinguishes the computational method used here from a run-of-the-mill nonlinear finite element method. This methodology is known as a hierarchical or upscaling multiscale method, where we emphasize that the scheme employed here computes subscale problems concurrently with the macroscale solution procedure.

Two key assumptions in the upscaling multiscale formulation are that the subscale problems have behavior representative of a macroscale continuum and the volume of the subscale problem is of a differential size compared with the macroscale finite element within which it resides. These requirements place strict bounds on the size of the RVE.

**2.1.1 Macroscale Problem.** On the macroscale, we use a 3D updated-Lagrangian displacement-based finite element formulation to solve the balance of virtual power.

$$\delta P = \delta P^{\text{int}} - \delta P^{\text{ext}} = 0 \quad \forall \delta \mathbf{v} \in \mathcal{v} \quad (1)$$

where

$$\delta P^{\text{int}} = \int_V \sigma_{ij} \delta D_{ij} dV, \quad (2)$$

$$\delta P^{\text{ext}} = \int_{\partial V} t_i \delta v_i d\Gamma. \quad (3)$$

Here,  $\mathcal{v}$  is the set of kinematically admissible velocity fields,  $\sigma$  is the Cauchy stress,  $\mathbf{D}$  is the symmetric rate of deformation tensor,  $\mathbf{t}$  is the surface traction,  $V$  is the total volume of the body, and  $\partial V$  is the surface of the domain.

By pulling out the virtual velocities from the integrals and noting the arbitrariness of the virtual velocities, we obtain the typical nonlinear discretized equations for the residual:

$$\mathcal{R}_{kI} = \int_V B_{ijkI} \sigma_{ij} dV - \int_{\partial V_j} N_I t_k d\Gamma_j = 0, \quad (4)$$

and the tangent stiffness:

$$K_{kI r J} = \int_V B_{ijkI} \mathbb{D}_{ijpq} B_{pqrJ} dV + \delta_{ij} \int_V B_{ijkI} \sigma_{pq} B_{pqrJ} dV, \quad (5)$$

where majuscule indices correspond to nodal degrees of freedom, and minuscule indices correspond to spatial dimensions.  $\mathbf{B}_I$  is the shape function derivatives at node  $I$ ,  $N_I$  is the shape functions at node  $I$ , and  $\mathbb{D}$  is the tangent material stiffness. For the updated-Lagrangian finite element procedure, the material stiffness is given as the push forward of the derivative of the second Piola-Kirchhoff with respect to the Green-Lagrange strain. That is:

$$\mathbb{D}_{mnpq} = \frac{1}{J} F_{mi} F_{nj} \frac{\partial \Pi_{ij}}{\partial E_{rs}} F_{pr} F_{qs}. \quad (6)$$

**2.1.2 Downscaling.** An upscaling homogenization scheme requires information passing between the macro and subscale model at each integration point. Downscaling is the process of passing the macroscopic strains *down* to the subscale. Here, we take the subscale displacements as a Taylor series about the macroscopic integration point, that is:

$$\mathbf{x}^s(\mathbf{X}^M, \mathbf{X}^s) = \mathbf{X}^M + \mathbf{F}^M \cdot (\mathbf{X}^s - \mathbf{X}^M) + \tilde{\mathbf{x}}^s(\mathbf{X}^M, \mathbf{X}^s), \quad (7)$$

where  $vx^s$  is the subscale coordinate,  $\mathbf{F}^M$  is the macroscopic deformation gradient at the integration point, and  $\tilde{\mathbf{x}}^s$  are the higher-order terms that are typically described as fluctuations. To proceed, we make the following choices, which can be interpreted as orthogonality of the mean and fluctuating fields [24,25].

- (1) The RVE centroid is coincident with the macroscopic integration point:

$$\int_{V^s} (\mathbf{X}^s - \mathbf{X}^M) dV = 0. \quad (8)$$

- (2) The macroscopic deformation gradient is the volume average of the subscale deformation gradient:

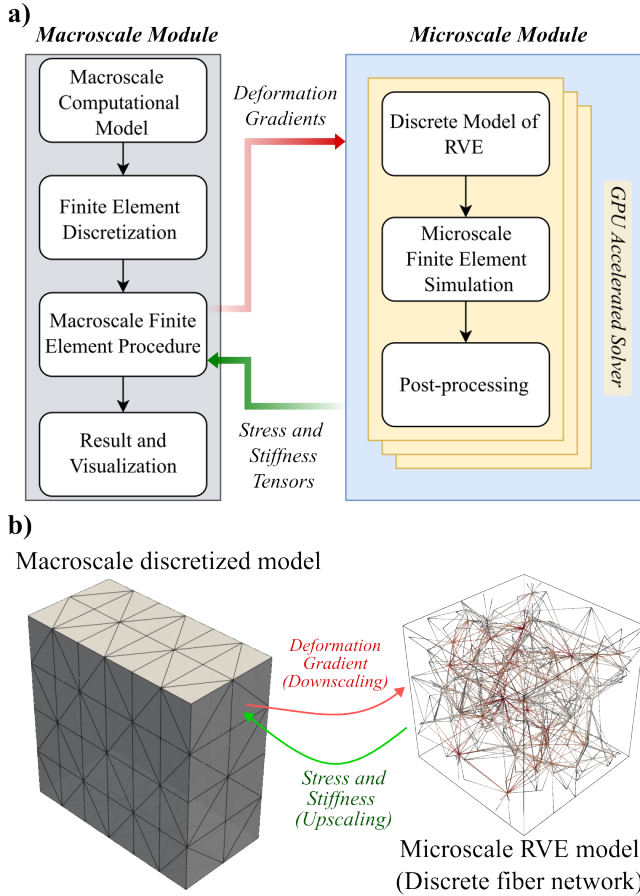
$$\mathbf{F}^M = \frac{1}{V^s} \int_{V^s} \mathbf{F}^s dV. \quad (9)$$

Three types of boundary conditions are common: homogeneous displacement, homogeneous traction, and periodic. However, any set of boundary conditions that satisfies:

$$\int_{\Gamma^s} \tilde{\mathbf{x}}^s \otimes \mathbf{n} d\Gamma = \mathbf{0} \quad (10)$$

can be used. In this work, we use homogeneous displacement boundary conditions.

Many authors argue for the use of periodic boundary conditions because it reduces the size of the RVE that is needed. However, fibrous materials are not periodic, so this choice is not appropriate. Instead, one may use the so-called "Generalized Boundary Condition" of [26], which has been extended to fibrous materials [7]. This boundary condition can be used to help mitigate the significant size effect that is present in these materials [7].



**Fig. 1** (a) Schematic of a typical workflow of MuFim multiscale procedure that involves two finite element solution modules that handle the macro and microscale part of the problem, respectively. The deformation gradient, as informed by the macroscale module, is used to simulate RVEs to estimate the material response. For fibrous materials, the RVE is a discrete fiber network model (e.g., 3D Delaunay network shown in (b)). The machine learning model presented in this study is intended to be an accurate model of the RVE and aims to replace the ‘microscale’ module in panel (a).

**2.1.3 Upscaling.** Upscaling is the process of transferring data back to the macroscopic problem from the subscale problem. It requires application of the Hill-Mandel criterion, which states that the volume average of an increment in the microscopic power density is equal to the macroscopic power density. Or:

$$\int_{V^s} \boldsymbol{\sigma}^s : \delta \mathbf{D}^s dV = \boldsymbol{\sigma}^M : \delta \mathbf{D}^M. \quad (11)$$

Based on equation (11), we identify the following upscaling rule for the stress:

$$\boldsymbol{\sigma}^M = \frac{1}{V^s} \int_{V^s} \boldsymbol{\sigma}^s dV. \quad (12)$$

An additional rule is needed to upscale the material stiffness as needed for the macroscale tangent stiffness matrix calculation (equation (5)). Determination of this upscaling rule is challenging, as it requires a derivative of the mean subscale stresses with respect to the macroscale strains.

If Jacobians are available, one can use the reduced stiffness method described in [27], or the non-affine approach described in [2]. However, fiber simulations typically have significant parts of the load path that have singular Jacobians due to nonlinearities. We have found that use of these methods is not robust when large numbers (tens of thousands to millions) of subscale problems must be computed simultaneously. This is because failed convergence of any single RVE prevents the overall macroscale solution from proceeding.

Instead, we make use of an alternative, finite difference approach that works well with the Jacobian free dynamic relaxation solution procedures we use to robustly solve the subscale network problems (see 2.1.4). Making use of symmetries does require six additional solves of the subscale problem; however, these typically converge quickly as they only represent small perturbations.

Here, we provide the key equations for computing the material stiffness with the finite difference method; however, a more complete discussion can be found in [1].

From equation (6), we note that we must find the derivative of the macroscopic second Piola-Kirchhoff stress with the macroscopic Green-Lagrange strain and perform the push forward to obtain  $\mathbb{D}$ , which is used in the updated-Lagrangian finite element calculations. In the remainder of this section, we will use square brackets to refer to the Mandel form of symmetric fourth-order tensor quantities.

The finite difference computation proceeds as follows:

- (1) Compute the stresses in six perturbed directions and compute the finite difference tensor:

$$P_{ijpq} = \frac{\Pi_{ij}(U_{lm} + hT_{lmpq}) - \Pi_{ij}(U_{lm})}{h}, \quad (13)$$

where the directions are given by:

$$[\mathbf{T}] = \frac{1}{2} \begin{bmatrix} 1 & 0 & 0 & 0 & \sqrt{2} & \sqrt{2} \\ 0 & 1 & 0 & \sqrt{2} & 0 & \sqrt{2} \\ 0 & 0 & 1 & \sqrt{2} & \sqrt{2} & 0 \\ 0 & 0 & 0 & 2 & 0 & 0 \\ 0 & 0 & 0 & 0 & 2 & 0 \\ 0 & 0 & 0 & 0 & 0 & 2 \end{bmatrix}, \quad (14)$$

in Mandel form.

- (2) Solve:

$$([\mathbf{M}] [\mathbf{T}])^T \left[ \frac{\partial \boldsymbol{\Pi}}{\partial \mathbf{E}} \right]^T = [\mathbf{P}]^T \quad (15)$$

where

$$[\mathbf{M}] = \frac{1}{2} \begin{bmatrix} 2U_{11} & 0 & 0 & 0 & \sqrt{2}U_{13} & \sqrt{2}U_{12} \\ 0 & 2U_{22} & 0 & \sqrt{2}U_{23} & 0 & \sqrt{2}U_{12} \\ 0 & 0 & 2U_{33} & \sqrt{2}U_{23} & \sqrt{2}U_{13} & 0 \\ 0 & \sqrt{2}U_{23} & \sqrt{2}U_{23} & U_{22}+U_{33} & U_{12} & U_{13} \\ \sqrt{2}U_{13} & 0 & \sqrt{2}U_{13} & U_{12} & U_{11}+U_{33} & U_{23} \\ \sqrt{2}U_{12} & \sqrt{2}U_{12} & 0 & U_{13} & U_{23} & U_{11}+U_{22} \end{bmatrix}, \quad (16)$$

and  $U$  is the right stretch tensor.

As described in [1], the probing directions  $[\mathbf{T}]$  are not unique; however, they should correspond to positive definite (tensor) directions.

### 2.1.4 Subscale.

**Network Generation.** In this work, we use Delaunay fiber networks. The network construction procedure proceeds as follows: First, a generation box is seeded with points using a uniform random distribution. A Delaunay triangularization is then constructed from the initial seed points. To avoid boundary effects, the generation box is trimmed so that the new edge length is half of the one used for the generation box. New nodes are inserted at the intersection of the trimming box and any crossing fibers. The fiber segments that remain outside the trimming box are deleted. This process will yield fiber networks with an average connectivity of  $z \approx 14$ . This is well above the isostaticity limit for 3D truss networks. The constitutive model for each fiber is given by:

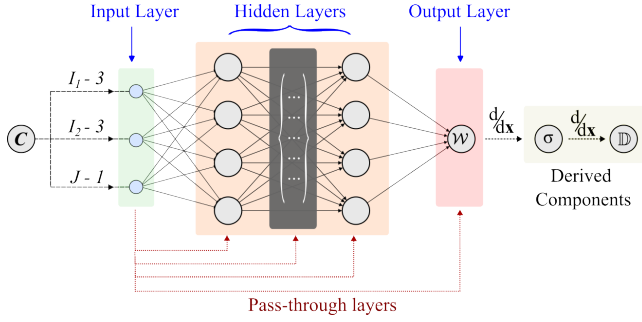
$$\boldsymbol{\Pi} = E \boldsymbol{\varepsilon}, \quad (17)$$

where  $\boldsymbol{\Pi}$  is the second Piola-Kirchhoff stress,  $E$  is the elastic modulus, and  $\boldsymbol{\varepsilon}$  is the Green strain. This can alternatively be represented as the force along a fiber  $P = EA_0 \lambda_1 \varepsilon_{11}$ , where  $A_0$  is the initial fiber area.

**Solution Procedure.** Due to the difficulties in converging discrete fiber network models, many authors make use of explicit techniques to overcome large material nonlinearities [28,29]. In these papers, large strains are achieved using dynamic explicit simulations and maintaining the proportion of kinetic energy to strain energy at below five percent. This convergence difficulty was also observed with the Delaunay networks used herein. However, adherence to the Hill-Mandel criterion means that there can be no remaining kinetic energy in the subscale system. To overcome this, we use the dynamic relaxation procedure that was developed in [1]. The dynamic relaxation solver makes use of the insight that when a damped dynamic system comes to rest in a state where the internal and external forces (excluding damping) come into balance, this is a state of static equilibrium. Here, a time-dependent central difference solver is used with linear velocity damping ( $\mathbf{f}^{\text{damp}} = c\mathbf{v}$ ). The damping coefficient and density are parameters that can be chosen to accelerate the convergence.

**2.2 Machine Learning Model.** The majority of the computational cost in the multiscale method is incurred in the distributed parallel analysis of RVEs, owing to the lack of an analytical constitutive model [1]. The primary contribution of this work is toward providing a neural network-based framework that will approximately model the fibrous network material. Therefore, the trained model can act as a drop-in replacement of subscale simulations, which reduces the FE<sup>2</sup> method to the traditional FE algorithm that executes at a fraction of the computational cost of the MuMFiM[1]. To this end, we assume the material behavior is hyperelastic up to the point of failure, which is supported by numerical and experimental results [4,30,31].

The hyperelastic formulation entails finding a non-negative, non-decreasing, and convex scalar energy density function ( $\mathcal{W}$ ), in



**Fig. 2** Schematic of the input convex neural network we implement. The input vector consists of invariants of the right Cauchy-Green deformation tensor ( $\mathbf{C}$ ), and the output is the predicted strain energy density ( $\mathcal{W}$ ). The components of true stress ( $\sigma$ ), and stiffness tensor ( $\mathbb{D}$ ), are computed using automatic differentiation of the trained model.

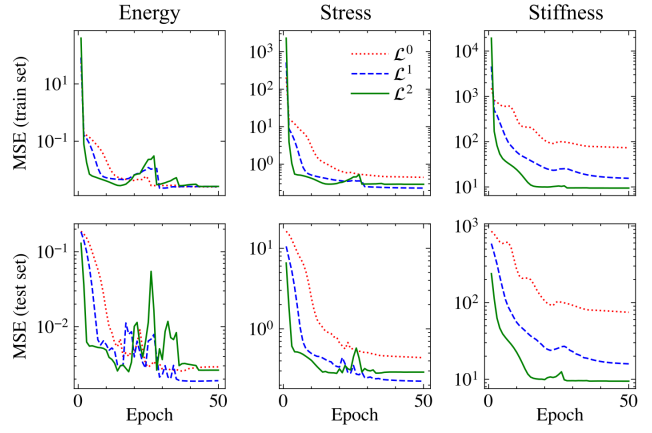
terms of deformation-related quantities [32,33]. The stress and stiffness tensor components are then found through appropriate first and second-directional derivatives of  $\mathcal{W}$ . The convexity condition implies the machine learning algorithm must be chosen or designed appropriately [23,34]. Here, we employ the Input Convex Neural Network (ICNN) model, which guarantees that the overall mathematical form of the neural network will be convex for the proper choice of input and output quantities. The ICNN network was originally pioneered in [23]. Various authors have used the ICNN as a basis for hyperelastic material modeling [17,33–36]. A schematic of the neural network model we implemented is shown in Figure 2.

ICNN is a particular form of fully connected neural network with restrictions on activation functions and weights. The convexity of the model is ensured by strictly adhering to (i) convex activation functions, and (ii) non-negative weights. While the first requirement is trivial, non-negative weights limit the scope of the neural network when modeling complex phenomena [23]. To counter, a number of pass-through layers without restrictions on weights or biases are introduced that connect the input to the hidden layer neurons. These pass-through layers amount to affine mapping of input to hidden layer neurons. Therefore, if the ICNN output is a convex function of the input, the convexity condition on the strain energy density function is satisfied by construction.

Here, we aim to map the principal invariants of the Right Cauchy-Green deformation tensor to the deformed material’s strain energy density through ICNN. Following [36], the input layer of ICNN consists of modified invariants of the right Cauchy-Green deformation tensor ( $I_1 - 3$ ,  $I_2 - 3$ , and  $I_3 - 1$ ). This choice helps to normalize the input values. We employ the *Soft Plus* activation function defined as  $g(x) = 1/\beta \log(1 + \beta \exp(x))$  with  $\beta = 1$ , a choice inspired by [17,34]. The function is non-negative, non-decreasing, and convex in  $x$ . A second function ( $f$ ), of similar characteristics, is applied over the weights to fulfill the requirements for positive weights. Here, we choose  $f = g$  without loss of generality. Therefore, the resulting general form of the strain energy density function is non-negative, non-decreasing, and convex by construction.

This model, however, does not guarantee vanishing strain energy at zero strain (i.e.,  $\mathcal{W}(\mathbf{F} = \mathbf{I}) = 0$ ), due to the nature of activation functions. The optimization algorithm can overcome this shortcoming by adjusting the biases in the pass-through layers. Figure 4 indicates that the requirement is approximately satisfied. An alternative approach can be introducing standalone bias terms to act as correction factors, for example, in [17].

The ICNN we train contains five fully connected hidden layers, each having four neurons in the primary branch. The pass-through layers connect the input vector to these hidden layer neurons, giving a total of 164 trainable parameters. Mathematically, the output of



**Fig. 3** Mean squared error (loss) of ICNN during training. The average errors associated with strain energy density, stress, and stiffness tensors are shown in the first, second, and third columns, respectively. The top row shows the loss for the training dataset, and the bottom row represents the corresponding results for the test dataset. The legend  $\mathcal{L}^k := \sum_{i=0}^k H_i$  indicates the variant of the loss function used to train ICNN, with  $k$  being the highest order of derivative included in the composite loss function.

the neurons in the  $i$ -th hidden layer is  $\mathbf{z}^{(i)} = g(f(\mathbf{A}^{(i)}\mathbf{z}^{(i-1)} + \mathbf{A}_p^{(i)}\mathbf{x} + \mathbf{b}_p^{(i)}))$ . Here,  $\mathbf{x}$  is the input vector to the model, and  $\mathbf{A}^{(i)}$  is the weight matrix for the  $i$ -th layer of the primary branch. The final two terms ( $\mathbf{A}_p^{(i)}$  and  $\mathbf{b}_p^{(i)}$ ) represent the weight matrix and bias vector due to the pass-through connection to the  $i$ -th layer, respectively. The model is trained on 91,590 samples, with an 80/20 split for the train/test dataset. We use Adams solver for parameter optimization without any weight decay [37]. The model parameters are initialized using Kaiming uniform distribution [38]. We use the mean squared error  $MSE(y) = (y_{\text{pred}} - y_{\text{true}})^2$  as the template for the loss function.

In the original and most subsequent implementations of ICNN, the loss function is based on the output variable only. For our purpose, this translates to hyperparameter optimization based on strain energy density. However, due to the large number of trainable parameters, the prediction accuracy for energy does not generally translate to its derivative quantities such as stress and stiffness, which are necessary for FE simulations. To increase the prediction accuracy of the derivatives, we implement the so-called Sobolev training protocol such that the model is trained on the target output and its derivatives concurrently [39]. Here, we include both the first and second derivatives in the ICNN training procedure as follows. For the  $i$ -th batch iteration within an epoch, in addition to the loss in energy ( $H_0 = MSE(\mathcal{W})$ ), we compute the component-average loss in stress ( $H_1 = \langle MSE(\sigma) \rangle$ ) and stiffness ( $H_2 = \langle MSE(\mathbb{D}) \rangle$ ) through automatic differentiation of the ICNN (updated in the  $i - 1$ -th iteration). The total loss per batch is computed as  $\mathcal{L}^k = \sum_{j=0}^k H_j$ , with  $k = 2$  being the highest order of derivative considered. The model parameters are then updated based on the total loss, and the cycle is repeated. The learning rate is adjusted automatically at the end of an epoch based on the mean loss such that the learning rate decreases by a factor of ten if the loss exhibits a plateau for five consecutive epochs. We use a moderately large batch size, so the loss (especially in the gradients) approximated from a batch is representative of the population. Finally, we note that the construction of neural network determines the convexity and smoothness of the model. Sobolev training is an add-on intended for accurate prediction of higher-order quantities only.

**2.2.1 Training Data Generation.** One of the major challenges with developing machine learning models is that it is difficult to know if a given input was reasonably covered by the training dataset. We have developed a novel sampling methodology that allows for explicit control over the range of principal stretch values in which we may be interested. This explicit control provides a mechanism to verify whether a given deformation state is likely to be covered by the training data.

Since our constitutive response must be frame-indifferent, we can sample the set of positive definite right stretch tensors. The standard relations can be used to map the resulting stress and stiffness back to a rotated frame as needed for the analysis procedures.

We employ the following algorithm to construct our set of positive definite right stretch tensors:

- (1) Sample principal stretches  $\lambda_1, \lambda_2, \lambda_3 \in [\lambda_{\min} = 0.85, \lambda_{\max} = 1.15]$ , using Latin hypercube sampling
- (2) Construct base right stretch tensor:

$$\mathbf{U}_i^* = \begin{pmatrix} \lambda_1 & 0 & 0 \\ 0 & \lambda_2 & 0 \\ 0 & 0 & \lambda_3 \end{pmatrix} \quad (18)$$

- (3) Sample a random rotation matrix:  $\mathbf{R}_j$
- (4) Construct a realization of the stretch tensor using the polar decomposition formula:

$$\mathbf{U}_j = \mathbf{R}_i \mathbf{U}_i^* \mathbf{R}_j^T \quad (19)$$

- (5) Repeat steps (3)–(4) until sufficient samples are collected for this set of stretches.
- (6) Repeat steps (1)–(5) until a sufficient number of base stretches are sampled.

If a constant number of samples is used within each ellipsoidal shell that is represented by a given base stretch  $\mathbf{U}_i^*$ , then each data point will cover a varying volume in phase space. To avoid this problem, the number of rotation samples constructed for each set of base stretches is scaled by the surface area of the ellipsoid, with  $\lambda_1, \lambda_2, \lambda_3$  forming the ellipsoid axes. This will ensure that, in a statistical sense, each sampled point will cover a constant volume in phase space, which is critical to avoid oversampling and associated overfitting. These sampled deformations are used as inputs to our GPU accelerated network solver in MuMFiM to generate the neural network training and test dataset.

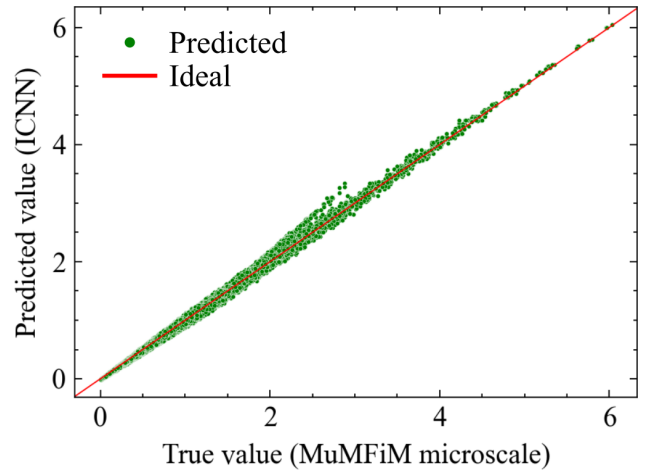
**2.2.2 Model Availability.** The neural network model was implemented using the PyTorch [40] framework and is available for public use along with the dataset on which the network was trained.<sup>2 3</sup> The detailed numerical values of model parameters omitted here for brevity are available in the code repository.

### 3 Results and Discussions

In this section, we first present the model’s predictive capability and the improvements brought forth by the Sobolev training protocol. We then present a case study involving mechanical deformation of the Facet Capsule Ligament, simulated using the trained model. Finally, we compare the output to the results of MuMFiM-based large-scale numerical simulation to comment on the efficacy of the current approach.

<sup>2</sup>The dataset is available at <https://zenodo.org/doi/10.5281/zenodo.11205879>

<sup>3</sup>The source code is available at <https://github.com/LACES-LAB/ML-biotissues>

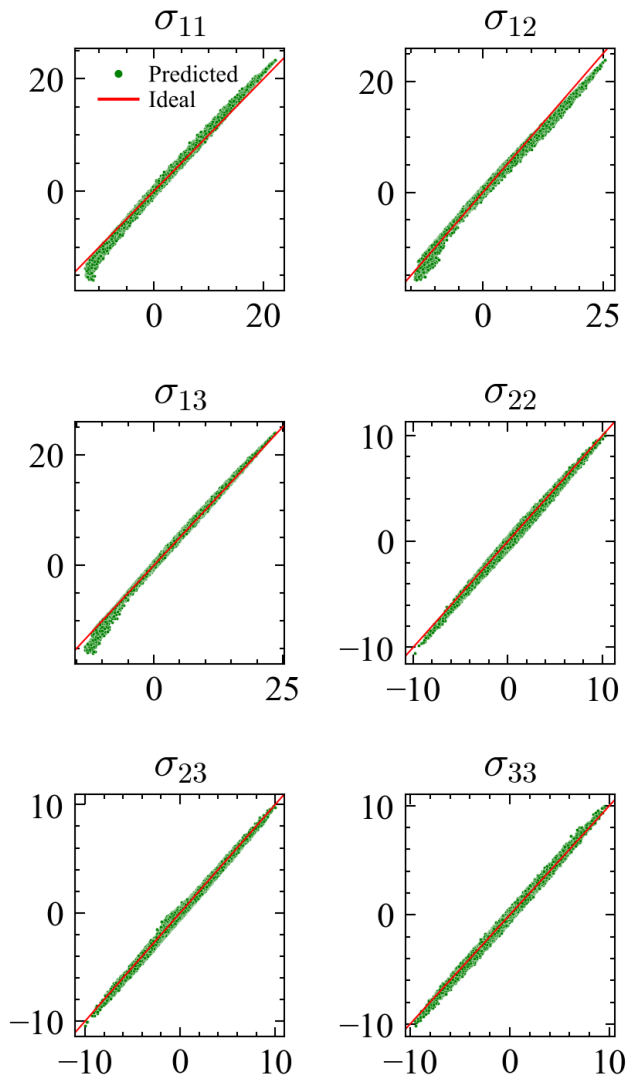


**Fig. 4 True (MuMFiM) vs ICNN-predicted strain energy density for various deformation gradients ( $F$ ) in test dataset using ICNN trained with  $\mathcal{L}^2$  loss function. The dashed red line indicates the ideal fit, and scatters indicate predictions. The value of normalized mean squared error is 0.15% for this dataset.**

**3.1 Sobolev Training of ICNN.** We first discuss the overall predictive accuracy of the input convex neural network (ICNN) in terms of the average loss of desired quantities. This energy, stress, and stiffness result is shown in the first, second, and third columns of Figure 3. We compare three variants of the model emanating from the choice of the composite loss function (i.e.,  $k = 0, 1, 2$  in  $\mathcal{L}^k = \sum_{j=0}^{j=k} H_j$ ), indicating the highest derivatives included in the loss function.

The first column of Figure 3 shows the loss in *strain energy density* for different choices of the overall loss function. Expectedly, the choice of loss function has a negligible effect on the predictive accuracy of strain energy density. The derivative quantities (such as stress), however, benefit from including  $H_1$  in the loss function (curves corresponding to  $\mathcal{L}^1$ ). This result is shown in the second column of Figure 3. The additional information passed to the optimizer also improved the predictive accuracy of stiffness, as shown in the final column of the figure. Naturally, including the loss in stiffness in the overall loss function (curves corresponding to  $\mathcal{L}^2$ ) improved the predictive accuracy of the stiffness for both the training and test datasets. Comparing the loss function variants, it is evident that including higher-order derivatives of the output function improved the accuracy of the derivative quantities at any given epoch. The substantial improvement in stiffness prediction accuracy is especially beneficial for the downstream finite element algorithm, which would be a typical use case of the ICNN-based model developed here. Consequently, subsequent discussions focus on the  $\mathcal{L}^2$  variant only.

**3.2 Numerical Constitutive Model.** At this point, we comment on the accuracy of the trained ICNN for individual components of the desired outputs. We use the normalized MSE, computed as  $\text{NMSE}(y) = \text{MSE}(y) / \text{mean}(y_{\text{true}}^2)$ , as the measure of deviation from the true value (numerical solution). To start, we present the true vs predicted values of the strain energy density function for the test samples in Figure 4. In this figure, the ICNN-predicted strain energy density corresponding to the numerical solution is shown via scatters. The red line indicates the ideal match between true and predicted value (i.e., slope = 1.) The computed NMSE for strain energy density is approximately 0.15%, indicating exceptional predictive accuracy. Similarly, the true vs predicted values for the unique components of the Cauchy stress tensor are shown in Figure 5. The average NMSE for the stress



**Fig. 5 True (MuMFiM) vs ICNN-predicted values for unique components of Cauchy stress tensor for various deformation gradients ( $F$ ) in test dataset. The component averaged value of normalized MSE is 0.815%. The result is based on ICNN trained with the  $\mathcal{L}^2$  loss function.**

tensor components is 0.815%, with a maximum of 1.25% from  $\sigma_{22}$  component.

The mean normalized error increased to 5.4% for the stiffness tensor components shown in Figure 6. The maximum deviation was recorded for  $\mathbb{D}_{1312}$  at 23.35%, which is also reflected in the figure as a visible drift from the ideal fit. The loss of accuracy for stiffness is not necessarily surprising. Two potential reasons are: (i) an amplification of noise due to numerical differentiation techniques used to compute the derivative quantities, and (ii) the near-constant gradient of the activation functions at large inputs. The modeling is further complicated by the fact that the underlying data relates to a stochastic fibrous material, which is not guaranteed to have a smooth energy landscape. Despite these challenges, the machine-learned constitutive model is able to faithfully reproduce results on an exemplar Facet Capsular Ligament geometry (Figure 7).

**3.3 Case Study: Uniaxial Tension of FCL.** To demonstrate the efficacy of the ICNN-based model, we present a comparison of the results of a boundary value problem with a 3D model of

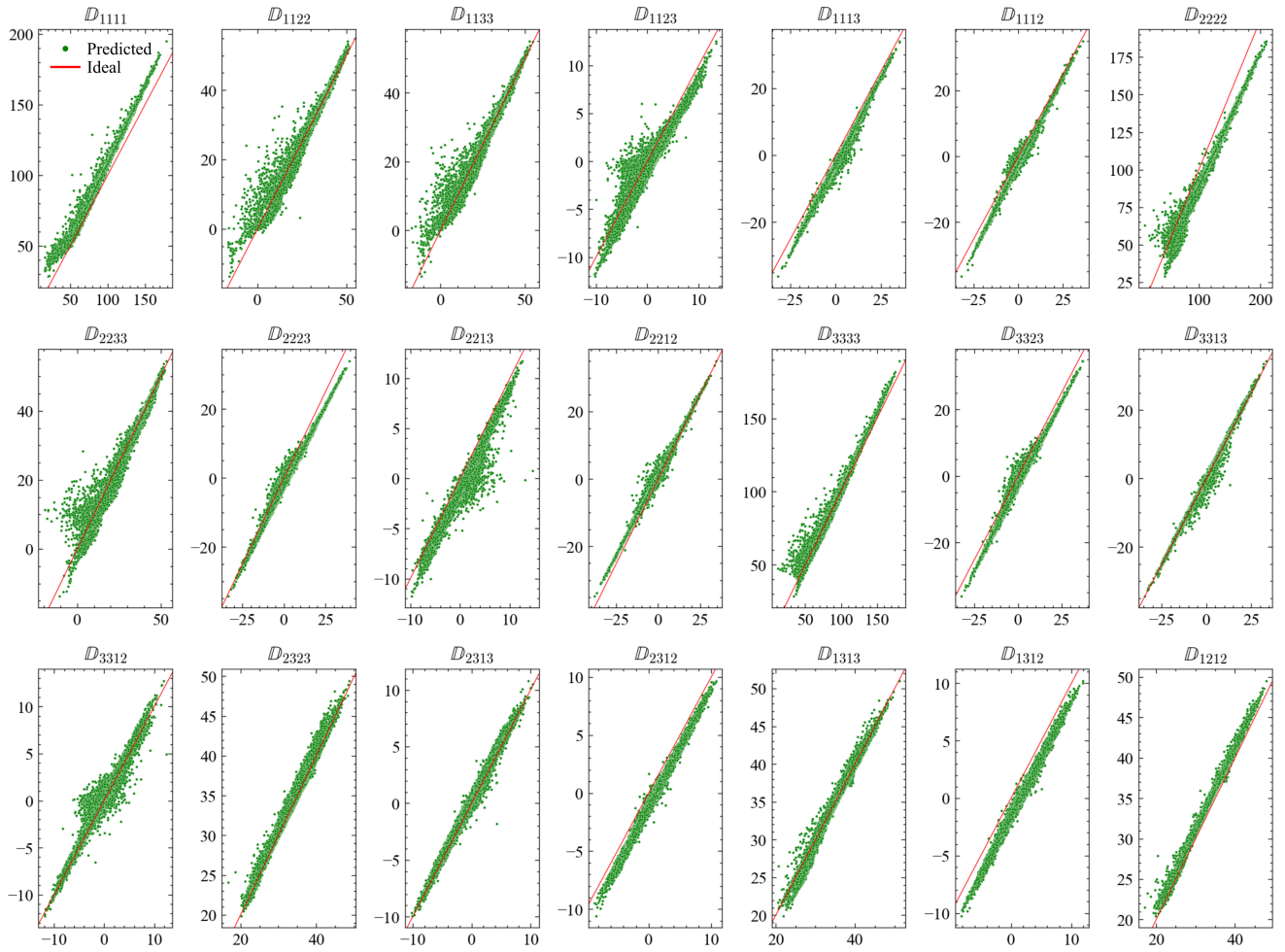
facet capsular ligament geometry (FCL). To this end, we consider “bone” boundary conditions on the left and right surfaces of the FCL model. In this setup, the left surface is held encastre, and the right surface is fixed in the  $y$  and  $z$  directions and displaced in the  $x$  direction. The meshed geometry and boundary conditions are shown schematically in Figure 7(a). The remaining boundaries are in a traction-free condition. We solve this problem in two ways: First, we use the MuMFiM package to obtain a fully numerical solution. Next, we solve the same problem with trained ICNN as the material model. In other words, we replace the ‘microscale module’ in Figure 1a with an ICNN-based framework. We treat the MuMFiM solution as the reference result for this comparison. A more detailed study of this problem is available in [1].

The deformed configurations at approximately 70% global strain obtained from ICNN and MuMFiM-based simulations are shown in Figure 7b and 7c, respectively. The color represents the true stress in the elements along the loading direction. Visually comparing these results, it is immediately clear that the ICNN-based approach closely replicates the predictions of MuMFiM, including the shear-band-like phenomena appearing due to the geometry of the ligament. We also show the result obtained with a calibrated compressible neo-Hookean model in 7d. This model predicts a more diffused band with a far smaller maximum stress. Although neo-Hookean is the simplest material model for hyperelastic behavior, it captures the essence of the difficulties associated with classical continuum models in the context of fibrous network materials. The small parameter space of classical models and strict assumptions regarding the shape of the strain energy density functions fail to capture the complexities arising from the kinematics of the fibers in fibrous materials. A neural network model such as the one developed here thus presents a trade-off between explainability and generality.

The stress-strain response of the facet capsular ligament extracted from the MuMFiM and ICNN-based simulation are presented in Figure 8. Both approaches predict exponential stiffening, which is a hallmark behavior of soft biological tissues [30,41,42]. The neo-Hookean model calibrated at the small strain limit is also shown for completeness. The results indicate that the ICNN-based method retains reasonable accuracy up to a very large strain, while reducing the computational resource requirement by orders of magnitude—from GPU-accelerated super-computers to consumer-grade laptops. The inset of Figure 8 shows the measured relative error of the ICNN result for stress with respect to MuMFiM. The maximum relative error is in the small-strain regime and upward of 50%. The deviation, however, falls rapidly below 20% at approximately 10% strain. The discrepancy in the small strain regime is related to a similar deviation in the predicted stiffness, where the true values are close to zero (Figure 6) and the relative dominance of numerical noise when the true value is small. In fibrous network materials such as biological tissues, however, the large strain regime is the principal concern [9]. Given the computational cost for large-scale simulation of fibrous materials and the technical difficulties required to develop efficient algorithms such as those employed in [1], the current model presents an excellent pathway for obtaining approximate results involving the deformation of fibrous materials. Although our work does not obviate the need for large-scale numerical simulations, it does provide a pathway for those in the community to make use of results from those expensive simulations with modest computational resources.

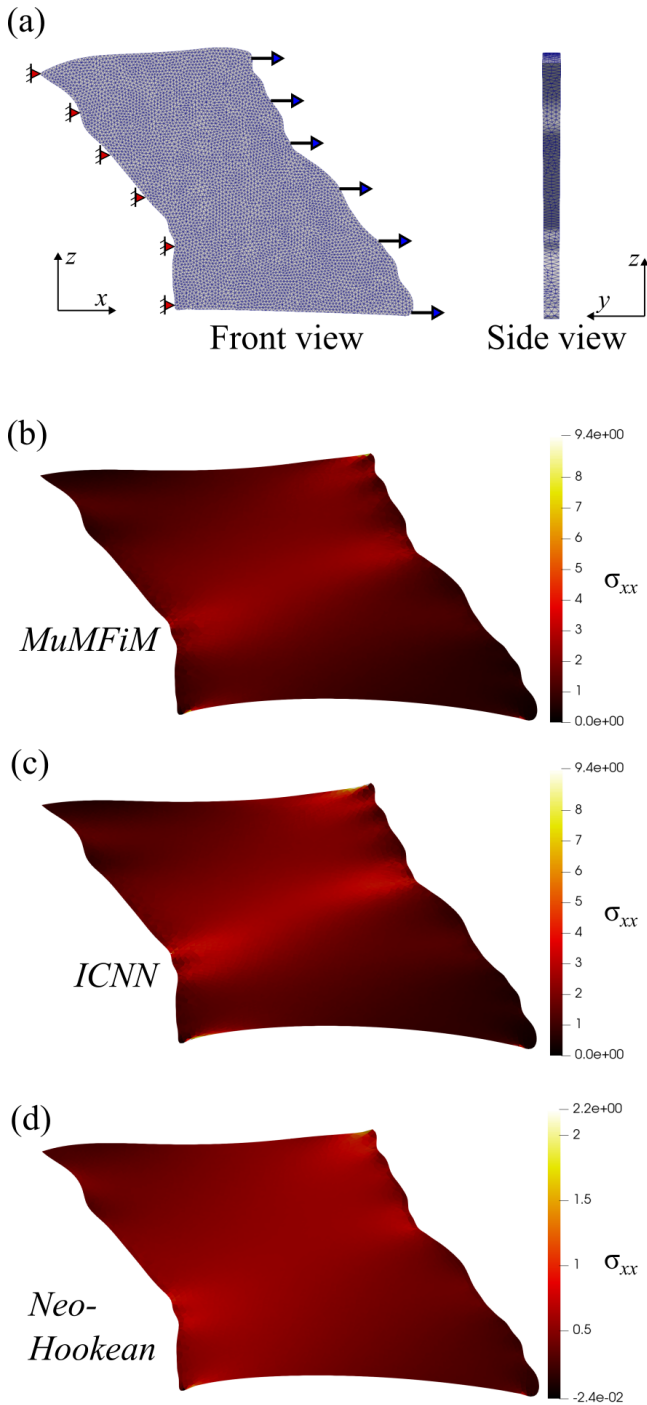
**3.4 Limitations.** The ICNN-based model developed here suffers from several limitations. The major shortcomings are enumerated below.

- (1) *Limited availability of training data:* Our model relies on the higher-order derivatives of the energy function to achieve superior predictive accuracy for quantities such as stiffness tensor components. These datasets are generally not readily available, especially for novel materials. Under these limiting circumstances, we suggest making use of alterna-

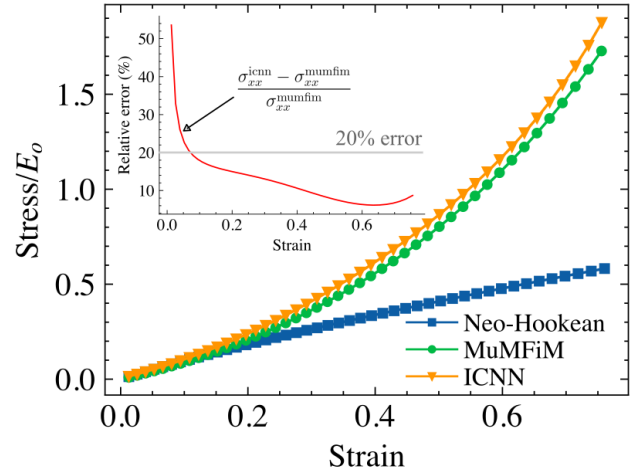


**Fig. 6 True (MuMFIM) vs ICNN-predicted values of the unique components of stiffness tensor for various deformation gradients ( $F$ ) in test dataset using ICNN trained with  $\mathcal{L}^2$  loss function. The average normalized MSE score is 5.4% (maximum: 23%, minimum: 0.03%).**





**Fig. 7** (a) Geometry and boundary conditions for numerical simulation of facet capsule ligament (FCL) under uniaxial tension along the x-axis. (b) Deformed configuration at 70% strain based on large scale MuMFiM/FE<sup>2</sup> simulation. (c) Deformed configuration at same strain using standard finite element method with trained ICNN ( $\mathcal{L}^2$  variant) as the constitutive descriptor, and (d) with calibrated neo-Hookean material model. The color indicates the true stress in the elements along the loading direction.



**Fig. 8** True stress as a function of Green-Lagrange strain in the loading direction based on MuMFiM neo-Hookean, and ICNN-based simulations of FCL under uniaxial tension. The relative error of ICNN-based prediction with respect to MuMFiM output is shown as inset.

tive models that rely on available datasets only while being mindful of the loss of accuracy for higher-order quantities.

- (2) *Limited accuracy in the small strain regime:* Our model does not enforce  $\mathcal{W} = 0$  for  $\mathbf{F} = \mathbf{I}$  due to the model architecture, specifically, the same constraints that ensure the model convexity. However, the optimizer can adjust the bias in pass-through layers without any constraints to push  $\mathcal{W}$  arbitrarily close to zero. The trained model indeed shows such convergence for strain energy density and stress (Figure 4 and 5). Additionally, the numerical derivatives used to compute the higher-order quantities amplify the noise. We speculate these two factors combined produce this discrepancy.
- (3) *Anticipated loss of accuracy for extreme deformation:* We anticipate the model will gradually lose accuracy beyond the scope of the training dataset. This is particularly important if the problem of interest contains singularities such as sharp cracks. In such use cases, the predictions should be scrutinized carefully, or the model should be re-trained with an extended dataset if necessary.

We hope the published code and dataset will increase interest in this approach and lead to more general models encompassing other microstructural aspects such as fiber prealignment and flocculation.

#### 4 Conclusion

In this paper, we have developed a novel numerical constitutive model based on an Input Convex Neural Network (ICNN) that is able to accurately predict energies, stresses, and stiffnesses for fibrous materials without limiting assumptions such as affine deformation of microscale fibers or incompressibility. This neural network preserves important constitutive constraints such as polyconvexity and frame indifference through its structure. The strict enforcement of these constraints is critical to obtaining outputs that can be used in well-posed finite element simulations. By construction of higher-order tensor quantities through back-propagation of derivatives, we are additionally able to obtain symmetric stiffness tensors as required by the mathematical description of hyperelastic materials.

We show that constitutive constraints alone are not enough to construct accurate models of stress and stiffness. The contributions of this work stem from: First, the incorporation of the Sobolev training protocol, which involves including higher-order deriva-

tives in the loss function, significantly improves the model's prediction accuracy for stress and stiffness. Second, the trained model, when used as a replacement for the subscale segment of multiscale procedure such as  $FE^2$  or as a material model in standard finite element procedures, provides a quantitatively similar solution to practical problems of interest at a fraction of the computational cost. Despite their accuracy, performing  $FE^2$  multiscale simulations requires significant computational resources that are out of reach for most biomechanical researchers. Our material model provides a bridge between the computational demands of multiscale simulations and the typical accuracy needed to derive important biomechanical insights. We exemplify this through the analysis of a Facet Capsular Ligament and believe that others can benefit from applying this method to their research.

## References

- [1] Merson, J. S., Picu, C. R., and Shephard, M. S., 2024, “A New Open-Source Framework for Multiscale Modeling of Fibrous Materials on Heterogeneous Supercomputers,” *Engineering with Computers*.
- [2] Mahutga, R. R., Barocas, V. H., and Alford, P. W., 2023, “The Non-Affine Fiber Network Solver: A Multiscale Fiber Network Material Model for Finite-Element Analysis,” *Journal of the Mechanical Behavior of Biomedical Materials*, **144**, p. 105967.
- [3] Lai, V. K., Hadi, M. F., Tranquillo, R. T., and Barocas, V. H., 2013, “A Multiscale Approach to Modeling the Passive Mechanical Contribution of Cells in Tissues,” *Journal of Biomechanical Engineering*, **135**(7), 071007.
- [4] Holzapfel, G. A., Gasser, T. C., and Ogden, R. W., 2000, “A New Constitutive Framework for Arterial Wall Mechanics and a Comparative Study of Material Models,” *Journal of elasticity and the physical science of solids*, **61**(1), pp. 1–48.
- [5] Melly, S. K., Liu, L., Liu, Y., and Leng, J., 2021, “A Review on Material Models for Isotropic Hyperelasticity,” *International Journal of Mechanical System Dynamics*, **1**(1), pp. 71–88.
- [6] Feyel, F., 1999, “Multiscale FE2 Elastoviscoplastic Analysis of Composite Structures,” *Computational Materials Science*, **16**(1), pp. 344–354.
- [7] Merson, J. and Picu, R., 2020, “Size Effects in Random Fiber Networks Controlled by the Use of Generalized Boundary Conditions,” *International Journal of Solids and Structures*, **206**, pp. 314–321.
- [8] Merson, J. and Shephard, M. S., 2023, “Using Hierarchical Parallelism to Accelerate the Solution of Many Small Partial Differential Equations,” doi: [10.48550/arXiv.2305.07030](https://doi.org/10.48550/arXiv.2305.07030), [2305.07030](https://doi.org/10.48550/arXiv.2305.07030)
- [9] Picu, C. R., 2022, *Network Materials: Structure and Properties*, 1st ed., Cambridge University Press.
- [10] Hatami-Marbini, H. and Picu, R. C., 2009, “Effect of Fiber Orientation on the Non-Affine Deformation of Random Fiber Networks,” *Acta Mechanica*, **205**(1), pp. 77–84.
- [11] Broedersz, C. and MacKintosh, F., 2011, “Molecular Motors Stiffen Non-Affine Semiflexible Polymer Networks,” *Soft Matter*, **7**(7), pp. 3186–3191.
- [12] Lake, S. P., Cortes, D. H., Kadlowec, J. A., Soslosky, L. J., and Elliott, D. M., 2012, “Evaluation of Affine Fiber Kinematics in Human Supraspinatus Tendon Using Quantitative Projection Plot Analysis,” *Biomechanics and Modeling in Mechanobiology*, **11**(1), pp. 197–205.
- [13] Lee, C.-H., Zhang, W., Liao, J., Carruthers, C. A., Sacks, J. I., and Sacks, M. S., 2015, “On the Presence of Affine Fibril and Fiber Kinematics in the Mitral Valve Anterior Leaflet,” *Biophysical Journal*, **108**(8), pp. 2074–2087.
- [14] Picu, R. C., Degekar, S., and Islam, M. R., 2018, “Poisson’s Contraction and Fiber Kinematics in Tissue: Insight from Collagen Network Simulations,” *Journal of Biomechanical Engineering*, **140**(2), 021002.
- [15] Kakaletsis, S., Lejeune, E., and Rausch, M., “The Mechanics of Embedded Fiber Networks,” **181**, p. 105456.
- [16] Dey, M. K., Merson, J., and Picu, R. C., “Evaluation of the Parallel Coupling Constitutive Model for Biomaterials Using a Fully Coupled Network-Matrix Model,” **155**, p. 106583.
- [17] Thakolkaran, P., Joshi, A., Zheng, Y., Flaschel, M., De Lorenzis, L., and Kumar, S., 2022, “NN-EUCLID: Deep-Learning Hyperelasticity without Stress Data,” *Journal of the Mechanics and Physics of Solids*, **169**, p. 105076.
- [18] Sacks, M. S., Motiwale, S., Goodbrake, C., and Zhang, W., “Neural Network Approaches for Soft Biological Tissue and Organ Simulations,” *Journal of Biomechanical Engineering*, **144**(121010).
- [19] Kakaletsis, S., Lejeune, E., and Rausch, M. K., “Can Machine Learning Accelerate Soft Material Parameter Identification from Complex Mechanical Test Data?” *Biomechanics and Modeling in Mechanobiology*, **22**(1), pp. 57–70.
- [20] Gupta, A., Bhaduri, A., and Graham-Brady, L., 2023, “Accelerated Multiscale Mechanics Modeling in a Deep Learning Framework,” *Mechanics of Materials*, **184**, p. 104709.
- [21] Peng, G. C. Y., Alber, M., Buganza Tepole, A., Cannon, W. R., De, S., Dura-Bernal, S., Garikipati, K., Karniadakis, G., Lytton, W. W., Perdikaris, P., Petzold, L., and Kuhl, E., “Multiscale Modeling Meets Machine Learning: What Can We Learn?” *Archives of Computational Methods in Engineering*, **28**(3), pp. 1017–1037.
- [22] Leng, Y., Tac, V., Calve, S., and Tepole, A. B., “Predicting the Mechanical Properties of Biopolymer Gels Using Neural Networks Trained on Discrete Fiber Network Data,” **387**, p. 114160.
- [23] Amos, B., Xu, L., and Kolter, J. Z., 2017, “Input Convex Neural Networks,” **1609.07152**
- [24] Luscher, D., McDowell, D., and Bronkhorst, C., “Essential Features of Fine Scale Boundary Conditions for Second Gradient Multiscale Homogenization of Statistical Volume Elements,” **10**, pp. 461–486.
- [25] Walters, D. J., Luscher, D. J., and Yeager, J. D., “Considering Computational Speed vs. Accuracy: Choosing Appropriate Mesoscale RVE Boundary Conditions,” **374**, p. 113572.
- [26] Glüge, R., 2013, “Generalized Boundary Conditions on Representative Volume Elements and Their Use in Determining the Effective Material Properties,” *Computational Materials Science*, **79**, pp. 408–416.
- [27] Kouznetsova, V., Brekelmans, W. A. M., and Baaijens, F. P. T., 2001, “An Approach to Micro-Macro Modeling of Heterogeneous Materials,” *Computational Mechanics*, **27**(1), pp. 37–48.
- [28] Islam, M. R., Tudryn, G., Bucinell, R., Schadler, L., and Picu, R. C., “Stochastic Continuum Model for Mycelium-Based Bio-Foam,” **160**, pp. 549–556.
- [29] Degekar, S. and Picu, R. C., “On the Strength of Random Fiber Networks,” **116**, pp. 1–16.
- [30] Parvez, N., Merson, J., and Picu, R. C., 2023, “Stiffening Mechanisms in Stochastic Athermal Fiber Networks,” *Physical Review E*, **108**(4), p. 044502.
- [31] Picu, R. and Jin, S., 2023, “Toughness of Network Materials: Structural Parameters Controlling Damage Accumulation,” *Journal of the Mechanics and Physics of Solids*, **172**, p. 105176.
- [32] Song, D., Oberai, A. A., and Janmey, P. A., 2022, “Hyperelastic Continuum Models for Isotropic Athermal Fibrous Networks,” *Interface Focus*, **12**(6), p. 20220043.
- [33] Tikenogullari, O. Z., Açan, A. K., Kuhl, E., and Dal, H., 2023, “Data-Driven Hyperelasticity, Part II: A Canonical Framework for Anisotropic Soft Biological Tissues,” *Journal of the Mechanics and Physics of Solids*, **181**, p. 105453.
- [34] Linden, L., Klein, D. K., Kalina, K. A., Brummund, J., Weeger, O., and Kästner, M., 2023, “Neural Networks Meet Hyperelasticity: A Guide to Enforcing Physics,” *Journal of the Mechanics and Physics of Solids*, **179**, p. 105363.
- [35] Tac, V., Sree, V. D., Rausch, M. K., and Tepole, A. B., 2021, “Data-Driven Modeling of the Mechanical Behavior of Anisotropic Soft Biological Tissue,” **2107.05388**
- [36] Linka, K. and Kuhl, E., 2023, “A New Family of Constitutive Artificial Neural Networks towards Automated Model Discovery,” *Computer Methods in Applied Mechanics and Engineering*, **403**, p. 115731.
- [37] Kingma, D. P. and Ba, J., 2017, “Adam: A Method for Stochastic Optimization,” doi: [10.48550/arXiv.1412.6980](https://doi.org/10.48550/arXiv.1412.6980), [1412.6980](https://doi.org/10.48550/arXiv.1412.6980)
- [38] He, K., Zhang, X., Ren, S., and Sun, J., 2015, “Delving Deep into Rectifiers: Surpassing Human-Level Performance on ImageNet Classification,” *Proceedings of the IEEE International Conference on Computer Vision*, pp. 1026–1034.
- [39] Czarnecki, W. M., Osindero, S., Jaderberg, M., Swirszcz, G., and Pascanu, R., “Sobolev Training for Neural Networks,” .
- [40] Paszke, A., Gross, S., Massa, F., Lerer, A., Bradbury, J., Chanan, G., Killeen, T., Lin, Z., Gimelshein, N., Antiga, L., Desmaison, A., Kopf, A., Yang, E., DeVito, Z., Raison, M., Tejani, A., Chilamkurthy, S., Steiner, B., Fang, L., Bai, J., and Chintala, S., 2019, “PyTorch: An Imperative Style, High-Performance Deep Learning Library,” *Advances in Neural Information Processing Systems*, Vol. 32, Curran Associates, Inc.
- [41] Islam, M. R. and Picu, R. C., 2018, “Effect of Network Architecture on the Mechanical Behavior of Random Fiber Networks,” *Journal of Applied Mechanics, Transactions ASME*, **85**(8), pp. 1–8.
- [42] Licup, A. J., Münster, S., Sharma, A., Sheinman, M., Jawerth, L. M., Fabry, B., Weitz, D. A., and MacKintosh, F. C., 2015, “Stress Controls the Mechanics of Collagen Networks,” *Proceedings of the National Academy of Sciences of the United States of America*, **112**(31), pp. 9573–9578.

**List of Figures**

1 (a) Schematic of a typical workflow of MuMFiM multiscale procedure that involves two finite element solution modules that handle the macro and microscale part of the problem, respectively. The deformation gradient, as informed by the macroscale module, is used to simulate RVEs to estimate the material response. For fibrous materials, the RVE is a discrete fiber network model (e.g., 3D Delaunay network shown in (b)). The machine learning model presented in this study is intended to be an accurate model of the RVE and aims to replace the ‘microscale’ module in panel (a). . . . . 3

2 Schematic of the input convex neural network we implement. The input vector consists of invariants of the right Cauchy-Green deformation tensor ( $\mathbf{C}$ ), and the output is the predicted strain energy density ( $\mathcal{W}$ ). The components of true stress ( $\sigma$ ), and stiffness tensor ( $\mathbb{D}$ ), are computed using automatic differentiation of the trained model. . . . . 5

3 Mean squared error (loss) of ICNN during training. The average errors associated with strain energy density, stress, and stiffness tensors are shown in the first, second, and third columns, respectively. The top row shows the loss for the training dataset, and the bottom row represents the corresponding results for the test dataset. The legend  $\mathcal{L}^k := \sum_{i=0}^{i=k} H_i$  indicates the variant of the loss function used to train ICNN, with  $k$  being the highest order of derivative included in the composite loss function. . . . . 5

4 True (MuMFiM) vs ICNN-predicted strain energy density for various deformation gradients ( $F$ ) in test dataset using ICNN trained with  $\mathcal{L}^2$  loss function. The dashed red line indicates the ideal fit, and scatters indicate predictions. The value of normalized mean squared error is 0.15% for this dataset. . . . . 6

5 True (MuMFiM) vs ICNN-predicted values for unique components of Cauchy stress tensor for various deformation gradients ( $F$ ) in test dataset. The component averaged value of normalized MSE is 0.815%. The result is based on ICNN trained with the  $\mathcal{L}^2$  loss function. . . . . 7

6 True (MuMFiM) vs ICNN-predicted values of the unique components of stiffness tensor for various deformation gradients ( $F$ ) in test dataset using ICNN trained with  $\mathcal{L}^2$  loss function. The average normalized MSE score is 5.4% (maximum: 23%, minimum: 0.03%). . . . . 8

7 (a) Geometry and boundary conditions for numerical simulation of facet capsule ligament (FCL) under uniaxial tension along the x-axis. (b) Deformed configuration at 70% strain based on large scale MuMFiM/FE<sup>2</sup> simulation. (c) Deformed configuration at same strain using standard finite element method with trained ICNN ( $\mathcal{L}^2$  variant) as the constitutive descriptor, and (d) with calibrated neo-Hookean material model. The color indicates the true stress in the elements along the loading direction. . . . . 9

8 True stress as a function of Green-Lagrange strain in the loading direction based on MuMFiM neo-Hookean, and ICNN-based simulations of FCL under uniaxial tension. The relative error of ICNN-based prediction with respect to MuMFiM output is shown as inset. . . . . 9

**List of Tables**