

Offshoring Emissions through Used Vehicle Exports

Saul Justin Newman^{1, 2}, Kayla Schulte³, Micol Matilde Morellini^{1, 4, 5},
Charles Rahal^{1, 4}, and Douglas R. Leasure^{1, 4}

¹ Leverhulme Centre for Demographic Science, University of Oxford

² University College, University of Oxford

³ Imperial College London

⁴ Nuffield College, University of Oxford

⁵ Department of Sociology, University of Oxford

February 22, 2024

Please cite this article as:

Newman, S.J., Schulte, K., Morellini, M.M., Rahal, C., and Leasure, D., ‘Offshoring emissions through used vehicle exports’. *Nat. Clim. Chang.* (2024).

<https://doi.org/10.1038/s41558-024-01943-1>

Abstract

Policies to reduce transport emissions often overlook the international flow of used vehicles. We quantify the rate at which used vehicles generated CO₂ and pollution for all used vehicles exported from Great Britain – a globally leading used-vehicle exporter – across 2005-2021. Destined for low-middle income countries, exported vehicles fail roadworthiness standards and, even under extremely optimistic ‘functioning-as-new’ assumptions, generate at least 13-53% more emissions than scrapped or on-road vehicles.

Keywords: *Big Data, Machine Learning, Climate Change*

Correspondence: All correspondence and requests for material should be directed to Dr Saul Newman, the corresponding author, at saul.newman@demography.ox.ac.uk. **Acknowledgements:** We would like to thank Professor Sarah Sharples for her support as chief scientific officer at the Department for Transport, climate change engineer Dr Rabee Jibrin for his wonderful feedback, Mr Grant Thunder for his excellent help and advice, and the Driver and Vehicle Standards Agency and the Department for Transport for their substantial help and support, without which this project would not be possible. **Project Ethics:** This project was approved by the University of Oxford’s Departmental Research Ethics Committee (Sociology) under ethics approval SOC_R2.001.C1A.21.66. A compliance assessment was undertaken by Oxford Population Health. **Replication Materials:** Imputation models and code are freely available under a creative commons CC-BY-NC 4.0 licence from a [figshare repository](#) or on request from the corresponding author. **Funding:** The authors are grateful for support from the Leverhulme Trust (Grant RC-2018-003) for the Leverhulme Centre for Demographic Science, and Nuffield College.

Main Article

Transport is the largest emitting sector of greenhouse gases, accounting for a quarter to a third of all emissions in developed countries [1, 23] with serious consequences for both climate and health [2, 7, 15]. Air pollutants such as nitrogen oxides (NOx), which are effectively reduced when standards are enforced, cause millions of deaths each year [3, 7]. These impacts fall unequally on lower-middle income countries (LMICs, [3]) which suffer more overall and per-capita pulmonary deaths from air pollution [7, 13, 15] and stand to suffer the greatest impacts from climate change [16]. The source of vehicles in LMICs is dominated by unregulated trade [1, 2, 5, 10, 23]. As of 2020, 100 countries receiving used vehicles had no vehicle emissions standards [5], and only eleven had ‘very good’ [5] regulations. However, the USA, EU, Japan, and UK collectively supply 90% of used vehicles exported to (non-EU) LMICs [5]. The potential for rapid regulation is therefore incumbent on just four jurisdictions, all of which already maintain high vehicle emission standards. Using comprehensive government databases, we quantify per-kilometre rates at which vehicles generate carbon and pollution for every vehicle (N=6,921,292) legally exported from Great Britain between January 2005 and December 2021. We compare these vehicle emissions to every private vehicle driven in Great Britain during the same period, and those that would have been driven if they had not been scrapped.

These data reveal substantially higher rates of CO₂ and pollution generation in exported vehicles, even under optimistic ‘functioning-as-new’ emissions intensity estimates that assume no vehicle modifications or vehicle degradation with age (Fig 1). Exported cars generate at least 23g (13%) more CO₂ per kilometre than cars scrapped in the same period (Fig 1a; [19]), and at least 29g (17%) more CO₂ per kilometre than the contemporary on-road used car fleet (Fig 1a; mean 197.0, 174.4, and 168.6g/km CO₂ for exported, scrapped, and on-road fleets respectively; interquartile ranges IQR 170.1-225.3, 147.5-189.1, and 134.2-188.9g/km). Emissions figures were even more striking for other pollutants. Exported cars emit similar amounts of hydrocarbon particulates (Fig 1b) but 48mg/km more NOx (53% higher; Fig 1c) than scrapped cars. Likewise, observed engine capacities were larger (Fig 1d) and fuel efficiency at least 9% worse, by 3.3 miles per gallon (MPG, mean 38.5, 41.8 and 44.4mpg for exported, scrapped and on-road used fleets respectively; IQR 33-45mpg exported, 37-47mpg scrapped, and 37-49mpg on-road fleets). A substantial fraction (42%) of exported diesel vehicles were predicted to fail the current EURO-4 emissions standards [12] that form the legal roadworthy minimum for all vehicles registered after 2000. A surprising 83% were predicted to fail the EURO-6 diesel [12] CO₂ emissions standards, and 98% failed the EURO-6 carbon monoxide and NOx standards. These differences are not the result of over-dispersion, where a few high-emitting exports [12] dragged up the average: similar or even larger gaps in pollution rates were observed for the median pollution rates of exported, scrapped, and contemporary on-road used vehicles (Fig 1).

Daily-resolution data for six million exported cars reveals that the gap between exported, on-road, and scrapped fleets is consistent over time (Fig 2a), apart from a narrowing and then rapid expansion of this gap over 2020-2021 alongside distortions of trade patterns, used car prices, and vehicle testing regulations during the COVID-19 pandemic (Fig 2b). That is, Great Britain persistently scraps lower-emissions vehicles while exporting higher-emission vehicles (Fig 2b). While geographical disparities due to uneven concentrations of upmarket export vehicles or differing ‘on-road’ usage were anticipated, this export gap was remarkably uniform. Almost every British postcode region (95%),

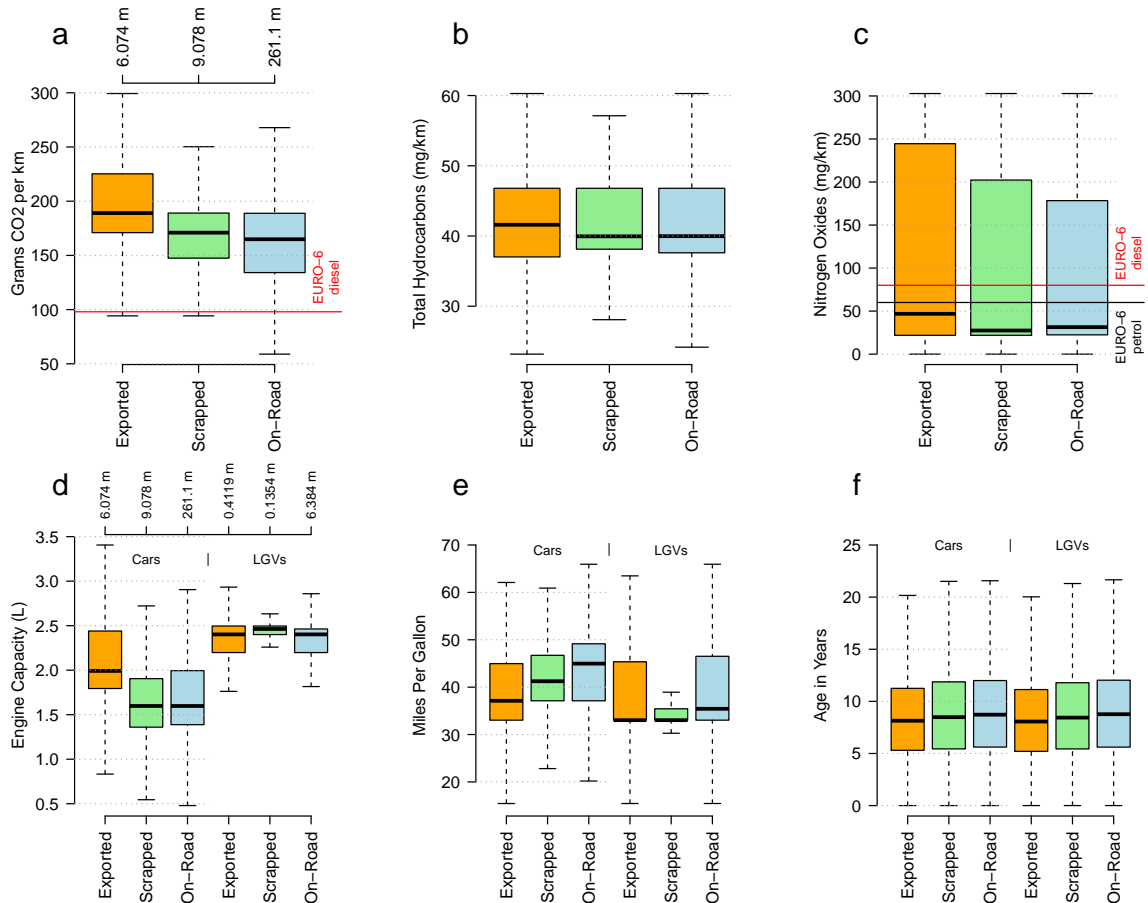

Figure 1: Pollution generated per kilometre by used vehicle fleets. Exported cars (orange) generate at least 13-24% more CO₂ per kilometre (a), similar average but (through overdispersion) higher median fine particulate matter pollution (b), and (c) at least 53% more nitrogen oxides per kilometre than scrapped (green) or on-road (blue) vehicle fleets. Both exported car and LGVs fleets also have larger observed engine capacities (d) and worse fuel efficiency (e) despite being similar ages to on-road fleets and much younger than contemporary scrapped vehicles (f). Boxes show interquartile range (IQR), whiskers are 1.5x IQR, sample size (millions) on supplementary x-axes.

representing a full cross-section of society, export higher-polluting vehicles than those they drive or scrap (Fig 2c). Exported vehicles will likely generate more pollution per kilometre independent of their destinations and patterns of use, for simple physical reasons: compared to their more-efficient scrapped alternatives, export vehicles have larger observed engine capacities (Fig 1d) and lower operating efficiencies (Fig 1e), despite a younger average age (Fig 1f). These fixed factors also mean that degradation rates are likely rank-conserved, especially for CO₂, and high-polluting vehicles will remain the most polluting as vehicle fleets age.

Air quality outcomes are more nuanced than individual emission categories, including how vehicles are driven, road conditions, engine age, climate, payload, and maintenance schedules [6, 14]. Vehicles also generate pollution, such as ozone or non-tailpipe emissions, for which testing data was not available. Observational data are urgently needed to fill this gap. Adding to the challenges of measuring emissions, emissions testing data have long been manipulated. For example; ‘Dieselgate’ involved nine major manufacturers using

‘defeat devices’ to alter performance and intentionally deceive environmental agencies and regulators. In the Dieselgate aftermath, vehicle manufacturers are, incredibly, allowed to legally manipulate vehicles during new-car emissions testing [14, 18] by, for example, removing wing mirrors and seats, taping up high-drag surfaces, or hard-baking and over-inflating tyres. Manufacturers are also now allowed to ‘adjust’ emissions estimates [18] by 4.5% and program vehicles to turn off emission-reduction devices [8] when the weather becomes ‘too hot’ or ‘cold’ [8]. Manufacturers define ‘hot’ and ‘cold’. For example, Renault told the French government their emissions control devices should shut off above 35°C and below 17°C (Paris is colder 83% of the time [18]) to ‘protect the engine’ [18], at the cost of protecting the climate and human health. As a result, real-world emissions increasingly overshoot (currently by 50%) emissions measured during testing [4, 14, 22]. Some 13% of diesel cars in the EU now emit NOx at over ten times the legal standard [4], outnumbering the 10% that actually meet those standards.

The lack of emissions standards in most destination countries also results in the routine stripping of emission-reduction devices for resale [11] or melting down before export [5, 11]. One study tested 160 vehicles destined for Africa from the EU [11]. Of the vehicles that could start, 85-93% failed to meet the (roadworthy-minimum) EURO-4 emissions standards, 20% of petrol (gasoline) vehicles did not comply with any emission standard at all [11], and 10% had their catalytic converters cut out [11] increasing NOx and carbon monoxide pollution 10-fold. Used vehicles were exported at an average 8.5 years of age (IQR 5.0-10.6 years) and both emissions [6] and fuel efficiency [14] degrade with age. Our models, therefore, likely underestimate vehicle pollution rates substantially, by relying on new car testing data that does not account for increasing emissions generation from vehicle aging or modifications. The nonstationarity and complexity of emissions degradation curves [6, 14] and vehicle modifications mean that direct measurements – like those increasingly captured by annual vehicle emissions tests required in the UK – are needed to improve estimates of exported emissions. Actual emissions are likely far higher [4, 6, 14], perhaps 150% higher for CO₂ under ideal ‘European-style’ driving conditions [4], but enormous and unnecessary gaps in our knowledge remain.

As with carbon leakage from heavy industry and manufacturing [3], rich countries appear to be offshoring the cost of replacing high-polluting vehicles. There are, however, some positive trends. While many improved emissions are artefacts of manipulated testing [8, 20, 22], better fuel efficiency and air quality standards in the USA, UK, EU, and Japan are slowly reducing the estimated pollution of exported vehicles over time (see Fig 2a-b for Great Britain). These four jurisdictions are the collective source of over 95% of light used vehicle exports worldwide and, despite creating 40% of global transport emissions [9], implement world-leading vehicle emissions standards inside their own borders. Imparting the same standards on exported vehicles, preventing the removal of emission-reduction devices, and redirecting clean vehicles from the scrapyards to the export fleet would all positively impact global emissions. Export licences can be indexed to increase duties on dirty vehicles or subsidise clean vehicle exports. Export countries have very few major vehicle ports [1] and thousands of mechanics qualified to evaluate legal roadworthy standards. Tasking mechanics to randomly spot-check vehicles in port, and issue penalties when vehicles fail emissions tests, would be an extremely low-cost intervention to stem the dirty used vehicle trade. Such measures would not necessitate increased vehicle prices, which can reduce access to the economic benefits of vehicle ownership. Supply shocks can be mitigated or avoided by using policy and incentives, and by redirecting clean vehicles from scrapyards to export. Cleaner vehicles also have smaller and more fuel-efficient

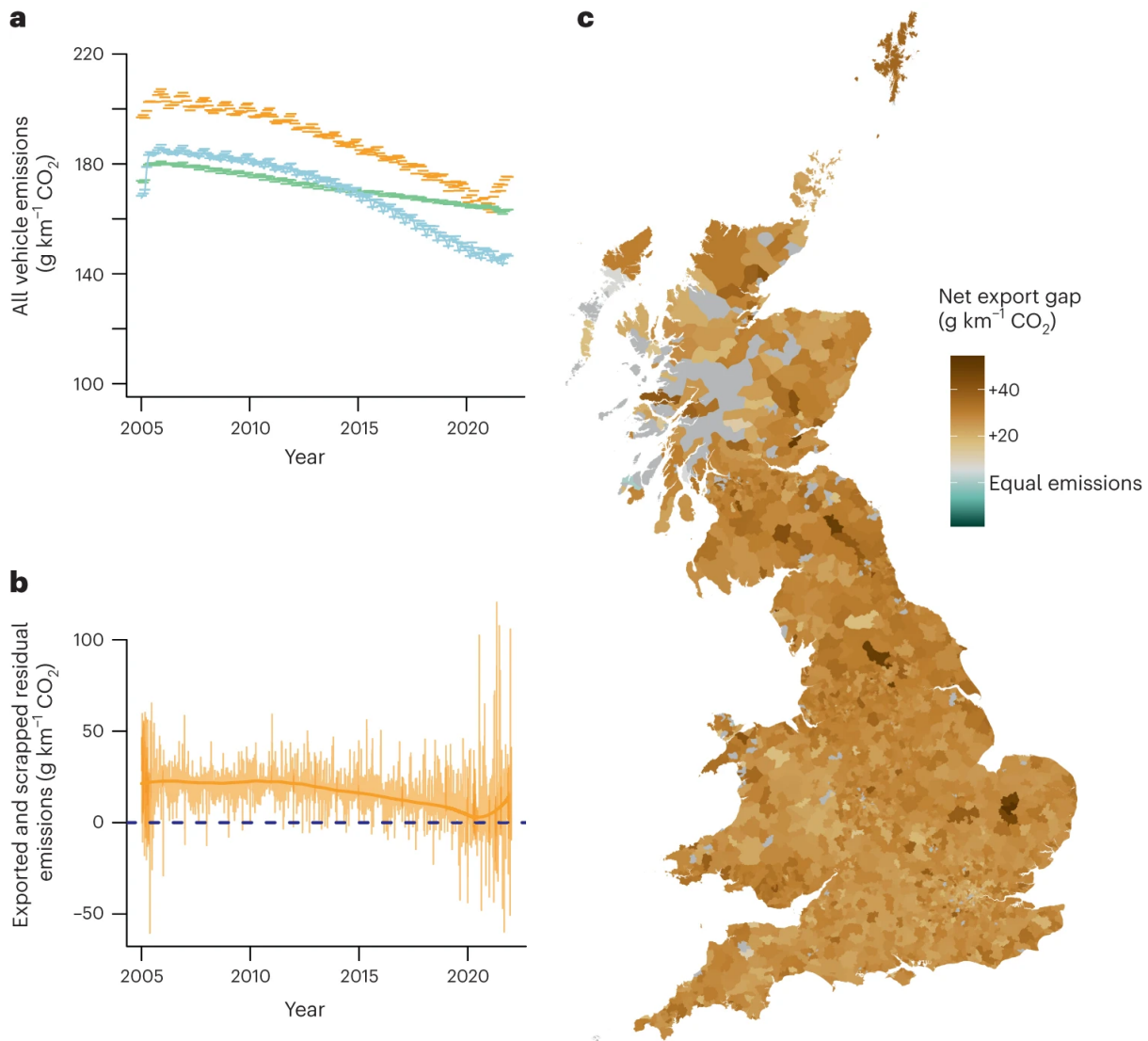

Figure 2: Export of consistently higher-emitting vehicles from Great Britain. Exported vehicles (orange) are consistently more polluting (a) than contemporary scrapped (green) and used on-road (blue) vehicles. Cleaner choices and improving standards have lowered exported emissions, after considerable delay, but the gap between exported and scrapped fleets persists (b) and is growing post-pandemic. Scrapped vehicles are cleaner than exports across 5,874 (95%) of our 6,145 observed postcode regions (2005-2021 inclusive) covering every community in Britain (c). Grey regions have insufficient data or no inspection sites. Orange line (b) shows locally weighted smoothed spline; note non-zero y-axis (a) to emphasise variation.

engines on average, and lower ongoing costs [17] over the life of the vehicle, reducing net economic burdens. Potential short-term price increases imposed on individuals are also offset by long-term reduction in the societal and economic costs from pollution [7, 15, 23] and climate change [1, 2, 16]. Most LMICs are placing this consideration above others, with widespread moves to ban the import of dirty used vehicles, regardless of price shocks [5, 17]. These policies reflect a growing desire for clean air over cheap cars. However, such moves are struggling for traction due to a lack of policing and resources, and the unstemmed flow of unregulated imports [17].

Developed economies can aid these goals and reduce the damage from vehicular emis-

sions by raising export standards to match their own internal legal minimum standards. Such low-cost interventions are an immense opportunity for rich high-emitting countries to reduce global emissions and cut pollution in the developing world. To instead overlook this problem, and allow the continued flow of high-emissions vehicles, would be a devastating missed opportunity and an ethical failure.

Online Methods

Data were obtained from the Department for Transportation – a department of the government of the United Kingdom – for all 65 million privately registered used vehicles undergoing mandatory annual vehicle inspections. Traditionally termed ‘MOT’ tests, they were undertaken across in the UK between 1 January 2005 and 31 December 2021. Used vehicles were defined as all vehicles that had undergone at least one prior inspection. These annual vehicle inspections are required by law in the UK to assess road worthiness. They begin one year after the vehicle is first registered for motorcycles and scooters, and three years after first registration for all other vehicles (in Northern Ireland, the equivalent requirement applies after four years). Alongside these data, we obtained linked vehicle-specific data on all used vehicles that had been scrapped or issued a certificate of destruction (N=9,077,804), and all vehicles that had been flagged as exported (N = 6,922,292). Both export and scrappage certifications are supplied with exact dates.

Used-vehicle summary statistics for predicted emissions, age, observed engine capacity, and all other vehicle properties were calculated at a daily resolution, from 1 January 2005 - 31 December 2021 inclusive, for a comprehensive sample of every on-road vehicle test (267.5 million tests; one random test per annum was selected for each vehicle), and for every scrapped (issued a vehicle scrappage certificate or certificate of destruction) or exported vehicle [19]. We restricted our ‘on-road’ data to one randomly sampled road-worthy test per vehicle per year to avoid the oversampling of mechanically unreliable vehicles, which are re-tested each time they fail a roadworthy certificate [19]. This resulted in predictions of emissions intensity across 261.1 million vehicle-days, or forty-two thousand vehicles per day, for cars (or class 4 vehicles) known to be on-road at the time of their roadworthy inspection.

All analyses were performed using R version 4.0.5 (see Supplementary Code). Some 993 vehicles (0.015%) that were erroneously flagged as both exported and scrapped or destroyed were removed from analysis. As the date of first use, and the date of each vehicle inspection, scrappage, destruction, or export were reported, we calculated vehicle ages at each of these events. Some 60,642 (0.4%) of the reported dates were ‘impossible’ and were excluded, as they were in potentially reverse order, or contained typographic errors. Another 7,380 vehicles over the age of 110 years (0.05%) were excluded from analysis as they largely – but not entirely – constituted age-related coding errors.

The vehicle inspection and scrappage data were matched to a public dataset of fuel efficiency and emissions data from the Vehicle Certification Agency, for seventy thousand measurements tabulated by vehicle make, model, fuel type, and year, measured across vehicles sold in the UK from 2000 onwards. Emissions data for carbon dioxide, carbon monoxide, nitrogen oxides, total hydrocarbon particulates and fuel efficiency of UK vehicles were also obtained from the Vehicle Certification Agency. Given the near-complete lack of emissions testing data for motorcycles and other vehicle classes, emissions testing data were only captured for cars and vans, and were curated, quality-controlled, and

matched to the Department for Transport data [19].

Matching these emissions testing data resulted in 1.3 million exactly matched CO₂ measurements for cars in the exported or scrapped fleet (8.4% of all exported cars and 8.1% of all scrapped cars) but only 3222 exact-matched CO₂ measurements for LGVs (0.3% of all LGVs), a number largely restricted by the abundance of rarer or untested models, and the difficulty in exact-matching heterogeneous make and model descriptions provided by the Vehicle Certification Agency. Exported vehicles with exact matches for measured emissions were lower (just 678 or 0.16% of all exported LGVs), excluding the reliable imputation of emissions from LGVs.

These data highlighted the extensive need for better, more comprehensive emissions testing for both new, on-road, and exported vehicles. The regulatory environment needs to be restructured to fill these gaps. However, while testing regimes and data were insufficient to impute on-road emissions in motorcycle or LGV fleets, accurate imputation of car emissions and pollution was possible under the assumption that new-car testing data would remain rank-conserved over time. This assumption generates a lowest-possible estimate of emissions rates, under the assumption that used vehicles are ‘functioning-as-new’ at the point of scrappage, export, or testing. This overly optimistic assumption is a key limitation of the study, one that highlights the need for far better measurement and testing of real-world emissions across all vehicle fleets.

Imputation models were constructed to capture the emissions of all exported (N = 6,072,730), scrapped (N = 9,077,804) or on-road (N = 261.1 million tests) class 4 vehicles (cars and vans below 3T) that passed quality controls. We used the reported model year, fuel type (e.g., ‘Petrol/Gasoline’, ‘Diesel-Electric’), and engine capacity (in cubic centimetres) from the annual vehicle inspection data to construct a model for each pollution type and vehicle property. Pollution types and vehicle properties which were imputed include CO₂ (grams per km), total nitrous oxides (NO_x; mg per km), total particulate hydrocarbons (mg per km), carbon monoxide (mg per km), and fuel efficiency in ‘miles per gallon’ (MPG). Imputation models were kept deliberately simple, as we predict values across the broadest possible range of vehicles using variables that were reported at almost every vehicle inspection. This avoided over-fitting and, as rare vehicles share engines and emission technology with common makes and models, achieved accurate (see Supplementary Materials: Fig S1) imputation for a very large (>99%) fraction of cases.

We developed imputation models using recursively partitioned regression trees [21, 24], a foundational and interpretable machine learning heuristic suited to discrete effects and small variable sets (Fig S1). This was implemented using the ‘rpart’ package [21]. Models were trained on three input variables – engine size in cubic centimetres, the year of vehicle manufacture, and fuel type – using ten-fold random-sample cross-validation, with the ‘cp’ model complexity parameter set to 0.001, and a minimum of 100 vehicle make-models used for a parent node (i.e., the ‘minbucket’ parameter). A minimum of 25 vehicle make-models were used for a child or leaf nodes (the ‘minsplit’ parameter; see [19]).

These models achieved high accuracy, approaching the test-retest accuracy of the Vehicle Certification Agency testing regime (Fig S1). For example, consecutive tests of the same vehicle for CO₂ were correlated by $r=0.9$, while our recursively partitioned regression model attained an accuracy of $r=0.94$ when imputing CO₂ for a random hold-out sample (random 20% holdout sample; N = 6,708 unique vehicle makes and models; Fig S1a-b). We found that grid-searching to further optimise model fit was therefore unnecessary, as our initial model parameters generated models that approached the highest achievable accuracy. All resulting recursively partitioned regression models, code,

and imputation data are provided in the Supplementary Materials and in open, stable repositories [19].

References

- [1] International Energy Agency. *CO₂ Emissions from Fuel Combustion 2019*. 2019.
- [2] Susan C Anenberg, Joshua Miller, Ray Minjares, Li Du, Daven K Henze, Forrest Lacey, Christopher S Malley, Lisa Emberson, Vicente Franco, Zbigniew Klimont, et al. Impacts and mitigation of excess diesel-related no x emissions in 11 major vehicle markets. *Nature*, 545(7655):467–471, 2017.
- [3] Mustafa H Babiker. Climate change policy, market structure, and carbon leakage. *Journal of International Economics*, 65(2):421–445, 2005.
- [4] Chelsea Baldino, Uwe Tietge, Rachel Muncrief, Yoann Bernard, and Peter Mock. Road Tested: Comparative overview of real-world versus type-approval NO_x and CO₂ emissions from dielsel cars in Europe. *Communications*, 49(30):847129–102, 2017.
- [5] A Baskin, R de Jong, E Dumitrescu, J Akumu, VR Stannah, A Mwangi, and G Maina. Used vehicles and the environment: A global overview of used light duty vehicles: Flow, scale and regulation. 2020. <http://hdl.handle.net/20.500.11822:34175>.
- [6] Yoann Bernard, Tim Dallmann, Uwe Tietge, Huzeifa Badshah, and John German. Development and application of a united states real-world vehicle emissions database. In *TRUE Initiative*. 2020.
- [7] Aaron J Cohen, Michael Brauer, Richard Burnett, H Ross Anderson, Joseph Frostad, Kara Estep, Kalpana Balakrishnan, Bert Brunekreef, Lalit Dandona, Rakhi Dandona, et al. Estimates and 25-year trends of the global burden of disease attributable to ambient air pollution: an analysis of data from the global burden of diseases study 2015. *The Lancet*, 389(10082):1907–1918, 2017.
- [8] European Commission. Commission notice guidance on the identification of the presence of defeat devices with regards to emissions of light-duty vehicles approved with real driving emissions (rde), heavy-duty vehicles and on anti-tampering protection 2023/c. 2023.
- [9] Monica Crippa, Diego Guizzardi, Manjola Banja, Efisio Solazzo, Marilena Muntean, Edwin Schaaf, Federico Pagani, Fabio Monforti-Ferrario, JGJ Olivier, Roberta Quadrelli, et al. CO₂ Emissions of all World Countries. *JRC Science for Policy Report, European Commission, EUR*, 31182, 2022.
- [10] Lucas W Davis and Matthew E Kahn. International trade in used vehicles: The environmental consequences of nafta. *American Economic Journal: Economic Policy*, 2(4):58–82, 2010.
- [11] Human Environment and Transport Inspectorate. Used vehicles exported to Africa: A study on the quality of used export vehicles. 61:1–61, 2020.

- [12] EUR-Lex. Commission Regulation (EU) No 459/2012 of 29 May 2012 amending Regulation (EC) No 715/2007 of the European Parliament and of the Council and Commission Regulation (EC) No 692/2008 as regards emissions from light passenger and commercial vehicles (Euro 6) Text with EEA relevance. 142, 2012.
- [13] Richard Fuller, Philip J Landrigan, Kalpana Balakrishnan, Glynda Bathan, Stephan Bose-O’Reilly, Michael Brauer, Jack Caravanos, Tom Chiles, Aaron Cohen, Lilian Corra, et al. Pollution and health: a progress update. *The Lancet Planetary Health*, 6(6):e535–e547, 2022.
- [14] David L Greene, Jun Liu, Asad J Khattak, Behram Wali, Janet L Hopson, and Richard Goeltz. How does on-road fuel economy vary with vehicle cumulative mileage and daily use? *Transportation Research Part D: Transport and Environment*, 55:142–161, 2017.
- [15] Jos Lelieveld, John S Evans, Mohammed Fnais, Despina Giannadaki, and Andrea Pozzer. The contribution of outdoor air pollution sources to premature mortality on a global scale. *Nature*, 525(7569):367–371, 2015.
- [16] Ole Mertz, Kirsten Halsnæs, Jørgen E Olesen, and Kjeld Rasmussen. Adaptation to climate change in developing countries. *Environmental management*, 43:743–752, 2009.
- [17] Marco Miotti, Geoffrey J Supran, Ella J Kim, and Jessika E Trancik. Personal vehicles evaluated against climate change mitigation targets. *Environmental Science & Technology*, 50(20):10795–10804, 2016.
- [18] Rachel Muncrief and John German. Defeat devices under the us and eu passenger vehicle emissions testing regulations. 2016.
- [19] Saul Newman, Kyla Schulte, Micol Morellini, Charles Rahal, and Douglas Leasure. Replication Materials to Accompany ‘Offshoring Emissions through Used Vehicle Exports’. *figshare*, <https://doi.org/10.6084/m9.figshare.23702571>, 2024.
- [20] Mathias Reynaert and James M Sallee. Corrective policy and goodhart’s law: The case of carbon emissions from automobiles. Technical report, National Bureau of Economic Research, 2016.
- [21] Terry Therneau, Beth Atkinson, Brian Ripley, and Maintainer Brian Ripley. Package ‘rpart’. Available online: cran.ma.ic.ac.uk/web/packages/rpart/rpart.pdf, 2015.
- [22] Zacharof N. Mock P. Franco V. German J. Bandivadekar A. Ligterink N. Tietge, U. and U. Lambrecht. From Laboratory to Road: A 2015 update of official and ‘real-world’ fuel consumption and CO2 values for passenger cars in Europe. *International Council on Clean Transportation White Paper*, 2015.
- [23] TJ Wallington and P Wiesen. N2o emissions from global transportation. *Atmospheric Environment*, 94:258–263, 2014.
- [24] Achim Zeileis, Torsten Hothorn, and Kurt Hornik. Model-based recursive partitioning. *Journal of Computational and Graphical Statistics*, 17(2):492–514, 2008.

S1 Files within the figshare repository

Several supplementary files are available from the figshare repository cited in the main text:

1. This document which summarises the supporting material:
2. A file containing summary statistics for Figure 1, and both spatial and temporal aggregates of fleet emissions.

File names:

`'Figure_data_and_aggregates.xlsx'`

3. A file summarising the accuracy of the recursively partitioned decision trees:

File names:

`'accuracy_tables.csv'`

4. Four related .pdf files detailing the exact partitions of the aforementioned trees, and a zip file containing the actual models as R data serialisation files (.RDS files):

File names:

`'co2_decision_tree.pdf'`

`'co_decision_tree.pdf'`

`'mpg_decision_tree.pdf'`

`'nox_decision_tree.pdf'`

`'Models_shareable.zip'`

The figshare repository is available from:

[19] Saul Newman, Kyla Schulte, Micol Morellini, Charles Rahal, and Douglas Leasure. Replication Materials to Accompany ‘Offshoring Emissions through Used Vehicle Exports’. *figshare*, <https://doi.org/10.6084/m9.figshare.23702571>, 2024.

S2 Supplementary Figures

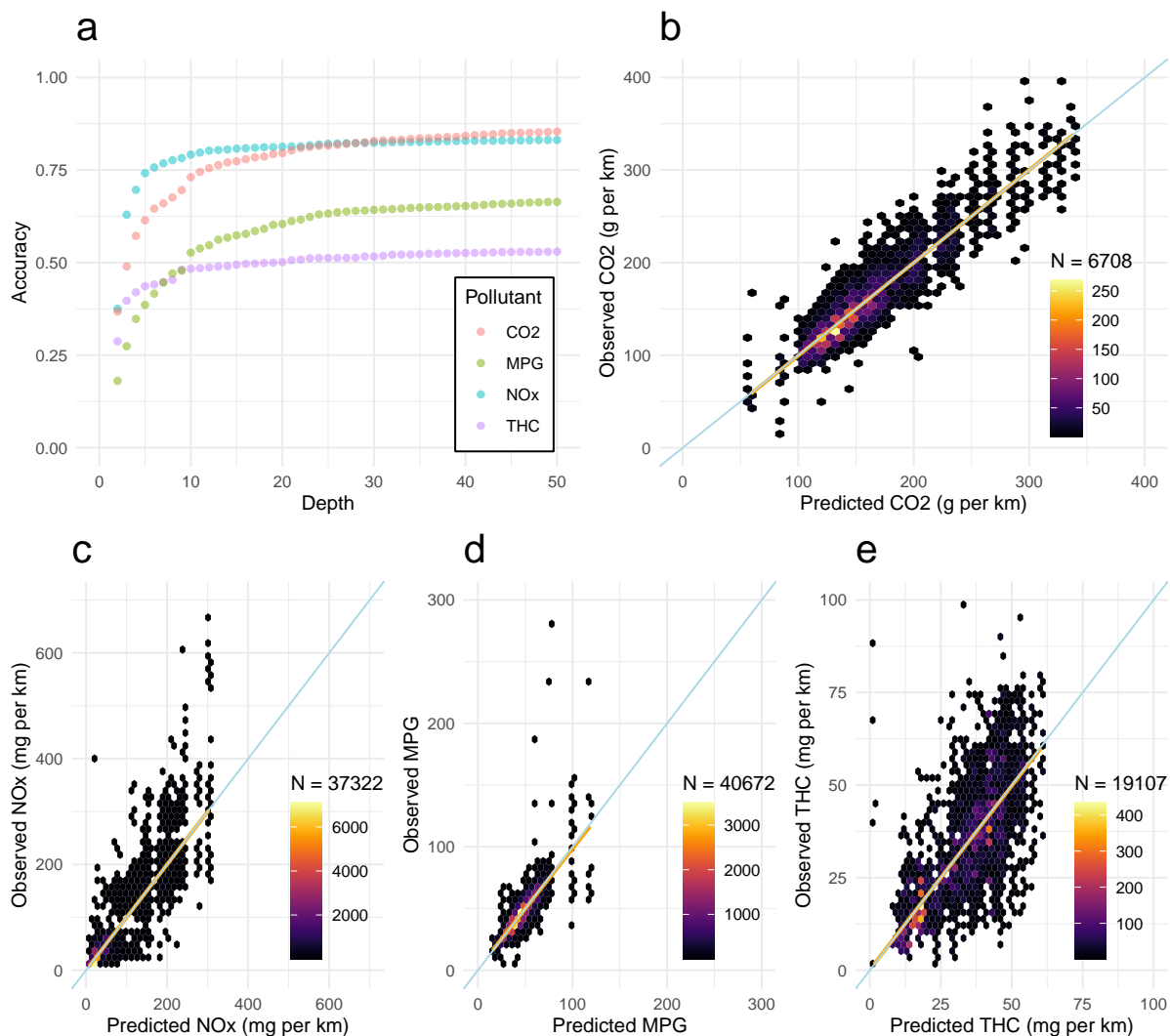

Figure S1: Imputation accuracy for randomly sampled emissions data. Emissions of non-electric vehicles were accurately imputed from recursively partitioned regression models (Supplementary Code). Predictions made on a masked random 20% sample of vehicle emissions tests ($N = 6,708$ holdout make – model – year – engine combinations) showed a high degree of accuracy under ten-fold cross-validation (a; R^2 on y-axis). Accuracy increased with tree depth to achieve moderate to high accuracy across CO₂ (b), nitrogen oxides (NO_x; c), and miles per gallon (MPG; d) prediction models, with the lowest cross-validation accuracy for total hydrocarbon emissions (THC; e). Model and manufacturer effects accounted for minimal variance, independent of these effects, and were not fit to allow imputation of rare makes and models. Filled circles in (a) are red for CO₂, green for MPG, blue for NO_x, and mauve for THC.

S3 Vehicle Testing Classes

Vehicles fell under different standardized MOT testing classes denoting their legal status, variously, as motorcycles or scooters up to (Class 1) and over (Class 2) an engine capacity of 200cc, three-wheeled vehicles up to 450kg (Class 3), cars (Class 4; by far the most common), private vehicles and ambulances with over 13 seats (Class 5), and light goods vehicles between 3000-3500kg (LGVs; Class 7). Class 4 contained miscellaneous classes of very low-frequency vehicle types, such as three-wheeled vehicles over 450kg and ambulances, and vans or goods vehicles below 3000kg tare weight.

S4 Acronyms

Acronyms for Variables, Column Headers, and Code:

- **NO_x** – Nitrogen Oxides.
- **MPG** – Fuel efficiency in Miles per Gallon.
- **CO₂** – Carbon dioxide.
- **THC** – Total hydrocarbons (particulate emissions).

- **CP** – Complexity Parameter.
- **nsplit** – Total number of splits in recursively partitioned tree.
- **rel error** – Relative error of the tree.
- **xerror** – Error rate of the tree under random-sample cross-validation.
- **xstd** – Standard error of the tree under random-sample cross-validation.

Variable names for decision trees:

- **ModelYea** – Model calendar year of the tested vehicle
- **EngineCa** - Observed engine capacity, in cubic centimetres
- **Fuel_typ** – The Department of Vehicles Standards Agency fuel type code, classified into:
 - **DIE** – Diesel
 - **PET** – Petrol / Gasoline
 - **CNG** – Compressed Natural Gas
 - **ELD** – Hybrid (Electric + Diesel)
 - **HYB** – Hybrid (Electric + Petrol/Gasoline)
 - **LPG** – Liquid Petroleum Gas

S5 Parameterising RPart Decision Trees

All analyses were performed using R version 4.0.5 (see Supplementary Code), and in particular, we used the ‘rpart’ library (version 4.1.19). We chose the same four key parameterisations for our models (in parentheses):

- **cp**: prune all nodes with a complexity less than cp (cp=1e-04).
- **minbucket**: the minimum number of observations in any terminal leaf node. If only one of minbucket or minsplit is specified, the code either sets minsplit to minbucket $\times 3$ or $\frac{\text{minsplit}}{3}$, as appropriate (minbucket=100).
- **minsplit**: the minimum number of observations that must exist in a node in order for a split to be attempted (minsplit=25).
- **xval**: number of cross-validations (xval=10).

S6 How to Read Decision Trees

Decision trees are machine-generated interpretable models and can be represented as branching flow-charts, like organisational flow charts, with a fixed structure. To read a decision tree, begin at the top node in the centre of the page. There will be a variable name and a simple decision; is the engine capacity ('CC') greater than 2194? Is the car a Diesel? Is the model year ('Year') of the car being tested greater or equal to 2010? If answering yes at any node, you always progress to the value on the left branch. On the other hand, answering 'no' will always take you to the right-hand node. After making each decision, the model or the user simply moves down to the next decision in the tree until they reach the bottom of the tree. From the numbers below each node, we can see how many vehicle tests these predictions are based on and the percentage of the initial vehicle tests that fall into this category. Consider the example below. If the Year is greater than or equal to 2019, we assign to that observation 24 miles per gallon. If it is less than 2019, the model then considers the engine capacity. If it's less than 3891, the car is assigned 25 miles per gallon. If it's more than or equal to 3891, it's assigned 30 miles per gallon.

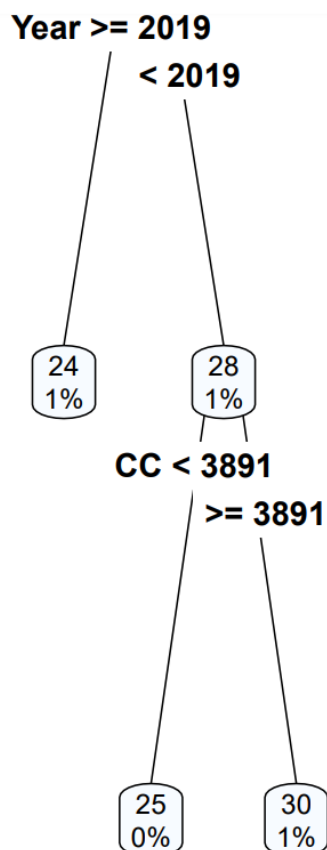

These models are presented here to aid users that are not familiar with the R programming language. For anyone who is familiar with R, we provide complete, estimated models in the repository associated with this work, as we are unfortunately unable to share the associated raw data.

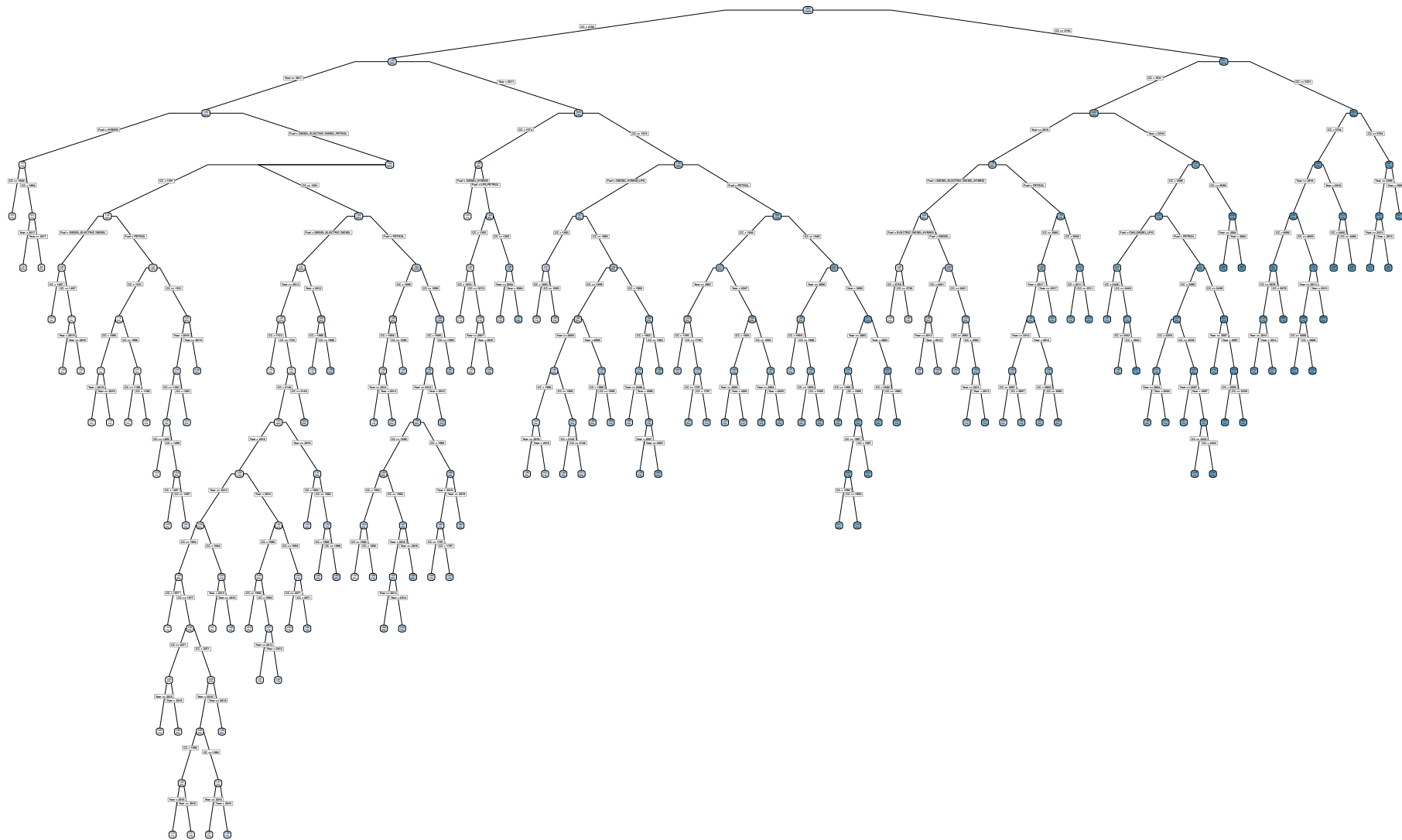

Figure S2: Recursively Partitioned Decision Tree: CO₂

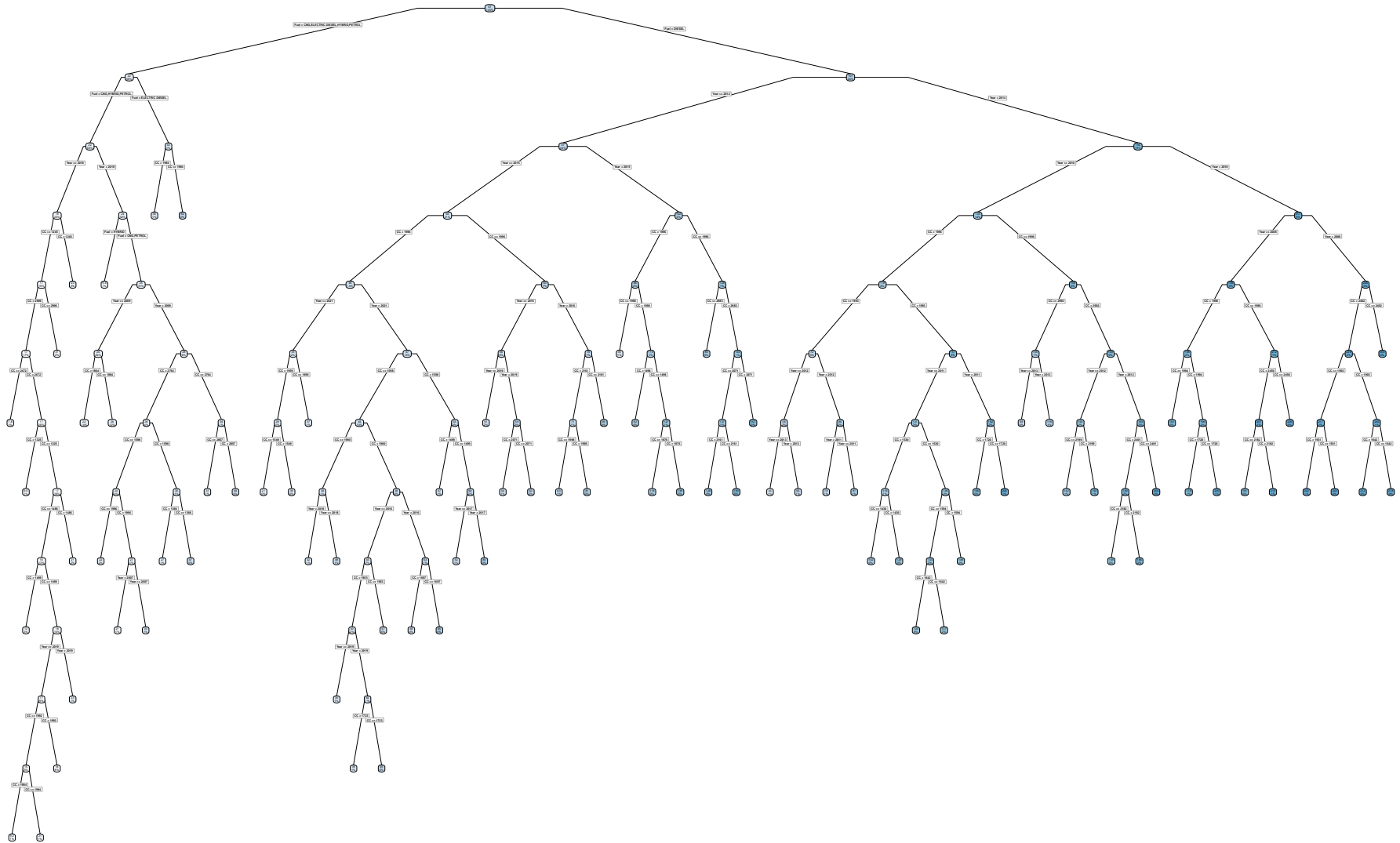

Figure S3: Recursively Partitioned Decision Tree: CO

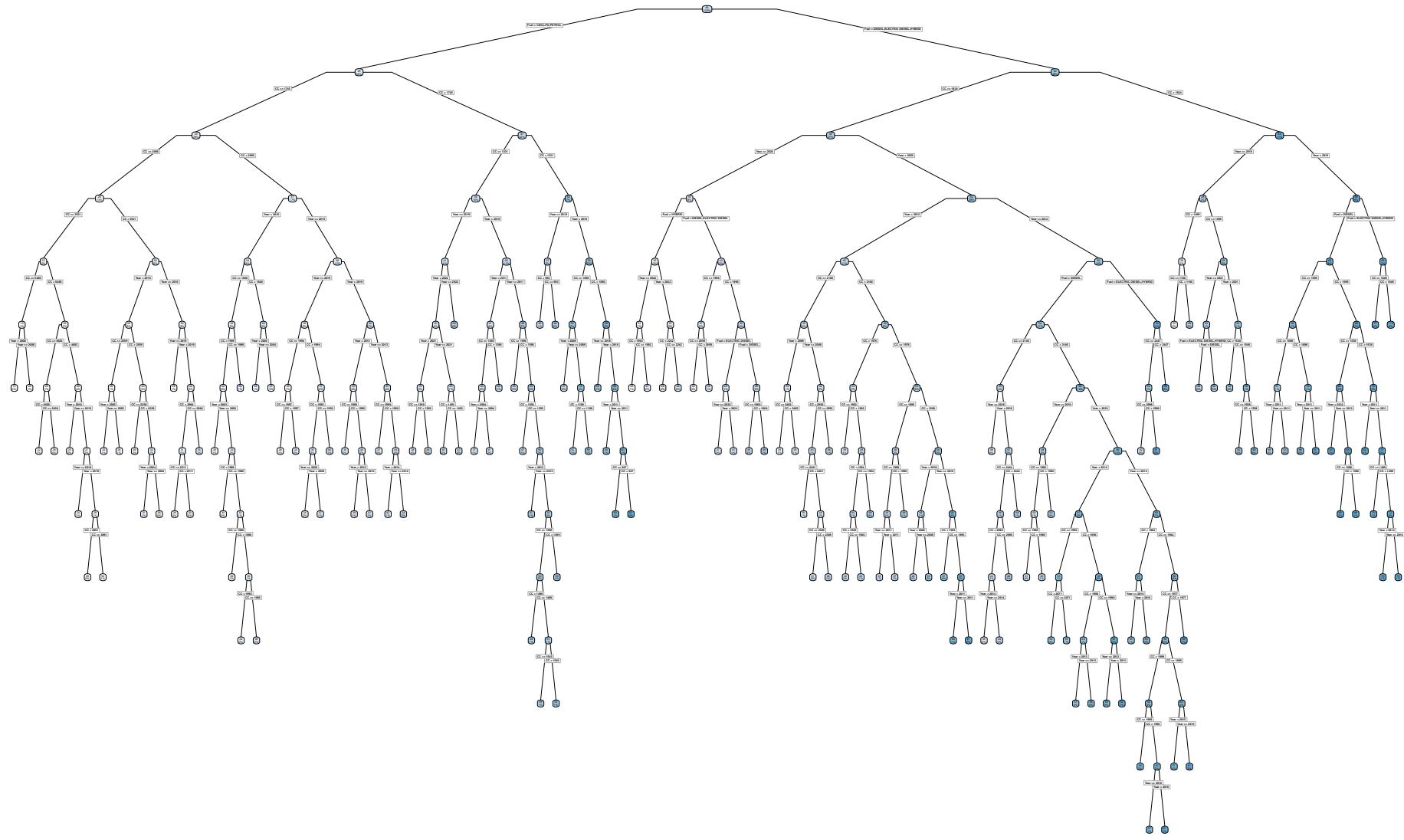

Figure S4: Recursively Partitioned Decision Tree: MPG

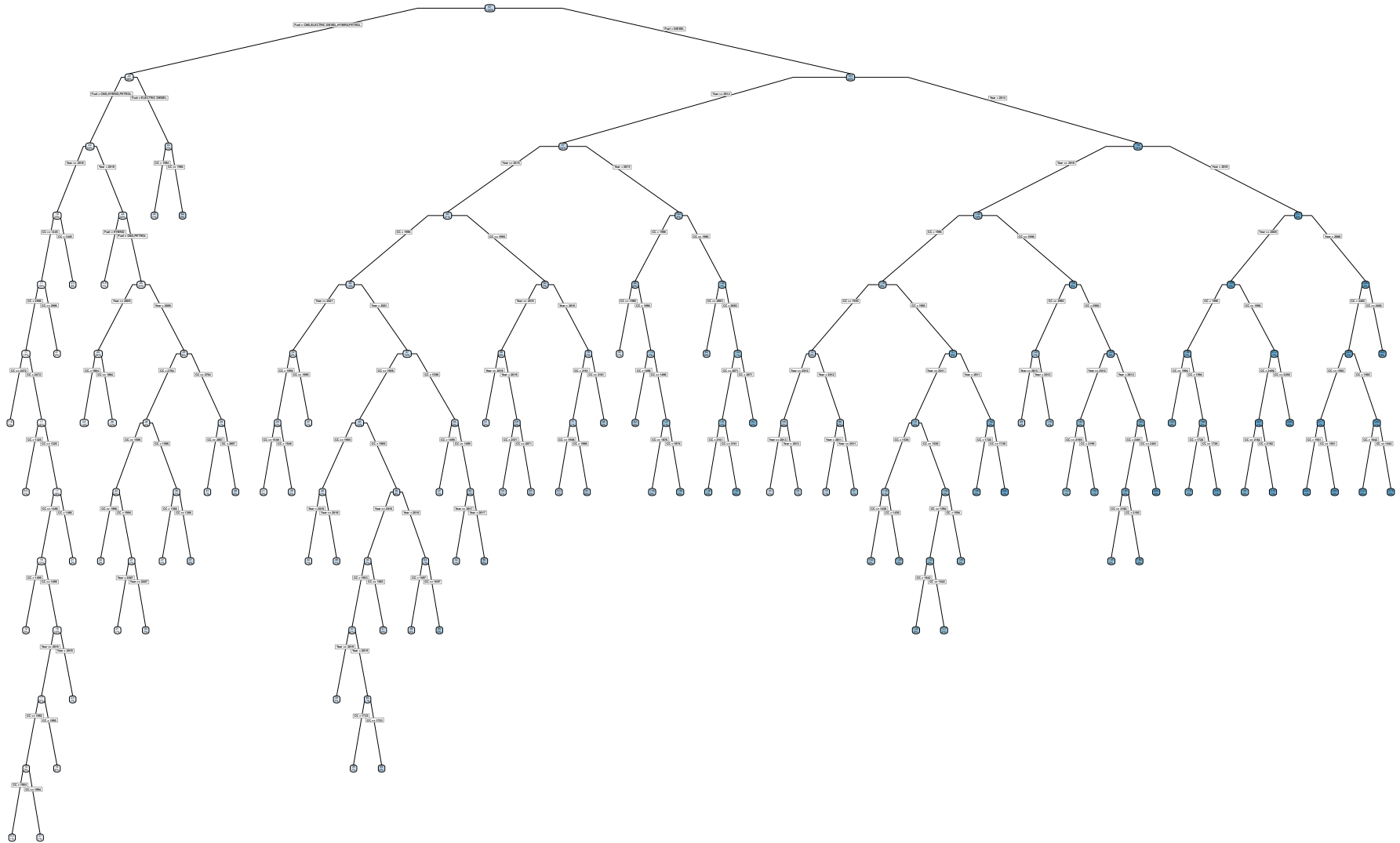

Figure S5: Recursively Partitioned Decision Tree: NOx