

---

# TYPE ISOMORPHISMS FOR MULTIPLICATIVE-ADDITIVE LINEAR LOGIC

RÉMI DI GUARDIA AND OLIVIER LAURENT

Univ Lyon, EnsL, UCBL, CNRS, LIP, F-69342, LYON Cedex 07, France  
*e-mail address:* remi.di-guardia@ens-lyon.fr, olivier.laurent@ens-lyon.fr

---

**ABSTRACT.** We characterize type isomorphisms in the multiplicative-additive fragment of linear logic (MALL), and thus in  $\star$ -autonomous categories with finite products, extending a result for the multiplicative fragment by Balat and Di Cosmo [BDC99]. This yields a much richer equational theory involving distributivity and cancellation laws. The unit-free case is obtained by relying on the proof-net syntax introduced by Hughes and Van Glabbeek [HvG05]. We use the sequent calculus to extend our results to full MALL, including all units, thanks to a study of cut-elimination and rule commutations.

## 1. INTRODUCTION

The question of type isomorphisms consists in trying to understand when two types in a type system, or two formulas in a logic, are “the same”. The general question can be described in category theory: two objects  $A$  and  $B$  are isomorphic ( $A \simeq B$ ) if there exist morphisms  $A \xrightarrow{f} B$  and  $B \xrightarrow{g} A$  such that  $f \circ g = \text{id}_B$  and  $g \circ f = \text{id}_A$ . The arrows  $f$  and  $g$  are the underlying isomorphisms. Given a (class of) category, the question is then to find equations characterizing when two objects  $A$  and  $B$  are isomorphic (in all instances of the class). The focus here is on pairs of isomorphic objects rather than on the isomorphisms themselves. For example, in the class of cartesian categories, one finds the following isomorphic objects:  $A \times B \simeq B \times A$ ,  $(A \times B) \times C \simeq A \times (B \times C)$  and  $A \times \top \simeq A$ . Regarding type systems and logics, one can instantiate the categorical notion. For instance in typed  $\lambda$ -calculi: two types  $A$  and  $B$  are isomorphic if there exist two  $\lambda$ -terms  $M : A \rightarrow B$  and  $N : B \rightarrow A$  such that  $\lambda x : B.(M (N x)) =_{\beta\eta} \lambda x : B.x$  and  $\lambda x : A.(N (M x)) =_{\beta\eta} \lambda x : A.x$  where  $=_{\beta\eta}$  is  $\beta\eta$ -equality. This corresponds to isomorphic objects in the syntactic category generated by terms up to  $=_{\beta\eta}$ . Similarly, type isomorphisms can also be considered in logic, following what happens in the  $\lambda$ -calculus through the Curry-Howard correspondence: simply replace  $\lambda$ -terms with proofs, types with formulas,  $\beta$ -reduction with cut-elimination and  $\eta$ -expansion with axiom-expansion. In this way, type isomorphisms are studied in a wide range of theories, such as category theory [Sol83],  $\lambda$ -calculus [DC95] and proof theory [BDC99]. They have

---

*Key words and phrases:* Linear Logic, Type Isomorphisms, Multiplicative-Additive fragment, Proof-nets, Sequent calculus, Star-autonomous categories with finite products.

\* The present paper is a revised and extended version of [DGL23], supplying all proofs and with a different organization.

been used to develop practical tools, such as search in a library of a functional programming language [Rit91, ARG21].

Following the definition, it is usually easy to prove that the type-isomorphism relation is a congruence. It is then natural to look for an equational theory generating this congruence. Testing whether or not two types are isomorphic is then much easier. An equational theory  $\mathcal{T}$  is called *sound* with respect to type isomorphisms if types equal up to  $\mathcal{T}$  are isomorphic. It is called *complete* if it equates any pair of isomorphic types. Given a (class of) category, a type system or a logic, our goal is to find an associated sound and complete equational theory for type isomorphisms. This is not always possible as the induced theory may not be finitely axiomatisable (see for instance [FDCB02]).

Soundness is usually the easy direction as it is sufficient to exhibit pairs of terms corresponding to each equation. The completeness part is often harder, and there are in the literature two main approaches to solve this problem. The first one is a semantic method, relying on the fact that if two types are isomorphic then they are isomorphic in all (denotational) models. One thus looks for a model in which isomorphisms can be computed (more easily than in the syntactic model) and are all included in the equational theory under consideration (this is the approach used in [Sol83, Lau05] for example). Finding such a model simple enough for its isomorphisms to be computed, but still complex enough not to contain isomorphisms absent in the syntax is the difficulty. The second method is the syntactic one, which consists in studying isomorphisms directly in the syntax. The analysis of pairs of terms composing to the identity should provide information on their structure and then on their type so as to deduce the completeness of the equational theory (see for example [DC95, BDC99]). The easier the equality ( $=_{\beta\eta}$  for example) between proof objects can be computed, the easier the analysis of isomorphisms will be.

We place ourselves in the framework of linear logic (LL) [Gir87], the underlying question being “is there an equational theory corresponding to the isomorphisms between formulas in this logic?”. LL is a very rich logic containing three classes of propositional connectives: multiplicative, additive and exponential ones. The multiplicative and additive families provide two copies of each classical propositional connective: two copies of conjunction ( $\otimes$  and  $\&$ ), of disjunction ( $\wp$  and  $\oplus$ ), of true (1 and  $\top$ ) and of false ( $\perp$  and 0). The exponential family is constituted of two modalities ! and ? bridging the gap between multiplicatives and additives through four isomorphisms  $!(A \& B) \simeq !A \otimes !B$ ,  $?(A \oplus B) \simeq ?A \wp ?B$ ,  $!\top \simeq 1$  and  $?0 \simeq \perp$ . In the multiplicative fragment (MLL) of LL (using only  $\otimes$ ,  $\wp$ , 1 and  $\perp$ , and corresponding to  $\star$ -autonomous categories), the question of type isomorphisms was answered positively using a syntactic method based on proof-nets by Balat and Di Cosmo [BDC99]: isomorphisms emerge from associativity and commutativity of the multiplicative connectives  $\otimes$  and  $\wp$ , as well as unitality of the multiplicative units 1 and  $\perp$ . The question was also solved for the polarized fragment of LL by one of the authors using game semantics [Lau05]. It is conjectured that isomorphisms in full LL correspond to those in its polarized fragment (Table 1 together with the four exponential equations above). As a step towards solving this conjecture, we prove the type isomorphisms in the multiplicative-additive fragment (MALL) of LL are generated by the equational theory of Table 1. This applies at the same time to the class of  $\star$ -autonomous categories with finite products (equational theory on Table 7).

This situation is much richer than in the multiplicative fragment since isomorphisms include not only associativity, commutativity and unitality, but also the distributivity of the multiplicative connective  $\otimes$  (resp.  $\wp$ ) over the additive  $\oplus$  (resp.  $\&$ ) as well as the associated cancellation laws for the additive unit 0 (resp.  $\top$ ) over the multiplicative connective  $\otimes$

$$\mathcal{L}^\dagger$$

Commutativity	Associativity	Distributivity	Unitality	Cancellation
$A \otimes B = B \otimes A$	$A \otimes (B \otimes C) = (A \otimes B) \otimes C$	$A \otimes (B \oplus C) = (A \otimes B) \oplus (A \otimes C)$	$A \otimes 1 = A$	$A \otimes 0 = 0$
$A \wp B = B \wp A$	$A \wp (B \wp C) = (A \wp B) \wp C$	$A \wp (B \& C) = (A \wp B) \& (A \wp C)$	$A \wp \perp = A$	$A \wp \top = \top$
$A \oplus B = B \oplus A$	$A \oplus (B \oplus C) = (A \oplus B) \oplus C$		$A \oplus 0 = A$	
$A \& B = B \& A$	$A \& (B \& C) = (A \& B) \& C$		$A \& \top = A$	

$$\mathcal{L}$$

Table 1: Type isomorphisms in multiplicative-additive linear logic

(resp.  $\wp$ ). Using a semantic approach looks difficult as most of the known models of MALL immediately come with unwanted isomorphisms not valid in the syntax: for example  $\top \otimes A \simeq \top$  in coherent spaces [Gir87]. For this reason we use a syntactic method. We follow the approach by Balat and Di Cosmo [BDC99] based on proof-nets [Gir96]. Indeed, proof-nets provide a very good syntax for linear logic where studying composition of proofs by cut, cut-elimination and identity of proofs is very natural, highly simplifying the problem. However, already in [BDC99] some trick had to be used to deal with units as proof-nets are working perfectly only in the unit-free multiplicative fragment of linear logic. If one puts units aside, there is a notion of proof-nets incorporating both multiplicative and additive connectives in such a way that cut-free proofs are represented in a *canonical* way, and cut-elimination can be dealt with in a parallel manner. This is the syntax of proof-nets introduced by Hughes & Van Glabbeek in [HvG05].

**Outline.** Once the necessary definitions given (Section 2), our proof of the completeness of the equational theory of Table 1 goes in two steps. First, we work in the sequent calculus to simplify the problem and reduce it to the unit-free fragment, by lack of a good-enough notion of proof-nets for MALL including units. This goes through a characterization of the equality of proofs up to axiom-expansion and cut-elimination by means of rule commutations (Sections 3 and 4). A result which is not surprising, but not proved before for MALL as far as we know, and rather tedious to settle. Using it, we analyze the behaviour of units inside isomorphisms to conclude that they can be replaced with fresh atoms, once formulas are simplified appropriately (Section 5). Secondly, being in a setting admitting proof-nets, we adapt the proof of Balat & Di Cosmo [BDC99] to the framework of Hughes & Van Glabbeek's proof-nets [HvG05]. We transpose the definition of isomorphisms to this new syntax (Sections 6 and 7), then prove completeness (Section 8). This last step requires a precise analysis of the structure of proof-nets because of the richer structure induced by the presence of the additive connectives. The situation is much more complex than in the multiplicative setting since for example sub-formulas can be duplicated through distributivity equations, breaking a linearity property crucial in [BDC99]. Finally, seeing MALL as a category, we extend our result to conclude that Table 1 (or more precisely its adaptation to the language of categories, Table 7 on page 47) provides the equational theory of isomorphisms valid in all  $\star$ -autonomous categories with finite products (Section 9). We discuss the situation of products in symmetric monoidal closed categories as well.

We are quite exhaustive on notions in sequent calculus. An informed reader could skip these basic definitions and results, and start reading directly from Section 5 on page 17.

## 2. DEFINITIONS

In this section are first defined formulas and proofs of multiplicative-additive linear logic (Section 2.1). Then are introduced the standard operations on these sequent calculus proofs: axiom-expansion, cut-elimination and rule commutations (Section 2.2). This finally leads to the definition of type isomorphisms for this logic (Section 2.3).

**2.1. Multiplicative-Additive Linear Logic.** The multiplicative-additive fragment of linear logic [Gir87], denoted by MALL, has formulas given by the following grammar, where  $X$  belongs to a given enumerable set of *atoms*:

$$A, B := X \mid X^\perp \mid A \otimes B \mid A \wp B \mid 1 \mid \perp \mid A \& B \mid A \oplus B \mid \top \mid 0$$

Orthogonality  $(\cdot)^\perp$  expands into an involution on arbitrary formulas through  $X^{\perp\perp} = X$ ,  $1^\perp = \perp$ ,  $\perp^\perp = 1$ ,  $\top^\perp = 0$ ,  $0^\perp = \top$  and De Morgan's laws  $(A \otimes B)^\perp = B^\perp \wp A^\perp$ ,  $(A \wp B)^\perp = B^\perp \otimes A^\perp$ ,  $(A \& B)^\perp = B^\perp \oplus A^\perp$ ,  $(A \oplus B)^\perp = B^\perp \& A^\perp$ . These *non-commutative* De Morgan's laws are the good notion of duality, as shown in the context of cyclic linear logic where this leads to planar proof-nets [AM98]. This choice in our setting will often result in planar graphs on our illustrations, with axiom links not crossing each others.

The *size*  $s(A)$  of a formula  $A$  is its number of (binary) connectives  $\otimes$ ,  $\wp$ ,  $\&$  and  $\oplus$ . Equivalently, it is its number of atoms, negated atoms and units  $1$ ,  $\perp$ ,  $\top$  and  $0$ , minus one.

Sequents are lists of formulas of the form  $\vdash A_1, \dots, A_n$ . Sequent calculus rules are, with  $A$  and  $B$  arbitrary formulas,  $\Gamma$  and  $\Delta$  contexts (*i.e.* lists of formulas) and  $\sigma$  a permutation:

$$\begin{array}{c} \frac{}{\vdash A^\perp, A} \text{ax} \quad \frac{\vdash \Gamma}{\vdash \sigma(\Gamma)} \text{ex} \quad \frac{\vdash A, \Gamma \quad \vdash A^\perp, \Delta}{\vdash \Gamma, \Delta} \text{cut} \\ \frac{\vdash A, \Gamma \quad \vdash B, \Delta}{\vdash A \otimes B, \Gamma, \Delta} \otimes \quad \frac{\vdash A, B, \Gamma}{\vdash A \wp B, \Gamma} \wp \quad \frac{}{\vdash 1} 1 \quad \frac{\vdash \Gamma}{\vdash \perp, \Gamma} \perp \\ \frac{\vdash A, \Gamma \quad \vdash B, \Gamma}{\vdash A \& B, \Gamma} \& \quad \frac{\vdash A, \Gamma}{\vdash A \oplus B, \Gamma} \oplus_1 \quad \frac{\vdash B, \Gamma}{\vdash A \oplus B, \Gamma} \oplus_2 \quad \frac{}{\vdash \top, \Gamma} \top \end{array}$$

In practice, we consider exchange rules (*ex*) as incorporated in the conclusion of the rule above, thus dealing with rules like:  $\frac{\vdash A, B, \Gamma, \Delta}{\vdash \Gamma, A \wp B, \Delta} \wp$ . In this spirit, by  $\frac{\vdash \Gamma, A, B, \Delta}{\vdash \Gamma, A \wp B, \Delta} \wp$  we mean that the appropriate permutation is also incorporated in the rule above. Equivalently, we only consider proofs with exactly one exchange rule below each non-exchange rule.

The main difference with the multiplicative fragment of linear logic (MLL) is the  $\&$ -rule, which introduces some sharing of the context  $\Gamma$ . From this comes the notion of a *slice* [Gir87, Gir96] which is a partial proof missing some additive component.

**Definition 2.1** (Slice). For  $\pi$  a proof, consider the (non-correct) proof tree obtained by deleting one of the two sub-trees of each  $\&$ -rule of  $\pi$  (thus, in the new proof tree,  $\&$ -rules are unary):

$$\frac{\vdash A, \Gamma}{\vdash A \& B, \Gamma} \&_1 \quad \frac{\vdash B, \Gamma}{\vdash A \& B, \Gamma} \&_2$$

The remaining rules form a *slice* of  $\pi$ . We denote by  $\mathcal{S}(\pi)$  the set of slices of  $\pi$ .

Slices satisfy a linearity property (validated by proofs of MLL as well): any connective in the conclusion is introduced by at most one rule in a slice.

By *unit-free* MALL, we mean the restriction of MALL to formulas not involving the units  $1$ ,  $\perp$ ,  $\top$  and  $0$ , and as such without the  $1$ ,  $\perp$  and  $\top$ -rules. When speaking of a *positive* formula, we mean a formula with main connective  $\otimes$  or  $\oplus$ , a unit  $1$  or  $0$ , or an atom  $X$ . A *negative* formula is one with main connective  $\wp$  or  $\&$ , a unit  $\perp$  or  $\top$ , or a negated atom  $X^\perp$ .

**2.2. Transformations of proofs.** There are two well-known rewriting relations on proofs, *axiom-expansion* and *cut-elimination*. These transformations correspond respectively to  $\eta$ -expansion and  $\beta$ -reduction in the  $\lambda$ -calculus, hence the notations in the following definitions.

**Definition 2.2.** We call *axiom-expansion* the rewriting system  $\xrightarrow{\eta}$  described on Table 2.

**Definition 2.3.** We call *cut-elimination* the rewriting system  $\xrightarrow{\beta}$  described on Tables 3 and 4 (up to permuting the two branches of any *cut*-rule).

**Remark 2.4.** Another possible  $\wp - \otimes$  key case for cut-elimination would be the following:

$$\frac{\frac{\frac{\pi_1}{\vdash A, \Gamma} \quad \frac{\pi_2}{\vdash B, \Delta}}{\vdash A \otimes B, \Gamma, \Delta} \otimes \quad \frac{\frac{\pi_3}{\vdash B^\perp, A^\perp, \Sigma}}{\vdash B^\perp \wp A^\perp, \Sigma} \wp}{\vdash \Gamma, \Delta, \Sigma} \text{cut} \quad \xrightarrow{\beta} \quad \frac{\frac{\pi_2}{\vdash B, \Delta} \quad \frac{\frac{\pi_1}{\vdash A, \Gamma} \quad \frac{\pi_3}{\vdash B^\perp, A^\perp, \Sigma}}{\vdash B^\perp, \Gamma, \Sigma} \text{cut}}{\vdash \Gamma, \Delta, \Sigma} \text{cut}$$

This case can be simulated with the given  $\wp - \otimes$  key case and a *cut* – *cut* commutative case.

Another relation on proofs is *rule commutation*, which is closely related to cut-elimination as we will see in Section 4. These commutations associate proofs which differ only by the order in which their rules are applied.

**Definition 2.5.** We call *rule commutation* the symmetric relation  $\vdash^r$  described on Tables 5 and 6. This corresponds to rule commutations in *cut-free* MALL, *i.e.* with no *cut*-rules above the commutation (there may be *cut*-rules below).<sup>1</sup> In particular, in a  $\top - \otimes$  commutation we assume the created or erased sub-proof to be cut-free, and in a  $\& - \otimes$  commutation the duplicated or superimposed sub-proof to be cut-free.

**Remark 2.6.** A more general theory of rule commutations exists, without the restriction on cut-free proofs and with commutations involving the *cut*-rule, the latter being the symmetric closure of the commutative cases of cut-elimination on Table 4. See [HvG16] for these commutations in unit-free MALL (and also with the *mix*-rule).

**Remark 2.7.** Looking at the commutative cut-elimination cases, as well as rule commutations, there is no commutation with *ax* and 1-rules because these rules have no context. For there is no rule for  $0$ , there is no commutation with  $0$  nor a  $\top - 0$  key cut-elimination case.

We denote the reflexive transitive closure of  $\xrightarrow{\eta}$  (resp.  $\xrightarrow{\beta}$ ,  $\vdash^r$ ) by  $\xrightarrow{\eta^*}$  (resp.  $\xrightarrow{\beta^*}$ ,  $\vdash^{r^*}$ ). By  $\xrightarrow{\beta^n}$  we mean a sequence of  $n$   $\xrightarrow{\beta}$  steps, and similarly for  $\xrightarrow{\eta^n}$ . Because of the analogy with the  $\lambda$ -calculus and since there will be no ambiguity, we use the notation  $=_{\beta\eta}$  for equality of proofs up to cut-elimination ( $\beta$ ) and axiom-expansion ( $\eta$ ). Similarly,  $=_{\beta}$  is equality up to cut-elimination only.

<sup>1</sup>This choice is more appropriate for our setting, as it has less cases and corresponds to the equivalence relation between normal forms, namely cut-free proofs.

**2.3. Linear isomorphisms.** We denote by  $\pi \stackrel{B}{\bowtie} \pi'$  the proof obtained by adding a cut on  $B$  between proofs  $\pi$  with conclusion  $\vdash \Gamma, B$  and  $\pi'$  with conclusion  $\vdash B^\perp, \Delta$ , and by  $\text{ax}_A$  the proof of  $\vdash A^\perp, A$  containing just an  $ax$ -rule.

**Definition 2.8** (Isomorphism). Two formulas  $A$  and  $B$  are *isomorphic*, denoted  $A \simeq B$ , if there exist proofs  $\pi$  of  $\vdash A^\perp, B$  and  $\pi'$  of  $\vdash B^\perp, A$  such that  $\pi \stackrel{B}{\bowtie} \pi' =_{\beta\eta} \text{ax}_A$  and  $\pi' \stackrel{A}{\bowtie} \pi =_{\beta\eta} \text{ax}_B$ :

$$\pi \stackrel{B}{\bowtie} \pi' = \frac{\frac{\pi}{\vdash A^\perp, B} \quad \frac{\pi'}{\vdash B^\perp, A}}{\vdash A^\perp, A} \text{cut} =_{\beta\eta} \frac{}{\vdash A^\perp, A} \text{ax} = \text{ax}_A$$

and

$$\pi' \stackrel{A}{\bowtie} \pi = \frac{\frac{\pi'}{\vdash B^\perp, A} \quad \frac{\pi}{\vdash A^\perp, B}}{\vdash B^\perp, B} \text{cut} =_{\beta\eta} \frac{}{\vdash B^\perp, B} \text{ax} = \text{ax}_B$$

By  $A \simeq B$  we mean the *cut-free* proofs  $\pi$  and  $\pi'$  define an isomorphism between formulas  $A$  and  $B$ , that is  $\pi$  is a proof of  $\vdash A^\perp, B$  and  $\pi'$  one of  $\vdash B^\perp, A$  such that  $\pi \stackrel{B}{\bowtie} \pi' =_{\beta\eta} \text{ax}_A$  and  $\pi' \stackrel{A}{\bowtie} \pi =_{\beta\eta} \text{ax}_B$ . It is quite easy to link these two notations of isomorphisms.

**Lemma 2.9.** *Given two formulas  $A$  and  $B$ ,  $A \simeq B$  if and only if there exist proofs  $\pi$  and  $\pi'$  such that  $A \stackrel{\pi, \pi'}{\simeq} B$ .*

*Proof.* The converse way follows by definition of an isomorphism. For the direct way, take proofs  $\pi$  and  $\pi'$  given by the definition of an isomorphism, not necessarily cut-free. One may eliminate all *cut*-rules inside, using weak normalization of cut-elimination  $\xrightarrow{\beta}$  (Corollary A.19).  $\square$

We aim to prove that two MALL (resp. unit-free MALL) formulas are isomorphic if and only if they are equal in the equational theory  $\mathcal{L}$  (resp.  $\mathcal{L}^\dagger$ ) defined as follows.

**Definition 2.10** (Equational theories  $\mathcal{L}$  and  $\mathcal{L}^\dagger$ ). We denote by  $\mathcal{L}$  the equational theory given on Table 1 on page 3, while  $\mathcal{L}^\dagger$  denotes the part not involving units, *i.e.* with commutativity, associativity and distributivity equations only.

Given an equational theory  $\mathcal{T}$ , the notation  $A =_{\mathcal{T}} B$  means that formulas  $A$  and  $B$  are equal in the theory  $\mathcal{T}$ . As often, the soundness part is easy (but tedious) to prove.

**Theorem 2.11** (Isomorphisms soundness, see Lemma 3 in [Lau05]). *If  $A =_{\mathcal{L}} B$  then  $A \simeq B$ .*

*Proof.* It suffices to give the proofs for each equation, then check their compositions can be reduced by cut-elimination to an axiom-expansion of an  $ax$ -rule. For instance, looking at the commutativity of  $\wp$ , *i.e.*  $A \wp B \simeq B \wp A$ , we set  $\pi$  and  $\pi'$  the following proofs:

$$\pi = \frac{\frac{\frac{}{\vdash B^\perp, B} \text{ax}}{\vdash B^\perp \otimes A^\perp, B, A} \otimes \quad \frac{}{\vdash A^\perp, A} \text{ax}}{\vdash B^\perp \otimes A^\perp, B \wp A} \wp \quad \text{and} \quad \pi' = \frac{\frac{\frac{}{\vdash A^\perp, A} \text{ax}}{\vdash A^\perp \otimes B^\perp, A, B} \otimes \quad \frac{}{\vdash B^\perp, B} \text{ax}}{\vdash A^\perp \otimes B^\perp, A \wp B} \wp$$

One can check

$\wp - \otimes$	$\frac{}{\vdash A \otimes B, B^\perp \wp A^\perp} ax$	$\xrightarrow{\eta}$	$\frac{\frac{}{\vdash A^\perp, A} ax \quad \frac{}{\vdash B^\perp, B} ax}{\vdash A \otimes B, B^\perp, A^\perp} \otimes}{\vdash A \otimes B, B^\perp \wp A^\perp} \wp$
$\& - \oplus$	$\frac{}{\vdash A \oplus B, B^\perp \& A^\perp} ax$	$\xrightarrow{\eta}$	$\frac{\frac{}{\vdash B, B^\perp} ax \quad \frac{}{\vdash A, A^\perp} ax}{\vdash A \oplus B, B^\perp} \oplus_2 \quad \frac{}{\vdash A \oplus B, A^\perp} \oplus_1}{\vdash A \oplus B, B^\perp \& A^\perp} \&$
$\perp - 1$	$\frac{}{\vdash 1, \perp} ax$	$\xrightarrow{\eta}$	$\frac{}{\vdash 1} 1}{\vdash 1, \perp} \perp$
$\top - 0$	$\frac{}{\vdash 0, \top} ax$	$\xrightarrow{\eta}$	$\frac{}{\vdash 0, \top} \top$

Table 2: Axiom-expansion in sequent calculus (up to a permutation of the conclusion)

$ax$	$\frac{\frac{}{\vdash A^\perp, A} ax \quad \frac{\pi}{\vdash A, \Gamma} cut}{\vdash A, \Gamma} \xrightarrow{\beta} \frac{\pi}{\vdash A, \Gamma}$
$\wp - \otimes$	$\frac{\frac{\frac{\pi_1}{\vdash A, \Gamma} \quad \frac{\pi_2}{\vdash B, \Delta}}{\vdash A \otimes B, \Gamma, \Delta} \otimes \quad \frac{\frac{\pi_3}{\vdash B^\perp, A^\perp, \Sigma}}{\vdash B^\perp \wp A^\perp, \Sigma} \wp}{\vdash \Gamma, \Delta, \Sigma} cut}{\vdash \Gamma, \Delta, \Sigma} \xrightarrow{\beta} \frac{\frac{\pi_1}{\vdash A, \Gamma} \quad \frac{\frac{\pi_2}{\vdash B, \Delta} \quad \frac{\pi_3}{\vdash B^\perp, A^\perp, \Sigma}}{\vdash A^\perp, \Delta, \Sigma} cut}{\vdash \Gamma, \Delta, \Sigma} cut$
$\& - \oplus_1$	$\frac{\frac{\frac{\pi_1}{\vdash A_1, \Gamma} \quad \frac{\pi_2}{\vdash A_2, \Gamma}}{\vdash A_1 \& A_2, \Gamma} \& \quad \frac{\frac{\pi_3}{\vdash A_2^\perp, \Delta}}{\vdash A_2^\perp \oplus A_1^\perp, \Delta} \oplus_1}{\vdash \Gamma, \Delta} cut}{\vdash \Gamma, \Delta} \xrightarrow{\beta} \frac{\frac{\pi_2}{\vdash A_2, \Gamma} \quad \frac{\pi_3}{\vdash A_2^\perp, \Delta}}{\vdash \Gamma, \Delta} cut$
$\& - \oplus_2$	$\frac{\frac{\frac{\pi_1}{\vdash A_1, \Gamma} \quad \frac{\pi_2}{\vdash A_2, \Gamma}}{\vdash A_1 \& A_2, \Gamma} \& \quad \frac{\frac{\pi_3}{\vdash A_1^\perp, \Delta}}{\vdash A_2^\perp \oplus A_1^\perp, \Delta} \oplus_2}{\vdash \Gamma, \Delta} cut}{\vdash \Gamma, \Delta} \xrightarrow{\beta} \frac{\frac{\pi_1}{\vdash A_1, \Gamma} \quad \frac{\pi_3}{\vdash A_1^\perp, \Delta}}{\vdash \Gamma, \Delta} cut$
$\perp - 1$	$\frac{\frac{}{\vdash 1} 1 \quad \frac{\frac{\pi}{\vdash \Gamma}}{\vdash \Gamma, \perp} \perp}{\vdash \Gamma} cut}{\vdash \Gamma} \xrightarrow{\beta} \frac{\pi}{\vdash \Gamma}$

Table 3: Cut-elimination in sequent calculus – key cases (up to a permutation of the conclusion)

$\wp - cut$	$\frac{\frac{\pi_1}{\frac{\vdash A, B, C, \Gamma}{\vdash A, B \wp C, \Gamma} \wp} \quad \frac{\pi_2}{\vdash A^\perp, \Delta} cut}{\vdash B \wp C, \Gamma, \Delta} cut$	$\xrightarrow{\beta}$	$\frac{\frac{\pi_1}{\vdash A, B, C, \Gamma} \quad \frac{\pi_2}{\vdash A^\perp, \Delta} cut}{\frac{\vdash B, C, \Gamma, \Delta}{\vdash B \wp C, \Gamma, \Delta} \wp} cut$
$\otimes - cut - 1$	$\frac{\frac{\pi_1}{\vdash A, B, \Gamma} \quad \frac{\pi_2}{\vdash C, \Delta} \otimes \quad \frac{\pi_3}{\vdash A^\perp, \Sigma} cut}{\vdash B \otimes C, \Gamma, \Delta, \Sigma} cut$	$\xrightarrow{\beta}$	$\frac{\frac{\pi_1}{\vdash A, B, \Gamma} \quad \frac{\pi_3}{\vdash A^\perp, \Sigma} cut}{\vdash B, \Gamma, \Sigma} cut \quad \frac{\pi_2}{\vdash C, \Delta} \otimes}{\vdash B \otimes C, \Gamma, \Delta, \Sigma} \otimes$
$\otimes - cut - 2$	$\frac{\frac{\pi_1}{\vdash B, \Gamma} \quad \frac{\pi_2}{\vdash A, C, \Delta} \otimes \quad \frac{\pi_3}{\vdash A^\perp, \Sigma} cut}{\vdash B \otimes C, \Gamma, \Delta, \Sigma} cut$	$\xrightarrow{\beta}$	$\frac{\frac{\pi_1}{\vdash B, \Gamma} \quad \frac{\pi_2}{\vdash A, C, \Delta} \quad \frac{\pi_3}{\vdash A^\perp, \Sigma} cut}{\vdash B \otimes C, \Gamma, \Delta, \Sigma} \otimes$
$\& - cut$	$\frac{\frac{\pi_1}{\vdash A, B, \Gamma} \quad \frac{\pi_2}{\vdash A, C, \Gamma} \& \quad \frac{\pi_3}{\vdash A^\perp, \Delta} cut}{\vdash B \& C, \Gamma, \Delta} cut$	$\xrightarrow{\beta}$	$\frac{\frac{\pi_1}{\vdash A, B, \Gamma} \quad \frac{\pi_3}{\vdash A^\perp, \Delta} cut}{\vdash B, \Gamma, \Delta} cut \quad \frac{\frac{\pi_2}{\vdash A, C, \Gamma} \quad \frac{\pi_3}{\vdash A^\perp, \Delta} cut}{\vdash C, \Gamma, \Delta} \&}{\vdash B \& C, \Gamma, \Delta} \&$
$\oplus_1 - cut$	$\frac{\frac{\pi_1}{\vdash A, B_1, \Gamma} \quad \frac{\pi_2}{\vdash A^\perp, \Delta} cut}{\frac{\vdash A, B_1 \oplus B_2, \Gamma}{\vdash B_1 \oplus B_2, \Gamma, \Delta} \oplus_1} cut$	$\xrightarrow{\beta}$	$\frac{\frac{\pi_1}{\vdash A, B_1, \Gamma} \quad \frac{\pi_2}{\vdash A^\perp, \Delta} cut}{\frac{\vdash B_1, \Gamma, \Delta}{\vdash B_1 \oplus B_2, \Gamma, \Delta} \oplus_1} cut$
$\oplus_2 - cut$	$\frac{\frac{\pi_1}{\vdash A, B_2, \Gamma} \quad \frac{\pi_2}{\vdash A^\perp, \Delta} cut}{\frac{\vdash A, B_1 \oplus B_2, \Gamma}{\vdash B_1 \oplus B_2, \Gamma, \Delta} \oplus_2} cut$	$\xrightarrow{\beta}$	$\frac{\frac{\pi_1}{\vdash A, B_2, \Gamma} \quad \frac{\pi_2}{\vdash A^\perp, \Delta} cut}{\frac{\vdash B_2, \Gamma, \Delta}{\vdash B_1 \oplus B_2, \Gamma, \Delta} \oplus_2} cut$
$\perp - cut$	$\frac{\frac{\pi_1}{\vdash A, \Gamma} \quad \frac{\pi_2}{\vdash A^\perp, \Delta} cut}{\frac{\vdash A, \perp, \Gamma}{\vdash \perp, \Gamma, \Delta} \perp} cut$	$\xrightarrow{\beta}$	$\frac{\frac{\pi_1}{\vdash A, \Gamma} \quad \frac{\pi_2}{\vdash A^\perp, \Delta} cut}{\frac{\vdash \Gamma, \Delta}{\vdash \perp, \Gamma, \Delta} \perp} cut$
$\top - cut$	$\frac{\frac{\pi}{\vdash A, \top, \Gamma} \top \quad \frac{\pi}{\vdash A^\perp, \Delta} cut}{\vdash \top, \Gamma, \Delta} cut$	$\xrightarrow{\beta}$	$\frac{\pi}{\vdash \top, \Gamma, \Delta} \top$
$cut - cut$	$\frac{\frac{\frac{\pi_1}{\vdash A, B, \Gamma} \quad \frac{\pi_2}{\vdash B^\perp, \Delta} cut}{\vdash A, \Gamma, \Delta} cut \quad \frac{\pi_3}{\vdash A^\perp, \Sigma} cut}{\vdash \Gamma, \Delta, \Sigma} cut$	$\xrightarrow{\beta}$	$\frac{\frac{\pi_1}{\vdash A, B, \Gamma} \quad \frac{\pi_3}{\vdash A^\perp, \Sigma} cut}{\vdash B, \Gamma, \Sigma} cut \quad \frac{\pi_2}{\vdash B^\perp, \Delta} cut}{\vdash \Gamma, \Delta, \Sigma} cut$

Table 4: Cut-elimination in sequent calculus – commutative cases (up to a permutation of the conclusion)





$\frac{}{\vdash A_1 \wp A_2, \top, \Gamma} \top$	$\frac{C_{\top}^{\wp}}{\leftarrow} \frac{}{\vdash A_1, A_2, \top, \Gamma} \top$ $\frac{}{\vdash A_1 \wp A_2, \top, \Gamma} \wp$
$\frac{}{\vdash A_1 \otimes A_2, \top, \Gamma, \Delta} \top$	$\frac{C_{\top}^{\otimes}}{\leftarrow} \frac{}{\vdash A_1, \top, \Gamma} \top$ $\frac{\pi}{\vdash A_2, \Delta} \otimes$ $\frac{}{\vdash A_1 \otimes A_2, \top, \Gamma, \Delta} \otimes$
$\frac{}{\vdash A_1 \otimes A_2, \top, \Gamma, \Delta} \top$	$\frac{C_{\top}^{\otimes}}{\leftarrow} \frac{\pi}{\vdash A_1, \Gamma} \frac{}{\vdash A_2, \top, \Delta} \top$ $\frac{}{\vdash A_1 \otimes A_2, \top, \Gamma, \Delta} \otimes$
$\frac{}{\vdash A_1 \& A_2, \top, \Gamma} \top$	$\frac{C_{\top}^{\&}}{\leftarrow} \frac{}{\vdash A_1, \top, \Gamma} \top$ $\frac{}{\vdash A_2, \top, \Gamma} \top$ $\frac{}{\vdash A_1 \& A_2, \top, \Gamma} \&$
$\frac{}{\vdash A_1 \oplus A_2, \top, \Gamma} \top$	$\frac{C_{\top}^{\oplus_i}}{\leftarrow} \frac{}{\vdash A_i, \top, \Gamma} \top$ $\frac{}{\vdash A_1 \oplus A_2, \top, \Gamma} \oplus_i$
$\frac{}{\vdash \top_0, \top_1, \Gamma} \top_0$	$\frac{C_{\top}^{\top}}{\leftarrow} \frac{}{\vdash \top_0, \top_1, \Gamma} \top_1$
$\frac{}{\vdash \top, \perp, \Gamma} \top$	$\frac{C_{\top}^{\perp}}{\leftarrow} \frac{}{\vdash \top, \Gamma} \top$ $\frac{}{\vdash \top, \perp, \Gamma} \perp$
$\frac{\pi_1}{\vdash A_1, A_2, \Gamma} \wp$ $\frac{}{\vdash A_1 \wp A_2, \perp, \Gamma} \perp$	$\frac{C_{\perp}^{\wp}}{\leftarrow} \frac{\pi_1}{\vdash A_1, A_2, \Gamma} \perp$ $\frac{}{\vdash A_1 \wp A_2, \perp, \Gamma} \wp$
$\frac{\pi_1}{\vdash A_1, \Gamma} \frac{\pi_2}{\vdash A_2, \Delta} \otimes$ $\frac{}{\vdash A_1 \otimes A_2, \perp, \Gamma, \Delta} \perp$	$\frac{C_{\perp}^{\otimes}}{\leftarrow} \frac{\pi_1}{\vdash A_1, \Gamma} \perp$ $\frac{\pi_2}{\vdash A_2, \Delta} \otimes$ $\frac{}{\vdash A_1 \otimes A_2, \perp, \Gamma, \Delta} \otimes$
$\frac{\pi_1}{\vdash A_1, \Gamma} \frac{\pi_2}{\vdash A_2, \Delta} \otimes$ $\frac{}{\vdash A_1 \otimes A_2, \perp, \Gamma, \Delta} \perp$	$\frac{C_{\perp}^{\otimes}}{\leftarrow} \frac{\pi_1}{\vdash A_1, \Gamma} \frac{\pi_2}{\vdash A_2, \Delta} \perp$ $\frac{}{\vdash A_1 \otimes A_2, \perp, \Gamma, \Delta} \otimes$
$\frac{\pi_1}{\vdash A_1, \Gamma} \frac{\pi_2}{\vdash A_2, \Gamma} \&$ $\frac{}{\vdash A_1 \& A_2, \perp, \Gamma} \perp$	$\frac{C_{\perp}^{\&}}{\leftarrow} \frac{\pi_1}{\vdash A_1, \Gamma} \perp$ $\frac{\pi_2}{\vdash A_2, \Gamma} \perp$ $\frac{}{\vdash A_1 \& A_2, \perp, \Gamma} \&$
$\frac{\pi}{\vdash A_i, \Gamma} \oplus_i$ $\frac{}{\vdash A_1 \oplus A_2, \perp, \Gamma} \perp$	$\frac{C_{\perp}^{\oplus_i}}{\leftarrow} \frac{\pi}{\vdash A_i, \Gamma} \perp$ $\frac{}{\vdash A_1 \oplus A_2, \perp, \Gamma} \oplus_i$
$\frac{\pi}{\vdash \Gamma} \perp_0$ $\frac{}{\vdash \perp_0, \perp_1, \Gamma} \perp_1$	$\frac{C_{\perp}^{\perp}}{\leftarrow} \frac{\pi}{\vdash \Gamma} \perp_1$ $\frac{}{\vdash \perp_0, \perp_1, \Gamma} \perp_0$

In the  $C_{\top}^{\perp}$  and  $C_{\perp}^{\perp}$  commutations, indices serve to identify occurrences of  $\top$ , and the index of the rules to identify the distinguished occurrence associated with the rule.

Table 6: Rule commutations involving a unit rule (up to a permutation of the conclusion)

$$\begin{array}{c}
\frac{\frac{\pi}{\vdash B^\perp \otimes A^\perp, B \wp A} \quad \frac{\pi'}{\vdash A^\perp \otimes B^\perp, A \wp B}}{\vdash B^\perp \otimes A^\perp, A \wp B} \text{ cut} \\
\searrow^{\beta^*} \\
\frac{\frac{\frac{\frac{\pi}{\vdash B^\perp, B} ax}{\vdash B^\perp \otimes A^\perp, A, B} \wp}{\vdash B^\perp \otimes A^\perp, A \wp B} \wp}{\vdash B^\perp \otimes A^\perp, A \wp B} ax \otimes \\
\searrow^{\eta} \\
\frac{\frac{\pi}{\vdash B^\perp \otimes A^\perp, A \wp B} ax}{\vdash B^\perp \otimes A^\perp, A \wp B} ax
\end{array}$$

and

$$\begin{array}{c}
\frac{\frac{\pi'}{\vdash A^\perp \otimes B^\perp, A \wp B} \quad \frac{\pi}{\vdash B^\perp \otimes A^\perp, B \wp A}}{\vdash A^\perp \otimes B^\perp, B \wp A} \text{ cut} \\
\searrow^{\beta^*} \\
\frac{\frac{\frac{\frac{\pi'}{\vdash A^\perp, A} ax}{\vdash A^\perp \otimes B^\perp, B, A} \wp}{\vdash A^\perp \otimes B^\perp, B \wp A} \wp}{\vdash A^\perp \otimes B^\perp, B \wp A} ax \otimes \\
\searrow^{\eta} \\
\frac{\frac{\pi'}{\vdash A^\perp \otimes B^\perp, B \wp A} ax}{\vdash A^\perp \otimes B^\perp, B \wp A} ax
\end{array}$$

□

All the difficulty lies in the proof of the other implication, completeness, on which the rest of this work focuses.

### 3. AXIOM-EXPANSION

The goal of this section is to reduce the study of isomorphisms to proofs with *atomic axioms* only, *i.e.* whose  $ax$ -rules are on a formula  $A = X$  or  $A = X^\perp$  (for  $X$  an atom), no more considering axiom-expansion. Said in another manner, we restrict our study to proofs in normal form for the  $\eta$  relation, so as to have only  $=_\beta$  instead of  $=_{\beta\eta}$  when considering isomorphisms.

To begin with, axiom-expansion is convergent.

**Proposition 3.1.** *Axiom-expansion  $\xrightarrow{\eta}$  is strongly normalizing and confluent.*

*Proof.* Strong normalization follows from the fact that a  $\xrightarrow{\eta}$  step strictly decreases the sum of the sizes of the formulas on which an  $ax$ -rule is applied.

Confluence can be deduced from the diamond property. Observe that two distinct steps  $\tau \xleftarrow{\eta} \pi \xrightarrow{\eta} \phi$  always commute, *i.e.* there exists  $\mu$  such that  $\tau \xrightarrow{\eta} \mu \xleftarrow{\eta} \phi$  (there is no critical pair). Hence the diamond property of  $\xrightarrow{\eta}$ , thus its confluence. □

**Remark 3.2.** As long as there exists a  $ax$ -rule not on an atom, a  $\xrightarrow{\eta}$  axiom-expansion step can be applied. Thus, atomic-axiom proofs correspond to proofs in normal form for  $\xrightarrow{\eta}$ .

Thanks to Proposition 3.1, we denote by  $\eta(\pi)$  the unique  $\eta$ -normal form of a proof  $\pi$ , *i.e.* the proof obtained by expanding iteratively all  $ax$ -rules in  $\pi$  (in any order thanks to

confluence). Thus, we can define  $\text{id}_A = \eta(\text{ax}_A)$ , the axiom-expansion of the proof consisting of only one  $\text{ax}$ -rule. The goal of this section is to prove the following (proof on page 14).

**Proposition 3.3** (Reduction to atomic-axiom proofs). *Let  $\pi$  and  $\tau$  be proofs such that  $\pi =_{\beta\eta} \tau$ . Then  $\eta(\pi) =_{\beta} \eta(\tau)$  with, in this sequence, only proofs in  $\eta$ -normal form.*

This allows us to then consider proofs with atomic axioms only, manipulated through composition by cut and cut-elimination, never to speak again of  $\eta$  rewriting.

We will need some intermediate results to reach our goal. We set  $a(\pi \xrightarrow{\beta^*} \tau)$  the multiset of the sizes of the formulas in the  $\text{ax}$  key cases of these  $\xrightarrow{\beta}$  reductions.

**Lemma 3.4.** *Let  $\pi$ ,  $\tau$  and  $\phi$  be proofs such that  $\tau \xleftarrow{\beta} \pi \xrightarrow{\eta} \phi$ . Then there exists  $\mu$  such that  $\tau \xrightarrow{\eta^*} \mu \xleftarrow{\beta} \phi$  or there exist  $\mu_1$  and  $\mu_2$  such that  $\phi \xrightarrow{\eta^*} \mu_1 \xrightarrow{\beta^*} \mu_2 \xleftarrow{\eta^*} \tau$ . Furthermore,  $a(\phi \xrightarrow{\beta} \mu) = a(\pi \xrightarrow{\beta} \tau)$  in the first case and  $a(\mu_1 \xrightarrow{\beta^*} \mu_2) < a(\pi \xrightarrow{\beta} \tau)$  in the second one. Diagrammatically:*

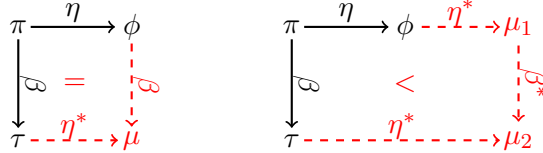

*Proof.* Call  $r$  the  $\text{ax}$ -rule that  $\pi \xrightarrow{\eta} \phi$  expands, and  $A$  its formula. If the cut-elimination step is not an  $\text{ax}$  key case using  $r$ , then the two steps commute and there exists  $\mu$  such that  $\phi \xrightarrow{\beta} \mu$  and  $\tau \xrightarrow{\eta} \mu$  (or  $\tau \xrightarrow{\eta} \cdot \xrightarrow{\eta} \mu$  if  $r$  belongs to a sub-proof duplicated by the  $\xrightarrow{\beta}$  step, or  $\tau = \mu$  if it belongs to a sub-proof erased by the  $\xrightarrow{\beta}$  step). In particular,  $a(\phi \xrightarrow{\beta} \mu) = a(\pi \xrightarrow{\beta} \tau)$  for they use the same rules.

Otherwise, the cut-elimination step is an  $\text{ax}$  key case on  $r$ , with a  $\text{cut}$ -rule we call  $c$  and a sub-proof  $\rho$  in the other branch of  $c$  that the one leading to  $r$ ;  $c$  introduces the formula  $A$ . The reasoning we apply is depicted on Figure 1. Starting from  $\phi$ , consider the rules introducing  $A^\perp$  in (all slices of)  $\rho$ . If any of them are  $\text{ax}$ -rules, then these are necessarily on the formula  $A$ ; expand those  $\text{ax}$ -rules, in both  $\phi$  and  $\tau$  (keeping the same names for proofs  $\pi$ ,  $\tau$  and  $\rho$  by abuse). Then, in  $\phi$ , commute the  $\text{cut}$ -rule  $c$  with rules of  $\rho$  until reaching the rules introducing  $A^\perp$  in all slices (which are rules of the main connective of  $A^\perp$  or  $\top$ -rules). Applying the corresponding key cases or  $\top$ - $\text{cut}$  commutative case (first commuting with a rule of the expanded axiom  $r$  if  $A$  is a positive formula, and doing it after if  $A$  is a negative formula), then the  $\text{ax}$  key cases on strict sub-formulas of  $A$  yields  $\tau$ . During these  $\text{ax}$  key cases, we cut on sub-formulas of  $A$ , so on formulas of a strictly smaller size. Therefore  $\phi \xrightarrow{\eta^*} \cdot \xrightarrow{\beta^*} \cdot \xleftarrow{\eta^*} \tau$ , with  $a(\cdot \xrightarrow{\beta^*} \cdot) < a(\pi \xrightarrow{\beta} \tau)$ .  $\square$

**Fact 3.5.** Cut-elimination  $\xrightarrow{\beta}$  preserves being in  $\eta$ -normal form.

**Lemma 3.6.** *Let  $\pi$ ,  $\tau$  and  $\phi$  be proofs such that  $\tau \xleftarrow{\eta^*} \pi \xrightarrow{\beta^*} \phi$ , with  $\tau$  an  $\eta$ -normal proof. There exists an  $\eta$ -normal proof  $\mu$  such that  $\tau \xrightarrow{\beta^*} \mu \xleftarrow{\eta^*} \phi$ . Diagrammatically:*

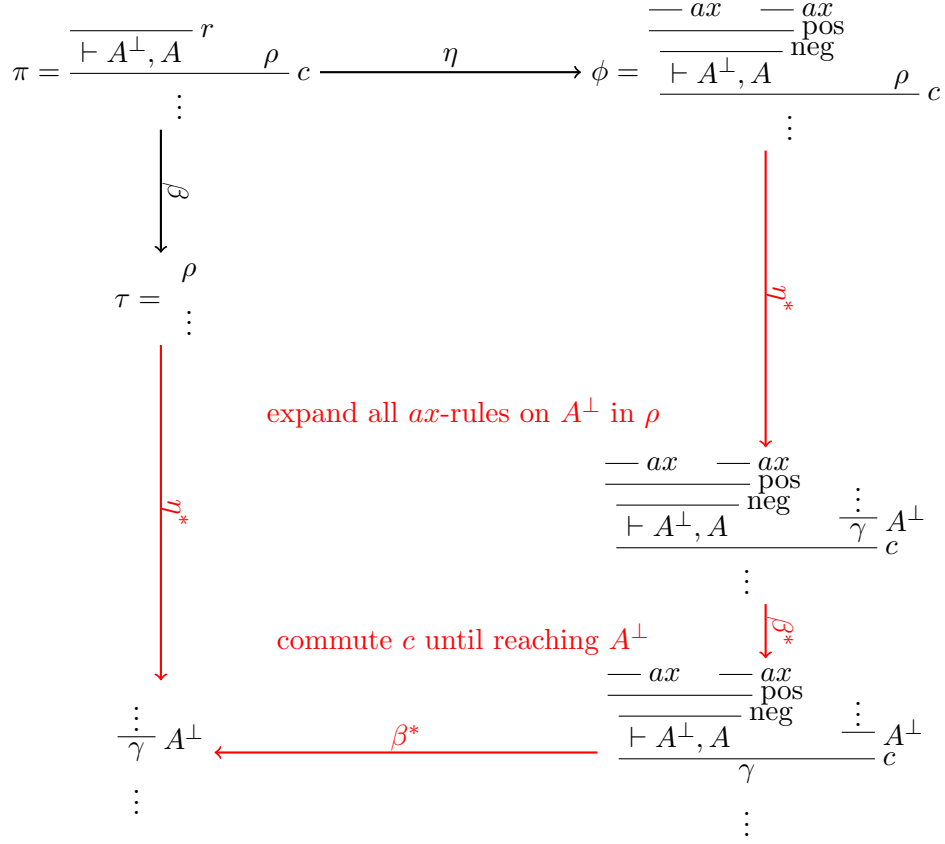
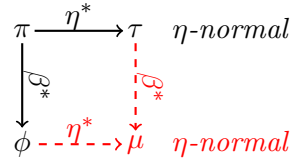

Figure 1: Schematic representation of the second case of the proof of Lemma 3.4



*Proof.* Assume  $\tau \xleftarrow{\eta^m} \pi \xrightarrow{\beta^n} \phi$ . If we find a  $\mu$  respecting the diagram, then it is an  $\eta$ -normal form thanks to Fact 3.5. We reason by induction on the lexicographic order of the triple  $(a(\pi \xrightarrow{\beta^*} \phi), n, m)$ . If  $n = 0$  or  $m = 0$ , then the result trivially holds ( $\mu = \tau$  or  $\mu = \phi$ ).

Consider the case  $n + 1$  and  $m + 1$ . Therefore,  $\tau \xleftarrow{\eta^m} \iota \xleftarrow{\eta} \pi \xrightarrow{\beta} \kappa \xrightarrow{\beta^n} \phi$ . We apply Lemma 3.4 on  $\iota \xleftarrow{\eta} \pi \xrightarrow{\beta} \kappa$ , yielding  $\rho$  such that  $\iota \xrightarrow{\beta} \rho \xleftarrow{\eta^*} \phi$  with  $a(\iota \xrightarrow{\beta} \rho) = a(\pi \xrightarrow{\beta} \kappa)$  or  $\rho_1$  and  $\rho_2$  such that  $\iota \xrightarrow{\eta^*} \rho_1 \xrightarrow{\beta^*} \rho_2 \xleftarrow{\eta^*} \kappa$  with  $a(\rho_1 \xrightarrow{\beta^*} \rho_2) < a(\pi \xrightarrow{\beta} \kappa)$ . Both of these cases, and the reasonings we will apply, are illustrated by diagrams preceding them, with the following color convention: in blue are uses of Lemma 3.4, in green of confluence of  $\xrightarrow{\eta}$  and in red of the induction hypothesis.

$$\begin{array}{ccccc}
\pi & \xrightarrow{\eta} & \iota & \xrightarrow{\eta^m} & \tau & \eta\text{-normal} \\
\downarrow \beta & = & \downarrow \beta & IH & \downarrow \beta_* & \\
\kappa & \xrightarrow{\eta^*} & \rho & \xrightarrow{\eta^*} & \nu & \eta\text{-normal} \\
\downarrow \beta_n & & \downarrow \beta_n & IH & \downarrow \beta_* & \\
\phi & \xrightarrow{\eta^*} & & \xrightarrow{\eta^*} & \mu & \eta\text{-normal}
\end{array}$$

Assume to be in the first case. Applying the induction hypothesis on  $\tau \xleftarrow{\eta^m} \iota \xrightarrow{\beta} \rho$ , with  $\tau$  in  $\eta$ -normal form,  $a(\iota \xrightarrow{\beta} \rho) = a(\pi \xrightarrow{\beta} \kappa) \leq a(\pi \xrightarrow{\beta^*} \phi)$ ,  $1 \leq n + 1$  and  $m < m + 1$ , there exists an  $\eta$ -normal proof  $\nu$  such that  $\tau \xrightarrow{\beta^*} \nu \xleftarrow{\eta^*} \rho$ . We now apply the induction hypothesis on  $\nu \xleftarrow{\eta^*} \rho \xleftarrow{\eta^*} \kappa \xrightarrow{\beta^n} \phi$ , with  $\nu$  in  $\eta$ -normal form,  $a(\kappa \xrightarrow{\beta^n} \phi) \leq a(\pi \xrightarrow{\beta^*} \phi)$  and  $n < n + 1$ . We obtain an  $\eta$ -normal proof  $\mu$  such that  $\nu \xrightarrow{\beta^*} \mu \xleftarrow{\eta^*} \phi$ . This concludes the first case.

$$\begin{array}{ccccc}
\pi & \xrightarrow{\eta} & \iota & \xrightarrow{\eta^m} & \tau & \eta\text{-normal} \\
\downarrow \beta & & \downarrow \eta_* & \eta^* & \downarrow \beta_* & \\
& & \rho_1 & & & \\
\downarrow \beta & & \downarrow \beta_* & IH & & \\
\kappa & \xrightarrow{\eta^*} & \rho_2 & \xrightarrow{\eta^*} & \nu & \eta\text{-normal} \\
\downarrow \beta_n & & \downarrow \beta_n & IH & \downarrow \beta_* & \\
\phi & \xrightarrow{\eta^*} & & \xrightarrow{\eta^*} & \mu & \eta\text{-normal}
\end{array}$$

Consider the second case. Using the confluence of  $\xrightarrow{\eta}$  on  $\tau \xleftarrow{\eta^m} \iota \xrightarrow{\eta^*} \rho_1$  (Proposition 3.1), with  $\tau$  in  $\eta$ -normal form, yields  $\tau \xleftarrow{\eta^*} \rho_1$ . We then apply the induction hypothesis on  $\tau \xleftarrow{\eta^*} \rho_1 \xrightarrow{\beta^*} \rho_2$ , with  $\tau$  in  $\eta$ -normal form and  $a(\rho_1 \xrightarrow{\beta^*} \rho_2) < a(\pi \xrightarrow{\beta^*} \phi)$ . This yields an  $\eta$ -normal proof  $\nu$  such that  $\tau \xrightarrow{\beta^*} \nu \xleftarrow{\eta^*} \rho_2$ . We use the induction hypothesis again, this time on  $\nu \xleftarrow{\eta^*} \rho_2 \xleftarrow{\eta^*} \kappa \xrightarrow{\beta^n} \phi$ , with  $\nu$  in  $\eta$ -normal form,  $a(\kappa \xrightarrow{\beta^n} \phi) \leq a(\pi \xrightarrow{\beta^*} \phi)$  and  $n < n + 1$ . We obtain an  $\eta$ -normal proof  $\mu$  with  $\nu \xrightarrow{\beta^*} \mu \xleftarrow{\eta^*} \phi$ , solving the second case.  $\square$

We can now prove the main result of this section, Proposition 3.3.

*Proof of Proposition 3.3.* We reason by induction on the length of the sequence  $\pi =_{\beta\eta} \tau$ . If it is of null length, then  $\pi = \tau$  hence  $\eta(\pi) = \eta(\tau)$ . Otherwise, there is a proof  $\phi$  such that

$\pi - \phi =_{\beta\eta} \tau$  with  $- \in \{\xrightarrow{\beta}; \xleftarrow{\beta}; \xrightarrow{\eta}; \xleftarrow{\eta}\}$ . By induction hypothesis,  $\eta(\phi) =_{\beta} \eta(\tau)$ , with only axiom-expanded proofs in this sequence. We distinguish cases according to  $\pi - \phi$ .

If  $\pi \xrightarrow{\beta} \phi$ , then as  $\eta(\pi) \xleftarrow{\eta^*} \pi$  we can apply Lemma 3.6 to obtain an  $\eta$ -normal proof  $\mu$  such that  $\eta(\pi) \xrightarrow{\beta^*} \mu \xleftarrow{\eta^*} \phi$ . Thus,  $\mu = \eta(\phi)$ , so  $\eta(\pi) \xrightarrow{\beta^*} \eta(\phi) =_{\beta} \eta(\tau)$  and the result holds.

Similarly, if  $\pi \xleftarrow{\beta} \phi$  then, as  $\phi \xrightarrow{\eta^*} \eta(\phi)$ , there exists an  $\eta$ -normal proof  $\mu$  such that  $\pi \xrightarrow{\eta^*} \mu \xleftarrow{\beta^*} \eta(\phi)$  (Lemma 3.6). Thus  $\mu = \eta(\pi)$ , and  $\eta(\pi) \xleftarrow{\beta^*} \eta(\phi) =_{\beta} \eta(\tau)$ .

Finally, if  $\pi \xrightarrow{\eta} \phi$  or  $\pi \xleftarrow{\eta} \phi$ , then  $\eta(\pi) = \eta(\phi) =_{\beta} \eta(\tau)$  and the conclusion follows.  $\square$

#### 4. CUT-ELIMINATION AND RULE COMMUTATIONS

It is not possible to apply the reasoning from the previous section (about axiom-expansion) to cut-elimination, because cut-elimination is confluent only up to rule commutations. This is what we want to prove in this section, reducing the problem from looking at cut-elimination to considering rule commutations.

A first, easy but important, result is that rule commutation is included in equality up to cut-elimination.

**Proposition 4.1** ( $\vdash^r \subseteq =_{\beta}$ ). *Given proofs  $\pi$  and  $\tau$ , if  $\pi \vdash^r \tau$  then  $\pi =_{\beta} \tau$ .*

*Proof.* It suffices, for each commutation, to give a proof that can be reduced by cut elimination to both sides. We give here only a few representative cases.

- $C_{\&}^{\top}$  and  $C_{\top}^{\&}$  commutations. The proof

$$\frac{\frac{\vdash 0, \top}{\vdash 0, \top} \top \quad \frac{\frac{\vdash A_1, \top, \Gamma}{\vdash A_1, \top, \Gamma} \top \quad \frac{\vdash A_2, \top, \Gamma}{\vdash A_2, \top, \Gamma} \top}{\vdash A_1 \& A_2, \top, \Gamma} \&}{\vdash A_1 \& A_2, \top, \Gamma} cut$$

reduces to both

$$\frac{\vdash A_1 \& A_2, \top, \Gamma}{\vdash A_1 \& A_2, \top, \Gamma} \top \quad \text{and} \quad \frac{\frac{\vdash A_1, \top, \Gamma}{\vdash A_1, \top, \Gamma} \top \quad \frac{\vdash A_2, \top, \Gamma}{\vdash A_2, \top, \Gamma} \top}{\vdash A_1 \& A_2, \top, \Gamma} \&$$

according respectively to whether the *cut*-rule is first commuted with the  $\top$ -rule on its left or with the  $\&$ -rule on its right and then with the  $\top$ -rule on its left in both occurrences.

- $C_{\oplus_i}^{\perp}$  and  $C_{\perp}^{\oplus_i}$  commutations. The proof

$$\frac{\frac{\frac{\pi}{\vdash A_i, \Gamma}}{\vdash A_i, \perp, \Gamma} \perp \quad \frac{\frac{\quad}{\vdash A_i^{\perp}, A_i} ax}{\vdash A_i^{\perp}, A_1 \oplus A_2} \oplus_i}{\vdash A_1 \oplus A_2, \perp, \Gamma} cut$$

reduces to both

$$\frac{\frac{\frac{\pi}{\vdash A_i, \Gamma}}{\vdash A_1 \oplus A_2, \Gamma} \oplus_i}{\vdash A_1 \oplus A_2, \perp, \Gamma} \perp \quad \text{and} \quad \frac{\frac{\frac{\pi}{\vdash A_i, \Gamma}}{\vdash A_i, \perp, \Gamma} \perp}{\vdash A_1 \oplus A_2, \perp, \Gamma} \oplus_i$$

according respectively to whether the *cut*-rule is first commuted with the  $\perp$ -rule on its left or with the  $\oplus_i$ -rule on its right.

- $C_{\otimes}^{\otimes}$  commutations. The proof

$$\frac{\frac{\pi_1}{\vdash A_1, \Gamma} \quad \frac{}{\vdash A_2^\perp, A_2} ax}{\vdash A_2^\perp, A_1 \otimes A_2, \Gamma} \otimes \quad \frac{\frac{\pi_2}{\vdash A_2, B_1, \Delta} \quad \frac{\pi_3}{\vdash B_2, \Sigma}}{\vdash B_1 \otimes B_2, \Delta, \Sigma, A_2} \otimes}{\vdash A_1 \otimes A_2, B_1 \otimes B_2, \Gamma, \Delta, \Sigma} cut$$

reduces to both

$$\frac{\frac{\pi_1}{\vdash A_1, \Gamma} \quad \frac{\frac{\pi_2}{\vdash A_2, B_1, \Delta} \quad \frac{\pi_3}{\vdash B_2, \Sigma}}{\vdash A_2, B_1 \otimes B_2, \Delta, \Sigma} \otimes}{\vdash A_1 \otimes A_2, B_1 \otimes B_2, \Gamma, \Delta, \Sigma} \otimes \quad \text{and} \quad \frac{\frac{\pi_1}{\vdash A_1, \Gamma} \quad \frac{\pi_2}{\vdash A_2, B_1, \Delta}}{\vdash A_1 \otimes A_2, B_1, \Gamma, \Delta} \otimes \quad \frac{\pi_3}{\vdash B_2, \Sigma} \otimes}{\vdash A_1 \otimes A_2, B_1 \otimes B_2, \Gamma, \Delta, \Sigma} \otimes$$

according respectively to whether the *cut*-rule is first commuted with the  $\otimes$ -rule on its left or on its right.

Other  $C_{\otimes}^{\otimes}$  commutations are similar.

- $C_{\wp}^{\wp}$  and  $C_{\&}^{\wp}$  commutations. The proof

$$\frac{\frac{\frac{\pi_1}{\vdash A_1, A_2, B_1, \Gamma} \wp}{\vdash A_1 \wp A_2, B_1, \Gamma} \wp \quad \frac{\frac{\pi_2}{\vdash A_1, A_2, B_2, \Gamma} \wp}{\vdash A_1 \wp A_2, B_2, \Gamma} \wp}{\vdash A_1 \wp A_2, B_1 \& B_2, \Gamma} \& \quad \frac{\frac{}{\vdash A_2^\perp, A_2} ax \quad \frac{}{\vdash A_1^\perp, A_1} ax}{\vdash A_1, A_2, A_2^\perp \otimes A_1^\perp} \otimes}{\vdash A_1 \wp A_2, A_2^\perp \otimes A_1^\perp} \wp}{\vdash A_1 \wp A_2, B_1 \& B_2, \Gamma} cut$$

reduces to both

$$\frac{\frac{\frac{\pi_1}{\vdash A_1, A_2, B_1, \Gamma} \wp}{\vdash A_1 \wp A_2, B_1, \Gamma} \wp \quad \frac{\frac{\pi_2}{\vdash A_1, A_2, B_2, \Gamma} \wp}{\vdash A_1 \wp A_2, B_2, \Gamma} \wp}{\vdash A_1 \wp A_2, B_1 \& B_2, \Gamma} \& \quad \text{and} \quad \frac{\frac{\pi_1}{\vdash A_1, A_2, B_1, \Gamma} \quad \frac{\pi_2}{\vdash A_1, A_2, B_2, \Gamma}}{\vdash A_1, A_2, B_1 \& B_2, \Gamma} \&}{\vdash A_1 \wp A_2, B_1 \& B_2, \Gamma} \wp$$

according respectively to whether the *cut*-rule is first commuted with the  $\&$ -rule on its left or with the  $\wp$ -rule on its right.  $\square$

Cut-elimination  $\xrightarrow{\beta}$  is weakly normalizing (see Corollary A.19). Furthermore, rule commutation is its “core”, in the following meaning.

**Theorem 4.2** (Rule commutation is the core of cut-elimination). *If two axiom-expanded proofs  $\pi$  and  $\tau$  are  $\beta$ -equal, then any of their normal forms by  $\xrightarrow{\beta}$  are related by  $\vdash\!\!\vdash^*$ .*

This result is not surprising but has not already been proved as far as we know for it is rather tedious to establish. It is an important general result about sequent calculus, which we are convinced should hold for full linear logic. We can extend it to  $\beta\eta$ -equality.

**Theorem 4.3.** *Let  $\pi_1$  and  $\pi_2$  be  $\beta\eta$ -equal proofs. Then, letting  $\pi'_1$  (resp.  $\pi'_2$ ) be a result of expanding all axioms and then eliminating all cuts in  $\pi_1$  (resp.  $\pi_2$ ),  $\pi'_1 \vdash\!\!\vdash^* \pi'_2$ .*

*Proof.* We have  $\pi_1 =_{\beta\eta} \pi_2$ , so  $\eta(\pi_1) =_{\beta} \eta(\pi_2)$  by Proposition 3.3. By Theorem 4.2, it follows  $\eta(\pi_1) \xrightarrow{\beta^*} \pi'_1 \vdash\!\!\vdash^* \pi'_2 \xleftarrow{\beta^*} \eta(\pi_2)$ .  $\square$

The proof of Theorem 4.2 involves a result from rewriting theory modulo an equivalence relation, as well as plenty of case studies and intermediate results. Whence, for the sake of clarity, it is written in its own part in Appendix A.



## 5. REDUCTION TO THE UNIT-FREE DISTRIBUTED FRAGMENT

As written in the introduction, our plan is to use proof-nets, which currently exist only for axiom-expanded proofs in unit-free MALL. For we already reduced the problem to axiom-expanded proofs in Section 3, it stays to take care of the units. The main idea is that the multiplicative and additive units can be replaced by fresh atoms for the study of isomorphisms. However, this is not true in general, for instance we have  $(1 \oplus A) \otimes B \simeq B \oplus (A \otimes B)$  (using the soundness theorem, Theorem 2.11), and this isomorphism uses that 1 is unital for  $\otimes$ . Hence, we begin by reducing the problem to so-called *distributed* formulas, using the distributivity, unitality and cancellation equations of Table 1 on page 3 (Section 5.1). Then, for these special formulas, we identify patterns containing units in proofs equal to an identity up to rule commutations, patterns which can be lifted to proofs of isomorphisms (Section 5.2). Finally, we prove that, in an isomorphism between distributed formulas, replacing units by fresh atoms preserves being an isomorphism, reducing the study of isomorphisms to distributed formulas in the unit-free fragment (Section 5.3).

## 5.1. Reduction to distributed formulas.

**Definition 5.1** (Distributed formula). A formula is *distributed* if it does not have any sub-formula of the form  $A \otimes (B \oplus C)$ ,  $(A \oplus B) \otimes C$ ,  $A \otimes 1$ ,  $1 \otimes A$ ,  $A \oplus 0$ ,  $0 \oplus A$ ,  $A \otimes 0$ ,  $0 \otimes A$  or their duals  $(C \& B) \wp A$ ,  $C \wp (B \& A)$ ,  $\perp \wp A$ ,  $A \wp \perp$ ,  $\top \& A$ ,  $A \& \top$ ,  $\top \wp A$ ,  $A \wp \top$  (where  $A$ ,  $B$  and  $C$  are any formulas).

**Remark 5.2.** This notion is stable under duality: if  $A$  is distributed, so is  $A^\perp$ .

**Proposition 5.3.** *If the equational theory denoted  $\mathcal{L}$  (see Table 1 on page 3) is complete for isomorphisms between distributed formulas, then it is complete for isomorphisms between arbitrary formulas.*

*Proof.* The following rewriting system is strongly normalizing (but not confluent), with as normal forms distributed formulas, and each rule corresponds to a valid equality in the theory  $\mathcal{L}$ :

$$\begin{array}{c}
\begin{array}{l}
A \otimes (B \oplus C) \rightarrow (A \otimes B) \oplus (A \otimes C) \\
(A \oplus B) \otimes C \rightarrow (A \otimes C) \oplus (B \otimes C)
\end{array}
\quad \Bigg| \quad
\begin{array}{l}
(C \& B) \wp A \rightarrow (C \wp A) \& (B \wp A) \\
C \wp (B \& A) \rightarrow (C \wp B) \& (C \wp A)
\end{array} \\
\hline
\begin{array}{l}
A \otimes 1 \rightarrow A \\
A \oplus 0 \rightarrow A \\
A \otimes 0 \rightarrow 0
\end{array}
\quad \Bigg| \quad
\begin{array}{l}
1 \otimes A \rightarrow A \\
0 \oplus A \rightarrow A \\
0 \otimes A \rightarrow 0
\end{array}
\quad \Bigg| \quad
\begin{array}{l}
A \wp \perp \rightarrow A \\
A \& \top \rightarrow A \\
A \wp \top \rightarrow \top
\end{array}
\quad \Bigg| \quad
\begin{array}{l}
\perp \wp A \rightarrow A \\
\top \& A \rightarrow A \\
\top \wp A \rightarrow \top
\end{array}
\end{array}$$

Consider an isomorphism  $A \simeq B$  between two arbitrary formulas  $A$  and  $B$ . Let  $A_d$  and  $B_d$  be associated distributed formulas, obtained as normal forms of the above rewriting system. As this rewriting system is included in  $\mathcal{L}$ , we have  $A =_{\mathcal{L}} A_d$  and  $B =_{\mathcal{L}} B_d$ .

By soundness of  $\mathcal{L}$  (Theorem 2.11) and as linear isomorphism is a congruence, we deduce  $A_d \simeq A \simeq B \simeq B_d$ . The completeness hypothesis on  $\mathcal{L}$  for distributed formulas yields  $A_d =_{\mathcal{L}} B_d$  from  $A_d \simeq B_d$ . Thus  $A =_{\mathcal{L}} A_d =_{\mathcal{L}} B_d =_{\mathcal{L}} B$ .  $\square$

Therefore, we can now consider only distributed formulas. We will use this to study units, as well as when solving the unit-free case to prove there are only commutativity and associativity isomorphisms left.

**5.2. Patterns in distributed isomorphisms.** We analyze the behaviour of units in proofs equal to  $\text{id}_A$  up to rule commutations (recall  $\text{id}_A$  is the axiom-expansion of  $\text{ax}_A$ , the proof composed of an  $\text{ax}$ -rule on  $A$ ). We only do so for a *distributed* formula  $A$  as we have already seen it is enough in Section 5.1, and as the patterns we find hold only for these formulas.

**Proposition 5.4.** *Let  $\pi$  be a proof equal, up to rule commutations, to  $\text{id}_A$  with  $A$  distributed. Then:*

- the  $\top$ -rules of  $\pi$  are of the shape  $\frac{}{\vdash \top, 0} \top$  (with  $\top$  in  $A$  being the dual of 0 in  $A^\perp$ , or vice-versa);
- $\perp$ -rules and 1-rules come by pairs separated with  $\oplus_i$ -rules only, called a  $1/\oplus/\perp$ -pattern:  $\frac{\frac{\frac{}{\vdash 1} 1}{\vdash F} \rho}{\vdash \perp, F} \perp$  where  $\rho$  is a sequence of  $\oplus_i$ -rules (with  $\perp$  in  $A$  being the dual of 1 in  $A^\perp$ , or vice-versa);
- there is no sequent in  $\pi$  of the shape  $\vdash B \& C$ .

*Proof.* Given a formula  $B$ , we define the grammar  $\oplus[B] := B \mid \oplus[B] \oplus D \mid D \oplus \oplus[B]$  where  $D$  ranges over all formulas. The key idea is to find properties of  $\text{id}_A$  preserved by all rule commutations and ensuring the properties described in the statement. Hence, we prove a stronger property: any sequent  $S$  of a proof  $\pi$  obtained through a sequence of rule commutations from  $\text{id}_A$  for a distributed formula  $A$  respects:

- (1) the formulas of  $S$  are distributed;
- (2) if  $\top$  is a formula of  $S$ , then  $S = \vdash \top, 0$ , with 0 in  $A^\perp$  the dual of  $\top$  if  $\top$  is a sub-formula of  $A$  (or vice-versa);
- (3) if  $\perp$  is a formula of  $S$ , then  $S = \vdash \perp, \oplus[1]$  with  $\oplus[1]$  the grammar defined above, where the distinguished 1 is the dual of  $\perp$  in  $A^\perp$  if  $\perp$  is a sub-formula of  $A$  (or vice-versa), and the sub-proof of  $\pi$  above  $S$  is a sequence of  $\oplus_i$  rules leading to the distinguished 1, with in addition a  $\perp$ -rule inside this sequence;
- (4) if  $B \& C$  is a formula of  $S$ , then  $S = \vdash B \& C, \oplus[C^\perp \oplus B^\perp]$  with  $\oplus[C^\perp \oplus B^\perp]$  the grammar defined above, where the distinguished  $C^\perp \oplus B^\perp$  is the dual of  $B \& C$  in  $A^\perp$  if  $B \& C$  is a sub-formula of  $A$  (or vice-versa), and in the sub-proof of  $\pi$  above  $S$  the  $\oplus$ -rules of the distinguished  $C^\perp \oplus B^\perp$  are a  $\oplus_2$ -rule in the left branch of the  $\&$ -rule of  $B \& C$ , and a  $\oplus_1$ -rule in its right branch;
- (5) if  $S$  contains several negative formulas or several positive formulas, then its negative formulas are all  $\mathfrak{N}$ -formulas or negated atoms.

Remark that (5) is a corollary of properties (2), (3) and (4). As in  $\vdash^r$  there is no commutation with a *cut*-rule (in particular no *cut* –  $\top$  commutation) and no  $\otimes$  –  $\top$  commutation creating a sub-proof with a *cut*-rule, it follows that  $\pi$  is cut-free and has the sub-formula property, making (1) trivially true. We prove that the fully expanded axiom respects properties (2), (3) and (4), and that these properties are preserved by any rule commutation of  $\vdash^r$ .

*The fully expanded axiom respects the properties.* We prove it by induction on the distributed formula  $A$ . Notice that sub-formulas of  $A$  are also distributed. By symmetry, assume  $A$  is positive.

If  $A \in \{X, 1, 0\}$  where  $X$  is an atom, then:

$$\text{id}_A \in \left\{ \frac{}{\vdash X^\perp, X} \text{ax} ; \frac{\frac{}{\vdash 1} 1}{\vdash \perp, 1} \perp ; \frac{}{\vdash \top, 0} \top \right\}$$

Each of these proofs respects (2), (3) and (4).

Assume the result holds for  $B$  and  $C$ , and that  $A = B \otimes C$ . The proof  $\text{id}_A$  is:

$$\frac{\frac{\text{id}_B \quad \text{id}_C}{\vdash B^\perp, B \quad \vdash C^\perp, C} \otimes}{\vdash C^\perp, B^\perp, B \otimes C} \otimes}{\vdash C^\perp \wp B^\perp, B \otimes C} \wp$$

We have to prove the sequents  $\vdash C^\perp, B^\perp, B \otimes C$  and  $\vdash C^\perp \wp B^\perp, B \otimes C$  respect the properties. The latter respects (2), (3) and (4) trivially for it has neither a  $\top$ ,  $\perp$  nor  $\&$  formula. As  $C^\perp \wp B^\perp$  is distributed, it follows that neither  $C^\perp$  nor  $B^\perp$  can be a  $\top$ ,  $\perp$  or  $\&$  formula, and as such the former sequent also respects the properties.

Suppose  $A = B \oplus C$  with sequents of  $B$  and  $C$  respecting the properties. Now,  $\text{id}_A$  is:

$$\frac{\frac{\text{id}_C}{\vdash C^\perp, C} \oplus_2 \quad \frac{\text{id}_B}{\vdash B^\perp, B} \oplus_1}{\vdash C^\perp \& B^\perp, B \oplus C} \&$$

The sequent  $\vdash C^\perp \& B^\perp, B \oplus C$  respects (2), (3) and (4), as the  $\oplus$  is the dual of the  $\&$ . By symmetry, we show the properties are also fulfilled by  $\vdash B^\perp, B \oplus C$ , and they will be respected by  $\vdash C^\perp, B \oplus C$  with a similar proof. As the formulas are distributed,  $B^\perp$  cannot be a  $\top$  formula, hence the sequent respects (2). If  $B^\perp$  is not a  $\perp$  nor  $\&$  formula, then (3) and (4) hold for  $\vdash B^\perp, B \oplus C$ . If it is, then using that  $\vdash B^\perp, B$  respects (3) and (4), it follows that  $B \oplus C$  is also of the required shape, for  $B$  was.

*Every possible rule commutation preserves the properties.* We show it for each rule commutation, using every time the notations from Tables 5 and 6 in Definition 2.5, on Pages 9 and 10. By symmetry, we treat only one case for  $\otimes - \otimes$ ,  $\wp - \otimes$ ,  $\& - \otimes$  and  $\oplus_i - \otimes$  commutations.

**$\top$ -commutations:** Using property (2), we cannot do any commutation between a  $\top$ -rule and a  $\wp$ ,  $\otimes$ ,  $\&$ ,  $\oplus_i$ ,  $\perp$  or  $\top$ -rule, so no commutations at all involving a  $\top$ -rule.

**$\perp$ -commutations:** Using property (3), we cannot do any commutation between a  $\perp$ -rule and a  $\wp$ ,  $\otimes$ ,  $\&$  or  $\perp$ -rule. A commutation between a  $\perp$  and a  $\oplus_i$ -rule preserves property (3): we have by hypothesis  $\Gamma$  empty and  $A_1 \oplus A_2$  of the right shape. It also respects (2) and (4) trivially.

**$C_{\wp}^{\wp}$  commutation:** We have to show the properties for  $\vdash A_1, A_2, B_1 \wp B_2, \Gamma$ . Because  $\vdash A_1 \wp A_2, B_1 \wp B_2, \Gamma$  respects them, negative formulas of  $\Gamma$  are  $\wp$ -formulas or negated atoms by (5). By distributivity, if  $A_1$  (or  $A_2$ ) is a negative formula, then it must be a  $\wp$  one or a negated atom. Thus,  $\vdash A_1, A_2, B_1 \wp B_2, \Gamma$  fulfills (2), (3) and (4).

**$C_{\oplus_j}^{\oplus_i}$  commutation:** We show the properties for  $\vdash A_i, B_1 \oplus B_2, \Gamma$ . As  $\vdash A_1 \oplus A_2, B_1 \oplus B_2, \Gamma$  respects them, negative formulas of  $\Gamma$  are  $\wp$ -formulas or negated atoms by (5). If  $A_i$  is positive, a  $\wp$  or a negated atom, then we are done. Otherwise, as  $\vdash A_i, B_j, \Gamma$  fulfills the properties, it follows  $\Gamma$  is empty and  $B_j$  of the desired shape. By (1),  $B_j$  is not 0, thus  $A_i$  is not  $\top$ . Whether  $A_i$  is  $\perp$  or  $\&$ , the sequent  $\vdash A_i, B_1 \oplus B_2$  respects the properties.

**$C_{\otimes}^{\otimes}$  commutation:** We have to show the properties for  $\vdash A_1 \otimes A_2, B_1, \Gamma, \Delta$ . Because  $\vdash A_1 \otimes A_2, B_1 \otimes B_2, \Gamma, \Delta, \Sigma$  respects them, negative formulas of  $\Gamma$  and  $\Delta$  are  $\wp$ -formulas or negated atoms by (5). If  $B_1$  is positive, a  $\wp$  or a negated atom, then we

are done. Otherwise, as  $\vdash A_2, B_1, \Delta$  fulfills the properties, it follows  $\Delta$  is empty and  $B_1$  of the desired shape, so  $B_1$  is a 0, 1 or  $\oplus$ -formula. This is impossible as  $B_1 \otimes B_2$  is distributed by (1).

- $C_{\&}^{\&}, C_{\&}^{\&}, C_{\&}^{\&}, C_{\&}^{\&}$  and  $C_{\&}^{\otimes}$  **commutations:** These cases are impossible by property (4).
- $C_{\oplus}^{\&}$  and  $C_{\&}^{\oplus_i}$  **commutations:** In these cases, (4) for  $\vdash A_1 \& A_2, B_1 \oplus B_2, \Gamma$  implies  $\Gamma$  empty and  $B_1 \oplus B_2$  of the desired shape. Thus  $B_i$  of the desired shape ( $B_1 \oplus B_2$  is not the distinguished formula as it has the same rule  $\oplus_i$  in both branches of the  $\&$ -rule), proving the result for  $\vdash A_1 \& A_2, B_i$ . For  $\vdash A_1, B_1 \oplus B_2$  (and similarly  $\vdash A_2, B_1 \oplus B_2$ ),  $A_1$  cannot be a  $\top$  by (1), and if it is a  $\perp$  or a  $\&$ , then the hypothesis on  $\vdash A_1, B_i$  implies that the properties are also respected in  $\vdash A_1, B_1 \oplus B_2$ .
- $C_{\oplus}^{\&}$  and  $C_{\&}^{\oplus_i}$  **commutations:** Let us show the properties for  $\vdash A_1, A_2, B_1 \oplus B_2, \Gamma$  in the first commutation and  $\vdash A_1 \& A_2, B_i, \Gamma$  in the second. As they hold for  $\vdash A_1, A_2, B_i, \Gamma$ , negative formulas in  $A_1, A_2, B_i, \Gamma$  are  $\&$ -formulas or negated atoms by (5) and the result follows.
- $C_{\oplus}^{\otimes}$  **commutation:** We have to prove  $\vdash A_1, B_1 \oplus B_2, \Gamma$  respects the properties. Because  $\vdash A_1 \otimes A_2, B_1 \oplus B_2, \Gamma, \Delta$  fulfills them, negative formulas of  $\Gamma$  are  $\&$  or negated atoms by (5). If  $A_1$  is a negative formula other than a  $\&$  or an atom, then for  $\vdash A_1, B_i, \Gamma$  respects the properties we have that  $\Gamma$  is empty and  $B_i$  of the desired shape. By (1),  $B_i$  is not a 0, so  $A_1$  is not a  $\top$ . But then  $B_1 \oplus B_2$  also has the wished shape for  $A_1$ , and  $\vdash A_1, B_1 \oplus B_2$  fulfills the properties.
- $C_{\otimes}^{\oplus_i}$  **commutation:** We prove  $\vdash A_1 \otimes A_2, B_i, \Gamma, \Delta$  respects the properties. As they are fulfilled by  $\vdash A_1 \otimes A_2, B_1 \oplus B_2, \Gamma, \Delta$ , negative formulas of  $\Gamma$  and  $\Delta$  are  $\&$  or atoms by (5). As  $A_1 \otimes A_2$  is distributed by (1),  $A_1$  cannot be a 0, 1 nor  $\oplus$  formula, so by  $\vdash A_1, B_i, \Gamma$  fulfilling the properties it follows that  $B_i$  cannot be a negative formula other than a  $\&$  or an atom. The conclusion follows.
- $C_{\otimes}^{\&}$  **commutation:** We prove the properties for  $\vdash A_1, A_2, B_1 \otimes B_2, \Gamma, \Delta$ . As they are respected by  $\vdash A_1 \& A_2, B_1 \otimes B_2, \Gamma, \Delta$ , according to (5) negative formulas of  $\Gamma$  and  $\Delta$  can only be  $\&$ -formulas or atoms. As  $A_1 \& A_2$  is distributed by (1),  $A_1$  and  $A_2$  are positive or  $\&$ -formulas or atoms. The conclusion follows.
- $C_{\&}^{\otimes}$  **commutation:** We prove the properties for  $\vdash A_1 \& A_2, B_1, \Gamma$ . As  $\vdash A_1, A_2, B_1, \Gamma$  respects them, by (5) negative formulas of  $\Delta$  and  $B_1$  can only be  $\&$ -formulas or atoms, proving the result.

Therefore, we proved the expanded axiom respects these properties, and they are preserved by all rule commutations. The conclusion follows.  $\square$

The main goal of this part is proving  $\top$  and  $\perp$ -rules in proofs of distributed isomorphisms also belong to these patterns. Indeed, this property is preserved by cut anti-reduction, but it is not so easy to prove it. We will consider slices to do so (recall Definition 2.1 on page 4).

Cut-elimination can be extended from proofs to slices except that some reduction steps produce failures for slices: when a  $\&_i$  faces a  $\oplus_i$  and conversely. The reduction of the slice

$$\frac{\frac{\vdash A, \Gamma}{\vdash A \oplus B, \Gamma} \oplus_1 \quad \frac{\vdash B^\perp, \Delta}{\vdash B^\perp \& A^\perp, \Delta} \&_1}{\vdash \Gamma, \Delta} cut$$

is a failure since the selected sub-formulas of  $A \oplus B$  and its dual do not match. Given two slices  $s \in \mathcal{S}(\pi)$  and  $r \in \mathcal{S}(\rho)$  with respective conclusions  $\vdash A, \Gamma$  and  $\vdash A^\perp, \Delta$ , their composition by cut  $s \overset{A}{\bowtie} r$  reduces either to a slice of a normal form of  $\pi \overset{A}{\bowtie} \rho$  or to a failure.

**Lemma 5.5.** *Let  $\pi_1$  and  $\pi_2$  be proofs such that  $\pi_1 \xrightarrow{\beta} \pi_2$ . For each  $s_2 \in \mathcal{S}(\pi_2)$ , there exists  $s_1 \in \mathcal{S}(\pi_1)$  such that  $s_1 \xrightarrow{\beta} s_2$  or  $s_1 = s_2$ . Reciprocally, for each  $s_1 \in \mathcal{S}(\pi_1)$ ,  $s_1$  reduces to a failure or there exists  $s_2 \in \mathcal{S}(\pi_2)$  such that  $s_1 \xrightarrow{\beta} s_2$  or  $s_1 = s_2$ .*

*Proof.* We can check that each cut-elimination step respects this property, with the equality case coming from a reduction in  $\pi_1 \xrightarrow{\beta} \pi_2$  on rules not in the considered slice  $s_2$  (resp.  $s_1$ ).  $\square$

**Lemma 5.6.** *Let  $\pi_1$  and  $\pi_2$  be proofs whose composition over  $A$  reduces to a proof  $\tau$ . For each  $s \in \mathcal{S}(\tau)$ , there exist  $s_1 \in \mathcal{S}(\pi_1)$  and  $s_2 \in \mathcal{S}(\pi_2)$  such that  $s_1 \overset{A}{\bowtie} s_2$  reduces to  $s$ .*

*Proof.* By induction on  $\pi_1 \overset{A}{\bowtie} \pi_2 \xrightarrow{\beta^*} \tau$ , using Lemma 5.5.  $\square$

**Lemma 5.7.** *Let  $\pi_1$  and  $\pi_2$  be cut-free proofs of  $\vdash \Gamma$  with  $\top$ -rules only of the shape  $\frac{}{\vdash \top, 0} \top$ . Assume that  $\pi_1 \overset{r^*}{\vdash} \pi_2$ , where in this sequence there is no rule commutation involving a  $\top$ -rule. Then for each slice  $s_1 \in \mathcal{S}(\pi_1)$ , there exists a unique  $s_2 \in \mathcal{S}(\pi_2)$  such that  $s_1$  and  $s_2$  make the same choices for additive connectives in  $\Gamma$ .*

*Proof.* This can be easily checked for each equation in  $\overset{r}{\vdash}$ , save for those involving  $\top$ .  $\square$

Given a choice  $\mathcal{C}$  of premises for some additive connectives of a sequent, we say a slice is on  $\mathcal{C}$  if each  $\&_i$  and  $\oplus_i$ -rule in this slice takes premise  $i$  for a connective in  $\mathcal{C}$  whose chosen premise is  $i$ . This concept will be essential when speaking about proof-nets (in Section 6.1 for instance), as it is related to additive resolutions.

**Lemma 5.8.** *Given a choice  $\mathcal{C}$  of premises for additive connectives of  $A$  (but not  $A^\perp$ ), there exists a unique slice of  $\mathcal{S}(\text{id}_A)$  on it, which furthermore makes on  $A^\perp$  the dual choices of  $\mathcal{C}$ .*

*Proof.* Direct induction on  $A$ , following the definition of  $\text{id}_A$  on Table 2.  $\square$

We now prove a partial reciprocal to Lemma 5.6.

**Lemma 5.9.** *Let  $\pi$  and  $\pi'$  be cut-free proofs respectively of  $\vdash A^\perp, B$  and  $\vdash B^\perp, A$ , whose composition over  $A$  reduces to  $\text{id}_B$  up to rule commutation. Set  $\rho$  a normal form of  $\pi \overset{B}{\bowtie} \pi'$ , i.e. any result of eliminating all cut-rules in this proof. Then, for any slice  $s$  of  $\pi$ , there exists a slice  $s'$  of  $\pi'$  such that  $s \overset{B}{\bowtie} s'$  reduces to a slice of  $\rho$ .*

*Proof.* Take  $s \in \mathcal{S}(\pi)$ , and denote by  $\mathcal{C}$  the choices made in  $s$  on  $\&$  and  $\oplus$  connectives of the formula  $B$ . We will use that the composition over the formula  $A$  reduces to  $\text{id}_B$  up to  $\overset{r^*}{\vdash}$  to find  $s' \in \mathcal{S}(\pi')$  that makes the dual choices of  $\mathcal{C}$  on additive connectives of  $B^\perp$ . This ensures no failure happens during the reduction of  $s \overset{B}{\bowtie} s'$ , which thus reduces to a slice of  $\rho$  (Lemma 5.5).

By hypothesis, call  $\tau$  a cut-free proof resulting from cut-elimination of  $\pi \overset{A}{\bowtie} \pi'$ , with  $\tau \overset{r^*}{\vdash} \text{id}_B$ . By Lemma 5.8, there is a (unique) slice of  $\text{id}_B$  with choices  $\mathcal{C}$  on  $B$  and dual choices  $\mathcal{C}^\perp$  on  $B^\perp$ . Applying Proposition 5.4, all proofs in the sequence  $\tau \overset{r^*}{\vdash} \text{id}_B$  have  $\top$ -rules with only 0 in their context; in particular, there cannot be any commutation involving a  $\top$ -rule in this sequence. Using Lemma 5.7, there is a slice  $t$  of  $\tau$  with choices  $\mathcal{C}$  and  $\mathcal{C}^\perp$ . According to Lemma 5.6, we have slices  $r \in \mathcal{S}(\pi)$  and  $r' \in \mathcal{S}(\pi')$  whose composition on  $A$  reduces to  $t$ . In particular,  $r$  makes choices  $\mathcal{C}$  on  $B$  and  $r'$  choices  $\mathcal{C}^\perp$  on  $B^\perp$ , as these choices are those in the resulting slice  $t$ , and no reversed cut-elimination step can modify them (a  $\top$ -cut

commutative case can erase such choices, but taking it in the other direction can only create choices). Therefore,  $r'$  makes on  $B^\perp$  the dual choices of  $s$  on  $B$ , and we can take such a slice as  $s'$ .  $\square$

Lemma 5.9 will be used to prove that any non- $ax$  rule  $r$  in  $\pi$  is not erased in all slices by  $\& - \oplus_i$  key cases during normalization. More precisely, taking a slice  $s$  containing  $r$ , of principal connective in, say  $A^\perp$ , the lemma gives a slice  $s' \in \mathcal{S}(\pi')$  that has no failure for a composition over  $B$ . As  $r$  does not introduce a cut formula, the only way for it to be erased during the reduction is by a  $\top - cut$  commutative case, in which case its principal formula becomes a sub-formula of the sequent on which a  $\top$ -rule is applied. This will be enough to conclude in our cases, as we know that the resulting normal form only has  $\top$ -rules of the shape  $\frac{}{\top, 0} \top$  (using Theorem 4.3 and Proposition 5.4).

**Remark 5.10.** Cut-free MALL proofs have the *sub-sequent property*: every sequent in such a proof is a sub-sequent of the conclusion sequent, as every rule respects this property, except the *cut*-rule.

**Lemma 5.11.** *Let  $r$  be a non- $ax$  rule in a cut-free slice  $s$  of conclusion  $\top, A$ , with the conclusion sequent of  $r$  of the shape  $\Sigma_\Gamma, \Sigma_A$  where  $\Sigma_\Gamma$  is a sub-sequent of  $\Gamma$  and  $\Sigma_A$  of  $A$ . Also assume the principal formula of  $r$  belongs to  $\Sigma_\Gamma$ , i.e. is not a sub-formula of  $A$ . Take  $s'$  a cut-free slice of conclusion  $\top, A^\perp, \Delta$  such that  $s \stackrel{A}{\bowtie} s'$  reduces to a cut-free slice  $s''$ . Then either there is in  $s''$  a rule of the same kind as  $r$ , applied on a sequent  $\top, \Theta$  with the same principal formula as  $r$ , or  $\Sigma_\Gamma$  is a sub-sequent of a  $\top$ -rule in  $s''$ , whose main  $\top$ -formula is not in  $\Sigma_\Gamma$ .*

*Proof.* By hypothesis,  $r$  does not introduce a *cut*-formula, for these formulas are sub-formulas of  $A$  or  $A^\perp$ . Therefore, the only reductions in  $s \stackrel{A}{\bowtie} s' \xrightarrow{\beta^*} s''$  that can erase a rule are  $\top - cut$  commutative cases, for the  $\&_i - \oplus_j$  key cases in the reduction do not lead to a failure. If no such erasure happens, then we are done: other cut commutative cases involving  $r$  may modify its conclusion sequent, but only in the part coming from  $A$ , thus  $\Sigma_\Gamma$  is preserved.

If a  $\top - cut$  reduction erases  $r$ , then  $\Sigma_\Gamma$  is in the context of the resulting  $\top$ -rule  $t$ , possibly as a sub-sequent. Furthermore, the principal  $\top$ -formula of  $t$  is not in  $\Sigma_\Gamma$ . This is enough to conclude, using an induction on the number of steps in  $s \stackrel{A}{\bowtie} s' \xrightarrow{\beta^*} s''$ . Notice that  $t$  may be erased too during the reduction but, like  $r$ , this would lead to  $\Sigma_\Gamma$  being a sub-sequent of the context of another  $\top$ -rule.  $\square$

**Lemma 5.12.** *If  $A \stackrel{\pi, \pi'}{\simeq} B$ , then all  $\top$ -rules in  $\pi$  and  $\pi'$  are of the form  $\frac{}{\top, 0} \top$ .*

*Proof.* Consider  $t$  a  $\top$ -rule  $\frac{}{\top, \Delta} \top$  in  $\pi$ , with  $\Gamma$  occurrences of sub-formulas of  $A^\perp$  and  $\Delta$  of  $B$  (as the cut-free  $\pi$  has for conclusion sequent is  $\top, A^\perp, B$ , see Remark 5.10). By symmetry, say the main  $\top$ -formula of  $t$  belongs to  $\Gamma$ , i.e. is a sub-formula of  $A^\perp$ . Call  $s$  a slice the  $\top$ -rule  $t$  belongs to.

Set  $\rho$  a normal form of  $\pi \stackrel{B}{\bowtie} \pi'$ . By Lemma 5.9, there exists a slice  $s' \in \mathcal{S}(\pi')$  such that  $s \stackrel{B}{\bowtie} s'$  reduces to a slice  $s'' \in \mathcal{S}(\rho)$ . By Lemma 5.11 applied to  $t$ ,  $t$  is either preserved and  $\Gamma$  as well, or  $t$  is absorbed by another  $\top$ -rule (during a  $\top - cut$  commutative case) and  $\Gamma$  stays in the context of a  $\top$ -rule, possibly as a sub-sequent. But by Theorem 4.3,  $\rho \stackrel{*}{\vdash} \text{id}_A$  and, by Proposition 5.4, the only  $\top$ -rules of  $\rho$ , and so of  $s''$ , are  $\frac{}{\top, 0} \top$  rules, with  $\top$  being the dual occurrence of  $0$ . Thus,  $\top$  and  $0$  are not both sub-formula of  $A^\perp$ , and it follows  $\Gamma$  is

either a sub-sequent of  $\top$  or one of  $0$ . For  $\Gamma$  contains  $\top$ , we conclude that  $\Gamma$  is  $\top$ . Moreover, it follows that  $t$  had not been erased during a  $\top$  – *cut* commutative case, using Lemma 5.11 (otherwise there would be at least two  $\top$ -formulas in the resulting  $\top$ -rule). This implies that  $\Delta$  cannot be empty: if it were,  $t$  could not commute with any *cut*-rule, as it could not do a  $\top$  – *cut* commutative case for it does not have a cut formula, which is a sub-formula of  $B$ , in its context, and no other cut-elimination step can change this. Thus, if  $\Delta$  were empty then  $t$  would be a rule of  $s''$ , impossible as it is a  $\frac{\top}{\top \top} \top$  rule.

Similarly, set  $\tau$  a normal form of  $\pi \stackrel{A}{\bowtie} \pi'$ . By Lemma 5.9 and Lemma 5.11,  $t$  is either preserved during the reduction (in a slice) and  $\Delta$  as well, or  $t$  is absorbed by another  $\top$ -rule and  $\Delta$  stays in the context of a  $\top$ -rule, possibly as a sub-sequent. But  $t$  cannot be preserved: its main formula is a sub-formula of  $A^\perp$ , and in  $\tau$  there are only occurrences of sub-formulas of  $B$  and  $B^\perp$ . Therefore,  $\Delta$  in  $\tau$  is in the context of a  $\top$ -rule, and does not contains its principal  $\top$ -formula. But by Theorem 4.3 and Proposition 5.4, the only  $\top$ -rules of  $\tau$  are  $\frac{\top}{\top \top, 0} \top$  rules, with  $\top$  being the dual occurrence of  $0$ . Hence,  $\Delta$  must be a sub-sequent of  $0$ . As  $\Delta$  cannot be empty,  $\Delta$  is  $0$ .

Thus, any  $\top$ -rule  $t$  in  $\pi$  (and  $\pi'$  by symmetry) is of the shape  $\frac{\top}{\top \top, 0} \top$ .  $\square$

**Lemma 5.13.** *Let  $\pi$  be an axiom-expanded proof whose  $\top$ -rules are all of the shape  $\frac{\top}{\top \top, 0} \top$ . There is a cut elimination strategy, of  $\pi$ , such that all  $\top$  – *cut* commutative cases are of the form:*

$$\frac{\frac{\top}{\top \top, 0} \top \quad \frac{\top}{\top \top, 0} \top}{\top \top, 0} \text{cut} \xrightarrow{\beta} \frac{\top}{\top \top, 0} \top$$

*Proof.* If a  $\top$  – *cut* commutative case can be applied, then the considered *cut*-rule is below a  $\frac{\top}{\top \top, 0} \top$ , with  $\top$  not the formula we cut on. But then  $0$  is the formula we cut on, so there is a  $\top$ -formula on the other premise; we are in the following situation:

$$\frac{\frac{\top}{\top \top, 0} \top \quad \frac{\phi}{\top \top, \Gamma} \text{cut}}{\top \top, \Gamma} \text{cut}$$

We commute non- $\top$ -rules of  $\phi$  with the *cut*-rule, until reaching the rule introducing the found  $\top$  (in each slice). This rule cannot be an *ax*-rule by hypothesis, so it is a  $\top$ -rule, of the given form. At this point, our sub-proof is:

$$\frac{\frac{\top}{\top \top, 0} \top \quad \frac{\top}{\top \top, 0} \top}{\top \top, 0} \text{cut}$$

We apply the  $\top$  – *cut* commutative case, obtaining  $\frac{\top}{\top \top, 0} \top$  as wished. For other reduction steps, one can do whatever, except doing an infinity of *cut* – *cut* commutative cases. This strategy terminates by Proposition A.17.  $\square$

**Lemma 5.14.** *If  $A \stackrel{\pi, \pi'}{\simeq} B$ , then there is no sequent of the shape  $\top D \& E$  in  $\pi$  (and  $\pi'$ ).*

*Proof.* Assume *w.l.o.g.*  $D \& E$  is a sub-formula of  $A^\perp$ , and let  $s$  be a slice containing the sequent  $\top D \& E$ . Pose  $\rho$  a normal form of  $\pi \stackrel{B}{\bowtie} \pi'$  obtained by following the strategy given by Lemma 5.13. By Lemma 5.9, there exists a slice  $s' \in \mathcal{S}(\pi')$  such that  $s \stackrel{B}{\bowtie} s'$  reduces to a slice  $s''$  of  $\rho$ . Since  $D \& E$  is a sub-formula of  $A^\perp$ , it is not a cut formula during the reduction, and the sequent  $\top D \& E$  remains in  $s''$ , so in  $\rho$ . Indeed, reducing cuts using

these steps preserves having the sequent  $\vdash D \& E$  (as there is no failure in the reduction). This is trivial for all steps except  $\top$  – *cut*. In the case a  $\top$  – *cut* step, by hypothesis on the reduction strategy, it cannot erase the sequent  $\vdash D \& E$  from the proof. Thus, the sequent  $\vdash D \& E$  belongs to  $\rho$ , which is equal to the identity up to rule commutations (Theorem 4.3). This is impossible by Proposition 5.4.  $\square$

**Lemma 5.15.** *If  $A \simeq^{\pi, \pi'} B$ , then all  $\perp$ -rules and 1-rules belong to  $1/\oplus/\perp$ -patterns.*

*Proof.* In  $\pi$ , we look at a possible rule  $r$  below a sequent  $\vdash \oplus[1]$  (see proof of Proposition 5.4 for the definition of  $\oplus[\_]$ ). It cannot be a  $\otimes$ -rule by distributivity, nor a  $\wp$ -rule for the sequent has a unique formula, nor a  $\&$ -rule due to Lemma 5.14. If  $r$  is a  $\oplus_i$ -rule, then we keep a sequent  $\vdash \oplus[1]$ , and if it is a  $\perp$ -rule then it is one of the required shape.

As a consequence, each 1-rule is followed by some  $\oplus_i$ -rules and possibly a  $\perp$ -rule; let us call a  $1/\oplus$ -*pattern* a 1-rule followed by a maximal such sequence of  $\oplus_i$ -rules. If a  $1/\oplus$ -pattern stops without a  $\perp$ -rule below it, we have only one formula in the conclusion sequent of the proof: impossible as  $\pi$  is a proof of  $\vdash A^\perp, B$ . Thus, the  $\perp$ -rule exists and to each 1-rule we can associate a  $\perp$ -rule leading to a  $1/\oplus/\perp$ -pattern. Henceforth, there are at least as many  $\perp$ -rules as 1-rules, and as the patterns they belong to have no  $\&$ -rule, this also holds in any slice.

Consider a slice  $s$  of  $\pi$ . By Lemma 5.9, there exists a slice  $s' \in \mathcal{S}(\pi')$  such that  $s \stackrel{B}{\boxtimes} s'$  reduces to a slice  $s''$  of  $\rho$ , the latter being a normal form of  $\pi \stackrel{B}{\boxtimes} \pi'$  obtained by following the strategy given by Lemma 5.13. Moreover,  $s''$  contains as many  $\perp$ -rules as 1-rules, as in  $\rho$  they belong to a  $1/\oplus/\perp$ -pattern (Theorem 4.3 and Proposition 5.4), so are in the same slices. Furthermore, in  $s''$ , each 1 from  $A$  (resp.  $A^\perp$ ) corresponds to a  $\perp$  from  $A^\perp$  (resp.  $A$ ).

Remark that, in the reduction  $s \stackrel{B}{\boxtimes} s' \xrightarrow{\beta^*} s''$ , the only steps that may erase a  $\perp$  or 1-rule are  $\perp - 1$  and  $\top$  – *cut* cases. But a  $\top$  – *cut* commutative case cannot erase non- $\top$ -rules by definition of our cut-elimination strategy. Furthermore, a  $\perp - 1$  key case erases one 1-rule and one  $\perp$ -rule. Therefore, with  $r_s$  the number of  $r$ -rules of a slice  $s$ , we have  $\perp_s + \perp_{s'} = 1_s + 1_{s'}$  as  $\perp_{s''} = 1_{s''}$  and any reduction step in  $s \stackrel{B}{\boxtimes} s' \xrightarrow{\beta^*} s''$  preserves this equality. But, by our analysis at the beginning of this proof,  $1_s \leq \perp_s$  and  $1_{s'} \leq \perp_{s'}$ . We conclude  $1_s = \perp_s$ , *i.e.* that  $s$  has as many  $\perp$ -rules than 1-rules.

However, each 1-rule, belonging to a  $1/\oplus/\perp$ -pattern, belongs to exactly the same slices as the corresponding  $\perp$ -rule of the pattern. Hence, a  $\perp$ -rule not in a  $1/\oplus/\perp$ -pattern would yield a slice  $s$  with strictly more  $\perp$ -rules than 1-rules (taking  $s$  any slice containing this  $\perp$ -rule). Thus, every  $\perp$ -rule belongs to a  $1/\oplus/\perp$ -pattern.  $\square$

**5.3. Completeness with units from unit-free completeness.** In the  $1/\oplus/\perp$ -patterns, moving each  $\perp$ -rule up to the associated 1-rule (which can be done up to  $\beta$ -equality by Proposition 4.1) allows us to consider units as fresh atoms introduced by  $ax$ -rules, whence reducing the problem to the unit-free fragment.

**Theorem 5.16** (Isomorphisms completeness from unit-free completeness). *If  $\mathcal{L}^\dagger$  is complete for isomorphisms in unit-free MALL, then  $\mathcal{L}$  is complete for isomorphisms in MALL (*i.e.*  $A \simeq B \implies A =_{\mathcal{L}} B$ ).*

*Proof.* Take  $A$  and  $B$  formulas in MALL (possibly with units) such that  $A \simeq B$ . We assume  $A$  and  $B$  to be distributed thanks to Proposition 5.3. It suffices to prove that  $A =_{\mathcal{L}^\dagger} B$ .



Suppose  $A \simeq^{\pi, \tau} B$  by Lemma 2.9. By Lemmas 5.12 and 5.15,  $\pi$  and  $\tau$  have  $\top$ -rules only of the shape  $\frac{\pi, \tau}{\vdash \top, 0} \top$  and  $\perp$  and 1-rules in  $1/\oplus/\perp$ -patterns. Using  $\perp$ -commutations to move each  $\perp$ -rule just below the 1-rule above it, we build  $\pi'$  and  $\tau'$  such that  $\pi'$  and  $\tau'$  have  $\top$ -rules only of the shape  $\frac{}{\vdash \top, 0} \top$ ,  $\perp$  and 1-rules of the form  $\frac{\frac{}{\vdash 1} 1}{\vdash \perp, 1} \perp$ ,  $\pi \stackrel{r^*}{\dashv} \pi'$  and  $\tau \stackrel{r^*}{\dashv} \tau'$ . Whence,  $\pi' \stackrel{B}{\boxtimes} \tau' \stackrel{r^*}{\dashv} \pi \stackrel{B}{\boxtimes} \tau$  and  $\pi' \stackrel{A}{\boxtimes} \tau' \stackrel{r^*}{\dashv} \pi \stackrel{A}{\boxtimes} \tau$ . By Proposition 4.1 and Theorem 4.3, for any normal form  $\rho$  of  $\pi' \stackrel{B}{\boxtimes} \tau'$  (resp.  $\pi' \stackrel{A}{\boxtimes} \tau'$ ),  $\rho \stackrel{r^*}{\dashv} \text{id}_A$  (resp.  $\rho \stackrel{r^*}{\dashv} \text{id}_B$ ).

We reduce cuts in  $\pi' \stackrel{B}{\boxtimes} \tau'$  (and similarly in  $\pi' \stackrel{A}{\boxtimes} \tau'$ ) following a particular strategy, ensuring that the proofs obtained during the reduction have  $\top$ -rules only of the shape  $\frac{}{\vdash \top, 0} \top$ , and  $\perp$  and 1-rules of the form  $\frac{\frac{}{\vdash 1} 1}{\vdash \perp, 1} \perp$ .

First, while we can apply a step of cut-elimination which is not a  $\top$ -cut,  $\perp$ -cut,  $\perp$ -1 or  $\text{cut}$ - $\text{cut}$  case, we do such a reduction step. These operations preserve that all  $\top$ -rules are applied on sequents  $\vdash \top, 0$  (up to exchange) and  $\perp$  and 1-rules are in the wished pattern.

If no such reduction is possible, consider a highest  $\text{cut}$ -rule, *i.e.* one with no  $\text{cut}$ -rule above it. The only possible cases that can be applied are  $\top$ -cut,  $\perp$ -cut or  $\perp$ -1.

- If a  $\top$ -cut commutative case can be applied, then the  $\text{cut}$ -rule is below a  $\top$ -rule, so necessarily one of its premises is  $\frac{}{\vdash \top, 0} \top$ , with  $\top$  not the formula we cut on. But then 0 is the formula we cut on, so there is a  $\top$ -formula on the other premise; we are in the following situation:

$$\frac{\frac{}{\vdash \top, 0} \top \quad \frac{\phi}{\top, \Gamma} r}{\vdash \top, \Gamma} \text{cut}$$

We prove the rule  $r$  above the premise  $\vdash \top, \Gamma$  of the  $\text{cut}$ -rule is the  $\top$ -rule corresponding to the cut formula  $\top$ . If it were not the case, then  $r$  commutes with the  $\text{cut}$ -rule. But  $r$  cannot be a  $\perp$ -rule (which cannot have a  $\top$ -formula in its context), nor a  $\top$ -rule corresponding to another  $\top$ -formula (because such a rule would have two  $\top$ -formulas in its conclusion). Thence,  $r$  is the  $\top$ -rule introducing the formula we cut on. Thus, our sub-proof is:

$$\frac{\frac{}{\vdash \top, 0} \top \quad \frac{}{\vdash \top, 0} \top}{\vdash \top, 0} \text{cut}$$

A  $\top$ -cut commutative case yields  $\frac{}{\vdash \top, 0} \top$  as if we had done an  $ax$  key case.

- If a  $\perp$ -cut commutative case can be applied, then the  $\text{cut}$ -rule is below a  $\perp$ -rule, so necessarily one of its premises is  $\frac{\frac{}{\vdash 1} 1}{\vdash \perp, 1} \perp$ , with  $\perp$  not the formula we cut on. But then 1 is the formula we cut on, so there is a  $\perp$ -formula on the other premise; we are in the following situation:

$$\frac{\frac{\frac{}{\vdash 1} 1}{\vdash \perp, 1} \perp \quad \frac{\phi}{\perp, \Gamma} r}{\vdash \perp, \Gamma} \text{cut}$$

We prove the rule  $r$  above the premise  $\vdash \perp, \Gamma$  of the  $\text{cut}$ -rule is the  $\perp$ -rule corresponding to the cut formula  $\perp$ . If it were not the case, then  $r$  commutes with the  $\text{cut}$ -rule. But  $r$  cannot be a  $\top$ -rule (which cannot have a  $\perp$ -formula in its context), nor a  $\perp$ -rule corresponding to another  $\perp$ -formula (because such a rule would have two  $\perp$ -formulas in its conclusion). Thence,  $r$  is the  $\perp$ -rule introducing the formula we cut on. Thus, our sub-proof is:

$$\frac{\frac{\overline{\vdash 1} \ 1}{\vdash \perp, 1} \perp \quad \frac{\overline{\vdash 1} \ 1}{\vdash \perp, 1} \perp}{\vdash \perp, 1} \text{cut}$$

We apply a  $\perp - \text{cut}$  commutative case, followed by a  $\perp - 1$  key case, obtaining  $\frac{\overline{\vdash 1} \ 1}{\vdash \perp, 1} \perp$  as if we had done an  $ax$  key case.

- No  $\perp - 1$  key case can be applied, for 1-rules have below them a  $\perp$ -rule, so not a  $\text{cut}$ -rule.

This strategy of reduction allows reaching a normal form  $\rho$ , with  $\top$ -rules only of the shape  $\frac{}{\vdash \top, 0} \top$ , and  $\perp$  and 1-rules of the form  $\frac{\overline{\vdash 1} \ 1}{\vdash \perp, 1} \perp$  (Proposition A.17).

Furthermore, call  $\sigma$  the substitution replacing  $\top, 0, \perp$  and 1-formulas respectively by  $X^\perp, X, Y^\perp$  and  $Y$ , for  $X$  and  $Y$  fresh atoms. We can reach  $\sigma(\rho)$  by cut-elimination from  $\sigma(\pi') \overset{\sigma(B)}{\bowtie} \sigma(\tau')$ , for the reductions we did on units could as well have been done by  $ax$ -key cases: no  $\perp - \text{cut}$ , nor  $\perp - 1$ , nor  $\top - \text{cut}$  case were used, except for cases that could be simulated using  $ax$ -key cases. Moreover,  $\sigma(\text{id}_A) = \text{id}_{\sigma(A)}$ , and in  $\rho \overset{r^*}{\vdash} \text{id}_A$  we can assume not to commute any  $\perp$ -rule because we start and end with 1-rules and  $\perp$ -rules in  $\frac{\overline{\vdash 1} \ 1}{\vdash \perp, 1} \perp$  shapes only, and such commutations could only move the  $\perp$ -rule below or above some  $\oplus_i$ -rules according to Proposition 5.4. Thus,  $\sigma(\rho) \overset{r^*}{\vdash} \text{id}_{\sigma(A)}$ . Using Proposition 4.1, it follows  $\sigma(\rho) =_{\beta\eta} \text{id}_{\sigma(A)}$ , and therefore  $\sigma(\pi') \overset{\sigma(B)}{\bowtie} \sigma(\tau') =_{\beta\eta} \text{ax}_{\sigma(A)}$  with  $\text{ax}_{\sigma(A)}$  the  $ax$ -rule on  $\sigma(A)$ . A similar result holding for a cut over  $A$ , we have  $\sigma(A) \simeq \sigma(B)$ , these formulas being unit-free. For we assume  $\mathcal{L}^\dagger$  to be complete for unit-free isomorphisms, this yields  $\sigma(A) =_{\mathcal{L}^\dagger} \sigma(B)$ . We conclude  $A =_{\mathcal{L}^\dagger} B$  by substituting  $X$  by 0 and  $Y$  by 1, as  $X$  and  $Y$  were fresh.  $\square$

## 6. PROOF-NETS FOR UNIT-FREE MALL

We will at present change the syntax, no longer considering sequent calculus proofs but *proof-nets*, choosing the syntax from Hughes & Van Glabbeek for unit-free MALL [HvG05]. A key property of proof-nets is to be a more canonical representation of proofs, as they define a quotient of sequent calculus proofs up to rule commutations [HvG16] (we recall Tables 5 and 6 on Pages 9 and 10 give rule commutations).<sup>2</sup> This yields better properties concerning the study of isomorphisms. As a key example, cut-elimination in proof-nets is confluent and leads to a unique normal form. This spares us tedious case studies on rule commutations – like the one in the proof of Proposition 5.4, which was due to the need to relate the different possible cut-free proofs obtained by cut-elimination. Thus, studying isomorphisms using proof-nets will be less complex. Nonetheless, we leave an inductive definition to a graphical syntax. It would have been ideal to use this syntax from the very beginning. Unfortunately, this was not possible as no notion of proof-nets, with exact quotient on normal forms, exists with units at the time this article is written.

Other definitions of proof-nets exist, see the original one from Girard [Gir96], or others such as [DG11, HH16]. Still, the definition we take is one of the most satisfactory, from the point of view of canonicity and cut-elimination for instance (see [HvG05, HvG16], or

<sup>2</sup>While the definition of rule commutations in [HvG16] differs a little from ours, for they also consider commutations involving a  $\text{cut}$ -rule, both definitions coincide on cut-free proof-nets, which are the objects we want canonical.

the introduction of [HH16] for a comparison of alternative definitions). We recall here this definition of proof-nets, and define composition by cut and cut-elimination for this syntax. Please refer to [HvG05] for more details, as well as the intuitions behind the definition.

In all that follows, as we use proof-nets, we consider only the unit-free fragment of MALL, unless stated otherwise.

**6.1. Proof-net.** A sequent is seen as its syntactic forest, with as internal vertices its connectives and as leaves the atoms of its formulas. We always identify a formula  $A$  with its syntactic tree  $T(A)$ . A *cut pair* is a formula  $A * A^\perp$ , given a formula  $A$ ; the connective  $*$  is unordered. A *cut sequent*  $[\Sigma] \Gamma$  is composed of a list  $\Sigma$  of cut pairs and a sequent  $\Gamma$ . When  $\Sigma = \emptyset$  is empty, we denote it simply by  $\Gamma$ . For instance,  $[X_5 * X_6^\perp] X_1 \& X_2^\perp, X_3 \oplus X_4^\perp$  (where each  $X_i$  is an occurrence of the same atom  $X$ ) is a cut sequent, on which we will instantiate the concepts defined in this part.

An *additive resolution* of a cut sequent  $[\Sigma] \Gamma$  is any result of deleting zero or more cut pairs from  $\Sigma$  and one argument sub-tree of each additive connective ( $\&$  or  $\oplus$ ) of  $\Sigma \cup \Gamma$ . A *&-resolution* of a cut sequent  $[\Sigma] \Gamma$  is any result of deleting one argument sub-tree of each  $\&$ -connective of  $\Sigma \cup \Gamma$ . For example,  $[\ ] X_1 \& , \oplus X_4^\perp$  is one of the eight additive resolutions of  $[X_5 * X_6^\perp] X_1 \& X_2^\perp, X_3 \oplus X_4^\perp$ , while  $[X_5 * X_6^\perp] X_1 \& , X_3 \oplus X_4^\perp$  is one of its two  $\&$ -resolutions. Notice the difference on cut pairs: they may be deleted in an additive resolution, but never in a  $\&$ -resolution.

An (*axiom*) *link* on  $[\Sigma] \Gamma$  is an unordered pair of complementary leaves in  $\Sigma \cup \Gamma$  (labeled with  $X$  and  $X^\perp$  for some atom  $X$ ). A *linking*  $\lambda$  on  $[\Sigma] \Gamma$  is a set of links on  $[\Sigma] \Gamma$  such that the set of the leaves of its links forms a partition of the set of leaves of an additive resolution of  $[\Sigma] \Gamma$ , additive resolution which is denoted  $[\Sigma] \Gamma \uparrow \lambda$ . For instance, on the left-most graph of Figure 2, the red axiom links form a linking  $\lambda_1 = \{(X_1, X_6^\perp); (X_4^\perp, X_5)\}$ , whose additive resolution is  $[X_5 * X_6^\perp] X_1 \& X_2^\perp, X_3 \oplus X_4^\perp \uparrow \lambda_1 = [X_5 * X_6^\perp] X_1 \& , \oplus X_4^\perp$ .

Note the relation between slices in the sequent calculus and linkings in proof-nets: a slice “belongs” to an additive resolution, and a  $\&$ -resolution “selects” a slice from a proof.

A set of linkings  $\Lambda$  on  $[\Sigma] \Gamma$  *toggles* a  $\&$ -vertex  $W$  if both arguments (called *premises*) of  $W$  are in  $[\Sigma] \Gamma \uparrow \Lambda := \bigcup_{\lambda \in \Lambda} [\Sigma] \Gamma \uparrow \lambda$ . We say a link  $a$  *depends* on a  $\&$ -vertex  $W$  in  $\Lambda$  if there exist  $\lambda, \lambda' \in \Lambda$  such that  $a \in \lambda \setminus \lambda'$  and  $W$  is the only  $\&$ -vertex toggled by  $\{\lambda; \lambda'\}$ . Looking at our running example, and taking  $\lambda_1 = \{(X_1, X_6^\perp), (X_4^\perp, X_5)\}$  and  $\lambda_2 = \{(X_2^\perp, X_3)\}$ , the  $\&$ -vertex is toggled by  $\{\lambda_1; \lambda_2\}$ . Furthermore, all links depend on this  $\&$ -vertex for  $\lambda_1$  and  $\lambda_2$  contain only different pairs.

The graph  $\mathcal{G}_\Lambda$  is defined as  $[\Sigma] \Gamma \uparrow \Lambda$  with the edges from  $\bigcup \Lambda$  and enriched with jump edges  $l \rightarrow W$  for each leaf  $l$  and each  $\&$ -vertex  $W$  such that there exists  $a \in \lambda \in \Lambda$ , between  $l$  and some  $l'$ , with  $a$  depending on  $W$  in  $\Lambda$ . When  $\Lambda = \{\lambda\}$  is composed of a single linking, we shall simply denote  $\mathcal{G}_\lambda = \mathcal{G}_{\{\lambda\}}$  (which is the graph  $[\Sigma] \Gamma \uparrow \lambda$  with the edges from  $\lambda$  and no jump edge). For our example, the graphs  $\mathcal{G}_{\lambda_1}$ ,  $\mathcal{G}_{\lambda_2}$  and  $\mathcal{G}_{\{\lambda_1; \lambda_2\}}$  are illustrated on Figure 2.

In the text of this paper (but not on the graphs), we write  $l \xrightarrow{j} W$  for a jump edge from a leaf  $l$  to a  $\&$ -vertex  $W$ . When drawing proof-nets, we will denote membership of a linking by means of colors.

When we write a  $\wp \setminus \&$ -vertex, we mean a  $\wp$ - or  $\&$ -vertex (a *negative* vertex); similarly a  $\otimes \setminus \oplus$ -vertex is a  $\otimes$ - or  $\oplus$ -vertex (a *positive* vertex). A *switch edge* of a  $\wp \setminus \&$ -vertex  $N$  is an in-edge of  $N$ , *i.e.* an edge between  $N$  and one of its premises or a jump to  $N$ . A *switching cycle* is a cycle with at most one switch edge of each  $\wp \setminus \&$ -vertex. A  $\wp$ -*switching* of a linking

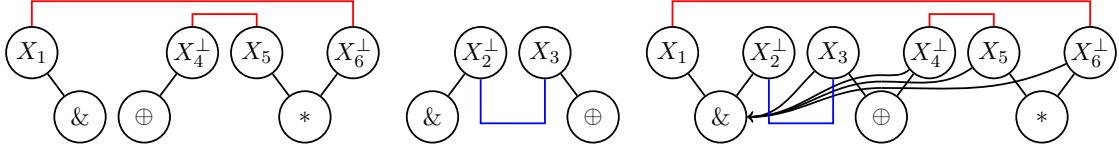

Figure 2: Graphs from an example of a proof-net: from left to right  $\mathcal{G}_{\lambda_1}$ ,  $\mathcal{G}_{\lambda_2}$  and  $\mathcal{G}_{\{\lambda_1; \lambda_2\}}$

$\lambda$  is any subgraph of  $\mathcal{G}_\lambda$  obtained by deleting a switch edge of each  $\mathfrak{A}$ -vertex; denoting by  $\phi$  this choice of edges, the subgraph it yields is  $\mathcal{G}_\phi$ . For example, a cycle in a  $\mathfrak{A}$ -switching is a switching cycle, as in a graph  $\mathcal{G}_\phi$  all  $\mathfrak{A}\backslash\&$ -vertices have one premise.

**Definition 6.1** (Proof-net). A *unit-free MALL proof-net*  $\theta$  on a cut sequent  $[\Sigma] \Gamma$  is a set of linkings satisfying:

(P0) *Cut*: Every cut pair of  $\Sigma$  has a leaf in  $\theta$ .

(P1) *Resolution*: Exactly one linking of  $\theta$  is on any given  $\&$ -resolution of  $[\Sigma] \Gamma$ .

(P2) *MLL*: For every  $\mathfrak{A}$ -switching  $\phi$  of every linking  $\lambda \in \theta$ ,  $\mathcal{G}_\phi$  is a tree.

(P3) *Toggling*: Every set  $\Lambda \subseteq \theta$  of two or more linkings toggles a  $\&$ -vertex that is in no switching cycle of  $\mathcal{G}_\Lambda$ .

These conditions are called the *correctness criterion*. Condition (P0) is here to prevent unused  $*$ -vertices. A *cut-free* proof-net is one without  $*$ -vertices (it respects (P0) trivially). Condition (P1) is a correctness criterion for additive proof-nets [HvG05] and (P2) is the Danos-Regnier criterion for multiplicative proof-nets [DR89]. However, (P1) and (P2) together are insufficient for cut-free MALL proof-nets, hence the last condition (P3) taking into account interactions between the slices (see also [DG11] for a similar condition for example). Sets composed of a single linking  $\lambda$  are not considered in (P3), for by (P2) the graph  $\mathcal{G}_\lambda$  has no switching cycle. One can check that our example on Figure 2,  $\{\lambda_1; \lambda_2\}$ , is a proof-net.

In the particular setting of isomorphisms, we mainly consider proof-nets with two conclusions. This allows to define a notion of duality on leaves and connectives. Consider a cut sequent containing both  $A$  and  $A^\perp$ . For  $V$  a vertex in (the syntactic tree  $T(A)$  of)  $A$ , we denote by  $V^\perp$  the corresponding vertex in  $A^\perp$ . As expected,  $V^{\perp\perp} = V$ . This also respects orthogonality for formulas on leaves: given a leaf  $l$  of  $A$ , labeled by a formula  $X$ , the label of  $l^\perp$  is  $X^\perp$ . We can also define a notion of duality on premises: given a premise of a vertex  $V \in T(A)$ , the dual premise of  $V^\perp$  is the corresponding premise in  $T(A^\perp)$ . In other words, if in  $L - V - R$  we consider the premise  $L$  then in  $R^\perp - V^\perp - L^\perp$  its dual premise is  $L^\perp$ .

## 6.2. Cut-elimination in proof-nets.

**Definition 6.2** (Composition). For proof-nets  $\theta$  and  $\psi$  of respective conclusions  $[\Sigma] \Gamma, A$  and  $[\Xi] \Delta, A^\perp$ , the *composition* over  $A$  of  $\theta$  and  $\psi$  is the proof-net  $\theta \stackrel{A}{\bowtie} \psi = \{\lambda \cup \mu \mid \lambda \in \theta, \mu \in \psi\}$ , with conclusions  $[\Sigma, \Xi, A * A^\perp] \Gamma, \Delta$ .

For example, see Figure 8 with a composition of the proof-nets on Figure 6.

**Definition 6.3** (Cut-elimination). Let  $\theta$  be a set of linkings on a cut sequent  $[\Sigma] \Gamma$ , and  $A * A^\perp$  a cut pair in  $\Sigma$ . Define the *elimination* of  $A * A^\perp$  (or of the cut  $*$  between  $A$  and  $A^\perp$ ) as:

- (a) If  $A$  is an atom, delete  $A * A^\perp$  from  $\Sigma$  and replace any pair of links  $(l, A)$ ,  $(A^\perp, m)$  ( $l$  and  $m$  being other occurrences of  $A^\perp$  and  $A$  respectively) with the link  $(l, m)$ .
- (b) If  $A = A_1 \otimes A_2$  and  $A^\perp = A_2^\perp \wp A_1^\perp$  (or vice-versa), replace  $A * A^\perp$  with two cut pairs  $A_1 * A_1^\perp$  and  $A_2 * A_2^\perp$ . Retain all original linkings.
- (c) If  $A = A_1 \& A_2$  and  $A^\perp = A_2^\perp \oplus A_1^\perp$  (or vice-versa), replace  $A * A^\perp$  with two cut pairs  $A_1 * A_1^\perp$  and  $A_2 * A_2^\perp$ . Delete all *inconsistent* linkings, namely those  $\lambda \in \theta$  such that in  $[\Sigma] \Gamma \uparrow \lambda$  the children  $\&$  and  $\oplus$  of the cut do not take dual premises. Finally, “garbage collect” by deleting any cut pair  $B * B^\perp$  for which no leaf of  $B * B^\perp$  is in any of the remaining linkings.

See Figure 9 for a result on applying steps (b) and (c) to the proof-net of Figure 8. We use for proof-nets the same notations  $\xrightarrow{\beta}$  and  $=_\beta$  as for the sequent calculus.

**Proposition 6.4** (Proposition 5.4 in [HvG05]). *Eliminating a cut in a proof-net yields a proof-net.*

**Theorem 6.5** (Theorem 5.5 in [HvG05]). *Cut-elimination of proof-nets is strongly normalizing and confluent.*

A linking  $\lambda$  on a cut sequent  $[\Sigma] \Gamma$  *matches* if, for every cut pair  $A * A^\perp$  in  $\Sigma$ , any given leaf  $l$  of  $A$  is in  $[\Sigma] \Gamma \uparrow \lambda$  if and only if  $l^\perp$  of  $A^\perp$  is in  $[\Sigma] \Gamma \uparrow \lambda$ . A linking matches if and only if, when cut-elimination is carried out, the linking never becomes inconsistent, and thus is never deleted. This allows defining *Turbo Cut-elimination* [HvG05], eliminating a cut in a single step by removing inconsistent linkings.

## 7. REDUCTION TO PROOF-NETS

The goal of this section is to shift the study of isomorphisms to the syntax of proof-nets, never to speak of sequent calculus again. We do so by first defining *desequentialization*, a function from sequent calculus proofs to proof-nets (Section 7.1). We then show that cut-elimination in proof-nets simulates the one from sequent calculus (Section 7.2). Finally, we define isomorphisms directly in the syntax of proof-nets (Section 7.3). Recall that all sequent calculus proofs we consider have expanded axioms, thanks to Proposition 3.3.

**7.1. Desequentialization.** We desequentialize a unit-free MALL proof  $\pi$  (with expanded axioms) into a set of linkings  $\mathcal{R}(\pi)$  by induction on  $\pi$ :

$$\begin{array}{c}
\frac{}{\{\{(X, X^\perp)\}\} \triangleright [\emptyset] X, X^\perp} ax \qquad \frac{\theta \triangleright [\Sigma] \Gamma}{\theta \triangleright [\Sigma] \sigma(\Gamma)} ex \\
\\
\frac{\theta \triangleright [\Sigma] A, \Gamma \quad \psi \triangleright [\Xi] A^\perp, \Delta}{\{\lambda \cup \mu \mid \lambda \in \theta, \mu \in \psi\} \triangleright [\Sigma, \Xi, A * A^\perp] \Gamma, \Delta} cut \\
\\
\frac{\theta \triangleright [\Sigma] A, \Gamma \quad \psi \triangleright [\Xi] B, \Delta}{\{\lambda \cup \mu \mid \lambda \in \theta, \mu \in \psi\} \triangleright [\Sigma, \Xi] A \otimes B, \Gamma, \Delta} \otimes \qquad \frac{\theta \triangleright [\Sigma] A, B, \Gamma}{\theta \triangleright [\Sigma] A \wp B, \Gamma} \wp \\
\\
\frac{\theta \triangleright [\Xi] A, \Gamma \quad \psi \triangleright [\Phi] B, \Gamma}{\theta \cup \psi \triangleright [\Xi, \Phi] A \& B, \Gamma} \& \qquad \frac{\theta \triangleright [\Sigma] A, \Gamma}{\theta \triangleright [\Sigma] A \oplus B, \Gamma} \oplus_1 \qquad \frac{\theta \triangleright [\Sigma] B, \Gamma}{\theta \triangleright [\Sigma] A \oplus B, \Gamma} \oplus_2
\end{array}$$

This definition uses the implicit tracking of formula occurrences downwards through the rules, and follows [HvG05] with the notation  $\theta \triangleright [\Sigma] \Gamma$  for “ $\theta$  is a set of linkings on the cut sequent  $[\Sigma] \Gamma$ ”. As identified in Section 5.3.4 of [HvG05], desequentializing with both *cut* and  $\&$ -rules is complex, for cuts can be shared (or not) when translating a  $\&$ -rule:  $\frac{\theta \triangleright [\Sigma, \Xi] A, \Gamma \quad \psi \triangleright [\Sigma, \Phi] B, \Gamma}{\theta \cup \psi \triangleright [\Sigma, \Xi, \Phi] A \& B, \Gamma} \&$ . We choose to never share cuts ( $\Sigma = \emptyset$ ),

thus desequentialization is a function. The cost being that the following  $\&$  – *cut* commutation yields different proof-nets (contrary to the other commutations, see [HvG16]).

$$\frac{\frac{\frac{\pi_1}{\vdash A, B, \Gamma} \quad \frac{\pi_2}{\vdash A, C, \Gamma}}{\vdash A, B \& C, \Gamma} \& \quad \frac{\pi_3}{\vdash A^\perp, \Delta} \text{cut}}{\vdash B \& C, \Gamma, \Delta} \text{cut} \quad \equiv \quad \frac{\frac{\pi_1}{\vdash A, B, \Gamma} \quad \frac{\pi_3}{\vdash A^\perp, \Delta} \text{cut}}{\vdash B, \Gamma, \Delta} \text{cut} \quad \frac{\frac{\pi_2}{\vdash A, C, \Gamma} \quad \frac{\pi_3}{\vdash A^\perp, \Delta} \text{cut}}{\vdash C, \Gamma, \Delta} \text{cut}}{\vdash B \& C, \Gamma, \Delta} \&$$

**Remark 7.1.** An alternative definition of desequentialization in [HvG05] consists in building a linking by slice. In this spirit, if a proof-net  $\theta$  is obtained by desequentializing a proof  $\pi$ , there is a bijection between linkings in  $\theta$  and slices of  $\pi$ .

**Theorem 7.2** (Sequentialization, Theorem 5.9 in [HvG05]). *A set of linkings on a cut sequent is a translation of a unit-free MALL proof if and only if it is a proof-net.*

**Definition 7.3** (Identity proof-net). We call *identity proof-net* of a unit-free formula  $A$ , the proof-net corresponding to the proof  $\text{id}_A$  (the axiom-expansion of  $\text{ax}_A = \frac{}{\vdash A^\perp, A} \text{ax}$ ).

**7.2. Simulation of cut elimination.** We show here that cut elimination in proof-nets mimic the one in sequent calculus, which will allow us in the next section to consider isomorphisms on proof-nets only. As written in Section 7.1, proof-nets have difficulties with the  $\&$  – *cut* commutation, which corresponds to superimposing  $*$ -vertices.

**Definition 7.4** ( $\triangleleft$ ). Let  $\theta$  and  $\psi$  be proof-nets. We denote  $\theta \triangleleft \psi$  if there exists a  $*$ -vertex  $C$  in  $\theta$  such that the syntactic forest of  $\psi$  is the syntactic forest of  $\theta$  where the syntactic tree of  $C$  is duplicated into the syntactic trees of  $C_0$  and  $C_1$  (which are different occurrences of  $C$ ),  $\theta = \theta_0 \sqcup \theta_1^3$  and  $\psi = \psi_0 \sqcup \psi_1$  with, for  $i \in \{0; 1\}$ ,  $\psi_i = \theta_i$  up to assimilating  $C_i$  with  $C$ .

See Figure 3 for a graphical representation of this concept, as well as the link with the  $\&$  – *cut* commutative case of cut-elimination.

**Lemma 7.5** (Simulation -  $\beta$ ). *Let  $\pi$  and  $\pi'$  be unit-free MALL proof trees such that  $\pi \xrightarrow{\beta} \pi'$ . Then either  $\mathcal{R}(\pi) = \mathcal{R}(\pi')$ ,  $\mathcal{R}(\pi) \triangleleft \mathcal{R}(\pi')$  or  $\mathcal{R}(\pi) \xrightarrow{\beta} \mathcal{R}(\pi')$ .*

*Proof.* We reason by cases according to the step  $\pi \xrightarrow{\beta} \pi'$ . Recall we desequentialize by separating all cuts, and use the notations for steps from Definition 6.3. If  $\pi \xrightarrow{\beta} \pi'$  is an *ax* (resp.  $\wp - \otimes$ ,  $\& - \oplus$ ) key case, then using a step (a) (resp. (b), (c)), we get  $\mathcal{R}(\pi) \xrightarrow{\beta} \mathcal{R}(\pi')$ . If it is a  $\wp - \text{cut}$ ,  $\otimes - \text{cut} - 1$ ,  $\otimes - \text{cut} - 2$ ,  $\oplus_1 - \text{cut}$  or  $\oplus_2 - \text{cut}$  commutative case, then  $\mathcal{R}(\pi) = \mathcal{R}(\pi')$ . Finally, in a  $\& - \text{cut}$  commutative case, we duplicate the *cut*-rule:  $\mathcal{R}(\pi) \triangleleft \mathcal{R}(\pi')$  (see Figure 3).  $\square$

Nonetheless, the  $\triangleleft$  relation is not a hard problem since two proofs differing by a  $\&$  – *cut* commutation yield proof-nets equal up to cut-elimination.

<sup>3</sup>The symbol  $\sqcup$  means a union  $\cup$  which happens to be between disjoint sets.

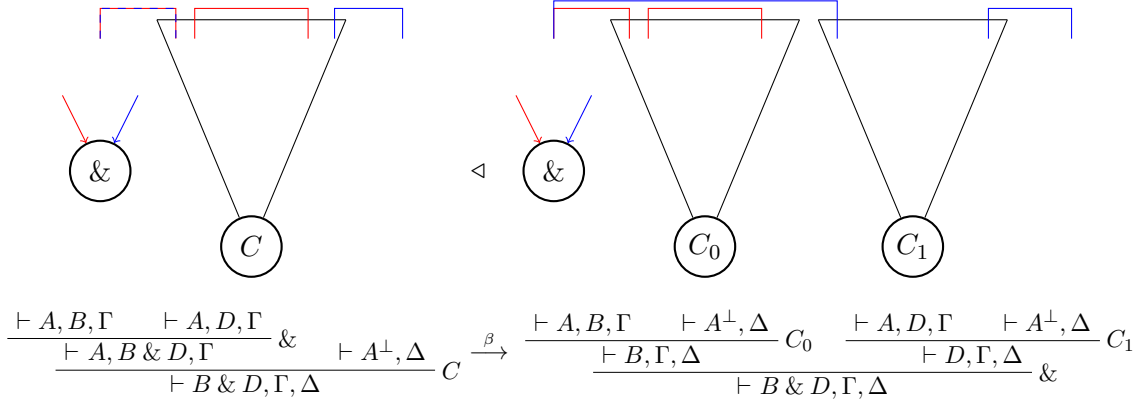

Figure 3: Illustration of  $\triangleleft$  (Definition 7.4) and parallel with the  $\&$  – cut cut-elimination

**Lemma 7.6** ( $\triangleleft \subseteq =_\beta$ ). *Let  $\theta$  and  $\theta'$  be proof-nets such that  $\theta \triangleleft \theta'$ . Then  $\theta =_\beta \theta'$ .*

*Proof.* By Definition 7.4 of  $\triangleleft$ , there exists a  $*$ -vertex  $C$  in  $\theta$ , with  $\theta = \theta_0 \sqcup \theta_1$ , such that  $\theta'$  is  $\theta$  where the syntactic tree of  $C$  is duplicated into  $C_0$  and  $C_1$ , and linkings in  $\theta_0$  (respectively  $\theta_1$ ) use  $C_0$  (respectively  $C_1$ ) as  $C$ .

We reason by induction on the size of the formula  $A$  of  $C$  (and also  $C_0$  and  $C_1$ ); *w.l.o.g.*  $A$  is positive. Applying a step of cut-elimination on  $C$  in  $\theta$  yields a proof-net  $\Theta$ . On the other hand, a corresponding step of cut-elimination on  $C_0$  and one on  $C_1$  in  $\theta'$  yields  $\Theta'$ .

If  $A$  is an atom, then we applied step (a), and we find  $\Theta = \Theta'$ .

If  $A$  is a  $\otimes$ -formula, *i.e.*  $A = A_0 \otimes A_1$ , then we applied step (b) and produced cuts  $A_0 * A_0^\perp$  and  $A_1 * A_1^\perp$  in  $\Theta$ , and two occurrences of these cuts in  $\Theta'$ . Thus,  $\Theta \triangleleft \Xi \triangleleft \Theta'$  with  $\Xi$  the proof-net  $\Theta$  where the cut on  $A_0$  is duplicated. By induction hypothesis,  $\Theta =_\beta \Xi =_\beta \Theta'$ .

It follows  $\theta =_\beta \theta'$  as  $\theta \xrightarrow{\beta} \Theta =_\beta \Theta' \xleftarrow{\beta} \cdot \xleftarrow{\beta} \theta'$ .

Finally, if  $A$  is a  $\oplus$ -formula with  $A = A_0 \oplus A_1$ , then we used step (c), producing cuts  $A_0 * A_0^\perp$  and  $A_1 * A_1^\perp$  in  $\Theta$ , and two occurrences of these cuts in  $\Theta'$ . Remark that inconsistent linkings in  $\theta'$  for these steps are exactly those of  $\theta$ , and therefore the same cuts are garbage collected. Whence,  $\Theta \triangleleft \cdot \triangleleft \Theta'$ ,  $\Theta \triangleleft \Theta'$  or  $\Theta = \Theta'$  (according to the number of cuts garbage collected). In all cases, using the induction hypothesis we conclude  $\theta =_\beta \theta'$ .  $\square$

**Remark 7.7.** Another proof of Lemma 7.6, using the Turbo Cut-elimination procedure and no induction, is possible. We use the Turbo Cut-elimination procedure on  $C$  in  $\theta$ , yielding a proof-net  $\Theta$ ; we also use it in  $\theta'$  on  $C_0$  then  $C_1$ , yielding  $\Theta'$ . Whence,  $\theta \xrightarrow{\beta^*} \Theta$  and  $\Theta' \xleftarrow{\beta^*} \theta'$ . It stays to prove that  $\Theta = \Theta'$ . Remark that  $\Theta$  and  $\Theta'$  can only differ by their linkings, for they have the same syntactic forest. Notice that a linking in  $\theta_i$ ,  $i \in \{0; 1\}$ , matches for  $C$  in  $\theta$  if and only if it matches for  $C_i$  in  $\theta'$ , because this linking uses  $C_i$  as  $C$ . Thence, the same linkings stay in  $\Theta$  and  $\Theta'$ , and  $\Theta = \Theta'$  follows.

**Theorem 7.8** (Simulation Theorem). *Let  $\pi$  and  $\pi'$  be unit-free MALL proof trees with expanded axioms. If  $\pi =_\beta \pi'$ , then  $\mathcal{R}(\pi) =_\beta \mathcal{R}(\pi')$ .*

*Proof.* This is a corollary of Lemmas 7.5 and 7.6.  $\square$

We call  $\mathcal{B}(\theta)$  the  $\beta$ -normal form of the proof-net  $\theta$ , with all cuts eliminated (thanks to Proposition 6.4 and Theorem 6.5).

**Lemma 7.9.** *Let  $\pi$ ,  $\tau$  and  $\rho$  be unit-free MALL proof trees of respective sequents  $\vdash A, \Gamma$ ,  $\vdash A^\perp, \Delta$  and  $\vdash \Gamma, \Delta$ , with expanded axioms. Assume  $\pi \stackrel{A}{\bowtie} \tau =_\beta \rho$ . Then  $\mathcal{B}(\mathcal{R}(\pi)) \stackrel{A}{\bowtie} \mathcal{B}(\mathcal{R}(\tau))$  reduces, after fully eliminating the cut on  $A$ , to  $\mathcal{B}(\mathcal{R}(\rho))$ .*

*Proof.* By the Simulation Theorem (Theorem 7.8),  $\mathcal{R}(\pi \stackrel{A}{\bowtie} \tau) =_\beta \mathcal{R}(\rho)$ . By definition of  $\mathcal{R}$  (Section 7),  $\mathcal{R}(\pi \stackrel{A}{\bowtie} \tau) = \mathcal{R}(\pi) \stackrel{A}{\bowtie} \mathcal{R}(\tau)$ , so  $\mathcal{B}(\mathcal{R}(\pi) \stackrel{A}{\bowtie} \mathcal{R}(\tau)) = \mathcal{B}(\mathcal{R}(\rho))$ . Moreover, by confluence of cut-elimination (Theorem 6.5),  $\mathcal{B}(\mathcal{R}(\pi) \stackrel{A}{\bowtie} \mathcal{R}(\tau))$  can be obtained by taking the  $\beta$ -normal forms of  $\mathcal{R}(\pi)$  and  $\mathcal{R}(\tau)$ , composing them over  $A$  and reducing this cut. In other words,  $\mathcal{B}(\mathcal{B}(\mathcal{R}(\pi)) \stackrel{A}{\bowtie} \mathcal{B}(\mathcal{R}(\tau))) = \mathcal{B}(\mathcal{R}(\pi) \stackrel{A}{\bowtie} \mathcal{R}(\tau)) = \mathcal{B}(\mathcal{R}(\rho))$ , and the result follows.  $\square$

**7.3. Isomorphisms in proof-nets.** A notion of isomorphism  $A \simeq B$  can be defined directly on proof-nets:  $\theta$  and  $\psi$  are two cut-free proof-nets of respective conclusions  $A^\perp, B$  and  $B^\perp, A$  such that  $\theta \stackrel{B}{\bowtie} \psi$  and  $\psi \stackrel{A}{\bowtie} \theta$  reduce by cut-elimination to identity proof-nets. Using previous results, we obtain:

**Theorem 7.10** (Type isomorphisms in proof-nets). *Let  $A$  and  $B$  be two unit-free MALL formulas. If  $A \simeq B$  then there exist two proof-nets  $\theta$  and  $\psi$  such that  $A \stackrel{\theta, \psi}{\simeq} B$ .*

*Proof.* Using Lemma 2.9 followed by Proposition 3.3, there exist unit-free MALL cut-free proofs with expanded axioms  $\pi$  and  $\tau$ , respectively of  $\vdash A^\perp, B$  and  $\vdash B^\perp, A$ , such that  $\pi \stackrel{B}{\bowtie} \tau =_\beta \text{id}_A$  and  $\tau \stackrel{A}{\bowtie} \pi =_\beta \text{id}_B$ . By Lemma 7.9 and as  $\mathcal{R}(\text{id}_A)$ ,  $\mathcal{R}(\pi)$  and  $\mathcal{R}(\tau)$  are cut-free,  $\mathcal{B}(\mathcal{R}(\pi) \stackrel{B}{\bowtie} \mathcal{R}(\tau)) = \mathcal{R}(\text{id}_A)$ . Similarly,  $\mathcal{B}(\mathcal{R}(\tau) \stackrel{A}{\bowtie} \mathcal{R}(\pi)) = \mathcal{R}(\text{id}_B)$ . Thus, there exist cut-free proof-nets  $\mathcal{R}(\pi)$  and  $\mathcal{R}(\tau)$  whose composition over  $B$  (resp.  $A$ ) yields after cut-elimination the identity proof-net of  $A$  (resp.  $B$ ).  $\square$

**Remark 7.11.** The converse of Theorem 7.10 holds. Indeed, the goal of the next section is to prove  $A \stackrel{\theta, \psi}{\simeq} B \implies A =_{\mathcal{L}^\dagger} B$ . Therefore, using Theorem 2.11 and Theorem 7.10:

$$A =_{\mathcal{L}^\dagger} B \implies A \simeq B \implies A \stackrel{\theta, \psi}{\simeq} B \implies A =_{\mathcal{L}^\dagger} B$$

## 8. COMPLETENESS

Our method relates closely to the one used by Balat and Di Cosmo in [BDC99], with some more work due to the distributivity isomorphisms. We work on proof-nets, as they highly simplify the problem by representing proofs up to rule commutations [HvG16]. We start by studying identity proof-nets (Section 8.1), then prove isomorphisms yield proof-nets of a particular shape, called *bipartite full* (Section 8.2). Having previously reduced the problem to distributed formulas (Proposition 5.3), we can consider even more constrained proof-nets (Section 8.3). These are the key differences with the proof in MLL from [BDC99], where some properties are given for free as there is no slice nor distributivity isomorphism. From this point the problem is similar to unit-free MLL, with commutativity and associativity only. We conclude as in [BDC99]: restricting the problem to so-called *non-ambiguous* formulas (Section 8.4), isomorphisms are easily characterized (Section 8.5).

The special shapes of proof-nets we consider are the followings.

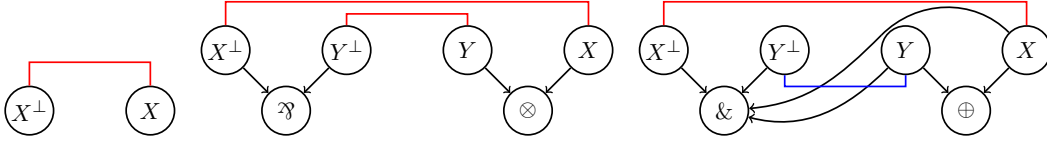

Figure 4: Identity proof-nets (from left to right: atom,  $\wp \setminus \otimes$  and  $\& \setminus \oplus$ )

**Definition 8.1** (Full,  $Ax$ -unique, Bipartite proof-net). A cut-free proof-net is called *full* if any of its leaves has (at least) one link on it. Furthermore, if for any leaf there exists a unique link on it (possibly shared among several linkings), then we call this proof-net *ax-unique*.

A cut-free proof-net is *bipartite* if it has two conclusions,  $A$  and  $B$ , and each of its links is between a leaf of  $A$  and a leaf of  $B$  (no link between leaves of  $A$ , or between leaves of  $B$ ).

For instance:

- the three proof-nets on Figure 4 (page 33) are bipartite and  $ax$ -unique
- the top-left proof-net of Figure 5 (page 34) is non-bipartite, full and non- $ax$ -unique; meanwhile, its top-right proof-net is bipartite and non-full (so non- $ax$ -unique)
- both proof-nets on Figure 6 (page 36) are bipartite, full and non- $ax$ -unique

**Lemma 8.2.** *Let  $\theta$  and  $\psi$  be bipartite proof-nets of respective conclusions  $A, B$  and  $B^\perp, C$ . Their composition over  $B$  reduces to a bipartite proof-net.*

*Proof.* The resulting proof-net has for conclusions  $A, C$ . The only links in the new proof-net that were not in  $\theta$  nor in  $\psi$  are those resulting from the replacement of a pair of links  $(l, m)$  and  $(m^\perp, n)$  with a link  $(l, n)$ , where  $m$  is a leaf of  $B$ . By bipartiteness of  $\theta$  and  $\psi$ , it follows  $l$  is a leaf of  $A$  and  $n$  one of  $C$ , so the new axiom link is between a leaf of  $A$  and one of  $C$ .  $\square$

**8.1. Properties of identity proof-nets.** Using an induction on the formula  $A$ , we can prove the following results on the identity proof-net of  $A$ , and in particular that it is bipartite  $ax$ -unique (see Figure 4 for a graphical intuition).

**Lemma 8.3.** *The axiom links of an identity proof-net are exactly the  $(l, l^\perp)$ , for any leaf  $l$ .*

*Proof.* By induction on the formula (see Figure 4).  $\square$

**Corollary 8.4.** *An identity proof-net is bipartite  $ax$ -unique.*

*Proof.* This follows from Lemma 8.3.  $\square$

**Lemma 8.5.** *Let  $\lambda$  be a linking of an identity proof-net and  $V$  an additive vertex in its additive resolution. Then  $V^\perp$  is also inside with, as premise kept, the dual premise of the one kept for  $V$ .*

*Proof.* Assume *w.l.o.g.* that the left premise of  $V$  is kept in  $\lambda$ . There is a left-ancestor  $l$  of  $V$  in the additive resolution of  $\lambda$ , hence with a link  $a \in \lambda$  on it. By Lemma 8.3,  $a = (l, l^\perp)$ . As  $l^\perp$  is a right-ancestor of  $V^\perp$ , the conclusion follows.  $\square$

The next result allows to go from exactly one linking on any  $\&$ -resolution of  $A^\perp, A$  (P1) to exactly one linking on any additive resolution of  $A$ .

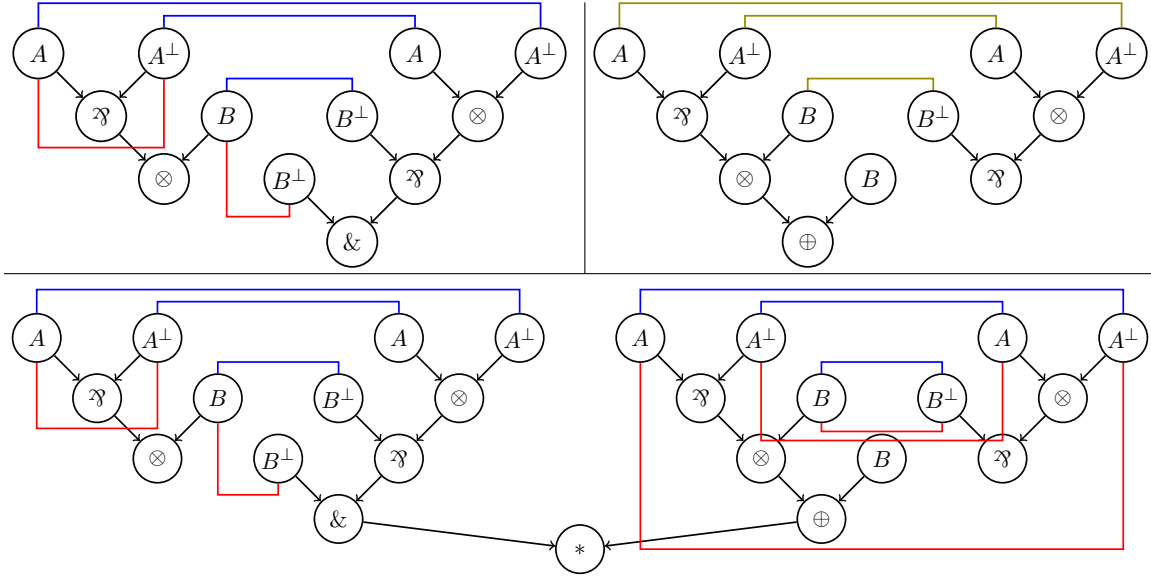

Figure 5: Non bipartite proof-net (top-left), non full proof-net (top-right) and one of their composition yielding the identity proof-net (bottom) (jump edges not represented)

**Lemma 8.6.** *In the identity proof-net of  $A$ , exactly one linking is on any given additive resolution of the conclusion  $A$ .*

*Proof.* Consider such an additive resolution  $R$ . There is an associated  $\&$ -resolution  $R'$  of  $A^\perp, A$  by taking the choices of premise of  $R$  on  $A$  and, for a  $\&$ -vertex  $W$  of  $A^\perp$ , taking the dual premise chosen in  $R$  for  $W^\perp$ . By Lemma 8.5, a linking  $\lambda$  is on  $R$  if and only if it is on  $R'$ . Meanwhile, by (P1) there is a unique linking  $\lambda$  on  $R'$ ; thus the same holds on  $R$ .  $\square$

**8.2. Bipartite full proof-nets.** We prove here that proof-nets of isomorphisms are bipartite full. Neither fullness,  $ax$ -uniqueness nor bipartiteness is preserved by cut anti-reduction. A counter-example is given on Figure 5, with a non bipartite proof-net and a non full one whose composition reduces to the identity proof-net (bipartite  $ax$ -unique by Corollary 8.4). However, if *both* compositions yield identity proof-nets, we get bipartiteness and fullness.

**Lemma 8.7.** *Let  $\theta$  and  $\theta'$  be cut-free proof-nets of respective conclusions  $A^\perp, B$  and  $B^\perp, A$ , such that  $\theta' \overset{A}{\boxtimes} \theta$  reduces to the identity proof-net of  $B$ . For any linking  $\lambda \in \theta$ , there exists  $\lambda' \in \theta'$  such that  $\lambda \cup \lambda'$  matches in the composition over  $B$  of  $\theta$  and  $\theta'$ ,  $\theta \overset{B}{\boxtimes} \theta'$ .*

*Proof.* Let us consider a linking  $\lambda \in \theta$ , and call  $\mathcal{C}$  the choices of premise on additive connectives of  $B$  that  $\lambda$  makes. We search some  $\lambda' \in \theta'$  making the dual choices of premise on additive connectives of  $B^\perp$  compared to  $\mathcal{C}$ . Consider the composition of  $\theta$  and  $\theta'$  over  $A$ . It reduces to the identity proof-net of  $B$  by hypothesis. By Lemma 8.6, there exists a unique linking  $\nu$  in the identity proof-net of  $B$  corresponding to  $\mathcal{C}$ . Furthermore, this linking  $\nu$  of the identity proof-net is derived from some  $\mu \cup \mu'$  for  $\mu$  a linking of  $\theta$  and  $\mu'$  one of  $\theta'$ , with  $\mu \cup \mu'$  matching for a cut over  $A$ : a linking in the identity proof-net is a linking of the form  $\mu \cup \mu'$  where axiom links  $(l, m_1), (m_1^\perp, m_2), \dots, (m_n^\perp, l^\perp)$  in  $\mu$  and  $\mu'$  are replaced with

$(l, l^\perp)$ , with  $l$  a leaf of  $B$  and the  $m_i$  and  $m_i^\perp$  of  $A^\perp$  and  $A$  (because an identity proof-net has only links of the form  $(l, l^\perp)$  by Lemma 8.3). Therefore,  $\mu$  makes the choices  $\mathcal{C}$  on  $B$  and  $\mu \cup \mu'$  matches for the composition of  $\theta$  and  $\theta'$  over both  $A$  and  $B$ . But  $\lambda$  makes the same choices  $\mathcal{C}$  on  $B$  as  $\mu$ :  $\lambda \cup \mu'$  also matches for a cut over  $B$ .  $\square$

**Remark 8.8.** Lemma 8.7 is the analogue of Lemma 5.9 in proof-nets

**Corollary 8.9.** *Assuming  $A \stackrel{\theta, \theta'}{\simeq} B$ ,  $\theta$  and  $\theta'$  are bipartite.*

*Proof.* We proceed by contradiction: *w.l.o.g.* there is a link  $a$  in some linking  $\lambda \in \theta$  which is between leaves of  $A^\perp$ . By Lemma 8.7 there exists  $\lambda' \in \theta'$  such that  $\lambda \cup \lambda'$  matches for a cut over  $B$ . Whence  $a$ , which does not involve leaves of  $B$ , belongs to a linking of the composition where cuts have been eliminated (it belongs to the linking resulting from  $\lambda \cup \lambda'$ ). But this reduction yields the identity proof-net of  $A$ , which is bipartite by Corollary 8.4, so there cannot be an axiom link between leaves of  $A^\perp$  inside: contradiction.  $\square$

**Lemma 8.10.** *Assume  $\theta$  and  $\theta'$  are cut-free proof-nets of respective conclusions  $A^\perp, B$  and  $B^\perp, A$ , and that their composition over  $B$  yields the identity proof-net of  $A$ . Then any leaf of  $A^\perp$  (resp.  $A$ ) has (at least) one axiom link on it in  $\theta$  (resp.  $\theta'$ ).*

*Proof.* Towards a contradiction, assume *w.l.o.g.* a leaf  $l$  of  $A^\perp$  has no link on it in  $\theta$ . Then, the composition over  $B$  of  $\theta$  and  $\theta'$  has no link on  $l$  either. And reducing cuts cannot create links using  $l$ , for it only takes links  $(l, m)$  and  $(m, n)$  to merge them into  $(l, n)$ . However, the identity proof-net of  $A$  is *ax*-unique by Corollary 8.4, thence full: contradiction.  $\square$

**Remark 8.11.** Lemma 8.10 holds not only for isomorphisms but more generally for retractions, which are formulas  $A$  and  $B$  such that there exist proofs  $\pi$  of  $\vdash A^\perp, B$  and  $\pi'$  of  $\vdash B^\perp, A$  whose composition by cut over  $B$  (but not necessarily over  $A$ ) is equal to the axiom on  $\vdash A^\perp, A$  up to axiom-expansion and cut-elimination. An example of retraction is given by the proof-nets on Figure 5, yielding a retraction between  $(A \wp A^\perp) \otimes B$  and  $((A \wp A^\perp) \otimes B) \oplus B$ , which is not an isomorphism. As another example, in MLL there is a well-known retraction between  $A$  and  $(A \multimap A) \multimap A = (A \otimes A^\perp) \wp A$ .

**Theorem 8.12.** *Assuming  $A \stackrel{\theta, \theta'}{\simeq} B$ ,  $\theta$  and  $\theta'$  are bipartite full.*

*Proof.* By Corollary 8.9,  $\theta$  and  $\theta'$  are bipartite, and thanks to Lemma 8.10, they are full.  $\square$

**8.3. *ax*-uniqueness.** In general, isomorphisms do not yield *ax*-unique proof-nets. A counter-example is distributivity:  $A \otimes (B \oplus C) \simeq (A \otimes B) \oplus (A \otimes C)$ , see Figure 6. Nonetheless, distributivity equations are the only ones in  $\mathcal{L}^\dagger$  not giving *ax*-unique proof-nets. Recall we can consider only distributed formulas (Proposition 5.3). On distributed formulas, distributivity isomorphisms can be ignored, and isomorphisms between distributed formulas happen to be bipartite *ax*-unique.

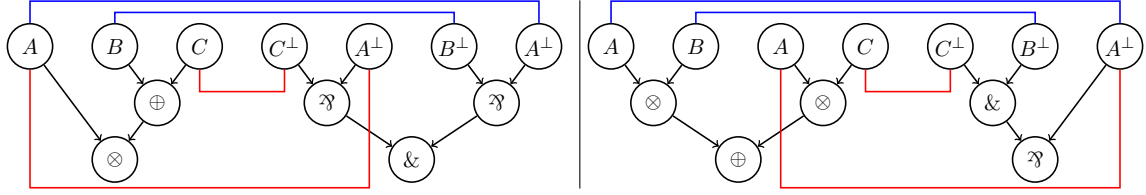
Figure 6: Proof-nets for  $A \otimes (B \oplus C) \simeq (A \otimes B) \oplus (A \otimes C)$ 

8.3.1. *Preliminary results.* We mostly use the correctness criterion through the fact we can sequentialize, *i.e.* recover a proof tree from a proof-net by Theorem 7.2. However, in order to prove *ax*-uniqueness, we make a direct use of the correctness criterion to deduce geometric properties of proof-nets. This part of the proof takes benefits from the specificities of this syntax. We begin with two preliminary results. For  $\Lambda$  a set of linkings and  $W$  a  $\&$ -vertex,  $\Lambda^W$  denote the set of all linkings in  $\Lambda$  whose additive resolution does not contain the right argument of  $W$ .

**Lemma 8.13** (Adaptation of Lemma 4.32 in [HvG05]). *Let  $\omega$  be a jump-free switching cycle in a proof-net  $\theta$ . There exists a subset of linkings  $\Lambda \subseteq \theta$  such that  $\omega \subseteq \mathcal{G}_\Lambda$ ,  $\omega \not\subseteq \mathcal{G}_{\Lambda^W}$  and for any  $\&$ -vertex  $W$  toggled by  $\Lambda$ , there exists an axiom link  $a \in \omega$  depending on  $W$  in  $\Lambda$ .*

*Proof.* The proof of this lemma uses some facts from [HvG05] reproduced verbatim here. Write  $\lambda \stackrel{W}{=} \lambda'$  if linkings  $\lambda, \lambda' \in \theta$  are either equal or  $W$  is the only  $\&$  toggled by  $\{\lambda, \lambda'\}$ . A subset  $\Lambda$  of a proof-net  $\theta$  is *saturated* if any strictly larger subset toggles more  $\&$  than  $\Lambda$ . It is straightforward to check that:

(S1) If  $\Lambda$  is saturated and toggles  $W$ , then  $\Lambda^W$  is saturated.

(S2) If  $\Lambda$  is saturated and toggles  $W$  and  $\lambda \in \Lambda$ , then  $\lambda \stackrel{W}{=} \lambda_W$  for some  $\lambda_W \in \Lambda^W$ .

Let us now prove our lemma. Take  $\Lambda$  a minimal saturated subset of  $\theta$  with  $\mathcal{G}_\Lambda$  containing  $\omega$ , and  $W$  a  $\&$ -vertex it toggles. Since  $\Lambda$  is minimal,  $\omega \not\subseteq \mathcal{G}_{\Lambda^W}$  using (S1), so some edge  $e$  of  $\omega$  is in  $\mathcal{G}_\Lambda$  but not in  $\mathcal{G}_{\Lambda^W}$ . We claim that, without loss of generality,  $e$  is an axiom link. If it is indeed the case then, by (S2),  $e \in \lambda \in \Lambda$  and  $e \notin \lambda_W$  for  $e \notin \Lambda^W$ , so  $e$  depends on  $W$  in  $\Lambda$ . We now prove our claim by eliminating other possibilities step by step.

Without loss of generality,  $e$  is an edge from a leaf  $l$  to some  $X$ , because for any other edge  $Y \rightarrow X$  in  $\omega$  we have  $l \rightarrow Z_1 \rightarrow \dots \rightarrow Z_n \rightarrow Y \rightarrow X$  in  $\omega$  for some leaf  $l$ , and  $Y \rightarrow X$  is in  $\mathcal{G}_{\Lambda^W}$  whenever  $l \rightarrow Z_1$  is in  $\mathcal{G}_{\Lambda^W}$ . This is because a switching cycle must have an edge using a leaf, for all other edges are in the syntactic forest of the sequent, which is acyclic.

Still without loss of generality,  $e$  is not an edge in a syntactic tree. Indeed, in such a case  $e \notin \mathcal{G}_{\Lambda^W}$  implies  $l \notin \mathcal{G}_{\Lambda^W}$ . As  $e$  belongs to the switching cycle  $\omega$ , let us look at the other edge in this cycle with endpoint  $l$ , say  $e'$ . As  $l \notin \mathcal{G}_{\Lambda^W}$ , we also have  $e' \notin \mathcal{G}_{\Lambda^W}$ . Remark that  $e'$  cannot be an edge in a syntactic tree, for only one such edge has for endpoint the leaf  $l$ , namely  $e$ . We can replace  $e$  with  $e'$  to assume  $e$  is not an edge in a syntactic tree.

As  $\omega$  is jump-free,  $e$  cannot be a jump edge. The sole possibility is  $e$  being a link.  $\square$

For  $U$  and  $V$  vertices in a tree, their *first common descendant* is the vertex of the tree which is a descendant of both  $U$  and  $V$  and which has no ancestor respecting this property, with a tree represented with its root at the bottom, which is a *descendant* of the leaves. Or equivalently, looking at a tree as a partial order of minimal element the root, the first common descendant is the infimum.

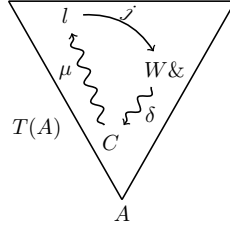
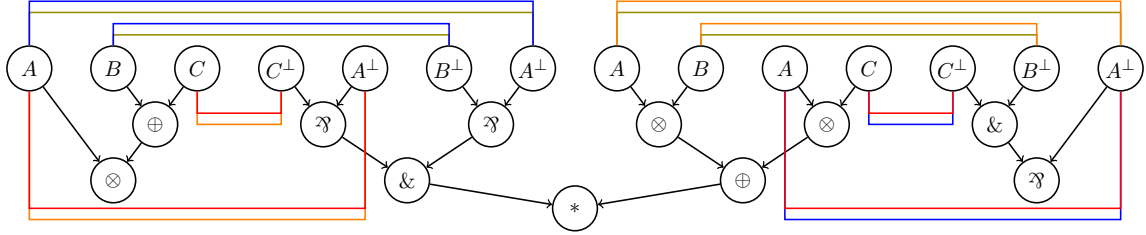

Figure 7: Illustration of the proof of Lemma 8.14

 Figure 8: Proof-nets from Figure 6 composed by cut on  $(A \otimes B) \oplus (A \otimes C)$ 

**Lemma 8.14.** *Let  $\theta$  be a proof-net of conclusions  $\Gamma, A$ , with a jump edge  $l \xrightarrow{j} W$  between  $l, W \in T(A)$ . If  $W$  is not a descendant of  $l$ , then their first common descendant  $C$  is a  $\wp$ .*

*Proof.* As there is a jump  $l \xrightarrow{j} W$ , there exist linkings  $\lambda, \lambda' \in \theta$  such that  $W$  is the only  $\&$  toggled by  $\{\lambda; \lambda'\}$ , and a link  $a \in \lambda \setminus \lambda'$  using the leaf  $l$ . In particular, the jump  $l \xrightarrow{j} W$  is in  $\mathcal{G}_{\{\lambda; \lambda'\}}$ . For  $l$  and  $W$  are both in the additive resolution of  $\lambda$ , both premises of  $C$  are also in this additive resolution, thus  $C$  cannot be an additive connective, so not a  $\&$  nor a  $\oplus$ -vertex.

Assume by contradiction that  $C$  is a  $\otimes$ . Call  $\delta$  the path in  $T(A)$  from  $W$  to  $C$ , and  $\mu$  the one from  $C$  to  $l$  (see Figure 7). Then,  $(l \xrightarrow{j} W)\delta\mu$  is a switching cycle in  $\mathcal{G}_{\{\lambda; \lambda'\}}$ . According to (P3), there exists a  $\&$  toggled by  $\{\lambda; \lambda'\}$  not in any switching cycle of  $\mathcal{G}_{\{\lambda; \lambda'\}}$ . A contradiction, for  $W$  is the only  $\&$  toggled by  $\{\lambda; \lambda'\}$ . Whence,  $C$  can only be a  $\wp$ .  $\square$

**8.3.2. Isomorphisms of distributed formulas.** Now, let us prove that isomorphisms of distributed formulas are bipartite  $ax$ -unique. We will consider proof-nets corresponding to an isomorphism that we cut and where we eliminate all cuts not involving atoms. To give some intuition, let us consider the non- $ax$ -unique proof-nets of Figure 6 (on page 36). Composing them together by cut on  $(A \otimes B) \oplus (A \otimes C)$  gives the proof-net illustrated on Figure 8. Reducing all cuts not involving atoms yields the proof-net on Figure 9, that we call an *almost reduced composition*. We stop there because of the switching cycle produced by the two links on  $A$  (dashed in blue on Figure 9), less visible in the non-reduced composition of Figure 8. However, reducing all cuts gives the identity proof-net, which has no switching cycle: during these reductions, both links on  $A$  are merged. By using almost reduced composition, we are going to prove that links preventing  $ax$ -uniqueness yield switching cycles, and moreover that these cycles are due to non-distributed formulas only.

**Definition 8.15** (Almost reduced composition). Take  $\theta$  and  $\theta'$  cut-free proof-nets of respective conclusions  $\Gamma, B$  and  $B^\perp, \Delta$ . The *almost reduced composition* over  $B$  of  $\theta$  and

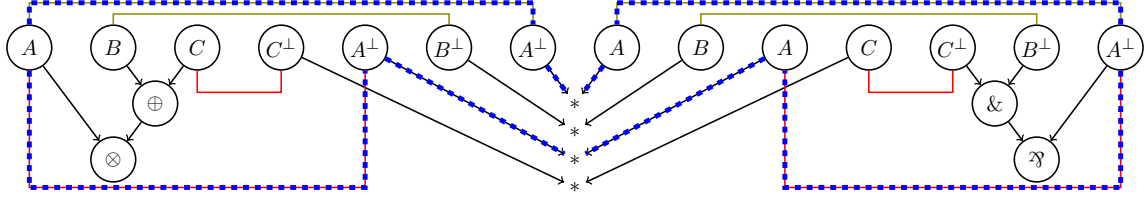

Figure 9: An almost reduced composition of the proof-nets on Figure 6

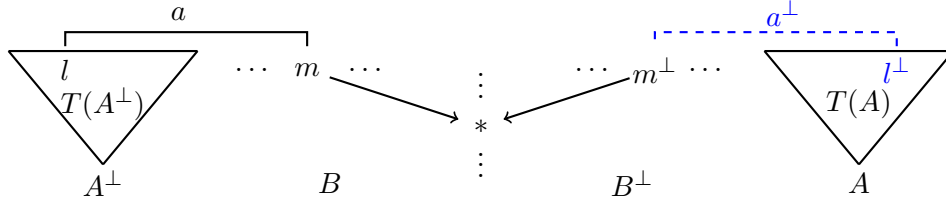

Figure 10: Illustration of Lemma 8.16

$\theta'$  is the proof-net resulting from the composition over  $B$  of  $\theta$  and  $\theta'$  where we repeatedly reduce all cuts not involving atoms (*i.e.* not applying step (a) of Definition 6.3).

Let us fix  $A$  and  $B$  two unit-free MALL (not necessarily distributed yet) formulas as well as  $\theta$  and  $\theta'$  such that  $A \simeq B$ . By Theorem 8.12,  $\theta$  and  $\theta'$  are bipartite full. We denote by  $\psi$  the almost reduced composition over  $B$  of  $\theta$  and  $\theta'$ . Here, we can extend our duality on vertices and premises (defined in Section 6) to links.

**Lemma 8.16.** *An axiom link  $a = (l, m)$  belongs to some linking  $\lambda \in \psi$  if and only, up to swapping  $l$  and  $m$ ,  $l$  is a leaf of  $A^\perp$  (resp.  $A$ ),  $m$  is in the leaves of  $B$  (resp.  $B^\perp$ ) and there is an axiom link  $(l^\perp, m^\perp)$  in the same linking  $\lambda$ , that we will denote  $a^\perp = (l^\perp, m^\perp)$  (see Figure 10).*

*Proof.* Linkings of  $\psi$  are disjoint union of linkings in  $\theta$  and  $\theta'$ . By symmetry, assume  $(l, m) \in \lambda \in \psi$  comes from a linking in  $\theta$ . As  $\theta$  is bipartite, one of the leaves, say  $l$ , is in  $A^\perp$  and the other,  $m$ , is a leaf of  $B$ . For the cut  $m * m^\perp$  belongs to the additive resolution of  $\lambda$  (for  $m$  is inside),  $m^\perp$  is a leaf in this resolution. Thus, there is a link  $(m^\perp, l') \in \lambda$  for some leaf  $l'$ , which necessarily belongs to  $A$  by bipartiteness of  $\theta'$ . It stays to prove  $l' = l^\perp$ . If we were to eliminate all cuts in  $\psi$ , we would get the identity proof-net on  $A$  by hypothesis. But eliminating the cut  $m * m^\perp$  yields a link  $(l, l')$ , which is not modified by the elimination of the other atomic cuts. By Lemma 8.3,  $l' = l^\perp$  follows.  $\square$

**Lemma 8.17.** *Let  $\lambda$  be a linking of  $\psi$ , and  $V$  an additive vertex in its additive resolution. Then  $V^\perp$  is also inside, with as premise kept the dual premise of the one kept for  $V$ .*

*Proof.* Assume *w.l.o.g.* that the left premise of  $V$  is kept in  $\lambda$ . There is a left-ancestor  $l$  of  $V$  in the additive resolution of  $\lambda$ , hence with a link  $a \in \lambda$  on it. By Lemma 8.16, we have  $a^\perp \in \lambda$ , using  $l^\perp$ . As  $l^\perp$  is a right-ancestor of  $V^\perp$ , the conclusion follows.  $\square$

**Lemma 8.18.** *Let  $W$  and  $P$  be respectively a  $\&$ -vertex and a  $\oplus$ -vertex in  $\psi$ , with  $W$  an ancestor of  $P$ . Then for any axiom link  $a$  depending on  $W$  in  $\psi$ ,  $a$  also depends on  $P^\perp$  in  $\psi$ .*

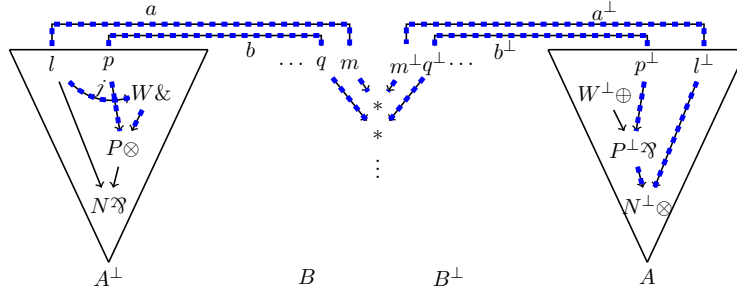
Figure 11: Switching cycle containing  $W$  if  $P$  is a  $\otimes$ -vertex in the proof of Lemma 8.19

*Proof.* There exist linkings  $\lambda, \lambda' \in \psi$  such that  $W$  is the only  $\&$  toggled by  $\{\lambda; \lambda'\}$  and  $a \in \lambda \setminus \lambda'$ . We consider a linking  $\lambda_{P^\perp}$  defined by taking an arbitrary  $\&$ -resolution of  $\lambda$  where we choose the other premise for  $P^\perp$  (and arbitrary premises for  $\&$ -vertices introduced this way, meaning for  $\&$ -ancestors of  $P^\perp$ ): by (P1), there exists a unique linking on it. By Lemma 8.17, the additive resolutions of  $\lambda$  and  $\lambda_{P^\perp}$  (resp.  $\lambda$  and  $\lambda'$ ) differ, on  $A$  and  $A^\perp$ , exactly on ancestors of  $P$  and  $P^\perp$  (resp.  $W$  and  $W^\perp$ ). Thus, the additive resolutions of  $\lambda'$  and  $\lambda_{P^\perp}$  also differ, on  $A$  and  $A^\perp$ , exactly on ancestors of  $P$  and  $P^\perp$ , for  $W$  is an ancestor of  $P$ . In particular,  $\{\lambda; \lambda_{P^\perp}\}$ , as well as  $\{\lambda'; \lambda_{P^\perp}\}$ , toggles only  $P^\perp$ . If  $a \in \lambda_{P^\perp}$ , then  $a$  depends on  $P^\perp$  in  $\{\lambda'; \lambda_{P^\perp}\}$ . Otherwise,  $a$  depends on  $P^\perp$  in  $\{\lambda; \lambda_{P^\perp}\}$ .  $\square$

The key result to use distributivity is that a positive vertex “between” a leaf  $l$  and a  $\&$ -vertex  $W$  in the same tree prevents them from interacting, *i.e.* there is no jump  $l \xrightarrow{j} W$ .

**Lemma 8.19.** *Let  $l \xrightarrow{j} W$  be a jump edge in  $\psi$ , with  $l$  not an ancestor of  $W$  and  $l, W \in T(A^\perp)$  (resp.  $T(A)$ ). Denoting by  $N$  the first common descendant of  $l$  and  $W$ , there is no positive vertex in the path between  $N$  and  $W$  in  $T(A^\perp)$  (resp.  $T(A)$ ).*

*Proof.* Let  $P$  be a vertex on the path between  $N$  and  $W$  in  $T(A^\perp)$ . By Lemma 8.14,  $N$  is a  $\wp$ -vertex. We prove by contradiction that  $P$  can neither be a  $\oplus$  nor a  $\otimes$ -vertex.

Suppose  $P$  is a  $\oplus$ -vertex. By Lemma 8.18,  $a$  depends on  $P^\perp$ , and so does  $a^\perp$  through Lemma 8.16: there is a jump edge  $l^\perp \xrightarrow{j} P^\perp$ . Applying Lemma 8.14, the first common descendant of  $l^\perp$  and  $P^\perp$ , which is  $N^\perp$ , is a  $\wp$ -vertex: a contradiction as it is a  $\otimes$ -vertex.

Assume now  $P$  to be a  $\otimes$ -vertex. As there is a jump  $l \xrightarrow{j} W$ , there exist linkings  $\lambda, \lambda' \in \psi$  and a leaf  $m$  of  $B$  such that  $W$  is the only  $\&$  toggled by  $\{\lambda; \lambda'\}$  and  $a = (l, m) \in \lambda \setminus \lambda'$ . For  $P$  is a  $\otimes$ , there is a leaf  $p$  which is an ancestor of  $P$  in the additive resolution of  $\lambda$ , from a different premise of  $P$  than  $W$ ; it is used by a link  $b = (p, q) \in \lambda$  (see Figure 11). Remark  $q \neq m$ , for  $a$  and  $b$  are two distinct links in the same linking  $\lambda$ . Then the switching cycle  $l \xrightarrow{j} W \rightarrow P \leftarrow p \xrightarrow{b} q \rightarrow * \leftarrow q^\perp \xrightarrow{b^\perp} p^\perp \rightarrow P^\perp \rightarrow N^\perp \leftarrow l^\perp \xrightarrow{a^\perp} m^\perp \rightarrow * \leftarrow m \xrightarrow{a} l$  (dashed in blue on Figure 11) belongs to  $\mathcal{G}_{\{\lambda; \lambda'\}}$ , with non labeled arrows paths in the syntactic forest. Contradiction:  $W$ , the only  $\&$  toggled by  $\{\lambda; \lambda'\}$ , cannot be in any switching cycle of  $\mathcal{G}_{\{\lambda; \lambda'\}}$  by (P3).  $\square$

**Theorem 8.20.** *Assuming  $A \stackrel{\theta, \theta'}{\simeq} B$  with  $A$  and  $B$  distributed,  $\theta$  and  $\theta'$  are bipartite ax-unique.*

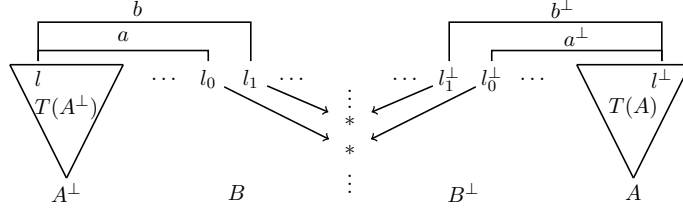

Figure 12: Almost reduced composition  $\psi$  of  $\theta$  and  $\theta'$  by cut over  $B$  in the proof of Theorem 8.20

*Proof.* We already know that  $\theta$  and  $\theta'$  are bipartite full thanks to Theorem 8.12. We reason by contradiction and assume *w.l.o.g.* that  $\theta$  is not *ax-unique*: there exist a leaf  $l$  of  $A^\perp$  and two distinct leaves  $l_0$  and  $l_1$  of  $B$  with links  $a = (l, l_0)$  and  $b = (l, l_1)$  in  $\theta$ . We consider  $\psi$  the almost reduced composition of  $\theta$  and  $\theta'$  over  $B$ , depicted on Figure 12. By Lemma 8.7,  $a$  and  $b$  are also links in  $\psi$  (for the linkings they belong to in  $\theta$  have matching linkings in  $\theta'$ , and we did not eliminate atomic cuts). Using Lemma 8.16, we have in  $\mathcal{G}_\psi$  a switching cycle  $\omega = l \xrightarrow{a} l_0 \rightarrow * \leftarrow l_0^\perp \xrightarrow{a^\perp} l_1^\perp \xrightarrow{b^\perp} l_1 \rightarrow * \leftarrow l_1 \xrightarrow{b} l$ .

Let  $\Lambda$  be a set of linkings given by Lemma 8.13 applied to  $\omega$ . As there are two distinct links on  $l$  in  $\omega \subseteq \mathcal{G}_\Lambda$ ,  $\Lambda$  contains at least two linkings. By (P3), there exists  $W$  a  $\&$  toggled by  $\Lambda$  that is not in any switching cycle of  $\mathcal{G}_\Lambda$ . By Lemma 8.13,  $a, a^\perp, b$  or  $b^\perp$  depends on  $W$ . So  $a$  or  $b$  depends on  $W$  by Lemma 8.16; *w.l.o.g.*  $a$  depends on  $W$ . The vertex  $W$  belongs to either  $T(A)$  or  $T(A^\perp)$ : up to considering  $a^\perp$  instead of  $a$ ,  $W$  is in  $T(A^\perp)$ . Remark  $l$  is not an ancestor of  $W$ : if it were, by symmetry assume it is a left-ancestor. Whence  $a$  and  $b$  belong to  $\Lambda^W$ , so  $a^\perp$  and  $b^\perp$  too (Lemma 8.16); thus  $\omega \subseteq \mathcal{G}_{\Lambda^W}$ , contradicting Lemma 8.13. By Lemma 8.14, the first common descendant  $N$  of  $l$  and  $W$  in  $T(A^\perp)$  is a  $\wp$ . There is a  $\otimes \setminus \oplus$  on the path between the  $\wp$   $N$  and its ancestor the  $\&$   $W$  in  $T(A^\perp)$ , for there is no sub-formula of the shape  $-\wp(-\&-)$  in the distributed  $A^\perp$ . This contradicts Lemma 8.19.  $\square$

**8.4. Non-ambiguous formulas.** Once our study is restricted to bipartite *ax-unique* proof-nets, we can also restrict formulas further.

**Definition 8.21** (Non-ambiguous formula). A formula  $A$  is said *non-ambiguous* if each atom in  $A$  occurs at most once positive and once negative.

**Remark 8.22.** This means all leaves in  $A$  are distinct. If  $A$  is non-ambiguous, so is  $A^\perp$ .

For instance,  $X \& X^\perp$  is non-ambiguous, whereas  $(A \otimes B) \oplus (A \otimes C)$  is ambiguous. The reduction to non-ambiguous formulas requires to restrict to distributed formulas first: in  $(A \otimes B) \oplus (A \otimes C) \simeq A \otimes (B \oplus C)$  we need the two occurrences of  $A$  to factorize. The goal of this section is to prove that we can consider only non-ambiguous formulas (Corollary 8.26) and that isomorphisms for these formulas correspond simply to the existence of bipartite proof-nets (Theorem 8.32). These two results are a direct adaptation of the work on MLL by Balat & Di Cosmo (see Section 3 in [BDC99]).



8.4.1. *Reduction to non-ambiguous formulas.* In the following, we will call *substitution* the usual operation  $[A_1/X_1, \dots, A_n/X_n]$  of replacement of the atoms  $X_i$  of a formula by the formulas  $A_i$ . In our case, the  $A_i$  will always be atoms or negated atoms, *i.e.* leaves. We will consider substitutions extended to proof-nets, *i.e.* if  $\sigma$  is a substitution and  $\theta$  a proof-net,  $\sigma(\theta)$  will be the proof-net obtained from  $\theta$  by relabeling all leaves  $X_i$  appearing in it by  $\sigma(X_i)$ . We also use a more general notion, *renaming*, that may replace *different occurrences* of the *same* atom by different atoms or negated atoms in a proof-net, *i.e.* substitute on leaves instead of atoms.

**Definition 8.23** (Renaming). An application  $\alpha$  from the set of *leaves* of a proof-net  $\theta$  to a set of atoms and negated atoms is a *renaming* if  $\alpha(\theta)$ , the graph obtained by substitution of each label of a leaf  $l$  of  $\theta$  by  $\alpha(l)$ , is a proof-net.

Remark that if  $\theta$  is *bipartite ax-unique*, then the definition of  $\alpha$  only on leaves in *one conclusion* of  $\theta$  is sufficient to uniquely define a renaming  $\alpha$  on  $\theta$ . This is because every leaf of the other conclusion is linked to exactly one leaf in this conclusion, and no leaves in a given conclusion are linked together. It then suffices to define  $\alpha(Y)$  as  $\alpha(X)^\perp$  for  $Y$  linked to  $X$ , with  $X$  in the conclusion where  $\alpha$  is defined. Note also that if the conclusions of  $\theta$  are ambiguous formulas, then two different occurrences of the same atom can be renamed differently, unlike what happens in the case of substitutions.

**Theorem 8.24** (Renaming preserves distributed isomorphisms). *For  $A$  and  $B$  distributed formulas, assume  $A \simeq_{\theta, \theta'} B$ . If  $\alpha$  is a renaming of the leaves of  $\theta$ , then there exists  $\alpha'$ , a renaming of the leaves of  $\theta'$ , such that  $\alpha'(A) \simeq_{\alpha(\theta), \alpha'(\theta')} \alpha(B)$ ; more precisely:*

- $\alpha'(\theta')$  is a proof-net
- $\alpha(A^\perp) = \alpha'(A)^\perp$  and  $\alpha'(B^\perp) = \alpha(B)^\perp$
- the composition of  $\alpha(\theta)$  and  $\alpha'(\theta')$  by cut over  $\alpha(B)$  (resp.  $\alpha'(A)$ ) gives the identity proof-net of  $\alpha'(A)$  (resp.  $\alpha(B)$ ).

*Proof.* We first define  $\alpha'$ . By Theorem 8.20,  $\theta'$  is bipartite *ax-unique*, so it is sufficient to define  $\alpha'$  only on the occurrences of  $B^\perp$ , *i.e.* to define  $\alpha'(B^\perp)$ . We set  $\alpha'(B^\perp) = \alpha(B)^\perp$ . Then the composition of  $\alpha(\theta)$  and  $\alpha'(\theta')$  by cut over  $\alpha(B)$  is a proof-net. Since cut-elimination does not depend on labels, this composition reduces to a proof-net with the same structure as an identity proof-net, but with conclusions  $\alpha(A^\perp), \alpha'(A)$ . An induction, on the size of  $\alpha(A^\perp)$ , shows that this is the identity proof-net of  $\alpha(A^\perp)$ . Thus  $\alpha(A^\perp) = \alpha'(A)^\perp$ . But then, the composition of  $\alpha'(\theta')$  and  $\alpha(\theta)$  by cut over  $\alpha'(A)$  is well-defined and reduces, since cut-elimination does not depend on labels, to the identity proof-net of  $\alpha(B)$ . Hence,  $\alpha'(A) \simeq_{\alpha(\theta), \alpha'(\theta')} \alpha(B)$ .  $\square$

**Lemma 8.25** (Distributed ambiguous isomorphic formulas). *Let  $A$  and  $B$  be distributed formulas, such that  $A \simeq_{\theta, \theta'} B$ . There exists a substitution  $\sigma$  and distributed formulas  $A'$  and  $B'$ , non-ambiguous, such that  $A = \sigma(A')$ ,  $B = \sigma(B')$  and  $A' \simeq_{\psi, \psi'} B'$  for some proof-nets  $\psi$  and  $\psi'$ .*

*Proof.* The proof-nets  $\theta$  and  $\theta'$  are bipartite *ax-unique* (Theorem 8.20), with conclusions  $A^\perp, B$  and  $B^\perp, A$  respectively. One can define a renaming  $\alpha$  of  $\theta$  such that  $\alpha(B)$  has distinct positive leaves (*i.e.* no leaf of  $\alpha(B)$  occurs twice in  $\alpha(B)$ , and all are positive atoms), for it is

sufficient to define  $\alpha$  only on leaves of  $B$ . In particular,  $\alpha(B)$  is non-ambiguous. Furthermore,  $\alpha(\theta)$  being bipartite  $ax$ -unique,  $\alpha(A^\perp)$  has for leaves exactly the duals of the leaves of  $\alpha(B)$ . Whence,  $\alpha(A^\perp)$  is non-ambiguous too (with distinct negative leaves).

Now, Theorem 8.24 gives an algorithm for defining a renaming  $\alpha'$  such that  $\alpha'(A) \simeq \alpha(B)$ , with in particular  $\alpha(A^\perp) = \alpha'(A)^\perp$  and  $\alpha'(B^\perp) = \alpha(B)^\perp$ . Pose  $A' := \alpha'(A)$  and  $B' := \alpha(B)$ ,

hence  $A' \simeq B'$  and  $\alpha(\theta)$  has for conclusions  $A'^\perp, B'$ . Formulas  $A'$  and  $B'$  are distributed, as renaming acts only on leaves, and non-ambiguous (for  $\alpha(A^\perp)$  and  $\alpha(B)$  are non-ambiguous).

On  $\alpha(\theta)$  one can define a renaming  $\alpha^{-1}$  such that  $\alpha^{-1}(B') = B$ , again as  $\alpha(\theta)$  is bipartite  $ax$ -unique, so it is equivalent to define  $\alpha^{-1}$  on  $\alpha(\theta)$  or only on leaves of  $B'$ . Moreover,  $\theta = \alpha^{-1}(\alpha(\theta))$  and then  $\alpha^{-1}(A'^\perp) = A^\perp$  follow from  $\alpha^{-1}(B') = B$ .

Recall that all leaves of  $B'$  are distinct and positive. Hence, the definition of  $\alpha^{-1}$  on  $B'$  can be seen as a substitution  $\sigma$  on atoms of  $B'$ , with  $\sigma(X) = \alpha^{-1}(l(X))$  where  $l(X)$  is the unique leaf of  $B'$  with label  $X$ . Thus,  $\theta = \alpha^{-1}(\alpha(\theta)) = \sigma(\alpha(\theta))$ : in particular,  $\sigma(B') = B$  and  $\sigma(A'^\perp) = A^\perp$ , so  $\sigma(A') = A$ . Finally,  $A'$  and  $B'$  are distributed non-ambiguous formulas such that  $A' \simeq B'$ ,  $A = \sigma(A')$  and  $B = \sigma(B')$ .  $\square$

**Corollary 8.26** (Reduction to distributed non-ambiguous formulas). *The set of couples of distributed formulas  $A$  and  $B$  such that  $A \simeq B$  is the set of instances (by a substitution on atoms) of couples of distributed non-ambiguous formulas  $A'$  and  $B'$  such that  $A' \simeq B'$ .*

*Proof.* We show each inclusion separately. Let  $A$  and  $B$  be two distributed formulas such that  $A \simeq B$ . Then  $A$  and  $B$  are instances of two non-ambiguous distributed formulas  $A'$  and  $B'$  such that  $A' \simeq B'$  by Lemma 8.25.

Conversely, let  $A'$  and  $B'$  be distributed non-ambiguous formulas such that  $A' \simeq B'$ ,  $\theta'$  and  $\psi'$  being bipartite  $ax$ -unique proof-nets (Theorem 8.20). Take  $\sigma$  a substitution on atoms of  $A'$  (so also on atoms of  $B'$ ). The substitution  $\sigma$  defines on  $\theta'$  a renaming  $\alpha$  for any substitution can be seen as a renaming. Let  $\alpha'$  be the renaming defined on  $\psi'$ , associated to  $\alpha$  in Theorem 8.24. Since  $\sigma(A'^\perp) = \alpha(A'^\perp) = (\alpha'(A'))^\perp$ ,  $\alpha'$  is also the renaming induced by  $\sigma$  on  $\psi'$ . As  $\alpha'(A') \simeq \alpha(B')$  by Theorem 8.24, it follows  $\sigma(A') \simeq \sigma(B')$ .  $\square$

8.4.2. *Simplification with non-ambiguous formulas.* The goal of this part is to show isomorphisms between non-ambiguous formulas correspond simply to the existence of bipartite proof-nets, speaking no more about cut-elimination nor identity proof-nets. This is done by proving properties close to the ones of identity proof-nets from Section 8.1.

**Lemma 8.27.** *Let  $\theta$  be a bipartite proof-net of conclusions  $A^\perp, A$ , with  $A$  a non-ambiguous formula. Axiom links of  $\theta$  are of the form  $(l^\perp, l)$  for  $l$  a leaf of  $A$ .*

*Proof.* Let  $a$  be an axiom link of  $\theta$ . By bipartiteness, it uses a leaf  $l$  of  $A$  and a leaf  $m$  of  $A^\perp$ . Denote by  $X$  the label of  $l$ , whence the label of  $m$  is  $X^\perp$ . However, the only leaf of  $A^\perp$  with label  $X^\perp$  is  $l^\perp$ , because  $A^\perp$  is non-ambiguous. Thus,  $m = l^\perp$  and  $a = (l, l^\perp)$ .  $\square$

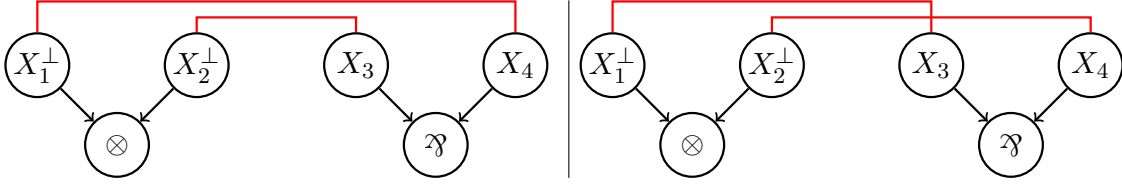

Figure 13: Identity proof-net of  $X \otimes X$  (left-side) and the swap on this formula (right-side)

**Lemma 8.28.** *Let  $\theta$  be a bipartite proof-net of conclusions  $A^\perp, A$ , with  $A$  a non-ambiguous formula. Take a linking  $\lambda \in \theta$  and an additive vertex  $V$  in its additive resolution. The vertex  $V^\perp$  is in the additive resolution of  $\lambda$ , and  $\lambda$  keeps for  $V^\perp$  the dual premise it keeps for  $V$ .*

*Proof.* As  $V$  is in the additive resolution  $(A^\perp, A) \uparrow \lambda$  of  $\lambda$ , one of its ancestor leaves, say  $l$ , is in  $(A^\perp, A) \uparrow \lambda$ : there is a link  $a \in \lambda$  on it. By Lemma 8.27,  $a = (l, l^\perp)$ . But  $l^\perp$  is an ancestor of  $V^\perp$ , so  $V^\perp$  is in  $(A^\perp, A) \uparrow \lambda$ , with as premise the dual premise chosen for  $V$ .  $\square$

**Lemma 8.29.** *Let  $A$  be a non-ambiguous formula,  $\theta$  and  $\theta'$  bipartite proof-nets of conclusions  $A^\perp, A$ . Then  $\theta = \theta'$ .*

*Proof.* Take  $\lambda \in \theta$  a linking. It is on some  $\&$ -resolution  $R$  of  $A^\perp, A$ . By (P1), there exists a unique linking  $\lambda' \in \theta'$  on  $R$ . We have to prove  $\lambda = \lambda'$ . They have the same additive resolution, for their choice on a  $\oplus$ -vertex  $P$  is determined by the premise taken for the  $\&$ -vertex  $P^\perp$ , which is in  $R$  (Lemma 8.28). They have the same axiom links on this additive resolution, because any leaf on it is linked to its dual (Lemma 8.27). Therefore,  $\lambda = \lambda'$ , so  $\theta \subseteq \theta'$ . By symmetry, the same reasoning yields  $\theta' \subseteq \theta$ , thus  $\theta = \theta'$ .  $\square$

**Corollary 8.30.** *Let  $A$  be a non-ambiguous formula. There is exactly one bipartite proof-net of conclusions  $A^\perp, A$ : the identity proof-net of  $A$ .*

*Proof.* This follows from Corollary 8.4 and Lemma 8.29.  $\square$

**Remark 8.31.** This property does not hold outside of non-ambiguous formulas, even distributed. For instance, there are two bipartite  $ax$ -unique proof-nets of conclusions  $X_1^\perp \otimes X_2^\perp, X_3 \otimes X_4$  (where each  $X_i$  is an occurrence of the atom  $X$ ): the identity proof net, with axiom links  $(X_1^\perp, X_4)$  and  $(X_2^\perp, X_3)$ , and the “swap” with axiom links  $(X_1^\perp, X_3)$  and  $(X_2^\perp, X_4)$  (see Figure 13).

**Theorem 8.32** (Bipartite proof-nets for non-ambiguous formulas). *Let  $A$  and  $B$  be non-ambiguous formulas. If there exist bipartite proof-nets  $\theta$  and  $\psi$  of respective conclusions  $A^\perp, B$  and  $B^\perp, A$ , then  $A \simeq_{\theta, \psi} B$ .*

*Proof.* We prove both compositions reduce to identity proof-nets. By symmetry, consider the composition over  $B$ . Using Lemma 8.2, it reduces to a bipartite proof-net, of conclusions  $A^\perp, A$ . By Corollary 8.30, this can only be the identity proof-net of  $A$ .  $\square$

**8.5. Completeness for unit-free MALL.** We now prove the completeness of  $\mathcal{L}^\dagger$  for unit-free MALL by reasoning as in Section 4 of [BDC99], with some more technicalities for we have to reorder not only  $\otimes$ -vertices but also  $\&$ -vertices.

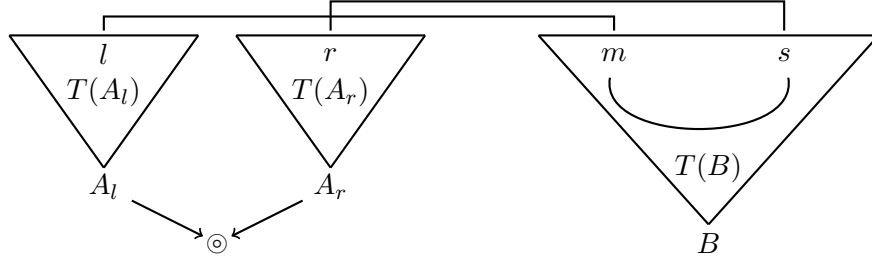

Figure 14: Illustration of the proof of Lemma 8.34

**Definition 8.33** (Sequentializing vertex). A terminal (*i.e.* with no descendant) non-leaf vertex  $V$  in a proof-net  $\theta$  is called *sequentializing* if, depending on its kind:

- $\otimes \setminus *$ -vertex: the removal of  $V$  in  $\mathcal{G}_\theta$  has two connected components.
- $\oplus$ -vertex: the left or right syntactic sub-tree of  $V$  does not belong to  $\mathcal{G}_\theta$  (*i.e.* has no link on any of its leaves in  $\mathcal{G}_\theta$ ).
- $\wp \setminus \&$ -vertex: a terminal  $\wp \setminus \&$ -vertex is always sequentializing.

It is easy to check that removing a sequentializing vertex produces proof-net(s). The sequentialization theorem (Theorem 7.2) affirms there exists a sequentializing vertex in a proof-net.

**Lemma 8.34.** *In a bipartite full proof-net with conclusions  $A_l \odot A_r, B$ , where  $\odot \in \{\otimes; \oplus\}$ , the root of  $A_l \odot A_r$  is not sequentializing.*

*Proof.* Let  $l$  be a leaf of  $A_l$  and  $r$  one of  $A_r$ . By bipartiteness and fullness, there are leaves  $m$  and  $s$  of  $B$  with axiom links  $(l, m)$  and  $(r, s)$  in the proof-net (see Figure 14). As there is a path in  $T(B)$  between  $m$  and  $s$ , whether  $\odot = \oplus$  or  $\odot = \otimes$ , it is not sequentializing.  $\square$

**Lemma 8.35** (Reordering  $\wp$ -vertices). *Let  $\theta$  be a bipartite ax-unique proof-net of conclusions  $A = A_l \wp A_r$  and  $B = B_l \odot B_r$  with  $\odot \in \{\otimes; \oplus\}$  and  $A$  a distributed formula. Then  $\odot = \otimes$  and there exist two bipartite ax-unique proof-nets of respective conclusions  $A'_l, B_l$  and  $A'_r, B_r$  where  $A'_l \wp A'_r$  is equal to  $A_l \wp A_r$  up to associativity and commutativity of  $\wp$ .*

*Proof.* We remove all terminal (hence sequentializing)  $\wp$ -vertices, all in  $A$ , without modifying the linkings. The resulting graph is a proof-net of conclusions  $A_1, \dots, A_n, B_l \odot B_r$  (see Figure 15). The roots of the new trees  $A_i$  cannot be  $\&$ -vertices because  $A$  is distributed: so they are  $\otimes \setminus \oplus$ -vertices or atoms. These  $\otimes \setminus \oplus$ -vertices are not sequentializing, since by bipartiteness and fullness every leaf of each  $A_i$  is connected to the formula  $B_l \odot B_r$  (reasoning as in the proof of Lemma 8.34). Thus, the sequentializing vertex of this proof-net is necessarily  $B_l \odot B_r$ . It follows  $\odot = \otimes$ , because all leaves of  $B$  are connected to leaves in  $A_1, \dots, A_n$ , so if  $\odot = \oplus$  then  $B_l \odot B_r$  cannot be sequentializing. Removing the sequentializing  $B_l \otimes B_r$  gives two proof-nets, with a partition of the  $A_i$  into two classes: those linked to leaves of  $B_l$  and the others linked to leaves of  $B_r$ . We recover from these proof-nets bipartite ax-unique ones by adding  $\wp$ -vertices under the  $A_i$  in an arbitrary order, yielding formulas  $A'_l$  (with those linked to  $B_l$ ) and  $A'_r$  (with those linked to  $B_r$ ). As we only removed and put back  $\wp$ -vertices,  $A'_l \wp A'_r$  is equal to  $A_l \wp A_r$  up to associativity and commutativity of  $\wp$ .  $\square$

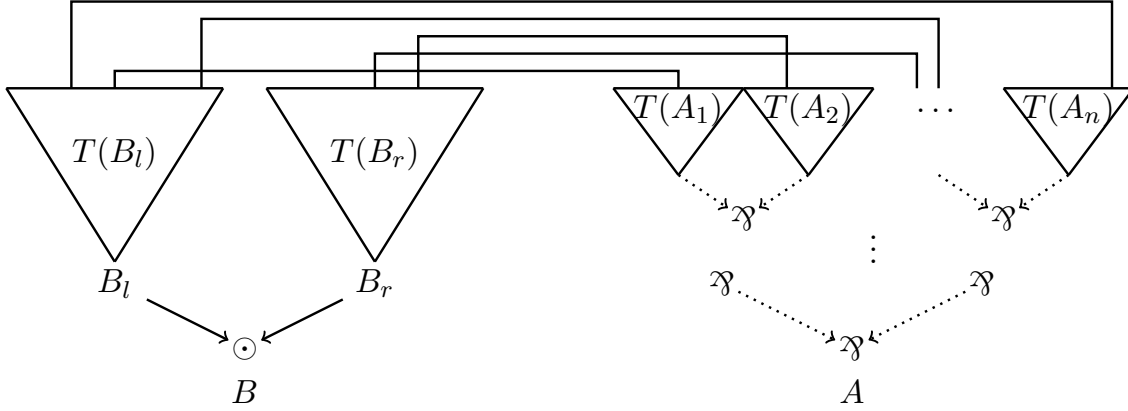
Figure 15: Proof-net of Lemma 8.35 with all terminal  $\wp$ -vertices removed

**Lemma 8.36** (Reordering  $\&$ -vertices). *Let  $\theta$  be a bipartite  $ax$ -unique proof-net of conclusions  $A = A_l \& A_r$  and  $B = B_l \oplus B_r$  with  $A$  a distributed formula. Then there exist two bipartite  $ax$ -unique proof-nets of respective conclusions  $A'_l, B_l$  and  $A'_r, B_r$  where  $A'_l \& A'_r$  is equal to  $A_l \& A_r$  up to associativity and commutativity of  $\&$ .*

*Proof.* We remove all terminal  $\&$ -vertices in the proof-net, then all terminal  $\wp$ -vertices, all in  $A$ . The resulting graphs are proof-nets  $\theta_i$  (for terminal negative vertices are sequentializing), of conclusions  $A_1^i, \dots, A_{n_i}^i, B_l \oplus B_r$  for the  $i$ -th proof-net. An illustration is Figure 15, except we have several of these proof-nets, having in common exactly  $T(B)$ . As in the proof of Lemma 8.35, the roots of the new trees  $A_j^i$  cannot be negative vertices because the formula  $A$  is distributed: so they are  $\otimes \setminus \oplus$ -vertices or atoms. These  $\otimes \setminus \oplus$ -vertices cannot be sequentializing, since by bipartiteness and fullness every leaf of  $A_j^i$  is connected to the formula  $B_l \oplus B_r$  (reasoning as in the proof of Lemma 8.34). Thus, the sequentializing vertex of these proof-nets is necessarily  $B_l \oplus B_r$ , we can remove it: for a given  $i$ , all  $A_j^i$  are linked only to either  $B_l$  or  $B_r$ . We put back the  $\wp$ -vertices we removed, in the very same order. We then put back the  $\&$ -vertices we removed, but in another order: we put together all  $\theta_i$  linked to  $B_l$ , and all those to  $B_r$ , yielding two proof-nets of conclusions  $B_l, A'_l$  and  $B_r, A'_r$ . These proof-nets are bipartite  $ax$ -unique ones (because adding and removing  $\wp$  does not modify the linkings, and  $\&$  is disjoint union of linkings). We indeed have  $A'_l \& A'_r$  equal to  $A_l \& A_r$  up to associativity and commutativity of  $\&$ , because we only reordered  $\&$ -vertices.  $\square$

We conclude by induction on the size  $s(A)$  of  $A$ , which we recall is its number of connectives, and is thus unaffected by commutation and associativity of connectives.

**Theorem 8.37** (Isomorphisms completeness for unit-free MALL). *Given  $A$  and  $B$  two unit-free MALL formulas, if  $A \simeq_{\theta, \psi} B$  for some proof-nets  $\theta$  and  $\psi$ , then  $A =_{\mathcal{L}^\dagger} B$ .*

*Proof.* We assume  $A$  and  $B$  to be distributed and non-ambiguous formulas by Proposition 5.3 and Corollary 8.26. We reason by induction on the size of  $A$ ,  $s(A)$ .<sup>4</sup>

If  $A$  and  $B$  are atoms (*i.e.* of null size), then the axiom link in  $\theta$  between  $A^\perp$  and  $B$  yields  $A = B$  and the property holds. Otherwise,  $A^\perp$  and  $B$  are *both* non atomic. By

<sup>4</sup>Remark that  $s(A) = s(B)$ , because  $\theta$  is bipartite  $ax$ -unique (Theorem 8.20), thence  $A$  and  $B$  have the same number of atoms, so of connectives as they are all binary ones.

Theorem 8.20,  $\theta$  and  $\psi$  are bipartite  $ax$ -unique; they have respective conclusions  $A^\perp, B$  and  $B^\perp, A$ . By Lemma 8.34, one of the formulas  $A^\perp, B$  is negative, otherwise neither the root of  $A^\perp$  nor  $B$  is sequentializing in  $\theta$ , contradicting sequentialization (Theorem 7.2). A symmetric reasoning on  $\psi$  implies that the other formula is positive. Assume *w.l.o.g.* that  $B = B_0 \odot B_1$  is positive (*i.e.*  $\odot \in \{\otimes; \oplus\}$ ) and  $A^\perp$  negative. We distinguish cases according to the kind of the roots of  $A^\perp$  and  $B$ , considering the proof-net  $\theta$ . If  $B$  a  $\otimes$ -formula and  $A$  a  $\&$ -formula, we instead consider  $\psi$  of conclusions  $B^\perp, A$ , where  $A$  is a  $\oplus$ -formula and  $B^\perp$  a  $\wp$ -formula. Whence, either  $A^\perp$  is a  $\wp$ -formula, or  $B$  and  $A^\perp$  are respectively a  $\oplus$ -formula and a  $\&$ -formula.

In the first (resp. second) case, by Lemma 8.35 (resp. Lemma 8.36)  $\odot = \otimes$  (in the first case only) and there exist two bipartite  $ax$ -unique proof-nets  $\theta_0$  and  $\theta_1$  of respective conclusions  $A_0'^\perp, B_0$  and  $A_1'^\perp, B_1$ , with  $A'^\perp = A_1'^\perp \wp A_0'^\perp$  (resp.  $A'^\perp = A_1'^\perp \& A_0'^\perp$ ) equal to  $A^\perp$  up to associativity and commutativity of  $\wp$  (resp.  $\&$ ). In particular,  $A'^\perp =_{\mathcal{L}^\dagger} A^\perp$ , and  $s(A_0')$  and  $s(A_1')$  are both less than  $s(A)$ . To conclude, we only need bipartite proof-nets  $\psi_0$  and  $\psi_1$  of respective conclusions  $B_0^\perp, A_0'$  and  $B_1^\perp, A_1'$ . We will then apply Theorem 8.32 to obtain  $A_0' \simeq_{\theta_0, \psi_0} B_0$  and  $A_1' \simeq_{\theta_1, \psi_1} B_1$ . Thence, by induction hypothesis,  $A_0' =_{\mathcal{L}^\dagger} B_0$  and  $A_1' =_{\mathcal{L}^\dagger} B_1$ , thus  $A' =_{\mathcal{L}^\dagger} B$ .<sup>5</sup> As  $A =_{\mathcal{L}^\dagger} A'$ , we will finally conclude  $A =_{\mathcal{L}^\dagger} B$ .

Thus, we look for two bipartite proof-nets of respective conclusions  $B_0^\perp, A_0'$  and  $B_1^\perp, A_1'$ . As  $A \simeq B$ , and  $A \simeq A'$  by soundness of  $\mathcal{L}^\dagger$  (Theorem 2.11), it follows using Theorem 7.10 that  $A' \simeq_{\Theta, \Theta'} B$  for some proof-nets  $\Theta$  and  $\Theta'$ .<sup>6</sup> Furthermore,  $\Theta$  is a bipartite  $ax$ -unique proof-net (Theorem 8.20) of conclusions  $B^\perp, A'$ , *i.e.* of conclusions  $B_1^\perp \odot^\perp B_0^\perp, A_0' \odot A_1'$  with  $(\odot^\perp, \odot) \in \{(\wp, \otimes); (\&, \oplus)\}$ . We had a bipartite  $ax$ -unique proof-net  $\theta_0$  of conclusions  $A_0'^\perp, B_0$ , therefore the atoms or negated atoms of  $B_0$  are exactly those of  $A_0'$ . Similarly, the atoms and negated atoms of  $B_1$  are exactly those of  $A_1'$ . Whence, no atom nor negated atom of  $B_0$  (resp.  $B_1$ ) is one of  $A_1'$  (resp.  $A_0'$ ), for otherwise an atom or negated atom of  $A_0$  (resp.  $A_1$ ) also occurs in  $A_1'$  (resp.  $A_0'$ ), contradicting non-ambiguousness of  $A'$ . This implies that axiom links in  $\Theta$  must be between leaves of  $B_0^\perp$  and  $A_0'$ , and between leaves of  $B_1^\perp$  and  $A_1'$ . Therefore, once we sequentialize the negative root  $\odot^\perp$  of  $B^\perp$  in  $\Theta$ , the positive root  $\odot$  of  $A'$  is sequentializing. After sequentializing both, we obtain two bipartite  $ax$ -unique proof-nets, of respective conclusions  $B_0^\perp, A_0'$  and  $B_1^\perp, A_1'$ .  $\square$

The above theorem, associated with preceding results, yields our main contribution.

**Theorem 8.38** (Isomorphisms completeness).

$\mathcal{L}^\dagger$  is complete for unit-free MALL: Given  $A$  and  $B$  two unit-free MALL formulas, if  $A \simeq B$ , then  $A =_{\mathcal{L}^\dagger} B$ .

$\mathcal{L}$  is complete for MALL: Given  $A$  and  $B$  two MALL formulas, if  $A \simeq B$ , then  $A =_{\mathcal{L}} B$ .

*Proof.* For  $A$  and  $B$  unit-free formulas such that  $A \simeq B$ , using Theorem 7.10 there exist proof-nets  $\theta$  and  $\psi$  such that  $A \simeq_{\theta, \psi} B$ . The first point then follows by Theorem 8.37.

The second point results from the first one and Theorem 5.16.  $\square$

<sup>5</sup>The formula  $A'$  is distributed for it is equal up to associativity and commutativity to the distributed  $A$ . Whence,  $A_0'$  and  $A_1'$  are also distributed.

<sup>6</sup>One can easily check that isomorphisms in proof-nets form equivalence classes on formulas.

$$\mathcal{D} \left\{ \begin{array}{l} F \otimes (G \otimes H) = (F \otimes G) \otimes H \quad F \otimes G = G \otimes F \quad F \otimes 1 = F \\ (F \otimes G) \multimap H = F \multimap (G \multimap H) \quad 1 \multimap F = F \\ \\ F \& (G \& H) = (F \& G) \& H \quad F \& G = G \& F \quad F \& \top = F \\ F \multimap (G \& H) = (F \multimap G) \& (F \multimap H) \quad F \multimap \top = \top \\ \\ (F \multimap \perp) \multimap \perp = F \end{array} \right\} \mathcal{S}$$

Table 7: Type isomorphisms in  $\star$ -autonomous categories with finite products

## 9. STAR-AUTONOMOUS CATEGORIES WITH FINITE PRODUCTS

Since MALL semantically corresponds to  $\star$ -autonomous categories with finite products (which also have finite coproducts), we can use our results on MALL to characterize isomorphisms valid in all such categories. For the historical result of how linear logic can be seen as a category, see [See89].

We consider objects of  $\star$ -autonomous categories described by formulas in the language:

$$F := X \mid F \otimes F \mid 1 \mid F \multimap F \mid \perp \mid F \& F \mid \top$$

There is some redundancy here since one could define 1 as  $\perp \multimap \perp$  in any  $\star$ -autonomous category, but we prefer to keep 1 in the language as it is at the core of monoidal categories. Our goal is to prove the theory  $\mathcal{D}$  of Table 7 to be sound and complete for the isomorphisms of  $\star$ -autonomous categories with finite products.

We establish this result from the one on MALL, first proving that MALL (with proofs considered up to  $\beta\eta$ -equality) defines a  $\star$ -autonomous category with finite products (Section 9.1). Then, we conclude using a semantic method based on this syntactic category (Section 9.2). In a third step we look at the more general case of symmetric monoidal closed categories – without the requirement of a dualizing object (Section 9.3).

**9.1. MALL as a star-autonomous category with finite products.** The logic MALL, with proofs taken up to  $\beta\eta$ -equality, defines a  $\star$ -autonomous category with finite products, that we will call **MALL**. Indeed, we can define it as follows.

Objects of **MALL** are formulas of MALL, while its morphisms from  $A$  to  $B$  are proofs of  $\vdash A^\perp, B$ , considered up to  $\beta\eta$ -equality.<sup>7</sup> One can check that a proof of MALL is an isomorphism if and only if, when seen as a morphism, it is an isomorphism in **MALL**.

We define a bifunctor  $\otimes$  on **MALL**, associating to formulas (*i.e.* objects)  $A$  and  $B$  the formula  $A \otimes B$  and to proofs (*i.e.* morphisms)  $\pi_0$  and  $\pi_1$  respectively of  $\vdash A_0^\perp, B_0$  and  $\vdash A_1^\perp, B_1$  the following proof of  $\vdash (A_0 \otimes A_1)^\perp, B_0 \otimes B_1$ :

$$\frac{\frac{\pi_0 \quad \pi_1}{\vdash A_0^\perp, B_0 \quad \vdash A_1^\perp, B_1} \otimes}{\vdash A_1^\perp, A_0^\perp, B_0 \otimes B_1} \wp$$

$$\frac{}{\vdash A_1^\perp \wp A_0^\perp, B_0 \otimes B_1} \wp$$

One can check that (**MALL**,  $\otimes$ , 1,  $\alpha$ ,  $\lambda$ ,  $\rho$ ,  $\gamma$ ) forms a symmetric monoidal category, where 1 is the 1-formula,  $\alpha$  are isomorphisms of MALL associated to  $(A \otimes B) \otimes C \simeq A \otimes (B \otimes C)$  seen

<sup>7</sup>We recall that  $(\cdot)^\perp$  is defined by induction, making it an involution.

as natural isomorphisms of  $\mathbb{MALL}$ , and similarly for  $\lambda$  with  $1 \otimes A \simeq A$ ,  $\rho$  with  $A \otimes 1 \simeq A$ , and  $\gamma$  with  $A \otimes B \simeq B \otimes A$ .

Furthermore, define  $A \multimap B := A^\perp \wp B$  and  $ev_{A,B}$  as the following morphism from  $A \otimes (A \multimap B)$  to  $B$  (i.e. a proof of  $\vdash (B^\perp \otimes A) \wp A^\perp, B$ ):

$$\frac{\frac{\frac{\overline{\vdash B^\perp, B} \quad ax}{\vdash B^\perp \otimes A, A^\perp, B} \otimes}{\vdash (B^\perp \otimes A) \wp A^\perp, B} \wp}{\vdash (B^\perp \otimes A) \wp A^\perp, B} \wp$$

It can be checked that  $\mathbb{MALL}$  is a symmetric monoidal closed category with as exponential object  $(A \multimap B, ev_{A,B})$  for objects  $A$  and  $B$ .

Moreover, one can also check that  $\perp$  is a dualizing object for this category, making  $\mathbb{MALL}$  a  $\star$ -autonomous category. This relies on the following morphism from  $(A \multimap \perp) \multimap \perp$  to  $A$  (which is an inverse of the currying of  $ev_{A,\perp}$ ):

$$\frac{\frac{\frac{\overline{\vdash A^\perp, A} \quad ax}{\vdash A^\perp, \perp, A} \perp}{\vdash A^\perp \wp \perp, A} \wp}{\vdash 1 \otimes (A^\perp \wp \perp), A} \otimes$$

Finally,  $\top$  is a terminal object of  $\mathbb{MALL}$ , and  $A \& B$  is the product of objects  $A$  and  $B$ , with, as projections  $\pi_A$  and  $\pi_B$ , the following morphisms respectively from  $A \& B$  to  $A$  and from  $A \& B$  to  $B$ :

$$\frac{\overline{\vdash A^\perp, A} \quad ax}{\vdash B^\perp \oplus A^\perp, A} \oplus_2 \quad \text{and} \quad \frac{\overline{\vdash B^\perp, B} \quad ax}{\vdash B^\perp \oplus A^\perp, B} \oplus_1$$

Therefore,  $\mathbb{MALL}$  is a  $\star$ -autonomous category with finite products [See89].

**9.2. Isomorphisms of star-autonomous categories with finite products.** We translate formulas in the language of  $\star$ -autonomous categories with finite products into  $\mathbb{MALL}$  formulas and conversely by means of the following translations:

$$\begin{array}{ll} \ell(X) = X & \partial(X) = X \\ \ell(F \otimes G) = \ell(F) \otimes \ell(G) & \partial(X^\perp) = X \multimap \perp \\ \ell(1) = 1 & \partial(A \otimes B) = \partial(A) \otimes \partial(B) \\ \ell(F \multimap G) = \ell(F)^\perp \wp \ell(G) & \partial(1) = 1 \\ \ell(\perp) = \perp & \partial(A \wp B) = ((\partial(A) \multimap \perp) \otimes (\partial(B) \multimap \perp)) \multimap \perp \\ \ell(F \& G) = \ell(F) \& \ell(G) & \partial(\perp) = \perp \\ \ell(\top) = \top & \partial(A \& B) = \partial(A) \& \partial(B) \\ & \partial(\top) = \top \\ & \partial(A \oplus B) = ((\partial(A) \multimap \perp) \& (\partial(B) \multimap \perp)) \multimap \perp \\ & \partial(0) = \top \multimap \perp \end{array}$$

The translation  $\ell(\cdot)$  corresponds exactly to the interpretation of the constructions on objects of a  $\star$ -autonomous categories with finite products in the concrete category  $\mathbb{MALL}$ .

**Lemma 9.1.** *The  $\partial(\cdot)$  and  $\ell(\cdot)$  translations satisfy the following properties:*

- $\partial(A^\perp) =_{\mathcal{D}} \partial(A) \multimap \perp$
- $\partial(\ell(F)) =_{\mathcal{D}} F$
- $A =_{\mathcal{L}} B$  entails  $\partial(A) =_{\mathcal{D}} \partial(B)$



*Proof.* The second property relies on the first while the third is independent.

- By induction on  $A$ :

$$\begin{aligned}
\partial(X^\perp) &= X \multimap \perp =_{\mathcal{D}} \partial(X) \multimap \perp \\
\partial(X^{\perp\perp}) &= \partial(X) = X =_{\mathcal{D}} (X \multimap \perp) \multimap \perp = \partial(X^\perp) \multimap \perp \\
\partial((A \otimes B)^\perp) &= ((\partial(B^\perp) \multimap \perp) \otimes (\partial(A^\perp) \multimap \perp)) \multimap \perp \\
&=_{\mathcal{D}} (((\partial(A) \multimap \perp) \multimap \perp) \otimes ((\partial(B) \multimap \perp) \multimap \perp)) \multimap \perp \\
&=_{\mathcal{D}} (\partial(A) \otimes \partial(B)) \multimap \perp = \partial(A \otimes B) \multimap \perp \\
\partial(1^\perp) &= \perp =_{\mathcal{D}} 1 \multimap \perp = \partial(1) \multimap \perp \\
\partial((A \wp B)^\perp) &= \partial(B^\perp) \otimes \partial(A^\perp) =_{\mathcal{D}} (\partial(A) \multimap \perp) \otimes (\partial(B) \multimap \perp) \\
&=_{\mathcal{D}} (((\partial(A) \multimap \perp) \otimes (\partial(B) \multimap \perp)) \multimap \perp) \multimap \perp \\
&= \partial(A \wp B) \multimap \perp \\
\partial(\perp^\perp) &= 1 =_{\mathcal{D}} (1 \multimap \perp) \multimap \perp =_{\mathcal{D}} \perp \multimap \perp = \partial(\perp) \multimap \perp \\
\partial((A \& B)^\perp) &= ((\partial(B^\perp) \multimap \perp) \& (\partial(A^\perp) \multimap \perp)) \multimap \perp \\
&=_{\mathcal{D}} (((\partial(A) \multimap \perp) \multimap \perp) \& ((\partial(B) \multimap \perp) \multimap \perp)) \multimap \perp \\
&=_{\mathcal{D}} (\partial(A) \& \partial(B)) \multimap \perp = \partial(A \& B) \multimap \perp \\
\partial(\top^\perp) &= \top \multimap \perp = \partial(\top) \multimap \perp \\
\partial((A \oplus B)^\perp) &= \partial(B^\perp) \& \partial(A^\perp) =_{\mathcal{D}} (\partial(A) \multimap \perp) \& (\partial(B) \multimap \perp) \\
&=_{\mathcal{D}} (((\partial(A) \multimap \perp) \& (\partial(B) \multimap \perp)) \multimap \perp) \multimap \perp \\
&= \partial(A \oplus B) \multimap \perp \\
\partial(0^\perp) &= \top =_{\mathcal{D}} (\top \multimap \perp) \multimap \perp = \partial(0) \multimap \perp
\end{aligned}$$

- By induction on  $F$ , the key case being:

$$\begin{aligned}
\partial(\ell(F \multimap G)) &= \partial(\ell(F)^\perp \wp \ell(G)) = ((\partial(\ell(F)^\perp) \multimap \perp) \otimes (\partial(\ell(G)) \multimap \perp)) \multimap \perp \\
&=_{\mathcal{D}} (((F \multimap \perp) \multimap \perp) \otimes (G \multimap \perp)) \multimap \perp =_{\mathcal{D}} (F \otimes (G \multimap \perp)) \multimap \perp \\
&=_{\mathcal{D}} F \multimap ((G \multimap \perp) \multimap \perp) =_{\mathcal{D}} F \multimap G
\end{aligned}$$

- We prove that the image of each equation of Table 1 through  $\partial(\cdot)$  is derivable with equations of Table 7. Commutativity, associativity and unitality for  $\otimes$  and  $\&$  are immediate.

$$\begin{aligned}\partial(A \wp B) &= ((\partial(A) \multimap \perp) \otimes (\partial(B) \multimap \perp)) \multimap \perp \\ &=_{\mathcal{D}} ((\partial(B) \multimap \perp) \otimes (\partial(A) \multimap \perp)) \multimap \perp = \partial(B \wp A)\end{aligned}$$

$$\begin{aligned}\partial(A \wp (B \wp C)) &= ((\partial(A) \multimap \perp) \otimes (((\partial(B) \multimap \perp) \otimes (\partial(C) \multimap \perp)) \multimap \perp) \multimap \perp)) \multimap \perp \\ &=_{\mathcal{D}} ((\partial(A) \multimap \perp) \otimes ((\partial(B) \multimap \perp) \otimes (\partial(C) \multimap \perp))) \multimap \perp \\ &=_{\mathcal{D}} (((\partial(A) \multimap \perp) \otimes (\partial(B) \multimap \perp)) \otimes (\partial(C) \multimap \perp)) \multimap \perp \\ &=_{\mathcal{D}} (((((\partial(A) \multimap \perp) \otimes (\partial(B) \multimap \perp) \multimap \perp) \multimap \perp) \otimes (\partial(C) \multimap \perp)) \multimap \perp \\ &= \partial((A \wp B) \wp C)\end{aligned}$$

$$\begin{aligned}\partial(A \wp \perp) &= ((\partial(A) \multimap \perp) \otimes (\perp \multimap \perp)) \multimap \perp \\ &=_{\mathcal{D}} ((\partial(A) \multimap \perp) \otimes ((1 \multimap \perp) \multimap \perp)) \multimap \perp =_{\mathcal{D}} ((\partial(A) \multimap \perp) \otimes 1) \multimap \perp \\ &=_{\mathcal{D}} (\partial(A) \multimap \perp) \multimap \perp =_{\mathcal{D}} \partial(A)\end{aligned}$$

Commutativity, associativity and unitality for  $\oplus$  follow the same pattern as for  $\wp$ .

Then we have:

$$\begin{aligned}\partial(A \otimes (B \oplus C)) &= \partial(A) \otimes (((\partial(B) \multimap \perp) \& (\partial(C) \multimap \perp)) \multimap \perp) \\ &=_{\mathcal{D}} ((\partial(A) \otimes (((\partial(B) \multimap \perp) \& (\partial(C) \multimap \perp)) \multimap \perp)) \multimap \perp) \multimap \perp \\ &=_{\mathcal{D}} (\partial(A) \multimap (((\partial(B) \multimap \perp) \& (\partial(C) \multimap \perp)) \multimap \perp) \multimap \perp) \multimap \perp \\ &=_{\mathcal{D}} (\partial(A) \multimap ((\partial(B) \multimap \perp) \& (\partial(C) \multimap \perp))) \multimap \perp \\ &=_{\mathcal{D}} ((\partial(A) \multimap (\partial(B) \multimap \perp)) \& (\partial(A) \multimap (\partial(C) \multimap \perp))) \multimap \perp \\ &=_{\mathcal{D}} (((\partial(A) \otimes \partial(B)) \multimap \perp) \& ((\partial(A) \otimes \partial(C)) \multimap \perp)) \multimap \perp \\ &= \partial((A \otimes B) \oplus (A \otimes C))\end{aligned}$$

$$\begin{aligned}\partial(A \otimes 0) &= \partial(A) \otimes (\top \multimap \perp) \\ &=_{\mathcal{D}} ((\partial(A) \otimes (\top \multimap \perp)) \multimap \perp) \multimap \perp \\ &=_{\mathcal{D}} (\partial(A) \multimap ((\top \multimap \perp) \multimap \perp)) \multimap \perp \\ &=_{\mathcal{D}} (\partial(A) \multimap \top) \multimap \perp \\ &=_{\mathcal{D}} \top \multimap \perp = \partial(0)\end{aligned}$$

$$\begin{aligned}\partial(A \wp (B \& C)) &= ((\partial(A) \multimap \perp) \otimes ((\partial(B) \& \partial(C)) \multimap \perp)) \multimap \perp \\ &=_{\mathcal{D}} (\partial(A) \multimap \perp) \multimap (((\partial(B) \& \partial(C)) \multimap \perp) \multimap \perp) \\ &=_{\mathcal{D}} (\partial(A) \multimap \perp) \multimap (\partial(B) \& \partial(C)) \\ &=_{\mathcal{D}} ((\partial(A) \multimap \perp) \multimap \partial(B)) \& ((\partial(A) \multimap \perp) \multimap \partial(C)) \\ &=_{\mathcal{D}} ((\partial(A) \multimap \perp) \multimap ((\partial(B) \multimap \perp) \multimap \perp)) \& ((\partial(A) \multimap \perp) \multimap ((\partial(C) \multimap \perp) \multimap \perp)) \\ &=_{\mathcal{D}} (((\partial(A) \multimap \perp) \otimes (\partial(B) \multimap \perp)) \multimap \perp) \& (((\partial(A) \multimap \perp) \otimes (\partial(C) \multimap \perp)) \multimap \perp) \\ &= \partial((A \wp B) \& (A \wp C))\end{aligned}$$

$$\begin{aligned}\partial(A \wp \top) &= ((\partial(A) \multimap \perp) \otimes (\top \multimap \perp)) \multimap \perp \\ &=_{\mathcal{D}} (\partial(A) \multimap \perp) \multimap ((\top \multimap \perp) \multimap \perp) \\ &=_{\mathcal{D}} (\partial(A) \multimap \perp) \multimap \top =_{\mathcal{D}} \top = \partial(\top)\end{aligned}$$

□

**Theorem 9.2** (Isomorphisms in  $\star$ -autonomous categories with finite products). *The equational theory  $\mathcal{D}$  (Table 7) is sound and complete for isomorphisms in  $\star$ -autonomous categories with finite products.*

*Proof.* Soundness follows by definition of  $\star$ -autonomous categories with finite products. For completeness, take an isomorphism  $F \simeq G$ . It yields an isomorphism  $\ell(F) \simeq \ell(G)$  in MALL. As  $A \simeq B$  in MALL is generated by  $\mathcal{L}$  (Theorem 8.38), we get  $\ell(F) =_{\mathcal{L}} \ell(G)$ . From Lemma 9.1, we deduce  $F =_{\mathcal{D}} \partial(\ell(F)) =_{\mathcal{D}} \partial(\ell(G)) =_{\mathcal{D}} G$ . □

**9.3. Isomorphisms of symmetric monoidal closed categories with finite products.** Isomorphisms in symmetric monoidal closed categories (SMCC) have been characterized [DP97] and proved to correspond to equations in the first two lines of Table 7.

We want to extend this result to finite products by proving the soundness and completeness of the theory  $\mathcal{S}$  presented in Table 7.

**Theorem 9.3** (Isomorphisms in SMCC with finite products). *The equational theory  $\mathcal{S}$  (Table 7) is sound and complete for isomorphisms in symmetric monoidal closed categories with finite products.*

*Proof.* The language of SMCC with finite products is the language of  $\star$ -autonomous categories with finite products in which we remove  $\perp$ . In particular the translation  $\ell(\_)$  can be used to translate the associated formulas into MALL formulas. In order to analyse the image of this restricted translation, we consider the following grammar of MALL formulas (*output formulas*  $o$  and *input formulas*  $\iota$  [Lam96]):

$$\begin{array}{l} o := X \quad | \quad o \otimes o \quad | \quad o \wp \iota \quad | \quad \iota \wp o \quad | \quad 1 \quad | \quad o \& o \quad | \quad \top \\ \iota := X^\perp \quad | \quad \iota \wp \iota \quad | \quad \iota \otimes o \quad | \quad o \otimes \iota \quad | \quad \perp \quad | \quad \iota \oplus \iota \quad | \quad 0 \end{array}$$

The dual of an output formula is an input formula and conversely. Moreover no MALL formula is both an input and an output formula – let us call this the *non-ambiguity property*. One can check by induction on a formula  $F$  in the language of SMCC with finite products that  $\ell(F)$  is an output formula. We define a translation back from output formulas to SMCC formulas (which is well defined thanks to the non-ambiguity property):

$$\begin{array}{l} X^\circ = X \\ (o \otimes o')^\circ = o^\circ \otimes o'^\circ \qquad 1^\circ = 1 \\ (o \& o')^\circ = o^\circ \& o'^\circ \qquad \top^\circ = \top \\ (o \wp \iota)^\circ = (\iota^\perp)^\circ \multimap o^\circ \qquad (\iota \wp o)^\circ = (\iota^\perp)^\circ \multimap o^\circ \end{array}$$

We use the notation  $\iota^\bullet = (\iota^\perp)^\circ$  (so that  $(o^\perp)^\bullet = o^\circ$ ). We can check, by induction on  $F$ , that  $\ell(F)^\circ = F$ . We now prove that when  $o =_{\mathcal{L}} A$  (resp.  $\iota =_{\mathcal{L}} A$ ) is an equation from Table 1 (or its symmetric version) then  $A$  is an output (resp. input) formula and  $o^\circ =_{\mathcal{S}} A^\circ$  (resp.  $\iota^\bullet =_{\mathcal{S}} A^\bullet$ ):

- If  $o$  or  $\iota$  is of the shape  $A \otimes (B \otimes C)$ , we have the following possibilities:
  - $A, B$  and  $C$  are output, then  $(A \otimes B) \otimes C$  is output and:

$$\begin{aligned} (A \otimes (B \otimes C))^\circ &= A^\circ \otimes (B^\circ \otimes C^\circ) \\ &=_{\mathcal{S}} (A^\circ \otimes B^\circ) \otimes C^\circ = ((A \otimes B) \otimes C)^\circ \end{aligned}$$

–  $A$  and  $B$  are output and  $C$  is input, then  $(A \otimes B) \otimes C$  is input and:

$$\begin{aligned} (A \otimes (B \otimes C))^\bullet &= A^\circ \multimap (B^\circ \multimap C^\bullet) \\ &=_{\mathcal{S}} (A^\circ \otimes B^\circ) \multimap C^\bullet = ((A \otimes B) \otimes C)^\bullet \end{aligned}$$

–  $A$  and  $C$  are output and  $B$  is input, then  $(A \otimes B) \otimes C$  is input and:

$$\begin{aligned} (A \otimes (B \otimes C))^\bullet &= A^\circ \multimap (C^\circ \multimap B^\bullet) \\ &=_{\mathcal{S}} (A^\circ \otimes C^\circ) \multimap B^\bullet =_{\mathcal{S}} (C^\circ \otimes A^\circ) \multimap B^\bullet \\ &=_{\mathcal{S}} C^\circ \multimap (A^\circ \multimap B^\bullet) = ((A \otimes B) \otimes C)^\bullet \end{aligned}$$

–  $A$  is input and  $B$  and  $C$  are output, then  $(A \otimes B) \otimes C$  is input and:

$$\begin{aligned} (A \otimes (B \otimes C))^\bullet &= (B^\circ \otimes C^\circ) \multimap A^\bullet \\ &=_{\mathcal{S}} (C^\circ \otimes B^\circ) \multimap A^\bullet \\ &=_{\mathcal{S}} C^\circ \multimap (B^\circ \multimap A^\bullet) = ((A \otimes B) \otimes C)^\bullet \end{aligned}$$

The symmetric case follows the same pattern, as well as associativity of  $\wp$ .

- If  $o$  or  $\iota$  is of the shape  $A \otimes B$ , we have the following possibilities:
  - $A$  and  $B$  are output, then  $B \otimes A$  is output and  $(A \otimes B)^\circ = A^\circ \otimes B^\circ =_{\mathcal{S}} B^\circ \otimes A^\circ = (B \otimes A)^\circ$
  - $A$  is output and  $B$  is input, then  $B \otimes A$  is input and  $(A \otimes B)^\bullet = A^\circ \multimap B^\bullet = (B \otimes A)^\bullet$
  - $A$  is input and  $B$  is output, then  $B \otimes A$  is input and  $(A \otimes B)^\bullet = B^\circ \multimap A^\bullet = (B \otimes A)^\bullet$
- The commutativity of  $\wp$  follows the same pattern.
- If  $o$  or  $\iota$  is of the shape  $A \otimes 1$  then either  $A$  is output and  $(A \otimes 1)^\circ = A^\circ \otimes 1 =_{\mathcal{S}} A^\circ$ , or  $A$  is input and  $(A \otimes 1)^\bullet = 1 \multimap A^\bullet =_{\mathcal{S}} A^\bullet$ . The symmetric case follows the same pattern, as well as unitality for  $\wp$ .
- If  $o = A \& (B \& C)$  then  $A$ ,  $B$  and  $C$  are output and  $(A \& B) \& C$  as well. We have  $(A \& (B \& C))^\circ = A^\circ \& (B^\circ \& C^\circ) =_{\mathcal{S}} (A^\circ \& B^\circ) \& C^\circ = ((A \& B) \& C)^\circ$ . The symmetric case follows the same pattern, as well as associativity of  $\oplus$ .
- If  $o = A \& B$  then  $A$  and  $B$  are output and  $B \& A$  as well. We have  $(A \& B)^\circ = A^\circ \& B^\circ =_{\mathcal{S}} B^\circ \& A^\circ = (B \& A)^\circ$ . The commutativity of  $\oplus$  follows the same pattern.
- If  $o = A \& \top$  then  $A$  is output and  $(A \& \top)^\circ = A^\circ \& \top =_{\mathcal{S}} A^\circ$ . The symmetric case follows the same pattern, as well as unitality for  $\oplus$ .
- If  $\iota = A \otimes (B \oplus C)$  then  $A$  is output and  $B$  and  $C$  are input, and  $(A \otimes B) \oplus (A \otimes C)$  is input. We have:

$$\begin{aligned} (A \otimes (B \oplus C))^\bullet &= A^\circ \multimap (C^\bullet \& B^\bullet) \\ &=_{\mathcal{S}} (A^\circ \multimap C^\bullet) \& (A^\circ \multimap B^\bullet) = ((A \otimes B) \oplus (A \otimes C))^\bullet \end{aligned}$$

The symmetric case follows the same pattern, as well as distributivity of  $\wp$  over  $\&$ .

- If  $\iota = A \otimes 0$  then  $A$  is output and  $(A \otimes 0)^\bullet = A^\circ \multimap \top =_{\mathcal{S}} \top = 0^\bullet$ . The symmetric case follows the same pattern, as well as cancellation of  $\wp$  by  $\top$ .

Assume now that  $F \simeq G$  in the class of SMCC with finite products. As MALL is such a SMCC with finite products, we have  $\ell(F) \simeq \ell(G)$  in MALL, thus  $\ell(F) =_{\mathcal{L}} \ell(G)$  by Theorem 8.38. As  $\ell(F)$  is an output formula, by induction on the length of the equational derivation of  $\ell(F) =_{\mathcal{L}} \ell(G)$ , we get that all the intermediary steps involve output formulas and each equation is mapped to  $=_{\mathcal{S}}$  by  $(-)^{\circ}$  so that  $\ell(F)^{\circ} =_{\mathcal{S}} \ell(G)^{\circ}$ , and finally  $F =_{\mathcal{S}} \ell(F)^{\circ} =_{\mathcal{S}} \ell(G)^{\circ} =_{\mathcal{S}} G$ .

Conversely soundness easily comes from the definition of SMCC and products.  $\square$

In  $\star$ -autonomous categories with finite products, we automatically have finite coproducts given by  $A \oplus B := ((A \multimap \perp) \& (B \multimap \perp)) \multimap \perp$  and  $0 := \top \multimap \perp$ . From equations of Table 7, one can derive:

$$\left. \begin{array}{l} A \oplus B = B \oplus A \\ A \oplus (B \oplus C) = (A \oplus B) \oplus C \\ A \oplus 0 = A \\ A \otimes (B \oplus C) = (A \otimes B) \oplus (A \otimes C) \\ A \otimes 0 = 0 \\ (A \oplus B) \multimap C = (A \multimap C) \& (B \multimap C) \\ 0 \multimap C = \top \end{array} \right\} \mathcal{C}$$

In the weaker setting of SMCC, finite products do not induce finite coproducts. It justifies the possibility of considering them separately. The case of products only was Theorem 9.3. We are now looking at both products and coproducts on one side, and coproducts only on the other side.

As a preliminary result, let us give a necessary condition for formulas to be isomorphic in this symmetric monoidal closed setting.

**Lemma 9.4.** *If  $A \simeq B$  in symmetric monoidal closed categories with finite products and coproducts with  $A$  and  $B$  distributed (i.e.  $\ell(A)$  and  $\ell(B)$  are distributed) then there exist cut-free proofs of  $A \vdash B$  and  $B \vdash A$  in IMALL (intuitionistic multiplicative additive linear logic) [Bie95] whose left  $0$  rules introduce  $0 \vdash 0$  sequents only and right  $\top$  rules introduce  $\top \vdash \top$  sequents only.*

*Proof.* If  $A$  and  $B$  are isomorphic in SMCC with finite products and coproducts, the associated isomorphisms can be represented as IMALL proofs which we can assume to be cut-free. These proofs can be interpreted as MALL proofs (corresponding to the fact that MALL is an SMCC with finite products and coproducts). By Lemma 5.12, these MALL proofs have their  $\top$  rules introducing  $\vdash \top, 0$  sequents only which gives the required property on the IMALL proofs we started with.  $\square$

We conjecture that isomorphisms in SMCC with both finite products *and* finite coproducts correspond to adding the equations of theory  $\mathcal{C}$  to  $\mathcal{S}$  (Table 7). However our approach through  $\star$ -autonomous categories does not work since for example  $\top \multimap (\top \oplus \top)$  and  $(0 \& 0) \multimap 0$  are isomorphic in  $\star$ -autonomous categories but not in SMCC with finite products and coproducts:

$$\begin{aligned} \top \multimap (\top \oplus \top) &=_{\mathcal{D}} \top \multimap (((\top \multimap \perp) \& (\top \multimap \perp)) \multimap \perp) \\ &=_{\mathcal{D}} (\top \otimes (0 \& 0)) \multimap \perp =_{\mathcal{D}} ((0 \& 0) \otimes \top) \multimap \perp \\ &=_{\mathcal{D}} (0 \& 0) \multimap (\top \multimap \perp) =_{\mathcal{D}} (0 \& 0) \multimap 0 \end{aligned}$$

or directly by interpreting these formulas into MALL, one gets:

$$\ell(\top \multimap (\top \oplus \top)) =_{\mathcal{L}} 0 \wp (\top \oplus \top) =_{\mathcal{L}} (\top \oplus \top) \wp 0 =_{\mathcal{L}} \ell((0 \& 0) \multimap 0)$$

(the analogue of the non-ambiguity property does not hold). This isomorphism however is not valid in the SMCC setting as shown by Lemma 9.4 since all cut-free proofs of  $(0 \& 0) \multimap 0 \vdash \top \multimap (\top \oplus \top)$  in IMALL have the following shape:

$$\frac{\frac{\frac{}{(0 \& 0) \multimap 0, \top \vdash \top} \top R}{(0 \& 0) \multimap 0, \top \vdash \top \oplus \top} \oplus_i R}{(0 \& 0) \multimap 0 \vdash \top \multimap (\top \oplus \top)} \multimap R$$

One could also investigate SMCC with finite coproducts only (without products). It is important to notice that an initial object  $0$  in a SMCC induces that  $0 \multimap A$  is a terminal object for any  $A$ . This first means that we cannot uncorelate completely products and coproducts. It also means that the theory of isomorphisms includes the equation  $0 \multimap A \simeq 0 \multimap B$  even if it does not occur in  $\mathcal{C}$  (it might be the only missing equation). Regarding a characterization through  $\star$ -autonomous categories, it is again not possible since, if we denote by  $\top$  a terminal object,  $(\top \multimap 0) \multimap 0$  and  $\top \multimap (\top \otimes \top)$  are isomorphic in  $\star$ -autonomous categories (using  $0 =_{\mathcal{D}} \top \multimap \perp$ ):

$$\begin{aligned} (\top \multimap 0) \multimap 0 &=_{\mathcal{D}} (\top \multimap (\top \multimap \perp)) \multimap (\top \multimap \perp) \\ &=_{\mathcal{D}} ((\top \otimes \top) \multimap \perp) \multimap (\top \multimap \perp) \\ &=_{\mathcal{D}} (((\top \otimes \top) \multimap \perp) \otimes \top) \multimap \perp \\ &=_{\mathcal{D}} (\top \otimes ((\top \otimes \top) \multimap \perp)) \multimap \perp \\ &=_{\mathcal{D}} \top \multimap (((\top \otimes \top) \multimap \perp) \multimap \perp) =_{\mathcal{D}} \top \multimap (\top \otimes \top) \end{aligned}$$

(or  $\ell((\top \multimap 0) \multimap 0) =_{\mathcal{L}} (\top \otimes \top) \wp 0 =_{\mathcal{L}} 0 \wp (\top \otimes \top) =_{\mathcal{L}} \ell(\top \multimap (\top \otimes \top))$  in MALL). But they are not isomorphic in SMCC with initial and terminal objects by Lemma 9.4 since all cut-free proofs of  $(\top \multimap 0) \multimap 0 \vdash \top \multimap (\top \otimes \top)$  in IMALL have the following shape (up to permuting the premises of the  $(\otimes R)$ -rule):

$$\frac{\frac{\frac{}{(\top \multimap 0) \multimap 0 \vdash \top} \top R}{(\top \multimap 0) \multimap 0, \top \vdash \top \otimes \top} \otimes R}{(\top \multimap 0) \multimap 0 \vdash \top \multimap (\top \otimes \top)} \multimap R \quad \text{or} \quad \frac{\frac{\frac{}{(\top \multimap 0) \multimap 0, \top \vdash \top} \top R}{(\top \multimap 0) \multimap 0, \top \vdash \top \otimes \top} \otimes R}{(\top \multimap 0) \multimap 0 \vdash \top \multimap (\top \otimes \top)} \multimap R$$

## 10. CONCLUSION

Extending the result of Balat and Di Cosmo in [BDC99], we give an equational theory characterising type isomorphisms in multiplicative-additive linear logic with units as well as in  $\star$ -autonomous categories with finite products: the one described on Table 1 on page 3 (and on Table 7 for  $\star$ -autonomous categories). Looking at the proof, we get as a sub-result that isomorphisms for additive linear logic (resp. unit-free additive linear logic) are given by the equational theory  $\mathcal{L}$  (resp.  $\mathcal{L}^\dagger$ ) restricted to additive formulas – and more generally this applies to any fragment of MALL, thanks to the sub-formula property. Proof-nets were a major tool to prove completeness, as notions like fullness and *ax*-uniqueness are much harder to define and manipulate in sequent calculus. However, we could not use them for taking care of the (additive) units, because there is no known appropriate notion of proof-nets. We have thus been forced to develop (some parts of) the theory of cut-elimination, axiom-expansion and rule commutations for the sequent calculus of MALL with units.

The immediate question to address is the extension of our results to the characterization of type isomorphisms for full propositional linear logic, thus including the exponential connectives. This is clearly not immediate since the interaction between additive and exponential connectives is not well described in proof-nets.

A more general problem is the study of type retractions (where only one of the two compositions yields an identity) which is also much more difficult (see for example [RU02]). The question is mostly open in the case of linear logic. Even in multiplicative linear logic (where there is for example a retraction between  $A$  and  $(A \multimap A) \multimap A = (A \otimes A^\perp) \wp A$  which is not an isomorphism, and where the associated proof-nets are not bipartite), no characterization is known. In the multiplicative-additive fragment, the problem looks even harder, with more retractions; for instance the one depicted on Figure 5, but there also is a retraction between  $A$  and  $A \oplus A$ .

#### ACKNOWLEDGMENT

This work was performed within the framework of the LABEX MILYON (ANR-10-LABX-0070) of Université de Lyon, within the program “Investissements d’Avenir” (ANR-11-IDEX-0007), and supported by the projects DyVerSe (ANR-19-CE48-0010), QuaReMe (ANR-20-CE48-0005) and ReCiProg (ANR-21-CE48-0019), all operated by the French National Research Agency (ANR). This work was also supported by the IRN Linear Logic.

#### REFERENCES

- [AM98] Michele Abrusci and Elena Maringelli. A new correctness criterion for cyclic proof nets. *Journal of Logic, Language and Information*, 7:449–459, 1998. doi:10.1023/A:1008354130493.
- [ARG21] Clément Allain, Gabriel Radanne, and Laure Gonnord. Isomorphisms are back! In *ML 2021 - ML Workshop*, August 2021. URL: <https://hal.science/hal-03355381>.
- [BDC99] Vincent Balat and Roberto Di Cosmo. A linear logical view of linear type isomorphisms. In Jörg Flum and Mario Rodríguez-Artalejo, editors, *Computer Science Logic*, volume 1683 of *Lecture Notes in Computer Science*, pages 250–265. Springer, 1999.
- [Bie95] Gavin Bierman. What is a categorical model of Linear Logic? In Mariangiola Dezani and Gordon Plotkin, editors, *Typed Lambda Calculi and Applications '95*, volume 902 of *Lecture Notes in Computer Science*. Springer, April 1995.
- [DC95] Roberto Di Cosmo. *Isomorphisms of Types*. Progress in Theoretical Computer Science. Birkhäuser, 1995.
- [DG11] Paolo Di Giamberardino. Jump from parallel to sequential proofs: Additives, 2011. <https://hal.science/hal-00616386>.
- [DGL23] Rémi Di Guardia and Olivier Laurent. Type isomorphisms for multiplicative-additive linear logic. In Marco Gaboardi and Femke van Raamsdonk, editors, *International Conference on Formal Structures for Computation and Deduction (FSCD)*, volume 260 of *Leibniz International Proceedings in Informatics (LIPIcs)*, pages 26:1–26:21. Schloss Dagstuhl – Leibniz-Zentrum fuer Informatik, July 2023. doi:10.4230/LIPIcs.FSCD.2023.26.
- [DP97] Kosta Dosen and Zoran Petric. Isomorphic objects in symmetric monoidal closed categories. *Mathematical Structures in Computer Science*, 7(6):639–662, 1997. doi:10.1017/S0960129596002241.
- [DR89] Vincent Danos and Laurent Regnier. The structure of multiplicatives. *Archive for Mathematical Logic*, 28:181–203, 1989.
- [FDCB02] Marcelo Fiore, Roberto Di Cosmo, and Vincent Balat. Remarks on isomorphisms in typed lambda calculi with empty and sum types. In *Proceedings of the seventeenth annual symposium on Logic In Computer Science*, pages 147–156, Copenhagen, July 2002. IEEE, IEEE Computer Society Press.
- [Gir87] Jean-Yves Girard. Linear logic. *Theoretical Computer Science*, 50:1–102, 1987. doi:10.1016/0304-3975(87)90045-4.
- [Gir96] Jean-Yves Girard. Proof-nets: the parallel syntax for proof-theory. In Aldo Ursini and Paolo Agliano, editors, *Logic and Algebra*, volume 180 of *Lecture Notes In Pure and Applied Mathematics*, pages 97–124, New York, 1996. Marcel Dekker. doi:10.1201/9780203748671-4.

- [HH16] Willem Heijltjes and Dominic Hughes. Conflict nets: Efficient locally canonical MALL proof nets. In *Proceedings of the 31st Annual ACM/IEEE Symposium on Logic in Computer Science (LICS)*, pages 437–446. ACM Press, July 2016. doi:10.1145/2933575.2934559.
- [Hue80] Gérard Huet. Confluent reductions: Abstract properties and applications to term rewriting systems: Abstract properties and applications to term rewriting systems. *Journal of the ACM*, 27(4):797–821, oct 1980. doi:10.1145/322217.322230.
- [HvG05] Dominic Hughes and Rob van Glabbeek. Proof nets for unit-free multiplicative-additive linear logic. *ACM Transactions on Computational Logic*, 6(4):784–842, 2005. doi:10.1145/1094622.1094629.
- [HvG16] Dominic Hughes and Rob van Glabbeek. MALL proof nets identify proofs modulo rule commutation, 2016. <https://arxiv.org/abs/1609.04693>.
- [Lam96] François Lamarche. From proof nets to games: extended abstract. *Electronic Notes in Theoretical Computer Science*, 3:107–119, 1996. doi:10.1016/S1571-0661(05)80409-8.
- [Lau05] Olivier Laurent. Classical isomorphisms of types. *Mathematical Structures in Computer Science*, 15(5):969–1004, October 2005.
- [Rit91] Mikael Rittri. Using types as search keys in function libraries. *Journal of Functional Programming*, 1(1):71–89, 1991.
- [RU02] Laurent Regnier and Pawel Urzyczyn. Retractions of types with many atoms, 2002. <http://arxiv.org/abs/cs/0212005>.
- [See89] Robert Seely. Linear logic,  $\star$ -autonomous categories and cofree coalgebras. *Contemporary mathematics*, 92, 1989.
- [Sol83] Sergei Soloviev. The category of finite sets and cartesian closed categories. *Journal of Soviet Mathematics*, 22(3):1387–1400, 1983.



## APPENDIX A. RULE COMMUTATION IS THE CORE OF CUT-ELIMINATION

In this appendix is given the proof of Theorem 4.2 from Section 4. We work in sequent calculus, hence by proof we mean a sequent calculus proof, never considering proof-nets. We assume proofs to be axiom-expanded.

Our proof uses a general result from the theory of abstract rewriting systems. We use standard notations from this theory: given a relation  $\triangleleft$ ,  $\triangleleft^*$  (resp.  $\triangleleft^+$ , resp.  $\triangleleft^\equiv$ ) is the transitive reflexive (resp. transitive, resp. reflexive) closure of  $\triangleleft$ , while  $\triangleright$  is the converse relation – symmetric relations will correspond to symmetric symbols. We denote by  $\cdot$  the composition of relations.

**Definition A.1.** Let  $\sim, \rightarrow$  be relations on a set  $A$  such that  $\sim$  is an equivalence relation. The relation  $\rightarrow$  is *Church-Rosser modulo  $\sim$*  if  $(\rightarrow \cup \leftarrow \cup \sim)^* \subseteq \rightarrow^* \cdot \sim \cdot \leftarrow^*$  (see Figure 16).

**Definition A.2.** Let  $\sim, \rightarrow$  be relations on a set  $A$  such that  $\sim$  is an equivalence relation. The relation  $\rightarrow$  is *locally confluent modulo  $\sim$*  if  $\leftarrow \cdot \rightarrow \subseteq \rightarrow^* \cdot \sim \cdot \leftarrow^*$  (see Figure 16).

**Definition A.3.** Let  $\vdash, \rightarrow$  be relations on a set  $A$  such that  $\vdash$  is symmetric. The relation  $\rightarrow$  is *locally coherent with  $\vdash$*  if  $\vdash \cdot \rightarrow \subseteq \rightarrow^* \cdot \vdash^* \cdot \leftarrow^*$  (see Figure 16).

We will deduce Theorem 4.2 from a Church-Rosser property, which will be found by applying the following result from Huet:

**Lemma A.4** [Hue80]. *Let  $\vdash, \rightarrow$  be relations on a set  $A$  such that  $\vdash$  is symmetric. If  $\vdash^* \cdot \rightarrow \cdot \vdash^*$  is strongly normalizing,  $\rightarrow$  is locally confluent modulo  $\vdash^*$  and locally coherent with  $\vdash$ , then  $\rightarrow$  is Church-Rosser modulo  $\vdash^*$ .*

We denote by  $\xrightarrow{\bar{\beta}}$  a  $\xrightarrow{\beta}$  step other than a *cut – cut* commutation. Also note  $\vdash^c$  the *cut – cut* commutation (which is a symmetric relation).

We recall  $\vdash^r$  (defined in Definition 2.5) is one rule commutation of *cut-free MALL*, i.e. which is not a commutation involving a *cut*-rule nor having above the commuted rules a sub-proof with a *cut*-rule (but it may have a *cut*-rule in its external context); for instance in the  $\top - \otimes$  commutation creating or deleting a sub-proof  $\pi$ ,  $\pi$  is cut-free.<sup>8</sup>

As  $\vdash^r$  and  $\vdash^c$  are symmetric,  $\vdash^{r*}$  and  $\vdash^{c*}$  are equivalence relations.

We will instantiate Lemma A.4 with  $\vdash = (\vdash^r \cup \vdash^c)$  and  $\rightarrow = \xrightarrow{\bar{\beta}}$ . To this aim, we first prove that  $(\vdash^r \cup \vdash^c)^* \cdot \xrightarrow{\bar{\beta}} \cdot (\vdash^r \cup \vdash^c)^*$  is strongly normalizing (Section A.1), before demonstrating the other hypotheses of the lemma, namely local confluence and local coherence (Section A.2). Finally, we prove that  $\xrightarrow{\bar{\beta}}$  is Church-Rosser modulo  $\vdash^r \cup \vdash^c$  using Lemma A.4, leading to a proof of Theorem 4.2 (Section A.3).

**A.1. Strong normalization.** The goal of this section is proving the strong normalization of  $(\vdash^r \cup \vdash^c)^* \cdot \xrightarrow{\bar{\beta}} \cdot (\vdash^r \cup \vdash^c)^*$ , namely Proposition A.17. We do so by giving a measure which is preserved by  $\vdash^r$  and  $\vdash^c$  but decreases during a  $\xrightarrow{\bar{\beta}}$  step. This measure is complex, and will need some intermediate definitions.

**Definition A.5.** We define the *weight*  $w(A)$  of a formula  $A$  by induction:

<sup>8</sup>Actually, we only need it for the  $\top - \otimes$  and  $\& - \otimes$  commutations, but ask it for all commutations to homogenize and simplify some proofs.

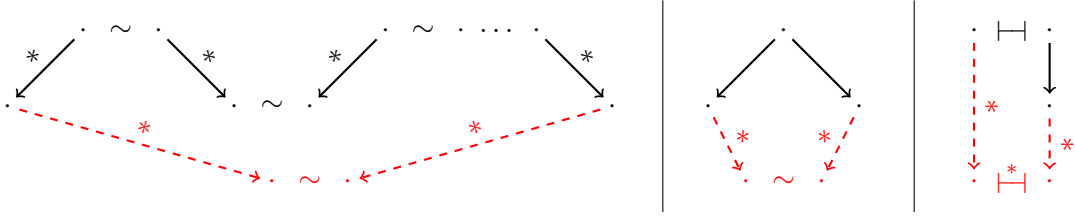

Figure 16: Diagrams of Church-Rosser modulo  $\sim$  (Definition A.1) local confluence modulo  $\sim$  (Definition A.2) and local coherence (Definition A.3), from left to right, with hypotheses in solid black and conclusions in dashed red

- $w(X) = w(X^\perp) = w(1) = w(\perp) = w(\top) = w(0) = 1$
- $w(A \otimes B) = w(A \wp B) = w(A \oplus B) = w(A) + w(B) + 1$
- $w(A \& B) = \max(w(A), w(B)) + 1$

We extend this notion to sequents, by defining for a sequent  $\vdash \Gamma = \vdash A_1, \dots, A_n$  that  $w(\vdash \Gamma) = \sum_{i=1}^n w(A_i)$ .

**Fact A.6.** For any formula  $A$ ,  $w(A)$  is a positive integer.

**Definition A.7.** We define the *weight*  $w(\pi)$  of a proof  $\pi$  by induction:

- $w\left(\frac{}{\vdash A^\perp, A} ax\right) = w(A^\perp) + w(A)$ .
- $w\left(\frac{\pi_1}{\vdash \Gamma} \frac{}{\vdash \sigma(\Gamma)} ex\right) = w(\pi_1)$
- $w\left(\frac{\pi_1 \quad \pi_2}{\vdash A, \Gamma \quad \vdash A^\perp, \Delta} \frac{}{\vdash \Gamma, \Delta} cut\right) = w(\pi_1) + w(\pi_2)$
- $w\left(\frac{\pi_1 \quad \pi_2}{\vdash A, \Gamma \quad \vdash B, \Delta} \frac{}{\vdash A \otimes B, \Gamma, \Delta} \otimes\right) = w(\pi_1) + w(\pi_2) + 1$
- $w\left(\frac{\pi_1}{\vdash A, B, \Gamma} \frac{}{\vdash A \wp B, \Gamma} \wp\right) = w(\pi_1) + 1$
- $w\left(\frac{}{\vdash 1} 1\right) = 1$
- $w\left(\frac{\pi_1}{\vdash \Gamma} \frac{}{\vdash \perp, \Gamma} \perp\right) = w(\pi_1) + 1$
- $w\left(\frac{\pi_1 \quad \pi_2}{\vdash A, \Gamma \quad \vdash B, \Gamma} \frac{}{\vdash A \& B, \Gamma} \&\right) = \max(w(\pi_1), w(\pi_2)) + 1$
- $w\left(\frac{\pi_1}{\vdash A, \Gamma} \frac{}{\vdash A \oplus B, \Gamma} \oplus_1\right) = w(\pi_1) + w(B) + 1$
- $w\left(\frac{\pi_1}{\vdash B, \Gamma} \frac{}{\vdash A \oplus B, \Gamma} \oplus_2\right) = w(\pi_1) + w(A) + 1$

$$\bullet w\left(\frac{}{\vdash \top, \Gamma} \top\right) = 1 + w(\vdash \Gamma)$$

**Lemma A.8.** For a proof  $\pi$  of a sequent  $\vdash \Gamma$ ,  $w(\pi) \geq w(\vdash \Gamma)$ . Furthermore, if  $\pi$  is cut-free, then  $w(\pi) = w(\vdash \Gamma)$ .

*Proof.* This can be easily proven by induction on  $\pi$ . We give here the most interesting cases, others are easier or similar.

$$\text{If } \pi = \frac{\frac{}{\vdash A, \Gamma} \pi_1 \quad \frac{}{\vdash B, \Gamma} \pi_2}{\vdash A \& B, \Gamma} \&. \text{ Remark that } \pi \text{ is cut-free if and only if } \pi_1 \text{ and } \pi_2 \text{ are.}$$

Then

$$\begin{aligned} w(\pi) &= \max(w(\pi_1), w(\pi_2)) + 1 \\ &\geq \max(w(\vdash A, \Gamma), w(\vdash B, \Gamma)) + 1 \text{ by induction, with equality if } \pi \text{ is cut-free} \\ &= \max(w(A) + w(\vdash \Gamma), w(B) + w(\vdash \Gamma)) + 1 \\ &= \max(w(A), w(B)) + w(\vdash \Gamma) + 1 \\ &= w(A \& B) + w(\vdash \Gamma) \\ &= w(\vdash A \& B, \Gamma) \end{aligned}$$

$$\text{If } \pi = \frac{\frac{}{\vdash A_1, \Gamma} \pi_1}{\vdash A_1 \oplus A_2, \Gamma} \oplus_1. \text{ Remark that } \pi \text{ is cut-free if and only if } \pi_1 \text{ is. Then}$$

$$\begin{aligned} w(\pi) &= w(\pi_1) + w(A_2) + 1 \\ &\geq w(\vdash A_1, \Gamma) + w(A_2) + 1 \text{ by induction hypothesis, with equality if } \pi \text{ is cut-free} \\ &= w(\vdash \Gamma) + w(A_1) + w(A_2) + 1 \\ &= w(\vdash \Gamma) + w(A_1 \oplus A_2) \\ &= w(\vdash A_1 \oplus A_2, \Gamma) \end{aligned}$$

□

**Remark A.9.** There exists a proof  $\pi$  using a *cut*-rule but whose weight is the one of its sequent. In the following proof, the left sub-tree of the  $\&$ -rule has weight 5 while its right sub-tree has weight 3, whence the weight of the full proof is  $6 = w(\vdash (1 \oplus (1 \oplus 1)) \& 1)$ .

$$\frac{\frac{}{\vdash 1} 1 \oplus_1 \quad \frac{\frac{}{\vdash 1} 1}{\vdash 1, \perp} \perp \quad \frac{}{\vdash 1} 1}{\vdash 1} \text{cut}}{\vdash (1 \oplus (1 \oplus 1)) \& 1} \&$$

This is due to the max when weighting a  $\&$ -rule, which may “hide” some weight.

**Remark A.10.** As a corollary of Lemma A.8,  $\xrightarrow{\eta}$  preserves the weight of a proof, for it transforms a cut-free proof into another one, and weight is defined inductively.

**Definition A.11.** A *block*  $\mathfrak{B}$  of *cut*-rules in a proof  $\pi$  is a maximal set of consecutive *cut*-rules in  $\pi$ .

We call *measure*  $|\mathfrak{B}|$  of a block  $\mathfrak{B}$  of *cut*-rules in a proof  $\pi$  the weight of its root *cut*-rule, i.e.  $|\mathfrak{B}| = \sum_i w(\pi_i)$  where the  $\pi_i$  are the sub-proofs whose conclusions are the premises of the *cut*-rules of  $|\mathfrak{B}|$ , premises which are by definition not the conclusion of a *cut*-rule.



Call  $\mathfrak{B}_p^\phi$  the block in  $\phi$  corresponding to the  $\mathfrak{B}_p^\tau$ , which has corresponding *cut*-rules save for  $c$  the eliminated one (it might be empty, in which case the result holds). The weight of sub-proofs decreases during the reduction step, for we removed an  $ax$ -rule. By the preliminary remarks of our proof, we only have to compare the measures of  $\mathfrak{B}_p^\tau$  and  $\mathfrak{B}_p^\phi$ .

We have  $|\mathfrak{B}_p^\tau| = |\mathfrak{B}_p^\phi| + w(A^\perp) + w(A)$ , as we remove an  $ax$ -rule. Therefore, in  $\tau$  we had  $n + 1$  *cut*-rules of weight  $|\mathfrak{B}_p^\phi| + w(A^\perp) + w(A)$  corresponding in  $\phi$  to  $n$  *cut*-rules of weight  $|\mathfrak{B}_p^\phi|$ . Whence,  $|\tau| > |\phi|$ .

$$\wp - \otimes \text{ key case. Here } \tau = \frac{\frac{\pi_1}{\vdash A, \Gamma} \quad \frac{\pi_2}{\vdash B, \Delta}}{\vdash A \otimes B, \Gamma, \Delta} \otimes \frac{\frac{\pi_3}{\vdash B^\perp, A^\perp, \Sigma}}{\vdash B^\perp \wp A^\perp, \Sigma} \wp \quad \text{while}$$

$$\frac{\vdash \Gamma, \Delta, \Sigma}{\rho} \text{ cut}$$

$$\phi = \frac{\frac{\pi_1}{\vdash A, \Gamma} \quad \frac{\frac{\pi_2}{\vdash B, \Delta} \quad \frac{\pi_3}{\vdash B^\perp, A^\perp, \Sigma}}{\vdash A^\perp, \Delta, \Sigma} \text{ cut}}{\vdash \Gamma, \Delta, \Sigma} \text{ cut}$$

$$\frac{\vdash \Gamma, \Delta, \Sigma}{\rho}$$

Call  $\mathfrak{B}_i$  the (possibly empty) block at the root of  $\pi_i$ , containing  $n_i$  *cut*-rules, for  $i \in \{1; 2; 3\}$ , and  $\mathfrak{B}_p^\phi$  the block in  $\phi$  containing the two produced *cut*-rules. Blocks  $\mathfrak{B}_1^\tau$ ,  $\mathfrak{B}_2$  and  $\mathfrak{B}_3$  are merged into the same block  $\mathfrak{B}_p^\phi$ .

We compute  $|\mathfrak{B}_p^\tau| = |\mathfrak{B}_1| + |\mathfrak{B}_2| + |\mathfrak{B}_3| + 2 + \alpha$ , with  $\alpha$  the sum of the weight of the other sub-proofs leading to the block  $\mathfrak{B}_p^\tau$  than the two of roots the eliminated  $\wp$  and  $\otimes$ -rules. Also  $|\mathfrak{B}_p^\phi| = |\mathfrak{B}_1| + |\mathfrak{B}_2| + |\mathfrak{B}_3| + \alpha$  (for we remove the  $\wp$  and  $\otimes$ -rules). Therefore, in  $\tau$  we had  $n + 1$  *cut*-rules of weight  $|\mathfrak{B}_1| + |\mathfrak{B}_2| + |\mathfrak{B}_3| + 2 + \alpha$ , and  $n_i$  *cut*-rules of weight  $|\mathfrak{B}_i|$ , while in  $\phi$  we have  $n + n_1 + n_2 + n_3 + 2$  *cut*-rules of weight  $|\mathfrak{B}_1| + |\mathfrak{B}_2| + |\mathfrak{B}_3| + \alpha$ . Whence,  $|\tau| > |\phi|$ .

$$\& - \oplus_1 \text{ key case. Here } \tau = \frac{\frac{\pi_1}{\vdash A_1, \Gamma} \quad \frac{\pi_2}{\vdash A_2, \Gamma}}{\vdash A_1 \& A_2, \Gamma} \& \frac{\frac{\pi_3}{\vdash A_2^\perp, \Delta}}{\vdash A_2^\perp \oplus A_1^\perp, \Delta} \oplus_1 \quad \text{while}$$

$$\frac{\vdash \Gamma, \Delta}{\rho} \text{ cut}$$

$$\phi = \frac{\frac{\pi_2}{\vdash A_2, \Gamma} \quad \frac{\pi_3}{\vdash A_2^\perp, \Delta}}{\vdash \Gamma, \Delta} \text{ cut}$$

$$\frac{\vdash \Gamma, \Delta}{\rho}$$

Call  $\mathfrak{B}_i$  the (possibly empty) block at the root of  $\pi_i$ , containing  $n_i$  *cut*-rules, for  $i \in \{1; 2; 3\}$ , and  $\mathfrak{B}_p^\phi$  the block in  $\phi$  containing the produced *cut*-rule. Blocks  $\mathfrak{B}_2^\tau$ ,  $\mathfrak{B}_2$  and  $\mathfrak{B}_3$  are merged into the same block  $\mathfrak{B}_p^\phi$ , while  $\mathfrak{B}_1$  is deleted.

We compute  $|\mathfrak{B}_p^\tau| = \max(|\mathfrak{B}_1|, |\mathfrak{B}_2|) + |\mathfrak{B}_3| + 2 + w(A_1^\perp) + \alpha$ , with  $\alpha$  the sum of the weight of the other sub-proofs leading to the block  $\mathfrak{B}_p^\tau$  than the two of roots the eliminated  $\&$  and  $\oplus_1$ -rules. Also  $|\mathfrak{B}_p^\phi| = |\mathfrak{B}_2| + |\mathfrak{B}_3| + \alpha$ . Therefore, in  $\tau$  we had  $n + 1$  *cut*-rules of weight  $\max(|\mathfrak{B}_1|, |\mathfrak{B}_2|) + |\mathfrak{B}_3| + 2 + w(A_1^\perp) + \alpha$ , and  $n_i$  *cut*-rules of weight  $|\mathfrak{B}_i|$ , while in  $\phi$  we have  $n + n_2 + n_3 + 1$  *cut*-rules of weight  $|\mathfrak{B}_2| + |\mathfrak{B}_3| + \alpha$ . Whence,  $|\tau| > |\phi|$ .

$\& - \oplus_2$  key case. This case is very similar to the  $\& - \oplus_1$  key case.

$$\perp - 1 \text{ key case. Here } \tau = \frac{\frac{\perp}{\vdash 1} \quad \frac{\frac{\pi}{\vdash \Gamma} \perp}{\vdash \Gamma, \perp}}{\vdash \Gamma} \text{ cut} \quad \text{and } \phi = \frac{\pi}{\vdash \Gamma} \rho.$$

Call  $\mathfrak{B}_p^\phi$  the block in  $\phi$  corresponding to the  $\mathfrak{B}_p^\tau$ , which has corresponding *cut*-rules save for the eliminated one, and maybe additional rules from a block  $\mathfrak{B}$  just above the  $\perp$ -rule in  $\tau$ .

We have  $|\mathfrak{B}_p^\tau| = |\mathfrak{B}_p^\phi| + 2$ , as we remove the  $\perp$  and 1-rules, and  $|\mathfrak{B}| \leq |\mathfrak{B}_p^\phi|$ . Therefore, in  $\tau$  we had  $n + 1$  *cut*-rules of weight  $|\mathfrak{B}_p^\phi| + 2$  and  $k$  rules of weight  $|\mathfrak{B}| \leq |\mathfrak{B}_p^\phi|$ , corresponding in  $\phi$  to  $n + k$  *cut*-rules of weight  $|\mathfrak{B}_p^\phi|$ . Whence,  $|\tau| > |\phi|$ .

$$\mathfrak{Y} - \text{cut commutative case. Here } \tau = \frac{\frac{\vdash A, B, C, \Gamma}{\vdash A, B \mathfrak{Y} C, \Gamma} \mathfrak{Y} \quad \frac{\pi_2}{\vdash A^\perp, \Delta}}{\vdash B \mathfrak{Y} C, \Gamma, \Delta} \text{ cut} \quad \text{while}$$

$$\phi = \frac{\frac{\frac{\pi_1}{\vdash A, B, C, \Gamma} \quad \frac{\pi_2}{\vdash A^\perp, \Delta}}{\vdash B, C, \Gamma, \Delta} \text{ cut}}{\vdash B \mathfrak{Y} C, \Gamma, \Delta} \mathfrak{Y} \rho.$$

Call  $\mathfrak{B}_1$  the (possibly empty) block at the root of  $\pi_1$ , containing  $n_1$  *cut*-rules,  $\mathfrak{B}_a$  the sub-block in  $\phi$  (and  $\tau$ ) containing  $c$  and the *cut*-rules directly above its right premise, and  $\mathfrak{B}_b^\phi$  the (possibly empty) block in  $\phi$  containing the rules corresponding to the ones of  $\mathfrak{B}_p^\tau \setminus \mathfrak{B}_a$ . The blocks  $\mathfrak{B}_p^\tau$  and  $\mathfrak{B}_1$  are mapped to the blocks  $\mathfrak{B}_b^\phi$  and  $\mathfrak{B}_a \cup \mathfrak{B}_1$ .

The difference between  $\mathfrak{B}_p^\tau$  and  $\mathfrak{B}_1$  in  $\tau$  and  $\mathfrak{B}_b^\phi$  and  $\mathfrak{B}_a \cup \mathfrak{B}_1$  in  $\phi$  is that  $\mathfrak{B}_a$  (including  $c$ ) moved from  $\mathfrak{B}_p^\tau$  to  $\mathfrak{B}_1$ . We have  $|\mathfrak{B}_p^\tau| = |\mathfrak{B}_b^\phi|$  (provided  $\mathfrak{B}_b^\phi$  is not empty) and  $|\mathfrak{B}_p^\tau| = |\mathfrak{B}_a \cup \mathfrak{B}_1| + 1 > |\mathfrak{B}_a \cup \mathfrak{B}_1|$ , as the weight of the commuted  $\mathfrak{Y}$ -rule is included in  $|\mathfrak{B}_p^\tau|$  but not  $|\mathfrak{B}_a \cup \mathfrak{B}_1|$ . Thence,  $|\tau| > |\phi|$ .

$$\& - \text{cut commutative case. Here } \tau = \frac{\frac{\frac{\pi_1}{\vdash A, B, \Gamma} \quad \frac{\pi_2}{\vdash A, C, \Gamma}}{\vdash A, B \& C, \Gamma} \& \quad \frac{\pi_3}{\vdash A^\perp, \Delta}}{\vdash B \& C, \Gamma, \Delta} \text{ cut} \quad \text{and}$$

$$\phi = \frac{\frac{\frac{\pi_1}{\vdash A, B, \Gamma} \quad \frac{\pi_3}{\vdash A^\perp, \Delta}}{\vdash B, \Gamma, \Delta} \text{ cut} \quad \frac{\frac{\pi_2}{\vdash A, C, \Gamma} \quad \frac{\pi_3}{\vdash A^\perp, \Delta}}{\vdash C, \Gamma, \Delta} \text{ cut}}{\vdash B \& C, \Gamma, \Delta} \& \rho.$$

Call  $\mathfrak{B}_i$  the (possibly empty) block at the root of  $\pi_i$ , containing  $n_i$  *cut*-rules,  $i \in \{1; 2\}$ ,  $\mathfrak{B}_a$  the sub-block in  $\phi$  (and  $\tau$ ) containing  $c$  and the *cut*-rules directly above its right premise, and  $\mathfrak{B}_b^\phi$  the (possibly empty) block in  $\phi$  containing the rules corresponding to the ones of  $\mathfrak{B}_p^\tau \setminus \mathfrak{B}_a$ . The blocks  $\mathfrak{B}_p^\tau$ ,  $\mathfrak{B}_1$ ,  $\mathfrak{B}_2$  are mapped to the blocks  $\mathfrak{B}_b^\phi$ ,  $\mathfrak{B}_a \cup \mathfrak{B}_1$ ,  $\mathfrak{B}_a \cup \mathfrak{B}_2$ .

As in the previous cases, some *cut*-rules (including at least  $c$ ) strictly lose measure by going from  $\mathfrak{B}_p^\tau$  to  $\mathfrak{B}_a \cup \mathfrak{B}_1$  and  $\mathfrak{B}_a \cup \mathfrak{B}_2$  (both copies separately weight less than the original), and the duplicated blocks (in  $\pi_3$ ) are of weight less than the weight of  $\mathfrak{B}_p^\tau$ . So, again, we replace one or several measures by strictly smaller measures, hence  $|\tau| > |\phi|$ .

$\otimes - cut - 1$ ,  $\otimes - cut - 2$ ,  $\oplus_i - cut$  and  $\perp - cut$  commutative cases. These cases are quite similar to the  $\wp - cut$  commutative case.

$$\top - cut \text{ commutative case. We have } \tau = \frac{\frac{\overline{\vdash A, \top, \Gamma} \top \quad \vdash A^\perp, \Delta}{\vdash \top, \Gamma, \Delta} \top \quad \vdash A^\perp, \Delta}{\vdash \top, \Gamma, \Delta} \text{ cut} \text{ whereas}$$

$$\phi = \frac{\overline{\vdash \top, \Gamma, \Delta} \top}{\vdash \top, \Gamma, \Delta} \top.$$

The weights of sub-proofs do not increase during the reduction step, using Lemma A.8. As we remove at least the *cut*-rule  $c$ , and the measures of all blocks do not increase, the result follows as in the  $ax$  key case.  $\square$

**Lemma A.14.** *If  $\pi \vdash^c \pi'$  then  $|\pi| = |\pi'|$ .*

*Proof.* Because a *cut*-*cut* commutation does not modify the measure of the block of *cut*-rules it is done in, nor the weight of the sub-proof starting from this block.  $\square$

**Lemma A.15.** *If  $\pi \vdash^r \pi'$ , then  $|\pi| = |\pi'|$ .*

*Proof.* As rule commutations act below a cut-free proof, it is enough to prove they preserve the weight of the minimal sub-proof containing them. This is the case by Lemma A.8, for two cut-free proofs on a given sequent share the same weight.  $\square$

**Remark A.16.** For Lemma A.15 to hold, we need that rule commutations are applied only when there is no *cut*-rule above. Otherwise, a sub-proof created (resp. destructed) by a  $\top - \otimes$  commutation may increase (resp. decrease) the weight and the measure of the proof. Similarly, a sub-proof duplicated (resp. superimposed) by a  $\& - \otimes$  commutation may increase (resp. decrease) the measure of the proof, even if its weight remains unchanged. Other rule commutations pose no such problem.

**Proposition A.17.** *The relation  $(\vdash^r \cup \vdash^c)^* \cdot \xrightarrow{\bar{\beta}} \cdot (\vdash^r \cup \vdash^c)^*$  is strongly normalizing. In particular,  $\xrightarrow{\bar{\beta}}$  is strongly normalizing.*

*Proof.* By Lemmas A.13, A.14 and A.15, a step of  $\xrightarrow{\bar{\beta}}$  decreases the measure of a proof while one of  $\vdash^r$  or  $\vdash^c$  preserves it. Hence, a step of  $(\vdash^r \cup \vdash^c)^* \cdot \xrightarrow{\bar{\beta}} \cdot (\vdash^r \cup \vdash^c)^*$  strictly decreases the measure of the proof, ensuring termination.  $\square$

**Fact A.18.** As long as there exists a *cut*-rule, a  $\xrightarrow{\bar{\beta}}$  cut-elimination step can be applied. Thus, cut-free proofs correspond to proofs in normal form for  $\xrightarrow{\bar{\beta}}$ .

**Corollary A.19.** *Cut-elimination  $\xrightarrow{\beta} = (\xrightarrow{\bar{\beta}} \cup \vdash^c)$  is weakly normalizing.*

*Proof.* Using Proposition A.17, one can reach a normal form for  $\xrightarrow{\bar{\beta}}$ . This is also a normal form for  $\vdash^c$  thanks to Fact A.18.  $\square$

**A.2. Local confluence and coherence.** We prove here the two other conditions needed to apply Lemma A.4, which amount to three lemmas as  $\vdash = (\vdash^r \cup \vdash^c)$ .

In this section we denote graphically some proofs with the following convention. When writing proofs as in

$$\begin{array}{c} \frac{\rho}{\vdash} r_2 \quad r_1 \quad \frac{\rho}{\vdash} r_1 \\ \vdots \quad \vdots \end{array}$$

we abuse notations in the cases where  $r_1$  or  $r_2$  is a  $\&$  or  $\top$ -rule. The meaning is that, if say  $r_1$  is a  $\&$ -rule, then  $r_2$  is duplicated, and even possibly a whole sub-proof if  $r_2$  is a  $\otimes$  for instance. Similarly, if  $r_1$  is a  $\top$ -rule, then this schema means that on the left hand-side  $r_2$  and  $\rho$  are not here, and are created by the  $\top$ -commutation.

We use the following preliminary results, identifying sufficient conditions to apply a rule commutation.

**Definition A.20.** A *linear block*  $\mathfrak{B}$  of a proof  $\pi$  is a set of successive rules of  $\pi$ , which are not  $ax$  nor  $cut$  nor  $1$  nor  $\top$ -rules, along with a choice of premises for each  $\otimes$ -rules, such that if a  $\otimes$ -rule  $r \frac{\vdash A, \Gamma \quad \vdash B, \Delta}{\vdash A \otimes B, \Gamma, \Delta} \otimes$  belongs to  $\mathfrak{B}$ , and the premise  $\vdash A, \Gamma$  (resp.  $\vdash B, \Delta$ ) is chosen, then the rule above  $\vdash B, \Delta$  (resp.  $\vdash A, \Gamma$ ) does not belong to  $\mathfrak{B}$ .

For example, consider the following proof  $\pi_{ex}$ .

$$\frac{\frac{\frac{\frac{\vdash A^\perp, A}{\vdash A^\perp, A} ax \quad \frac{\vdash B^\perp, B}{\vdash B^\perp, B} ax}{\vdash A^\perp \otimes B, A, B^\perp} \otimes \quad \frac{\frac{\frac{\vdash A^\perp, A}{\vdash A^\perp, A} ax \quad \frac{\vdash B^\perp, B}{\vdash B^\perp, B} ax}{\vdash A^\perp \otimes B, A, B^\perp} \otimes}{\vdash (A^\perp \otimes B) \oplus A, A, B^\perp} \oplus_1 \quad \frac{\vdash B^\perp, B}{\vdash B^\perp, B} ax}{\vdash (A^\perp \otimes B) \oplus A, A, B^\perp} \oplus_2}{\vdash (A^\perp \otimes B) \& ((A^\perp \otimes B) \oplus A), A, B^\perp} \& \quad \frac{\vdash B^\perp, B}{\vdash B^\perp, B} ax}{\vdash A^\perp \oplus B, B^\perp} \oplus_2}{\vdash (A^\perp \otimes B) \& ((A^\perp \otimes B) \oplus A), A, B^\perp \otimes B^\perp, A^\perp \oplus B} \otimes$$

The following  $\mathfrak{B}_{ex}$  is a linear block (with the kept premise of the  $\otimes$ -rule having its sequent):

$$\frac{\frac{\vdash B^\perp, B}{\vdash B^\perp, B} \otimes \quad \frac{\vdash A^\perp \otimes B, A, B^\perp}{\vdash (A^\perp \otimes B) \oplus A, A, B^\perp} \oplus_1}{\vdash (A^\perp \otimes B) \& ((A^\perp \otimes B) \oplus A), A, B^\perp} \&$$

On the contrary, the following is not, for it keeps both premises of a  $\otimes$ -rule:

$$\frac{\frac{\vdash A^\perp \otimes B, A, B^\perp}{\vdash (A^\perp \otimes B) \& ((A^\perp \otimes B) \oplus A), A, B^\perp} \& \quad \frac{\vdash B^\perp, B}{\vdash A^\perp \oplus B, B^\perp} \oplus_2}{\vdash (A^\perp \otimes B) \& ((A^\perp \otimes B) \oplus A), A, B^\perp \otimes B^\perp, A^\perp \oplus B} \otimes$$

**Definition A.21.** Given a proof  $\pi$  of  $\vdash \Theta$  containing a rule  $r$ , a *domain* of  $r$  is a sub-list of  $\Theta$  defined (or not) depending on the kind of  $r$ , as the formulas of  $\Theta$  having for sub-formulas (following occurrences):

**$ax$ -rule:** undefined;

**$cut$ -rule:** undefined;

**$\otimes$ -rule:** if  $r$  is  $\frac{\vdash A, \Gamma \quad \vdash B, \Delta}{\vdash A \otimes B, \Gamma, \Delta} \otimes$  then the sub-formulas to consider are either  $A \otimes B, \Gamma$  or  $A \otimes B, \Delta$ ;

**$\wp$ -rule:** if  $r$  is  $\frac{\vdash A, B, \Gamma}{\vdash A \wp B, \Gamma} \wp$  then the sub-formula to consider is  $A \wp B$ ;

**$1$ -rule:** undefined;

**$\perp$ -rule:** if  $r$  is  $\frac{\vdash \Gamma}{\vdash \perp, \Gamma} \perp$  then the sub-formula to consider is  $\perp$ ;

**$\&$ -rule:** if  $r$  is  $\frac{\vdash A, \Gamma \quad \vdash B, \Gamma}{\vdash A \& B, \Gamma} \otimes$  then the sub-formula to consider is  $A \& B$ ;



- $\oplus_1$ -rule: if  $r$  is  $\frac{\vdash A, \Gamma}{\vdash A \oplus B, \Gamma} \oplus_1$  then the sub-formula to consider is  $A \oplus B$ ;
- $\oplus_2$ -rule: if  $r$  is  $\frac{\vdash B, \Gamma}{\vdash A \oplus B, \Gamma} \oplus_2$  then the sub-formula to consider is  $A \oplus B$ ;
- $\top$ -rule: undefined;

The domain of a linear block  $\mathfrak{B}$  is the union of the domain of each of its rules, with the constraint that if  $r$  is a  $\otimes$ -rule  $\frac{\vdash A, \Gamma \quad \vdash B, \Delta}{\vdash A \otimes B, \Gamma, \Delta} \otimes$  of  $\mathfrak{B}$  whose premise  $\vdash A, \Gamma$  (resp.  $\vdash B, \Delta$ ) is chosen, then the domain of  $r$  in this definition is  $A \otimes B, \Delta$  (resp.  $A \otimes B, \Gamma$ ).

Two rules  $r$  and  $s$  in sub-proof  $\pi$  of conclusion  $\vdash \Gamma$  are *independent* if a domain of  $r$  is disjoint from a domain of  $s$  (as sub-lists of  $\Gamma$ , these domains being defined), with the convention that if  $\pi$  has several slices, then we ask for the disjointness of the union of domains of  $r$  (identifying rules in different slices with the same main formula occurrence) and of the union of domains of  $s$ , and if  $r$  or  $s$  is a  $\otimes$ -rule by choosing the same premise for this  $\otimes$ -rule in all slices.

A rule  $r$  and a linear block  $\mathfrak{B}$  in  $\pi$  are *independent* if all following conditions hold:

- $\mathfrak{B}$  is at the root of  $\pi$ ;
- in every slice the rule  $r$  is the rule above a rule of  $\mathfrak{B}$  (identifying rules in different slices with the same main formula occurrence, with  $\otimes$ -rules unary following the choice of premises of  $\mathfrak{B}$ );
- the (or one of the two if  $r$  is a  $\otimes$ -rule, choosing the same premise in every slice) union of domains of  $r$  across all slices is disjoint from the domain of  $\mathfrak{B}$  (as sub-lists of  $\Gamma$ ); remark this corresponds to the independence of  $r$  with every rule of  $\mathfrak{B}$ .

For instance, on  $\pi_{ex}$ , the domain of the  $\oplus_1$ -rule is  $(A^\perp \otimes B) \& ((A^\perp \otimes B) \oplus A)$ , the domains of the leftmost  $\otimes$ -rule are  $(A^\perp \otimes B) \& ((A^\perp \otimes B) \oplus A)$ ,  $A$  or  $(A^\perp \otimes B) \& ((A^\perp \otimes B) \oplus A)$ ,  $B^\perp \otimes B^\perp$ , the former also being the domain of  $\mathfrak{B}_{ex}$ . The middle (upper)  $\otimes$ -rule is not independent with  $\mathfrak{B}_{ex}$  whereas the  $\oplus_2$ -rule is independent with the root  $\otimes$ -rule.

**Fact A.22.** Consider two rules  $r$  and  $s$  in the two different sub-proofs given by a *cut*-rule. Then  $r$  and  $s$  are independent in the sub-proof of root this *cut*-rule.

**Lemma A.23.** Take  $r$  and  $s$  are successive non 0-ary nor *cut*-rules in a proof  $\pi$ , with  $r$  above  $s$  and no *cut*-rules above  $r$  and  $s$  (in case  $s$  is a  $\&$ -rule, we ask  $r$  to be above  $s$  in both premises). If they are independent, then they commute. On the other end, if they commute, then they are independent in the sub-proof of root  $s$ .

*Proof.* One has to check it for every type of rules  $r$  and  $s$  can be, among  $\otimes$ ,  $\wp$ ,  $\perp$ ,  $\&$ ,  $\oplus_1$  and  $\oplus_2$ -rules. A representative case is  $r$  is a  $\otimes$ -rule and  $s$  a  $\&$ -rule, other cases being left at the charge of the reader. By symmetry, say that  $r$  keeps its right premise (in both slices, by independence with  $s$ ). Our proof must then be:

$$\frac{\frac{\pi_1}{\vdash A_1, \Gamma} \quad \frac{\pi_2}{\vdash A_2, B_1, \Delta}}{\vdash A_1 \otimes A_2, B_1, \Gamma, \Delta} \otimes \quad \frac{\frac{\pi_1}{\vdash A_1, \Gamma} \quad \frac{\pi_3}{\vdash A_2, B_2, \Delta}}{\vdash A_1 \otimes A_2, B_2, \Gamma, \Delta} \otimes}{\vdash A_1 \otimes A_2, B_1 \& B_2, \Gamma, \Delta} \&$$

We recognize a  $\otimes$  –  $\&$  rule commutation.

For the (partial) reciprocal, it suffices to check for every instance of a rule commutation that the rules are independent, as it is the case here for a  $\otimes$  –  $\&$  commutation.  $\square$

**Remark A.24.** The full reciprocal of Lemma A.23 is false. The following is a counter-example:

$$\frac{\frac{\frac{\vdash A, B, C, D, \Gamma}{\vdash A \wp B, C, D, \Gamma} \wp r}{\vdash A \wp B, C \wp D, \Gamma} \wp s}{\vdash (A \wp B) \wp (C \wp D), \Gamma} \wp$$

**Lemma A.25.**

- (1) A rule commutation does not modify a domain of any (non-erased) rule.
- (2) A commutative cut-elimination case does not modify a domain of any (non-erased) rule.
- (3) A key cut-elimination case does not modify a domain of any (non-erased) rule.

*Proof.* Each item to check consists in a tedious cases analysis. We give here a few representative ones. Remark that, for any transformation of proofs, a domain of a non-erased rule which is not involved in the transformation is unchanged (as our transformation are local, except when erasing rules).

*Item 1.* Consider the following  $C_{\otimes}^{\&}$  commutation:

$$\frac{\frac{\frac{\pi_1}{\vdash A_1, \Gamma} \quad \frac{\pi_2}{\vdash A_2, B_1, \Delta}}{\vdash A_1 \otimes A_2, B_1, \Gamma, \Delta} \otimes \quad \frac{\frac{\pi_1}{\vdash A_1, \Gamma} \quad \frac{\pi_3}{\vdash A_2, B_2, \Delta}}{\vdash A_1 \otimes A_2, B_2, \Gamma, \Delta} \otimes}{\vdash A_1 \otimes A_2, B_1 \& B_2, \Gamma, \Delta} \otimes \xrightarrow{C_{\otimes}^{\&}} \frac{\frac{\pi_1}{\vdash A_1, \Gamma} \quad \frac{\frac{\frac{\pi_2}{\vdash A_2, B_1, \Delta} \quad \frac{\pi_3}{\vdash A_2, B_2, \Delta}}{\vdash A_2, B_1 \& B_2, \Delta} \&}}{\vdash A_1 \otimes A_2, B_1 \& B_2, \Gamma, \Delta} \otimes \&$$

For the  $\&$ -rule, its domain is (the formulas of the conclusion sequent whose sub-formulas are)  $B_1 \& B_2$  in both cases. For the  $\otimes$ -rule, its domain when keeping the right premise is  $A_1 \otimes A_2, \Gamma$  in both occurrences on the left, as well as on the right. Similarly, its domain when keeping the left premise stays  $A_1 \otimes A_2, B_1 \& B_2, \Delta$ .

*Item 2.* We take interest in a  $\otimes - cut - 1$  commutative case.

$$\frac{\frac{\frac{\pi_1}{\vdash A, B, \Gamma} \quad \frac{\pi_2}{\vdash C, \Delta}}{\vdash A, B \otimes C, \Gamma, \Delta} \otimes \quad \frac{\pi_3}{\vdash A^\perp, \Sigma}}{\vdash B \otimes C, \Gamma, \Delta, \Sigma} \otimes \xrightarrow{\beta} \frac{\frac{\frac{\pi_1}{\vdash A, B, \Gamma} \quad \frac{\pi_3}{\vdash A^\perp, \Sigma}}{\vdash B, \Gamma, \Sigma} cut \quad \frac{\pi_2}{\vdash C, \Delta}}{\vdash B \otimes C, \Gamma, \Delta, \Sigma} \otimes$$

The domain of the  $\otimes$ -rule, when keeping its right premise, stays (the formulas of the conclusion sequent whose sub-formulas are)  $B \otimes C, \Gamma$ , for  $A$  is not a sub-formula of the conclusion sequent. Similarly, when keeping its left premise its domain is still  $B \otimes C, \Delta$ .

*Item 3.* We study here a  $\& - \oplus_1$  key case:

$$\frac{\frac{\frac{\pi_1}{\vdash A_1, \Gamma} \quad \frac{\pi_2}{\vdash A_2, \Gamma}}{\vdash A_1 \& A_2, \Gamma} \& \quad \frac{\frac{\pi_3}{\vdash A_2^\perp, \Delta}}{\vdash A_2^\perp \oplus A_1^\perp, \Delta} \oplus_1}{\vdash \Gamma, \Delta} \& \oplus_1 \xrightarrow{\beta} \frac{\frac{\frac{\pi_2}{\vdash A_2, \Gamma} \quad \frac{\pi_3}{\vdash A_2^\perp, \Delta}}{\vdash \Gamma, \Delta} cut}{\vdash \Gamma, \Delta} cut$$

The initial remark is enough here: the rules involved in the transformation are erased, so there is nothing to check.  $\square$

**Lemma A.26.** Assume  $r$  is a rule and  $\mathfrak{B}$  a linear block, that they are independent and that there is no cut-rule above them. Then  $r$  commutes successively with all rules of  $\mathfrak{B}$ :  $\frac{\tau}{\mathfrak{B}} r$

$$\vdash^* \frac{\tau}{\mathfrak{B}} r .$$

*Proof.* By induction on the number of rules of  $\mathfrak{B}$ . If it is of null size, *i.e.* with no rules, then there is nothing to prove. Otherwise, there is a rule  $t_s \in \mathfrak{B}$  below  $r$  in each slice  $s$ . If one of the  $t_s$  is not a  $\&$ -rule, then we commute it with  $r$  by Lemma A.23. In the resulting proof,  $r$  and the block  $\mathfrak{B}'$ , made of the rules of  $\mathfrak{B}$  save for  $t_s$ , are independent by Item 1 of Lemma A.25 (we keep the same choice for premises of  $\otimes$ -rules). We conclude using the induction hypothesis.

Otherwise, all  $t_s$  are  $\&$ -rules. Take one of them, it must have two occurrences of  $s$  above its premises. Hence, we can again make them commute by Lemma A.23, then conclude by induction hypothesis using Item 1 of Lemma A.25.  $\square$

**Lemma A.27.** *Let  $\pi$  be an axiom-expanded cut-free proof of a sequent  $\vdash \top_0, \Gamma$  (up to permutation), with  $\top_0$  an occurrence of a  $\top$ -formula. Then  $\pi \stackrel{r^*}{\vdash} \frac{\vdash \top_0, \Gamma}{\top}$ , this rule being applied on  $\top_0$ .*

*Proof.* We reason by induction on the size of  $\pi$  (*i.e.* its number of rules).

If  $\pi$  has a unique rule, then it must be a  $\top$  one: this is the only 0-ary rule applicable on a sequent containing  $\top$ , except for a non-atomic *ax*-rule. Up to a  $\top - \top$  commutation, this rule is applied on  $\top_0$  and  $\pi$  is of the desired shape.

If  $\pi$  has more than one rule, then consider its last rule  $r$ , which is not a 0-ary one nor a *cut*. By induction hypothesis on the premises of  $r$  containing  $\top_0$  (there is at least one), up to  $\stackrel{r^*}{\vdash}$  these premises are  $\top$ -rules on  $\top_0$ . A commutation between  $r$  and these  $\top$ -rules yields  $\frac{\vdash \top_0, \Gamma}{\top}$ .  $\square$

**Remark A.28.** Lemma A.27 corresponds to the terminality of  $\top$  in the category corresponding to MALL (see Section 9.1).

**Lemma A.29.** *Let  $\pi$ ,  $\pi_1$  and  $\pi_2$  be MALL proofs such that  $\pi_1 \xleftarrow{\bar{\beta}} \pi \xrightarrow{\bar{\beta}} \pi_2$ . Then there exist  $\pi'_1$  and  $\pi'_2$  such that  $\pi_1 \xrightarrow{\bar{\beta}^*} \pi'_1 \stackrel{r=}{\vdash} \pi'_2 \xleftarrow{\bar{\beta}^*} \pi_2$ . Diagrammatically:*

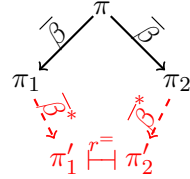

*More precisely, we need a step of  $\stackrel{r}{\vdash}$  exactly when both  $\xrightarrow{\bar{\beta}}$  steps are different commutative cases on the same cut-rule.*

*Proof.* If the  $\pi \xrightarrow{\bar{\beta}} \pi_1$  and  $\pi \xrightarrow{\bar{\beta}} \pi_2$  steps involve only distinct rules then, taking into account that rules of one may be duplicated or erased by the other step, they commute and we have a proof  $\pi'$  such that  $\pi_1 \xrightarrow{\bar{\beta}^*} \pi' \xleftarrow{\bar{\beta}^*} \pi_2$ , by applying one reduction after the other.

From now on, we assume both steps involve (at least) one common rule. If both reductions share all of their rules, then the two reductions are the same, so  $\pi_1 = \pi_2$  and we are done (recall Remark 2.4 for our convention on the  $\mathfrak{A} - \otimes$  key case). Hence, we will assume them not to share all of their rules. We distinguish cases according to the kinds of the  $\xrightarrow{\bar{\beta}}$  steps.

*If one step is a key case other than an *ax* one.* Remark that on the three rules of a non-*ax* key case, no other  $\xrightarrow{\bar{\beta}}$  step can be applied (only a *cut - cut* commutation could

have been applied, but this case does not belong to  $\overline{\beta}$ . Whenceforth, this case cannot happen as it would lead to the two reductions sharing all of their rules.

*If both steps are ax key cases.* As the two reductions share one rule, but not all rules, the shared rule must be the *cut*-rule, with as premises two *ax*-rules. We can check that this critical pair leads to the same resulting proof from both choices of cut-elimination. Thus  $\pi_1 = \pi_2$ .

*If one step is an ax key case and the other a commutative case.* By symmetry, assume  $\pi \xrightarrow{\overline{\beta}} \pi_2$  is the *ax* key case. For the two reductions share a rule, and the *ax*-rule cannot participate in a commutative step, the shared rule must be the *cut*-rule. We can still do this *ax* key step after the commutation (maybe twice in case of duplication, or zero time in case of erasure), recovering  $\pi_2$ . Thus:

- $\pi_1 \xrightarrow{\overline{\beta}} \pi_2$  (*ax*-key case and not a  $\&$  – *cut* nor  $\top$  – *cut* commutative case)
- $\pi_1 \xrightarrow{\overline{\beta}} \cdot \xrightarrow{\overline{\beta}} \pi_2$  (*ax*-key case and  $\&$  – *cut* commutative case)
- $\pi_1 = \pi_2$  (*ax*-key case and  $\top$  – *cut* commutative case)

*If both steps are commutative cases.* Here again, as the two reductions share a rule, it must be the *cut*-rule, because there is at most one *cut*-rule directly below a given rule. As the reductions do not share both of their rules, in  $\pi \xrightarrow{\overline{\beta}} \pi_1$  we sent a rule  $r_1$  from a branch of the *cut* below it, and in  $\pi \xrightarrow{\overline{\beta}} \pi_2$  we do similarly on a rule  $r_2$  in the other branch. This case, more complex than the previous ones, is depicted schematically on Figure 17. We can in  $\pi_1$  commute the *cut*-rule and  $r_2$  – maybe twice in case of a duplication, or zero in case of an erasure – obtaining  $\pi'_1$ , and similarly in  $\pi_2$  the *cut*-rule and  $r_1$ , yielding  $\pi'_2$ . The two resulting proofs differ exactly by a commutation of  $r_1$  and  $r_2$  (even if both are  $\top$ -rules, they differ by a  $\top$  –  $\top$  commutation).

Indeed,  $r_1$  and  $r_2$  are independent in the sub-proof of  $\pi$  whose root is the *cut*-rule we consider (Fact A.22). They are still independent in the sub-proof of  $\pi_1$  (resp.  $\pi_2$ ) and then of  $\pi'_1$  (resp.  $\pi'_2$ ) whose root is  $r_1$  (resp.  $r_2$ ) by Item 2 of Lemma A.25. For we apply rule commutation only on cut-free sub-proofs, we first eliminate all *cut*-rules above these two rules, in the same way in both sub-proofs (and in case of duplication, in the same way in all duplicates of the sub-proofs). This can be done thanks to weak normalization of  $\overline{\beta}$  (Proposition A.17). In the resulting sub-proofs,  $r_1$  and  $r_2$  are still independent as their domains do not depend on what happen above them, and cut-elimination is a local procedure (Item 2 and Item 3 of Lemma A.25). So, they commute (Lemma A.23).

Notice the reasoning above does not apply to the case where  $r_1$  or  $r_2$  is a  $\top$ -rule. Still, this case is easily handled using Lemma A.27: both sub-proofs are equal to a same  $\top$ -rule, up to rule commutations.

Thus,  $\pi_1 \xrightarrow{\overline{\beta}^*} \cdot \vdash \cdot \xleftarrow{\overline{\beta}^*} \pi_2$  if both steps are commutative cases. □

For local coherence with  $\vdash^c$ , we will need one intermediate result on symmetry of cut, due to the following remark.

**Remark A.30.** The *symmetry of a cut-rule* is the identification of the following (sub-)proofs:

$$\pi_1 = \frac{\frac{\rho_1}{\vdash A, \Gamma} \quad \frac{\rho_2}{\vdash A^\perp, \Delta}}{\vdash \Gamma, \Delta} \text{ cut} \quad \text{and} \quad \pi_2 = \frac{\frac{\rho_2}{\vdash A^\perp, \Delta} \quad \frac{\rho_1}{\vdash A, \Gamma}}{\vdash \Gamma, \Delta} \text{ cut}$$

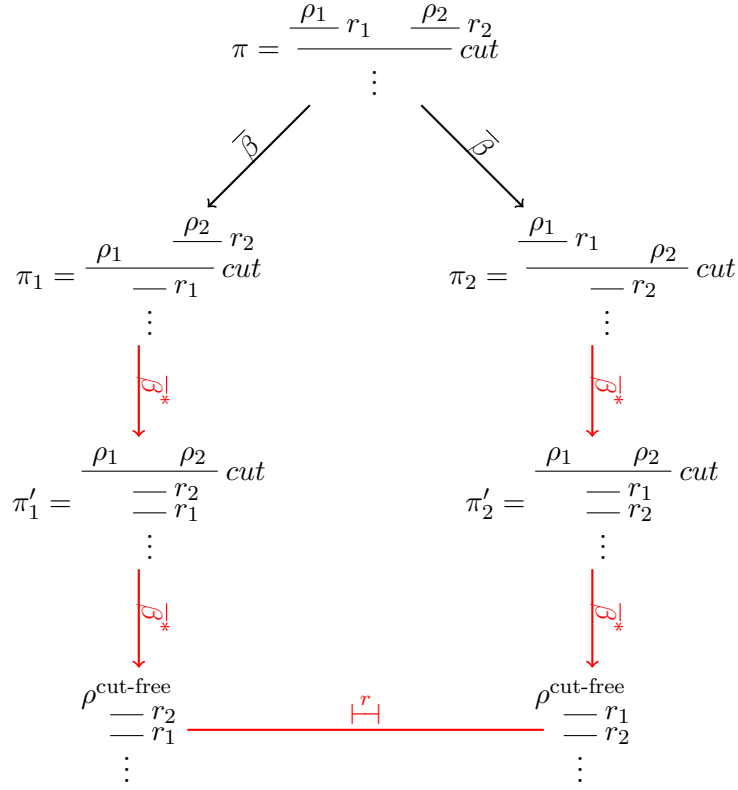

Figure 17: Schematic representation of the last case of the proof of Lemma A.29

This relation is included in  $=_{\beta}$ , using a *cut* – *cut* commutation. Indeed, define respectively  $\pi'_1$  and  $\pi'_2$  the two following proofs, where  $A_1$  and  $A_2$  are both the formula  $A$ , with indices to follow their occurrences:

$$\frac{\frac{\frac{}{\vdash A_1^\perp, A_2} ax}{} \quad \frac{\frac{\rho_1}{\vdash A_1, \Gamma} cut}{\vdash A_2, \Gamma} cut}{\vdash \Gamma, \Delta} cut \quad \frac{\frac{\rho_2}{\vdash A_2^\perp, \Delta} cut}{\vdash \Gamma, \Delta} cut}{\vdash \Gamma, \Delta} cut \quad \text{and} \quad \frac{\frac{\frac{\frac{}{\vdash A_1^\perp, A_2} ax}{} \quad \frac{\frac{\rho_2}{\vdash A_2^\perp, \Delta} cut}{\vdash A_1^\perp, \Delta} cut}{\vdash \Gamma, \Delta} cut}{\vdash \Gamma, \Delta} cut \quad \frac{\frac{\rho_1}{\vdash A_1, \Gamma} cut}{\vdash \Gamma, \Delta} cut}{\vdash \Gamma, \Delta} cut$$

Then  $\pi_1 \xleftarrow{\bar{\beta}} \pi'_1 \xrightarrow{c} \pi'_2 \xrightarrow{\bar{\beta}} \pi_2$ , these  $\bar{\beta}$  steps being *ax* key cases.

The next lemma allows us not to add symmetry of *cut* in  $\vdash^c$ , which would complexify our proofs where there already are a lot of cases.

**Lemma A.31.** *Let  $\pi_1$  and  $\pi_2$  be two proofs equal up to symmetry of *cut*-rules. Then  $\pi_1 \xrightarrow{\bar{\beta}^*} \cdot \xleftarrow{\bar{\beta}^*} \pi_2$ .*

*Proof.* The idea is to eliminate any *cut*-rule in  $\pi_1$  and  $\pi_2$  in a symmetric way, and show the resulting proofs are equal up to symmetry of *cut*-rules. The wished result follows through weak normalization, as two cut-free proofs equal up to symmetry of *cut*-rules are simply equal.

We reason by induction on a sequence  $\pi_1 \xrightarrow{\bar{\beta}^*} \rho$ , with  $\rho$  some cut-free proof found by weak normalization (Proposition A.17). If this sequence is empty, then  $\pi_1$  is *cut*-free and so

$\pi_1 = \pi_2$ . Thus, take  $\pi_1 \xrightarrow{\bar{\beta}} \pi'_1$  its first step. We apply the corresponding step in  $\pi_2$ , on the corresponding *cut*-rule which may be the symmetric version of  $c$  (for if a  $\xrightarrow{\bar{\beta}}$  step can be applied, then the one with switched premises can be applied on the symmetric version). We obtain a proof  $\pi'_2$  with the *cut*-rule still permuted compared to  $\pi'_1$  in case of a commutative case (or the *cut*-rule erased when commuting with a  $\top$ , or permuted and duplicated with a  $\&$ ) and 0, 1 or 2 symmetric *cut*-rules resulting from a key case. In all cases,  $\pi'_1$  and  $\pi'_2$  are equal up to symmetry of *cut*-rules, allowing us to conclude by induction hypothesis.  $\square$

**Lemma A.32.** *Let  $\pi_1, \pi_2$  and  $\pi_3$  be proofs such that  $\pi_1 \vdash^r \pi_2 \xrightarrow{\bar{\beta}} \pi_3$ . Then, there exist  $\pi'_1$  and  $\pi'_2$  such that  $\pi_1 \xrightarrow{\bar{\beta}^+} \pi'_1 \vdash^{r^*} \pi'_2 \xleftarrow{\bar{\beta}^*} \pi_3$ . Diagrammatically:*

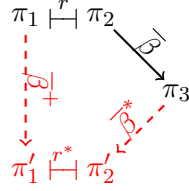

*Proof.* An easily handled case is when the  $\pi_1 \vdash^r \pi_2$  and  $\pi_2 \xrightarrow{\bar{\beta}} \pi_3$  steps involve only distinct rules; assume for now this is the case. A first general sub-case is when rules of one step are neither erased nor duplicated by the other. Then these steps commute and  $\pi_1 \xrightarrow{\bar{\beta}} \cdot \vdash^r \pi_3$ , using the same steps in the other order (because these are local transformations).

Now, consider the case where the two steps still involve distinct rules, but the  $\pi_2 \xrightarrow{\bar{\beta}} \pi_3$  step duplicates a sub-proof containing the rules of  $\pi_1 \vdash^r \pi_2$  (which may happen if  $\pi_2 \xrightarrow{\bar{\beta}} \pi_3$  is a  $\&$  – *cut* commutative case). We apply the corresponding  $\xrightarrow{\bar{\beta}}$  step first in  $\pi_1$ , yielding  $\pi_1 \xrightarrow{\bar{\beta}} \pi_1^1$ , and then the  $\vdash^r$  step twice, once for each occurrence, to recover  $\pi_3$ : we get  $\pi_1 \xrightarrow{\bar{\beta}} \pi_1^1 \vdash^r \cdot \vdash^r \pi_3$ .

Another general case is when the rules involved in the two steps are distinct, but the  $\xrightarrow{\bar{\beta}}$  step eliminates a sub-proof containing the rules of the  $\vdash^r$  step (this can arise when using a  $\&$  –  $\oplus_i$  key case or a  $\top$  – *cut* commutative case). In this case, doing in  $\pi_1$  the  $\xrightarrow{\bar{\beta}}$  step directly yields  $\pi_3$ :  $\pi_1 \xrightarrow{\bar{\beta}} \pi_3$ .

Remark that, if these steps use distinct rules, the  $\pi_1 \vdash^r \pi_2$  step cannot duplicate nor erase the rules involved in  $\pi_2 \xrightarrow{\bar{\beta}} \pi_3$ . Indeed, this may happen if the  $\vdash^r$  step is a  $\&$  –  $\otimes$  or  $\top$  –  $\otimes$  commutative case, but we assumed that a sub-proof corresponding to a rule commutation is cut-free, and a  $\xrightarrow{\bar{\beta}}$  step involves a *cut*-rule by definition.

From now on, we suppose both steps involve at least one common rule, which cannot be a *cut* one, for there is no commutation involving a *cut*-rule in  $\vdash^r$ . In fact, there is exactly one shared rule. Indeed, the rules that can commute using  $\vdash^r$  are one rule on top of another rule, so both cannot be above a *cut*-rule. We distinguish cases according to the kind of  $\pi_2 \xrightarrow{\bar{\beta}} \pi_3$ .

If  $\pi_2 \xrightarrow{\bar{\beta}} \pi_3$  is an *ax* key case. As an *ax*-rule never commutes, the two steps share no rule, contradiction.

If  $\pi_2 \xrightarrow{\bar{\beta}} \pi_3$  is a  $\wp - \otimes$  key case. In this case,  $\pi_2$  and  $\pi_3$  are the following proofs:

$$\frac{\frac{\frac{\rho_1}{\vdash A, \Gamma} \quad \frac{\rho_2}{\vdash B, \Delta}}{\vdash A \otimes B, \Gamma, \Delta} \otimes \quad \frac{\frac{\rho_3}{\vdash B^\perp, A^\perp, \Sigma}}{\vdash B^\perp \wp A^\perp, \Sigma} \wp}{\vdash \Gamma, \Delta, \Sigma} cut \quad \frac{\frac{\rho_1}{\vdash A, \Gamma} \quad \frac{\frac{\rho_2}{\vdash B, \Delta} \quad \frac{\rho_3}{\vdash B^\perp, A^\perp, \Sigma}}{\vdash A^\perp, \Delta, \Sigma} cut}{\vdash \Gamma, \Delta, \Sigma} cut}{\vdash \Gamma, \Delta, \Sigma} \rho_4$$

(up to symmetry of the *cut*-rule, the case where  $\pi_2$  has a  $\wp$ -rule on the left and a  $\otimes$  one on the right being symmetric and solved similarly; and up to the order of the formulas in each sequent).

By our assumption,  $\pi_1 \vdash^r \pi_2$  was a step pushing down the  $\otimes$  or  $\wp$ -rule, and up some non *cut*-rule  $r$ . We can in  $\pi_1$  commute the *cut*-rule up and  $r$  down (as  $r$  cannot be the rule of the main connective of the formula on which we cut, nor an *ax*-rule). This yields a proof  $\pi_1^1$  such that  $\pi_1 \xrightarrow{\bar{\beta}} \pi_1^1$  with this commutative step, with  $\pi_1^1$  being  $\pi_2$  except  $r$  is below the *cut*-rule and not above the  $\otimes$  or  $\wp$ -rule (by abuse, for if  $r$  is a  $\top$ -rule then the *cut*-rule is not here anymore). Thus,  $\pi_1^1 \xrightarrow{\bar{\beta}} \pi_1^2$  using the same step as in  $\pi_2 \xrightarrow{\bar{\beta}} \pi_3$ ; unless if  $r$  is a  $\top$ -rule, in which case there is nothing to do and we set  $\pi_1^1 = \pi_1^2$ ; or if  $r$  is a  $\&$ -rule, where we have to apply this step in both occurrences, obtaining  $\pi_1^1 \xrightarrow{\bar{\beta}} \cdot \xrightarrow{\bar{\beta}} \pi_1^2$ . In any case,  $\pi_1^1 \xrightarrow{\bar{\beta}^*} \pi_1^2$ . Observe that  $\pi_1^2$  is like  $\pi_3$ , except that  $r$  is above some *cut*-rule(s) in  $\pi_3$  and below in  $\pi_1^2$ . But, using  $\xrightarrow{\bar{\beta}}$  in  $\pi_3$ ,  $r$  can commute down one or two of the *cut*-rules created by the key case, yielding  $\pi_1^2$  (including if  $r$  is a  $\&$  or  $\top$ -rule). Therefore,  $\pi_1 \xrightarrow{\bar{\beta}} \pi_1^1 \xrightarrow{\bar{\beta}^*} \pi_1^2 \xleftarrow{\bar{\beta}^+} \pi_3$ , concluding this case.

If  $\pi_2 \xrightarrow{\bar{\beta}} \pi_3$  is a  $\& - \oplus_i$  or  $\perp - 1$  key case. These cases are similar to the previous one, in simpler as we create less *cut*-rules.

If  $\pi_2 \xrightarrow{\bar{\beta}} \pi_3$  is a commutative case. As  $\pi_1 \vdash^r \pi_2$  and  $\pi_2 \xrightarrow{\bar{\beta}} \pi_3$  have exactly one rule in common, the  $\vdash^r$  step involves the rule  $r$  that will be commuted down in the  $\xrightarrow{\bar{\beta}}$  step, and another rule that we call  $s$  ( $r$  and  $s$  are not *cut*-rules). The proof  $\pi_1$  has from top to bottom  $r$ ,  $s$  and *cut*,  $\pi_2$  has  $s$ ,  $r$  and *cut*, and  $\pi_3$  has  $s$ , *cut* and  $r$ . Schematically:

$$\pi_1 = \frac{\frac{\quad}{\quad} r}{\frac{\quad}{\quad} s} cut \quad \pi_2 = \frac{\frac{\quad}{\quad} s}{\frac{\quad}{\quad} r} cut \quad \pi_3 = \frac{\frac{\quad}{\quad} s}{\frac{\quad}{\quad} r} cut$$

Suppose first that the *cut*-rule commutes with  $s$ . Our reasoning for this case is depicted on Figure 18. In  $\pi_1$ , we commute  $s - cut$  then  $r - cut$ , yielding  $\pi_1 \xrightarrow{\bar{\beta}} \pi_1^1 \xrightarrow{\bar{\beta}^*} \pi_1^2$  (the  $\xrightarrow{\bar{\beta}^*}$  being of length one, except if  $s$  is a  $\&$ -rule, in which case we apply the  $r - cut$  commutation for both occurrences, or if  $s$  is a  $\top$ -rule, in which case there is no commutation to apply). The proof  $\pi_1^2$  has from top to bottom *cut*,  $r$  and  $s$ . Meanwhile, in  $\pi_3$  we commute  $s - cut$  (twice if  $r$  is a  $\&$ -rule, or zero time if it is a  $\top$ -rule), yielding  $\pi_3^1$  having from top to bottom *cut*,  $s$  and  $r$ . Now, both  $\pi_1^2$  and  $\pi_3^1$  have above  $r$  and  $s$  a same proof (maybe duplicated or erased). We use weak normalization of  $\xrightarrow{\bar{\beta}}$  (Proposition A.17) to eliminate all *cut*-rules in this sub-proof, in the same way for all its occurrences in  $\pi_1^2$  and  $\pi_3^1$ , obtaining proofs  $\pi_1^3$  and  $\pi_3^2$  equal up to the commutation of  $r$  and  $s$  (the very same one that was used in  $\pi_1 \vdash^r \pi_2$ ). We thus obtain  $\pi_1 \xrightarrow{\bar{\beta}} \pi_1^1 \xrightarrow{\bar{\beta}^*} \pi_1^2 \xrightarrow{\bar{\beta}^*} \pi_1^3 \vdash^r \pi_3^2 \xleftarrow{\bar{\beta}^*} \pi_3^1 \xleftarrow{\bar{\beta}^*} \pi_3$ .

To check that indeed we can apply a  $\vdash^r$  step, by Lemma A.23  $r$  and  $s$  are independent in the sub-proof of root  $s$  of  $\pi_1$ , so also of root the *cut*-rule (as their domains on the premise sequent of the *cut*-rule are their domains in the conclusion sequent, for none use the cut formula). Using commutative cut-elimination cases does not change this, nor does then eliminating all *cut*-rules above them (Item 2 and Item 3 of Lemma A.25). Thus,  $r$  and  $s$  commute in  $\pi_1^3$  (Lemma A.23). Notice this reasoning does not apply to the case where  $r$  or  $s$  is a  $\top$ -rule. Still, this case is easily handled using Lemma A.27: both sub-proofs are equal to a same  $\top$ -rule, up to rule commutations.

Assume now  $s$  is a rule associated to the main connective of the formula on which we cut. Remark  $s$  cannot be an *ax*-rule, for it commutes with  $r$ . This case is represented on Figure 19. We first reduce in the same way all *cut*-rules in the branch of the *cut*-rule not containing  $s$ , yielding  $\pi_1^1$  from  $\pi_1$  through  $\pi_1 \xrightarrow{\bar{\beta}^*} \pi_1^1$  and  $\pi_3^1$  from  $\pi_3$  through  $\pi_3 \xrightarrow{\bar{\beta}^*} \pi_3^1$ ; they share this sub-proof, and we use weak normalization of  $\xrightarrow{\bar{\beta}}$  (Proposition A.17). Denote by  $s^\perp$  the rule introducing the dual formula of  $s$  (*i.e.* the other formula on which we cut), and by  $\rho$  the rules between  $s^\perp$  and the *cut*-rule in  $\pi_1^1$  (which are also those in  $\pi_3^1$ ). Commuting the *cut*-rule above all rules in  $\rho$  yields  $\pi_1^1 \xrightarrow{\bar{\beta}^*} \pi_1^2$  with  $\pi_1^2$  having the *cut*-rule between  $s$  and  $s^\perp$ . (Remark we do not need  $\vdash^c$  steps, as we eliminated the *cut*-rules above.) Doing the same commutations in  $\pi_3^1$  gives  $\pi_3^1 \xrightarrow{\bar{\beta}^*} \pi_3^2$ , with  $\pi_3^2$  differing from  $\pi_1^2$  by having  $r$  below  $\rho$  and not above  $s$ . Using the appropriate key case or  $\top$  – *cut* commutative case to eliminate the *cut*-rule in  $\pi_1^2$ , using  $s^\perp$  and maybe  $s$ , we obtain a new proof  $\pi_1^3$  (as usual, if there are  $\&$ -rules in  $\rho$ , we need to do so for all duplicates). In this new proof, if *cut*-rules have been introduced by the key case we used, we commute them with the rule  $r$  (which cannot introduce the formula of the *cut*-rule, for this is a sub-formula of the  $s$  rule, which commutes with the  $r$  rule). The produced proof is called  $\pi_1^4$ , and we have  $\pi_1^2 \xrightarrow{\bar{\beta}^+} \pi_1^3 \xrightarrow{\bar{\beta}^*} \pi_1^4$ . On the other hand, we also eliminate the *cut*-rule in the same way in  $\pi_3^2$ , yielding a proof  $\pi_3^3$  such that  $\pi_3^2 \xrightarrow{\bar{\beta}^*} \pi_3^3$  (again, in all duplicates if there were  $\&$ -rules in  $\rho$ , or with nothing to do if  $r$  is a  $\top$ -rule). Remark  $\pi_3^3$  is  $\pi_1^4$ , except the rule  $r$  is below the rules of  $\rho$  in  $\pi_3^3$  and above in  $\pi_1^4$ . Now we use again weak normalization of  $\xrightarrow{\bar{\beta}}$  (Proposition A.17) to eliminates all *cut*-rules above  $r$  or the rules in  $\rho$ , in the same way in  $\pi_1^4$  and  $\pi_3^3$ . We obtain two proofs equal to the commutation of  $r$  with all rules in  $\rho$ , so equal up to  $\vdash^{r^*}$  now that there is no *cut*-rule above (including a  $\top$  –  $\top$  commutation if both  $r$  and  $s$  are  $\top$ -rules). If  $s$  or  $s^\perp$  is a  $\top$ -rule, then  $\pi_1^3 = \pi_1^4$  and we commute  $s^\perp$  with  $r$  in this proof, “producing” the rule  $r$  that we can then commute down with rules of  $\rho$  to recover  $\pi_3^3$ .

Indeed, in  $\pi_1^1$  the rule  $r$  is independent of every rule of  $\rho$  (Fact A.22),  $\rho$  being a linear block by definition (it consists of rules commuting with a given *cut*-rule, we keep for premises of  $\otimes$ -rules the one leading to the  $s^\perp$  rules). They are still independent in  $\pi_1^2$ ,  $\pi_1^3$ ,  $\pi_1^4$  and the resulting proof with cut above eliminated (Item 2 and Item 3 of Lemma A.25). But then we remark  $r$  independent with the linear block  $\rho$ , so it can indeed commute down (Lemma A.26). Notice this reasoning does not apply to the case where  $r$  is a  $\top$ -rule. Still, this case is easily handled using Lemma A.27: both sub-proofs are equal to a same  $\top$ -rule, up to rule commutations.

Finally,  $\pi_1 \xrightarrow{\bar{\beta}^*} \pi_1^1 \xrightarrow{\bar{\beta}^*} \pi_1^2 \xrightarrow{\bar{\beta}^+} \pi_1^3 \xrightarrow{\bar{\beta}^*} \pi_1^4 \xrightarrow{\bar{\beta}^*} \cdot \vdash^{r^*} \cdot \xleftarrow{\bar{\beta}^*} \pi_3^3 \xleftarrow{\bar{\beta}^*} \pi_3^2 \xleftarrow{\bar{\beta}^*} \pi_3^1 \xleftarrow{\bar{\beta}^*} \pi_3$ .  $\square$



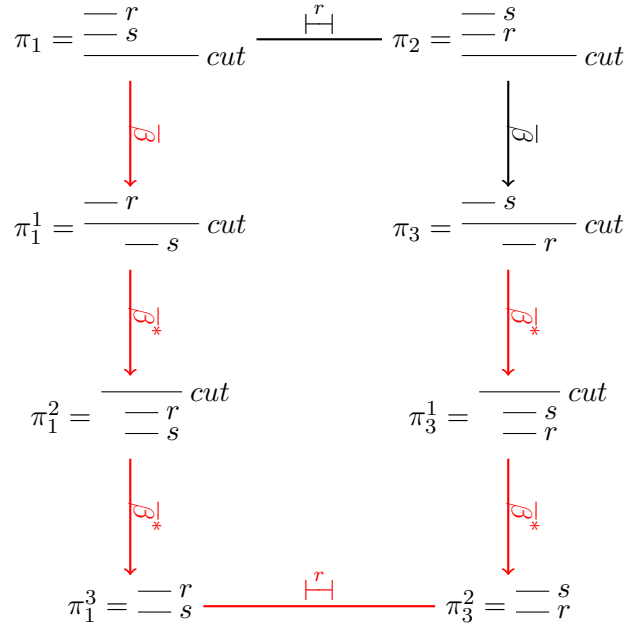

Figure 18: Schematic representation of the second-to-last case in the proof of Lemma A.32

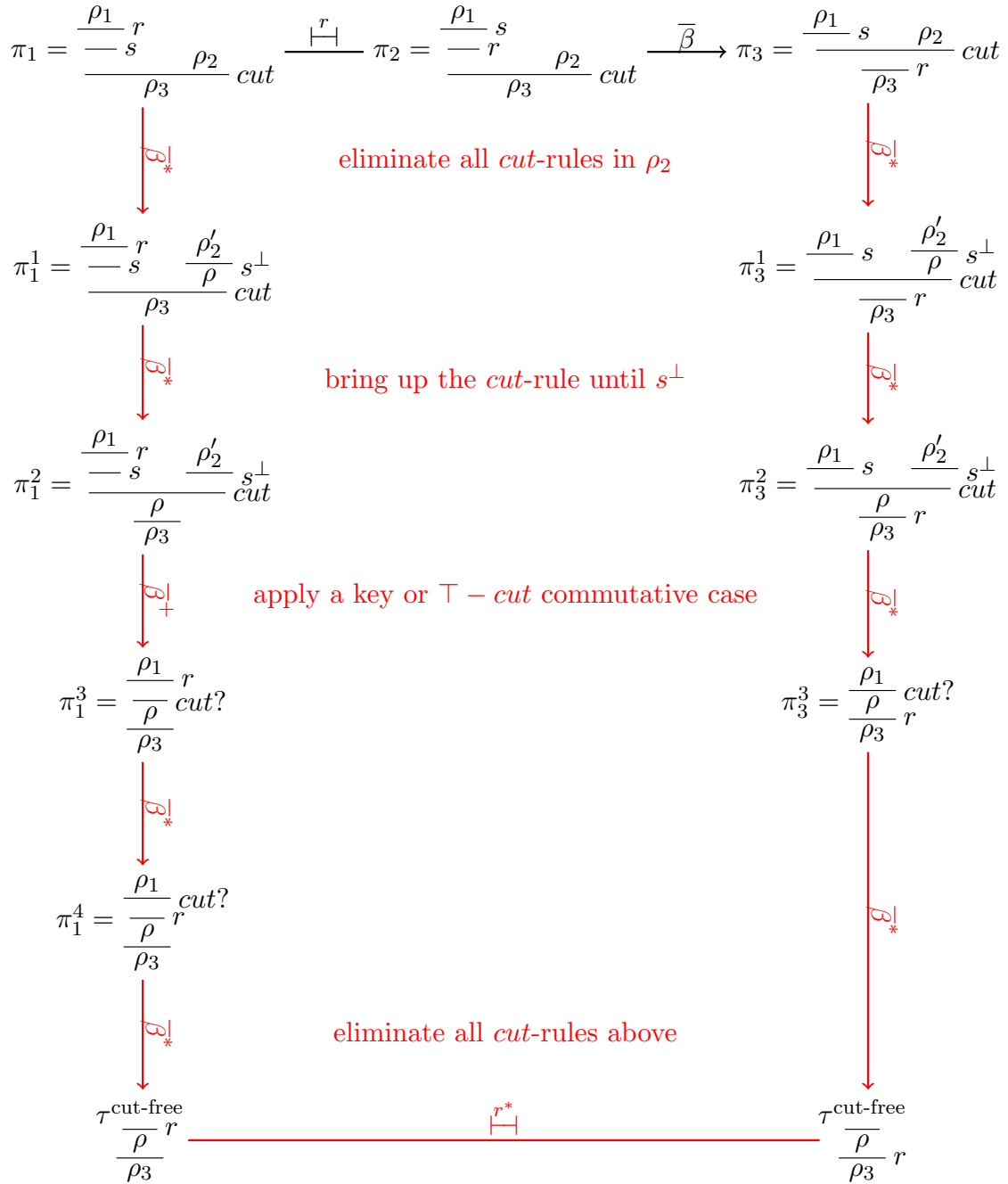
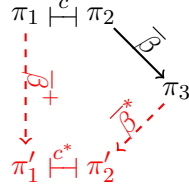

Figure 19: Schematic representation of the last case in the proof of Lemma A.32

**Lemma A.33.** *Let  $\pi_1, \pi_2$  and  $\pi_3$  be proofs such that  $\pi_1 \vdash^c \pi_2 \xrightarrow{\bar{\beta}} \pi_3$ . Then there exist  $\pi'_1$  and  $\pi'_2$  such that  $\pi_1 \xrightarrow{\bar{\beta}^+} \pi'_1 \vdash^{c^*} \pi'_2 \xleftarrow{\bar{\beta}^*} \pi_3$ . Diagrammatically:*



*Proof.* Call  $c$  the (unique) *cut*-rule of  $\pi_2$  involved in  $\pi_2 \xrightarrow{\bar{\beta}} \pi_3$ , and  $c_d$  and  $c_u$  the ones of  $\pi_2$  from top to bottom involved in  $\pi_1 \vdash^c \pi_2$  (so that in  $\pi_1$  we have  $c_u$  above  $c_d$ ).

If  $c \notin \{c_u; c_d\}$ , then there exists  $\rho$  such that  $\pi_1 \xrightarrow{\bar{\beta}} \rho \vdash^{c^*} \pi_3$ . Indeed, the commutation  $\pi_1 \vdash^c \pi_2$  involves no rule of the  $\xrightarrow{\bar{\beta}}$  step, meaning we can do the  $\xrightarrow{\bar{\beta}}$  step first. If this  $\xrightarrow{\bar{\beta}}$  step does not erase nor duplicate a sub-proof containing  $c_u$  and  $c_d$ , then we have the result by first doing the  $\xrightarrow{\bar{\beta}}$  step, then the *cut-cut* commutation:  $\pi_1 \xrightarrow{\bar{\beta}} \cdot \vdash^c \pi_3$ . If the  $\xrightarrow{\bar{\beta}}$  step erases  $c_u$  and  $c_d$ , then  $\pi_1 \xrightarrow{\bar{\beta}} \pi_3$ . Finally, if  $\xrightarrow{\bar{\beta}}$  duplicates the rules  $c_u$  and  $c_d$ , then we apply the *cut – cut* commutation on each copy to recover  $\pi_3$ , yielding  $\pi_1 \xrightarrow{\bar{\beta}} \cdot \vdash^c \cdot \vdash^c \pi_3$ . Thus, if  $c \notin \{c_u; c_d\}$  then  $\pi_1 \xrightarrow{\bar{\beta}} \rho \vdash^{c^*} \pi_3$ .

Whence, we now assume  $c \in \{c_u; c_d\}$ . Call  $\mathcal{R}$  the set of the non-*cut*-rules involved in  $\pi_2 \xrightarrow{\bar{\beta}} \pi_3$  (*i.e.* those other than  $c$ ). Also call  $c'$  the *cut*-rule in  $\{c_u; c_d\}$  other than  $c$ . Looking at the possible cases for  $\xrightarrow{\bar{\beta}}$ , we have  $\mathcal{R}$  of cardinal 1 or 2. If all rules of  $\mathcal{R}$  are just above  $c$  in  $\pi_1$  then, as it is also the case in  $\pi_2$ ,  $\mathcal{R}$  must be a singleton  $\{r\}$  (because  $c'$  must be just above  $c$  in  $\pi_1$  or in  $\pi_2$ ), and so  $\xrightarrow{\bar{\beta}}$  is a commutative step or an *ax* key case. Assume  $r$  is an *ax*-rule; we have two sub-cases, according to  $(c, c') = (c_u, c_d)$  or  $(c', c) = (c_u, c_d)$ . If  $(c, c') = (c_u, c_d)$ , then we have (up to symmetry of *cut*-rules):

$$\begin{aligned}
\bullet \pi_1 &= \frac{\frac{\frac{\rho_1}{\vdash A^\perp, A} r}{\vdash A, B^\perp, \Gamma} c}{\vdash \Gamma, \Delta} \frac{\rho_2}{\vdash B, \Delta} c' \\
\bullet \pi_2 &= \frac{\frac{\rho_1}{\vdash A^\perp, A} r}{\vdash \Gamma, \Delta} \frac{\frac{\rho_1}{\vdash A, B^\perp, \Gamma} \quad \frac{\rho_2}{\vdash B, \Delta}}{\vdash A, \Gamma, \Delta} c' \\
\bullet \pi_3 &= \frac{\frac{\rho_1}{\vdash A, B^\perp, \Gamma} \quad \frac{\rho_2}{\vdash B, \Delta}}{\vdash A, \Gamma, \Delta} c'
\end{aligned}$$

We remark  $\pi_1 \xrightarrow{\bar{\beta}} \pi_3$ . Similarly, if  $(c', c) = (c_u, c_d)$  then  $\pi_1 \xrightarrow{\bar{\beta}} \pi_3$ .

Suppose now that  $\pi_2 \xrightarrow{\bar{\beta}} \pi_3$  is a commutative step. Remark that  $r$  above  $c'$  is a commutative *cut* elimination case, for we have  $c'$  not below  $r$  in either  $\pi_1$  or  $\pi_2$ . We also have two sub-cases here, according to  $(c, c') = (c_u, c_d)$  or  $(c', c) = (c_u, c_d)$ .

In the first sub-case,  $(c, c') = (c_u, c_d)$ , we have schematically:

$$\pi_1 = \frac{\overline{r}}{\quad} c \quad c' \quad \pi_2 = \frac{\overline{r}}{\quad} \frac{\overline{c'}}{\quad} \quad \pi_3 = \frac{\overline{c'}}{\overline{r}} \frac{\overline{c}}{\quad}$$

(with in  $\pi_3$  rules above  $r$  erased if  $r$  is a  $\top$ -rule, or duplicated if  $r$  is a  $\&$ -rule). We apply in  $\pi_1$  the commutative cut elimination case between  $r$  and  $c$ , yielding  $\pi_1^1 = \frac{\overline{c}}{\overline{r}} \frac{\overline{c'}}{\quad}$ , then the same one between  $r$  and  $c'$  to get  $\pi_1^2 = \frac{\overline{c}}{\quad} \frac{\overline{c'}}{\overline{r}}$  and finally one  $\vdash^c$  step (or zero if  $r = \top$ , or two if  $r = \&$ ), obtaining  $\pi_3$ . Thence,  $\pi_1 \xrightarrow{\overline{\beta}} \pi_1^1 \xrightarrow{\overline{\beta}} \pi_1^2 \vdash^c \pi_3$ .

In the second sub-case,  $(c', c) = (c_u, c_d)$ , we have:

$$\pi_1 = \frac{\overline{r}}{\quad} \frac{\overline{c'}}{\quad} \quad \pi_2 = \frac{\overline{r}}{\quad} c \quad c' \quad \pi_3 = \frac{\overline{c}}{\overline{r}} \frac{\overline{c'}}{\quad}$$

Similarly to the previous sub-case,  $\pi_1 \xrightarrow{\overline{\beta}} \pi_1^1 = \frac{\overline{c'}}{\overline{r}} \frac{\overline{c}}{\quad}$  and  $\pi_3 \xrightarrow{\overline{\beta}} \pi_3^1 = \frac{\overline{c}}{\quad} \frac{\overline{c'}}{\overline{r}}$ . Then,  $\pi_1^1 \vdash^{c^*} \pi_3^1$  by commuting  $c$  and  $c'$  (using one *cut – cut* commutation, or zero if  $r = \top$ , or two if  $r = \&$ ). Thus,  $\pi_1 \xrightarrow{\overline{\beta}} \pi_1^1 \vdash^{c^*} \pi_3^1 \xleftarrow{\overline{\beta}} \pi_3$ . This solves the case where all rules of  $\mathcal{R}$  are above  $c$  in  $\pi_1$ .

We suppose now that a rule  $r \in \mathcal{R}$  is above  $c'$  in  $\pi_1$ , and then above  $c$  in  $\pi_2$ , thus  $c' = c_u$  and  $c = c_d$ . In this case, the possible other rule in  $\mathcal{R}$  cannot be above  $c'$  in  $\pi_1$ , for only one sub-proof may be shared between the two *cut*-rules. Schematically:

$$\pi_1 = \frac{\overline{r}}{\quad} \frac{\overline{c'}}{\quad} c \quad \pi_2 = \frac{\overline{r}}{\quad} c \quad c' \quad \pi_3 = \frac{\overline{\gamma}}{\quad} c'$$

with  $\gamma$  the rules resulting of applying the  $\xrightarrow{\overline{\beta}}$  step, which may be a key case.

If  $r$  and  $c'$  commute (with a commutative  $\xrightarrow{\overline{\beta}}$  step), then we apply this commutation in  $\pi_1$ , yielding  $\pi_1^1 = \frac{\overline{c'}}{\overline{r}} \frac{\overline{c}}{\quad}$ . Then we apply the  $\xrightarrow{\overline{\beta}}$  step with the rules corresponding to the ones of  $\pi_2 \xrightarrow{\overline{\beta}} \pi_3$ , yielding  $\pi_1^2 = \frac{\overline{\gamma}}{\quad} c'$ . At this point, either this step was a commutative step with  $r$ , meaning  $\gamma$  is composed of  $c$  above  $r$ , and we can in  $\pi_3$  commute  $c'$  and  $r$  with a  $\xrightarrow{\overline{\beta}}$  step, then  $c'$  and  $c$  with one  $\vdash^c$ , in order to recover  $\pi_1^2$  (or no  $\vdash^c$  needed if  $r = \top$ , or two if  $r = \&$ ). Otherwise, this reduction step was a key case, producing  $\gamma$  which consists in 0, 1 or 2 *cut*-rules. We commute them with  $c'$  so as to obtain  $\pi_3$ . Therefore, if  $r$  and  $c'$  commute then  $\pi_1 \xrightarrow{\overline{\beta}} \pi_1^1 \xrightarrow{\overline{\beta}} \pi_1^2 \vdash^c \cdot \xleftarrow{\overline{\beta}^*} \pi_3$ .

Suppose now that  $r$  and  $c'$  do not commute. This means  $r$  is a rule corresponding to the main connective of the formula  $A$  on which  $c'$  cuts, a  $\top$ -rule or an *ax*-rule on  $A$ . If it is an *ax*-rule, then  $r$  and  $c$ , as well as  $r$  and  $c'$ , make an *ax* key case. One can check that applying this key case with  $c'$  in  $\pi_1$  yields  $\pi_3$  (in this case  $\gamma$  is empty), maybe up to symmetry of the *cut*-rule. Thus  $\pi_1 \xrightarrow{\overline{\beta}} \pi_3$  or, using Lemma A.31,  $\pi_1 \xrightarrow{\overline{\beta}} \cdot \xrightarrow{\overline{\beta}^*} \cdot \xleftarrow{\overline{\beta}^*} \pi_3$ .

Assume now  $r$  is not an *ax*-rule, so it is a rule corresponding to the main connective of the formula  $A$  on which  $c'$  cuts, or a  $\top$ -rule. Thus  $\pi_2 \xrightarrow{\overline{\beta}} \pi_3$  is not a key step, because  $r$  cannot also correspond to the main connective of the formula on which  $c$  cuts (only the *ax*-rule has two principal formulas). Hence in the schema of  $\pi_3$ ,  $\gamma$  consists of  $c$  followed below by  $r$ . A schematic representation of the reasoning we will do is depicted on Figure 20.

Call  $\rho$  the sub-proof of  $\pi_1$  above  $c'$  in the branch not leading to  $r$ . This proof  $\rho$  is also the sub-proof of  $\pi_3$  above  $c'$  in the same branch ( $c$  does not belong to this branch as it commuted with  $r$ ). We reduce all *cut*-rules in  $\rho$  using only  $\xrightarrow{\bar{\beta}}$  steps (thanks to Proposition A.17), in the same way in both  $\pi_1$  and  $\pi_3$ , obtaining a cut-free proof  $\rho'$ , which is a sub-proof of the resulting  $\pi_1^1$  and  $\pi_3^1$  respectively. In particular, we have  $\pi_1 \xrightarrow{\bar{\beta}^*} \pi_1^1$  and  $\pi_3 \xrightarrow{\bar{\beta}^*} \pi_3^1$ .

Call  $r^\perp$  the rule in  $\rho'$  introducing the formula  $A^\perp$  (which is a rule of the main connective of  $A^\perp$  or an *ax* or  $\top$ -rule), and  $\tau$  the sequence of rules in  $\rho'$  between  $c'$  and  $r^\perp$ . Remark that rules in  $\tau$  cannot be  $\top$  or *cut*-rules. We commute in  $\pi_1^1$  (resp.  $\pi_3^1$ ) the rules of  $\tau$  with  $c'$ , yielding  $\pi_1^1 \xrightarrow{\bar{\beta}^*} \pi_1^2$  (resp.  $\pi_3^1 \xrightarrow{\bar{\beta}^*} \pi_3^2$ ) as  $\tau$  is cut-free. In the two proofs obtained,  $c'$  has on its premises the rules  $r$  and  $r^\perp$  (or all duplicated  $c'$ , as  $\tau$  may contain  $\&$ -rules).

We now apply a key or  $\top$  – *cut* commutative case on  $c'$ , using  $r$  and  $r^\perp$  (or just  $r^\perp$  if it is an *ax* or  $\top$ -rule), in all slices as there can be  $\&$ -rules in  $\tau$ , yielding  $\pi_1^2 \xrightarrow{\bar{\beta}^+} \pi_1^3$  and  $\pi_3^2 \xrightarrow{\bar{\beta}^+} \pi_3^3$ , producing rules  $\gamma'$  (in each slice), which are 0, 1 or 2 *cut*-rules, or the  $\top$ -rule  $r^\perp$ . Observe that  $\pi_1^3$  and  $\pi_3^3$  differ only by the fact that in  $\pi_1^3$  the *cut*-rule  $c$  is below  $\gamma'$  and  $\tau$ , while it is above (or erased in case of a  $\top$  – *cut* commutative case) in  $\pi_3^3$  (in all slices). We can commute  $c$  up in  $\pi_1^3$  until going above  $\tau$ , using  $\xrightarrow{\bar{\beta}}$  steps, obtaining  $\pi_1^4$ ; this is because rules in  $\tau$  cannot introduce the formula on which  $c$  cuts, looking at  $\pi_3^3$ . Then we commute  $c$  with  $\gamma'$  to recover  $\pi_3^3$ , using 0, 1 or 2  $\vdash^c$  steps or a  $\top$  – *cut* commutation  $\xrightarrow{\bar{\beta}}$ , in all slices as they can be  $\&$ -rules in  $\tau$ . Whence  $\pi_1 \xrightarrow{\bar{\beta}^*} \pi_1^1 \xrightarrow{\bar{\beta}^*} \pi_1^2 \xrightarrow{\bar{\beta}^+} \pi_1^3 \xrightarrow{\bar{\beta}^*} \pi_1^4 (\xrightarrow{\bar{\beta}^+} \cup \vdash^c) \pi_3^3 \xleftarrow{\bar{\beta}^+} \pi_3^2 \xleftarrow{\bar{\beta}^*} \pi_3^1 \xleftarrow{\bar{\beta}^*} \pi_3$ , and in particular  $\pi_1 \xrightarrow{\bar{\beta}^+} \cdot \vdash^c \cdot \xleftarrow{\bar{\beta}^*} \pi_3$ .  $\square$

**A.3. Church-Rosser modulo.** We can now prove the wished result.

**Theorem A.34.** *In the sequent calculus of MALL,  $\xrightarrow{\bar{\beta}}$  is Church-Rosser modulo  $(\vdash^r \cup \vdash^c)^*$ .*

*Proof.* We apply Lemma A.4:  $(\vdash^r \cup \vdash^c)^* \cdot \xrightarrow{\bar{\beta}} \cdot (\vdash^r \cup \vdash^c)^*$  is strongly-normalizing by Proposition A.17, locally confluent modulo  $(\vdash^r \cup \vdash^c)^*$  by Lemma A.29 and locally coherent with  $(\vdash^r \cup \vdash^c)$  by Lemmas A.32 and A.33.  $\square$

The theorem claimed in the main part then follows.

**Theorem 4.2** (Rule commutation is the core of cut-elimination). *If two axiom-expanded proofs  $\pi$  and  $\tau$  are  $\beta$ -equal, then any of their normal forms by  $\xrightarrow{\beta}$  are related by  $\vdash^{r^*}$ .*

*Proof.* By Theorem A.34 the normal forms, related by  $=_\beta$ , are related by  $(\vdash^r \cup \vdash^c)^*$ , for no reduction  $\xrightarrow{\bar{\beta}}$  can be applied to them. Being cut-free, they can only be related by  $\vdash^{r^*}$ .  $\square$

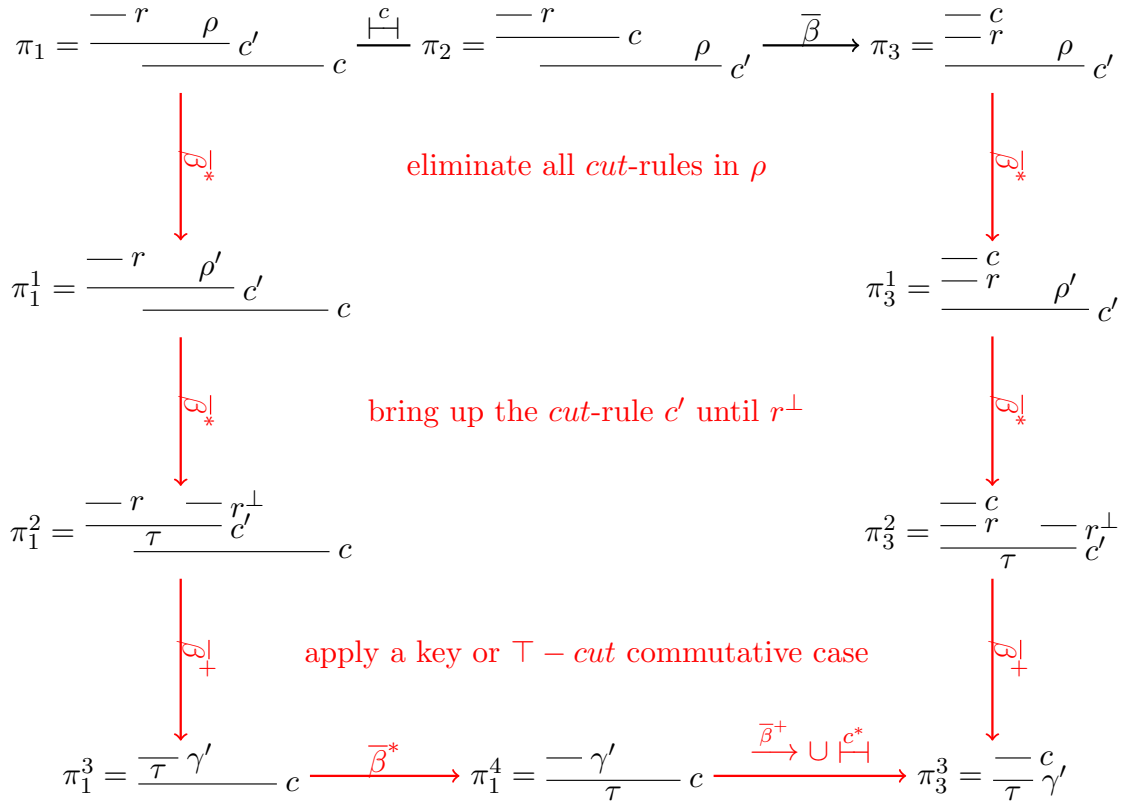

Figure 20: Schematic representation of the last case in the proof of Lemma A.33