LENS: A FOUNDATION MODEL FOR NETWORK TRAFFIC IN CYBERSECURITY

Qineng Wang

School of Computer Science
Zhejiang University and William & Mary
wongqineng73@zju.edu.cn

Chen Qian

Department of Computer Science
William & Mary
cqian03@wm.edu

Xiaochang Li

Department of Computer Science
William & Mary
xli59@wm.edu

Ziyu Yao

Department of Computer Science
George Mason University
ziyuyao@gmu.edu

Huajie Shao

Department of Computer Science
William & Mary
hshao@wm.edu

ABSTRACT

Network traffic refers to the amount of data being sent and received over the internet or any system that connects computers. Analyzing and understanding network traffic is vital for improving network security and management. However, the analysis of network traffic is challenging due to the diverse nature of data packets, which often feature heterogeneous headers and encrypted payloads lacking semantics. To capture the latent semantics of traffic, a few studies have adopted pre-training techniques based on the Transformer encoder or decoder to learn the representations from massive traffic data. However, these methods typically excel in traffic understanding (classification) or traffic generation tasks. To address this issue, we develop Lens, a foundation model for network traffic that leverages the T5 architecture to learn the pre-trained representations from large-scale unlabeled data. Harnessing the strength of the encoder-decoder framework, which captures the global information while preserving the generative ability, our model can better learn the representations from raw data. To further enhance pre-training effectiveness, we design a novel loss that combines three distinct tasks: Masked Span Prediction (MSP), Packet Order Prediction (POP), and Homologous Traffic Prediction (HTP). Evaluation results across various benchmark datasets demonstrate that the proposed Lens outperforms the baselines in most downstream tasks related to both traffic understanding and generation. Notably, it also requires much less labeled data for fine-tuning compared to current methods.

1 Introduction

In the realm of computer networking, network traffic is defined as the flow of data, transmitted in the form of packets between interconnected computers or systems. Typically, a packet consists of two parts: the header and the payload. The header provides essential information regarding the packet like IP address and payload length, while the payload contains the actual data, which may be encrypted. Given the critical role of network traffic, analyzing this data is crucial to ensure high network security, offer high-quality network services, and facilitate effective network management. However, analyzing network traffic poses a big challenge due to the complex characteristics of network traffic, encompassing both ciphertext and plaintext.

Over the past decades, many approaches have been developed for network traffic analysis. Early works [36, 1, 28, 42] mainly utilized statistical methods, heavily dependent on manually crafted features. To address this issue, some studies have employed deep learning methods [34, 21, 23, 39] to extract complicated features from raw data. While these approaches have shown impressive results in specific tasks, they often require extensive labeled data and struggle with generalization to novel tasks. Consequently, few recent works have explored pre-training techniques to learn the latent representations from large-scale unlabeled traffic data. For instance, some works have introduced BERT-based models [8, 19] to learn the pre-trained representations, subsequently applied to traffic understanding (classification) in downstream tasks. Despite their effectiveness in traffic classification, these models lack generative capabilities due to

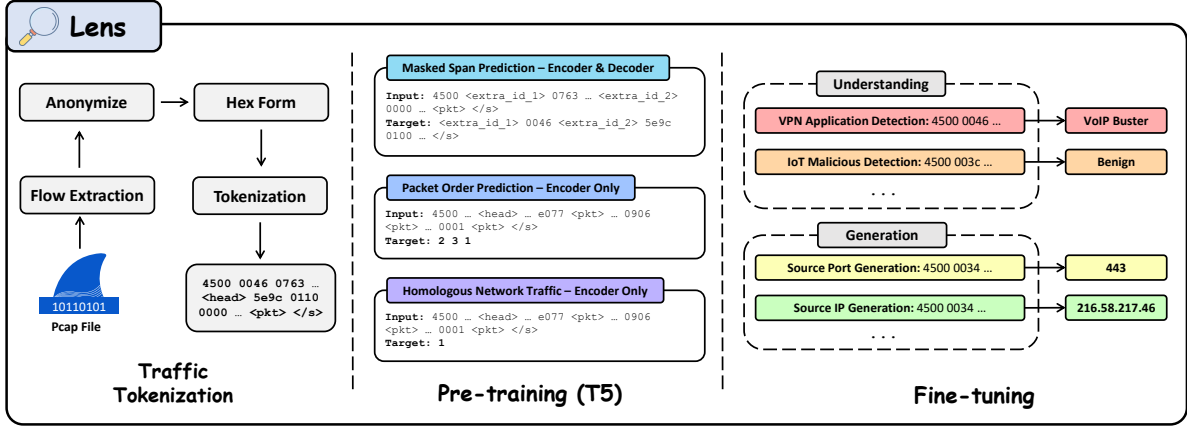

Figure 1: The overall framework of Lens. It consists of three parts: traffic tokenization, pre-training using the T5 Architecture, and fine-tuning.

their encoder-only architecture. Indeed, GPT-based models [29, 30, 3] excel in generation capability, but they only learn from previous information in a sequence without considering the following information. As a result, this unidirectional learning technique may not capture the global information of input data, impeding their capacity to fully understand network traffic. Thus, a pivotal question arises: how can we achieve good performance of both traffic understanding and generation within the scope of network traffic analysis?

In this paper, we develop Lens, a foundation model that leverages the T5 architecture [31, 41] to learn the pre-trained representations from massive traffic data. Thanks to the encoder-decoder architecture of T5, the proposed model excels in both traffic understanding and traffic generalization. As illustrated in Fig. 1, the overall framework consists of three stages: tokenization, pre-training, and fine-tuning. During tokenization, to accommodate the diverse nature of traffic data, including both plaintext and encrypted information, we standardize different traffic types by converting their content into a hexadecimal format. Furthermore, we explore the impact of different tokenization methods, such as SentencePiece [15] and WordPiece [19], on model performance. At the pre-training stage, we design a new loss function that addresses three tasks, including Masked Span Prediction (MSP), Packet Order Prediction (POP), and Homologous Traffic Prediction (HTP), to better discern the latent patterns from various network traffic. Specifically, MSP serves as a denoising task that prompts Lens to recover masked tokens, thereby enabling the model to capture the representations within network traffic. POP predicts the order of packets within a single traffic input, facilitating the capture of latent features within the same session flow, where *flow means a sequence of packets* exchanged between two endpoints. Inspired by [19], HTP aids in identifying the relational patterns across different flows. For fine-tuning, we leverage task-oriented prompts coupled with a small amount of task-specific labeled data to precisely tune the parameters of Lens, making it effectively adaptive to various downstream tasks.

We assess the performance of Lens in both understanding and generation tasks using 6 real-world datasets [9, 11, 40, 37, 25, 27], including 15 traffic understanding tasks and 5 header fields generation tasks. Extensive experimental results show that Lens achieves an average accuracy improvement of 10.75% for packet level understanding tasks and 0.59% for flow level tasks, outperforming the baselines. Additionally, regarding traffic generation tasks, it outperforms the baselines in terms of Jensen-Shannon Divergence (JSD) and Total Variation Distance (TVD), reduced by an average of 0.1353 and 0.0825, respectively. Finally, our method requires 50% ~ 95% less labeled data for fine-tuning compared to the state-of-the-art approach.

In summary, our contributions are four-fold: (1) we introduce Lens, the first large network traffic model using the T5 architecture for traffic understanding and generation; (2) we explore the impact of different tokenization methods and their settings on the pre-training effectiveness; (3) we enhance the pre-training phase by integrating three specialized tasks, aiming to learn better representations from raw traffic data; (4) extensive experiments show the superiority of our model over baselines in various downstream tasks related to traffic understanding and generation.

2 Related Work

2.1 Network Traffic Understanding

Classical Machine Learning Methods. Earlier works have employed classical machine learning methods to network traffic analysis. For example, Wang et al. [42] used the k-Nearest Neighbors (KNN) to identify attacks. CUMUL

[28] adopted SVM for network traffic identification, while APPScanner and BIND [36, 1] used statistical features like temporality and packet size to train Random Forests classifiers for identification tasks. Besides, IsAnon [5] fused Modified Mutual Information and Random Forest (MMIRF) to filter out redundant features. However, these methods require expert knowledge for feature extraction and lack generalization capability.

Deep Learning Techniques. Deep learning techniques have been introduced to provide a more automated approach to comprehending network traffic without human-designed features. DF [34], for example, devised Convolutional Neural Networks (CNN) for identifying a novel website fingerprinting attack. In addition, FS-Net [21, 18] employed recurrent neural networks (RNN) and its variant LSTM [43, 39] to classify network traffic. Recently, a method called DeepPacket [23] is introduced. It combined the stacked autoencoder (SAE) with CNN to identify and extract the important features for traffic classification tasks. However, these approaches rely heavily on large amounts of labeled data and have limited generalization ability.

Pre-training Approaches. To improve model generalization ability, recent studies have adopted pre-training techniques to learn the representations from large-scale traffic data in an unsupervised manner. For instance, PERT [12] and ET-BERT [19] leveraged the pre-trained ALBERT [17] and BERT [8] models to learn the latent representations, respectively. However, these models are not applicable to traffic generation due to their encoder-only structure. Most recently, NetGPT [24] built on GPT-2 [30] has been developed for both traffic classification and generation in a generative way. However, it fails to capture the global information of input data due to its decoder-only framework, leading to sub-optimal performance on traffic understanding tasks [41]. Moreover, NetGPT¹ pre-trained on network traffic without removing IP addresses, which may result in a risk of privacy leakage. Lastly, it is only implemented on 8 downstream tasks for traffic classification while our Lens is tested on 15 downstream tasks. Table 1 summarizes the comparison of the proposed Lens and other existing methods.

Table 1: Comparison of the proposed Lens and existing pre-training methods. “Curated PT Func” denotes custom pre-training tasks for network traffic beyond the original task, while “IP Masking” means that all IP addresses and port numbers in the input should be anonymized or removed, and “GT” refers to the support of generation tasks.

Method	Encoder	Decoder	Curated PT Func	IP Masking	GT
PERT [12]	✓	✗	✗	✗	✗
ET-BERT [19]	✓	✗	✓	✓	✗
NetGPT [24]	✗	✓	✗	✗	✓
Lens(Ours)	✓	✓	✓	✓	✓

2.2 Network Traffic Generation

Tool-Based Traffic Generation. The classical traffic generation methods mainly focus on simulation tools and structure-based solutions. Simulation tools, such as NS-3 [13], yans [16], and DYNAMO [4], are based on varying network topology. Structure-based approaches like Iperf [2], Harpoon [35], and Swing [38] capture network patterns via heuristics. However, these traditional methods require vast domain expertise and might lack versatility. Moreover, tool-based traffic generation methods often result in rigid traffic patterns that may not accurately reflect the dynamic and stochastic nature of real-world network conditions. Consequently, they cannot effectively adapt to the evolving behaviors of cyber threats or user demands.

GAN-Based Traffic Generation. In addition, some studies have employed Generative adversarial networks (GAN) to generate network traffic. Ring et al. [32] first suggested the use of GAN [10] for the simulation of flow-level traffic. The following works include NetShare [44] and DoppelGANger [20], and others [26, 14]. For instance, NetShare generated packet and flow header traces for networking tasks, such as telemetry, anomaly detection, and provisioning. Though GAN-based methods are adaptive, their generated results may be inconsistent with target protocols [44].

Pre-training-based Generation. Most recently, researchers employed pre-training technique for traffic generation. Only one work called NetGPT [24] has been developed to generate key header fields. However, NetGPT did not compare it with state-of-the-art methods like NetShare in the experiments. Thus, it is hard to assess its performance on generalization.

¹NetGPT is currently preprinted and not open-sourced, and we thus do not compare our method with it.

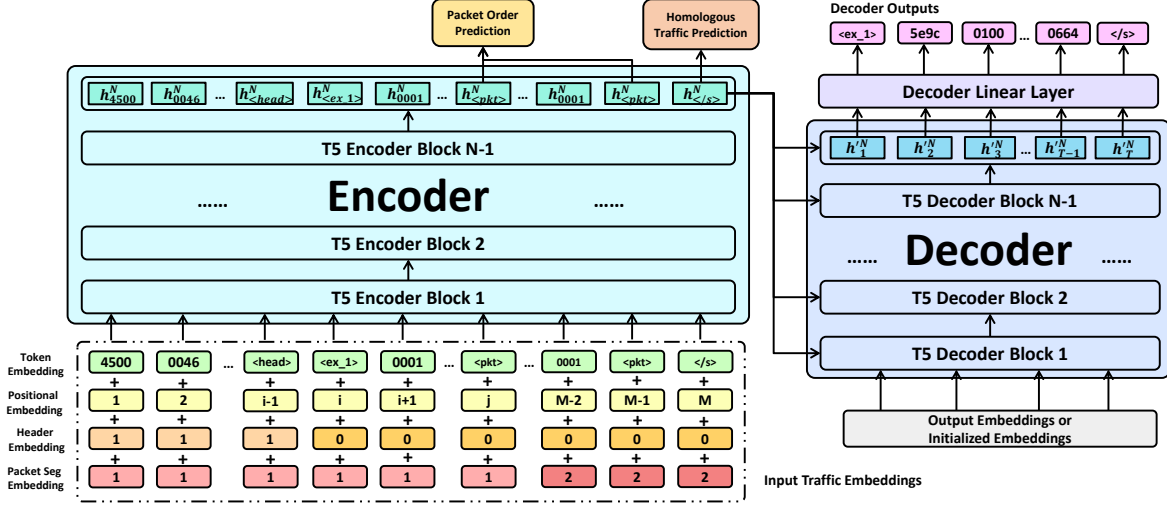

Figure 2: The core architecture of Lens for pre-training, which consists of an encoder and decoder.

Table 2: Accuracy of Masked Span Prediction across various tokenization strategies. The column headers “36,000”, “65,536”, and “80,000” denote the target vocabulary size.

Method / Vocab.	36,000	65,536	80,000
Vanilla Vocab	-	56.70	-
SentencePiece String	59.57	61.36	60.86
SentencePiece Word	63.48	65.65	63.02
WordPiece Word	64.86	66.22	-
WordPiece Pd.	66.53	68.87	-

3 Proposed Lens

In this section, we will introduce Lens, a large network traffic model for both traffic understanding and generation. Fig. 1 illustrates the overall framework of the proposed model, consisting of three main stages: traffic tokenization, pre-training, and fine-tuning. In Section 3.1, we will describe three different tokenization approaches: Vanilla Vocab, SentencePiece [15], and WordPiece [8]. We try to figure out which one performs best in our experiments in Sec. 4. Then we will present the pre-training process that involves three tasks: Masked Span Prediction (MSP), Packet Order Prediction (POP), and Homologous Traffic Prediction (HTP) in Section 3.2. Lastly, Section 3.3 will focus on the fine-tuning of the pre-trained Lens on a small amount of labeled data.

3.1 Traffic Tokenization

In the following, we first introduce the data pre-processing method, then elaborate on our traffic tokenization strategy.

3.1.1 Data pre-processing.

Different from textual data, network traffic comprises heterogeneous headers and payloads that may contain either plaintext or encrypted data [33, 6]. To ensure consistency in representation, it is crucial to standardize the input tokens for the model through a uniform approach.

To address this challenge, we use the following steps to pre-process the traffic data. First, we extract the session flows from the raw traffic data saved in pcap files, as shown in Fig. 1. Specifically, we extract each session flow using fixed IP addresses and port numbers of the two communicating endpoints. To preserve data privacy, we anonymize these session flows by resetting both source and destination IPs and ports to a default value 0. When anonymization process is complete, we convert every session flow into a hexadecimal format to enhance data uniformity [19]. After data pre-processing, our next step involves traffic tokenization.

3.1.2 Tokenization.

A well-designed tokenizer is critical for ensuring the successful training of a foundation model. It is often determined by three key factors: vocabulary size, input data patterns, and tokenization methods. Hence, we study the performance of three tokenization approaches with various settings on pre-training; namely Vanilla Vocab, SentencePiece [15], and WordPiece [8]. Vanilla Vocab splits the hex data into 4-digit words, creating a total vocabulary size of 65,536 by counting spans from 0x0000 to 0xffff. SentencePiece, used in the original T5 model [31], is a tokenizer algorithm that works directly on raw text without requiring pre-defined word boundaries (like white spaces) to split the text into subwords. WordPiece, used in BERT [8], is another tokenization method that breaks words (not raw text) into smaller subword pieces. Both of these two methods tokenize the input text with trained pieces used as a vocabulary.

As shown in Table 2, we further explore different settings for SentencePiece and WordPiece. Specifically, for SentencePiece, we examine two configurations: ‘SentencePiece String’, which processes an entire hex flow as a single string, and ‘SentencePiece Word’, which first divides hex flows into 4-digit words before treating it as a string. For WordPiece, we consider two settings: (i) ‘WordPiece Word’ splits the hex traffic into 4-digit words without using a predefined vocabulary; (ii) ‘WordPiece Pd.’ uses ‘Vanilla Vocab’ as the predefined vocabulary. This predefined vocabulary provides a standardized set of words that the algorithm can use to segment and recognize patterns in the data.

In addition to the above regular tokens, we also add some special tokens `</s>`, `<pad>`, `<unk>`, `<tsk>`, `<head>` and `<pkt>` in the vocabulary to signal the model for specific purposes. Here we briefly explain the usage of each special token. The token `</s>` signals the end of an input sequence. At the fine-tuning stage, `<tsk>` is used to distinguish descriptions of downstream tasks from input traffic; `<head>` is employed to separate header fields from payloads. In addition, `<pkt>` is placed at the end of each packet to mark packet boundaries. Examples of tokenized input are presented in the traffic tokenization process in Fig. 1.

Table 2 illustrates the comparison of pre-training accuracy for three tokenization approaches with different settings. We can observe that ‘WordPiece Pd.’ with a target vocabulary size of 65,536 achieves the highest accuracy. Therefore, we select this setting as the final tokenization algorithm to train our tokenizer for Lens.

3.2 Pre-Training

In this subsection, we will introduce the detailed pre-training process, as illustrated in Fig. 2. In short, we first present the input traffic embeddings by merging four different embeddings: token embedding, positional embedding, header embedding, and packet segment embedding. Then we design a novel objective function by incorporating three pre-training tasks: Masked Span Prediction, Packet Order Prediction, and Homologous Traffic Prediction.

3.2.1 Embeddings

As shown in figure 2, we represent the tokens derived from Traffic Tokenization using the embedding strategy by summing up four embedding types: token embedding, positional embedding, header embedding, and packet segment embedding. Note that the dimension of all embeddings is set to 768. The descriptions of each embedding are detailed below.

Token Embedding is a high-dimensional vector that uniquely represents a token, acting as its exclusive identifier. Each token is strongly associated with a single distinct vector.

Positional Embedding is used to maintain the contextual order within the input traffic data. Imagine a scenario where a token appears multiple times within the input data, but represents different meanings based on its position. Without marking its relative position, the distinct meanings of the token could converge, thus leading to ambiguity. Therefore, positional embedding is vital to guarantee that each instance of a token preserves its unique context according to its relative position.

Header Embedding aims to differentiate between the header fields and payload information encapsulated within session flows. Unlike text in natural language, the header and payload information in traffic data exhibit distinct characteristics and serve different functions. Specifically, header fields contain the meta-information about packets like the protocol types and packet length. Thus, we use header embedding to accurately represent their distinct functions.

Packet Segment Embedding is employed to differentiate each packet within a single flow, given that packets may not inherently share semantic associations. Furthermore, maintaining the order of packets is essential to preserve the temporal sequence of events in a session flow. Therefore, we employ this embedding to ensure that each packet is effectively learned with a focus on its distinctiveness and its position in the sequence of a flow.

3.2.2 New Objective with Three Tasks

Below, we will devise a new loss function for pre-training by integrating three different tasks. This can help better discern the latent representations learned from various traffic data.

Masked Span Prediction (MSP). Inspired by the span denoising task [31, 41], which has been proven to be effective across many NLP tasks, we introduce a similar task, called Masked Span Prediction (MSP), to enhance the learning of semantic patterns. As depicted in Figs. 1 and 2, the basic idea of MSP is to first mask specific spans, typically composed of one or more consecutive tokens in the original input, and then make the decoder restore the masked texts.

In the MSP approach, spans consist of 1 to 5 tokens uniformly, but on average, a span typically comprises 3 tokens.. For each span in this work, we randomly mask it with a 15% probability. Each masked span is sequentially replaced with a distinct sentinel token denoted by $\langle \text{extra_id_}i \rangle$ ($i \in [0, 99]$). Subsequently, the decoder is prompted to generate masked span using its correspondent sentinel token as a prefix. To calculate the loss function of MSP, we use the following negative log likelihood

$$\mathcal{L}_{\text{MSP}} = - \sum_{i=1}^k \log P(\text{MSPAN}_i = \text{SPAN}_i | \mathbf{x}_{\text{in}}, \text{MSPAN}_{<i}; \theta) \quad (1)$$

where θ represents model parameters, k is the total number of masked spans, MSPAN_i is i -th span generated by the decoder part of Lens, SPAN_i denotes the original span tokens, \mathbf{x}_{in} is the input sequence of the encoder, $\text{MSPAN}_{<i}$ indicates the generated spans from the decoder before i . MSPAN_i is generated given \mathbf{x}_{in} and $\text{MSPAN}_{<i}$ when parameterized by θ .

Packet Order Prediction. Packets in a session flow are naturally arranged in the order they occur over time, but existing pre-trained models in network traffic overlook these temporal patterns. To deal with this issue, we introduce the Packet Order Prediction (POP) task to enhance Lens’s ability to capture the inherent information within the input traffic flows.

For the POP task, we randomly select 15% of the input flows and shuffle the packets within each selected flow. With the special token $\langle \text{pkt} \rangle$ - acting as a suffix for all packets as described in Section 3.1 - Lens can easily identify all packets within the input. The order prediction is then carried out by treating POP as a classification task. It categorizes packets into one of three distinct classes, denoted as $c \in \{1, 2, 3\}$. As illustrated in Fig 1, these classes represent the relative order of packets within a flow, focusing on the first three packets that we preserve following prior work [7]. Below, we detail the POP task.

Given an input flow f_i (the i -th sample), suppose that it is composed of t packets $\sum^t P_k^{(i)}$ ($t \leq 3$), where $P_k^{(i)}$ denotes the k -th packet from flow i . We use $\langle \text{pkt} \rangle$ token to delineate each packet. Let y_{ij} be an indicator that confirms if the j -th packet is indeed in its original position, with 1 for yes and 0 for no, i.e, $y_{ij} = \text{isSamePosition}(c_{ij})$, where c_{ij} is the real position for packet j in flow i . Besides, we use $z_i \in \{0, 1\}$ to denote whether packets from f_i come from homologous traffic (which will be introduced in the next paragraph). This can help us avoid applying both POP and HTP tasks on the same flow since applying POP to the heterologous flow is meaningless. Then we have the following loss function for POP

$$\mathcal{L}_{\text{POP}} = - \sum_{i=1}^M z_i \sum_{j=1}^t \log P(y_{ij} | \mathbf{x}_{\text{in}}; \theta) \quad (2)$$

where M is the batch size of input flows.

Homologous Traffic Prediction. Inspired by ET-BERT [19], we propose a Homologous Traffic Prediction (HTP) task to capture variances between different flows, as illustrated in Fig. 1. In the HTP task, we select 30% of the flows that are not previously involved in the POP.

Each flow in the selected set is divided into two subflows. We label the subflows divided from a f_i as (sf_i^1, sf_i^2) . Consider each selected f_i' , its new composition structure becomes $f_i' = (sf_i^1, sf_j^2)$, where $j \neq i$ after HTP shuffling. The goal of Lens is to determine whether the current input flow has been reorganized. To achieve this, we use a ground-truth label $y_i \in \{0, 1\}$, where 0 and 1 respectively indicate heterologous and homologous. We employ the hidden state of the specialized token $\langle /s \rangle$ for HTP, as it captures the global information of the input. The loss function of the HTP task is given by:

$$\mathcal{L}_{\text{HTP}} = - \sum_{i=1}^M \log P(y_i | \mathbf{x}_{\text{in}}; \theta), \quad (3)$$

where M is the batch size of input flows, \mathbf{x}_{in} denotes the input sequence and θ represents the model parameters.

Table 3: The statistics of datasets for fine-tuning.

Dataset	#Flows	#Packets
ISCXVPN 2016 [9]	4,850	12,462
ISCTXor 2016 [11]	4,600	19,945
USTC-TFC 2016 [40]	5,000	24,903
Cross Platform (iOS) 2020 [37]	7,644	30,411
Cross Platform (Android) 2020 [37]	8,199	29,791
CIRA-CIC-DoHBrw-2020 [25]	5,000	24,903
CIC IoT Dataset 2023 [27]	6,399	20,265

Objective Function. Given the above three tasks, the final objective function is defined as:

$$\mathcal{L}_{\text{tot}} = \mathcal{L}_{\text{MSP}} + \alpha \cdot \mathcal{L}_{\text{POP}} + \beta \cdot \mathcal{L}_{\text{HTP}}, \tag{4}$$

where α and β are hyper-parameters.

3.3 Fine-Tuning

After finishing model pre-training, the next step is to fine-tune the proposed Lens on a small amount of data from various downstream tasks. We can achieve this by using task-specific transfer learning for all tasks. In the following, we detail how to fine-tune our foundation model in traffic understanding and traffic generation, respectively.

Regarding traffic understanding task, Lens is not provided with prior knowledge about the classes of the downstream task to ensure the model’s generalization ability. Rather, a generative method is employed to learn the corresponding labels through simple data training in coordination with the encoder and decoder. The actual prediction task then generates the tokens of the predicted class label. As shown in Fig. 1, the input format for the understanding task is defined as [task description] <tsk> [input traffic].

For the generation task, fine-tuning is achieved in a similar manner to the understanding task, wherein the encoder and decoder components of Lens learn concurrently during the fine-tuning stage. In this case, the decoder creates the tokens of prediction results. As shown in Fig. 1, the input format for the generation task mirrors the understanding task: [task description] <tsk> [input traffic]. However, a noticeable difference is the absence of header fields within the input traffic for the generation task.

4 Experiments

Extensive experiments are carried out to evaluate the performance of the proposed Lens on both traffic understanding and traffic generation tasks across six different datasets. First, we elaborate on experimental settings, including data preparation, metrics, implementation details, and downstream tasks. Then we compare our Lens with some competitive baselines in both traffic understanding and traffic generation. Finally, we do ablation studies to further investigate the impact of main components on model performance.

4.1 Experimental Settings

4.1.1 Data Preparation.

In our experiments, we use six publicly available datasets with the total data size of 645GB: ISCXVPN [9], ISCTXor [11], USTC-TFC [40], Cross Platform [37], CIRA-CIC-DoHBrw-2020 [25], and the CIC IoT Dataset 2023 [27].

At the beginning of our experiments, we first split raw pcap files into individual flows, which are then converted into a hexadecimal format. Then, we randomly choose some flows from each dataset for fine-tuning, as detailed in Table 3. The remaining of data is used for pre-training. Below, we introduce the detailed experimental setup for pre-training and fine-tuning.

The pre-training process involves a hex-based preprocessing of each session flow as introduced in Section 3.1. Following prior work [7], we limit the scope to the initial three packets of any large flows. This strategy aims to retain essential features of a session flow while managing the input size effectively. In addition, the CIC IoT Dataset 2023 is much larger than other datasets, which could result in imbalanced data distribution during model training. To deal with this

issue, we limit the data extracted from this dataset to around 50 GB for pre-training. Note that the Cross Platform dataset is not incorporated during pre-training, since it will be used to assess the generalization ability of Lens on unseen datasets.

In contrast to pre-training which only uses flow-level data, fine-tuning may input a flow or a packet into the model since some downstream tasks operate at either a flow level or packet level. Specifically, for flow-level tasks, we extract the first three packets from each large flow as mentioned earlier. For packet-level tasks, we choose the first five packets of each flow. This selective strategy demonstrates the Lens’s adaptability and effective performance even with limited labeled data. Note that compared to other methods like ET-BERT, our model requires 50% ~ 95% fewer packets for fine-tuning. Regarding traffic generation, we mask the header fields that would be predicted during both training and testing. At the fine-tuning stage, we split pre-processed data into a training set and a testing set at a ratio of 4:1.

4.1.2 Evaluation Metrics

For traffic understanding tasks, two main metrics: Accuracy (AC) and Macro F1 Score (F1), are used to assess the proposed Lens. To evaluate the traffic generation performance of our model, we utilize the Jensen-Shannon Divergence (JSD) and Total Variation Distance (TVD). JSD measures how similar two probability distributions are, reflecting their shared information, while TVD identifies the largest difference in probabilities between two distributions, highlighting the most extreme variances.

4.1.3 Implementation Details.

We adopt Google’s T5-v1.1-base model [31], which contains roughly 0.25B parameters, as the foundational architecture for the proposed Lens. For the final objective function introduced in Eq. 4, we set both α and β to 0.2 based on grid search method, as detailed in Appendix A.3. At the pre-training stage, we set the batch size to 128 and implement gradient accumulation over 4 training steps. The learning rate is set to 2×10^{-2} over a total of 56,000 steps with a warmup steps of 8000. We also use a dropout rate of 0.1 to mitigate the risk of overfitting. For fine-tuning, we set the batch size to 32 and the learning rate to 3×10^{-5} , training each downstream task for 10 epochs using the AdamW optimizer [22] on a single GPU with 48GB memory capacity.

4.1.4 Downstream tasks.

To evaluate the good performance of our Lens, we select 15 different understanding tasks to classify network traffic as well as 5 generation tasks for generating important header fields (source IP, destination IP, source port, destination port, packet length). To our best knowledge, we evaluate a wider range of downstream tasks compared to existing works. Below, we describe the experimental settings for both traffic understanding and generation.

Traffic Understanding Tasks: Our experiments span across 15 different traffic understanding tasks over the above 6 datasets. The datasets and their downstream tasks are detailed below. For ISCXVPN 2016, our tasks include VPN detection (task 1) with a binary class, VPN Service detection (task 2) encompassing 6 classes, and VPN application classification (task 3) with 17 classes. For ISCXTor 2016 dataset, our tasks involve Tor detection (task 4) with 2 categories and Tor service detection (task 5) with 7 classes. For USTC-TFC 2016 dataset, we focus on Malware detection (task 6) with a binary measurement, alongside Application Classification (task 7) that involves 20 classes. For the Cross Platform (Android), we have application classification (task 8) with 209 classes and country detection task (task 9) with 3 classes. In addition, regarding the Cross Platform (iOS), we have application classification (task 10) with 196 classes and country detection (task 11) with 3 classes. For CIRA-CIC-DoHBrw-2020, we implement DoH attack detection (task 12) under a binary class framework and DoH query method classification (task 13) with 5 classes. Lastly, for the CIC IoT Dataset 2023, we explore IoT attack detection (task 14) with 2 classes and IoT attack method detection (task 15) composed of 8 classes.

Traffic Generation Tasks: Based on the methodology of NetShare [44], we generate five vital header fields at the packet level as follows: source IP, destination IP, source port, destination port, and packet length. The generation of these synthetic header fields can help create usable pcap traffic for network simulation. For each dataset in our experiments, all generation tasks are individually conducted using a supervised fine-tuning approach.

4.2 Evaluation Results

In this subsection, we first assess the proposed Lens on traffic understanding tasks, and then apply it to traffic generation tasks. For traffic understanding, we compare the proposed model against 7 state-of-the-art (SOTA) baselines. For traffic generation, we primarily compare our method with the most competitive and open-sourced baseline, NetShare.

Table 4: Comparison results of traffic understanding tasks from task 1 to task 8.

Method	Task 1		Task 2		Task 3		Task 4		Task 5		Task 6		Task 7		Task 8	
	AC	F1	AC	F1	AC	F1	AC	F1	AC	F1	AC	F1	AC	F1	AC	F1
FS-Net	0.9336	0.4828	0.5625	0.4195	0.2148	0.3581	1.0000	1.0000	0.8047	0.6972	0.3398	0.2536	0.7594	0.7375	0.0977	0.0595
BiLSTM_Att	1.0000	1.0000	0.7487	0.5394	0.4847	0.3674	1.0000	1.0000	0.2755	0.1063	1.0000	1.0000	0.6070	0.4470	0.0772	0.0631
Datanet	0.9982	0.9960	0.7361	0.4837	0.4901	0.3558	1.0000	1.0000	0.2493	0.0582	1.0000	1.0000	0.5430	0.4032	0.0176	0.0097
DeepPacket	1.0000	1.0000	0.7307	0.5230	0.5009	0.3656	1.0000	1.0000	0.2755	0.1063	1.0000	1.0000	0.6070	0.4470	0.0737	0.0518
TSCRNN	0.9982	0.9960	0.7451	0.5264	0.5027	0.3773	1.0000	1.0000	0.2755	0.1121	1.0000	1.0000	0.6070	0.4470	0.2188	0.1929
YaTC	0.9856	0.9632	0.6887	0.6313	0.5567	0.5883	1.0000	1.0000	0.8196	0.7315	1.0000	1.0000	0.9820	0.9828	0.6012	0.5611
ET-Bert (flow)	0.9570	0.8218	0.5900	0.5302	0.3935	0.3819	0.9955	0.4989	0.8909	0.8147	1.0000	1.0000	0.9581	0.9560	0.1313	0.0992
ET-Bert (pkt)	0.9964	0.9884	0.9791	0.9769	0.9792	0.9773	1.0000	1.0000	0.9921	0.9894	1.0000	1.0000	0.9985	0.9959	0.8332	0.8211
Lens (flow)	0.9984	0.9958	0.9797	0.9698	0.9698	0.9717	1.0000	1.0000	0.9319	0.8594	1.0000	1.0000	0.9940	0.9937	0.9063	0.8981
Lens (pkt)	0.9992	0.9982	0.9849	0.9806	0.9877	0.9859	0.9997	0.9871	0.9622	0.9441	1.0000	1.0000	0.9905	0.9896	0.9326	0.9228

Table 5: Comparison results of traffic understanding tasks from tasks 9 to 15. ‘‘Avg.’’ means the average accuracy on 15 tasks.

Method	Task 9		Task 10		Task 11		Task 12		Task 13		Task 14		Task 15		Avg.
	AC	F1	AC	F1	AC	F1	AC	F1	AC	F1	AC	F1	AC	F1	AC
FS-Net	0.1563	0.1046	0.1068	0.0574	0.4440	0.2050	0.5980	0.3742	0.8800	0.8714	0.8375	0.4558	0.4883	0.4250	0.5482
BiLSTM_Att	0.6083	0.4428	0.1078	0.1006	0.6049	0.5415	1.0000	1.0000	0.6506	0.6400	0.9001	0.7652	0.7570	0.5943	0.6321
Datanet	0.5743	0.3278	0.0079	0.0001	0.5494	0.4350	1.0000	1.0000	0.6558	0.6403	0.8934	0.6147	0.7633	0.5863	0.6123
DeepPacket	0.5779	0.3630	0.0579	0.0473	0.5553	0.4666	1.0000	1.0000	0.6253	0.5862	0.9015	0.7673	0.7500	0.5736	0.5851
TSCRNN	0.6118	0.4368	0.1043	0.0964	0.5935	0.5204	1.0000	1.0000	0.6502	0.6443	0.8968	0.6373	0.7578	0.6067	0.6212
YaTC	0.9890	0.9866	0.6248	0.5938	0.9503	0.9263	1.0000	1.0000	0.9800	0.9799	0.9647	0.9265	0.8394	0.7673	0.8655
ET-Bert (flow)	0.7454	0.7136	0.3401	0.2992	0.8650	0.8597	1.0000	1.0000	0.6714	0.6279	0.8384	0.7035	0.7026	0.5662	0.7386
ET-Bert (pkt)	0.9845	0.9824	0.9289	0.9254	0.9872	0.9887	1.0000	1.0000	1.0000	1.0000	0.9704	0.9480	0.9320	0.9181	0.9721
Lens (flow)	0.9822	0.9808	0.9189	0.9143	0.9867	0.9816	1.0000	1.0000	0.9506	0.9507	0.9712	0.9285	0.9054	0.9061	0.9663
Lens (pkt)	0.9832	0.9806	0.9349	0.9266	0.9896	0.9880	0.9982	0.9981	0.9885	0.9885	0.9841	0.9658	0.9412	0.9363	0.9784

4.2.1 Traffic Understanding Tasks.

First, we evaluate the performance of Lens on a variety of traffic understanding tasks. We compare it with the following baselines: FS-Net [21], BiLSTM_Att [43], Datanet [39], DeepPacket [23], YaTC [45], TSCRNN [18], and ET-BERT [19]. In this experiment, we assess different methods with a focus on two levels of data granularity: flow level and packet level. Tables 4 and 5 illustrate the comparison results of our Lens and the baselines in traffic understanding tasks. From the evaluation results, we can conclude with three main insights: (1) Lens consistently achieves SOTA performance in most tasks, indicating its superiority over all the baselines. (2) With limited testing samples, Lens using packet-level input reaches higher accuracy and F1 than that of using flow-level input. In particular, ET-BERT demonstrates a significant average accuracy difference of 30.13% between these two data granularities. In contrast, our Lens still achieves comparable performance, with only 1.41% variance across two levels of data granularity. (3) Even if without using the CrossPlatform dataset in pre-training, Lens outperforms the baselines in three out of four tasks, especially for tasks 8, 10, and 11, demonstrating its strong generalization ability.

4.2.2 Generation Tasks.

In addition, we conduct experiments to evaluate the performance of Lens on traffic generation tasks by comparing it with the SOTA method, NetShare [44]. In this experiment, two evaluation metrics: Jensen-Shannon Divergence (JSD) and Total Variation Distance (TVD), are used to measure the results. In terms of metrics JSD and TVD, a lower value means better performance, indicating a smaller distribution difference between the generated and ground-truth data. The generation results related to the port number and packet length are illustrated in Tables 6, while the results of IP generation are introduced in Appendix A.1. We draw some conclusions from this table as follows: (1) Lens outperforms NetShare in most tasks in terms of TVD and JSD, demonstrating its good generation performance. Compared to NetShare, Lens can generate more high-quality synthetic traffic data by reducing JSD and TVD by 62% and 77% on average, respectively. (2) Lens consistently outperforms the NetShare in the task of packet length generation under both metrics. (3) Even if our model does not pre-train on the CrossPlatform dataset, it still surpasses the NetShare across most generation tasks in this dataset. More visual results are presented in Appendix A.2.

Table 6: Comparison results of different methods on generation tasks in terms of JSD and TVD. We can see that Lens outperforms NetShare on most of the tasks with JSD and all of the tasks with TVD.

Datasets	Method	JSD			TVD		
		Src Port	Dst Port	Len	Src Port	Dst Port	Len
ISCXVPN	NetShare	0.1622	0.1494	0.5451	0.4966	0.4755	0.9011
	Lens	0.0947	0.0292	0.0044	0.1530	0.0467	0.0093
ISCXTor	NetShare	0.0736	0.0711	0.3091	0.2190	0.2269	0.7004
	Lens	0.0887	0.1048	0.0063	0.1550	0.1784	0.0134
USTC-TFC	NetShare	0.2268	0.1144	0.4908	0.5899	0.4091	0.8598
	Lens	0.0591	0.0609	0.0022	0.0958	0.0982	0.0039
Cross Platform (iOS)	NetShare	0.0499	0.0217	0.3981	0.2176	0.1592	0.7748
	Lens	0.0561	0.0630	0.0041	0.1053	0.1120	0.0112
Cross Platform (AN)	NetShare	0.0520	0.0323	0.4266	0.2177	0.2216	0.8008
	Lens	0.0869	0.0724	0.0052	0.1482	0.1200	0.0143
CIRA-CIC-DoHBrw	NetShare	0.0359	0.0963	0.4806	0.1749	0.3605	0.8576
	Lens	0.0521	0.0546	0.0008	0.0917	0.0875	0.0014
CIC IoT Dataset 2023	NetShare	0.0666	0.0370	0.4199	0.2636	0.2126	0.7957
	Lens	0.1203	0.0784	0.0021	0.1989	0.0828	0.0047

4.3 Ablation Studies

In this study, we investigate the influence of various components on the performance of our proposed foundation model in traffic understanding and generation tasks using the USTC-TFC2016 dataset. More specifically, we examine the effects of pre-training, Masked Span Prediction (MSP), Packet Order Prediction (POP), and Homologous Traffic Prediction (HTP) on model’s performance .

For understanding tasks, we choose task 7 (Application Classification) as a representative example. The findings in Table 7 indicate that the absence of pre-training leads to a reduction in accuracy of Lens by approximately 1.1% to 1.5%. Moreover, if we remove one of the three components, MSP, POP, and HTP, in the loss function, its accuracy will be decreased but not too much. This is primarily due to two reasons: (i) Task 7, like other understanding tasks, is not exceedingly complex, so its features can be easily extracted to classify the input traffic; (ii) Lens has sufficient capability to discern the traffic patterns even if it is fine-tuned on a small amount of data. However, pre-training with these three components still enhances performance, particularly in the following traffic generation tasks.

In the context of generation tasks, we assess the model’s performance in source port generation using the USTC-TFC2016 data. As shown in Table 8, the model’s generative capabilities deteriorate significantly in the absence of pre-training or MSP. Conversely, the removal of HTP does not affect the generation performance too much. These observations underscore the necessity of pre-training the model with substantial volumes of raw data and incorporating MSP into this stage.

Table 7: Ablation studies on understanding task. It can be seen that pre-training with all designed tasks contribute to performance improvement.

Settings	AC	F1
Lens (Full model)	0.9940	0.9937
w/o MSP	0.9702	0.9689
w/o POP	0.9885	0.9881
w/o HTP	0.9868	0.9834
w/o Pre-training	0.9799	0.9798

5 Conclusion and Future Work

In this paper, we introduced Lens, a foundation model for network traffic excelling in both network traffic understanding and generation. Built on the T5 architecture, Lens can effectively learn the latent representations by pre-training on

Table 8: Ablation studies on generation tasks. It can be observed that pre-trained Lens can improve the performance of generation by a large margin.

Settings	JSD	TVD
Lens (Full model)	0.0591	0.0958
w/o MSP	0.1063	0.2142
w/o POP	0.0642	0.1563
w/o HTP	0.0609	0.0945
w/o Pre-training	0.1280	0.2119

large-scale unlabeled data. We also explored three different tokenization algorithms on the pre-training performance, and found that WordPiece with a predefined vocabulary performs the best. To further enhance the performance of Lens, we designed a new objective function that takes three pre-training tasks into account. Besides, we conducted ablation studies to validate the effectiveness of proposed components in the pre-training process. We evaluated the performance of Lens on 6 real-world datasets, including 15 understanding tasks and 5 header fields generation tasks. Evaluation results demonstrated that our model outperforms the baselines in most of downstream tasks, showcasing its effectiveness and strong generalization ability. It is worth noting that our approach required 50% ~ 95% less labeled data for fine-tuning compared to other pre-training methods like ET-BERT and YaTC.

For future work, we plan to upscale the model parameters for Lens. Moreover, we would like to investigate trustworthy foundation models for network traffic.

References

- [1] K. Al-Naami, S. Chandra, A. Mustafa, L. Khan, Z. Lin, K. Hamlen, and B. Thuraisingham. Adaptive encrypted traffic fingerprinting with bi-directional dependence. In *Proceedings of the 32nd Annual Conference on Computer Security Applications*, pages 177–188, 2016.
- [2] A. Botta, A. Dainotti, and A. Pescapé. A tool for the generation of realistic network workload for emerging networking scenarios. *Computer Networks*, 56(15):3531–3547, 2012.
- [3] T. Brown, B. Mann, N. Ryder, M. Subbiah, J. D. Kaplan, P. Dhariwal, A. Neelakantan, P. Shyam, G. Sastry, A. Askell, et al. Language models are few-shot learners. *Advances in neural information processing systems*, 33:1877–1901, 2020.
- [4] T. Bühler, R. Schmid, S. Lutz, and L. Vanbever. Generating representative, live network traffic out of millions of code repositories. In *Proceedings of the 21st ACM Workshop on Hot Topics in Networks*, pages 1–7, 2022.
- [5] Z. Cai, B. Jiang, Z. Lu, J. Liu, and P. Ma. isanon: Flow-based anonymity network traffic identification using extreme gradient boosting. In *2019 International Joint Conference on Neural Networks (IJCNN)*, pages 1–8. IEEE, 2019.
- [6] J. Daemen and V. Rijmen. Aes proposal: Rijndael. 1999.
- [7] J. Dai, X. Xu, and F. Xiao. Glads: A global-local attention data selection model for multimodal multitask encrypted traffic classification of iot. *Computer Networks*, 225:109652, 2023.
- [8] J. Devlin, M.-W. Chang, K. Lee, and K. Toutanova. Bert: Pre-training of deep bidirectional transformers for language understanding. *arXiv preprint arXiv:1810.04805*, 2018.
- [9] G. Draper-Gil, A. H. Lashkari, M. S. I. Mamun, and A. A. Ghorbani. Characterization of encrypted and vpn traffic using time-related. In *Proceedings of the 2nd international conference on information systems security and privacy (ICISSP)*, pages 407–414, 2016.
- [10] I. Goodfellow, J. Pouget-Abadie, M. Mirza, B. Xu, D. Warde-Farley, S. Ozair, A. Courville, and Y. Bengio. Generative adversarial nets. *Advances in neural information processing systems*, 27, 2014.
- [11] A. Habibi Lashkari., G. Draper Gil., M. S. I. Mamun., and A. A. Ghorbani. Characterization of tor traffic using time based features. In *Proceedings of the 3rd International Conference on Information Systems Security and Privacy - ICISSP*, pages 253–262. INSTICC, SciTePress, 2017.
- [12] H. Y. He, Z. G. Yang, and X. N. Chen. Pert: Payload encoding representation from transformer for encrypted traffic classification. In *2020 ITU Kaleidoscope: Industry-Driven Digital Transformation (ITU K)*, pages 1–8. IEEE, 2020.
- [13] T. R. Henderson, M. Lacage, G. F. Riley, C. Dowell, and J. Kopena. Network simulations with the ns-3 simulator. *SIGCOMM demonstration*, 14(14):527, 2008.
- [14] S. Hui, H. Wang, Z. Wang, X. Yang, Z. Liu, D. Jin, and Y. Li. Knowledge enhanced gan for iot traffic generation. In *Proceedings of the ACM Web Conference 2022*, pages 3336–3346, 2022.
- [15] T. Kudo and J. Richardson. Sentencepiece: A simple and language independent subword tokenizer and detokenizer for neural text processing. *arXiv preprint arXiv:1808.06226*, 2018.
- [16] M. Lacage and T. R. Henderson. Yet another network simulator. In *Proceedings of the 2006 Workshop on ns-3*, pages 12–es, 2006.
- [17] Z. Lan, M. Chen, S. Goodman, K. Gimpel, P. Sharma, and R. Soricut. Albert: A lite bert for self-supervised learning of language representations. *arXiv preprint arXiv:1909.11942*, 2019.
- [18] K. Lin, X. Xu, and H. Gao. Tscrnn: A novel classification scheme of encrypted traffic based on flow spatiotemporal features for efficient management of iiot. *Computer Networks*, 190:107974, 2021.
- [19] X. Lin, G. Xiong, G. Gou, Z. Li, J. Shi, and J. Yu. Et-bert: A contextualized datagram representation with pre-training transformers for encrypted traffic classification. In *Proceedings of the ACM Web Conference 2022*, pages 633–642, 2022.
- [20] Z. Lin, A. Jain, C. Wang, G. Fanti, and V. Sekar. Using gans for sharing networked time series data: Challenges, initial promise, and open questions. In *Proceedings of the ACM Internet Measurement Conference*, pages 464–483, 2020.
- [21] C. Liu, L. He, G. Xiong, Z. Cao, and Z. Li. Fs-net: A flow sequence network for encrypted traffic classification. In *IEEE INFOCOM 2019-IEEE Conference On Computer Communications*, pages 1171–1179. IEEE, 2019.
- [22] I. Loshchilov and F. Hutter. Decoupled weight decay regularization. *arXiv preprint arXiv:1711.05101*, 2017.

- [23] M. Lotfollahi, M. Jafari Siavoshani, R. Shirali Hossein Zade, and M. Saberian. Deep packet: A novel approach for encrypted traffic classification using deep learning. *Soft Computing*, 24(3):1999–2012, 2020.
- [24] X. Meng, C. Lin, Y. Wang, and Y. Zhang. Netgpt: Generative pretrained transformer for network traffic. *arXiv preprint arXiv:2304.09513*, 2023.
- [25] M. MontazeriShatoori, L. Davidson, G. Kaur, and A. H. Lashkari. Detection of doh tunnels using time-series classification of encrypted traffic. In *2020 IEEE Intl Conf on Dependable, Autonomic and Secure Computing, Intl Conf on Pervasive Intelligence and Computing, Intl Conf on Cloud and Big Data Computing, Intl Conf on Cyber Science and Technology Congress (DASC/PiCom/CBDCCom/CyberSciTech)*, pages 63–70. IEEE, 2020.
- [26] A. Mozo, Á. González-Prieto, A. Pastor, S. Gómez-Canaval, and E. Talavera. Synthetic flow-based cryptomining attack generation through generative adversarial networks. *Scientific reports*, 12(1):2091, 2022.
- [27] E. C. P. Neto, S. Dadkhah, R. Ferreira, A. Zohourian, R. Lu, and A. A. Ghorbani. Ciciot2023: A real-time dataset and benchmark for large-scale attacks in iot environment. 2023.
- [28] A. Panchenko, F. Lanze, J. Pennekamp, T. Engel, A. Zinnen, M. Henze, and K. Wehrle. Website fingerprinting at internet scale. In *NDSS*, 2016.
- [29] A. Radford, K. Narasimhan, T. Salimans, I. Sutskever, et al. Improving language understanding by generative pre-training. 2018.
- [30] A. Radford, J. Wu, R. Child, D. Luan, D. Amodei, I. Sutskever, et al. Language models are unsupervised multitask learners. *OpenAI blog*, 1(8):9, 2019.
- [31] C. Raffel, N. Shazeer, A. Roberts, K. Lee, S. Narang, M. Matena, Y. Zhou, W. Li, and P. J. Liu. Exploring the limits of transfer learning with a unified text-to-text transformer. *The Journal of Machine Learning Research*, 21(1):5485–5551, 2020.
- [32] M. Ring, D. Schlör, D. Landes, and A. Hotho. Flow-based network traffic generation using generative adversarial networks. *Computers & Security*, 82:156–172, 2019.
- [33] R. Rivest. The md5 message-digest algorithm. Technical report, 1992.
- [34] P. Sirinam, M. Imani, M. Juarez, and M. Wright. Deep fingerprinting: Undermining website fingerprinting defenses with deep learning. In *Proceedings of the 2018 ACM SIGSAC Conference on Computer and Communications Security*, pages 1928–1943, 2018.
- [35] J. Sommers, H. Kim, and P. Barford. Harpoon: a flow-level traffic generator for router and network tests. *ACM SIGMETRICS Performance Evaluation Review*, 32(1):392–392, 2004.
- [36] V. F. Taylor, R. Spolaor, M. Conti, and I. Martinovic. Robust smartphone app identification via encrypted network traffic analysis. *IEEE Transactions on Information Forensics and Security*, 13(1):63–78, 2017.
- [37] T. Van Ede, R. Bortolameotti, A. Continella, J. Ren, D. J. Dubois, M. Lindorfer, D. Choffnes, M. van Steen, and A. Peter. Flowprint: Semi-supervised mobile-app fingerprinting on encrypted network traffic. In *Network and distributed system security symposium (NDSS)*, volume 27, 2020.
- [38] K. V. Vishwanath and A. Vahdat. Swing: Realistic and responsive network traffic generation. *IEEE/ACM Transactions on Networking*, 17(3):712–725, 2009.
- [39] P. Wang, F. Ye, X. Chen, and Y. Qian. Datanet: Deep learning based encrypted network traffic classification in sdn home gateway. *IEEE Access*, 6:55380–55391, 2018.
- [40] W. Wang, M. Zhu, X. Zeng, X. Ye, and Y. Sheng. Malware traffic classification using convolutional neural network for representation learning. In *2017 International conference on information networking (ICOIN)*, pages 712–717. IEEE, 2017.
- [41] Y. Wang, W. Wang, S. Joty, and S. C. Hoi. Codet5: Identifier-aware unified pre-trained encoder-decoder models for code understanding and generation. *arXiv preprint arXiv:2109.00859*, 2021.
- [42] Z. Wang, W. Hamza, and L. Song. k -nearest neighbor augmented neural networks for text classification. *arXiv preprint arXiv:1708.07863*, 2017.
- [43] H. Yao, C. Liu, P. Zhang, S. Wu, C. Jiang, and S. Yu. Identification of encrypted traffic through attention mechanism based long short term memory. *IEEE Transactions on Big Data*, 8(1):241–252, 2019.
- [44] Y. Yin, Z. Lin, M. Jin, G. Fanti, and V. Sekar. Practical gan-based synthetic ip header trace generation using netshare. In *Proceedings of the ACM SIGCOMM 2022 Conference*, pages 458–472, 2022.
- [45] R. Zhao, M. Zhan, X. Deng, Y. Wang, Y. Wang, G. Gui, and Z. Xue. Yet another traffic classifier: a masked autoencoder based traffic transformer with multi-level flow representation. In *Proceedings of the AAAI Conference on Artificial Intelligence*, volume 37, pages 5420–5427, 2023.

A Appendix

We will further study the traffic generation tasks. Specifically, in Section A.1, we will introduce the source port generation and destination port generation tasks; in Section A.2, additional visual statistics are provided for various traffic generation tasks across all datasets.

A.1 IP Generation Tasks

A.1.1 Evaluation Metrics

We use JSD, TVD and DR (Diversity Ratio) to evaluate the performance of IP generation tasks. JSD and TVD have been introduced in Section 4.1.2, while DR is defined as the ratio of the number of generated valid IP addresses and the total testing cases.

A.1.2 Performance Analysis

As shown in Table 10 and 11, we can see that (1) *Lens* outperforms the *NetShare* according JSD and TVD metrics by a large margin in most of tasks, indicating that the distribution of results generated by *Lens* is closer to the real settings than that generated by *NetShare*; (2) *Lens* can generate more diversified IP addresses compared to *NetShare*, meaning that *Lens* can mimic the real-world network complexity better.

A.2 Visualizing Traffic Generation Distribution Results

We further present more visual results over generation tasks for source port, destination port and packet length from figure 3 to 9. In each figure, the first 3 sub-figures describes the relationships among the real settings, *NetShare* and *Lens* according to top- k (here we set k to 5) values of real settings, while the last three sub-figures measure the CDF (Cumulative Distribution Function) for different generation tasks.

A.3 Experiments over Pre-training Loss Hyperparameters

To determine the best weight α and β in Eq. (4), we experiment some hyperparameter settings as shown in table 9. We can see from this table that when α and β are all set to 0.2, *Lens* achieves the best performance on Masked Span Prediction task.

Table 9: Accuracy of Masked Span Prediction under different α and β settings in equation 4.

$\alpha \backslash \beta$	0.1	0.2	0.5	1.0
0.1	0.654	0.431	0.649	-
0.2	0.649	0.689	0.634	-
0.5	0.596	0.655	0.599	-
1.0	-	-	-	0.462

Table 10: Comparison results of source IP generation task.

Method	VPN			Tor			USTC-TFC2016			CrossPlatform (iOS)			CrossPlatform (AN)			DoHBrw			IoT		
	JSD	TVD	DR	JSD	TVD	DR	JSD	TVD	DR	JSD	TVD	DR	JSD	TVD	DR	JSD	TVD	DR	JSD	TVD	DR
Real	-	-	0.1222	-	-	0.1570	-	-	0.4086	-	-	0.1586	-	-	0.1467	-	-	0.1226	-	-	0.0799
NetShare	0.1218	0.3513	0.0200	0.0168	0.0880	0.0066	0.0363	0.2148	0.2173	0.0588	0.2665	0.0609	0.0572	0.2909	0.0478	0.3548	0.7113	0.3583	0.0452	0.2598	0.0558
Lens	0.0309	0.0678	0.1408	0.0372	0.0610	0.1555	0.0713	0.1196	0.4030	0.0326	0.0605	0.1724	0.0297	0.0687	0.1524	0.0279	0.0492	0.1129	0.0249	0.0828	0.0861

Table 11: Comparison results of traffic destination IP generation task.

Method	VPN			Tor			USTC-TFC2016			CrossPlatform (iOS)			CrossPlatform (AN)			DoHBrw			IoT		
	JSD	TVD	DR	JSD	TVD	DR	JSD	TVD	DR	JSD	TVD	DR	JSD	TVD	DR	JSD	TVD	DR	JSD	TVD	DR
Real	-	-	0.1071	-	-	0.2661	-	-	0.4562	-	-	0.1965	-	-	0.1979	-	-	0.1663	-	-	0.1017
NetShare	0.1269	0.3603	0.0180	0.0338	0.1263	0.0048	0.0445	0.2205	0.2685	0.0261	0.1717	0.0657	0.0155	0.1177	0.0525	0.2481	0.5828	0.2377	0.0111	0.0817	0.0618
Lens	0.0369	0.1886	0.1104	0.0533	0.0927	0.2805	0.0795	0.1312	0.4557	0.0428	0.0855	0.2278	0.0371	0.0817	0.2277	0.0403	0.0750	0.1726	0.0314	0.0994	0.1086

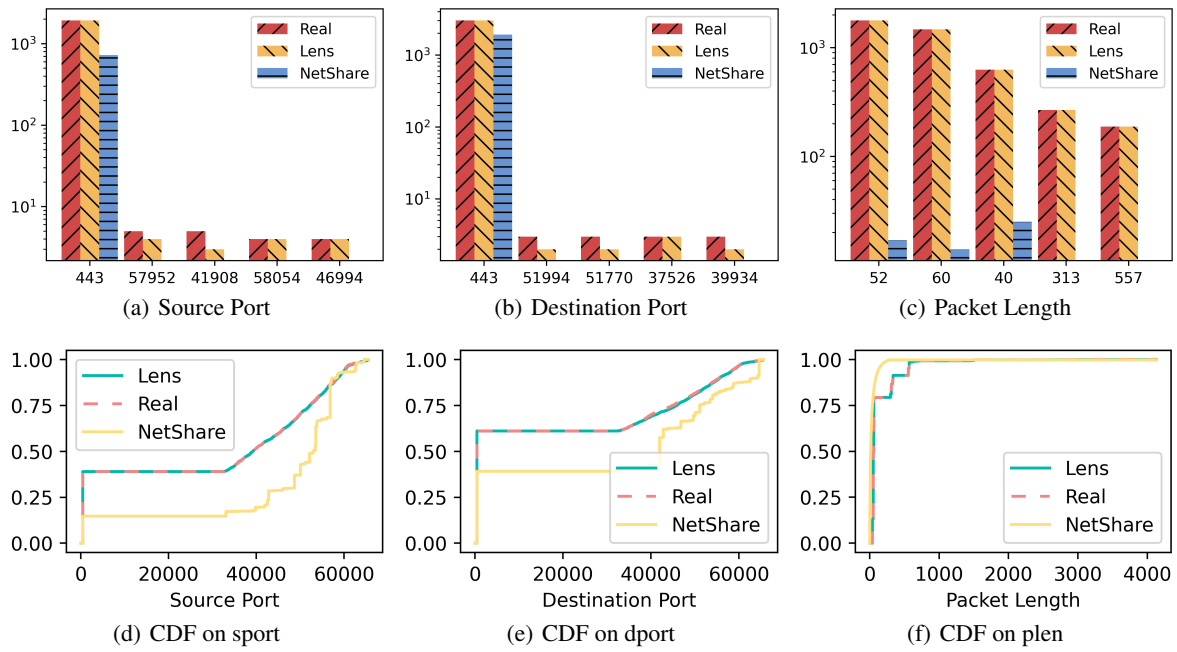

Figure 3: DoHBrw

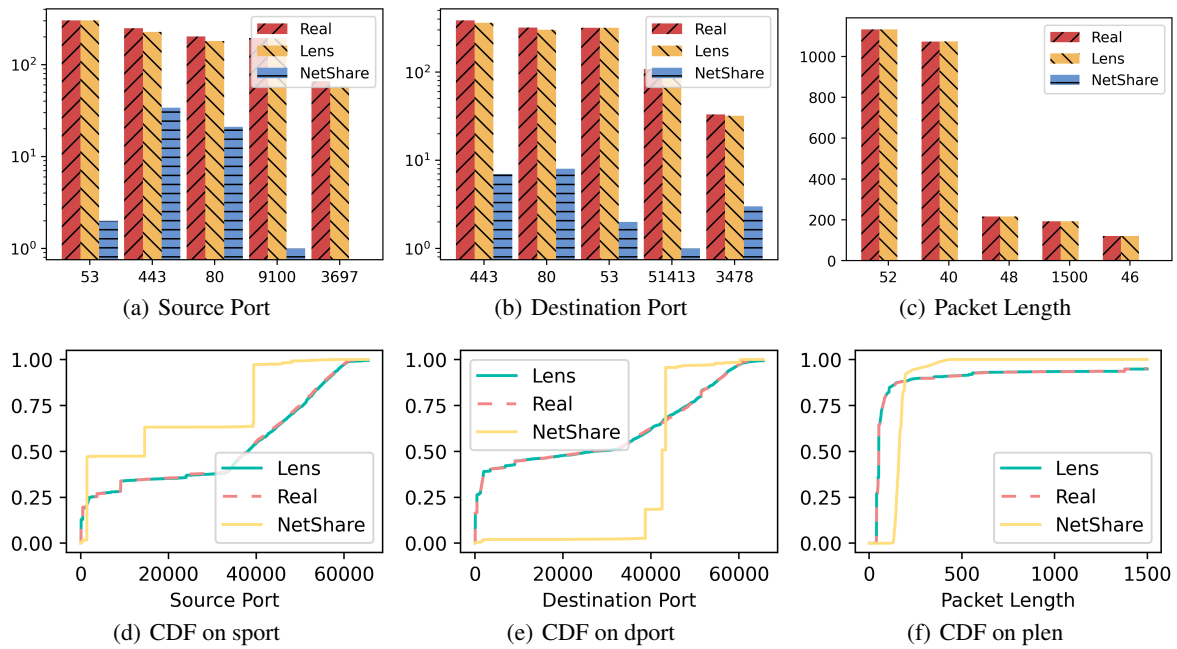

Figure 4: Tor

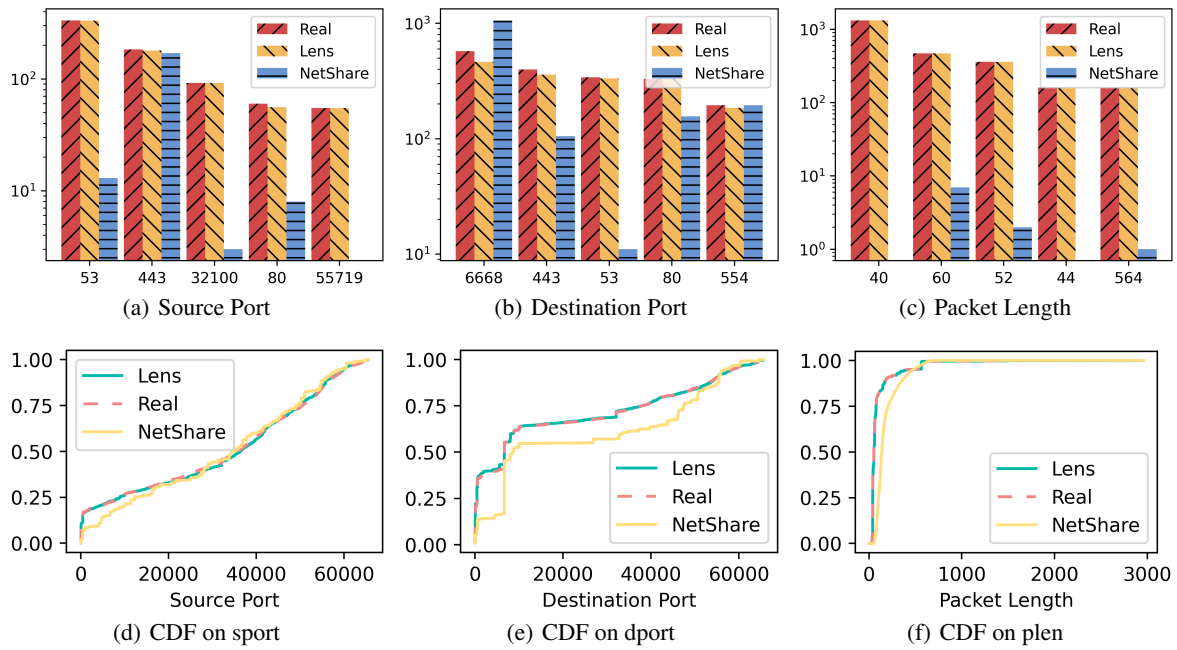

Figure 5: IoT

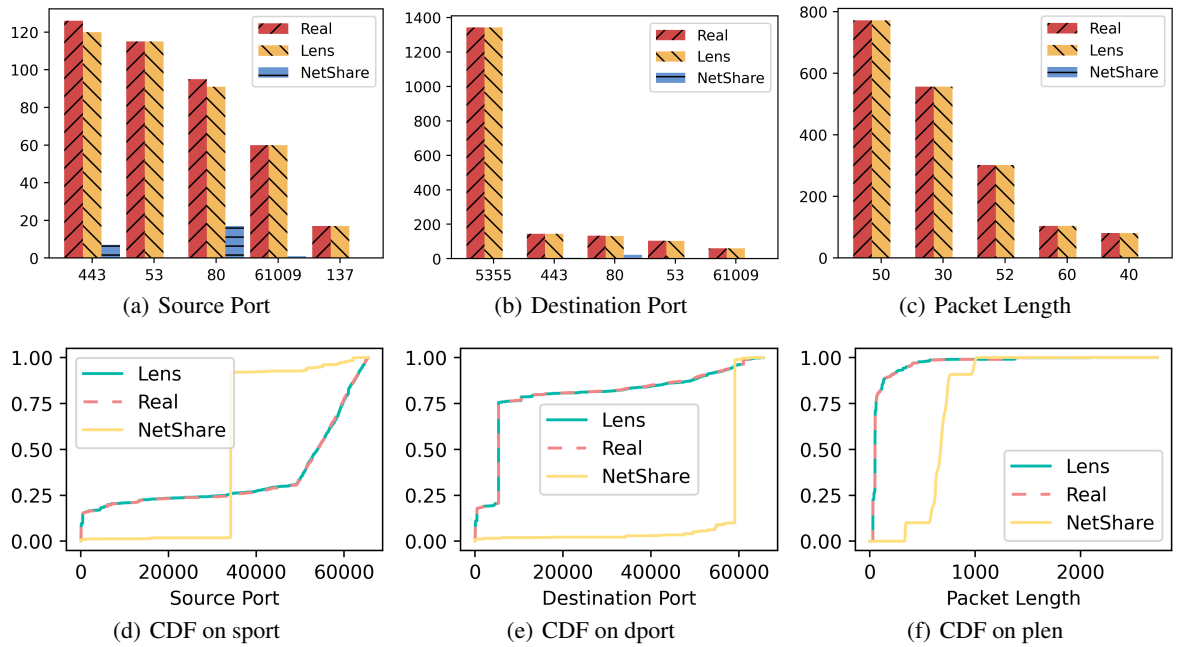

Figure 6: VPN

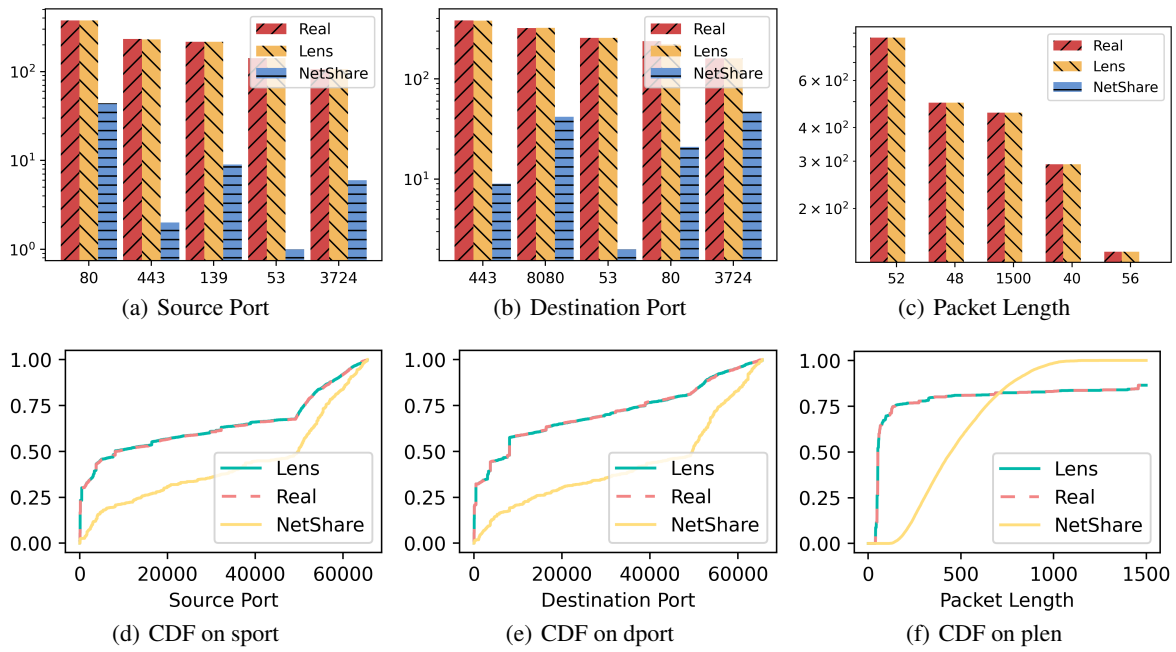

Figure 7: USTC-TFC2016

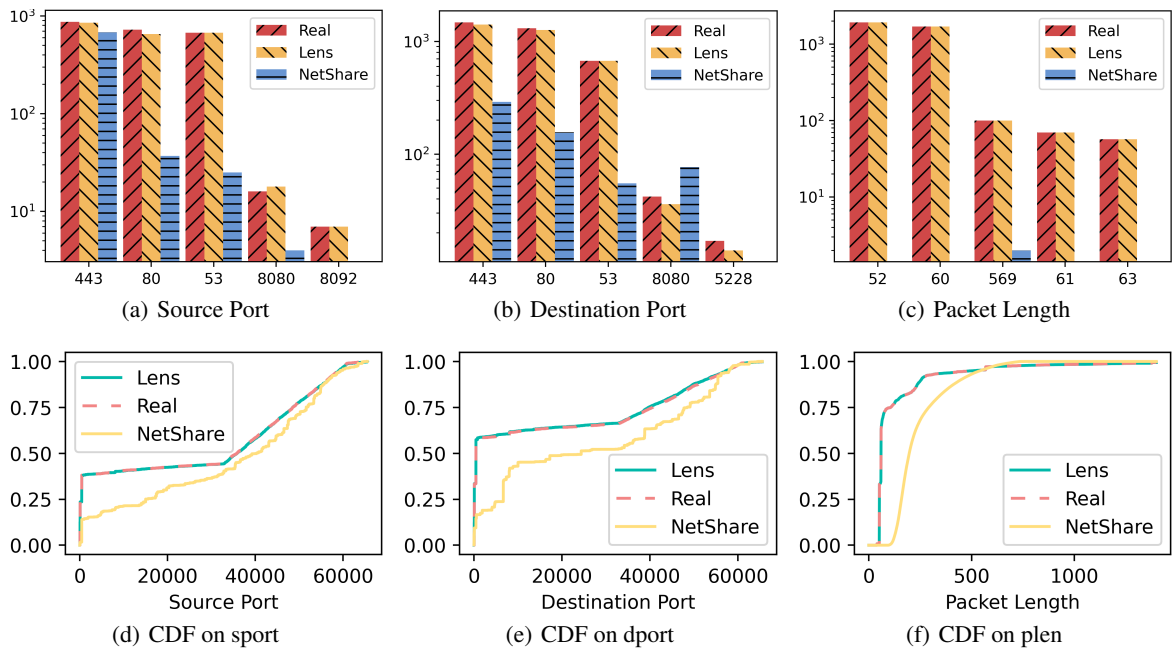

Figure 8: CrossPlatformAndroid

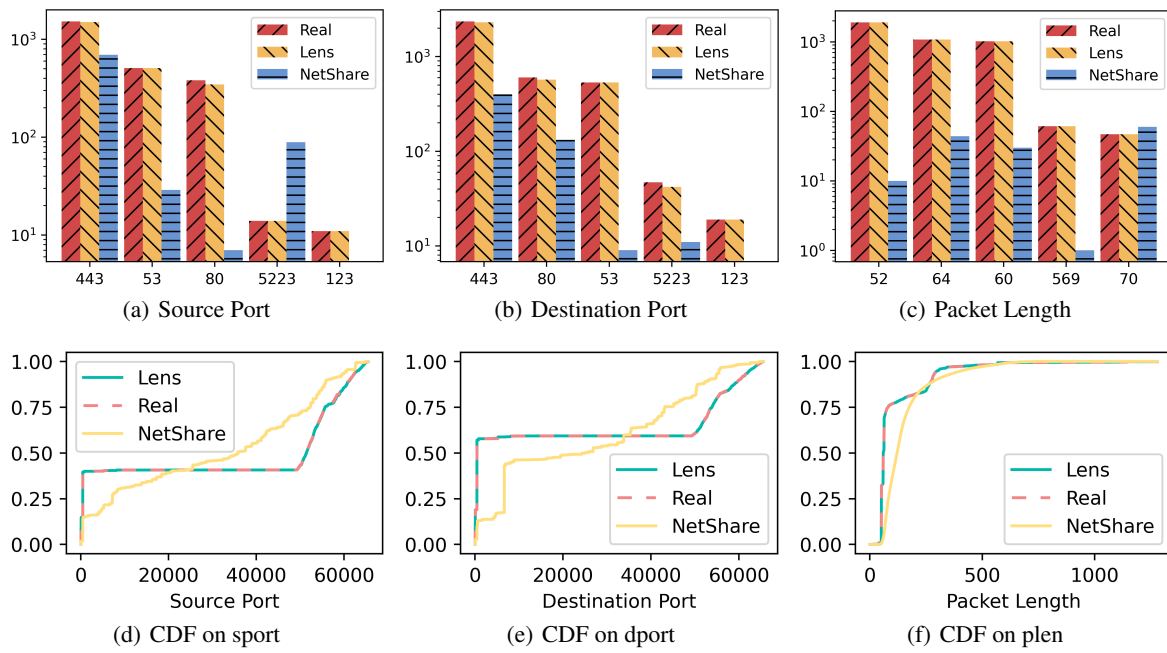

Figure 9: CrossPlatformIOS