

# Correct and Compositional Hardware Generators

Rachit Nigam  
Cornell University  
USA

Ethan Gabizon\*  
Cornell University  
USA

Edmund Lam\*  
Cornell University  
USA

Adrian Sampson  
Cornell University  
USA

## Abstract

Hardware *generators* help designers explore families of concrete designs and their efficiency trade-offs. Both parameterized hardware description languages (HDLs) and higher-level programming models, however, can obstruct composability. Different concrete designs in a family can have dramatically different timing behavior, and high-level hardware generators rarely expose a consistent HDL-level interface. Composition, therefore, is typically only feasible at the level of individual instances: the user generates concrete designs and then composes them, sacrificing the ability to parameterize the combined design.

We design Parafil, a system for correctly composing hardware generators. Parafil builds on Filament, an HDL with strong compile-time guarantees, and lifts those guarantees to generators to prove that all possible instantiations are free of timing bugs. Parafil can integrate with external hardware generators via a novel system of *output parameters* and a framework for invoking generator tools. We conduct experiments with two other generators, FloPoCo and Google’s XLS, and we implement a parameterized FFT generator to show that Parafil ensures correct design space exploration.

## 1 Introduction

Most hardware description languages (HDLs) provide compile-time code generation capabilities [1, 3, 23, 31]. In general, *hardware generators* [13, 26] expose parameters to explore resource and performance trade-offs. However, parameterized design is difficult to get right because each module represents a *family of circuits*, and composing generators together magnifies the challenge. Generators in high-level programming models [7, 12, 16, 22, 28, 34, 42] raise the level of abstraction by compiling computational descriptions to circuits can often provide formal correctness properties [5, 17]. However, such generators still need to interface with parametric HDL code: users generate “leaf modules” using such tools and integrate them using HDLs. Integration in such *heterogeneous* generator systems is even more challenging: users either integrate particular instances generated by the tool, stifling rapid exploration, or write parametric code to integrate generated blocks, which is difficult to get right.

We present Parafil, a language for correct and compositional integration of hardware generators. Parafil addresses the composition and correctness challenges for both parametric HDL programs and external generators. Building upon

Filament [29], a type system for reasoning about timing behaviors, Parafil provides the guarantee that parametric programs do not have bugs introduced by pipelining or resource reuse. Next, Parafil’s parametric abstractions enable correct composition with external generators; users can provide interfaces that abstract over *all possible designs* instantiated by a generator and use Parafil’s type system to guarantee correct composition. The contributions of this paper are:

- §4. Parafil, a parametric HDL that guarantees absence of structural hazards introduced from pipelining and resource reuse for entire families of circuits.
- §5. *Output parameters*, a new parametric abstraction that enables correct composition of all possible designs generated by external generators.
- §7. Parafil gen, a framework for integrating hardware generators. We integrate FloPoCo [11] and Google’s XLS [15] with Parafil using this framework.
- §8. We implement a parameterized, iterative FFT and show that Parafil enables design space exploration. We use Parafil abstractions to integrate FloPoCo-generated modules and implement optimization from Spiral [25].
- §9. We show how Parafil enrich the capabilities of high-level programming models by integrating it with XLS. The resulting system uses XLS to generate pipelined datapaths and Parafil to express resource reuse.

## 2 Motivating Example

We overview the challenges of parametric design by implementing a floating point ALU that performs either multiplication or addition. It uses adders and multipliers generated by FloPoCo [11], an FP core generator for FPGAs, and integrates them in Verilog. FloPoCo generates modules given the computation name, the parameters, and the target frequency. It uses the target frequency to decide how to pipeline the module, which indirectly determines the latency.

Figure 1a shows a Verilog wrapper module that instantiates Gen\_FPAdd and Gen\_FPMul and selects between their output using a multiplexer. The generated modules do not have corresponding Verilog implementations; instead, the user invokes FloPoCo to generate them and links them in at a later point. Since the ALU module is parameterized by the floating point representation, the parameters Exp and Mant must be communicated to FloPoCo.

The aim in using FloPoCo is enabling design space exploration beyond what is offered by the parameters of the ALU: Changing the target frequency parameter in FloPoCo

\*Both authors contributed equally to the paper

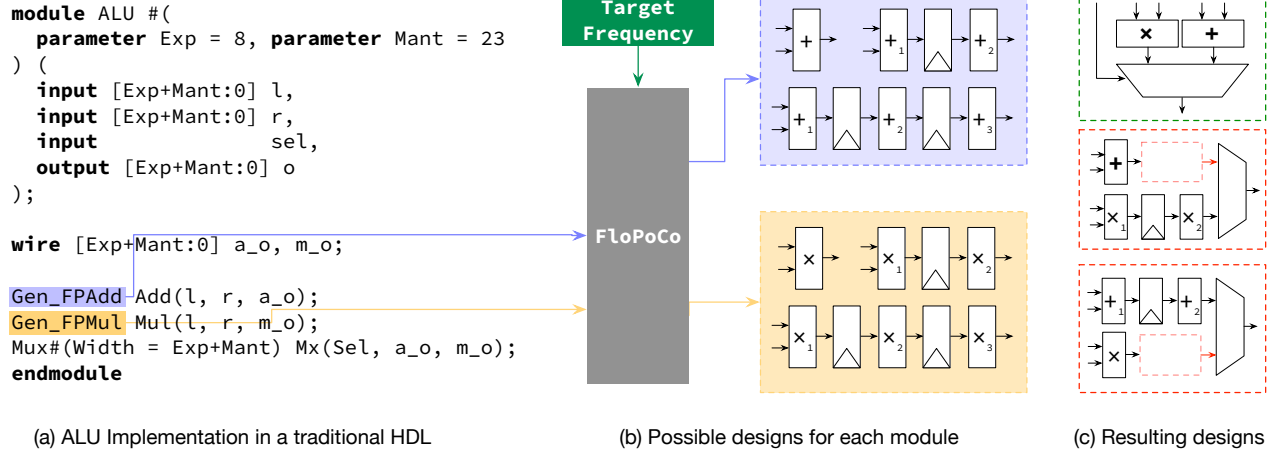

**Figure 1.** A parameterized floating-point ALU implementation that uses FloPoCo-generated modules, `Gen_FPAdd` and `Gen_FPMuL`. For each module, FloPoCo defines a design space with different amounts of pipelining. Most designs in the composed design space are incorrect due to imbalanced pipelines.

changes the pipeline depths, enabling us to trade-off resources for higher frequency. Unfortunately, the Verilog wrapper does not account for the possibility of different latencies. If the adder and multiplier have different latencies, the ALU pipeline will be imbalanced: the two computations will finish at different times. Balancing the pipeline would require instantiating a parametric number of registers based on: (1) which module has a longer latency, and (2) the difference between the two latencies. Unfortunately, the latency information will only be available after FloPoCo has been run. The alternative is to use *latency-insensitive* interfaces, such as ready-valid handshakes, which abstract timing behavior of the module at the cost of extra signals [27] and verification challenges [32, 40]. Furthermore, for designs with input-independent timing behavior, such interfaces are redundant after design-space exploration is completed.

The example highlights the dual challenge of designing parametric modules with correct timing behaviors and integrating them with external generators. Correct parametric design requires that the implementation account for *all possible timing behaviors*. Integrating external generator requires some mechanism to specify an interface to all possible designs generated by the tool. Parafil addresses both problems. First, it uses a type system to reason about and eliminate pipelining and resource sharing bugs. Second, it uses *output parameters* to abstract the interfaces of modules generated by external generators. Together, it guarantees that no matter what instance is generated, either through parameterization with the HDL code or by an external tool, the composed design will be free of a complex class of bugs.

### 3 Background

We overview Filament [29], upon which Parafil builds, by implementing a non-parameterized ALU (Figure 2).

```

1 ext comp Add[W]<'T:1>(..) -> (out: ['T,'T+1] W);
2 ext comp Mux[W]<'T:1>(..) -> (out: ['T,'T+1] W);
3 ext comp MuL[W]<'T:2>(..) -> (out: ['T+2,'T+3] W)
4 comp ALU<'G:1>(
5   l: ['G,'G+1] 32, r: ['G,'G+1] 32,
6   op: ['G,'G+1] 32 -> (out: ['G+2,'G+3] 32) {
7     // Instantiate modules without port connections
8     A := new Add[32]; M := new MuL[32];
9     // Schedule the computations
10    add := A<'G>(l, r); mul := M<'G>(l, r);
11    // Instantiate and invoke multiplexer.
12    mux := new Mux[32]<'G>(op, add.out, mul.out);
13    out = mux.out; }

```

**Figure 2.** A non-parameterized ALU in Filament. Subcomponents are instantiated with parameters (line 8). Component signature (line 4–6) defines event `'G` which is used to schedule computations using *invocations* (line 10). Connections forward values between ports (line 13).

**Components & signatures.** Components encapsulate hardware structure. The signature of ALU (lines 4–6) defines:

- **Ports** specify an *availability interval* and bitwidth.
- **Events:** The signature defines the event `'G` which is used to specify cycle-accurate timing behavior; `'G+3` occurs exactly three cycles after `'G`. Events are of the form  $G + n$  where  $G$  is an event and  $n$  is a concrete number. Timing must be input-independent.
- **Availability intervals** describe the cycles when ports are valid. Inputs express requirements while outputs express guarantees. Availability intervals are half-open:  $['G, 'G+1]$  denotes  $[G, G + 1)$ , i.e., the first cycle.
- **Event delay:** All events have a *delay* to capture pipelining behavior: `'G:1` defines the delay of  $G$  to be 1. The delay is the number of cycles after which the component can handle new inputs (i.e., initiation interval).

- **Parameters:** External components (lines 1–3) specify interfaces to HDL implementations and can be parameterized in Filament. Parameters are not allowed to appear in availability intervals or as delays.

**Instances & invocations.** Filament decouples circuit instantiation from use. In HDLs, circuit instantiation also provides wire connections for the input and output ports. Circuit reuse is expressed by multiplexing different values on these wires. Filament uses *invocations* to *schedule* the computation with an event and pass a particular set of inputs. For example, line 8 instantiates an adder (A) and multiplier (M) and line 9 uses them by scheduling their execution with event 'G and inputs  $\ell$  and  $r$ . By scheduling computations explicitly, Filament's type checker can ensure that the inputs  $\ell$  and  $r$  are valid when the circuits attempt to use them.

Invocations also concisely express reuse and Filament synthesizes simple multiplexing logic to forward the right inputs based on the schedule. Unlike Bluespec [31]—which generates complex scheduling logic to dynamically detect conflicting use—Filament relies on the type system to statically guarantee absence of resource conflicts and generates simple multiplexing logic to forward inputs for different invocations of an instance.

### 3.1 Filament's Compile-Time Reasoning

Filament's type system statically detects bugs arising from pipelining and resource reuse. For example, Figure 2 has a bug: the multiplexer expects the output from the adder and multiplier to be valid in the same cycle, but they have different latencies; The adder is combinational—it returns its output in the same cycle—while the multiplier is sequential—it takes two cycles to perform its computation. This means the multiplexer, also scheduled in the same cycle as the adder, will read an invalid output from multiplier. Filament catches this problem at compile-time:

```
mux := new Mux[32]<'G>(op, add.out mul.out);
      Signal available in interval ['G+2, 'G+3]
      but required in ['G, 'G+1]
```

We can add registers (Reg) to delay the adder's output by two cycles and schedule the multiplexer when the multiplier's output is valid:

```
add := A<'G>(l, r);
r0 := new Reg[32]<'G>(add.out);
r1 := new Reg[32]<'G+1>(r0.out);
mux := new Mux[32]<'G+2>(op, r1.out, mul.out);
```

**Pipelining.** Event delays express pipelining behavior. The ALU defines event 'G:1 with delay 1 which means we expect the component to accept new inputs every cycle. However, it uses the Mul component which has an event 'T:2 with delay 2; the multiplier accepts new inputs every other cycle. This is a bug: if the ALU accepts new inputs every cycle,

the multiplier drop every other input. Filament catches this problem at compile-time:

```
comp Mult[W]<'G:2> Module accepts inputs every 2 cycles
comp ALU<'G:1> Module accepts inputs every cycle
  mul := M<'G>(left, right) Cannot safely pipeline
```

To fix this, the ALU must instead use a fully-pipelined multiplier, i.e., with a delay of 1.

### 3.2 Resource Sharing

Resource sharing can create two kinds of bugs: *Intra-iteration conflicts*—conflicts that occur when processing one set of inputs—and *inter-iteration conflicts*—when processing multiple sets of inputs in a pipelined manner. We show how Filament detects two kinds of bugs using the following program:

```
comp Sq2<'G:1>(a:.., b:..) -> (o0:.., o1:..) {
  M := new Mul[32];
  ma := M<'G>(a, a); o0 = ma.out // first use
  mb := M<'G>(b, b); o1 = mb.out // second use
```

The module computes the square of two inputs using the same multiplier.

**Intra-iteration conflicts.** The first problem is that the design attempts to use M twice in the same cycle by scheduling both invocations using event 'G:

```
M := new Mul[32]
      delay requires uses to be 2 cycles apart
ma := M<'G>(a, a); first use at 'G
mb := M<'G>(b, b); second use at 'G
```

Since the delay of Mul's event is 2, we need to wait two cycles before scheduling the invocation mb.

```
mb := M<'G+2>(b, b);
```

**Inter-iteration conflicts.** The second problem is that Sq2 states it can accept new inputs every cycle:

```
comp Sq2<'G:1>(a:.., b:..) -> (o0:.., o1:..) {
      delay allows new inputs every cycle
      but instance used for 4 cycles
ma := M<'G>(a, a); first use begins at 'G
mb := M<'G+2>(b, b); last use ends at 'G+4
```

However, when processing one set of inputs, the multiplier is used for 4 cycles; it computes  $a^2$  in the first two cycles and  $b^2$  in the next two. This means that Sq2 cannot pass inputs for at least 4 cycles. We can fix this by changing the delay of 'G:

```
comp Sq2<'G:4>(a:.., b:..) -> (o0:.., o1:..) {
  M := new Mult[32];
  ma := M<'G>(a, a); o0 = ma.out;
  mb := M<'G+2>(b, b); o1 = mb.out; }
```

## 4 The Parafil Language

Filament's type system reasons about the correctness of particular instances. Parafil extends Filament with several

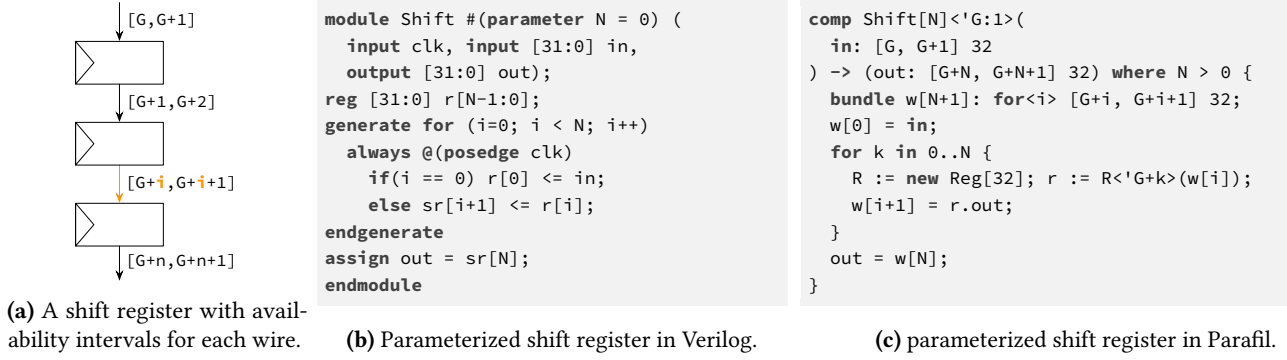

**Figure 3.** Shift register implementations in Verilog and Parafil. Parafil implementation provides a timeline type to each value of the bundle which allows it enforce Filament’s type safety guarantee.

new operators to support parameterized design and extends the type system to be able to statically reason about correctness of *all possible instances*.

#### 4.1 Parameters

Parafil adds parameter expressions to user-level Filament components. Any location that previously contained a concrete number can now instead use a parameter expression including availability intervals and delays. This allows Parafil to express parameter-dependent timing, pipelining, and resource reuse. Like Filament, Parafil is limited to expressing design with input-independent timing behavior.

#### 4.2 Parametric Signatures

A shift register (Figure 3) is a sequence of registers that delay a signal by  $N$  cycles where  $N$  is an input parameter. The Parafil interface (Figure 3c) expresses this as follows:

```

comp Shift[N]<'G:1>(in: ['G, 'G+1] 32) -> (
  out: ['G+N, 'G+N+1] 32) where N > 0 { ... }

```

The signature introduces the parameter  $N$  and uses it in the availability interval for the out port. It also describes the timing behavior of the module precisely: the shift register delays the input signal by  $N$  cycles and can process new inputs every cycle (since  $'G:1$  specifies the delay of  $'G$  as 1). In contrast, the signature in the Verilog implementation (Figure 3b) only captures the bitwidths of the inputs and outputs. The Parafil signature also uses a *where* clause to ensure that  $N > 0$ . This constraint is checked at compile-time: the module that instantiates `Shift` must statically prove that the argument, which can itself be a parameter expression, is greater than 0. The implementation of `Shift` assumes that this fact is true and uses it to discharge its own proofs.

#### 4.3 Bundles

Bundles are multi-dimensional arrays where the availability interval a particular index *depends* upon the index.

```

bundle w[N+1]: for<i> ['G+i, 'G+i+1] 32;

```

The bundle  $w$  has  $N + 1$  elements and the  $i^{\text{th}}$  element has the availability  $[G + i, G + i + 1]$ ;  $w[0]$  has availability  $[G, G + 1]$ ,  $w[2]$  has availability  $[G + 2, G + 3]$  and so on. Availability intervals for bundles are therefore a form of dependent types.

Bundles can be accessed using array-access syntax ( $w[0]$ ) to get a particular index, or range-access ( $w[4..N]$ ) to get a slice. Both syntaxes can be used on the left side of an assignment and at use locations.

For our shift register implementation, we use a bundle to track the availability of the output from each register. Figure 3a visualizes this: the input is available in the first cycle, the next wire holds a value in the second cycle, and so on. Bundles also allow programs to forward-declare values and aid resource reuse in parametric programs (§4.5).

#### 4.4 Compile-time Constructs

Parafil adds several compile-time constructs to Filament.

**Loops.** The implementation of the shift register instantiates  $N$  registers using a for loop:

```

for i in 0..N {
  R := new Reg[32]; r := R<'G+i>(w[i]);
  w[i+1] = r.out }

```

The loop body instantiates and invokes a register at time  $G+i$ , which is the  $i^{\text{th}}$  cycle of the shift register’s execution, uses the input  $w[i]$ , and connects the output of the register to  $w[i+1]$ .

Remaining constructs have standard semantics:

- `if-else`: Branch on parameter expressions.
- `let`-bindings: Name parameter expressions.
- `assume`: Asserted *trusted* facts that the type checker’s SMT backend cannot automatically prove.
- Recursive instantiation to express modules such as reduction trees, which naturally decompose problems into smaller versions of themselves.

<pre>comp FPMult[E,W]&lt;'G:1&gt; ( l: ['G,'G+1] W,   r: ['G,'G+1] W ) -&gt; (   o: ['G+3,'G+4] W)</pre>	<pre>comp FPMult[E,W]&lt;'G:1&gt; ( l: ['G,'G+1] W,   r: ['G,'G+1] W ) -&gt; (o: ['G+L, 'G+L+1] W ) with { some L; }</pre>
(a) Concrete interface.	(b) Abstract interface.

**Figure 4.** Parafil’s output parameters abstract details such as latency and the type system ensure correct composition.

#### 4.5 Reusing Instances

We lift Filament’s reasoning about inter- and intra-iteration resource conflicts to Parafil. Filament’s implementation for these checks walks over the entire component, collects all invocations associated with an instance, and computes the appropriate constraints. This approach is infeasible in Parafil since a parametric program can *generate* an unknown number of invocations for an instance. We redesign the check to be local using *instance availability intervals*:

```
A := new Add[32] in ['G, 'G+K];
```

Each instance specifies an availability interval which denotes when the instance can be invoked. Given this information, the Parafil type checker ensures:

- For each invocation’s scheduling event  $E$  with delay  $d$ ,  $[E, E + d]$  is contained in the availability interval.
- Each pair of invocations is separated by at least  $d$ .

Finally, the type-checker ensures that the *delay* of the containing component’s event is greater than the length of the instance availability interval. This is because if an instance is used for  $K$  cycles, then the component cannot process new inputs for at least  $K$  cycles. We include a simple pass to infer instance availability intervals for non-parametric programs for backward compatibility with Filament; extending this inference to parametric programs is future work.

## 5 Bottom-up parameterization

Input parameters, such as the bitwidth of an adder, allows the instantiating module to control how a child module is generated, enabling top-down parameterization. Parafil’s *output parameters*, enables *bottom-up* parameterization: during elaboration (§6.3), a child module can return parameters which influence the elaboration of other modules in the parent. Parafil’s key insight is that output parameters correspond to *existential types*: they hide the implementation details of a module and force a parent to be abstract with respect to those details. Using this, Parafil seamlessly incorporates output parameters into its type system and provides strong composition guarantees.

### 5.1 Interfaces for Hardware Generators

Interfaces for modules generated by FloPoCo can be captured using input parameters: the bitwidth of the exponent

and the mantissa. However, the target frequency configuration, which decides the pipelining and latency of the resulting module, is not easily encapsulated. Figure 4a shows the current of integrating such generated blocks: users pick a specific latency and write HDL glue code with respect to it.

### 5.2 Stable Interfaces for Generator Composition

Figure 4b shows the Parafil approach: using an output parameter  $L$  (defined using the syntax `some L`), the interface abstracts the latency of the module. The output is available  $L$  cycles after the input is provided but gives no information about its actual value, which is decided by FloPoCo.

In order to schedule computations that make use of outputs from such modules, programs need

```
M := new FPMult[8, 32];
m := M<'G>(a, b);
A := new Add[8, 32];
a := A<'G+M::L>(m.o, c)
```

to use the output parameter access syntax (`M::L`). The Parafil program computes  $a \times b + c$  using the `FPMult` module. The invocation for the adder, `A`, is scheduled at `'G+M::L` which depends on the value of `M::L`. Parafil’s type-checker treats `M::L` as abstract and proves that the resulting computation will be correct for any value of `M::L`.

A common pattern when using output parameters is *threading them up*. For example, the module with the computation itself has an abstract latency which depends upon the value of `M::L`. Parafil components specify this using output parameter assignments:

```
comp Compute<'G:1>(…) with { some L; } {
  …; L <- M::L } // Output param binding
```

Since the adder is combinational, the abstract latency  $L$  for the component is  $M::L + \theta$ . However, this dependency between the two latencies is not exposed in the signature; to a user of this component, the latency  $L$  is completely abstract. This abstraction can be used for specializing the timing behavior of an implementation based on input parameters:

```
comp SmartMul[W]<'G:1>(…) with { some L } {
  if W < 4 { M := CombMult[W]; ..; L <- 0; }
  else if W < 9 { M := FastMult[W]; ..; L <- 2; }
  else { M := SlowMult[W]; ..; L <- 4; }
```

## 6 The Parafil Compiler

The Parafil compiler type-checks parametric programs and eliminates all compile-time abstractions used by the Parafil compiler to generate an unparameterized Filament program.

### 6.1 Type Checking

The Parafil compiler lifts Filament’s guarantees to parameterized programs through *symbolic reasoning*. It encodes Filament’s typing constraints [30] as an SMT formula and discharges them using a solver.

Encoding is defined recursively over Parafil statements. It takes a Parafil program ( $C_p$ ), the current *path condition* ( $pc$ ),

and generates an SMT formulas ( $\mathbb{P}$ ):

$$\text{encode} : C_p \rightarrow \text{pc} \rightarrow \mathbb{P}$$

**Path conditions.** Path conditions define the current set of known facts at a program point and are updated when entering conditionals and loops:

$$\begin{aligned} \text{encode}(\text{if } c \{ t \} \text{ else } \{ f \}, \text{pc}) &\triangleq \\ \text{encode}(t, \text{pc} \wedge c) \wedge \text{encode}(f, \text{pc} \wedge \neg c) & \end{aligned}$$

**Constraints.** During type checking, the encoding function generates assertions for each program statement.

$$\begin{aligned} \text{encode}(b_0[0..N] = b_1[4..P], \text{pc}) &\triangleq \\ \text{pc} \implies N = (P - 4) \wedge \text{live}(b_0, 0, N) \subseteq \text{live}(b_1, 4, P) & \end{aligned}$$

For example, for a bundle connection, the constraints to ensure that (1) bundle sizes match, and (2) that they have the correct availability intervals. Parameters are treated as unbounded integers which ensures that Parafil’s guarantees extend to all possible designs. Finally, constraints are guarded by the path condition. Once constructed, the negation of the query is asserted and if the SMT solver returns UNSAT, the original query is valid.

**Output parameters.** Within the defining component, constraints on output parameters are treated as assertions and each parameter assignment must satisfy them. When a component is instantiated, constraints on the output parameters are treated as *assumptions* and the parent module uses them to discharge proofs.

## 6.2 Partial Evaluation

Compiling Parafil components to Filament requires partially evaluating them with respect to parameters. The partial evaluator: (1) substitutes concrete values for parameters, (2) evaluates compile-time control flow such as `for` and `if` with the resulting concrete expressions, (3) returns bindings for output parameters computed during evaluation. The result of evaluation is a Filament component and concrete bindings for output parameters; all input parameters, control-flow, and recursion is eliminated.

The evaluator takes a Parafil program ( $C_p$ ) a binding of parameters ( $s : \text{Var} \rightarrow \mathbb{N}$ ) and returns a concrete Filament program ( $C_f$ ) and bindings for the output parameters:

$$\text{eval} : C_p \rightarrow s \rightarrow (C_f, s)$$

**Parameter expressions.** Evaluating parameter expressions requires *substitution* which is recursively defined on the grammar of parameter expressions:

$$\begin{aligned} \text{subst} : p \rightarrow s \rightarrow \mathbb{N} \\ \text{subst}(x, s) &= s(x) \\ \text{subst}(e_1 \text{ op } e_2) &= \text{apply}(\text{op}, \text{subst}(e_1, s), \text{subst}(e_2, s)) \\ \text{subst}(f(e_1, \dots, e_n)) &= \text{apply}(f, \text{subst}(e_1, s), \dots, \text{subst}(e_n, s)) \end{aligned}$$

The *apply* evaluates functions and operations using concrete values. After substitution, all parameter expressions are reduced to concrete values.

**Control flow.** Control flow operators are given standard semantics using a recursive definition of *eval*:

$$\begin{aligned} \text{eval}(\text{if } e \{ t \} \text{ else } \{ f \}, s) &\triangleq \\ \text{if } \text{subst}(e, s) \text{ then } \text{eval}(t, s) \text{ else } \text{eval}(f, s) & \end{aligned}$$

**Output parameter bindings.** Parameter assignments update the output bindings:

$$\text{eval}(p \leftarrow e, s) \triangleq \text{empty}, \{p \mapsto \text{subst}(e, s)\}$$

The evaluator additionally ensures that all output parameters have exactly one assignment.

## 6.3 Elaboration

Figure 5 shows the process of elaboration for component `MuLAdd` that computes  $l \times r + c$ . The inputs ( $l, r, c$ ) are provided in the first cycle and the output is available on cycle  $T$ , which is abstracted using an output parameter. This is because the implementation uses a multiplier component with an abstract latency  $L$ . The adder is scheduled using the multiplier’s output parameter  $M : L$  and we use a shift register to delay the input  $c$ .

The process of compilation, or *elaboration*, start with `MuLAdd` and recursively expands each instance. In Figure 5, the pass first encounters the instance `MuL[32]` and partially evaluates the definition of `MuL` with the binding  $\{W \mapsto 32\}$  (Figure 5 center) to return a new, unparameterized Filament component `MuL_32` along with the binding  $\{M : L \mapsto 3\}$ . This binding for  $M : L$  added to `MuLAdd`’s binding. The pass then evaluates `Shift[32, M : L]` using the concrete value for  $M : L$  and calling *eval* again. The resulting component (Figure 5 right) does not have any parameters and is a valid Filament program.

**External components.** External component and cannot be specialized by Parafil’s partial evaluator; their definition exists only in Verilog and Parafil only has access to their interface. The elaboration pass substitutes concrete values for all parameters to such modules and passes them to the Filament compiler which already knows how to handle them.

**Order of evaluation.** Since components can define instances in any order, the elaboration pass first topologically sorts the instance list based on output parameter definitions and uses. If no topological sort exists, then component is invalid and cannot be elaborated.

## 6.4 Bundle Elimination

After elaboration, all Parafil programs have explicit assignments to bundle locations:

```
comp Foo<'G:1>(in[2]: for<i> ['G+i, 'G+i+1] 32) {
  bundle A[2]: for<i> ['G, G+1] 32;
```

```

comp MulAdd<'G:1>(
  l: ['G, 'G+1] 32, r: ..., c: ...
) -> (
  o: ['G+T, 'G+T+1] 32
) with { some T } {
  M := new Mul[32]; m := M<'G>(l, r);
  sh := new Shift[32, M::L]<'G>(c);
  add := new Add<'G+M::L>(m.out, sh.out);
  out = add.out;
  T := M::L;
}

eval[
  comp Mul[W]<'G:1>(…)
  with { some L },
  {W→32}
] = Mul_32, {L→3}

eval[
  comp Shift[W,D]<'G:1>(…),
  {W→32, D→3}
] = Shift_32_3

comp MulAdd<'G:1>(
  l: ['G, 'G+1] 32, r: ..., c: ...
) -> (
  o: ['G+3, 'G+4] 32
) {
  M := new Mul_32<'G>(l, r);
  sh := new Shift_32_3<'G>(c);
  add := new Add<'G+3>(
    m.out, sh.out);
  out = add.out;
}

```

**Figure 5.** Parafil’s elaboration pass compiles parametric programs into Filament programs. After elaboration, the Filament compiler’s backend lowers the program to synthesizable hardware.

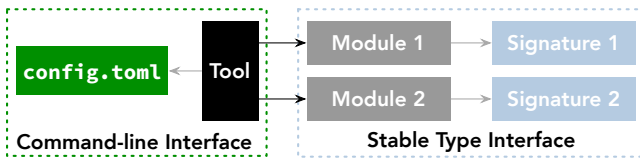

**Figure 6.** The Parafil gen framework. Tools define stable interfaces for the modules, used by the type checker, and a command-line interface, used by the elaboration pass.

```

comp FPExp[E, M]<'G:1>(
  X: ['G, 'G+1] W,
  Y: ['G, 'G+1] W,
) -> (
  R: ['G+L, 'G+L+1] W
) with {
  let W = E+M+3;
  some L;
}

path = "flopoco"
# Module definition
[modules.FPExp]
name = "FPExp"
parameters = ["E", "M"]
cli = "FPExp_{M}_{E}"
name = "FPE${E}_{M}"
# Extract output
outputs.L = "depth"

```

(a) Type signature.

(b) Command-line interface.

```
A[0] = in[0]; out = A[0]; }
```

Bundle elimination inlines writes to a particular index into all of its uses. For bundles used in the signature, it instantiates explicit ports:

```

comp Foo<'G:1>(in0: ['G, 'G+1] 32,
  in1: ['G+1, 'G+2] 32) -> (...) { out = in0 }

```

## 7 Composing External Generators

Parafil provides an in-language mechanism to compose designs generated by external generators. This framework, called Parafil gen, allows black box tools to define *stable interfaces* for generate-able modules and a command-line interface to invoke the tool to generate particular instances. The signatures are used by the type checker (§6.1) to ensure correct composition with any generateable instance while the command-line interface is used by the elaboration pass (§6.3) to generate instances. This decoupling between checking and generation allows users to prove that a design is correctly composed once and explore the design space repeatedly.

### 7.1 Type Checking

Type signatures for modules generated by tools must account for all possible implementations. Figure 7a shows the interface for the FPExp module. Input parameters configure the floating-point representation while the output parameter abstracts the latency of the design. Using this component in Parafil is seamless: users instantiate the component like any

**Figure 7.** Interface for the FPExp module generated by FloPoCo. The type signature uses an output parameter to abstract over the latency. The configuration file describes how to invoke the tool and extract an output parameter value.

other and the type checker ensures that the composition is correct using the provided interface.

### 7.2 Elaboration

The elaboration pass is responsible for transforming a parameterized Parafil program into an unparameterized Filament program. For components generated by external generators, elaboration needs a mechanism to invoke the tool and generate a Verilog file. Parafil gen uses *tool interfaces* which specifies the information needed to interface with a generator through a command-line interface. Figure 7b overviews the interface for the FPExp module:

- **Command-line interface.** The `cli` string describes how to invoke the FloPoCo binary to generate an FPExp module. The template string uses interpolation to pass parameters as command-line arguments.
- **Name generation.** The `name` string describes how the tool generates the name of the final Verilog module given a set of parameters.
- **Bindings for output parameters.** The output dictionary maps output parameters to strings. Given `outputs.L = "depth"`, Parafil will execute the tool and will look for the line `depth = <n>` in the standard output stream, setting the binding of `L` to `n`.

**Generating an external definition.** After executing the tool, Parafil has the bindings for output parameters and the name and path to the Verilog module. To generate an unparameterized Filament wrapper, it partially evaluates the signature of module (Figure 7a). For example, if the elaboration for `FPExp[16,4]` generates the binding  $\{L \mapsto 3\}$ , the final Filament signature will be:

```
ext comp FPE16_4<'G:1>(
  clk: 1, X: ['G, 'G+1] 23, Y: ['G, 'G+1] 23
) -> (R: ['G+3, 'G+4] 23);
```

## 8 parameterized FFT

Fast Fourier transforms (FFTs) are widely-used signal processing algorithms. Hardware generators for FFTs are widely studied [25, 26] because of the plethora of use cases and many implementation choices: radix size, circuit reuse, and the dataflow [10, 33]. We implement several FFT modules using Parafil:

- A Parafil implementation with parametric reuse.
- A second Parafil implementation that uses FloPoCo [11] to generate floating-point modules.
- An implementation that uses XLS [15] to generate butterfly modules and reuses them in Parafil code.

### 8.1 FFT Building Blocks

We use the Pease dataflow [33] which provides a regular structure for both the butterfly and permutation stages. We design an *iterative* implementation that shares subcircuits between stages and a *streaming* implementation that provides higher throughput at the cost of higher resource usage. Our implementation uses Parafil’s output parameters (§5) to abstract modules’ latencies, which lets us seamlessly replace their implementations.

Given  $N$  complex numbers as inputs, the Pease dataflow applies a bit-reversal followed by a series of stages, each consisting of  $N/2$  parallel butterflies. It then permutes the output from each stage using the stride permutation to produce the next stage’s input.

**Bit reversal permutation.** The Pease FFT requires the inputs to be bit-reversed before they are passed into the first butterfly stage. Since bit-reversal is a simple operation, the component (Figure 8c) has a combinational implementation.

**Butterfly.** The butterfly component, given complex inputs  $a$ ,  $b$  and the twiddle factor  $\omega$ , computes:

$$(a, b, \omega) \mapsto (a + b\omega, a - b\omega)$$

Figure 8a shows the Parafil signature of the butterfly module. Output parameters model the latency ( $L$ ) and initiation interval ( $II$ ), the number of cycles before the module can start processing new inputs. This lets us transparently swap out combinational, pipelined, or externally generated implementations of the butterfly.

**Stride permutation.** The stride permutation stage connects the outputs from one butterfly stage to the inputs of the next. The computation is:

$$out(i) = \begin{cases} in(\frac{i}{2}) & i \bmod 2 = 0 \\ in(\frac{i-1+N}{2}) & \text{otherwise} \end{cases}$$

This permutation is static, so our implementation (Figure 8b) uses bundles to combinationally rewire inputs to outputs.

### 8.2 Iterative FFT

Figure 9 overviews the parameterized iterative FFT. The bit-reversal stage transforms the inputs and passes it to the butterflies, which in turn forward their output to the permutation. The permutation component then sends the inputs back to the butterflies for the next stage. The design uses exactly one bit-reversal and one permutation component.

```
comp IterFFT[N, B=N/2]<'G:L>(
  in0[N][2]: ['G, 'G+1] 32 -> (
    out[N][2]: ['G+L, 'G+L+1] 32
  ) with { some L where L > 0 }
```

The design is parameterized by the number of inputs ( $N$ ) and the number of butterfly components ( $B$ ), with the default being  $N/2$  to allow fully parallel computation for a stage of the FFT. If fewer butterflies are provided, the FFT component reuses them over time and instantiates registers to store the output for a stage till the output from all butterflies is computed. Finally, the latency and throughput of the iterative FFT is abstracted using the output parameter ( $L$ ). This is because our implementation uses butterfly components with abstract latencies (Figure 8a) and that requires threading the abstract latency through (§5.2).

**FloPoCo integration.** The Parafil FFT implements the complex math using a 5 stage floating-point multiplier and a 5 stage floating-point adder. In order to explore area-throughput trade-offs, we abstract the interface for the floating-point modules and use FloPoCo [11] to generate implementations targeting different frequencies. Because of the gen framework, using FloPoCo generated components is seamless:

```
ac := new FPMult[E, M]<'G>(in{0}, twiddle{0});
bd := new FPMult[E, M]<'G>(in{0}, twiddle{1});
re := new FPSub[E, M]<'G+FM::L>(ac.R, bd.R);
```

The `FPMult` and `FPSub` are defined by FloPoCo and are automatically generated during elaboration (§7.2).

**Evaluation.** Our evaluation of the iterative FFT modules seeks to answer two questions:

1. Does the parameterized Parafil design offer meaningful area-throughput trade-offs?
2. Does using FloPoCo modules enable us to explore a larger space of trade-offs?

Figure 10 summarizes our results. We generate Parafil point by choosing the number of butterflies to be  $\{1, 2, 4, 8\}$  and the FloPoCo-Parafil points by additionally sweeping the target



```

comp Butterfly[W, E]<'G: II>(
  inp0[2]: ['G, 'G+II] W,
  inp1[2]: ['G, 'G+II] W,
  twid[2]: ['G, 'G+II] W
) -> (
  out0[2]: ['G+L, 'G+L+1] W,
  out1[2]: ['G+L, 'G+L+1] W
) with {
  some II, L where L >= II > 0;
}
    
```

(a) Signature of the butterfly component with abstract latency and initiation interval.

```

comp Perm[Stages, W]<'G: 1>(
  inp[P][2]: ['G, 'G+1] W
) -> (
  out[P][2]: ['G, 'G+1] W
) with { let P = pow2(Stages) }
where Stages > 0, W > 0 {
for i in 0..P/2 {
  out{i}{..} = inp{i*2}{..};
  out{i+P/2}{..} =
    inp{i*2+1}{..}; } }
    
```

(b) Permutation component implemented using bundles.

```

comp BitRev[Stages, W]<'G: 1>(
  inp[P][2]: ['G, 'G+1] W
) -> (
  out[P][2]: ['G, 'G+1] W
) with { let P = pow2(Stages) }
where Stages > 0, W > 0 {
for j in 0..P {
  let br = bit_rev(j, Stages);
  out{j}{0..2} = inp{br}{0..2};
} }
    
```

(c) Bit reversal implemented using the bit\_rev parameter function.

**Figure 8.** Building blocks for the Pease FFT. Complex numbers are represented as two element bundles.

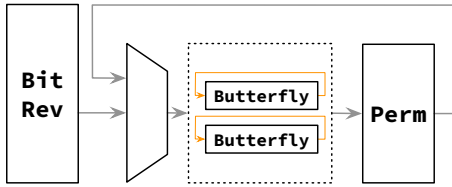

**Figure 9.** Iterative FFT that reuses butterfly components within and across stages.

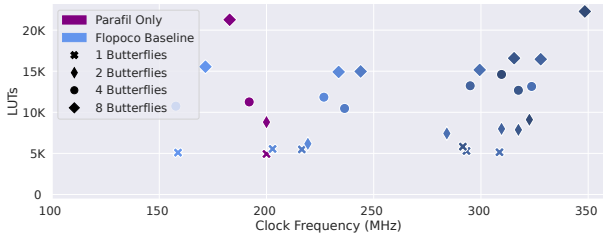

(a) Maximum frequency vs LUT usage.

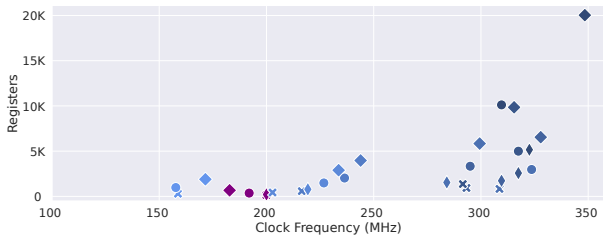

(b) Maximum frequency vs. register usage.

**Figure 10.** Iterative FFT. Darker points have deeper pipelines and shapes represent different amounts of reuse.

frequency input for FloPoCo from 300–900MHz. The graphs report post place-and-route resource usage using Vivado 2020.2 against the maximum frequency for all points that can meet timing at at least 100MHz. The designs generated by the parameterized Parafil implementation offer area-frequency trade-off: reducing reuse improves frequency at the cost of

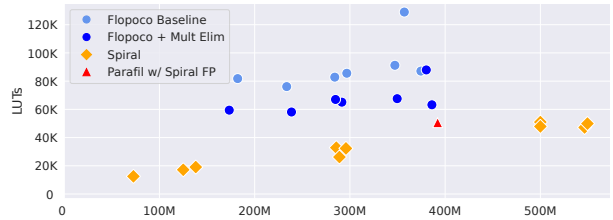

(a) Latency vs LUT usage.

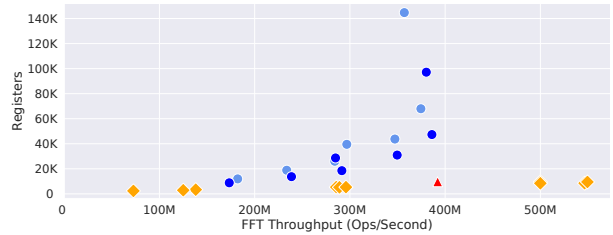

(b) Latency vs. register usage.

**Figure 11.** Streaming FFTs in Parafil and Spiral compared to optimized designs.

resources. The FloPoCo-Parafil expresses a larger design space: darker points have a higher target frequency input and are more pipelined. These designs can achieve a wider range of frequencies than the pure Parafil implementation.

### 8.3 Streaming FFT

We implement a streaming FFT as a special case of the iterative FFT that instantiates separate stages and does not reuse butterflies. We integrate FloPoCo and compare the generated design to FFTs generated by Spiral [25].

**Initial comparison.** Figure 11 reports usage against throughput, computed as ratio of frequency over initiation interval. Throughput is an application-level metric that allows us to

compare different FFT implementation. Between FloPoCo-Parafil designs and Spiral, the latter does strictly better because Spiral implements application-specific FFT optimizations that our implementation does not yet replicate.

**Eliminating unit multiplies.** Spiral opportunistically eliminate floating-point multiplier when the twiddle factors are constants (1 or  $-i$ ). This changes the latency of butterfly modules in some stages. Parafil’s output parameters abstract the latency and make it easy to express this optimization:

```
if is_one(Twid) { // is 1
  .. // Forward inputs
  L <- 0; // Purely combinational
} else if is_i(Twid) { // is -i?
  .. // Negate and forward inputs
  L <- 0; // Purely combinational
} else { // floating-point multiplier needed
  M := new FPMul; ...; L <- M::L; // Multi-cycle
}
```

The output parameter  $L$  reflects the component’s conditional latency: combinational (0) for unit factors and sequential (the same as the multiplier) otherwise. This abstraction over  $L$  is a unique feature of Parafil: clients do not *provide* this latency parameter to instantiate `OptMul`; instead, they *adapt* to the latency that the component reports. This abstraction supports the optimization efficiently while keeping implementation details hidden. Figure 11 summarizes the results: register usage goes down by 28.9%, LUT usage by 25.7%, and latency by 27.8%, bringing us closer to the Spiral designs.

**Integrating Spiral.** The Spiral implementation still outperforms the Parafil-FloPoCo integration because its modules are mapped onto DSP blocks more often. Figure 11 shows that if we replace some Parafil blocks with the Spiral ones, the resulting design is competitive. A better approach, however, is to simply define an interface for Spiral FFTs and import them in Parafil:

```
comp FFT[N]<'G: II>(
  X[W*2][N/W]: for<_, i> ['G+i, 'G+i+1] 32
) -> (
  Y[W*2][N/W]: for<_, i> ['G+L+i, 'G+L+i+1] 32
) with {
  some II, L where L >= II > 0;
  some W where N % W == 0; // streaming width
} where N > 0;
```

The interface for Spiral modules abstracts over the latency, initiation interval, and the *streaming width* ( $W$ ) using output parameters. For  $N \neq W$ , where  $N$  is the number of points, this means that inputs are provided over multiple cycles enabling resource savings.

## 9 Enriching High-Level Design

Heterogeneous generator composition, enabled by Parafil abstractions, can enable new hardware design flows where

high- and low-level programming models for hardware design can be combined. We prototype such a flow by combining Google’s XLS toolchain with Parafil and show how it offers the best of both worlds: XLS enables rapid design of efficient, pipelined datapaths, and Parafil enables precise and correct resource reuse.

### 9.1 DSLX Language

XLS [15] represents Google’s continued investment in high-level programming models for hardware after using high-level synthesis tools to design production chips [36]. XLS provides an expression-oriented functional language called DSLX to express computations which are automatically pipelined and compiled to synthesizable hardware.

DSLX programs look like standard imperative programs:

```
pub fn ALU<E:u32, M:u32>(
  left: Float<E, M>, right: Float<E, M>, op: u1
) -> Float<E, M> {
  if (op == 0) { float::add(l, r) }
  else { float::mul(l, r) }
}
```

This implements a ALU parameterized on the floating-point representation. Unlike HDL programs—which instantiate circuits and schedule computations—DSLX use function calls and control flow to express the design. However, this high-level representation has drawbacks: XLS cannot currently express *resource reuse* [14] which means it cannot express designs like Parafil’s iterative FFT (Figure 9).

### 9.2 Integrating with Parafil gen

Unlike FloPoCo, XLS is a programming language and can therefore support arbitrary computation instead of a limited set of hardware blocks. We define a wrapper script that integrates XLS to Parafil gen’s block-based interface. The script does the following:

- Maps names of blocks to XLS template programs.
- Given an XLS block and a set of parameters, uses a preprocessor to replace the value of the parameters.
- Runs the XLS toolchain and returns a Verilog module.

For each module, we provide a type signature and an entry in the configuration file (§7):

```
comp A[E, M]<'G:1>(
  x: ['G, 'G+1] E+M+1
) -> (
  out: ['G, 'G+1] E+M+1
) with { some L }
```

```
pub fn A(
  x: Float<E, M>
) -> Float<E, M>;
```

The XLS signature above is invalid since  $E$  and  $M$  are unbound. The preprocessor in our XLS scripts replaces concrete values for them before invoking the XLS toolchain. The Parafil interface for this module has both input parameters—which provide bindings for  $E$  and  $M$ —and an output parameter—which abstracts the latency.

<pre>pub fn Butterfly(   a_r: Float&lt;E, M&gt;,   a_i: Float&lt;E, M&gt;,   b_r: Float&lt;E, M&gt;,   b_i: Float&lt;E, M&gt;,   t_r: Float&lt;E, M&gt;,   t_i: Float&lt;E, M&gt; ) -&gt; (   Float&lt;E, M&gt;,   Float&lt;E, M&gt;,   Float&lt;E, M&gt;,   Float&lt;E, M&gt;) </pre>	<pre>comp Butterfly[E, M]&lt;'G:1&gt;(   a_r: ['G, 'G+1] W,   a_i: ['G, 'G+1] W,   b_r: ['G, 'G+1] W,   b_i: ['G, 'G+1] W,   t_r: ['G, 'G+1] W,   t_i: ['G, 'G+1] W ) -&gt; (   out: ['G+L, 'G+L+1] 4*W ) with {   let W = E+M+1;   some L where L &gt;= 1; } </pre>
----------------------------------------------------------------------------------------------------------------------------------------------------------------------------------------------------------------------------------------------------------------------------------------	----------------------------------------------------------------------------------------------------------------------------------------------------------------------------------------------------------------------------------------------------------------------

(a) XLS signature.

(b) Parafil signature.

Figure 12. Butterfly module in XLS.

### 9.3 Iterative FFT with XLS

XLS does not support resource reuse and therefore cannot express an iterative FFT. Instead, we use XLS to design a butterfly module (§8.1) and use Parafil code to express the resource reuse. Figure 12a shows the XLS interface for the module: it takes real and imaginary parts of the inputs and the twiddle factor. Figure 12b explicates its timing behavior: all inputs are accepted in the first cycle and the output is available after  $L$  cycles, where  $L$  is determined by XLS based on the user-specified pipeline depth.

DSLX’s expression-based representation makes it easy to express the butterfly computation:

```
let re = sub(mul(a_r, t_r), mul(b_i, t_i));
let img = ...;
// in0 + (w * in1)
let o0_r = add(a_r, re); let o0_i = add(a_i, im);
// in0 - (w * in1)
let o1_r = sub(a_r, re); let o1_i = sub(a_i, im);
return (o0_r, o0_i, o1_r, o1_i)
```

**Expressing reuse.** Figure 12b does not match the interface of the butterfly module used in our iterative FFT (Figure 8a). We define a wrapper module that exposes the same interface as the iterative FFT’s butterfly and explicitly forward signals to and from bundles. This allows us to *transparently* replace our butterfly module with XLS. Furthermore, it is *the only change* needed to express butterfly reuse. The iterative design is abstract with respect to the butterfly implementation and can therefore reuse any implementation, including the XLS implementation; our job is done.

Figure 13 summarizes the results of exploring the design space of the combined Parafil-XLS iterative FFT. We select between reuse factors in  $\{1, 2, 4, 8\}$  and number of pipeline stages in XLS from  $\{5, 10, \dots, 45\}$ . We report LUT and register usage against the maximum frequency and remove any design points that cannot meet timing at 100MHz. As the amount of reuse decreases and number of stages increase, designs achieve higher frequencies and require more resources.

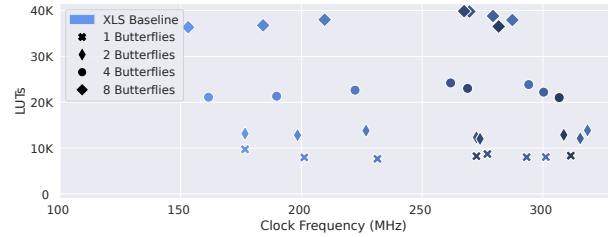

(a) FFT Throughput vs LUT usage.

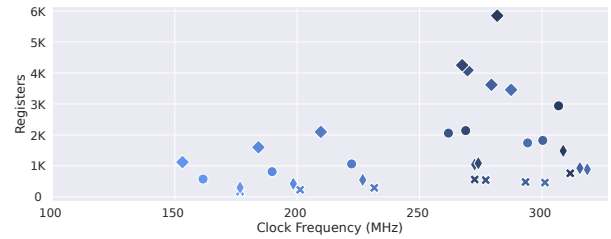

(b) FFT Throughput vs. register usage.

Figure 13. Parafil FFTs using XLS butterflies. Darker points have more pipeline stages and different shapes represent different amount of sharing.

## 10 Related Work

**Embedded hardware design languages.** Modern HDLs are often embedded in software languages [2, 3, 9, 19, 23, 31, 35] and leverage their constructs for powerful metaprogramming. Generator frameworks [38] emit HDL designs and provide similar capabilities. While enabling dramatically flexible design, such languages provide weak guarantees about the generated designs. Parafil provides strong guarantees about the pipelining behavior of all possible designs. The trade-off is that Parafil has limited metaprogramming constructs, and new features require care to make sure they can work with the type system and provide the required guarantees.

**High-level hardware design.** High-level programming models [12, 15, 16, 20, 28, 42] abstract away hardware details. The trade-off is control: the user must rely on, or reverse-engineer, the compilation process to get the final hardware design. Parafil offers a different trade-off: by safely combining HDL and high-level programs, we get productive exploration, low-level control, and correct composition.

**Metaprogramming.** General metaprogramming approaches include staging [37, 39], macro systems [21], and embedded DSLs [4, 18]. Parafil’s metaprogramming is most similar to MetaML-style typed staging: it constrains the set of compile-time primitives to ensure that it can enforce strong guarantees about *any* generated program.

**Verification systems.** Formal verification for hardware design [6, 24, 41] provides guarantees for particular instances

and require non-compositional reasoning [8]. Verified compiler for hardware design [5, 17] can provide correctness guarantees on the generation process. In contrast, Parafil uses a compositional type system to guarantee the absence of pipelining and resource sharing bugs. Future work can explore intermixing the guarantees provided by existing tools.

## References

- [1] IEEE Standard for Verilog Hardware Description Language. *IEEE Std 1364-2005 (Revision of IEEE Std 1364-2001)*, 2006.
- [2] C. Baaij, M. Kooijman, J. Kuper, A. Boeijink, and M. Gerards. ClaaS: Structural descriptions of synchronous hardware using Haskell. In *Euromicro Conference on Digital System Design: Architectures, Methods and Tools*, 2010.
- [3] Jonathan Bachrach, Huy Vo, Brian Richards, Yunsup Lee, Andrew Waterman, Rimas Avizienis, John Wawrzynek, and Krste Asanović. Chisel: constructing hardware in a Scala embedded language. In *Design Automation Conference (DAC)*, 2012.
- [4] Richard Boulton, Andrew Gordon, Mike Gordon, John Harrison, John Herbert, and John Van Tassel. Experience with embedding hardware description languages in HOL. In *Proceedings of the IFIP TC10/WG 10.2 International Conference on Theorem Provers in Circuit Design (TPCD): Theory, Practice and Experience*, 1993.
- [5] Thomas Bourgeat, Clément Pit-Claudel, and Adam Chlipala. The essence of bluespec: a core language for rule-based hardware design. In *ACM SIGPLAN Conference on Programming Language Design and Implementation (PLDI)*, 2020.
- [6] Cadence Inc. Jasper Gold FPV App, 2022.
- [7] Andrew Canis, Jongsok Choi, Mark Aldham, Victor Zhang, Ahmed Kammoona, Jason H Anderson, Stephen Brown, and Tomasz Czajkowski. LegUp: High-level synthesis for FPGA-based processor/accelerator systems. In *International Symposium on Field-Programmable Gate Arrays (FPGA)*, 2011.
- [8] Edmund M Clarke. Model checking. In *International Conference on Foundations of Software Technology and Theoretical Computer Science*, pages 54–56. Springer, 1997.
- [9] J. Clow, G. Tzimpragos, D. Dangwal, S. Guo, J. McMahan, and T. Sherwood. A Pythonic approach for rapid hardware prototyping and instrumentation. In *International Conference on Field-Programmable Logic and Applications (FPL)*, 2017.
- [10] James W Cooley and John W Tukey. An algorithm for the machine calculation of complex fourier series. *Mathematics of computation*, 1965.
- [11] Florent De Dinechin and Bogdan Pasca. Designing custom arithmetic data paths with flopoco. *IEEE Design & Test of Computers*, 2011.
- [12] David Durst, Matthew Feldman, Dillon Huff, David Akeley, Ross Daly, Gilbert Louis Bernstein, Marco Patrignani, Kayvon Fatahalian, and Pat Hanrahan. Type-directed scheduling of streaming accelerators. In *ACM SIGPLAN Conference on Programming Language Design and Implementation (PLDI)*, 2020.
- [13] Hasan Genc, Ameer Haj-Ali, Vighnesh Iyer, Alon Amid, Howard Mao, John Wright, Colin Schmidt, Jerry Zhao, Albert Ou, Max Banister, et al. Gemmini: An agile systolic array generator enabling systematic evaluations of deep-learning architectures. *arXiv preprint arXiv:1911.09925*, 2019.
- [14] Google Inc. Add capability to reuse expensive resources, 2023.
- [15] Google Inc. XLS: Accelerated Hardware Design, 2023.
- [16] James Hegarty, John Brunhaver, Zachary DeVito, Jonathan Ragan-Kelley, Noy Cohen, Steven Bell, Artem Vasilyev, Mark Horowitz, and Pat Hanrahan. Darkroom: Compiling high-level image processing code into hardware pipelines. 2014.
- [17] Yann Herklotz, James D. Pollard, Nadesh Ramanathan, and John Wickerson. Formal verification of high-level synthesis. In *ACM SIGPLAN Conference on Object Oriented Programming, Systems, Languages and Applications (OOPSLA)*, 2021.
- [18] Paul Hudak. Modular domain specific languages and tools. In *International Conference on Software Reuse (ICSR)*, 1998.
- [19] Jane Street. HardCaml: Register transfer level hardware design in OCaml, 2022.
- [20] David Koeplinger, Matthew Feldman, Raghu Prabhakar, Yaqi Zhang, Stefan Hadjis, Ruben Fiszal, Tian Zhao, Luigi Nardi, Ardavan Pedram, Christos Kozyrakis, and Kunle Olukotun. Spatial: A language and compiler for application accelerators. In *ACM SIGPLAN Conference on Programming Language Design and Implementation (PLDI)*, 2018.
- [21] Eugene Kohlbecker, Daniel P. Friedman, Matthias Felleisen, and Bruce Duba. Hygienic macro expansion. In *ACM Conference on LISP and Functional Programming*, 1986.
- [22] Yi-Hsiang Lai, Yuze Chi, Yuwei Hu, Jie Wang, Cody Hao Yu, Yuan Zhou, Jason Cong, and Zhiru Zhang. HeteroCL: A multi-paradigm programming infrastructure for software-defined reconfigurable computing. In *International Symposium on Field-Programmable Gate Arrays (FPGA)*, 2019.
- [23] Derek Lockhart, Gary Zibrat, and Christopher Batten. PyMTL: A unified framework for vertically integrated computer architecture research. In *IEEE/ACM International Symposium on Microarchitecture (MICRO)*, 2014.
- [24] Cristian Mattarei, Makai Mann, Clark Barrett, Ross G. Daly, Dillon Huff, and Pat Hanrahan. CoSA: Integrated Verification for Agile Hardware Design. In *Formal Methods in Computer-Aided Design (FMCAD)*, 2018.
- [25] Peter Milder, Franz Franchetti, James C. Hoe, and Markus Püschel. Computer generation of hardware for linear digital signal processing transforms. *ACM Transactions on Design Automation of Electronic Systems*, 2012.
- [26] VM Milovanović and ML Petrović. A highly parametrizable chisel HCL generator of single-path delay feedback FFT processors. In *International Conference on Microelectronics (MIEL)*. IEEE, 2019.
- [27] Kevin E. Murray and Vaughn Betz. Quantifying the cost and benefit of latency insensitive communication on FPGAs. In *International Symposium on Field-Programmable Gate Arrays (FPGA)*, 2014.
- [28] Rachit Nigam, Sachille Atapattu, Samuel Thomas, Zhijing Li, Theodore Bauer, Yuwei Ye, Apurva Koti, Adrian Sampson, and Zhiru Zhang. Predictable accelerator design with time-sensitive affine types. In *ACM SIGPLAN Conference on Programming Language Design and Implementation (PLDI)*, 2020.
- [29] Rachit Nigam, Pedro Henrique Azevedo de Amorim, and Adrian Sampson. Modular hardware design with timeline types. In *ACM SIGPLAN Conference on Programming Language Design and Implementation (PLDI)*, 2023.
- [30] Rachit Nigam, Pedro Henrique Azevedo De Amorim, and Adrian Sampson. Modular hardware design with timeline types. *arXiv preprint arXiv:2304.10646*, 2023.
- [31] Rishiyur Nikhil. Bluespec System Verilog: Efficient, correct RTL from high level specifications. In *Conference on Formal Methods and Models for Co-Design (MEMOCODE)*, 2004.
- [32] Peitian Pan and Christopher Batten. Formal verification of the stall invariant property for latency-insensitive rtl modules. In *Conference on Formal Methods and Models for Co-Design*, 2023.
- [33] Marshall C. Pease. An adaptation of the fast fourier transform for parallel processing. *Journal of the ACM*, 1968.
- [34] Christian Pilato and Fabrizio Ferrandi. Bambu: A modular framework for the high level synthesis of memory-intensive applications. In *International Conference on Field-Programmable Logic and Applications (FPL)*, 2013.
- [35] Oron Port and Yoav Etsion. Dfiant: A dataflow hardware description language. In *International Conference on Field-Programmable Logic and Applications (FPL)*. IEEE, 2017.

- [36] Parthasarathy Ranganathan, Daniel Stodolsky, Jeff Calow, Jeremy Dorfman, Marisabel Guevara, Clinton Wills Smullen IV, Aki Kuusela, Raghu Balasubramanian, Sandeep Bhatia, Prakash Chauhan, et al. Warehouse-scale video acceleration: co-design and deployment in the wild. In *ACM International Conference on Architectural Support for Programming Languages and Operating Systems (ASPLOS)*, 2021.
- [37] Tiark Rompf and Martin Odersky. Lightweight modular staging: A pragmatic approach to runtime code generation and compiled DSLs. In *International Conference on Generative Programming and Component Engineering (GPCE)*, 2010.
- [38] Ofer Shacham, Megan Wachs, Andrew Danowitz, Sameh Galal, John Brunhaver, Wajahat Qadeer, Sabarish Sankaranarayanan, Artem Vas-siliev, Stephen Richardson, and Mark Horowitz. Avoiding game over: Bringing design to the next level. In *Design Automation Conference (DAC)*, 2012.
- [39] Walid Taha and Tim Sheard. Multi-stage programming with explicit annotations. In *ACM SIGPLAN Workshop on Partial Evaluation and Program Manipulation (PEPM)*, 1997.
- [40] Muralidaran Vijayaraghavan et al. Bounded dataflow networks and latency-insensitive circuits. In *Conference on Formal Methods and Models for Co-Design*. IEEE, 2009.
- [41] Srikanth Vijayaraghavan and Meyyappan Ramanathan. *A practical guide for SystemVerilog assertions*. Springer Science & Business Media, 2005.
- [42] Zhiru Zhang, Yiping Fan, Wei Jiang, Guoling Han, Changqi Yang, and Jason Cong. AutoPilot: A platform-based ESL synthesis system. In *High-Level Synthesis*, pages 99–112. 2008.