

# A Survey on Property-Preserving Database Encryption Techniques in the Cloud

Johannes Koppenwallner  
Faculty of Computer Science  
University of Vienna  
Vienna, Austria

Erich Schikuta  
Faculty of Computer Science  
University of Vienna  
Vienna, Austria  
erich.schikuta@univie.ac.at

**Abstract**—Outsourcing a relational database to the cloud offers several benefits, including scalability, availability, and cost-effectiveness. However, there are concerns about the security and confidentiality of the outsourced data. A general approach here would be to encrypt the data with a standardized encryption algorithm and then store the data only encrypted in the cloud. The problem with this approach, however, is that with encryption, important properties of the data such as sorting, format or comparability, which are essential for the functioning of database queries, are lost. One solution to this problem is the use of encryption algorithms, which also preserve these properties in the encrypted data, thus enabling queries to encrypted data. These algorithms range from simple algorithms like Caesar encryption to secure algorithms like mOPE. The report at hand presents a survey on common encryption techniques used for storing data in relation Cloud database services. It presents the applied methods and identifies their characteristics.

**Index Terms**—Database systems, Property Preserving encryption, Cloud computing

## I. INTRODUCTION

### A. Motivation

Operating and maintaining a database is a laborious task. At first hardware for the server is needed. This hardware is often over powered for the expected, but under powered for the peak load. Then this hardware needs space, has to be properly maintained and secured against failure. The operating system has to be administered and updated regularly and the database management system also has to be installed and maintained. If the use of a commercial database is needed, complying to the licenses is a challenge for itself. In short, operating a database does not only require a significant investment, but also permanent effort (staff and means) for its maintenance. If requirements for the database change at some later point, for example the expected usage is much higher than predicted, adjusting the solution can be expensive. Here is where the cloud comes into play. In the database as a service model, hardware and software are completely maintained by the cloud vendor. No upfront investment is needed, and if requirements change the service model can also be easily adapted. But there is a significant drawback for outsourcing a database into the cloud: The control

over the data is lost. Before putting the data into the cloud, only members (for example administrators) of the organization controlling the data were involved, now as second party, the cloud vendor is involved, too. This is the point, where many organizations give up their plan of moving their data into the cloud. It is simply not worth the risk and the additional organizational effort. An apparent easy solution to this problem would be to encrypt all data in the cloud with a standard cipher. Doing this, the cloud vendor would never have access to the plain text, so there should be no more issues regarding privacy and confidentiality. The problem with this solution is, that it does not work as intended. By using standard ciphers for encryption, the relational data model is not usable anymore. The reason for this is that encrypted values are no more compatible with the defined column data types, and queries do not retrieve the correct results anymore, because important properties of the plain text, like identity or order are lost. So we have two solutions with different drawbacks: Deploying the data unencrypted is insecure and usable, while encrypting the data makes it secure, but unusable. This report tries to elaborate and show alternative solutions, which maintain most of the security, while still being usable.

### B. Overview

For storing and retrieving structured data, the relational data model is still the dominant model. More and more data is collected and stored in databases and they are a critical part in nearly every IT environment. Traditionally these databases are run in house and managed by members of the same organization using it. With the rise of cloud computing this is changing. Databases are outsourced into the cloud and run and managed by the cloud service provider. As mentioned, this leads to serious privacy and security concerns, because not only the members of the organization itself have access to the data, but additionally the administrators of the cloud provider have access. Another serious concern is that a database, which was formally only accessible in an internal network, is now accessible over the internet. A solution to this problem is to encrypt the data with proven secure ciphers before putting it into the cloud. This approach does not work with

---

structured data, because important properties of the data are lost during encryption. The result is that the relational model does not work for the encrypted data anymore. The format of the data has changed and queries do not work the way they used to on the plaintext data. The data model and any application depending on this schema have to be changed. Even then, the result comes with a serious performance penalty, which makes this approach often impractical. To avoid this, other solutions are required. A lot would be gained, if ciphers can encrypt the values while still keeping format, order or other query relevant properties. In the optimal case, the data model can be left unchanged, while still providing data confidentially by encryption. Of course, any application depending on such an unchanged data model can be left unchanged too, if encryption and decryption is done transparently. To achieve the objective of a fully usable encrypted relational database in the cloud, multiple problems have to be solved.

*Cryptography:* A short overview of cryptography is given. This includes history, taxonomy and the description of some of the most significant ciphers. Ancient ciphers like Caesar's and standard ciphers like DES and AES are shown. A small example of the classical Caesar's cipher is presented. The next chapter describes some attack scenarios and the use of encryption to mitigate these threats in the context of a database. It shows the use case for data at rest and data in transit. For data at rest it shows the different levels (storage, database, application) at which encryption can be performed. The advantages and disadvantages of the place of encryption are discussed here too. Then concrete solutions and applications of encryption on the different levels are presented. Database specific issues of ciphers are shown, and state of the art encryption techniques, such as homomorphic and order preserving encryption are described.

*Relational Model Requirements:* The relational model has some implicit requirements which have to be satisfied to be usable. As plain text always satisfies these requirements, ciphertext does often not (at least not out of the box). As these requirements are different for each SQL construct, the specific requirements for data definition and queries are given.

*Ciphers with Properties:* Although standard ciphers often do not satisfy the properties required by the relational model, ciphers exist which satisfy some or multiple of these requirements. An overview of the different properties like format preserving, order preserving, functional and homomorphic encryption is given. State of the art ciphers are shown and described in detail. For queries, order preserving is a often needed property. Different order preserving encryption schemes are shown in detail. Security definitions are given, and these ciphers are compared regarding their properties, security and implementation.

*Commercial Solutions:* An overview of existing solutions is given. These solutions includes research

projects like CryptDB as well as commercial products and solutions. These cloud based solutions are presented and compared with each other regarding their features and security.

*Requirements for Cloud Computing:* Moving data to the cloud requires additional concerns especially, but not only regarding security. After describing the database as a service scenario based on the previous chapter, additional requirements on security and privacy in the cloud are given. Contradictions between security requirements and other cloud-specific requirements, like scalability or elasticity, are shown. Deployment scenarios are described, and a short overview of available database as a service solutions is given. The chapter is concluded with the description of Relational Cloud, a project aiming to enhance the existing DBaaS model with security and privacy in focus.

### C. Scope and Limitations

This report focuses on relational databases running in the the cloud. For evaluation the database as a service (DBaaS) model is used from some cloud vendors. The encryption of unstructured data or data in non-relational databases like NoSQL databases is not examined. Of course, some of the presented ciphers may work here as well. This report is focused on the encryption of relational databases in the cloud, not on security in general. Other important security topics like key management, authorization, authentication are only scratched on the surface or not discussed at all.

## II. CLOUD

Originating from data centers and grid computing, cloud computing started gaining momentum around 2006. Organizations and enterprises began to outsource part of their internal IT into the cloud, while a few other companies provided their internal services to external customers and became cloud service provider. One of the first of these companies was Amazon starting their cloud offer "Amazon Web Service" (AWS) in 2006. Google and Microsoft followed later with their offers "Google Cloud Platform" and "Windows Azure" (later renamed to Microsoft Azure). Another kind of company here to mention is Salesforce. This company provided its software as a service over the internet from the start, thus becoming one of the first software as a service provider. As the definition of cloud computing is still evolving and changing [1], for this work the definition of cloud computing from the National Institute of Standards (NIST) is used:

"Cloud computing is a model for enabling ubiquitous, convenient, on-demand network access to a shared pool of configurable computing resources (e.g., networks, servers, storage, applications, and services) that can be rapidly provisioned and released with

minimal management effort or service provider interaction” [1, pp. 2].

Focusing more on the business perspective, but otherwise similar is another definition of cloud computing: “Cloud computing is an IT deployment model, based on virtualization, where resources, in terms of infrastructure, applications and data are deployed via the internet as a distributed service by one or several service providers. These services are scalable on demand and can be priced on a pay-per-use basis” [2, pp 4]. According to [2], there is a strong trend from products to services. This is not only true for hardware, but more and more for software, too. In cloud computing, hardware and software as a service are tightly integrated. Multiple services can be composed to support complex business processes. The NIST [1] defined the essential characteristics of cloud computing as:

- On-demand self-service.
- Broad (ubiquitous) network access.
- Resource pooling.
- Rapid elasticity.
- Measured service.

On-demand self-service means that a customer can add or remove computing capabilities without any human interaction as wanted. All capabilities and services are provided and accessed over a network. The provider’s computing resources are pooled to serve multiple clients. Another characteristic is that resources can be elastically provisioned and released. The last characteristic is that resource usage is monitored, controlled and reported. All these characteristics are fulfilled by the services from the established cloud vendors. As an example Amazon Web Services (AWS) allows customers to manage their cloud services with the AWS Management Console. With this web-based user interface services can be created, modified and removed on demand by the customer. These services are shared by multiple customers and the resources provided can be scaled up and down. All statistics of used services and resources and resulted cost are available directly to the customer [1].

### A. Cloud Computing Elements

The services in the cloud can be classified by service and deployment model.

1) *Service Models*: As cloud service providers offer many different types of services, these services are roughly categorized into three service models: Infrastructure, platform and software. These models can also be seen as layers, where basic services like providing storage, network or computing services are on the bottom, supporting services in the middle and specialized application services on top. The higher the service in the layer, the more specific the service is, where the lower a service, the more flexible usable it is. Normally services are using other services of the same layer or layers below. A database service, for example is using infrastructure services like storage and the database software will normally run on

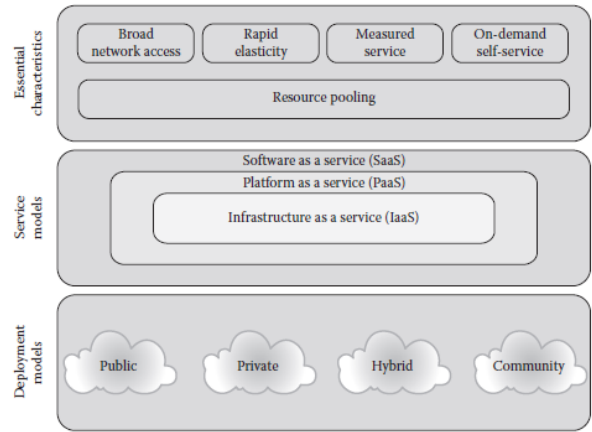

Fig. 1. Cloud computing elements [3, pp. 14]

an operating system in a virtual machine. It will need additional services, for example access to a domain name service, a firewall or the like.

a) *Infrastructure as a Service (IaaS)*: Virtualized hardware is provided over a network. Storage or computing resources are made available. Everything else, beginning from the operating system is managed by the customer.

*Platform as a Service (PaaS)*: These services are provided for developers and administrators. They can deploy applications on a software stack which is provided for the customer. The service stack is managed by the cloud provider, while the application itself is managed by the customer. Amazon (AWS) also uses the terms “Abstracted Services” and “Container Services” for this service model.

*Software as Service (SaaS)* : The applications of the provider are used by the customer. The model is focused of the end user of the cloud. The user does not manage or control the underlying cloud infrastructure, only user-specific application settings are possible. Examples for this services are Office 365 from Microsoft or Photoshop CC from Adobe.

2) *Deployment Models*: Another categorization is by deployment. This categorization is orthogonal to the service model. Every service model can deployed in different ways, and a deployment model does not have any influence on the service model. The deployment has an direct impact on the security and privacy of the data in the cloud, as there is an additional layer of defense for the private and hybrid cloud, because the access to it is restricted. Multiple service models can be deployed by using the same deployment model, but the opposite is possible too, a service can be available for multiple deployment models.

a) *Public cloud*: The cloud infrastructure is provisioned for use by the general public. This is considered the standard deployment scenario for cloud computing.

---

b) *Private Cloud*: The cloud infrastructure is exclusively provisioned for a single (often large) organization. This is the most secure deployment scenario, as no unintentionally interactions with other customers or users of the cloud are possible.

c) *Community cloud*: The cloud infrastructure is exclusively provisioned for a specific community.

d) *Hybrid Cloud*: A composition of two deployment models. Although the cloud infrastructure is separated, applications and data can be deployed in the private and in the public part. A typical usage model is cloud bursting: If the demand for resources exceeds the capacity of the private cloud, these additional resources are provided by the public cloud. Azure Stack makes it possible, to deliver cloud services from an internal data center [1].

e) *Virtual Private Clouds (VPC)*: A private cloud is simulated in the public cloud, by physically isolating storage and networking [4, pp. 43].

3) *Actors and roles in the cloud*: Outsourcing processes and services requires new actors and roles. According to [4] the actors facility manager, service provider, cloud user, and IT manager exist. Facility managers are the operators for the outsourced services of the data center. These data centers can be autonomous or a direct subdivision of the cloud vendor. The service providers manage the resources of the data centers and are employees of the cloud vendor. Cloud users are the customers of the cloud services, they can be different from the end user. End users are the people using the services provided by the cloud. IT Managers are the people responsible of the computer infrastructure in an organization [4].

4) *Cloud Computing Strength and Weakness*: Cloud computing is still growing fast. The main driver for this growth are advantages over the classic in house operating and maintenance model. According to [4],[5],[6] these advantages are:

- Reduced cost with shared infrastructure.
- Avoiding over provisioning for peak times.
- Eliminate the need to hire or train specialized IT staff for each application and system.
- Pricing models like charge per use and pay per use, resulting in more budget flexibility.
- On-demand elastically and scalability, resulting in more business agility.
- Any-where any-time accessibility.
- Outsourcing of hardware and software management.
- Better security.

Reduced cost is always a good motivation. But it is also good to know, where this reduced cost come from. For cloud services the reasons are economy of scale and shared infrastructure. Considering the size of the big cloud vendors, economy of scale does not need any further explanation but an even stronger effect comes from shared infrastructure. Multiple customers can share the same infrastructure, but not only infrastructure itself, but also the cost of maintenance for the infrastructure.

This minimizes capital investment in IT infrastructure and the need to build out data center facilities. The provided pricing models are very attractive too, as they are flexible and do not require any upfront investments. This budget flexibility makes it possible to switch capital expenditures for operating expenses. As the services are available over the network, the cloud resources can be accessed from any location and at any time. So a change of the region for a provided service is simple and fast. Resizing the resources on-demand is a big advantage, too, as peak demand for IT resources can easily satisfied. This makes it possible to align costs with usage and to avoid over provisioning. As result, this enhances business agility and makes it possible to deploy and remove resources as needed. The next advantage can not be overrated. Hardware and software management requires a lot of internal resources in every organization. Any problems in this area directly affects the performance of the whole organization. Security is often a controversial advantage, because it is often overseen, that the cloud has some benefits regarding security. First, due the availability of more resources, denial of service attacks are much costlier for the attacker, and chances are high that even DDoS (Distributed Denial of Service) attacks fail against one of the major cloud providers. Second, another advantage is that cloud provider usually have expert security personnel, who are specialized for exactly the services they are running. This might not be affordable in the in house data center. But of course, outsourcing into the cloud has not only advantages. Some potential drawbacks and disadvantages exist. These disadvantages are identified by [4],[5] as:

- Loss of control on hardware and software.
- Shared resource (performance reduced by neighbors).
- Potential security risk by placing critical data on remote servers.
- Vendor lock-in.

The loss of control can be seen as a disadvantage. The service provider takes over control of hardware and software, whereas the degree of control for the later depends on the chosen service model. The customer therefore has no more control over the hardware and software used. This means that any competitive advantages regarding software or hardware are no longer possible. Shared resources can also have some severe drawbacks. As already mentioned, sharing resources is great regarding cost, but only as long as the use by other customers has no negative impact on the provided resources. Privacy and security is a, if not the, critical concern of outsourcing data. A lot of trust to the vendor is necessary to give internal data out of hands. Depending on a specific vendor for a service can also be a serious disadvantage, if the vendor uses this dependency for its own benefit. Many of theses disadvantages are in fact simply the other side of the coin of the advantages listed before. It is great, not having to grapple with software and

hardware, on the other side it is not so great if you cannot control your software and hardware anymore.

### B. Database as a Service

As this report is about databases in the cloud, the database as a service model (DBaaS) is examined in more detail. The database as a service model was first described by [7] in 2002. It was implemented using the database DB2 and therefore named NetDB2. Besides the performance overhead of remote access, it identified data privacy as the most challenging problem and suggested first solutions to the problem. A cloud deployment of a relational database has advantages over the traditional in house approach. As already mentioned before, cost is always a strong driver for migration into the cloud. In this case it is not only the economy of scale on hardware and energy, but also in workforce for administrating and maintaining the database. Figure 2 on page 5 shows the time spent on different tasks by an administrator. Database administrators are not waiting at every corner, and their expertise is well paid. Another, often more important advantage is flexibility. Performance peaks are easier to handle, because the cloud provider can easily distribute the workload. Paying only the used resources is also a great benefit. In short all general advantages of the cloud apply to the DBaaS model as well. The commercial DBaaS offers have only the standard database security features enabled. This means that normally the transport is encrypted and the data is at least optional encrypted at rest. To gain additional security, encryption on the application level is necessary.

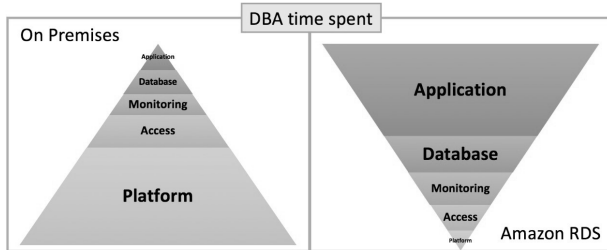

Fig. 2. Database Administrator Time (AWS)[8]

1) *Overview of DBaaS Providers:* All major cloud computing vendors offer managed relational databases as a service. These services exist for both open and closed source database management systems. The most widely used open source database engines are MySQL/MariaDB and PostgreSQL. Multiple service provider exist for the top commercial databases from Oracle and Microsoft, while a service using DB2 is offered only by IBM itself at the time of writing. As there exist a myriad of constantly changing different options of hardware and software options, here is only a short overview of the provided services:

*Amazon Relational Database Service (RDS):* Amazon offers the broadest range of services. Different options regarding type and number of processors, amount of memory, size of storage and network resources exist. (<https://aws.amazon.com/rds/>) The supported database engines are listed below.

TABLE I  
AWS DBAAS

Database	Description
Amazon Aurora	MySQL and PostgreSQL compatible
PostgreSQL	PostgreSQL 9.3.12 - 10.5
MySQL	MySQL 5.5, 5.6, 5.7
MariaDB	MariaDB 10.0, 10.1, 10.2
Oracle	Oracle 11g (11.2.0.4) and 12c (12.1.02)
Microsoft SQLServer	SQL Server 2012 - 2017

*Microsoft Azure Relational Databases:* Microsoft offers many different configurations for relational databases in the cloud. These configurations vary regarding the used database engine, the type and number of CPU cores and amount of memory provided and the kind of deployment (shared, managed, single). (<https://azure.microsoft.com/en-us/product-categories/databases/>)

TABLE II  
AZURE DBAAS

Database	Description
Azure SQL Database	based on enterprise edition of SQL Server
Azure Database for PostgreSQL	PostgreSQL 9.5, 9.6, 10.4
Azure Database for MySQL	MySQL 5.6, 5.7

Azure SQL Database was used during evaluation to show the support of multiple databases (and not only MySQL).

*Google Cloud SQL:* Google offers a fully managed database service for (currently) two open source database management systems. (<https://cloud.google.com/sql/docs/>)

TABLE III  
GOOGLE DBAAS

Database	Description
Cloud SQL for MySQL	MySQL 5.6, 5.7
Cloud SQL for PostgreSQL	PostgreSQL 9.6

*IBM Cloud:* IBM offers its commercial databases DB2 and Informix as fully managed service<sup>1</sup>. Additionally it offers two open source relational databases on its compose platform. Compose is a platform for all different kinds of NoSQL and SQL databases and middleware like message brokers. This includes services for MongoDB, Redis, JanusGraph, RabbitMQ, MySQL and PostgreSQL. Apart from Db2 on Cloud, Db2 Hosted also exists as the unmanaged version of DB2.

<sup>1</sup><https://www.ibm.com/cloud/databases>

TABLE IV  
IBM DBAAS

Database	Description
Db2 on Cloud	a fully managed version of DB2
Informix on Cloud	<a href="https://www.ibm.com/cloud/informix">https://www.ibm.com/cloud/informix</a>
Compose for MySQL	MySQL Version 5.7
Databases for PostgreSQL	PostgreSQL Versions 9.4, 9.5, 9.6

*Oracle Database Cloud Service* : Oracle supports its own relational database in the versions 11g, 12c and 18c as managed service<sup>2</sup>. Additionally Oracle offers its Exadata Cloud Service, which is also available as customer edition. Exadata is Oracles customized software and hardware for running its database. The customer edition is the Exadata Cloud Service running at the customer’s own data center. MySQL is supported as cloud service, but not fully managed.

TABLE V  
ORACLE DBAAS

Database	Description
Oracle DB Cloud Service	Version 11g, 12c and 18c
Oracle DB Exadata Cloud Service	Exadata
Oracle DB Exadata Cloud at Customer	Run at the customer’s data center
Oracle DB Exadata Express Service	Lightweight version of Exadata
Oracle DB Schema Cloud Service	No full access to the database

### III. SECURITY

No software system with some useful functionality is without flaws and bugs. Although these flaws and errors may restrict the use some of its functionality, a system is often considered as working. If the software is well designed, then an error in one component has no impact on the usability of another component. The component which is not affected, works as specified. In this aspect the security of a system is different, because it is only as strong as its weakest link. It does not matter, how secure one part of the system is, if other parts, even only one, has a flaw, the whole security of the system can be lost. Functionality can be tested by validating the specification of its features. A system’s security has to be tested the other way, it is important to verify that certain functionality, like accessing assets without authentication or authorization does not exist in the system. This is significant harder to test than functional features. Another difference is the adversarial setting. Normally (legal issues set aside), a user wants to use the software in the way it was intended by the developer, certain rules like constraints and circumstances under which the software works are accepted. In the context of security, there are no rules to which the attacker has to comply. Another problem is that time is on the side of the attacker. Attackers often can research and examine a system for years, where the systems itself was developed under timing pressure and forced to finish by an always too early deadline. All these things mentioned, show that a secure system is hard to develop and even

<sup>2</sup><https://cloud.oracle.com/database>

harder to maintain. The more complex this software is, the harder it is to maintain security. As mentioned in [9, pp 37], “complexity is the worst enemy of security”. Another important point to mention is that security not only includes hardware and software, but also its users and their interactions. Bruce Schneier brings this to the point, saying “Security is a process not a product”[10, pp. XXII].

#### A. Privacy

In nearly every country of the world, the gathering, using and transferring of data, especially personal data is restricted by law. Every member of the European Union has to have data protection laws, which implements the directive 95/46EC of the European parliament and of the council. In 2018 this directive was replaced by the general data protection regulation (GDPR) 2016/679 of the European Parliament and Council. The directive restricts the processing of personal data in specific categories. Examples of personal data are: Racial or ethnic origin, political opinions, religious or philosophical beliefs, trade-union membership, health or sex life. The processing of data in these special categories is generally forbidden and only allowed, if

- The subject has given explicit consent.
- Processing is necessary for the purposes of carrying out the obligations and specific rights of the controller in the field of employment law.
- Processing is necessary to protect the vital interests of the subject, where the subject is incapable of giving his consent.
- Processing is carried out by an association with a political, philosophical aim and that the data is only of members and not disclosed to others.
- The processing relates to data which are made public by the data subject or is necessary for legal claims.

In the United States of America the National Institute of Standards and Technology (NIST) provides a guide to protecting the confidentiality of personally identifiable information (Special Publication 800-122) for all federal agencies. It defines personal identifiable information as

“Any information about an individual maintained by an agency, including (1) any information that can be used to distinguish or trace an individual’s identity, such as name, social security number, date and place of birth, mother’s maiden name, or bio-metric records; and (2) any other information that is linked or linkable to an individual, such as medical, educational, financial, and employment information.”[11]

Examples of personal identifiable information are name, social security number, driver license number, passport number, credit card number, address information, images of a person, fingerprints or other bio-metric data. The main recommendations for the handling of personal identifiable data are to

- Minimize the use, collection and retention to what is strictly necessary to accomplish their purpose.
- To categorize them by the confidentiality impact level.
- To apply the appropriate safeguards based on their confidentiality impact level.
- Develop an incident response plan to handle breaches.
- Encourage close coordination between chief privacy officers, chief information officers, chief information security officers and legal counsel.

General speaking, the European legislative is more restrictive than the American, because every member of the European union has to implement the directives. The previous mentioned NIST guide for example is only a recommendation and not a law [12], [11], [13].

a) *General Data Protection Regulation (GDPR)*: For cloud computing the responsibilities are split. The data processor is the cloud computing service provider like Amazon (AWS) or Microsoft (azure). The Data Controller is the customer of these cloud services [14].

b) *Information Systems Categorization regarding security*: Information and Information Systems can be categorized in three categories regarding the objectives of security: Confidentiality, Integrity, and Availability (also called the CIA triad) [15].

*Low* : The loss of confidentiality, integrity and availability has only a limited adverse effect, like minor damages or loss of assets on the organization.

*Moderate* : The loss of confidentiality, integrity and availability results in severe negative effects, like significant financial loss, but the organization is still able to perform its primary functions.

*High* : The potential impact of the loss of confidentiality, integrity and availability is high, if the organization is not longer able to fulfill its primary functions or results in major damage and losses for the organization or severe harm to individuals.

*Server Security Principles* : The NIST “Guide to General Server Security” [15] also lists security principles like simplicity, fail-safe, complete mediation, open design, separation of privilege, least privilege, psychological acceptability, least common mechanism, defense in depth, work factor and compromise recording. All these principles are applicable to servers in the cloud, too. The difference is that some of these principles have to be followed by the cloud vendor, and not the cloud customer or user anymore.

## B. Cryptography

*Cipher Security*: The security of a cipher is determined on how hard it is to break, and how much information is needed to do so. An algorithm is unconditional secure only, if no matter how much information the attacker has, it is not possible to recover the plain text. If an algorithm is only computationally secure, it means that it cannot be broken by the available resources [16]. Cryptography is a vast discipline with many ciphers. Many taxonomies of these ciphers exist, but to

give these ciphers some order and to give an overview a common taxonomy was chosen (see Figure 3 on page 7).

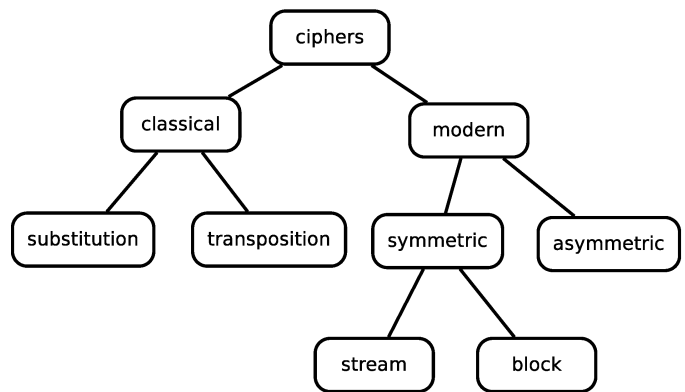

Fig. 3. Taxonomy of ciphers

### *Kerckhoff's principle:*

The security of the encryption scheme must only depend on the secrecy of the key, and not on the secrecy of the algorithm [9, pp 24].

The opposite of this principle is called security through obscurity. By security through obscurity an unknown cipher is used, or it is even unknown that any cipher at all is used. The problem is, if the obscure cipher is revealed, chances are high that it is not secure anymore, because a detailed cryptanalysis in public was never done. Security through obscurity is not recommended anymore. NIST Guide to General Server Security (SP 800-123) says regarding open design: “Security should not depend on the secrecy of the implementation or its components” [15, pp 2-4]. Steganography in contrast to cryptography tries to hide secretly information in plain sight. This can be also seen as security through obscurity.

*Block ciphers*: Block ciphers are rarely used directly, because the message size usually does not fit to the exact size of the block. For this are block cipher modes, which support arbitrary message sizes. The simplest definition of a secure block cipher according to [9, pp 44] is: “A block cipher is secure, if it keeps the plain text secret.” Another definition for security is the idea of an ideal block cipher. An ideal block cipher means, that for each key value there is a random permutation.

An ideal block cipher implements an independently chosen random even permutation for each of the key values [9, pp 50].

a) *Block cipher modes*: To encrypt messages, that are not exactly one block long, a block cipher mode has to be used. A block cipher mode is a function to encrypt an arbitrary length plain text to an ciphertext. As often the size have to be a multiple of the block length reversible padding is required to get the original message after decryption. Some of the most common modes for block ciphers are: ECB, CBC, Fixed IV, Counter IV, Random IV, Nonce-Generated IV [17].

- ECB (electronic code book). Each block is encrypted separately in this mode. This means that two identical blocks in plain text are encrypted to the same ciphertext, which makes this mode less secure, because with a chosen plaintext attack, it is easy to gain more information than acceptable. For example, if records contain an encrypted name, and an attacker tries to reveal if a distinct person with this name is in the record, than all the attacker has to do, is to create a record with the same name, and then select all rows with the encrypted name. Of course, sometimes this deterministic property is exactly what is wanted. An example is the foreign key relation in a database. If the same value is encrypted to different ciphertexts, it is not possible to reference it as a foreign key.
- CBC (cipher block chaining). Before encrypting the plain text, it is xor-ed with the previous encrypted block in this mode. This avoids the problem of identical plain text blocks resulting in the same ciphertext blocks. For the calculation of the first XOR there is no previous ciphertext block, so an initializing vector is needed. The following modes use different strategies to solve this problem.
- Fixed IV. Here the initialization vector (IV) is fixed. It has the same disadvantage as the ECB mode but for the first block only.
- Counter IV. In this mode, the initialization vector is the sequence of the message. This has the disadvantage that sometimes the sequence differs only one bit which means, that the same plain text is encrypted in a very similar ciphertext.
- Random IV. Using a random initialization vector is secure, but has the disadvantage, that this initialization vector has to be send to the receiver in the first block. Therefore the ciphertext is one block longer than the plain text.
- Nonce-Generated IV. Instead of sending the initializing vector itself, only the information (message counter) for creating an unique number (the nonce) is sent. This normally requires less overhead than the IV itself.
- Stream cipher modes. Multiple modes like OFB, CTR, OCB, CCM, CWC and GCM exist for stream ciphers.
- OFB (output feedback mode). Here an output stream with the key is generated, and the plain text is xor-ed with it.
- CTR (counter mode). Another stream cipher mode, but in this case it is using a nonce.
- OCB,CCM,CWC and GCM. These are special modes combining encryption and authenticity functionality at the same time.

1) *Classical ciphers*: All ciphers invented and used before 1950 are called classical ciphers. They can be further classified in substitution and transposition

ciphers [18, 28]

a) *Substitution ciphers*: A substitution cipher is a cipher where every letter of the plain text is substituted by a different letter. If every letter is always mapped to the same encrypted letter, a substitution cipher is called monoalphabetic.

b) *Caesar cipher*:: The most famous and in fact one of the simplest of these ciphers is the “Caesar Cipher”. Each cleartext letter is replaced by shifting the letter in the alphabet by  $n$  positions. The distance between the letter and the substituted letter in the alphabet is always constant.. More general, the key in this substitution cipher is the number of the shifts between the cleartext and ciphertext. Each letter of the alphabet is assigned a number according to its position in the alphabet, starting with letter A = 1 and ending with letter Z = 26. The function for encryption can be written as:

$$encrypt_K(P) = (P + K) \bmod |A|$$

P is the plain text (respectively the position of a plain text letter in the alphabet), K is the chosen key (number of shifts) and  $|A|$  is the number of letters in the alphabet. To encrypt a message, for each letter its position in the alphabet is determined, and the position of the encrypted letter is calculated by adding the value of the key modulo the number of letters in the alphabet. At the end the number is replaced with the corresponding letter. For decryption the function looks similar:

$$decrypt_K(C) = (C - K) \bmod |A|$$

In this function, C is the ciphertext and the other variables have the same meaning as in the function for encryption. To decrypt the message, the same steps are performed as in the encrypting function, but instead of adding the value of the key, the key is subtracted.

Example: Given the key  $K = 3$  (the original key used by Julius Caesar) and the plain text “VENI VIDI VICI” the ciphertext can be easily generated using the encrypt function: The first letter is ‘V’ so its position in the alphabet is 22. Adding the key (3) results in 25 modulo 26, which is 25, respectively the letter ‘Y’ according to the chosen alphabet. The next letter is ‘E’ encrypted to the letter ‘H’. To make it handier, a table of the alphabet in plain text and ciphertext can be generated. The first row shows the positions of the letters in the alphabet, the second shows the letters of the plain text and in the third row the letters of the ciphertext can be seen. To encrypt a letter, it is simply looked up in

TABLE VI  
CAESAR CIPHER WITH KEY = 3

position	1	2	3	4	5	...	9	10	11	12	13	14	...	22	...	26
plain text	A	B	C	D	E	...	I	J	K	L	M	N	...	V	...	Z
ciphertext	D	E	F	G	H	...	L	M	N	O	P	Q	...	Y	...	C

the plain text row and substituted with the letter of



the ciphertext. After the substitutions 'V' -> 'Y' , 'E' -> 'H', 'N' -> 'Q', 'I' -> 'L' the resulting ciphertext of the first word in the example is then "YHQL". As letters which are not members of the alphabet (in this case space) are ignored the whole message encrypted is "YHQLYLGOYLFL". To decrypt it, each letter is looked up in the ciphertext text row, and substituted with the plain text, resulting in "VENIVIDIVICI", which is (after including the corresponding spaces) the original message "VENI VIDI VICI".

A special case of this kind of cipher is ROT13. In this case the key is 13 and the plain text is revealed if the cipher is applied on the ciphertext a second time. The key space of these simple substitution cipher is 26, which means that only 26 different keys for this algorithm are possible. (Including the not very useful key 26, where the ciphertext is equal the plain text.) The result is that the encryption is very weak, and can be easily broken by an ciphertext-only attack. Even if the alphabet would be larger (resulting in more possible keys), it is easy to make a statistical attack on the ciphertext. When the frequencies of the letters in a language are known, and the frequencies of the encrypted letters are similar as in the plain text, it is easy to guess which letter is mapped to the encrypted one. In the German language for example, the letter "E" is with 17,4% the most used letter of the alphabet, so the probability is high, that in the ciphertext the most frequent used letter is the encrypted "E". One solution to avoid this kind of statistical attack is to map one plain text number (the position of a letter) to one or more ciphertext numbers according to their distribution in the language. These ciphers are called homophone [18], [19, 29].

c) *Multiplicative ciphers:* Another kind of monoalphabetic ciphers are multiplicative ciphers. In a product cipher every letter (its position in the alphabet starting with 0) is multiplied by a number, this number and the number of letters in the alphabet has to be relatively prime, to make the decryption unambiguous. The function to encryption and decryption can be written as:

$$encrypt_K(P) = (P * K) \bmod |A|$$

$$decrypt_K(C) = C * (K \bmod |A|)^{-1}$$

To decrypt the ciphertext has to divided modulo  $|A|$ , which is in fact a multiplication with the multiplicative inverse modulo  $|A|$ , which can be easily guessed for a small alphabet or calculated with extended Euclidean algorithm. A weakness of multiplicative ciphers is the tiny key space. For an alphabet with 26 letters, there exist only 12 valid keys, which vulnerable for a brute force attack [18].

d) *Polyalphabetic substitution ciphers:* A polyalphabetic cipher has not only one key, which maps a plain text letter to the ciphertext but has many keys. For encryption of the first letter the first key is used, for the second letter the second key and so on. After

the last key is used the circle starts again, encrypting the next letter with the first key. The advantage of these kind of ciphers is, that in the resulting ciphertext the distribution of the letters is hidden, which complicates a statistical attack on the cipher. Members of this kind of cipher are the Vigenere cipher and the Hill cipher [16], [18].

e) *Transposition ciphers:* In a transposition cipher the difference between plain text and ciphertext is only the order of the letters. A simple example of a transposition cipher is to write down the plain text in rows of fixed length and the ciphertext is the same text read by column. As there are many other possibilities in which order the ciphertext can be read from the table, many different ciphers of this kind exist. Another form of a transposition cipher is called permutation cipher, where the key is a permutation. All these ciphers are prone to statistical attacks, because the distribution of the letters in the plain text is the same as in the ciphertext [16].

f) *Rotor machines:* These mechanical devices allowed the automatic encryption of a message via a keyboard. It was a machine with a set of rotors in the end implementing a polyalphabetic substitution cipher. The best known rotor machine is the Enigma, which was used by Germany during WWII. As history showed, the encryption was not bulletproof and the encryption was broken by the British [16].

g) *One-Time pad:* Although all of the classical ciphers are weak and can be easily broken, there is one exception to this rule, the one-time pad. It is the only cipher which is unconditional secure. The cipher is simple and depends only on a good random key. This key consisting of random letters is used to encrypt the message letter by letter. The letter from the key is added to the plain text letter modulo 26. To decrypt the letter of the key is subtracted from the ciphertext. The important thing in this secure encryption scheme is, that every key is used only once. Every message has to be encrypted with another key, and the key has also be real random. The problem with this cipher is, that it is quite unpractical, because the key has to be the same size as the message (in fact, as the key can be only used once, a new key for every new message is needed), both sender and receiver need the this key and the key has to be truly random [18].

2) *Modern Block ciphers:*

a) *Symmetric ciphers:* A symmetric cipher is a cipher where the same key is used for encryption and decryption.

*Block ciphers:* Block ciphers are symmetric ciphers operating on a block of fixed size. The plain text message is divided in blocks and each block es encrypted separately.

b) *DES:* Data Encryption Standard [16], also known as Data Encryption Algorithm (DEA), was the first cryptographic algorithm, which became a ANSI standard. DES is a block cipher with a block size of 64bit. The result of applying the encryption on a block of plain text, is the ciphertext with the same size. The length of its key is 64

bits but because every eighth bit is used for parity checking the effective size is only 56. The basic building blocks of DES are simple (which makes it easy to implement), in fact only XOR, permutation and substitution is used. The application of a substitution followed by a permutation is called round.

The algorithm works as follows: After an initial permutation (IP), the block is split in two halves. Then 16 rounds (permutation and substitution) are performed, in which the key is combined with the data (in function F). At the end a final permutation is performed, which is the inverse of the initial permutation.

The interesting part of the algorithm is the function F, where the key (in fact a sub-key) is applied. In the first step of this function a sub-key of length 48 is generated. This is called a compression permutation, where the key is shuffled and reduced in one step. Then the right half is expanded to length 48. This is done via a expansion permutation, which not only changes the order of the right side, but adds additional bits too. In the next step XOR is applied on the compressed key and the expanded right side. The substitution is performed on the result. DES has eight different substitution boxes (S-Box), each having an input of 6 and an output of 4 bits. The 48 bit block is distributed to the S-boxes and the substitution is performed. In the next step, the 32 bit output is permuted by a P-box. At the end of the round XOR is applied on the output of the right side and the left side and the sides are switched for the next round. Decrypting works the same way, the only difference is, that the order of the sub-keys is inverted.

The security of DES depends on the length of the key and the implementation of the S-boxes. The S-boxes, although not perfect showed only minor flaws, which can be avoided. The problem is, that the key with 56 bits is too short, opening the door for brute force-attacks. Another flaw is that if you choose 0 as key then all rounds use the same key and as encryption and decryption are the same, except from the order of rounds this distinguishes the algorithm from a ideal block cipher. Another property of DES is, that if you encrypt the complement of the plain text with the complement of the key, you get the complement of the ciphertext. 3DES is attempt to enhance the security 3DES by using three keys in sequence to encrypt a block. This solves the problem of the small key size, but not the problem of the small block size. Of course encryption/decryption takes three times as long as with DES [19], [18], [9].

c) *AES*: Because DES with a key of 56 bit was no longer secure, a new standard, the Advanced Encryption Standard (AES), was created. It is a cipher with a block size of 128 bit. The key can have a length of 128, 192 or 256 bit. According to the length of its key, AES performs 10, 12 or 14 rounds. In every round except the last the following steps are performed. Subbytes implements an S-box, doing substitutions. ShiftRow does some permutations analog

to a P-box. As all this operations are done on a 4x4 matrix the next step MixColumns changes the order of the columns. AddRoundKey, the last step adds a sub-key to the matrix. In the last round the step MixColumns is replaced by AddRoundKey. As of today no security flaws of AES are known, so the only possible attack is a brute-force attack on the key, which is even with the smallest length not possible with current available hardware. This has not to be true for the future. In fact there are already theoretical attacks on AES with 192bit and even 256bit key length [19], [18], [9].

d) *Stream ciphers*: Stream ciphers are symmetric ciphers, where each bit is encrypted one by one. Stream ciphers are often faster than block ciphers, but their security depends on the randomness of the used keys. A famous example of a real secure stream cipher is the one-time pad, which was already mentioned before in the group of the classical algorithms.

e) *RC4*: Another well known and used represent of stream ciphers is RC4, named after Ron Rivest. This cipher uses a 8x8 S-Box, with permutations in the range from 0 to 255. The permutation depends on the key, which has no fixed size. Then according to a simple algorithm, a random byte K is generated and XOR is applied on K and the plain text. The same thing is done to decrypt the ciphertext. The algorithm is about ten times faster than DES. If the key is long and random enough, this encryption is quite strong. If not, like in the case of WEP (Wired Equivalent Privacy) it is not secure [20].

f) *Asymmetric ciphers*: An asymmetric cipher is a cipher where different keys are used for encryption and decryption. They are also called public-key algorithms, because at least one key is public available. It is crucial for an asymmetric cipher, that the private key can not be deducted from the public key. The plain text can be encrypted with the public key, and this plain text can only be decrypted with the private key. The classic example is to send an encrypted email. To do this, the public key of the receiver is used by the sender (the sender has to know this key) to encrypt the message. This message is then sent to the receiver, and can only decrypted by the private key of the receiver.

g) *RSA*: The first commercial public-key algorithms was RSA, named after Rivest, Shamir, and Adleman. The algorithm works as follows: To generate the both keys (public and private), two large primes p and q are chosen and multiplied, resulting in n. Then a encryption key e is chosen, which has to be relative prime to (p-1)(q-1). Then the decryption key d is calculated by

$$ed \equiv 1 \pmod{(p-1)(q-1)}$$

The public key consists of the numbers e and n, and the private key is e. To encrypt a message it is split in blocks smaller than n. A block is encrypted with

$$m^e \pmod{n}$$

---

and decrypted with

$$c^d \bmod(n)$$

The security of RSA depends on the fact, that factoring large numbers is computationally costly, because the factoring of  $n$  is required to get the decryption key. The key length is obvious very important and has normally a length from 1024 to 4096 bit.

3) *Tokenization* : “Tokenization is the process of randomly generating a substitute value, or token, that is used in place of real data, where the token is not computationally derived in any way, shape or form from the original data value”[21]. While the plaintext and the token is stored local, only the tokens are stored in the external database. The tokens can, but do not have to, preserve the type and format of the plain text data. The drawback of this approach is, that the whole data has to be stored locally, which requires additional resources and security measures. This can contradict the advantages of moving the data in the cloud. If the tokens are ordered or searchable, the same security drawbacks as of order preserving encryption exist. Access from outside can be another issue, which can, from a security standpoint, enlarge the attack surface of the solution significantly. Although having the same goal as encryption, a difference to encryption is, that tokenization is a non mathematical approach. As no sophisticated processing is required, it is usually more performant than the encryption process. Encryption, on the other hand requires no storage (except for the key). While the security of ciphers is often analyzed thoroughly, for tokenization this is often not the case, leading to security through obscurity. As a standard for tokenization X9.119 exists. Visa has defined best practices for tokenization in [22]. Best practices are for example: Segment the tokenization system from the rest of the network, give only authenticated users access the system and monitor it tightly. The tokens should be distinguishable from the plain text. The token generation should use a strong cipher or a one-way reversible function [23], [21].

4) *Cryptographic attacks*: The goal of cryptography is to keep messages secure. Cryptoanalysis on the other hand has the goal to break the encrypted message and reveal its plaintext. Cryptology is the combined study of cryptography and cryptoanalysis. Practitioners of this discipline are called cryptologist and have normally a strong mathematical background. As the terminology of the domain cryptology is not unambiguous a short terminology for this report is given. A plain text (also called cleartext) is a readable message. Through the process of encryption the plain text message is concealed. The resulting encrypted message is called ciphertext. The reverse process, which restores the plain text from the encrypted message, is called decryption. A cipher is a cryptographic algorithm used to encrypt and decrypt a message. If the security of a cipher is based on keeping

the way the algorithm works secret, it is called restricted. The sum of the cipher, plaintexts, ciphertexts and keys is called a cryptosystem [16]. Although the focus of this report lies on cryptography, cryptoanalysis is also needed as the complementary part of it, determining the quality of a cipher and the usability for its applications. As the goal of the cryptoanalysis is to recover the original plain text, there a different type of attacks a cryptanalyst can perform.

Cryptographic attacks can be classified by the kind of access the attacker has to a system. A type of attack is also called attack model [10, p.90]. The more prerequisites and information for an attack is needed, the harder it is for the attacker to be successful. Or seen from the perspective of the cryptosystem: A cryptosystem is more secure, if it can withstand an attack where the attacker has all the information he can gather, than a cryptosystem, which can only withstand attacks where the attacker has only limited information about the system. A threat model and threat analysis is a prerequisite for every project. A threat itself is defined as: “An action by an adversary aimed at compromising an asset” [9, pp 21]. According to [9], the following attack models exist:

- **Ciphertext Only Attack.** The attacker has only the ciphertext of one or several messages. The goal of the attacker is to recover the plain text of the messages, or even to recover the key used for encryption. This is the hardest way for an attacker to break an encryption system. Modern algorithms normally withstand these attacks, because often the only way to decrypt the message is a brute-force attack to guess the key.
- **Known-Plaintext Attack.** In this attack model the attacker knows the plain text and the associated ciphertext for some messages. The goal of the attacker is again the decryption of other messages or even getting the key to get access to all messages. The access to plain text and ciphertext is quite common, if you think about standard messages in a protocol or the scenario, where the same message is sent encrypted to multiple receivers, in which case multiple receiver know the plain text. Another scenario is where the plain text is revealed after some time, because the secret is revealed to the public anyway, like a quarterly report of a public corporation.
- **Chosen-Plaintext Attack.** In this kind of attack, the attacker does not only know some given plain text and its associated ciphertext like in the previous attack model, but can also choose the plain text which is encrypted. The attacker has access to the resulting ciphertext. This is often the case when the attacker can specify input values, which are saved encrypted by an application. A simple example is if you can create an user with a password for an application and have access to the database, where the password is stored, too.

- Chosen-Ciphertext Attack. The cryptanalyst can choose different plaintexts and ciphertexts and has full access to the associated ciphertext and plaintexts. This gives the attacker more freedom for the attack, making it more powerful than the chosen-plaintext attack, although it is not that common as the later. The goal of this attack is still to recover the key [16, p.32].
- Distinguishing Attack. In the attacks before, the goal was to get access to the plain text or the key. In this sort of attack the goal is to get additional information about a new encrypted message after observing several messages before. This means that although the new message can not be fully decrypted at least some information is disclosed.
- Side-Channel attacks (information leakage). In this kind of attack timing information or electricity consumption can reveal information. Although the cipher itself is not compromised, valuable information is leaked. An example could be that the validating of a passwords takes more time if the first letters are valid. This makes it much easier for the attacker to guess a valid password.
- Generic attack techniques. Another group of attacks is called generic attack. These attacks can not be avoided, because they are system immanent. An example is DRM for audio or video files. It is always possible to make an analog copy of the audio or video file, when it is played. Other examples of generic attacks, which can hardly be avoided are:

- Birthday Attack. This attack is named by the fact, that if there are 23 people in a room, the chance that 2 have the same birthday is more than 50%. In general this means that duplicate values and collisions are not as uncommon as expected. This fact is important, where the security is based on the fact that values are unique, for example for transactions.
- Meet-in-the-Middle Attack. This is another collision attack similar to the birthday attack. For this attack, parts of the possible keys are generated and stored in a table with a known plain text, known from the protocol. If a match is found, some valuable information (worst case a key) can be revealed.
- Related-key attack. This attack is applicable if a relation between different keys exist. If this relation can be revealed other attacks can be launched.

*Attack tree:* An attack tree can be built, to show the links of a security systems and the possible attacks on them. Figure 4 on page 12 shows the possible and impossible attacks on the different components of a system from the perspective of the attacker. Other attributes of the attack like cost and the needed know how can be

added. The goal is to think like the attacker and to fortify the links which are protected the least.

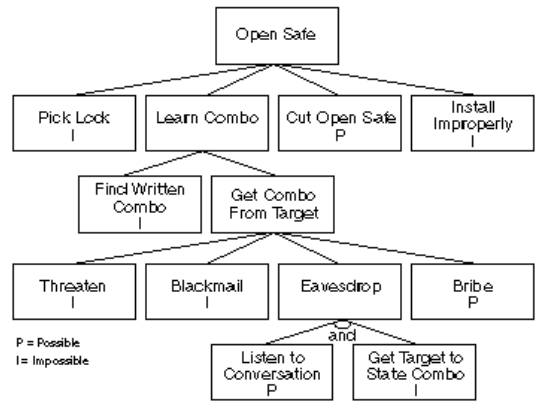

Fig. 4. Attack tree [20]

*Forward secrecy:* Forward secrecy means, that even if a key is compromised, old ciphertext is not revealed.

### C. Database Security

In a database, the avoidance of unauthorized access to restricted data is one of the key aspects of security. To prevent the disclosure of sensitive data, a database management system provides a role-based access control system to all objects in a database. With access control it is possible to define and execute fine granular policies to ensure the confidentiality of sensitive data. Although an important (maybe the most important) single aspect in database security, it is not enough to guarantee data confidentiality within the system. Defense in depth as a security principle is always a good reason to provide additional protection to data, as there are always chances that confidential data can be leaked to unauthorized users. Threats like bugs in the access control system or misconfiguration of user access rights can never be excluded completely. The even more important reason is, that some threats against data confidentiality simply cannot be mitigated by the access control of the database. This is specially true in the case of deployment scenarios, where the provider of the database server or the administrator of the database cannot or can only partially be trusted. Common threats are:

- Eavesdropping of communication.
- Legitimate privilege abuse.
- Platform vulnerabilities.
- Backup data exposure.

Data encryption can be a viable option to mitigate these threats. Two main use cases for data encryption can be identified here: In the first scenario the data is encrypted at rest and in the second the it is encrypted in transit to avoid eavesdropping. Some solutions provide data confidentiality in both scenarios, and mitigate multiple threats, while some solutions only mitigate a single threat.

In both scenarios encryption plays a key role for data confidentiality [24].

1) *Encrypting data in transit*: Also known as encrypting data on the wire, encrypting data-in-transit is mitigating the risk of eavesdropping the database communication. Normally the communication between the database server and its client is not encrypted and can easily be eavesdropped. To avoid this, the communication between the server and the client or between database servers for replication is encrypted. There is a number of ways to achieve this goal by using a broad range of not only database specific techniques. According to [25] these techniques can be summarized as:

- Database-specific features (Oracle Advances Security).
- Connection-base methods (SSL).
- Secure tunnels (SSH).
- Relying on the operating system (IPSec).

The most common techniques used are SSL and IPSec and have a wide range of applications, the encryption of database communication being only one of them.

a) *Secure Socket Layer*: SSL or more correct TLS (transport layer security) since Version 3, is the de facto standard for e-commerce. It uses asymmetric encryption for the exchange of a private symmetric session key, which is then used for the rest of the session. Nearly all databases support the use of SSL via the driver and an advantage is that TLS is protocol independent and not restricted exclusively to the internet protocol, because it is implemented above the transport layer.

b) *IPSec* : IPSec (Internet Protocol Security) is another way to secure the communication between client and database server. IPSec operates on a lower level than SSL and can only used for IP traffic. IPSec is a standard and supported by most modern operating systems. It can ensure the authentication, integrity and confidentiality of communication between two endpoints. An advantage here is that it does not need the cooperation of the applications involved in the communication, so a database server has no support of IPSec, because it is not even aware that it is used to encrypt its entire communication [26].

2) *Encrypting data at rest*: Even if the database is perfectly secure and the database administrator can be completely trusted, the data is still in danger, if the server running the database itself is compromised. If the attacker gains access to the file system by any means, it is possible to steal data and log files of the database, and break its confidentiality. One kind of threat is that the attacker gains physical access to the storage system in cold state, either because of the rare case that the hardware is stolen or the more common case that the data on old tapes or hard disks is not completely destroyed. A solution against this threat is to encrypt the file system of this disks, so even if physical access can be gained, the confidentiality of the data is not broken. Another threat exists, if the attacker gains access to the file system on

the running system. In this case the encryption of the file system does not help, because during operation of the system, the files are decrypted and can be accessed easily. As any vulnerability in the software running on the server which enables access to the database files is sufficient to attack, it is important to avoid the leakage of confidential data even if access to the file system is gained. This can be accomplished if the database encrypts all data, or at least all confidential data in its files and log files. Most commercial database vendors support the encryption of data and log files, and they support the same symmetric ciphers for encryption. The biggest differences in the solutions are the granularity of encryption, like per column, table or database, and the management of the keys in the database management system. The encryption is either built in the database server or available as an option [25], [27]. An important decision is the place where the data at rest is encrypted. It has an significant impact on the threats that can be mitigated with the chosen solution. It also has great influence on the cost and performance of the database. The levels where data can be encrypted are:

- Storage-level encryption.
- Database-level encryption.
- Application-level encryption.

As shown in Figure 5 on page 13 the level, where the encryption is performed has direct influence on the key management and which threats can be mitigated on the specific level.

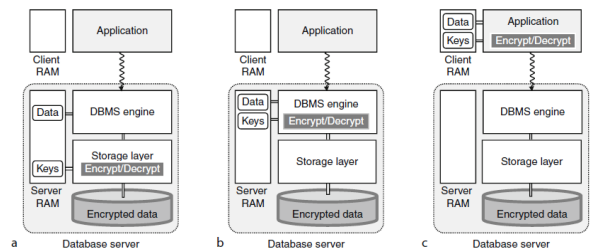

Fig. 5. DB-Level Encryption [25]

On storage level the file system is encrypted, minimizing the risk that a backup discloses confidential information. Also the data and logs are secure, if the server is in the cold state. If the server is running, this is not the case, because any malicious application on the server with enough privileges can access the data. The keys are stored on the database server, normally managed by the operating system. The database is not aware of the encryption. Other threats are not mitigated.

When the data is encrypted at the database layer, the database transparently encrypts and decrypts the data and logs. The keys are stored in the database itself, which means that a database administrator has access to keys and the encrypted data. During the operation of the database management system the data is in clear text in

---

the memory. As long as the database application itself is not compromised, the data is secured against backup disclosure and platform vulnerabilities. The encryption and decryption puts a significant additional workload on the database server. A big advantage is that the encryption is transparent to any application, so there is no customization of the application necessary.

If encryption is performed at the application layer, the database server is completely excluded of the encryption process. The key management is handled by the application and the encryption and decryption is also performed by the application, meaning there is no performance overhead for applying the ciphers on the server. As the size of encrypted data is usually bigger than the clear text and some ciphers require the selection and transfer of more data, this performance penalty still applies on the server. All threats on the database server are mitigated, but some like key management are only moved to the client. A major disadvantage is that it is not easy to perform complex queries with joins or aggregates on encrypted data on the database. There are special ciphers with additional attributes which make complex queries possible, but as already discussed, these solutions are either not as secure or have an significant impact on performance and are not as easy to use as standard symmetric block ciphers. An advantage is that the application has the full control of the encryption and can use in exactly the way needed.

*Examples of encryption on database level :*

*a) MS SQL Server:* Microsoft SQL Server is supporting the encryption of all data and log files of a database since Version 2008. This feature is called “Transparent Data Encryption” (TDE). TDE performs I/O encryption and decryption at the page level in real time. The data is encrypted before written to the disk, and decrypted after it is read from the disk. This is independent of the underlying file system. To do this, the database encryption key is stored in the database and secured by using a certificate stored in the master database. The protection of this certificate and its private key is very important, because the whole operation (including backups) of the database server depends on it. The ciphers used for encryption are AES and 3DES with different key lengths [28].

*b) Oracle Database:* Under the same name, but with different features, the Oracle Database is supporting transparent data encryption since Version 10g, too. It is part of an additional option called “Advanced security option”. This option includes the possibility to encrypt columns (constraint by data types) and since Version 11g the encryption of whole table spaces. For every encrypted table, a key is generated and all keys are secured by a master key. The whole key management is done by the database, and its master key is saved in a wallet or in a hardware security module (HSM) for more security. The use of TDE on a table or column is specified during the

data definition in SQL. It is possible to choose the cipher (AES or 3DES with different key lengths) and the use of salt can be specified. Without the use of salt, every value is encrypted to the same cipher text, so using salt is more secure, but it has the limitation, that it is not possible to create an index on encrypted column [29].

*c) IBM DB2:* Although not called or advertised as transparent data encryption, IBM has a solution for its database DB2 too. It is called IBM Database Encryption Expert and can as TDE encrypt all data at rest. It supports the encryption of backups and live data. Which data or files are encrypted and which not, is configured by the encryption expert agent, which can run on a separate server. As in the other solutions, the supported ciphers are AES and 3DES,

*d) Vormetric Encryption for Databases:* This product is an example of a vendor independent solution, as it supports Oracle, DB2, Informix, MS SQL Server, Sybase, MySQL and many other database management systems. The encryption key management is centralized and according to the vendor, it is completely transparent to databases and applications. Add-on exist for encryption in the cloud and for the Amazon cloud offering (AWS).

#### *D. Cloud Security*

According to [4, pp. 98] and a recent survey from IDC [30] security is still the biggest single concern in cloud computing. This is preventing or at least slowing down cloud adoption. One of the problems in cloud computing environments is the unclear definition of responsibilities between the customer and cloud service provider. As stated in [9, pp 5] “A security system is only as strong as the weakest link”, it is essential for security, that all different parts of a solution are taken into account. For example a perfect maintained operating systems does not help if the database has unpatched vulnerabilities or is configured without any access restrictions. Cloud providers like Amazon (AWS) try to solve this problem by defining the responsibilities in a model they call “Shared Responsibility Model”. This model splits the responsibilities between the customer and the provider by defining exactly for which configuration or artefact the customer is responsible and for which the provider (AWS) itself. As these responsibilities vary depending on the service model , each service type has its own shared responsibility model. Figure 6 on page 15 shows the shared responsibility model for container services. AWS manages all underlying infrastructure up to the database. This includes the operating system and the database management system itself. The customer is responsible for the configuration of data backup / recovery tools and the firewall. The responsibility for the customer data, its encryption and import still lies in the hand of the customer [31, pp 9].

Other important aspects of security in the cloud (and not only there) are:

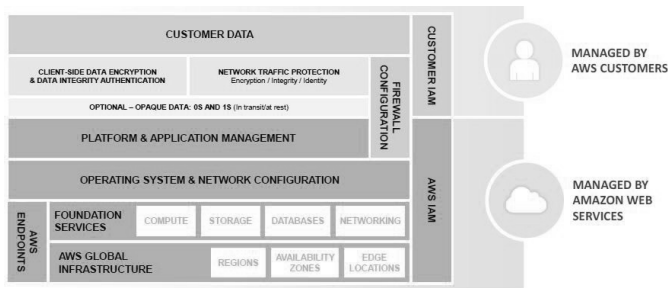

Fig. 6. AWS Shared Responsibility Model [31]

- Access Control.
- Secure Communications.
- Protection of private data.

Identity and authentication are fundamental for every secure software system. This is especially true for services in the cloud, as all resources are accessible over the network and due scalability there are plenty of resources available. Authorization for access of each asset is mandatory, too. As data has to be transferred in and out of the cloud, secure transmission of data is essential for avoiding eavesdropping of any kind. The protection of private data is fundamental for every organization and required by law. To protect this data, secure storage and computation is mandatory. Data integrity, confidentiality, and the risk of data leakage are here the main concerns.

*Relational Database Security with AWS* : AWS supports some security features for its relational database service. To get the data in and out of the cloud, encrypting the data in transit is supported by most databases, as they support SSL/TLS wrappers. This means that the driver communicates with the database in the cloud via TLS. This feature is supported by all RDS MySQL and Microsoft SQL instances. Amazon RDS for Oracle does not support a SSL/TLS wrapper but has a native encryption solution called “Native Network Encryption”, which encrypts the data on transit. For the encryption of data at rest the following options are available [31]:

- Encryption on application level.
- Oracle Transparent Data Encryption.
- MySQL cryptographic functions.
- Transact-SQL data protection function.

Encryption on application level does not need a support from the service provider, as here the data is encrypted and decrypted by the application and not the infrastructure service. Some databases like Oracle support the transparent encryption of data at rest and some like MySQL and Microsoft SQLServer have built-in functions to encrypt and decrypt data.

1) *Security Concerns in the Cloud*: As already mentioned, security concerns prevent the adoption of cloud solutions. According to [32] these concerns can be classified in:

*Traditional security concerns*: Computer and network intrusions are traditional security concerns, which are relevant for the cloud, too. There aspects of the cloud which can even reduce these concerns. For example cloud provider may have better than average security measures and processes or insider attacks are more unlikely, as security via contracts is easier than internal control.

- VM-level attacks.
- Cloud provider vulnerabilities (SQL-injections, cross-site scripting).
- Phishing cloud provider.
- Expanded network attack surface. Infrastructure to connect and interact has to be secured.
- Authentication and authorization has to be extended to the cloud.
- Difficult forensics in the cloud, as there is limited access to equipment. and media

*Availability*:

- Uptime (arguments are they are as high as in house).
- Single point of failure.
- Assurance of computational integrity (is the application faithfully. run and gives valid results)

*Third-party data control*:

- Due diligence (Can cloud provider respond in the required time-frame on a subpoena or other legal action, can deletion of data be guaranteed).
- Audit-ability (Has the provider enough transparency for auditing purpose.
- Contractual obligations by using the cloud.
- Cloud provider espionage.
- Data lock in (proprietary data format, vendor lock-in).
- Transitive nature (the cloud provider has itself subcontractors).

*Information-centric security* : Focus is shifted from data from the outside (systems and applications using the data) to protecting the data from inside. The data needs to be self-describing and defending, regardless of the environment [32]. Data is encrypted and packaged with its access policy and when accessed, reveals itself only in an trusted environment according to its policy. Data owners wish to audit how their data is used and to ensure that their data is not leaked or being abused. An approach is to have a trusted monitor, that can provide proof on compliance to the data owner. Another approach is to encrypt all data in the cloud, which has the drawback of limiting data use. Searchable (predicate) encryption is a method to restore the usability, even if the data is encrypted. As of today no perfect encryption is available, but recent research is promising. Other qualities like retrievability, which proves that all data of a client is stored correctly, are important too. Cloud fears largely stem from the loss of control of sensitive data. Control can be extended to the cloud by using trusted computing and encrypting all sensitive data [32]. This is exactly the

---

attempt of this report, encrypting all sensitive data, while still being usable in a database.

Providing access to a database in the cloud has, apart from the usual requirements for security and privacy, additional needs, because the data is not longer in the scope of the organization owning the data. One of these requirements is for example the secure transport from and into the cloud. In the cloud itself, the data has to be secured too, but not only against attacks from outsiders, but additional from insiders or the service provider too. Often this threat is not even a malicious cloud provider, but curiosity alone is enough motivation to breach privacy. As a public cloud normally has multiple clients, strict isolation between their data is an additional mandatory requirement.

2) *Privacy and Security*: As the transfer from and to the cloud can be secured by standard technologies like SSL/TLS or the like, the main goal is to secure the data, when it is in the cloud. The best way to achieve this, is to encrypt all or at least all sensible data in the cloud. For this, all techniques described in the chapter database encryption are relevant, but there are some additional things to consider, like compatibility with features of the cloud approach, for example scalability. The later in this chapter described project Relational Cloud is an approach to fulfill all these requirements.

a) *Attack Models*: According to the Cloud Security Alliance (CSA) the “Treacherous Twelve Cloud Computing Top Threats” [33] are:

- 1) Data Breaches. A data breach in general is an incident where confidential data is accessed without authorization. The impact of the data breach depends on the confidentiality and the scope of the disclosure of the information.
- 2) Insufficient Identity, Credential and Access Management. If attackers gain control of credentials and private keys security is broken. Therefore credentials and cryptographic keys have to be secured in particular. This includes activities to prevent weak passwords, invalid certificates and lack of cryptographic key rotation.
- 3) Insecure Interfaces and APIs. The security of cloud services depends on the provided application programming interface. This interfaces must provide protection against circumvention of authentication and access control.
- 4) System and Application Vulnerabilities. Every system and application can have bugs and flaws which can be used to compromise the system or application. Systems and application have to be updated and patched against found vulnerabilities to prevent the risk of data breaches.
- 5) Account Hijacking, Accounts can be hijacked by attack methods like phishing or simply social engineering. A compromised account can be used as a base for another attacks. Make matters worse,

credentials are often reused, compromising not only one but multiple accounts.

- 6) Malicious Insiders. A malicious insider can be a great threat. This is particular true in the cloud, because the insider of the service provider is normally no member of the organization, which owns the data.
- 7) Advanced Persistent Threats. A system is compromised for a long period by using sophisticated techniques to exploit vulnerabilities. The attacker in such cases can be a big organization or even a country with much more power at hand, than a normal attacker.
- 8) Data Loss. Losing important and not restorable data is a big concern in the cloud. Reasons for data loss are not only attacks, but also natural disasters of all kind.
- 9) Insufficient Due Diligence. As the cloud service provider is normally not part of the organization, which uses its services, all technical, commercial, legal and compliance issues have to be evaluated, before an outsourcing is possible.
- 10) Abuse and Nefarious Use of Cloud Services. If cloud services are not secured, they can be abused to cause damage on other systems. Misuse can be a DDoS attack, sending of spam mails or hosting illegal content.
- 11) Denial of Service. A denial of service attack prevents users from using a service. As a service in a public cloud has to be available on the internet and not only in an internal network, the attack surface for this kind of threat becomes larger in the cloud.
- 12) Shared Technology Issues. A cloud service provider usually shares its hardware and software for different customers. If these shared resources are not completely isolated, than the confidentiality of the data is at risk. In such a scenario it is possible that customer A using the same cloud as customer B, gains access to information of customer B.

A risk is composed of a threat, a probability and an impact. According to [34] a taxonomy of risks is given:

*A Taxonomy of risks::*

- Organizational Risks like Loss of reputation, loss of share value.
- Technological Risks Risks associated with the use of technological services like design,engineering, processes and procedures.
- Legal risks All issues due to legislation and regulations.
- Human errors an accidents.
- Network threats.
- Application threats.
- Host Threats.

*Threat assessments::*

- Data Threats (loss of data or integrity). Attacks cracking authentication credentials, SQL



injection, privilege escalation, unpatched database vulnerabilities, human errors, loss of encryption keys) These threats are not cloud specific, but using the internet as medium widens the risk (bigger attack surface) Another impact on security is less data control in the cloud. Establishing auditing controls are more difficult in the cloud. Data lock-in can also be seen as security issue. It is important to know, what happens with the data if the provider is changed.

- Physical Threats. When natural disasters occur, infrastructure can be harmed. As cloud providers often operate on larger scale, it is possible that they have more barriers against physical threats (for example datacenters in multiple regions). This threat is not cloud specific, too.
- Interface Threats. Are not only cloud specific, too. Security policy should ensure authentication and access controls. Monitoring is more complex in the cloud, as there are various layers of applications.
- Authentication Threats (Phishing, etc). They are the same in the cloud, but the impact in the cloud can be much higher, as there are often multiple clients affected.
- Virtualization Threats in the Cloud. Nearly all computing in the cloud depends on the virtualization paradigm. Isolation is not guaranteed. Attacks on hypervisors are possible.
- Cloud Power Threats. Denial of Service can affect multiple clients and applications can not separated from the internet.
- Outage. Although the chance is less probably, the impact of an outage in the cloud is much higher.

Traditional IT is easier to control and to manage, but also much more limited in resources (technical and human). There is no right answer whether traditional computing or cloud computing is better in terms of security [34].

*Threat classification:* STRIDE is a threat classification model for computer security threats. It is a mnemonic for

- Spoofing of user identity.
- Tampering.
- Repudiation.
- Information disclosure.
- Denial of service.
- Elevation of privilege.

It is used to reason about threats and find threats to a system [35].

*Threat Risk Modeling:* To assess the risk of a security threat and damage potential of it, the DREAD model can be used. It stands for

- Damage (How much damage will be caused, if an exploit is successful?).
- Reproducibility (How much effort is needed, to reproduce the exploit?).

- Exploitability (What is needed to exploit the threat?).
- Affected users (How many users are affected by the threat?).
- Discoverability (How easy is it, to discover the threat?).

The last item of the list (discoverability) is controversial discussed, because it can be interpreted as “security by obscurity”, which itself is controversial, and some say is no security at all, where others say, that every obstacle for an attacker, and not knowing that there is a threat is an obstacle, enhances security.

$$Risk_{DREAD} = \frac{(DAMAGE + REPRODUCIBILITY + EXPLOITABILITY + AFFECTED\ USERS * DISCOVERABILITY)}{5}$$

Values from 0 to 10 are assigned to each attribute. 0 means nothing or minimum effects and 10 maximum effects. The simple formula above calculates the overall risk of a threat, the higher the score, the higher the risk [36].

*Insider threats:* Many mechanisms exist for protecting data from outside attacks. Unfortunately, these mechanisms fail to protect data from authorized users from inside, who abuse their privileges. The protection of sensitive data from insiders is as important as protection from outside, as the the adverse consequences are the same. Insiders can use tables and relations they are authorized to access. Furthermore they also may gain additional knowledge by using dependencies. These dependencies can be:

- functional dependency.
- fuzzy dependency.
- multi valued dependence.

A functional dependency can reveal full information about another field, which depends on an accessible field. Fuzzy dependencies only reveals partial information, where as multi valued dependencies do not leak information [37]. Replication and load balancing of a database in the cloud can increase the probability of insider threats, which cannot be easily detected. To mitigate the threat the activities of insiders have to be monitored on different instances in different zones. Knowledge bases of insiders have to be monitored and synchronized. As this is normally the responsibility of the data owner, in the cloud it is the responsibility of the cloud provider. Different prevention models exist [38]:

- Peer-to-Peer.
- Centralized.
- Mobile Knowledge bases.

*Threat mitigation:* There are many possibilities to mitigate these threats like

- Data Obfuscation (Masking, Scrambling). Fake or scrambled data set for use by design and implementation teams, can be very expensive.

- Encryption of Data. Allows personally identifiable data to be scrambled if intrusion takes place, but adds overhead and possible performance issues.
- Database Intrusion/Extrusion Prevention. Looks for SQL injections, bad access commands and odd outbound data. Can cause performance issues, and needs very specific criteria to set up.
- Data Leak Prevention. Catches any data that is being sent out of the system. Does not protect data in the actual data warehouse.

Other threats are:

- Lost or stolen media. Can be mitigated by encryption.
- Unauthorized file sharing. Can be mitigated by encryption.
- Privileged user abuse. Can be mitigated by encryption, separation of duties and application authentication audit.
- Data leakage/unauthorized access. Can be mitigated by policy-based security.

#### IV. DATABASE ENCRYPTION IN THE CLOUD

As shown before, deploying a database into the cloud has advantages, but privacy concerns remain. To solve this problem, it would be great to only deploy the data encrypted and never as plaintext into the cloud. So in short, the goal is to deploy a database in the cloud, with all sensitive data encrypted, but still being usable as if the data were not encrypted at all. No change of an application or a query should be necessary.

##### A. Prerequisites

It is important to classify the data according to its sensitivity, because sensitive data needs special protection. A naive solution would be to classify all data as sensitive, but as this comes with an overhead, it is often no viable solution. For handling sensitive data different scenarios exist:

1) *No Sensitive data at all*: Maybe this looks like a trivial scenario, but often applications store and process more data than they need. Nowadays the technical tools (hardware and software) exist to process more data than ever, the credo here is often: the more data the better. But this does not come for free, and has some significant drawbacks regarding cost for storing, retrieving and managing the data. If this data contains sensitive data, then this cost is even much larger, because this sensitive data has to be protected, and the protection mechanism often include big overhead in the processing and management of the data. Also the legislative environment is changing to more restrictive privacy protection laws, and user and customer awareness of privacy issues is rising. So if it is possible to implement an application without the need of the processing and storing of sensitive data, this is simply the best case.

2) *No Sensitive data in the cloud*: If sensitive data is needed another way to avoid the drawbacks is to simple split the application and the database in two separated systems. One system has no sensitive data at all and can be easily deployed in the cloud like in the first scenario. For the system with sensitive data, there are either one of the following encryption strategies possible or the system can hold its data off the cloud. Of course it is important that this system does not only store the sensitive data separately, but also does not leak the information via its provided services. If you have an architecture based for example on microservices, then this can be a viable approach. Only services with no sensitive data are deployed in the cloud. The approach of this scenario is quite similar to the first, by rather not solving but avoiding the problem.

3) *Encrypting sensitive data in the cloud*: This is the case where at least some of the data is classified as sensitive and is deployed encrypted in the cloud. The data in a database can be encrypted on different levels of granularity. These levels of granularity are [39]:

- Relation.
- Attribute.
- Tuple.
- Element.

If the relation is encrypted, all data of an table is stored in a single value in the encrypted database. The granularity “Attribute” means, that each column is stored in a single value in the encrypted database. If the encryption is tuple based, a whole row (or at least most of it) is encrypted as one value in the encrypted database. The finest granularity is where each element is encrypted as single field in the database. As encryption of the levels relation and attribute make any normal usage of the database impossible, encryption based on tuple and specially on element granularity is preferred.

##### B. Encryption Strategies

To encrypt the data, multiple strategies are possible. Which to use best is highly dependent on the data model, data usage (like updates and kind of queries) and confidentiality or privacy requirements of the data.

1) *Standard ciphers*: The sensitive data is stored encrypted with a standard symmetric block cipher like AES. This is done without considering the datatype used in the database scheme. The data or better queries on it cannot processed in the cloud. Only exclusion is that the encrypted data can be selected like any binary field in the database. To process the data in a meaningful way, it has to be downloaded and decrypted. For range query this means that all data has to be downloaded. This is only practical if there are no such queries at all or these queries are executed only on a very small amount of data, as in all other scenarios the performance impact would be prohibitive. The key management is also a critical part of this solution, because it has to be implemented

on every private server where the data is processed. The advantage of this scenario is, that it is possible to use proven existing ciphers and can still achieve some of the benefits of the cloud like availability and scalability. As there is no processing possible in the cloud, it is more like a central master database in the cloud, from which every client can download or sync the data before it can be processed local.

2) *Standard ciphers and augmented data model*: In this scenario the data is fully encrypted as in the scenario before, but for each encrypted data field additional information on the data is provided. This can be additional information on order or equality of a field. The data model is extended for these fields. This makes range queries possible, by operating on the additional fields, and not on the encrypted data itself. Of course it is important, that this additional data does not leak information on the sensitive data itself. If these additional fields have to be computed for every update or delete, it could make the performance penalty prohibitive. For example, if any addition of one row, requires the update of all existing rows, to calculate the new orders in a row this would not work very well. A major disadvantage is, that the data model differs significant from the normal, domain specific data model and every query has to use the additional fields to work on the data. The advantage on the other side is that standard encryption technology can be used and some of the restriction on queries can be avoided. As queries are executed on a different data model, they have to be rewritten to be compatible for the enhanced data model. It is of course useful to automate the rewrite of the query, either by generating these queries or by rewriting it in a proxy.

3) *Ciphers with additional properties*: Beside from standard ciphers, other ciphers with additional properties exist. Encrypting the data with these ciphers makes it possible, to use the encrypted data as if it were plaintext. This strategy needs no change in the data model, which sounds only too well. The drawback is that there is a overhead of these ciphers and they are not as secure (at least not nowadays) as standard ciphers. Which properties are required is highly dependent of the queries used. Ciphers with properties are described later in detail V-B3 and VI, but before describing them, it is essential to determine the requirements of queries on the encrypted data.

### C. Query Requirements

As mentioned before, to perform non trivial SQL queries on encrypted data, the used ciphers have to provide additional properties to work. To make queries work on encrypted data without modification, different properties have to be supported by the used encryption scheme. The listed elements of queries are based on the description of relational operators in [40]. But before examining the queries, a short overview of the requirements originating from the used datatypes is given.

### Datatypes

As SQL uses different types, it is necessary, that the encrypted data is still a valid attribute. Format preserving means in this context not a special domain format like a social security number, but more a kind of type preserving encryption.

*String datatypes (CHAR, VARCHAR, TEXT ...)* : If the field is long enough, no additional properties are required for the cipher. If the length is too short or a special encoding is necessary, format preserving encryption is required.

*Number datatypes (TINYINT, INT, FLOAT, DECIMAL ...)* : Format preserving encryption is required.

*Date datatypes (DATE, DATETIME, TIMESTAMP, TIME...)*: Format preserving encryption is required.

### Restrictions

A `select` is restricted by one or multiple conditions. Multiple operators are supported, and the conditions can be combined with “and” and “or“. These operators determine the properties required for a cipher, so the are examined separately.

---

```
SELECT T.* FROM Table T WHERE T.Attr OP Value
```

---

or

---

```
SELECT T.* FROM Table T WHERE T.Attr BETWEEN Value1
AND Value2
```

---

- Equal (=). Equal requires a deterministic cipher.
- Not Equal (“<>”). Not equal requires a deterministic cipher.
- Less (“<”). Requires an order preserving cipher.
- Less Equal (“<="). Requires an deterministic order preserving cipher.
- Greater (“>”). Requires an order preserving cipher.
- Greater Equal (“>="). Requires an deterministic order preserving cipher.
- Between. Requires deterministic order preserving encryption

### Projection

---

```
SELECT DISTINCT T.Attr1, T.Attr2 FROM Table T
```

---

For the elimination of duplicates (DISTINCT) a deterministic cipher is needed. If no duplicates are eliminated, there are no requirements for a cipher.

### Join

---

```
SELECT T1.Attr1, T2.Attr2 FROM Table1 T1 JOIN Table2
T2 ON T1.Attr2 = T2.Attr2
```

---

As the join uses the equal operator a cipher has to be deterministic.

---

### Union

---

```
SELECT T1.Attr1 FROM Table1 T2 UNION Select T2.Attr1
FROM Table2 T2
```

---

As union has an implicit distinct, filtering duplicate entries, a deterministic cipher is needed.

### Union All

---

```
SELECT T1.Attr1 FROM Table1 T2 UNION ALL Select
T2.Attr1 FROM Table2 T2
```

---

Union all has no additional requirements for a cipher.

### Intersect

---

```
SELECT T1.Attr1 FROM Table1 T2 INTERSECT Select
T2.Attr1 FROM Table2 T2
```

---

For intersection a deterministic cipher is needed.

### Difference

---

```
SELECT T1.Attr1 FROM Table1 T2 EXCEPT CORRESPONDING
Select T2.Attr1 FROM Table2 T2
```

---

For difference to work, a deterministic cipher is needed.

### Semijoin

---

```
SELECT T1.* FROM Table1 T1 WHERE T1.Attr1 IN (SELECT
T2.Attr1 FROM Table2)
```

---

As the semijoin uses the equal operator a cipher has to be deterministic.

### Semidifference

---

```
SELECT T1.* FROM Table1 T1 WHERE T1.Attr1 NOT IN
(SELECT T2.Attr1 FROM Table2)
```

---

As the semidifference uses the equal operator a cipher has to be deterministic.

### Extend

---

```
SELECT T1.Attr1 * 123, T1.Attr2 FROM Table1 T1
```

---

As an arithmetic calculation (+,-,\*,/,%) is performed, the cipher has to be homomorphic supporting the arithmetic operation.

### Aggregate Operators

---

```
SELECT SUM(T1.Attr1) FROM Table1 T1 GROUP BY
T1.Attr2 HAVING SUM (T1.Attr1 < 2000)
```

---

The cipher has to be homomorphic (addition) and order preserving for the having clause, if another comparison operator like equal is used, than the cipher has to be deterministic.

---

```
SELECT MIN (T1.Attr1) FROM Table1 T1
```

---

The cipher has to be order preserving.

*Group By* : The cipher for the relevant attribute has to be deterministic.

*Having*: The same properties as for aggregate operator are needed.

### Summarization

---

```
SELECT COUNT(*) from Table1
```

---

No additional properties are required.

### Order By

---

```
SELECT T1.* from Table1 T1 ORDER BY T1.Attr1 DESC
```

---

The cipher has to be order preserving.

### Like

---

```
SELECT T1.* from Table1 T1 WHERE T1.Attr1 LIKE
'%'String%'
```

---

The cipher has to be searchable.

### Functions (Substr, Concat ...)

The cipher needs to be homomorphic, and the Functions must be implemented as user defined functions.

---

```
SELECT SUBSTR(T1.Attr1,1,5) from Table T1
```

---

### Summary

To give an overlook of the properties the relational operators are listed in Table VII on page 20. Of course depending on the type of the used attributes format preserving encryption may be an additional requirement for all of the listed elements.

TABLE VII  
REQUIRED PROPERTIES FOR SQL

	deterministic	order	homomorphic	search
RESTRICTION	X	X		
PROJECTION	X			
JOIN	X			
UNION	X			
INTERSECTION	X			
DIFFERENCE	X			
SEMIJOIN	X			
SEMIDIFFERENCE	X			
EXTEND			X	
AGGREGATE (AVG,SUM)			X	
AGGREGATE (MIN,MAX)		X		
SUMMARIZATION				
ORDER BY		X		
LIKE				X
FUNCTIONS			X	

---

## V. ORDER PRESERVING ENCRYPTION

As the requirements from the chapter before (IV-C) show, order preserving is an important property for many queries to work. If sensitive data is encrypted order preserving, many queries on the encrypted data are possible. As seen queries like “order by” or “>” “<” in the where clause could work on the encrypted data without changes. Other properties are dependent of the algorithm used, in some cases order preserving includes also format preserving, which means that all the advantages of format preserving encryption can be applied here too. If there is a one to one mapping between the plain text and the ciphertext, then even joins on the encrypted fields are possible without change of the data model or the queries. The drawback is that generally the more additional features an order preserving algorithm supports, the less secure it is. Other features, which require operations on the data like the aggregate functions “Sum” or “Average” are not supported directly. For these cases the whole data has to be decrypted before processing is possible.

Order preserving encryption can be seen also as a kind of property preserving encryption. The property that should be preserved is the order relation. If the plain text value  $v_1 > v_2$ , then the encrypted value  $v_1' > v_2'$  still holds. All order preserving ciphers presented here are symmetric. The reason for this is that for the uses of order preserving encryption, symmetric ciphers are more appropriate and not that asymmetric order preserving ciphers are impossible. Order preserving ciphers can have additional properties and constraints. Some of them work only for specific datatypes like numbers or strings, while others work for all. An order preserving cipher can be either deterministic or probabilistic (one to many), which has also great impact on usability and security. This section gives an overview of past and present order preserving encryption schemes. Some of these schemes are described more in detail than others, because they either had a significant impact on the development of order preserving encryption, they are the most practical or are the most secure currently available.

### A. Classical Schemes

Some of the classical ciphers are already order preserving, or can be easily made so. Although not practically from a security standpoint, these ciphers can show some insight on order preserving encryption. As they are easy to understand and implement, they can be used as simple test bed for any solution using order preserving encryption. Out of the box for example, Caesar cipher is not order preserving, because the last letters of the alphabet are encrypted as the first. For example a Caesar cipher with 3 as a key and only letters as the alphabet. For the letters A - W it is order preserving, but for X,Y,Z it is not because  $e(W) = Z$  and  $e(X) = A$  thus  $e(W) > e(X)$  is not correct. To make it order preserving

is easy, the range of the ciphertext is extended. X,Y, Z is mapped to additional characters like “:”, “,” and “;”. Another way is to support only range queries. Here the query is rewritten in such a way that the wrap-around case is taken into account. This shows an interesting point: Knowledge gained on such simple ciphers like the Caesar cipher can be used on much more complicated and more secure ciphers. In this case, the solution for range queries with the Caesar cipher is the same as for modular order encryption.

### B. Modern Encryption Schemes

Historically ciphers aside, it all started with the Hacigumus Scheme [41], then OPES [42], which created the term Order Preserving Encryption (OPE). After that, OPE [43], took a more formal approach to security, defining ciphertext indistinguishability for order preserving algorithms. Modular order preserving encryption [44] was the latest addition to order preserving ciphers, claiming the highest security level, while still being practically usable. Besides these ciphers many other encryption schemes were created in recent years. These ciphers are only described here on the surface. Some of them were only minor variations of existing ones, while other could not deliver the security they promised. The research of order preserving encryption is still very active, resulting in new schemes every year. Also more knowledge of the security of these ciphers is gained, but still the security of order preserving encryption is not as well understood as the security of standard block ciphers like AES. Thus most of the researchers warn of the use of these ciphers in practical applications, if the requirement for security is high. The following schemes are all order preserving. This is a non-exhaustive list of existing schemes and only an overview is given. For more details on these ciphers see the original publications as stated in the bibliography.

1) *Bucket Based Approach*: The encrypted relation differs from the unencrypted relation. The whole original tuple is stored in one attribute and for every searchable attribute an index attribute is added. Each index attribute does not contain the original value, but only the bucket value. Each bucket is a subset of the attribute domain. Two strategies for selecting the boundaries of the buckets are possible:

- equi-width. all buckets have the same range.
- equi-depth. all buckets contain the same number of items.

The disadvantage of the equi-width strategy is that the distribution of the attributes is revealed to the encrypted database. The downside of the equi-depth strategy is, that data changes requires updates of the bucket boundaries, so that all buckets still contain the same number of items [45]. To create a bucket value the domain of each attribute is split in buckets, mapping multiple values to one. To execute a query on the encrypted data the values in the

query are replaced by the corresponding bucket values. After receiving the data, it is filtered on the client to remove the spurious tuples. This makes queries on equality on the encrypted data possible, but as the buckets are not sorted, range queries are, depending on the domain either limited or not possible. Aggregation queries are possible too. While using an homomorphic encryption scheme leaks information as shown by [45], another approach is to predetermine aggregate functions like count and sum for each bucket. These attributes are stored encrypted together with the bucket id in the same way as normal index attributes [41].

TABLE VIII  
ORIGINAL TABLE (BUCKET)

CUSTOMERID	LASTNAME	AGE	INCOME
1	Miller	22	30000
2	Smith	54	90000
3	Hill	21	25000
4	Moore	77	35000

*Example:* The values are split to buckets:

Lastname: H -> 8 M ->13 S -> 19  
 Age: 21 - 30 -> 3 51 - 60 -> 6 71 -80 -> 8  
 Income: 0 - 25000 -> B 25001 - 50000 -> C 50001 -  
 75000 -> D 75001 - 100000 -> A

TABLE IX  
ENCRYPTED TABLE (BUCKET)

ID	TUPLE	I_LAST	I_AGE	I_INCOME
1	\$\$&%&/(%/&\$?"	13	3	C
2	%%\$%(\$%\$\$&/§	19	6	A
3	&(%%/\$/(\$"/%/(/	8	3	B
4	&%&)%(%%)%	13	8	C

TABLE X  
ENCRYPTED AGGREGATE TABLE (BUCKET)

BUCKET_ID	SUM	COUNT
A	enc(90000)	1
B	enc(25000)	1
C	enc(65000)	2
D	enc(0)	0

*Some example queries:*

*Value query:* client:

---

```
SELECT * FROM CUSTOMERS WHERE LASTNAME = 'Miller';
```

---

server:

---

```
SELECT TUPLE FROM CUSTOMERS WHERE I_LAST = 13;
```

---

client:

---

```
decrypt each TUPLE, filter by LASTNAME 'Miller'
```

---

*Limited range query:* client:

---

```
SELECT * FROM CUSTOMERS WHERE INCOME BETWEEN 20000  
AND 40000;
```

---

server:

---

```
SELECT TUPLE FROM CUSTOMERS WHERE I_INCOME = 'B' OR  
I_INCOME = 'C'
```

---

client:

---

```
decrypt each TUPLE, filter by INCOME between 20000  
and 40000
```

---

*Aggregate query:* client:

---

```
SELECT SUM(INCOME) FROM CUSTOMERS  
WHERE INCOME BETWEEN 20000 AND 50000;
```

---

server:

---

```
SELECT SUM FROM AGG_INCOME WHERE BUCKET_ID = 'C';  
SELECT TUPLE FROM CUSTOMERS WHERE I_INCOME = 'D';
```

---

client:

---

```
decrypt all tuples, filter by INCOME >= 20000,  
calculate sum  
decrypt sum from AGG_INCOME and add calculated sum
```

---

*Hash Based Approach:* This approach is very similar to the bucket approach but instead of splitting the domain of an attribute into buckets a one-way hash function is applied. If the hash function is not collision free then the spurious tuples have to be filtered in this approach, too. Queries on equality are supported, but range queries are not possible, because the hashes do not preserve the order of the original values.

*B+ Tree Approach:* This requires a more different schema than the previous approaches. Here the data is stored as a b+ tree. A vertex has a id and the content, which contains references to the lesser and to greater vertex and leaf nodes contain the links to the other nodes. This content is encrypted and to query the data, the tree has to be traversed by the decrypted vertexes until an leaf node is found. Although more steps for the retrieval are necessary, this makes range queries possible.

2) *OPES (Order Preserving Encryption Scheme):* The intuition behind this algorithm [42] is the following: Values from a user-specified distribution are generated, and sorted in a table. The index of an value in this table is the encrypted value. This table is the key. Decryption is a simple lookup in this table, which has the role of the encryption/decryption key. So the only thing revealed by the encrypted value is the order, which is exactly what is wanted. In reality, this is not practical, because the key is large, and every update can require a complete encryption. The goal of OPES is to construct an encryption function which has the same properties. OPES is the first order



preserving encryption scheme which is constructed with the relational data model in mind. OPES works in three stages:

- 1) Model. Input and target distributions are modeled as piece-wise linear splines. Here the data values are partitioned into buckets, and each bucket is as linear spline.
- 2) Flatten. The plain text values are transformed, so that the values are uniformly distributed. Values from a bucket are mapped to buckets with length proportional to the number of values.
- 3) Transform. The flattened values are mapped into the target distribution and then encrypted.

3) *OPE (Order Preserving Encryption):*

*Hypergeometric probability function:* There is a relation between a random order preserving function and hypergeometric probability distribution. Any order preserving function  $f$  from  $\{1, \dots, M\}$  to  $\{1, \dots, N\}$  can be represented by a combination of  $M$  out of  $N$  ordered items. This can be represented by a bin with  $N$  balls.  $M$  balls are black and  $N-M$  balls are white. The at each step a random ball without replacement is drawn. The random variable  $X$  is the number of black balls in the sample, after collecting the  $y$ -th ball. This variable has a hypergeometric distribution. The probability of  $X=x$  is given by

$$\frac{\binom{x}{y} \binom{N-y}{M-x}}{\binom{N}{M}}$$

If the  $y$ -th ball is black, then the least unmapped point of the domain is mapped to  $y$ . A simple example with a very small domain and range could be: domain  $D: [1,2,3]$  which is mapped to  $R: [1,2,3,4,5,6,7,8,9]$ . The experiment would be to withdraw random balls from the set. In this example the set would contain 3 black balls (elements from  $D$ ), and 6 white (elements from  $R$ )  $[*, *, *, o, o, o, o, o, o]$ . A possible random sequence of chosen balls could be  $\{o, o, *, *, o, *\}$ . The following steps are performed:

- 1)  $[*, *, *, o, o, o, o, o]$   $y = 1$ ,  $o$  is chosen.
- 2)  $[*, *, *, o, o, o, o, o]$   $y = 2$ ,  $o$  is chosen.
- 3)  $[*, *, *, o, o, o, o, o]$ ,  $y = 3$ ,  $*$  is chosen the least unmapped number of  $D$  is mapped  $[1 \rightarrow 3]$ .
- 4)  $[*, o, o, o, o, o]$ ,  $y = 4$ ,  $*$  is chosen, the least unmapped number of  $D$  is mapped  $[2 \rightarrow 4]$ .
- 5)  $[*, o, o, o, o]$ ,  $y = 5$ ,  $o$  is chosen.
- 6)  $[o, o, o, o]$ ,  $y = 6$ ,  $*$  is chosen, the least unmapped number of  $D$  is mapped  $[3 \rightarrow 6]$ .

As this is not efficient for real domains, a more efficient function is given by [43], which recursively samples a random order-preserving function. This makes the solution more practical, although the rationale stays the same [43, pp 3].

*Multiple messages and state:* As the independent encryption of multiple plaintexts would not be ordered, and keeping state of all encrypting messages is cumbersome, the state can be assumed as an static,

but random tape. To encrypt plain text  $x$ , the encryption algorithm performs a binary search of  $x$  by recursively calling the encryption with  $e(K, M/4)$  if  $m < M/2$  or with  $e(K, 3M/4)$  if greater. "Each ciphertext is made out of the hyper-geometric sampling algorithm and coins from an associated portion of the random tape, indexed by the plain text". A pseudo-random function can be created, to generate the tape dynamically. This function should be block cipher-based [43, pp 3].

*Encryption and decryption:*  $D = \text{Domain } \{1..M\}$ ,  $R = \text{Range } \{1..N\}$  plain text  $m \in [D]$ , ciphertext  $y \in [R]$  A Range gap is mapped to a domain gap. The algorithm is called with sets of the domain and the range. The start value for the range gap ( $y$ ) =  $N/2$ . After generating pseudo-random coins and giving them to the hypergeometric sampling function  $x$  is calculated. The number of values of the order preserving function which are less than  $y$  is the domain gap  $x$ . The  $m$ th point of the ciphertext is  $m$ . If  $m$  is less than  $x$  the encryption function is recursively called with the subset  $D\{d+1, x\}$  and  $R\{r+1, y\}$  or if greater with  $D\{x..d+M\}$  and  $R\{y..r+N\}$ . If the number of the domain is 1 the algorithm ends returning the ciphertext by choosing a point from the set as result. The decryption is very similar. At the end of the recursion if the ciphertext is in the range, the message  $m$  is returned as result. It is crucial for the algorithm to choose the right size of  $N$ . The goal is to have a large number of random order preserving functions. It is suggested by the authors, that  $N = 2M$ , which results in more than  $2^{80}$  functions.

<pre> EncK(D, R, m) 01 M ←  D  ; N ←  R  02 d ← min(D) - 1 ; r ← min(R) - 1 03 y ← r + [N/2] 04 If  D  = 1 then 05   cc ← TapeGen(K, 1<sup>len</sup>, (D, R, 1  m)) 06   c ← R 07   Return c 08 cc ← TapeGen(K, 1<sup>len</sup>, (D, R, 0  y)) 09 x ← HGD(D, R, y; cc) 10 If m ≤ x then 11   D ← {d + 1, ..., x} 12   R ← {r + 1, ..., y} 13 Else 14   D ← {x + 1, ..., d + M} 15   R ← {y + 1, ..., r + N} 16 Return EncK(D, R, m) </pre>	<pre> DecK(D, R, c) 17 M ←  D  ; N ←  R  18 d ← min(D) - 1 ; r ← min(R) - 1 19 y ← r + [N/2] 20 If  D  = 1 then m ← min(D) 21   cc ← TapeGen(K, 1<sup>len</sup>, (D, R, 1  m)) 22   w ← R 23   If w = c then return m 24   Else return ⊥ 25 cc ← TapeGen(K, 1<sup>len</sup>, (D, R, 0  y)) 26 x ← HGD(D, R, y; cc) 27 If c ≤ y then 28   D ← {d + 1, ..., x} 29   R ← {r + 1, ..., y} 30 Else 31   D ← {x + 1, ..., d + M} 32   R ← {y + 1, ..., r + N} 33 Return DecK(D, R, c) </pre>
--	--

Fig. 7. OPE Algorithm [43]

As already mentioned, order preserving encryption (OPE) is a encryption where the order of the cleartext is retained in the cipher text. It is crucial that only the order and no other information of the clear text is revealed in the cipher text. It is a kind of homomorphic encryption, where the homomorphic operation is order comparison [42], [43], [46].

4) *MOPE (Modular Order Preserving Encryption):* Modular OPE is a modification of order preserving

encryption [43]. It adds a secret modular offset to the plain text before encryption. The scheme is not strictly order preserving anymore, but it permits range queries. For the execution of a modular range query two cases have to be considered: The standard case occurs, if the range values are ordered  $c1 < c2$ . For this case, there is no difference between the execution on the plain text and the ciphertext. In the second case ( $c2 > c1$ ), also called the wrap around case, the query on the ciphertext differs: Here the query is executed with range  $[c1, M]$  and range  $[1, c2]$ . Consider the following simple example:  $D = [1,2,3,4,5,6]$   $M = 5$ ,  $R = [1,2,3,4,5,6,7]$ ,  $j = 2$ , the trivial OPE  $f(x) \rightarrow x + 1$ . The data is  $[1,2,2,3,4,5,5]$  the encrypted data is  $[4,5,5,6,1,2,2,2]$ .

- Standard query. select  $t.*$  from table  $t$  where  $t.a1$  between 1 and 3. The result is  $[1,2,2,3]$ . The offset is 2 so the lower bound 1 is encrypted as  $(1 + 2 \bmod 6) = \text{enc}(3) = 4$ . The upper bound 3 is encrypted as  $(3 + 2 \bmod 6) = 5 = 6$ . As  $4 < 6$  this is the standard case and the encrypted query is select  $t.*$  from table  $t$  where  $t.a1$  between 4 and 6. The encrypted result is  $[4,5,5,6]$  which is decrypted to  $[1,2,2,3]$ .
- Wrap around query. select  $t.*$  from table  $t$  where  $t.a1$  between 3 and 5. The offset is 2 again. The lower bound 3 is encrypted as  $(3 + 2 \bmod 6) = \text{enc}(5) = 6$  and the upper bound is  $(5 + 2) \bmod 6 = \text{enc}(1) = 2$ . As 6 is not  $< 2$  the query is rewritten to: select  $t.*$  from table  $t$  where  $t.a1$  between 6 and 7 union select  $t.*$  from table  $t$  where  $t.a1$  between 1 and 2. The encrypted result is  $[6]$  union  $[1,2,2,2]$  which is decrypted as  $[3]$  union  $[4,5,5,5]$  [44], [47].

5) *MV-POPES (Multivalued-Partial Order Preserving Encryption Scheme)*: The domain of the plain text is divided in multiple partitions which are randomized in the encryption domain. To enhance the security of OPE this scheme encrypts an integer to multiple different values. In each partition the encrypted values are ordered. Range queries have an higher overhead than in OPE. The overhead depends on the number of the partitions, but can be reduced with multilevel partitioning or binary recursive partitioning [48].

6) *mOPE (Mutable Order Preserving Encoding)*: This scheme is more a protocol, than a cipher. According to [49] it is defined as: “A mutable order-preserving encryption scheme for plain text domain  $D$  is a tuple of polynomial-time algorithms  $mOPE = (\text{KeyGen}, \text{InitState}, \text{Enc}, \text{Dec}, \text{Order})$  run by a client and a stateful server, where  $\text{KeyGen}$  is probabilistic and the rest are deterministic, and  $\text{Enc}$  is interactive.” It requires state on a server, and this state has to be mutable. Although more complicated than other order preserving solutions, it achieves the highest level of security for order preserving encryption IND-OPCA. This means that only the order, but nothing else is revealed about the encrypted values. The values are ciphered on the client with a symmetric cipher and stored in a search tree

on the server. The tree traversal for a value  $v$  is performed by these steps:

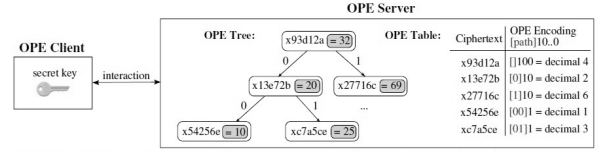

Figure 2. Overview of mOPE’s data structures. Each node in the OPE Tree contains a DET ciphertext (the hexadecimal value); for the reader’s information, the gray block shows the corresponding plaintext value, but this is not stored in the tree. Child pointers are labeled with 0 or 1 to indicate the path encoding.

Fig. 8. mOPE data structures [49]

*Request root from server:*

- 1) Decrypt value  $v$  on client as  $v'$ , if  $v < v'$  request left, if  $v' > v$  right from the server, if  $v = v'$  request found.
- 2) Repeat step 2 until  $v$  is found or empty returned.
- 3) The result is the path from the tree and whether the value was found.

*To insert a new value, the following steps are performed:*

- 1) Encrypt value  $v$  on the client.
- 2) OPE tree is traversed (as in the 1st algorithm), and inserted, possible balanced.
- 3) To query, the server finds the order in the tree of the encrypted value or the bounds and executes the query on the encrypted data using an user defined function (order).

7) *DOPE (Dynamic Order Preserving Encryption)*:

This scheme is a enhancement of mOPE. The main difference is, that the OPE tree is stored in the database by using an AVL tree [50].

8) *FH-OPE (Frequency Hiding Order Preserving Encryption)*: This scheme keeps local state of the plain text and the encrypted order. Only the ciphertext is sent to the server. The encryption is key-less, the security relies on the state of the algorithm. An update can potentially affect the complete ciphertext. It assumes uniformity of distribution of the plain text. For decryption only a lookup in the state tree is required. This scheme achieves better performance than the IND-OPCA Scheme, but the assumption of uniformity of the distribution is a significant constraint [51].

- IND-OPCA Scheme. This scheme requires statefulness. The state is encrypted in a tree data structure at the server and therefore the encryption process requires multiple requests between the client and the server. On the server the search tree is used to query the encrypted data. Additionally the complete ciphertext has to be updated after some time for not leaking the distribution of the plain text. If the plain text has uniform distribution, than no updates are required, but in reality, this is not often the case [52], [53].



9) *COPE (Chaotic Order Preserving Encryption)* : This cipher works only on a trusted database, as the data is decrypted and encrypted on the server. The transformation of the plain text values is performed in two steps: The goal of the first step is to hide the order of the plain text. The second step preserves the order to allow efficient queries.

- Random Shuffling. The domain of the data is partitioned in buckets. Each of these buckets has either descending or ascending order and the buckets are randomly mixed. To partition the domain, a number of random values is generated, where the order of the bucket is determined by the sequence. The order within the bucket can be either ascending or descending and is determined by the number of the bucket.
- Chaotic Beta-Expansion. The randomly shuffled database is transformed into an ordered ciphered database by using Beta-expansion. The encrypted values preserves the lexicographic order. This makes fast queries on the encrypted database possible [54].

10) *SOPE (Semi-Order Preserving Encryption)*: Although similar to order preserving encryption the resulting ciphertext is not strictly ordered, but only ordered to some degree. It is possible to encrypt two different values to the same ciphertext, which is not possible in OPE. If the encryption function is  $f(x) \rightarrow y$  and  $x_1 < x_2$ , then only the constraint  $y_1 \leq y_2$  and not  $y_1 < y_2$  is satisfied. The ciphertext space of SOPE can be divided in two sets: One that satisfies the order preserving condition, the other does not satisfy the condition. The ratio between these two sets measures the difference between OPE and SOPE. If all values are in the ordered set, it is in fact an OPE. The degree  $d$  is the sum of the probability of plain text encoded in the same value. A degree of 0 means that every plain text is encoded in a different ciphertext, while 1 means that at least 2 plaintexts are mapped to the same ciphertext. The higher the semi-order preserving degree is, the better is the security of the cipher. The drawback is that the error rate is higher, too. As different plaintexts are mapped to same values, the encryption has to keep state to make it possible to decrypt the value to the original value again [55].

11) *p-OPE (Probability-p Order Preserving Encryption)*: This is similar to the semi-order preserving encryption scheme. The resulting ciphertext is ordered, but only to a certain degree. Not all ciphertext values are in the correct order. If a query is executed on the encrypted data, the result can contain false positives (values which are not in the result of the query on the plain text) and it can even contain not all queried values (false negatives). The result of an query on encrypted data is not the same as the query on the cleartext data. The deviation of the correct result depends on the probability and it can be acceptable to loose some precision to gain

more security [56].

12) *New order preserving encryption model*: This OPE model sets the focus on outsourced databases in cloud environments. The goal is to be more secure than OPE, but also to avoid the performance penalty of secure OPE like IND-OCPA. The encryption scheme mitigates statistical attacks (the data distribution/ data frequency), which are the weak spot for OPE. To achieve this, the message space is extended. This can be done by two different ways. One way is to keep the type of the attribute but increase the precision. For example a real (8,4) can be enhance to a real(12,8). The other, more invasive way is to represent the number as string. The encryption is performed in different steps: 1) The message space is split. This destroys the data distribution. 2) The ciphertext space is split. 3) Each value is mapped to the ciphertext space. Both the encryption and decryption is run on the client [57].

13) *Order-Preserving Encryption Using Approximate Integer Common Divisors*: As other OPE schemes the ciphertext has to be significant larger than the plain text space. The security of this scheme is given by the general approximate common divisor problem. For additional security, the scheme can be used in conjunction with other OPE schemes like the original OPE [58].

14) *One-to-Many OPE*: Instead of mapping a plain text value to an encrypted value, each value is mapped to a bucket, and from this bucket a encrypted value is chosen randomly. This requires a significant larger ciphertext space, but the frequency of the plain text is hidden, because it is mapped to different values. Although the distribution is effectively hidden, an differential attack is still possible. Common values are mapped to the same bucket, which means that from this bucket many values are used, with little difference between them [59].

15) *NOPE (Noise Based Order Preserving Encryption)*: This encryption scheme generates a noised based encryption function for enhanced security [60].

16) *sOPE (Stateful Order Preserving Encryption)*: The encryption algorithm is separated between an order preserving and a symmetric key encryption part. A ciphertext  $c$  contains  $(c_1, c_2)$  where  $c_1$  is the ordered and  $c_2$  is the symmetric encrypted part. For  $c_1$ , a key point is that the the ratio of the partitions in the plain text and ciphertext space are the same. All values are stored in a table, and for encryption each value is looked up in this table. This table can be stored either on the client or on the server. For decryption only  $c_2$  is needed [52].

17) *TOPE (Top Order Preserving Encryption)*: This scheme is for retrieving the top relevant tuples, also called top-k queries. A simple example is the query “select max(a) from table”, which selects the max value of a column of a table . Another would be “select \* from table order by attr desc limit 10”, which selects the 10 tuples where a has the highest value. These queries can be executed over the encrypted data without revealing any

other information about the data (even the ordering of the non top-k data). The security is defined and proved with “indistinguishability under top-ordered chosen plain text” attacks. The schemes utilizes a partially ordered tree structure (heap) for min and max values. The values themselves are encrypted with a standard symmetric encryption cipher. While the encryption of the value itself never changes (permanent ciphertext), the top/min information has to be updated (transient ciphertext), if additional data is created, updated or deleted. The state of the heap is maintained on the server, while the encryption/decryption is done on the client. The state could be kept on the client too, but this would require a lot of local storage on the client, and if used on multiple clients multiple copies of the heap would exist. On the other hand, the key on the server could compromise security. A query is executed on the concatenated values of the transient and permanent ciphertext, and the result, the permanent value and or other attributes are retrieved and decrypted on the client [61].

### C. Security of Order Preserving Encryption

Pseudo Random Permutation (PRP) and Pseudo Random Function (PRF) are security notions. A common approach is the “Rank-then-Encipher Approach”: At first the rank of each plain text message is calculated, so that each plain text message has a rank. This rank is encrypted. The plain text message is replaced with the plain text message of the encrypted rank. To decrypt the rank of the decrypted message is calculated and encrypted. The message is replaced with the plain text of the decrypted rank [62], [63]. It is no secret, that security is the most important quality of a cipher. A cipher without security is pretty useless. Of course an unusable secure cipher is useless, too. So there is always an area of tension between security and usability. Ciphers without constraints or required properties like order or format are always potentially more secure than property preserving algorithms, because the attack surface is smaller. Another point is that standard (not property preserving) ciphers are much better researched and analyzed, because they are much more common and widespread than order preserving ciphers.

*ROPE (Random Order Preserving Encryption):* This is just a theoretical order preserving encryption scheme for comparison with a real one. It is used to describe an ideal order preserving encryption scheme. It is used in security analysis, to analyze which information is leaked from an order preserving encryption scheme [44].

*Ciphertext Indistinguishability:* Ciphertext Indistinguishability is a property of an encryption scheme. It means that an adversary cannot distinguish the ciphertext of two encrypted messages with the same length. If an adversary can distinguish the ciphertext with a probability significant greater than 0.5, the the encryption scheme is not secure in the terms of

indistinguishability.(wiki) The type of attack is specified for the distinguishability like indistinguishability under chosen plain text (IND-CPA), chosen ciphertext (IND-CCA) or another kind of attack.

*Definition CPA Security:* Let  $HE = \{Gen, Enc, Dec, Eval\}$  be an encryption scheme. Given any adversary  $A$ , we consider an experiment between the adversary  $A$  and the following challenger  $C$ :

- $C$  runs  $(pk, sk) \leftarrow Gen(1\kappa)$  and sends  $pk$  to the adversary  $A$ .
- $A$  selects two messages in the message space  $M$ , i.e.,  $(m_0, m_1) \in M \times M$ , and sends them to  $C$ .
- $C$  flips a uniformly random bit  $b \in \{0, 1\}$  and sends  $c^* \leftarrow HE.Enc(pk, m_b)$  to  $A$ . Here  $c^*$  is called the challenge ciphertext.
- $A$  outputs  $b' \in \{0, 1\}$ . We say  $A$  wins the game if  $b' = b$ , i.e.,  $A$  correctly finds out the bit  $b$  [3, pp 334].

Indistinguishability under chosen plain text attack (IND-CPA), also known as polynomial security is a strong security property for (asymmetric) encryption algorithms. Of course this can never be achieved by an order preserving encryption scheme, because as the order in the ciphertext is preserved, it is always possible to distinguish the ciphertext by simply comparing the order of the ciphertext. Indistinguishability under chosen ciphertext attack/adaptive chosen ciphertext attacks (IND-CCA1 / IND-CCA2) are even stronger security properties. Here additional to IND-CPA the adversary has access to the decryption oracle, meaning the adversary can encrypt and decrypt messages. IND-CCA1 restricts the access to decryption oracle to point where the two messages, which should be distinguished are received, while IND-CCA2 can access the encryption oracle even after receiving the messages. Of course it is not allowed to use the oracle on the messages received. Other weaker models exist too: IND-D CPA (Indistinguishability under distinct chosen plain text attack) for example is a weakened IND-CPA, requiring the adversary to only choose distinct messages. For order preserving encryption the following ciphertext indistinguishability models exist

- Indistinguishability under ordered chosen-plaintext attack (IND-OCPA). This is the ideal security model. No information other than the order is revealed.
- Indistinguishability Under Frequency-Analyzing Ordered Chosen Plaintext Attacks (IND-FA-OCPA). It is an generalization of IND-OCPA. According to [53] it is not achievable, but an achievable definition IND-FA-OCPA\* is suggested. Because of security concerns this kind of OPE is not recommended.
- Pseudo-random order-preserving function, security under chosen-ciphertext attack (POPF-CCA). Here the oracle access to the encryption algorithm of the order preserving encryption function and a random ordered encryption function are indistinguishable

under chosen ciphertext attacks. This security model is weaker than IND-OCPA. It is proven, that at least half of the bits of a plain text are leaked. According to Popa [49] this goal can only be achieved by statefulness on the client and ciphertext mutability. Ciphertext mutability means that when a new ciphertext value is added, existing ciphertext is updated [52].

- $\vartheta$ -lsb-KPA. In this model the secrecy of the fraction ( $\vartheta$ ) of the least significant bits is guaranteed under known plain text attacks.
- $\delta$ -IND-OCPA. A stronger security goal than  $\vartheta$ -lsb-KPA and for  $\delta = 1$  even IND-OPCA [52].
- random order-preserving function (ROPF). A random order preserving function is seen as an ideal object. If an order preserving function cannot not distinguished from this ideal object indistinguishability to ROPF is achieved [44].

*Security Notions for Order Preserving Encryption:*

- One-Wayness. This is a very fundamental security requirement. It states that it is not possible to recover the message from a ciphertext without the key. Of course this notion is not as strong as it seems, because even if the cleartext itself is not known, other information may be revealed [64].
- Window One-Wayness. This is a stronger security notion. The adversary is successful if the message is contained in an interval of cleartext. As an example the value 1000 is encrypted. If the given interval is 100 and the adversary finds the value is 960, it counts as successful decrypted [44].
- Window distance One-Wayness. This metric tries to quantify if the information of the distance between numbers of the plain text are revealed. For example if values 5 and 6 are ciphered, the order preserving encrypted values should reveal that  $e(6) > e(5)$  but not that the distance between  $e(5)$  and  $e(6)$  is 1.

*Security Models::* Leakage profiles show if and how much additional information is revealed by an encryption scheme. The following profiles exist [65], [64]:

- Ideal. Only the order of the ciphertexts is revealed. It hides any statistical information about the gaps between the messages.
- ROPF. Random order-preserving function: As later shown reveals at least half of the plain text bits.
- MSDB. Most-significant-differing bit profile: The most significant bit are allowed to leaked.
- TrM, MtR are other leakage profiles mentioned in literature [65, pp 4].

*Attack models::*

- Known ciphertext model. The attacker can only access the encrypted files without any additional background information.
- Known background model. The attacker has not only access to the encrypted data but also additional

information like statistical information about the data. If known which kind of data is stored, this can be used for statistical attacks.

Attacks on order revealing encryption [65]:

- Inter-column correlation-based attacks. As columns are often correlated, an attacker can attempt to reveal more information from multiple order revealing encrypted columns.
- Inter + intra-column correlation-based attack.

The following example shows the result of an attack on order revealing encryption. Although not one exact value is revealed, a lot insight to the data can be gained.

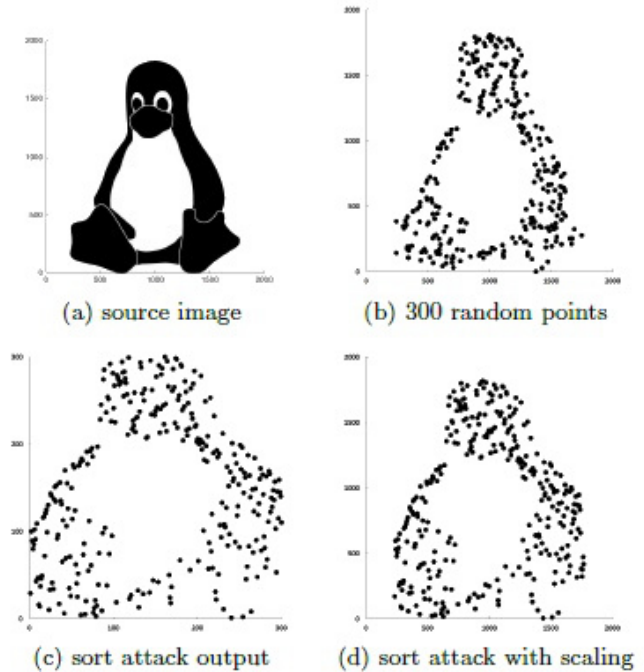

Fig. 9. 2D Attack [65, pp 5]

*Attack Scenario Order Preserving Encryption: Information Leakage:* If an attacker can insert new entries in the database via the application, it is possible that the order preserving encryption leaks information. In this simple example a row exists with salary data of an employee. Then the attacker creates a new record with the application, now he only has to query the (encrypted) database with a simple query like “select \* from employee order by salary desc” to know, if the target earns more than the created dummy employee. This can be continued until the exact salary is disclosed.

TABLE XI  
INFORMATION LEAK OPE

ID	Description	Salary (order preserving encrypted)
1	The target of the attack	9897899
2	Dummy Row with salary €5000 (created by attacker)	7866688
3	Other Rows	
...		

#### D. Summary of Security of Order Preserving Encryption

In [49] order preserving encryption schemes were analyzed regarding leakage besides order and any security guarantees given. To complete this chapter an overview of security and leakage beside order of some of the ciphers shown before, is given:

TABLE XII  
EXCERPT FROM COMPARISON OF CIPHERS IN [49]

Order-preserving scheme	Guarantees	Leakage besides order
Agrawal et al.'04 [42]	None	Yes
Boldyreva et al. [43]	ROPF [43]	§II-A Half of plain text bits
Lee et al.'09 [54]	None	Yes
Yum et al.'12 [40]	ROPF [43]	§II-A Half of plain text bits
Popa, et.al [49]	IND-OCPA	None

## VI. PROPERTY PRESERVING ENCRYPTION

Aside from order preserving encryption schemes there exist encryption schemes, which preserve other properties of a plaintext. Order preserving encryption, order revealing encryption, format preserving encryption, searchable encryption, prefix preserving encryption and even homomorphic encryption schemes can all be classified as property preserving encryption schemes. All of the following encryption schemes are property preserving encryption schemes. A property preserving cipher is optimal, if a certain property of the plain text remains in the ciphertext without revealing any additional information. At the end homomorphic encryption is presented. Homomorphic encryption makes it possible, to perform some operations like “plus” or “multiplication” on the encrypted data without decrypting it first. Homomorphic encryption is neither order preserving nor format preserving, but as arbitrary functions can be applied on the encrypted data, many useful properties can be implemented as functions. The cost of these operations is multiple magnitudes bigger than the operations on the plain text data, so although a very promising approach for future research, it is not ready for use for now.

#### A. FPE (Format Preserving Encryption)

Ciphertext normally does not meet the format constraints of an existing data model. Fuzzy queries, range queries and other SQL operations can not simply be executed over encrypted data. The usage of symmetric ciphers like AES results in binary strings regardless of the type or format in the database or application. Therefore the data

model and the application has to be changed. To avoid this, FPE preserves data type and length in ciphertext, so the existing schema of the database is still usable. Other characteristics of the data like order preserving, logical laws or domain specific checks are although possibly lost. All queries are the possible on a technical level, but range queries for example would not give the correct result, because operators like “>”, “<” are not valid for the encrypted data anymore. For such queries, the whole data has to be retrieved, decrypted and then processed, which can lead to a big overhead. If there are no such restrictions on the sensitive data fields, it can be a good solution for legacy systems, because the existing data model can be used without modification. The quality of the encryption is not only dependent on the algorithm but also by the length of the domain. Depending on the format, it is usually not as secure as the use of standard block ciphers like AES.

*Schemes* : According to [63], format preserving ciphers can be split based on the size of the space.

TABLE XIII  
TAXONOMY FORMAT PRESERVING ENCRYPTION [63]

setting	size	msg space
tiny-space FPE	$N \leq 2^{10}$	$X = [N]$
small-space FPE	$N \leq 2^{128}$	$X = \sum_n$
large-space FPE	$N \geq 2^{128}$	$X = \{0,1\}_n$

As seen in table XIII format preserving ciphers can be categorized by size and space. If  $N$  is sufficiently small, then it is acceptable to spend  $O(N)$  time for key setup or the first encryption. This is the easy case. If the message space is small like  $X = \sum_n$  for some arbitrary alphabet  $\sum$ , then a solution can often be based on Feistel networks. FFX is an example for such small-space FPE. The last category is large-space FPE. It is also called wide-block encryption. Standards are EME2 and XCB. For tiny spaces some simple and provably secure format preserving encryption schemes exist:

a) *Knuth shuffle (Fisher Yates shuffle)*: Shuffle a set of numbers  $[x_1..x_t]$  [66, pp 145].

- P1. Initialize, Set  $j \leftarrow t$ ,
- P2. Generate a random number  $U$  uniformly distributed between zero and one.
- P3. Exchange Set  $k \leftarrow [jU] + 1$ , exchange  $X_k \leftrightarrow X_j$ .
- P4. Decrease  $j$ . Decrease  $j$  by 1 if  $j > 1$ , return to step P2.

b) *Permutation numbering*: Map key  $K$  to a number  $k \in [N!]$  and encrypt with the  $k$ th permutation on  $[N]$  [63].

c) *Prefix cipher* : Use ordering of  $Ek(0)..Ek(N-1)$  to determine permutation. AES can be used for the encryption, to determine the order. As an output, a sorted table is created. This table can be used for table-driven encryption [63].

d) *FFX Algorithms*: NIST Special Publication 800-38G, “Recommendation for Block Cipher Modes of Operation” [67] specifies some methods for format

preserving encryption. This publication contains two recommendations for algorithms, which can be used for legacy applications, where the format can not be changed or to generally encrypt sensitive information while keeping the format. Both of them are based on a block cipher. Currently AES with key lengths of 128, 192 and 256 bits are supported. The main aspect of format preserving algorithms is that data is not necessarily binary and the encrypted text may not have the same length as the plain text. The alphabet (allowed symbols of the data) can be restricted, for example only numbers or certain letters could be allowed. FF1 and FF3 are the two recommended modes. They work like this: Each symbol is represented by a numeral, base is the number of the alphabet, denoted as radix. Two related function exist for encryption and decryption. For encryption, the input is the plain text given as numerical string (X) and a byte string as tweak (T), the resulting output is a numerical string Y of the same length as X. The decryption function has as input the encrypted numerical string and the tweak and as output the plain text as numerical string. For the same tweak the decryption function is the inverse of the encryption function. A tweak does not have to be a secret, it can be data associated to the plain text. Although not mandatory variable tweaks enhance the security, because the chance of identical encryptions of the identical values is reduced. Both algorithms, FF1 and FF3 are based on the Feistel structure (10). The Feistel structure consists of several iterations, called rounds, of a reversible transformation.

*Outline of FF3:*

- Split data in two parts.
- Apply a function on one part of the data to modify the other part.
- Swap roles for the next round.

In 10 four rounds of the transformation are shown.

1) *Length Limits of Modes:*

2) *FF1* : The allowed parameters for FF1 are: radix:  $[2..2^{16}]$  and  $\text{radix}^{\text{minlen}} > 100$ , but much higher values are recommended resulting in the range of  $2 < \text{minlen} < \text{maxlen} < 2^{32}$ .

3) *FF3*: The allowed parameters for FF3 are radix:  $[2..2^{16}]$  and  $\text{radix}^{\text{minlen}} > 100$  and the possible values are:  $2 < \text{minlen} < \text{maxlen} < 2[\log.\text{radix}(2^{96})]$ .

4) *IFX*: IFX is also based on a Feistel network as the FFX algorithms but supports non uniform data. For example, part of data can be numeric and the rest can be a string [67].

*B. Order Revealing Encryption (ORE)*

Here the ordering is not preserved, but there exists a comparison function which reveals the order of any two ciphertexts. Instead of using  $<$  for comparison, this user defined comparison function is used. It is IND-COPA secure, but has a big performance penalty. Practical ORE schemes reveal information about the relative distance of the plain text [52].

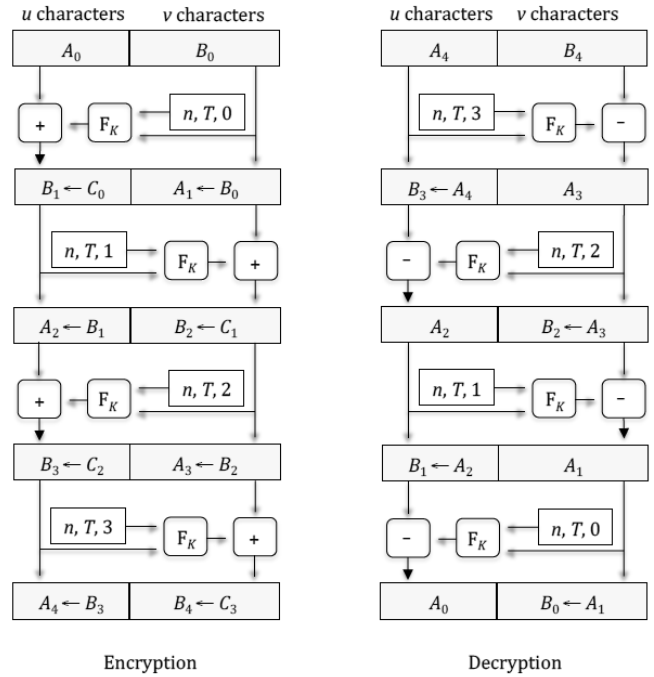

Fig. 10. Feistel Structure [67, pp 10]

*C. Searchable Encryption*

The ciphertext can be searched with an encrypted search term without decrypting the ciphertext. Searchable encryption can be seen a special case of functional encryption. Not a cipher, but another approach is this: Additional fields are used to store keyword ciphertexts for fuzzy queries. For each encrypted field in the database an additional keyword field is added. On enciphering string data it generates an keyword string which represents all sub strings of the data. After that this string is encrypted and stored in the keyword field. During the query it transforms the original query into combinations of terms, and searches in the keyword field and not in the original data field [68], [62].

*D. Prefix Preserving Encryption*

This is just a variant of searchable encryption: The ciphertext can be searched by prefix in the same way like the plaintext.

*E. Deterministic Encryption*

The same plain text is always encrypted to the same ciphertext. AES CBC mode is an example of deterministic encryption.

*F. Commutative Encryption*

The order of two encryptions and decryptions on the same plain text is not relevant.  $e1(e2(P)) == e2(e1(P))$ ,  $d1(d2(C)) == d2(d1(C))$

---

### G. Homomorphic Encryption

According to [24] homomorphic encryption is defined as “An encryption mechanism  $E$  is called homomorphic basically if it preserves certain algebraic structure between the plain text space and the ciphertext space, where the encryption key is fixed.” Homomorphic encryption makes it possible, to execute operations on cipher text and after decryption these operations are visible on the clear text. An example for this is RSA, where the product of two ciphertexts is a valid encryption of the product of the corresponding plaintexts. Fully homomorphic encryption (FHE) [69], [70], [71], [72], [73], [74] is a special kind of homomorphic encryption, where two operations, addition and multiplication in any number and any order are supported. This makes it possible to preserve the (algebraic) ring structure of the plain text and by supporting these two operations any computable function can be evaluated on encrypted values. An important application of such an encryption scheme in the context of a database is to apply aggregate functions like sum or average directly on encrypted data, without ever revealing the plain text. Some homomorphic encryption schemes exist:

- El Gamal Encryption Scheme [3, pp 308].
- Paillier Encryption Scheme [3, pp 309].
- BGN (Boneh, Goh, and Nissim) Encryption Scheme [3, pp 311]. Addition and Multiplication is supported, but only one multiplication.
- GSW (Gentry Sahai Waters) Encryption scheme (fully homomorphic).

Fully homomorphic encryption has a big performance penalty. It is up to 1000000x slower than without encryption. Although improved, practical use is still not possible due to the limited performance [75].

### H. Functional Encryption

In contrast to the previous ciphers, this is an asymmetric encryption scheme. Normal ciphers have no way to reveal only a particular information about the plain text. Functional encryption gives a more fine grained access to information. With a master key the ciphertext is still decrypted to the plain text. Additionally to this master key a kind of sub-key exists. With this key the ciphertext cannot be decrypted, but an associated function can be performed with this key on the ciphertext, only revealing a special property of the plain text and not the whole plain text itself [3], [76, pp 315].

## VII. OTHER SOLUTIONS

### A. Eperi Gateway

Eperi Data Protection for Databases<sup>3</sup> is an approach to store only encrypted data in the database. For processing, the data is decrypted by stored procedures so the cleartext

is in memory of DB-Server, thus providing no real end-to-end encryption. The encryption and decryption is transparent to an application, so the application does not have to be changed. Eperi gateway itself provides a lot more features. It is the central point for accessing and retrieving data from the cloud. It supports transparent encryption/decryption for different types of data and documents. A disadvantage of this central gateway approach is, that as all traffic to the cloud comes and goes through the gateway. Thus, it can be a performance bottleneck and a single point of failure [77].

### B. Relational cloud

Relational cloud<sup>4</sup> is a project from MIT to explore and enhance technology of the database as a service (DBaaS) model in cloud computing. The vision of Relational cloud is to provide access to all features of a DBMS without the need to manage hardware, software and privacy. Relational cloud consists of multiple nodes running a single database server. Applications communicate by their standard interfaces like JDBC. A special driver is used to connect to the front-end to ensure data is kept private. A router is consulted by the front end to analyze the queries and it determines the execution nodes [78].

### C. CryptDB

CryptDB [79] is a database management system, which can execute SQL queries over encrypted data. It follows an SQL-aware encryption strategy and evaluates the query directly on the server. The client must only decrypt the results and does not need to perform any query processing. The encryption can be completely transparent to an application, as long as the provided client front-end is used. CryptDB uses order preserving and homomorphic encryption.

The goal of CryptDB is to be as secure as possible, while still providing practical access to the database. However, CryptDB's security was analyzed and some successful attacks were revealed:

- LP-optimization. Based on combinatorial optimization techniques, this attack targets deterministic encryption schemes.
- Sorting attack. This attack decrypts order preserving encrypted columns. It works on dense sets, where nearly every value exists in the database.
- Cumulative attack. Another attack on order preserving encrypted columns. It works even on low-density columns by using combinatorial optimization techniques.

According to [80], there exist some CryptDB based or at least inspired solutions:

- Monomi [80]. It is based on the design of CryptDB but with a focus on analytical queries. It runs queries on encrypted data on top of the PostgreSQL database.

<sup>3</sup><http://eperi.de/produkte/database-encryption/>

<sup>4</sup><http://relationalcloud.com>

---

For the execution of complex queries, it uses the split client/server approach (similar to [41]), where part of the query is executed on the encrypted data on the server, and another part of the query is executed on the decrypted data on the client.

- Microsoft’s Always Encrypted SQL Server [81].
- Encrypted Bigquery<sup>5</sup>. It is a cloud service for analysis of large data-sets from Google storage. For queries it uses an SQL dialect. Encrypted BigQuery is an extension to the Bigquery client, which is capable of client-side encryption for a subset of query types.
- Skyhigh Networks<sup>6</sup>. McAfee Skyhigh Security Cloud is a cloud access security broker (CASB). This software sits between cloud service consumers and cloud service providers to enforce security, compliance, and governance policies for cloud applications. Among tons of other features, it supports encryption schemes for transparent encrypting of data going through the broker into the cloud. The Skyhigh Security Cloud supports, besides regular symmetric encryption schemes, format-preserving and searchable encryption schemes. Among other schemes, order preserving encryption is supported too.

#### D. DiCE - A Data Encryption Proxy for the Cloud

Order-preserving encryption algorithms range from simple algorithms like Caesar encryption to secure algorithms like mOPE [49]. In order to be able to use these algorithms as easy as possible, DiCE [82] a JDBC driver was developed<sup>7</sup>, that parses SQL queries as a proxy and transparently encrypts and decrypts these queries. This allows to execute many queries on an encrypted database in the cloud with (nearly) the performance as on unencrypted databases. The DiCE driver can be used with any other JDBC driver and therefore supports a variety of databases. The driver can be configured to support different encryption algorithms.

This research was motivated by our experience with large scale data stores [83] and complex applications in Grids and Clouds [84], [85], [86], [87], and strongly motivated by our focus on Web-based workflow optimizations [88], [89] and their respective management [90].

#### E. SecureDBaaS

SecureDBaaS [91] differs from other solutions on the application level (e.g. DiCE [82]), that it does not need a proxy to store metadata. Instead all metadata is stored encrypted on the server to avoid scalability issues. Features of SecureDBaaS are

- guaranteed confidentiality by allowing concurrent SQL over encrypted data,

- same availability, elasticity and scalability as unencrypted database as a service,
- concurrent access from distributed clients,
- no trusted broker or proxy required, and
- compatible with most relational Databases. It is possible to use existing database servers like PostgreSQL or MS SQL Server.

#### F. CipherCloud

CipherCloud<sup>8</sup> works as gateway which intercepts any traffic between a database and its clients. In fact, it uses an enhanced JDBC driver and supports format preserving encryption. It works with Amazon RDS as a database in the cloud [92].

#### G. Voltage Secure

Voltage Secure<sup>9</sup> provides another solution for Amazon relational database service. Unlike CipherCloud it provides its service for applications in the elastic cloud although with external key management. Similar to CipherCloud, it is possible with this solution to query over encrypted data [92].

#### H. Perspecsys

CloudSOC [21] is a cloud access security broker (CASB). Part of it (Symantec Cloud Data Protection & Security) provides encryption schemes for the data stored in the cloud. Additionally to the standard schemes, it supports different functionality (including order) preserving encryption schemes.

## VIII. CONCLUSION AND OUTLOOK

Collecting and storing only the minimal required data seems obvious, but often it is not. The GDPR makes data minimization of personal data a principle and from a security point of view this makes absolutely sense. Never collected data does not have to be stored, maintained and protected. But there are enough systems, where sensible data is definitely needed. Here it is crucial to make this classification as sensible data explicit. Without this knowledge, it is impossible to protect it accordingly. Mixing sensitive with non sensitive data is also a bad idea, because then everything has to be handled as sensitive data and this comes with an overhead. Often it is good practice to separate sensitive tables or even systems from non sensitives, but this will work only if considered from the start. This report discussed many ciphers, with different properties and different strength of security. It is recommended to always go for the best matching cipher regarding security requirements and needed functionality, even if that means to use multiple different ciphers. Here, the use of the smallest common denominator is definitely no good idea, as there is no perfect cipher which is best for all use cases. Ciphers with specific properties required for

<sup>5</sup><https://github.com/google/encrypted-bigquery-client>

<sup>6</sup><https://www.skyhighsecurity.com>

<sup>7</sup><https://github.com/dicejk/dice>

<sup>8</sup><http://www.ciphercloud.com/>

<sup>9</sup><https://voltage.com>

queries on encrypted data are available and usable. Order preserving encryption schemes with best possible security exist, but they are still not as secure as algorithms without additional properties. It is important to know, that these ciphers are relatively new and not analyzed in depth like standard algorithms as AES for example. Of course often not optimal encryption is better than none, but it is important to know the weaknesses of these ciphers. As a result, is not recommended to use any non standard encryption schemes for high classified data. The use of these ciphers also does not come for free. There is a certain overhead by embedding the encryption in a JDBC driver compared to using the native JDBC driver of the database directly. The reason for this is that much more processing has to be done before sending the query to the server. The SQL statement has to be parsed, encrypted and sometimes rewritten before it is forwarded to the real driver. The results of a query have to be parsed and decrypted again. The performance results show that the response time is significant higher, but by simulating multiple simultaneous queries the impact on the throughput is not as dramatic. Compared with the naive approach, by not enabling joins or indices on the encrypted data the result is clear: The naive approach is simple not working for anything but toy projects. Of course it can not repeated more often that security is more than encryption, and a lot more than encrypting the database has to be done to achieve security. Using the database as service solutions from AWS and Azure worked like a charm. It literally takes only 5 minutes and a database is up and running and available for operation. Network access and speed is definitely an issue. For example the data setup for evaluation took some time to get it into the cloud.

Optimal order preserving encryption is here, but it has to prove itself over the next years. As of today no high quality standard implementation like for example for AES exist. This will hopefully change soon. The big elephant in the room is fully homomorphic encryption, and future will show if it is possible to develop a secure and well performing cipher. If it is possible to achieve this, the impact goes far beyond database encryption, because then it would be possible to directly operate on the encrypted data and move the whole data processing in the cloud, too. Quantum computing could be a disruptive technology for many ciphers, which are currently believed to be secure. The adoption of cloud computing is continuing to grow, but as more and more important services rely on it, it seems very likely that more legislative control will be applied to it. Privacy and security in and outside the cloud will be more important than ever, and legislative regulation like GDPR will become more and more relevant.

## REFERENCES

- [1] P. M. Mell and T. Grance, "Sp 800-145. the nist definition of cloud computing," National Institute of Standards & Technology, Gaithersburg, MD, United States, Tech. Rep., 2011.
- [2] S. Leimeister, C. Riedl, M. Böhm, and H. Krcmar, "The business perspective of cloud computing: Actors, roles, and value networks," in *Proceedings of 18th European Conference on Information Systems (ECIS 2010)*, Pretoria, South Africa, 2010. [Online]. Available: <http://home.in.tum.de/~riedlc/res/LeimeisterEtAl2010-preprint.pdf>
- [3] J. R. Vacca, *Cloud Computing Security: Foundations and Challenges*. Boca Raton, FL, USA: CRC Press, Inc., 2016.
- [4] N. K. Sehgal and P. C. Bhatt, *Cloud Computing*. Springer International Publishing, 2018.
- [5] I. M. Khalil, A. Khreishah, and M. Azeem, "Cloud computing security: A survey," *Computers*, vol. 3, no. 1, pp. 1–35, 2014.
- [6] L. Stadtmueller, "Are cloud managed services the right financial choice for your business? an executive brief sponsored by ibm," 2017. [Online]. Available: [https://www.inxero.com/channels/flagshipsg-com/showcase/2422-managed-services?resource\\_mapping\\_id=28325](https://www.inxero.com/channels/flagshipsg-com/showcase/2422-managed-services?resource_mapping_id=28325)
- [7] H. Hacigumus, B. Iyer, and S. Mehrotra, "Providing database as a service," in *Proceedings of the 18th International Conference on Data Engineering*, ser. ICDE '02. Washington, DC, USA: IEEE Computer Society, 2002, pp. 29–. [Online]. Available: <http://dl.acm.org/citation.cfm?id=876875.879015>
- [8] W. Neu, "Role of the dba when moving to amazon rds: Responsibilities," 11 2017. [Online]. Available: <https://aws.amazon.com/blogs/database/part-1-role-of-the-dba-when-moving-to-amazon-rds-responsibilities/>
- [9] N. Ferguson, B. Schneier, and T. Kohno, *Cryptography Engineering: Design Principles and Practical Applications*. Wiley Publishing, 2010.
- [10] B. Schneier, *Secrets & Lies: Digital Security in a Networked World*, 1st ed. New York, NY, USA: John Wiley & Sons, Inc., 2000.
- [11] E. McCallister, T. Grance, and K. A. Scarfone, "Sp 800-122," *Guide to Protecting the Confidentiality of Personally Identifiable Information (PII)*, National Institute of Standards & Technology, Gaithersburg, MD, 2010.
- [12] K. Hänsch and L. Serna, "Directive 95/46/ec of the european parliament and of the council of 24 october 1995 on the protection of individuals with regard to the processing of personal data and on the free movement of such data, nov. 1995."
- [13] P. V. A. von dem Bussche, *EU-Datenschutz-Grundverordnung (DSGVO)*. Springer-Verlag Berlin Heidelberg, 2018.
- [14] P. Voigt and A. v. d. Bussche, *The EU General Data Protection Regulation (GDPR): A Practical Guide*, 1st ed. Springer Publishing Company, Incorporated, 2017.
- [15] K. A. Scarfone, W. Jansen, and M. Tracy, "Sp 800-123. guide to general server security," National Institute of Standards & Technology, Gaithersburg, MD, United States, Tech. Rep., 2008.
- [16] B. Schneier, *Applied cryptography (2nd ed.): protocols, algorithms, and source code in C*. New York, NY, USA: John Wiley & Sons, Inc., 1995.
- [17] L. R. Knudsen, *Block Ciphers — A Survey*. Berlin, Heidelberg: Springer Berlin Heidelberg, 1998, pp. 18–48. [Online]. Available: [https://doi.org/10.1007/3-540-49248-8\\_2](https://doi.org/10.1007/3-540-49248-8_2)
- [18] W. Ertel, *Angewandte Kryptographie*. Hanser, 2007.
- [19] K. Schmech, *Kryptografie: Verfahren, Protokolle, Infrastrukturen*, ser. iX Edition. Dpunkt.Verlag GmbH, 2009.
- [20] B. Schneier, *Angewandte Kryptographie.: Protokolle, Algorithmen und Sourcecode in C.*, ser. Reihe Informationssicherheit. Addison-Wesley, 1996.
- [21] Symantec, "Data privacy and compliance in the cloud." [Online]. Available: <https://www.symantec.com/content/dam/symantec/docs/white-papers/data-privacy-and-compliance-in-the-cloud-en.pdf>
- [22] Visa, "Visa best practices for tokenization version 1.0," 7 2010. [Online]. Available: <https://usa.visa.com/dam/VCOM/global/support-legal/documents/bulletin-tokenization-best-practices.pdf>
- [23] P. G. Alexandra Boldyreva, "The cloud encryption handbook: Encryption scheme and their relative strengths and weaknesses."
- [24] H. C. A. van Tilborg and S. Jajodia, Eds., *Encyclopedia of Cryptography and Security, 2nd Ed*. Springer, 2011.



- [25] R. B. Natan, *Implementing Database Security and Auditing: Includes Examples for Oracle, SQL Server, DB2 UDB, Sybase*. Newton, MA, USA: Digital Press, 2005.
- [26] R. Spenneberg, "Ipsec howto." [Online]. Available: <http://www.ipsec-howto.org/>
- [27] D. Cherry, *Securing SQL Server: Protecting Your Database from Attackers*. Elsevier Science, 2012.
- [28] Microsoft, "Transparent data encryption (tde) sql server 2012," <http://technet.microsoft.com/en-us/library/bb934049.aspx>.
- [29] H.-W. Fabry, "Daten verschlüsseln mit transparent data encryption (tde)," ORACLE Deutschland GmbH. [Online]. Available: <http://www.oracle.com/webfolder/technetwork/de/community/dbadmin/tips/tde/index.html>
- [30] L. S. Nishad, Akriti, J. Paliwal, R. Pandey, S. Beniwal, and S. Kumar, "Security, privacy issues and challenges in cloud computing: A survey," in *Proceedings of the Second International Conference on Information and Communication Technology for Competitive Strategies*, ser. ICTCS '16. New York, NY, USA: ACM, 2016, pp. 47:1–47:7. [Online]. Available: <http://doi.acm.org/10.1145/2905055.2905253>
- [31] I. Amazon Web Services, "Aws security best practices," 2016. [Online]. Available: [https://d1.awsstatic.com/whitepapers/Security/AWS\\_Security\\_Best\\_Practices.pdf](https://d1.awsstatic.com/whitepapers/Security/AWS_Security_Best_Practices.pdf)
- [32] R. Chow, P. Golle, M. Jakobsson, E. Shi, J. Staddon, R. Masuoka, and J. Molina, "Controlling data in the cloud: Outsourcing computation without outsourcing control," in *Proceedings of the 2009 ACM Workshop on Cloud Computing Security*, ser. CCSW '09. New York, NY, USA: ACM, 2009, pp. 85–90. [Online]. Available: <http://doi.acm.org/10.1145/1655008.1655020>
- [33] CSA, "The treacherous 12 cloud computing top threats in 2016," 2016. [Online]. Available: <https://downloads.cloudsecurityalliance.org/assets/research/top-threats/Treacherous-12Cloud-ComputingTop-Threats.pdf>
- [34] A. V. Katerina Lourida<sup>1</sup>, Antonis Mouhtaropoulos<sup>2</sup>, "Assessing database and network threats in traditional and cloud computing," *International Journal of Cyber-Security and Digital Forensics (IJCSDF) 2(3)*: 1-17 The Society of Digital Information and Wireless Communications, 2013 (ISSN: 2305-0012).
- [35] M. Jouini, L. B. A. Rabai, and A. B. Aissa, "Classification of security threats in information systems," *Procedia Computer Science*, vol. 32, pp. 489–496, 2014.
- [36] OWASP, "Threat risk modeling." [Online]. Available: [https://www.owasp.org/index.php/Threat\\_Risk\\_Modeling](https://www.owasp.org/index.php/Threat_Risk_Modeling)
- [37] Q. Yaseen and B. Panda, "Knowledge acquisition and insider threat prediction in relational database systems," *2013 IEEE 16th International Conference on Computational Science and Engineering*, vol. 3, pp. 450–455, 2009.
- [38] —, "Tackling insider threat in cloud relational databases," *Utility and Cloud Computing, IEEE International Conference on*, vol. 0, pp. 215–218, 2012.
- [39] S. Foresti, *Preserving Privacy in Data Outsourcing*, ser. Advances in Information Security. Springer US, 2010.
- [40] C. J. Date, *SQL and Relational Theory: How to Write Accurate SQL Code*. O'Reilly Media, Inc., 2011.
- [41] H. Hacigumus, B. Iyer, C. Li, and S. Mehrotra, "Executing sql over encrypted data in the database-service-provider model," in *Proceedings of the 2002 ACM SIGMOD international conference on Management of data*, ser. SIGMOD '02. New York, NY, USA: ACM, 2002, pp. 216–227. [Online]. Available: <http://doi.acm.org/10.1145/564691.564717>
- [42] R. Agrawal, J. Kiernan, R. Srikant, and Y. Xu, "Order preserving encryption for numeric data," in *Proceedings of the 2004 ACM SIGMOD international conference on Management of data*, ser. SIGMOD '04. New York, NY, USA: ACM, 2004, pp. 563–574. [Online]. Available: <http://doi.acm.org/10.1145/1007568.1007632>
- [43] A. Boldyreva, N. Chenette, Y. Lee, and A. O'Neill, "Order-Preserving Symmetric Encryption," in *Proceedings of the 28th Annual International Conference on Advances in Cryptology: the Theory and Applications of Cryptographic Techniques*, ser. EUROCRYPT '09. Berlin, Heidelberg: Springer-Verlag, 2009, pp. 224–241. [Online]. Available: [http://dx.doi.org/10.1007/978-3-642-01001-9\\_13](http://dx.doi.org/10.1007/978-3-642-01001-9_13)
- [44] A. Boldyreva, N. Chenette, and A. O'Neill, "Order-preserving encryption revisited: Improved security analysis and alternative solutions," in *Advances in Cryptology – CRYPTO 2011*, P. Rogaway, Ed. Berlin, Heidelberg: Springer Berlin Heidelberg, 2011, pp. 578–595.
- [45] E. Mykletun and G. Tsudik, "Aggregation queries in the database-as-a-service model," in *20th Annual IFIP WG 11.3 Working Conference on Data and Applications Security on Data and Applications Security XX - Volume 4127*. New York, NY, USA: Springer-Verlag New York, Inc., 2006, pp. 89–103. [Online]. Available: [https://doi.org/10.1007/11805588\\_7](https://doi.org/10.1007/11805588_7)
- [46] H. Mengke, "Key-controlled order-preserving encryption," pp. 1–5, 2010. [Online]. Available: <http://eprint.iacr.org/2010/268>
- [47] C. Mavroforakis, N. Chenette, A. O'Neill, G. Kollios, and R. Canetti, "Modular order-preserving encryption, revisited," in *Proceedings of the 2015 ACM SIGMOD International Conference on Management of Data*, ser. SIGMOD '15. New York, NY, USA: ACM, 2015, pp. 763–777. [Online]. Available: <http://doi.acm.org/10.1145/2723372.2749455>
- [48] H. Kadhemi, T. Amagasa, and H. Kitagawa, "Optimization techniques for range queries in the multivalued-partial order preserving encryption scheme," in *Knowledge Discovery, Knowledge Engineering and Knowledge Management*, A. Fred, J. L. G. Dietz, K. Liu, and J. Filipe, Eds. Berlin, Heidelberg: Springer Berlin Heidelberg, 2013, pp. 338–353.
- [49] R. A. Popa, F. H. Li, and N. Zeldovich, "An ideal-security protocol for order-preserving encoding," in *2013 IEEE Symposium on Security and Privacy*, 5 2013, pp. 463–477.
- [50] K. S. Reddy and S. Ramachandram, "A novel dynamic order-preserving encryption scheme," in *2014 First International Conference on Networks Soft Computing (ICNSC2014)*, 8 2014, pp. 92–96.
- [51] F. Kerschbaum and A. Schroepfer, "Optimal average-complexity ideal-security order-preserving encryption," in *Proceedings of the 2014 ACM SIGSAC Conference on Computer and Communications Security*, ser. CCS '14. New York, NY, USA: ACM, 2014, pp. 275–286. [Online]. Available: <http://doi.acm.org/10.1145/2660267.2660277>
- [52] K. S. Kim, M. Kim, D. Lee, J. H. Park, and W.-H. Kim, "Security of stateful order-preserving encryption," in *Information Security and Cryptology – ICISC 2017*, H. Kim and D.-C. Kim, Eds. Cham: Springer International Publishing, 2018, pp. 39–56.
- [53] M. Maffei, M. Reinert, and D. Schröder, "On the security of frequency-hiding order-preserving encryption," in *Cryptography and Network Security*, S. Capkun and S. S. M. Chow, Eds. Cham: Springer International Publishing, 2018, pp. 51–70.
- [54] S. Lee, T.-J. Park, D. Lee, T. Nam, and S. Kim, "Chaotic order preserving encryption for efficient and secure queries on databases," *IEICE transactions on information and systems*, vol. 92, no. 11, pp. 2207–2217, 2009.
- [55] C. Yang, W. Zhang, and N. Yu, "Semi-order preserving encryption," *Information Sciences*, vol. 387, pp. 266 – 279, 2017. [Online]. Available: <http://www.sciencedirect.com/science/article/pii/S0020025516320503>
- [56] C. Yang, W. Zhang, J. Ding, and N. Yu, "Probability-p order-preserving encryption," in *Cloud Computing and Security: Third International Conference, ICCCS 2017, Nanjing, China, June 16-18, 2017, Revised Selected Papers, Part II 3*. Springer, 2017, pp. 16–28.
- [57] Z. Liu, X. Chen, J. Yang, C. Jia, and I. You, "New order preserving encryption model for outsourced databases in cloud environments," *Journal of Network and Computer Applications*, vol. 59, pp. 198 – 207, 2016. [Online]. Available: <http://www.sciencedirect.com/science/article/pii/S1084804514001350>
- [58] J. Dyer, M. Dyer, and J. Xu, "Order-preserving encryption using approximate integer common divisors," *CoRR*, vol. abs/1706.00324, 2017. [Online]. Available: <http://arxiv.org/abs/1706.00324>
- [59] K. Li, W. Zhang, C. Yang, and N. Yu, "Security analysis on one-to-many order preserving encryption-based cloud data search,"

- IEEE Transactions on Information Forensics and Security*, vol. 10, no. 9, pp. 1918–1926, 9 2015.
- [60] R. T. Santi Martinez, Josep M. Miret and M. Valls, “Security analysis of order preserving symmetric cryptography,” *Applied Mathematics & Information Sciences*, 2013.
- [61] H. Quan, B. Wang, Y. Zhang, and G. Wu, “Efficient and secure top-k queries with top order-preserving encryption,” *IEEE Access*, vol. 6, pp. 31 525–31 540, 2018.
- [62] M. Bellare, T. Ristenpart, P. Rogaway, and T. Stegers, “Format-preserving encryption,” Cryptology ePrint Archive, Report 2009/251, 2009.
- [63] P. Rogaway, “A synopsis of format-preserving encryption,” 2010.
- [64] N. Chenette, K. Lewi, S. A. Weis, and D. J. Wu, “Practical order-revealing encryption with limited leakage,” Cryptology ePrint Archive, Report 2015/1125, 2015.
- [65] F. B. Durak, T. M. DuBuisson, and D. Cash, “What else is revealed by order-revealing encryption?” in *Proceedings of the 2016 ACM SIGSAC Conference on Computer and Communications Security*, ser. CCS ’16. New York, NY, USA: ACM, 2016, pp. 1155–1166. [Online]. Available: <http://doi.acm.org/10.1145/2976749.2978379>
- [66] D. E. Knuth, *The Art of Computer Programming, Volume 2 (3rd Ed.): Seminumerical Algorithms*. Boston, MA, USA: Addison-Wesley Longman Publishing Co., Inc., 1997.
- [67] D. Morris, “Recommendation for block cipher modes of operation: methods for formatpreserving encryption,” *NIST Special Publication*, vol. 800, p. 38G, 2013.
- [68] Z. Liu, C. Jia, J. Yang, and K. Yuan, “Format-preserving fuzzy query mechanism,” *2013 Fourth International Conference on Emerging Intelligent Data and Web Technologies*, vol. 0, pp. 220–226, 2013.
- [69] N. Smart and F. Vercauteren, “Fully homomorphic encryption with relatively small key and ciphertext sizes,” Cryptology ePrint Archive, Report 2009/571, 2009. [Online]. Available: <http://eprint.iacr.org/>
- [70] Z. Brakerski, C. Gentry, and V. Vaikuntanathan, “Fully homomorphic encryption without bootstrapping,” Cryptology ePrint Archive, Report 2011/277, 2011. [Online]. Available: <http://eprint.iacr.org/>
- [71] K. Lauter, M. Naehrig, and V. Vaikuntanathan, “Can homomorphic encryption be practical?” Cryptology ePrint Archive, Report 2011/405, 2011, <http://eprint.iacr.org/>.
- [72] J.-S. Coron, D. Naccache, and M. Tibouchi, “Optimization of fully homomorphic encryption,” Cryptology ePrint Archive, Report 2011/440, 2011. [Online]. Available: <http://eprint.iacr.org/>
- [73] C. Gentry and S. Halevi, “Implementing gentry’s fully-homomorphic encryption scheme,” in *EUROCRYPT*, 2011, pp. 129–148.
- [74] M. V. Dijk, C. Gentry, S. Halevi, and V. Vaikuntanathan, “Fully homomorphic encryption over the integers,” *Accepted to Eurocrypt 2010 Available*, vol. athttp, p. //eprintiacr.org/2009/616, 2009. [Online]. Available: <http://eprint.iacr.org/2009/616.pdf>
- [75] Y. Gahi, M. Guennoun, and K. El-Khatib, “A secure database system using homomorphic encryption schemes,” *CoRR*, vol. abs/1512.03498, 2015.
- [76] D. Boneh, A. Sahai, and B. Waters, “Functional encryption: A new vision for public-key cryptography,” *Commun. ACM*, vol. 55, no. 11, pp. 56–64, Nov. 2012. [Online]. Available: <http://doi.acm.org/10.1145/2366316.2366333>
- [77] Eperi, “How eperi can help to achieve compliance with strict data residency requirements,” [Online]. Available: <https://blog.eperi.co>, 2018.
- [78] C. Curino, E. Jones, R. A. Popa, N. Malviya, E. Wu, S. Madden, H. Balakrishnan, and N. Zeldovich, “Relational Cloud: A Database Service for the Cloud,” in *5th Biennial Conference on Innovative Data Systems Research*, Asilomar, CA, 1 2011.
- [79] R. A. Popa, C. M. S. Redfield, N. Zeldovich, and H. Balakrishnan, “Cryptodb: Protecting confidentiality with encrypted query processing,” in *Proceedings of the Twenty-Third ACM Symposium on Operating Systems Principles*, ser. SOSP ’11. New York, NY, USA: ACM, 2011, pp. 85–100. [Online]. Available: <http://doi.acm.org/10.1145/2043556.2043566>
- [80] S. Tu, M. F. Kaashoek, S. Madden, and N. Zeldovich, “Processing analytical queries over encrypted data,” *Proc. VLDB Endow.*, vol. 6, no. 5, pp. 289–300, Mar. 2013. [Online]. Available: <http://dx.doi.org/10.14778/2535573.2488336>
- [81] P. Antonopoulos, A. Arasu, K. D. Singh, K. Eguro, N. Gupta, R. Jain, R. Kaushik, H. Kodavalla, D. Kossmann, N. Ogg *et al.*, “Azure sql database always encrypted,” in *Proceedings of the 2020 ACM SIGMOD International Conference on Management of Data*, 2020, pp. 1511–1525.
- [82] J. Koppenwallner and E. Schikuta, “Dice – a data encryption proxy for the cloud,” 2023.
- [83] E. Schikuta, T. Fuerle, and H. Wanek, “Vipios: The vienna parallel input/output system,” in *Euro-Par98 Parallel Processing: 4th International Euro-Par Conference*. Springer, 1998, pp. 953–958.
- [84] W. Mach and E. Schikuta, “A generic negotiation and renegotiation framework for consumer-provider contracting of web services,” in *Proceedings of the 14th International Conference on Information Integration and Web-based Applications & Services*, 2012, pp. 348–351.
- [85] E. Schikuta and T. Weishäupl, “N2grid: neural networks in the grid,” in *2004 IEEE International Joint Conference on Neural Networks (IEEE Cat. No. 04CH37541)*, vol. 2. IEEE, 2004, pp. 1409–1414.
- [86] E. Schikuta, F. Donno, H. Stockinger, H. Wanek, T. Weishäupl, E. Vinek, and C. Witzany, “Business in the grid: Project results,” in *1st Austrian Grid Symposium*. OCG, 12 2005. [Online]. Available: <http://eprints.cs.univie.ac.at/745/>
- [87] T. Weishäupl and E. Schikuta, “Towards the merger of grid and economy,” in *Grid and Cooperative Computing - GCC 2004 Workshops*, H. Jin, Y. Pan, N. Xiao, and J. Sun, Eds. Berlin, Heidelberg: Springer Berlin Heidelberg, 2004, pp. 563–570.
- [88] E. Schikuta, H. Wanek, and I. Ul Haq, “Grid workflow optimization regarding dynamically changing resources and conditions,” *Concurrency and Computation: Practice and Experience*, vol. 20, no. 15, pp. 1837–1849, 2008.
- [89] K. Kofler, I. ul Haq, and E. Schikuta, “A parallel branch and bound algorithm for workflow qos optimization,” in *2009 International Conference on Parallel Processing*. IEEE, 2009, pp. 478–485.
- [90] G. Stuermer, J. Mangler, and E. Schikuta, “Building a modular service oriented workflow engine,” in *2009 IEEE international conference on service-oriented computing and applications (SOCA)*. IEEE, 2009, pp. 1–4.
- [91] P. Jagadeeswarajah and M. P. Kumar, “Securedbaas model for accessing encrypted cloud databases,” *Telkomnika Indonesian Journal of Electrical Engineering*, vol. 16, no. 2, pp. 333–340, 2015.
- [92] K. Beer and R. Holland, “Securing data at rest with encryption.” [Online]. Available: <https://d0.awsstatic.com/whitepapers/aws-securing-data-at-rest-with-encryption.pdf>