

Attention Based Encoder Decoder Model for Video Captioning in Nepali (2023)

Kabita Parajuli, *Department of Electronics and Computer Engineering, Pulchowk Campus, Tribhuvan University,*
 Shashidhar R. Joshi, *Department of Electronics and Computer Engineering, Pulchowk Campus, Tribhuvan University*

Abstract—Video captioning in Nepali, a language written in the Devanagari script, presents a unique challenge due to the lack of existing academic work in this domain. This work develops a novel encoder-decoder paradigm for Nepali video captioning to tackle this difficulty. LSTM and GRU sequence-to-sequence models are used in the model to produce related textual descriptions based on features retrieved from video frames using CNNs. Using Google Translate and manual post-editing, a Nepali video captioning dataset is generated from the Microsoft Research Video Description Corpus (MSVD) dataset created using Google Translate, and manual post-editing work. The efficacy of the model for Devanagari-scripted video captioning is demonstrated by BLEU, METOR, and ROUGE measures, which are used to assess its performance.

Index Terms— MSVD, Encoder, Decoder LSTM, GRU, Attention Mechanism

I. INTRODUCTION

The growth of multimedia data especially videos has brought up several benefits as well as difficulties in organizing and gaining access to the enormous amount of visual data that is out there. The internet's abundance of video footage has made video captioning an important field of study. The ability to efficiently classify, index, and retrieve videos is crucial for managing and comprehending this enormous amount of visual data. The demand for effective and precise video understanding approaches has increased due to the rising popularity of websites that share videos.

The process of automatically producing a natural language description of a video is known as video captioning. Because videos are dynamic and complex, it is a difficult process. Videos include a temporal component, which means that they vary over time, in contrast to photographs. Because of this, it is challenging for models to extract the temporal and spatial information required to provide meaningful and accurate captions. Conventional methods occasionally blend handcrafted features like motion vectors or low-level visual descriptors with statistical language models. In deep learning-based techniques, transformer models or recurrent neural networks (RNNs) are utilized for language modeling, while convolutional neural networks (CNNs) are used for visual analysis.

The state-of-the-art in video captioning has lately been established by deep learning-based techniques. In these methods, visual features are extracted from the video using convolutional neural networks (CNNs), then a caption is

generated based on these data using either transformer models or recurrent neural networks (RNNs). CNNs can learn intricate spatial patterns, which makes them especially well-suited for extracting visual data from films. RNNs can capture the temporal connections between words, which makes them ideal for creating captions. A more recent class of neural networks called transformer models has demonstrated encouraging performance in video captioning. They are excellent at jobs like video captioning because of their attention mechanism, which enables them to comprehend long-range dependencies quickly.

Recurrent neural network (RNN) architectures, such as LSTM and GRU, are frequently employed for video captioning; nevertheless, they have different advantage and disadvantages. Because LSTM is so good at capturing long-term dependencies in data, it's a great option for tasks requiring long-term memory, including video captioning. Nevertheless, greater complexity comes with a larger processing overhead, on the other hand, has a simpler structure that expedites training and inference and increases processing efficiency. However, because of its simplicity, it may not be as effective at modeling long-term dependencies. Which of LSTM and GRU to utilize depends on the requirements of the current task. For applications where accuracy is of utmost importance, LSTM is the optimal option, even if it comes at the expense of speed. However, GRU works better on tasks requiring real-time execution, even at the cost of some precision. When accuracy and speed are equally crucial, a hybrid approach that blends GRU and LSTM may be the best option.

II. LITERATURE REVIEW

Most of the video captioning has been done for a small set of commonly spoken languages, Nepali being one of the significant exceptions. Researchers have experimented with a variety of deep learning architectures and frameworks to produce captions from videos or image frame sequences, motivated by developments in image captioning. Predicting subject-verb-object (SVO) relationships and matching them to preset templates was the foundation of earlier methods. To enable descriptions of vehicle actions, researchers suggested approaches that connected motion verbs to vehicle movements. To further improve the description creation process, semantic tags were included. By following objects in real-world circumstances, they connected 64 motion verbs to describe a vehicle's movement. The description generation procedure was further expanded by creating semantic tags for the actions shown in the video. Researchers' emphasis has recently shifted

away from using predetermined templates for producing descriptions in favor of deep recurrent networks after studying the enormous success of deep learning (DL) in the fields of both CV and NLP. Currently, most methods for captioning videos use an encoder-decoder framework that employs various CNN (Convolutional Neural Network) configurations and recurrent network variants.

A technique for creating descriptive and contextually relevant video subtitles by combining global and local representations was presented by **L. Yan et al. [1]** High-level knowledge is obtained by extracting characteristics from the full video sequence in the first stream, which captures global representation. Using feature extraction, the second stream concentrates on local representations by identifying regions within video frames. A caption generator that uses transformer-based architectures or recurrent neural networks is then given these global and local information. The results of their experiments show that their approach works better than current approaches in terms of relevancy and quality of captions.

A video captioning system was developed by **Sandeep Samleti et al. [6]** that uses a CNN to extract frame-level features, a mean-pooled vector of all recovered features to represent the entire video, and an LSTM for sequence synthesis. Unfortunately, because of mean pooling, this technique is unable to capture the temporal correlations between frames. By presenting a two-layer LSTM encoder-decoder architecture for video captioning, **Kevin Lin et al. [5]** expanded on Samleti's work. At every time step, a fixed-size feature vector containing visual features is created using each frame as input.

Later this year, an exciting study on this field "Attention-based video captioning framework for Hindi" **Alok Singh et al [2]** tried to solve the issue of Hindi video captioning. It is critical to offer a method for interpreting the visual entities in native languages in a country with a vast array of languages like India. In this study, we use a hybrid attention mechanism that combines a soft temporal attention mechanism with a semantic attention mechanism to enable the system to select the appropriate time to focus on both visual context vector and semantic input. A Long Short-Term Memory (LSTM) recurrent network with an attention module is used to decode the encoded context vector after the visual context vector of the input video has been retrieved using a 3D convolutional neural network (3D CNN). The (MSR-VTT) dataset was translated, and then post-edited, using a dataset created internally for Hindi video captioning. This model achieves a 0.369 CIDEr score and a 0.393 METEOR score, which outperforms other baseline models. This model could not generate multi-lingual captions for an input video.

The revolutionary video captioning framework (ORMF), put forth by **Zhiwen Yan et al. [3]** for video captioning, is built on the object relation graph and multimodal feature fusion. ORMF uses the spatiotemporal correlations and similarities between the objects in the movie to construct an object relation features graph and introduce a graph convolution network (GCN) to encode the object relation. ORMF constructs a multi-modal features fusion network to ascertain the relationships between different modal features. The multimodal feature fusion network combines the features of many modalities. The proposed model calculates the caption's length loss, producing a richer caption. The experimental results on two publicly

available datasets (Microsoft research-video to text [MSR-VTT]) show the value of this approach.

The use of the transformer structure for video captioning is the focus of **Tao Jin et al.**'s essay "SBAT: Video Captioning with Sparse Boundary-Aware Transformer" [4]. The vanilla transformer is recommended for unimodal language-generating tasks, such as machine translation tasks. Video captioning is a multimodal learning challenge since there is a lot of overlap between different time steps in the video data. Considering these concerns, we propose a novel method to reduce redundant information in video representation called the sparse boundary-aware transformer (SBAT). SBAT selects a range of attributes from diverse situations and applies boundary-aware pooling procedure to scores from multi-head attention. To compensate for the local information loss brought on by sparse operation, SBAT also features a local correlation approach. When evaluated using the MSVD dataset, SBAT performs better overall than TVT and MARN models and beats GRU-EVE, SCN, and POS-CG on all criteria. The vanilla transformer's ability to identify the boundaries of different scenarios declines when its attention weights are allocated.

Now, most video captioning techniques rely on encoder-decoder frameworks that use various recurrent network variants and convolutional neural network combinations. [17] presented a framework for video captioning that uses CNN to extract frame-level features, which is then used to represent the entire video using a mean-pooled vector of all the collected features. This vector is then passed to an LSTM to generate sequences. The drawback of this is that the temporal relationship between the frames cannot be captured by the mean pooling approach. Expanding upon earlier research, [18] suggested an additional encoder-decoder system for video captioning that employs two layers of LSTMs. This framework encodes the visual elements of the video into a fixed size feature vector by using each frame as an input in each time step.

The ability of LSTM (Long Short-Term Memory) and GRU (Gated Recurrent Unit) models to handle sequential data and long-term dependencies makes them particularly effective tools for video captioning tasks. These models show remarkable performance in extracting and storing important information from films, particularly in cases where contextual dependencies span several frames or time steps. They can encode and capture the temporal dynamics inherent in movies because of their complex internal systems, which allow them to efficiently update and store pertinent information across extended durations. Moreover, the LSTM and GRU models can handle sequences with different lengths with ease, which is an important feature for video captioning because films come in a variety of lengths.

Prior work has been completed by concentrating on important languages like Chinese, English, German, and Hindi. This inspired me to use publicly available MSVD dataset, which is translated into Nepali language, followed by post editing of each reference caption, this research attempt to address the problem of video captioning in NEPALI language. A caption may be created in English and then translated into Nepali using a machine translation system, or the model may be trained directly on a Nepali reference caption to produce output in Nepali. The quality of the generated captions will decline if the

MT technique is used to generate them in many languages. I prefer to translate by hand using Google Translate.

A. Long Short-Term Memory Architecture

An artificial recurrent neural network architecture called long short-term memory combines feedforward and feedback neural networks. Long-term reliance is resolved by LSTMs because of their unique architecture, which allows them to manage the relationship between recent past knowledge and current tasks even as the gap widens. Information moves across cells in the LSTM structure, a type of memory system that can selectively distinguish between information that should be remembered and information that should be spread. Information about sequential data processing, including speech, video, text, etc., can be carried by the cell state.

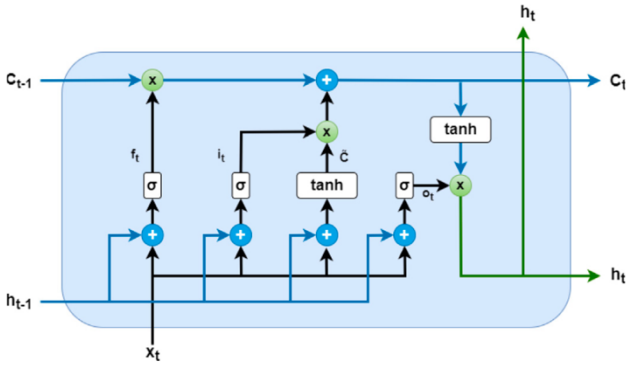

Fig 1: Basic Architecture of LSTM

The input gate (xt), output gate (ht), and forget gate (ft) compose a cell state. An input gate is used in an LSTM cell to measure the importance of new information at a certain timestamp. The crucial element in charge of eliminating (forgetting) the data from the prior timestamp is a forget gate. Additionally, the output gate's goal is to choose the most important data from the active LSTM cell and send it out as the output.

$$i_t = \sigma(x_t U^i + h_{t-1} W^i) \quad (1)$$

$$f_t = \sigma(x_t U^f + h_{t-1} W^f) \quad (2)$$

$$o_t = \sigma(x_t U^o + h_{t-1} W^o) \quad (3)$$

$$C'_t = \tanh(x_t U^g + h_{t-1} W^g). \quad (4)$$

$$C_t = \tanh(x_t U^g + h_{t-1} W^g). \quad (5)$$

$$h_t = \tanh(C_t) * o_t \quad (6)$$

Equations 1 through 6 display the LSTM architecture's mathematical formulas for corresponding gates. The reason LSTM is used in this study is due to its ability to retain patterns for extended periods with selectivity. Additionally, the LSTM design makes it easy to categorize, process, and forecast the right result from massive time-series data.

B. Gated Recurrent Unit

A basic recurrent neural network with a gating mechanism added is called a gated recurrent unit (GRU). Just like in LSTM,

gates are used to regulate the information flow in GRU. It can train more quickly and has a simpler architecture than LSTM, with fewer parameters. The fundamental architecture of a single GRU unit is shown in Figure, which includes an update gate (zt), reset gate (rt), current memory content (ht), and final memory at the current time step (ht). The GRU mathematical formulas are presented:

$$z_t = W_z x x_t + W_z h h_t + b_z \quad (7)$$

$$r_t = (W_r x x_t + W_r h h_{t-1} + b_r) \quad (8)$$

$$h'_t = \tanh(W_{\sigma x} x_t + W_{\sigma h} h_{t-1} + b_{\sigma}) \quad (9)$$

$$h_t = z_t h_{t-1} + (1 - z_t) h'_t \quad (10)$$

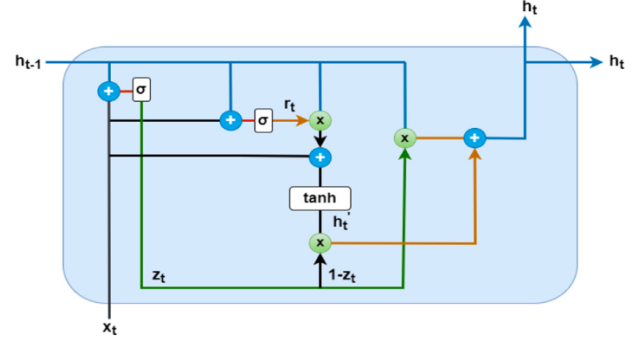

Fig 2: Basic Architecture of GRU

C. Encoder

It is the objective of the encoder to analyze and understand the input sequence. The encoder examines the input, whether it's a sentence in a natural language or a series of video frames, step by step, analyzing and extracting pertinent information at each time step. Each word in the phrase or each token in the input sequence is analyzed sequentially in text-based tasks. At each time step, the LSTM or GRU units of the encoder receive inputs and change their internal hidden states. These concealed states extract crucial data from the input sequence. The context vector, often referred to as the thought vector, is the encoder's final hidden state and contains a compressed version of the whole input sequence. It's important to note that in many applications, just the internal states are kept, and the encoder's output is deleted.

Depending on the recurrent neural network (RNN) being used, the encoder cell architecture can change. The internal state configuration is one of the main characteristics that set LSTM (Long Short-Term Memory) apart from GRU (Gated Recurrent Unit). Each cell in an LSTM consists of two internal states: the hidden state, which contains information transferred from one time step to the next, and the cell state, which oversees managing long-term data. On the other hand, the architecture of GRU cells is simpler because they have just one hidden state.

Furthermore, an important change from conventional methods is seen when utilizing an attention mechanism. This technique considers the outputs from all 80 encoder states, rather than just the last step. This change in focus improves the model's ability to extract and apply pertinent information for the job at hand by enabling it to dynamically attend to different segments of the input sequence. The efficiency of sequence-to-sequence models

is greatly influenced by this architecture and design, especially in natural language processing and other fields where understanding and context are important.

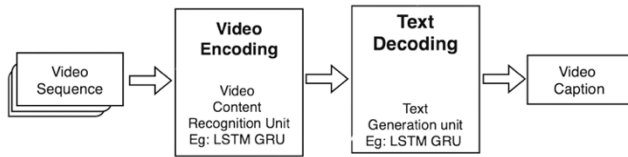

Fig 3: Basic Architecture of Encoder Decoder

D. Decoder

The output sequence is created by the decoder, which succeeds the encoder. The context vector from the encoder is used to initialize its initial LSTM or GRU cell. Making the output sequence step by step is the decoder's main responsibility. The decoder generates words one at a time for tasks involving text production, such as language translation or text summarization. It produces insightful captions for each frame of the video when used for captioning. The context vector is used to set the initial hidden state of the decoder's LSTM or GRU cell, which serves as the starting point for producing the output. The decoder creates an output token (such as a word) at every time step based on the previous output and the concealed state it is now in.

To learn the mapping function, the decoder cells take in the vector representation of the reference captions. To forecast the first vector, the decoder's first cell uses the <start> (sentence beginning) token. In a similar manner, the second cell predicts the second vector using the first decoder cell's output, and so on. Until the <end> (end of sentence) token is reached, the process keeps on.

The Encoder-Decoder can successfully capture and use sequential dependencies because of the use of LSTM or GRU cells in both the encoder and decoder. These recurrent units keep hidden states that include relevant information about the sequence that has been processed thus far, enabling the model to take context into account when making predictions. In the case of video captioning, this architecture enables the model to ingest a series of video frames and output coherent, contextually appropriate captions. To make sure that the captions match the content of the video frames, the context vector that the encoder generates is essential. A solid foundation for sequence-to-sequence operations is the encoder-decoder architecture with LSTM/GRU cells, in conclusion. It makes use of the encoder to comprehend input sequences and the decoder to produce corresponding output sequences, making it a flexible tool for a variety of applications, including video captioning and language translation.

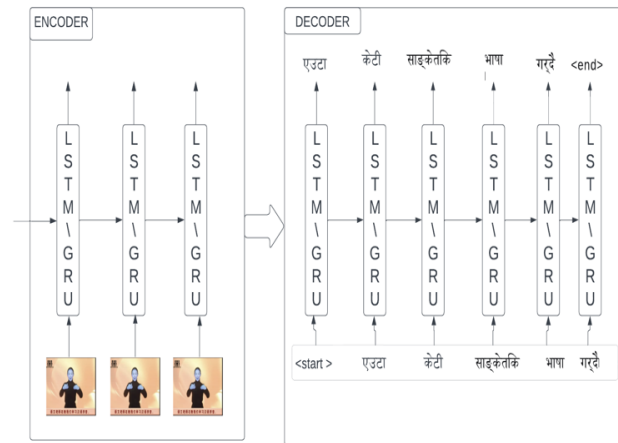

Fig 4: Working of Encoder Decoder model during Training

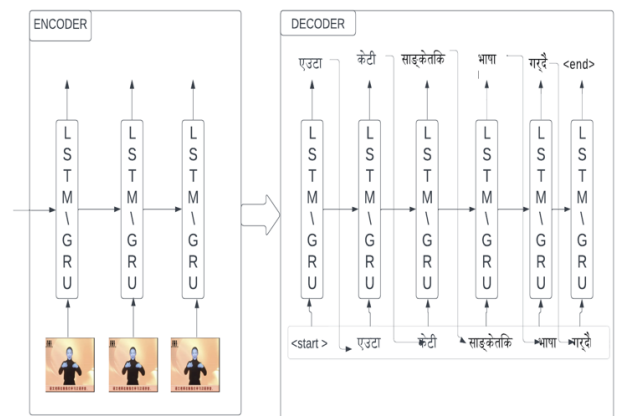

Fig 5: Working of Encoder Decoder model during Prediction

E. Attention Mechanism

The entire input sequence is encoded into a single fixed-length character vector, which is one of the drawbacks of the encoder-decoder-based seq2seq architecture. This is an issue when working with very long input sequences, especially ones that are longer than those in the training dataset. To overcome this constraint, the attention model which creates a context vector unique to every decoder time step was presented. This model differs from the basic encoder-decoder model in that it maps the whole input sequence onto a single context vector.

The attention mechanism is dependent on both input and output aspects. Attention makes it possible for the decoder to use the most pertinent information from the input sequence in a flexible manner. It accomplishes this by combining all the encoder outputs into a weighted combination, giving the most relevant vectors the highest weights. The two models (GRU, LSTM) that were previously discussed use this attention mechanism to determine which performs best. With the introduction of the attention model, this limitation was addressed by creating a context vector unique to each decoder time step, compared to the standard.

III. METHODOLOGY

An encoder-decoder paradigm for video captioning is a strong, adaptable technology with significant applications. It serves as an example of how AI has the potential to close gaps across various media types (visual and textual) and to produce more inclusive and educational digital experiences. It presents fascinating opportunities for enhancing how we interact with and comprehend video information in our increasingly digital world as the field continues to develop. A fascinating and interdisciplinary field of research that combines computer vision and natural language processing is video captioning utilizing an encoder-decoder architecture. This strategy has a wide range of real-world uses and is receiving a lot of attention since it has the potential to make videos easier to access, find, and use. It brings up new possibilities by allowing machines to comprehend and characterize the content of videos.

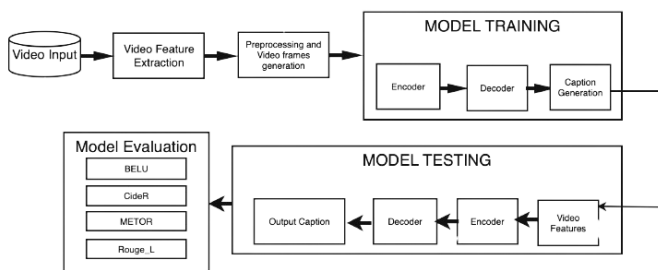

Fig 6: Proposed model block diagram

A. Dataset

There is no dataset available for Nepali video captioning prior to work. So, the Microsoft Research Video Description (MSVD) Dataset has about 2,000 brief video clips that each last a few seconds, cover a wide variety of topics and activities and each video consists of 15-20 captions. The MSVD dataset contains a large collection of YouTube video clips as well as corresponding annotations. It has over 80,789 video description sentences spread across 1,970 videos of 10- to 20 seconds. From the MSVD dataset, a unique Nepali video captioning dataset is created using Google Translate, and manual post-editing work accompanying these video segments uses natural language to explain the scenes and information they feature. Because of this, in addition to the automatic translation, careful manual work was needed to fix these problems and improve the accuracy of the machine-translated Nepali captions.

B. Preprocessing

Using a Google translator to translate an English caption into Nepali can provide a few difficulties, including incorrectly translating lengthy captions and captions with unclear language. We manually edited the translated captions once they were translated to make them cleaner. A Nepali tokenizer is used to tokenize each caption.

C. Feature Extraction

The MSVD (Microsoft Research Video Description) dataset feature extraction for video captioning entails gathering both visual and temporal data from the video frames to provide

meaningful captions. Frames from videos are extracted using the VGG16 model. To extract frames from a given video file frames function requires parameters like the video path and the desired number of extracted frames. The feature reads frames, distributing them uniformly throughout the film to guarantee that representative frames are recorded. a thorough pipeline for video preprocessing that pulls frames from a dataset of films, stores them as NumPy arrays, and stores the captions that go with them.

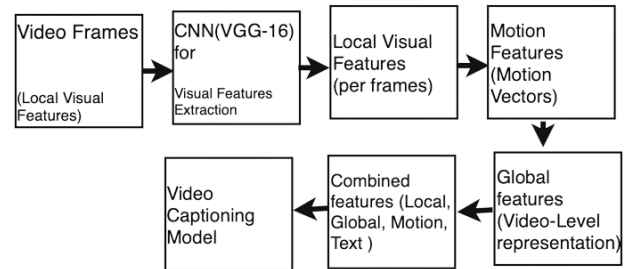

Fig 7: Feature Extraction overall illustration

Frames from videos are extracted during the pre-processing stage, and any necessary adjustments are made. To extract frames from a given video file, use the extract frame's function. It requires parameters like the video path and the desired number of extracted frames. The feature reads frames, distributing them uniformly throughout the film to guarantee that representative frames are recorded. a thorough pipeline for video preprocessing that pulls frames from a dataset of films, stores them as NumPy arrays and stores the captions that go with them. The pre-trained model performs feature extraction on each chosen frame. The use of a model like VGG16, which has been pre-trained on a sizable dataset including millions of images, produces a vector of features, frequently of dimensions 4096, that reflects the key visual qualities of each frame as it is processed by the model. Following the stacking of these feature vectors for each film, a structured NumPy array with dimensions (28, 4096) is produced.

```
[[1.4559064 0.66230696 0.08930378 ... 0.25029743 1.162832 1.2205805 ]
 [0.62838507 0.6127548 0.15510947 ... 0.45860204 1.2756816 1.3812673 ]
 [0.7599578 0.58748186 0.26961824 ... 0.44239733 1.3105797 1.1350001 ]
 ...
 [0.8577998 0.24253726 0.16858245 ... 0.4667028 0.24543582 0.6936421 ]
 [0.73376036 0.55585486 0.2657315 ... 0.04579229 0.3486544 0.7601513 ]
 [0.74133354 0.67648816 0.4922339 ... 0.27372175 1.1050256 0.8400312 ]]
```

Fig 8: Structured NumPy Array of dimensions (28,4096)

These arrays provide machine-learning models with a format that captures the visual core of the video content. The dataset is turned into a feature-rich representation by the extraction of these characteristics, where these features are used as input to create captions that describe the content of the video. A summary or aggregation of the local features that captures the general content or essence of the full set of local characteristics are global features retrieved from local data. One can apply an aggregation function or operation along the rows of the local features matrix (which consists of 28 rows, each of which represents a local feature) to produce global features from the local features.

The brief video clips in the Microsoft Video Description (MSVD) dataset can be useful for capturing the spatiotemporal information in motion by extracting motion features using a 3D Convolutional Neural Network (C3D). Deep learning models called 3D Convolutional Neural Networks (C3D) are made especially for extracting motion features from video footage. Spatial-temporal features are extracted from the MSVD (Microsoft Video Description) utilizing C3D for motion feature extraction. C3D transforms these volumetric cubes using 3D convolutions. These three-dimensional convolutional layers are trained to recognize spatiotemporal patterns in the video images, including motion vectors and actions.

D. Model Training

For various goals, this thesis on video captioning calls for several machine-learning architectures. There are various uses for each machine learning and deep learning model. Encoder and decoder models with LSTM and GRU, which aid in training a series of frames, are needed for training. A train set, a validation set, and a test set have been created from the preprocessed data. To the training model, the feature data is sent. Where the LSTM performs best for sequence data as a reservoir, an encoder-decoder model with an LSTM and GRU is employed. The encoder's final output is supplied as input to the decoder model, which creates captions. Under this model, the training set is trained.

The suggested video captioning models are trained and assessed using the updated dataset. A split ratio of 85% is employed for training and validation, with 1450 and 100 video clips used for testing, respectively. A neural network model with the following parameters was employed: a latent dimension of 512, an encoder with 28-time steps, and 2048 unique tokens. The decoder was intended to produce output sequences consisting of ten-time steps and a 1500 token output vocabulary. The model was trained over 100 and 40 epochs respectively using a batch size of 320 in our training procedure. The model's architecture and training schedule were shaped by these parameter values, which in turn affected the model's performance within the framework of study.

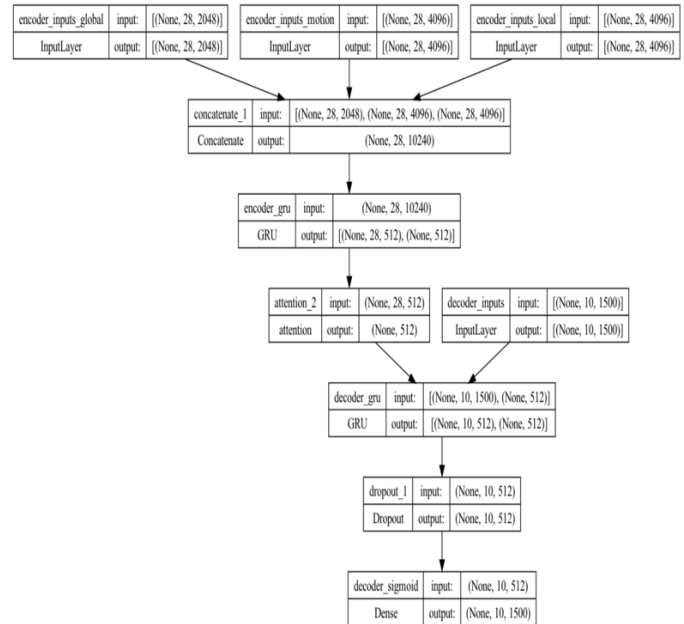

Fig 9: Final Model Architecture

D. Evaluation metrics

There are four distinct automated evaluation measures that are employed: BLEU [22], METEOR, CIDEr [23], and ROUGE [24]. Several research reports assert that because videos have a dynamic structure, different content pieces, events, and activities, the BLEU score may vary from the human assessment of the generated captions. However, after noting BLEU's recent success in MT output evaluation, we employed it in addition to METEOR for caption evaluation.

IV. RESULT AND ANALYSIS

While there has been a lot of research on Nepali picture captioning, there hasn't been nearly as much done around video captioning for the language. Videos, which consist of a continuous series of images, can be related to images. The suggested models' performances are compared as well with the results of research done on Nepali image captioning. The performance of various models compared to the suggested ones is shown in the figure below using various evaluation metrics. Both Gru and LSTM were run for both 100 and 40 epochs with implementation of Attention achieved the highest accuracy of 77.83. various Accuracy and loss plot are shown in figure below:

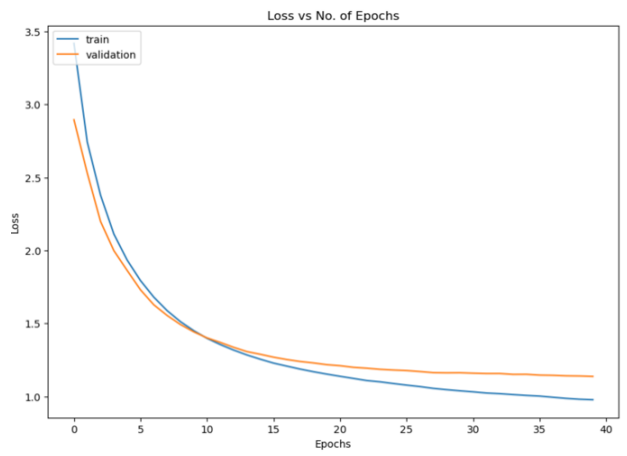
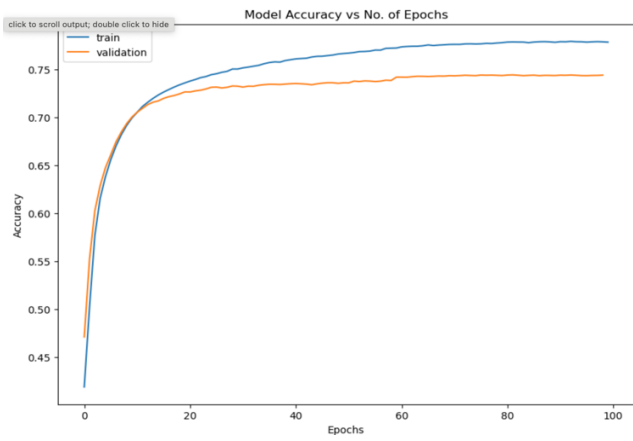
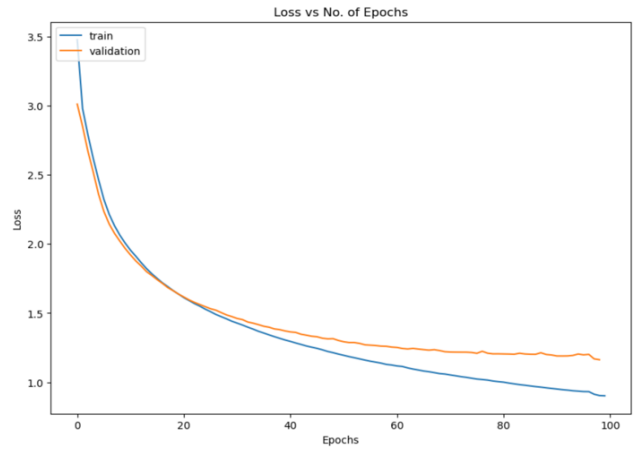
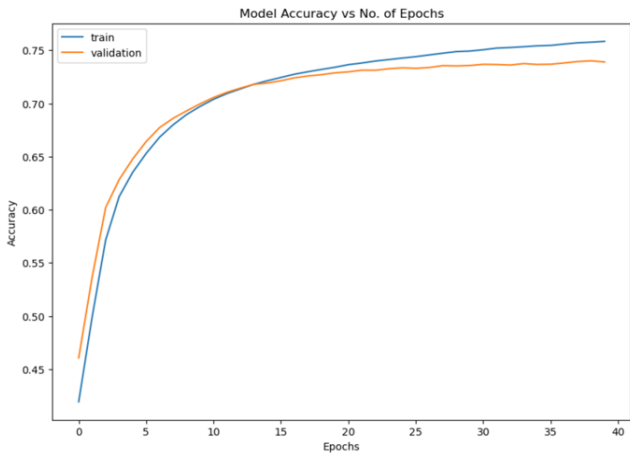
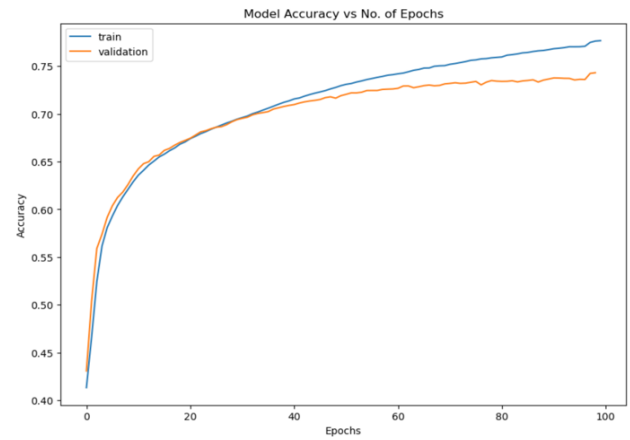
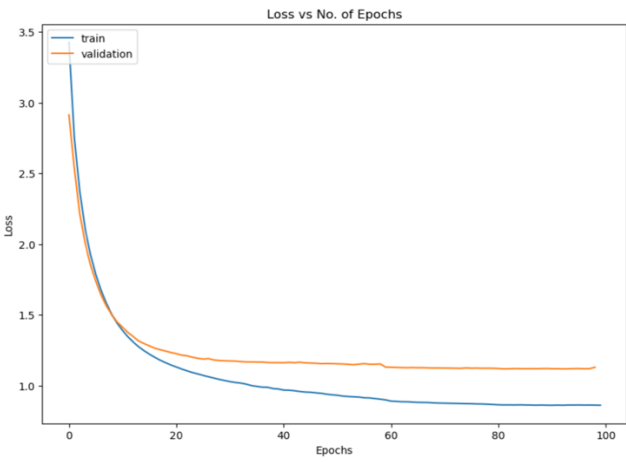

Fig 10: Accuracy loss plot encoder decoder with GRU



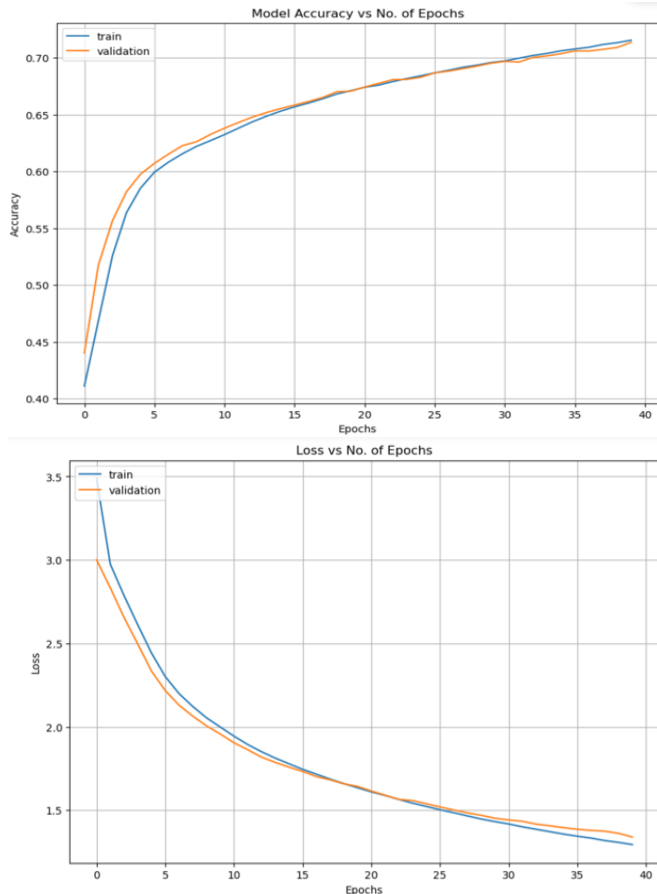

Fig 11: Accuracy loss plot of Encoder decoder LSTM

RNN	Bleu1	Bleu2	Bleu3	Bleu4	METEOR	ROUGE_L
LSTM	0.58	0.421	0.282	0.169	0.361	0.248
GRU	0.66	0.479	0.329	0.189	0.361	0.248
LSTM+ATTENTION	0.65	0.452	0.282	0.169	0.361	0.248
GRU+ATTENTION	0.68	0.451	0.282	0.223	0.361	0.342

Table 1: Performance Evaluation on Greedy Search

There have been some recent advances in the fascinating field of research on Nepali video captioning. The outcomes of the studies demonstrate how important model selection is to achieve improved performance. In terms of performance, the GRU outperforms the LSTM. But as Table demonstrates, both BLEU-3 and BLEU-4 ratings in this research were quite low. Special consideration was paid to the BLEU-4 and METEOR ratings when compared with other works. Overall, the results suggest that the attention mechanism can improve the performance of machine learning models on caption generation tasks.

The quality of the dataset utilized for training and assessment may be one explanation for this. Google Translate was used to translate the dataset from English to Nepali; as a result, there might be errors and differences in the Nepali captions. Lower BLEU scores could result from these errors since they could distort how well the generated captions fit with the reference sentences. Even so, the study's METEOR scores were strong, suggesting that despite the captions' minor deviations from the reference lines, they are meaningful and effectively communicate the essential idea. This demonstrates the model's capacity to generate pertinent captions despite the Nepali language's many difficulties, which include word order, morphological structures, different politeness levels, limited language resources, and the possibility of translation errors, to mention a few. The study also discovered that the model's performance can be affected by the selection of the batch size, hidden dimensions, and number of training epochs. These and other hyperparameters can be changed to investigate further improvements. All things considered, the study shows that Nepali video captioning is feasible and promising. Still, there is room to improve the model and the quality of the captions.

V. CONCLUSION

This study involved experimenting with several notable neural network topologies. The creation of a syntactically and semantically consistent dataset from the MSVD, which may be used for further research in this area, is a noteworthy contribution of this study. To achieve the highest level of accuracy in model differentiation, the dataset is utilized to train the carefully chosen cutting-edge models. Additionally, to get benchmark performance for Bengali video captioning, the attention method is introduced. In terms of generic RNN architecture, LSTM GRU combined with VGG16 performs best. However, the attention-based GRU combined with VGG16 is sound enough to produce more natural-looking captions, making it the best model overall. To conduct a comprehensive and flexible performance evaluation, the model's performance for two distinct search strategies is then compared using three widely used evaluation metrics: BLEU, METEOR, and ROUGE.

ACKNOWLEDGEMENT

We would like to thank all the professors and teachers at the Department of Electronics and Computer Engineering, Pulchowk Campus for their important and practical guidance for the research.

REFERENCES

- [1] L. Yan et al., "Video Captioning Using Global-Local Representation," in *IEEE Transactions on Circuits and Systems for Video Technology*, vol. 32, no. 10, pp. 6642–6656, Oct. 2022, doi: 10.1109/TCSVT.2022.3177320
- [2] Singh, A., Singh, T.D. Bandyopadhyay, S. Attention based video captioning framework for Hindi. *Multimedia Systems* 28, 195–207 (2022). <https://doi.org/10.1007/s00530-021-00816-3>.
- [3] P. Yan, Zhiwen, et al. "Multimodal feature fusion based on object relation for video captioning." *CAAI Transactions on Intelligence Technology* 8.1 (2023): 247-259. <http://dx.doi.org/10.1049/cit2.12071>
- [4] Jin, T., Huang, S., Chen, M., Li, Y., & Zhang, Z. (2020). SBAT: Video Captioning with Sparse Boundary-Aware Transformer. *ArXiv*. /abs/2007.11888
- [5] Lin, K., Li, L., Lin, C., Ahmed, F., Gan, Z., Liu, Z., Lu, Y., & Wang, L. (2021). SwinBERT: End-to-End Transformers with Sparse Attention for Video Captioning. *ArXiv*. /abs/2111.13196
- [6] Sandeep Samleti , Ashish Mishra , Alok Jhajhria , Shivam Kumar Rai, Gaurav Malik, 2021, Real Time Video Captioning Using Deep Learning, *INTERNATIONAL JOURNAL OF ENGINEERING RESEARCH & TECHNOLOGY (IJERT)* Volume 10, Issue 12 (December 2021),
- [7] Im H, Choi Y-S. UAT: Universal Attention Transformer for Video Captioning. *Sensors*. 2022; 22(13):4817.
- [8] J. Deng, L. Li, B. Zhang, S. Wang, Z. Zha and Q. Huang, "Syntax-Guided Hierarchical Attention Network for Video Captioning," in *IEEE Transactions on Circuits and Systems for Video Technology*, vol. 32, no. 2, pp. 880-892, Feb. 2022..
- [9] Yan L, Ma S, Wang Q, Chen Y, Zhang X, Savakis A, Liu D. Video Captioning Using Global-Local Representation. *IEEE Trans Circuits Syst Video Technol.* 2022 Oct;32(10):6642-6656. doi: 10.1109/tcsvt.2022.3177320. Epub 2022 May 23. PMID: 37215187; PMCID: PMC10198123.
- [10] W. Pei, J. Zhang, X. Wang, L. Ke, X. Shen, and Y.-W. Tai, "Memory-attended recurrent network for video captioning," 2019 *IEEE/CVF Conference on Computer Vision and Pattern Recognition (CVPR)*, pp. 8339-8348, 2019.
- [11] Xin, Wenhui Chen, Wang, Jiawei Wu, William Yang, Yuan-Fang Wang, and Wang. Video captioning via hierarchical reinforcement learning. In *Proceedings of the IEEE conference on computer vision and pattern recognition*, pages 4213-4222, 2018.
- [12] D. Liu, Y. Cui, Y. Chen, J. Zhang, and B. Fan, "Video object detection for autonomous driving: Motion-aid feature calibration," *Neurocomputing*, vol. 409, pp. 1-11, 2020
- [13] N. Aafaq, N. Akhtar, W. Liu, S. Z. Gilani and A. Mian, "Spatio-temporal dynamics and semantic attribute enriched visual encoding for video captioning", *Proc. IEEE/CVF Conf. Computer. Vision. Pattern Recognition. (CVPR)*, pp. 12487- 12496, Jun. 2019.
- [14] Y. Yang et al., "Video Captioning by Adversarial LSTM," in *IEEE Transactions on Image Processing*, vol. 27, no. 11, pp. 5600-5611, Nov. 2018.,
- [15] L. Gao, Y. Lei, P. Zeng, J. Song, M. Wang and H. T. Shen, "Hierarchical Representation Network With Auxiliary Tasks for Video Captioning and Video [18] Question Answering," in *IEEE Transactions on Image Processing*, vol. 31, pp. 202-215, 2022, .
- [16] S. Li, Z. Tao, K. Li and Y. Fu, "Visual to Text: Survey of Image and Video Captioning," in *IEEE Transactions on Emerging Topics in Computational Intelligence*, vol. 3, no. 4, pp. 297-312, Aug. 2019, doi: 10.1109/TETCI.2019.2892755.
- [17] Venugopalan, S., Xu, H., Donahue, J., Rohrbach, M., Mooney, R., Saenko, K.: Translating videos to natural language using deep recurrent neural networks. *arXiv:1412.4729* (2014).
- [18] Venugopalan, S., Rohrbach, M., Donahue, J., Mooney, R., Darrell, T., Saenko, K.: Sequence to sequence-video to text. In: *Proceedings of the IEEE international conference on computer vision*, pp. 4534–4542 (2015).
- [19] Papineni, K., Roukos, S., Ward, T., Zhu, W.J.: Bleu: a method for automatic evaluation of machine translation. In: *Proceedings of the 40th annual meeting on association for computational linguistics*, pp. 311–318. Association for Computational Linguistics (2002).
- [20] Vedantam, R., Lawrence Zitnick, C., Parikh, D.: Cider: Consensus-based image description evaluation. In: *Proceedings of the IEEE conference on computer vision and pattern recognition*, pp. 4566–4575 (2015).
- [21] Lin, C.Y.: Rouge: A package for automatic evaluation of summaries. In: *Text summarization branches out*, pp. 74–81 (2004).
- [22] Ali, U., Lee, I.H., Mahmood, M.T., 2022. Robust regularization for single image dehazing. *Journal of King Saud University - Computer and Information Sciences* 34, 7168–7173.
- [23] Bahdanau, D., Cho, K., Bengio, Y., 2015. Neural machine translation by jointly learning to align and translate. In: 2015, 3rd International Conference on Learning Representations, ICLR 2015.
- [24] X. Wang, W. Chen, J. Wu, Y.-F. Wang, and W. Y. Wang, "Video captioning via hierarchical reinforcement learning," in *Proceedings of the IEEE Conference on Computer Vision and Pattern Recognition (CVPR)*, 2018, pp. 4213–4222.
- [25] Palash, M.A.H., Nasim, M.A.A., Saha, S., Afrin, F., Mallik, R., Samiappan, S., 2002. Bangla image caption generation through cnn-transformer based encoder-decoder network. pp. 631–644.
- [26] W. Pei, J. Zhang, X. Wang, L. Ke, X. Shen, and Y.-W. Tai, "Memory-attended recurrent network for video captioning," 2019 *IEEE/CVF Conference on Computer Vision and Pattern Recognition (CVPR)*, pp. 8339–8348, 2019.
- [27] L. Wang, Y. Xiong, Z. Wang, Y. Qiao, D. Lin, X. Tang, and L. Gool, "Temporal segment networks: Towards good practices for deep action recognition," *ArXiv*, vol. abs/1608.00859, 2016.
- [28] L. Wang, W. Li, and L. Gool, "Appearance-and-relation networks for video classification," 2018 *IEEE/CVF Conference on Computer Vision and Pattern Recognition*, pp. 1430-1439, 2018.
- [29] Q. Jin, J. Chen, S. Chen, Y. Xiong, and A. Hauptmann, "Describing videos using multi-modal fusion," *Proceedings of the 24th ACM international conference on Multimedia*, 2016.
- [30] X.Wang,Y.Wang,andW.Y.Wang,"Watch,listen,anddescribe:Globally and locally aligned cross-modal attentions for video captioning," in *NAACL-HLT*, 2018.
- [31] D. Tran, L. D. Bourdev, R. Fergus, L. Torresani, and M. Paluri, "Learning spatiotemporal features with 3d convolutional networks," 2015 *IEEE International Conference on Computer Vision (ICCV)*, pp. 4489-4497, 2015.
- [32] G. Nan, R. Qiao, Y. Xiao, J. Liu, S. Leng, H. Zhang, and W. Lu, "Interventional video grounding with dual contrastive learning," in *Proceedings of the IEEE/CVF Conference on Computer Vision and Pattern Recognition*, 2021, pp. 2765–2775.
- [33] Naik, D., & Jaidhar, C. D. (2022). A novel Multi-Layer Attention Framework for visual description prediction using bidirectional LSTM. *Journal of Big Data*, 9(1), 104. <https://doi.org/10.1186/s40537-022-00664-6>.
- [34] Subedi, Bipesh & Bal, Bal Krishna. (2022). CNN-Transformer based Encoder-Decoder Model for Nepali Image Captioning. *Proceedings of the 19th International Conference on Natural Language Processing (ICON)*, 86–91, New Delhi, India. Association for Computational Linguistics. <https://aclanthology.org/2022.icon-main.12>.