

Applying SDN to Mobile Networks: A New Perspective for 6G Architecture

Rashmi Yadav

Department of Electrical Engineering
Indian Institute of Technology Kanpur,
India
rashmiy@iitk.ac.in

Rashmi Kamran

Department of Electrical Engineering,
Indian Institute of Technology Bombay,
India
rashmi.kamran@iitb.ac.in

Pranav Jha

Department of Electrical Engineering,
Indian Institute of Technology Bombay,
India
pranavjha@ee.iitb.ac.in

Abhay Karandikar

Department of Electrical Engineering,
Indian Institute of Technology Bombay, India
karandi@ee.iitb.ac.in
Director, Indian Institute Technology Kanpur, India
karandi@iitk.ac.in

Abstract—The upcoming Sixth Generation (6G) mobile communications system envisions supporting a variety of use cases with differing characteristics, e.g., very low to extremely high data rates, diverse latency needs, ultra massive connectivity, sustainable communications, ultra-wide coverage etc. To accommodate these diverse use cases, the 6G system architecture needs to be scalable, modular, and flexible; both in its user plane and the control plane. In this paper, we identify some limitations of the existing Fifth Generation System (5GS) architecture, especially that of its control plane. Further, we propose a novel architecture for the 6G System (6GS) employing Software Defined Networking (SDN) technology to address these limitations of the control plane. The control plane in existing 5GS supports two different categories of functionalities – handling end user signalling (e.g., user registration, authentication) and control of user plane functions. We propose to move the “end-user signalling functionality” out of the mobile network control plane and treat it as user service, i.e., as payload or data. This proposal results in an evolved service-driven architecture for mobile networks bringing increased simplicity, modularity, scalability, flexibility and security to its control plane. The proposed architecture can also support service specific signalling support, if needed, making it better suited for diverse 6GS use cases. To demonstrate the advantages of the proposed architecture, we also compare its performance with the 5GS using a process algebra-based simulation tool.

Index Terms—Software-defined networking, Mobile networks, Service-driven architecture.

I. INTRODUCTION

THE notable rise in the range of diverse use cases with differing attributes has paved the way for the continued evolution of mobile networks. The upcoming 6th Generation Mobile Communication System (6GS) is envisioned to support peak data rate (≥ 200 Gbps), very high mobility (500-1000 Km/h), very low latency (0.1-1 ms), connection density in the range of 10^6 - 10^8 devices/Km², reliability of 10^{-5} - 10^{-7} [1]. Moreover, it is expected to witness further diversity of use cases with the emergence of newer categories of use cases.

Focus Group on Technologies for Network 2030 (FG NET-2030) [2] has identified and included the following use cases in its report: Holographic-type communications, Tactile Internet for Remote Operations, Intelligent Operation Networks, Network and Computing Convergence, Digital Twin, Space-Terrestrial Integrated Network, Industrial IoT with cloudification etc. A scalable, flexible and modular network architecture is one of the essential ingredients towards tackling this immense diversity of use cases in future mobile networks. Third Generation Partnership Project (3GPP) adopted technologies such as Network Function Virtualization, Control and User Plane Separation, Network slicing for Fifth Generation System (5GS), which resulted in improved scalability and flexibility of 5GS over the previous generation mobile communications systems such as Fourth Generation System (4GS).

However, there is scope for further improvement in mobile network architecture especially that of its control plane through the application of Software Defined Networking (SDN) technology. A survey of the existing research related to SDN-based enhancements in the mobile network control plane is presented next. The work in [3] proposes a centralised control plane for multi-Radio Access Technology (multi-RAT) Radio Access Network (RAN) to enhance the simplicity and flexibility of the network. Relocation of the control plane functionality of RAN to the Core Network (CN) to reduce the signalling cost between RAN and core has been discussed in [4]. Authors in [5] proposed a decentralized control plane architecture for the 5GS with independent control functions for different control events for flexible and scalable networks. An SDN architecture where a middle cell and a middle cell controller are introduced between the macro cell and the small cell to reduce the control overhead of the macro cell and to address the scalability problems is proposed in [6]. In [7], authors proposed a new 5GS core architecture based on the SDN concept. They introduced a centralised SDN controller

for easier and more flexible management of the user plane. In [8], a hierarchical control plane is designed to lighten the load of the controller. It focuses on the vertical scalability of the control plane. In [9], a scalability metric for the SDN control plane is proposed. Besides, a comparison between different SDN architectures is analysed via mathematical methods. In addition, there is a vast amount of literature on SDN-based network architectures, albeit unrelated to mobile networks [10], [11].

To summarize, current research in the context of the application of SDN technology to mobile networks mainly focuses on the centralized or distributed architecture of the control plane for reduced control overheads or scalability purposes. However, to the best of our knowledge, there is a limited discussion/rethink on certain other aspects of network architecture, such as, what functionality should constitute the mobile network control plane within an SDN-based framework. Is the network control plane right place for “end user signalling handling” functionality? Should “Non-Access Stratum (NAS) messages” be handled by CN control plane functions such as Access and Mobility Management Function (AMF) or should this functionality be moved out of AMF? Should the user authentication function (Authentication Server Function (AUSF) in 5GS) be part of the CN control plane? These questions assume even more importance in the upcoming 6GS era, where a massive increase in the number of UEs is expected and an accompanying growth in end-user signalling has the potential to over-burden the network control plane. In one of our earlier works [12], we briefly analysed these questions.

In order to bring in additional enhancements to mobile network architecture, especially to its control plane, we propose to separate end user (User Equipment (UE)) signalling handling from the control plane functions. In a significant departure from the existing cellular networks, the proposed architecture views UE signalling as payload, i.e., a form of data traversing through the cellular network, not much different from other types of data such as Video streaming or Web browsing. We analyse the proposed architecture using Performance Evaluation Process Algebra (PEPA) [13], a formal language used to model distributed systems. We also provide a comparative analysis of the proposed architecture and the existing 5GS architecture through example call flows for Protocol Data Unit (PDU) session establishment and UE handover procedures. We demonstrate a significant reduction in the number of control messages exchanged in the proposed architecture along with the network’s scalability.

The rest of the paper is organised as follows: Section II provides limitations of the existing 5GS mobile network architecture. Section III provides an overview of the proposed architecture and highlights its advantages. Section IV includes an information flow comparison of the existing and proposed architecture for PDU session establishment and handover procedures. Section V describes the system model using PEPA. Section VI covers the performance analysis. Section VII provides the conclusion and future work.

II. LIMITATIONS OF EXISTING 5GS ARCHITECTURE

In this section, we have captured some of the limitations of the existing 5GS architecture especially that of its control plane. Although there can be other limitations too say pertaining to radio technology, etc., those are not discussed here.

A. Tight coupling of user plane control and UE signalling in control plane

The existing 5GS architecture supports the control and user plane separation. The 5GS control plane performs user plane control (network resource control, e.g., setting up data path through the user plane) and UE signalling handling functionalities (e.g., NAS/RRC (Radio Resource Control) message exchange with UEs). There is a tight coupling between these two categories of functionalities, i.e., between user plane control and UE signalling handling and certain CN (e.g., AMF) and RAN gNodeB-Centralized Unit-Control Plane (gNB-CU-CP) control plane functions in the existing 5GS perform both. A detailed description of control plane functionality is provided in [14]. As demonstrated here, decoupling of UE signalling handling functionality from User plane control functionality may lead to a more modular and scalable network architecture.

B. Limited alignment with SDN paradigm

SDN is a networking paradigm which separates the control plane of a network from its user (data) plane and centralizes the network’s intelligence in the control plane. Although there are differing views in industry/academia on how to define an SDN-based network architecture, we can still discern a broad agreement on the topic [5], [15], [16]. The existing 5GS architecture incorporates the concept of SDN, resulting in architectural features such as the separation of the user plane from the control plane [14]. However, closer observation shows that the 5GS architecture does not align completely with the SDN paradigm. Besides controlling the user plane, the 5GS control plane also exchanges signalling messages with UEs to provide services such as authentication and also collect service requirements, e.g., requirements for PDU connectivity service. The functionality of signalling exchange with UEs may fit better within the service plane instead of the control plane.

C. Non-uniform handling of services

Services in the existing 5GS can be categorized into the following two types:

- 1) Application-based services such as Media streaming services, IP Multimedia subsystem services, Mission-critical services, Multicast/Broadcast Services (MBS) etc.
- 2) Other than these application-based services, the 5GS network also provides services such as initial access, registration, authentication, PDU connectivity (connectivity to data networks), and connected mode mobility support. Such services can be called built-in (or intrinsic) network services.

The two categories of services (Application based services and built-in network services) are enabled differently in the 5GS. As Application (Service) Functions (AFs) are independent and decoupled from the core and RAN functions of mobile networks, they access the control plane functions of the mobile CN over a standardized interface to enable service delivery through the user plane. However, the delivery of built-in services is tightly integrated within the control plane of the 5GS network (RAN and CN) itself. It also leads to the usage of special paths for signalling exchange with UEs, different from the regular data paths and brings certain inconsistencies to the architecture. For example, the Performance Measurement Function (PMF), a sub-function within the User Plane Function (UPF), exchanges “Measurement Assistance Information”, a type of signalling information with UEs to aid the access traffic steering, switching, and splitting (ATSSS) functionality at UPF. This signalling information is exchanged via a regular data path (i.e. user plane) between the UE and the PMF. This mechanism is different from how other signalling information such as “radio measurement reports” to support the handover procedure is exchanged.

D. Complex protocols between control plane and user plane

The existing 5GS control plane architecture impacts the interface design (protocols) between the control and user planes. For instance, F1 Application Protocol (F1AP) is the protocol used on the interface between the RAN control plane (gNB-CU-CP) and the RAN user plane (gNB-Distributed Unit (gNB-DU) or RAN-DU). It is used to configure gNB-DU and also carries RRC (UE signalling) messages for UEs. Integrating both these types of functionalities in a single protocol results in a relatively complex communication protocol between gNB-CU-CP and gNB-DU.

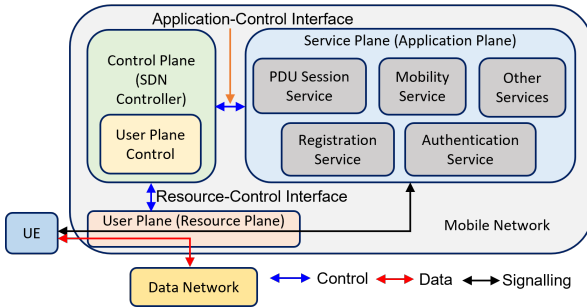

Fig. 1. Control plane architecture for proposed architecture [17]

III. SERVICE DRIVEN ARCHITECTURE FOR 6GS MOBILE NETWORKS

This section presents the proposed architecture, which addresses the architectural limitations of the existing 5GS (as discussed in Section II) and highlights a few other advantages. In the proposed work, we aim to separate the UE signalling handling from the control plane and treat them as a service to the user to enhance modularity and flexibility in the mobile network control plane. With the proposed separation, the control plane is left with only the user plane control functionality,

as shown in Fig. 1. The UE signalling handling functionality is moved out of the control plane to the service/application plane. The service plane consists of various in-built and external service functions, as shown in Fig. 1, such as the PDU Session Service Function (handles PDU session establishment and management providing PDU connectivity service), Mobility Service Function (responsible for handling UE mobility), Registration Service Function (handles UE registration with the network), Authentication Service Function (manages UE authentication), Multicast/Broadcast Services and a few others. Due to the reorganisation of the architecture, it offers various architectural and performance advantages discussed next. Please note that there may be separate controllers in the CN and RAN, as shown in Fig. 3. Similarly, we have a separate resource plane (user plane) for RAN and the CN. Further, the proposed architecture’s user or resource plane may remain the same as the 3GPP 5GS.

A. Advantages of the proposed 6GS architecture

This section highlights a few advantages of the proposed work. Segregation of UE signalling handling functionality from the control plane simplifies the control plane, which **enhances the modularity** of the control plane. The reorganised architecture also **aligns well with the SDN paradigm** as the control plane is redesigned to perform only user plane control functionality as discussed in Section II-B. The proposed architecture also allows internal (or built-in 5GS) services to be treated the same way as external application-based services, leading to **uniform handling of various services**. Further, this proposal results in the simplification of the control messages. For instance, the number of sessions management-related messages is reduced due to the setup of a direct path between UE and the service function (detailed in Section IV-B), leading to **simplified call flows**. Also, the number of hops between the RAN controller and the CN controller in the proposed architecture is less than the corresponding entities in 5GS, i.e., between gNB-CU-CP and the Session Management Function (SMF), respectively, which further results in the performance improvement in terms of control plane latency and resource utilisation. Transposition of UE signalling handling functionality to functions in service plane **simplifies the protocols** between the control plane and the user plane such as Next Generation Application Protocol (NGAP) between the CN control plane and RAN and F1AP between the RAN control plane (gNB-CU-CP) and the RAN user plane (gNB-DU).

The existing 5GS uses the same type of signalling messages for all use cases. However, it is possible to have different signalling requirements for different use cases, e.g., the Internet of Things (IoT) and human users. The proposed architecture may support this requirement by employing **use case specific signalling** service functions. Our proposal can also support **flexible function deployment and chaining** as various service functions, such as the PDU session service function, mobility service function, registration service function, and authenti-

cation service function, can be placed flexibly and chained together to serve UEs.

An additional advantage towards signalling security is presented here. 3GPP specification [18] highlights the exposed AMF which is vulnerable to replay attacks of NAS signalling messages between the UE and AMF (control plane of the CN). In a similar way, [19] presents the exposed RAN which is susceptible to replay attacks to RRC signalling messages between the UE and RAN (gNB-CU-CP (control plane of RAN)) as the Uu interface also carries sensitive RRC signalling. Furthermore, the European Union Agency for Cybersecurity (ENISA) [20], in its report recommends that the N2 interface between the 5GS RAN and AMF is a target for attackers since they carry sensitive signalling between the RAN and the CN. Therefore, in this context, the proposed architecture may have some advantages towards the **UE signalling security** between the UE and the signalling service function. Since UE signalling is segregated from the control plane (of RAN and CN) and is terminated to a separate signalling server, it leads to the possibility of localizing the attack originating from a UE within the signalling server without compromising the network control plane where the architectural and logical control and management of RAN and CN are located. This segregation allows us to improve the UE-related signalling security of future mobile networks.

IV. INFORMATION FLOW COMPARISON

In this section, we compare the information flows of the proposed architecture and the existing 5GS architecture. We consider the PDU session establishment and mobility services example to differentiate the working of the existing 5GS and the proposed architectures.

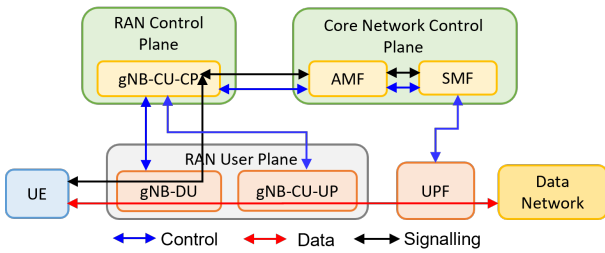

Fig. 2. Network entities, signalling and control message flow for PDU session establishment in 5GS

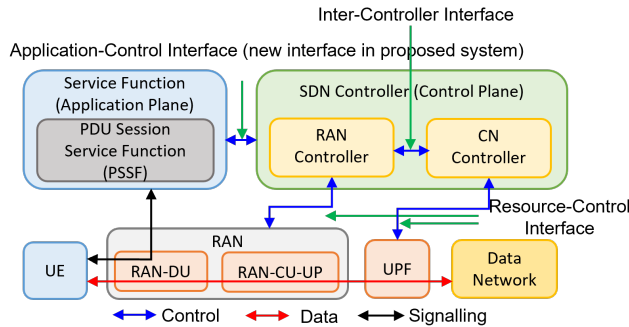

Fig. 3. Network entities, signalling and control message flow for PDU session establishment in the proposed architecture

A. PDU session establishment as a service

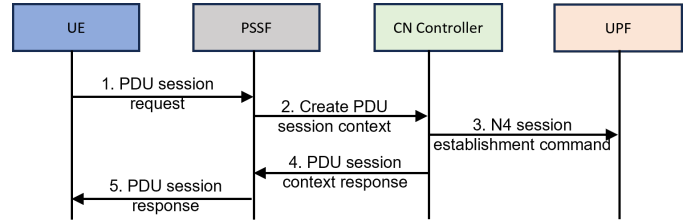

Fig. 4. PDU session establishment procedure in the proposed architecture

Fig. 2 and Fig. 3 show the entities involved in PDU session signalling for the 5GS and the proposed architecture, respectively. In 5GS, messages are exchanged between UE and SMF for PDU session-related signalling via RAN (it requires both gNB-DU and gNB-CU) and AMF. However, signalling messages are directly exchanged between UE and the (PDU session service function (PSSF)) service function via RAN (it requires only RAN-DU) in the proposed architecture, as shown in Fig. 3, which implies that in the existing 5GS, signalling takes place through multiple hops. In contrast, the number of hops is reduced in the proposed architecture. Further, the control plane collects all requirements from the PSSF (which in turn are received by PSSF from the UE as shown in Fig. 3) via the application-control interface and establishes the PDU session.

The complete message sequences for establishing PDU sessions for the existing 5GS are detailed in [17] while simplified call flow for the proposed architecture is shown in Fig. 4¹. Please note that the controllers do not require response messages from the resource (user) plane, as the controller knows about user plane resource information; it handles resource decision-making. Therefore, the proposed architecture eliminates many such messages. For example, the N4 session modification request and response are exchanged between SMF and UPF in 5GS architecture [17], while the session modification command (message 3 in Fig. 4 and message 9 in Fig. 7) is exchanged between the CN controller and CN user plane (UPF) in the proposed architecture. There is no need for a session modification response message from the UPF. Hence, these reductions in the messages simplify both the session establishment and mobility procedure (to be discussed next). Please note that even though using RAN-User Plane (RAN-UP) and other network functions/messages is necessary, we have shown only the CN functions in the call flow to keep the analysis tractable even though RAN functions will also be required in real systems. However, keeping the RAN functions out of the call flows is not likely to alter the conclusions drawn here. This note applies to mobility services also.

B. Mobility as a service

We consider mobility as another service to illustrate the difference between the existing 5GS and the proposed ar-

¹In call flows and simulations, only those messages are considered and compared which are different in proposed and existing architectures

chitecture. Fig. 5 and Fig. 6 show the network entities, signalling and control message flow of the existing 5GS and proposed architecture, respectively. S-DU and T-DU represent source gNB-DU and target gNB-DU, respectively. Similarly, the Source-Centralized Unit-User Plane (S-CU-UP) and Target-Centralized Unit-User Plane (T-CU-UP) represent source gNB-CU-UP and target gNB-CU-UP, respectively. S-CU-CP and T-CU-CP represent source gNB-CU-CP and target gNB-CU-CP, respectively. Also, the interaction between the RAN controller and the CN controller is through the inter-controller interface, as shown in Fig. 6. Signalling takes place between UE and MSF via S-DU before handover while after handover it is through T-DU. Likewise, the data path between UE and UPF is by way of S-UP before handover while it is via T-UP after handover.

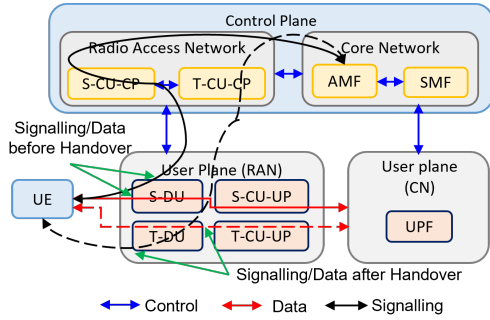

Fig. 5. Network entities, signalling and control message flow in case of mobility service for the existing 5GS architecture

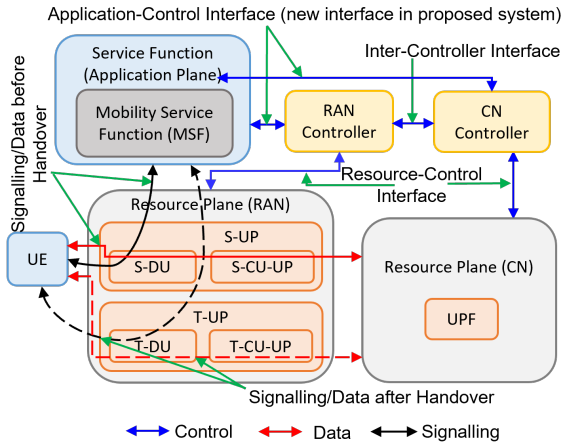

Fig. 6. Network entities, signalling and control message flow in case of mobility service for the proposed architecture

Mobility call flow for the existing 5GS is available in [17]. Fig. 7 shows the mobility call flow which illustrates the handover procedure of the proposed architecture. For the sake of simplicity, splitting S-UP into S-DU and S-CU-UP, T-UP into T-DU and T-CU-UP is not shown. However, the reason behind the simplification of mobility procedure/messages is the same as explained for PDU session establishment in Section IV-B.

V. SYSTEM MODEL

This section presents the system model for the proposed architecture using PEPA. PEPA is a formal high-level language

TABLE I
SYSTEM MODEL FOR PDU SESSION ESTABLISHMENT

PDU session establishment	
PEPA Modules	Code Description
UE NF	$Ue_1 \stackrel{def}{=} (acc_{uep}, r_a).(process, r_{iat}).Ue_2$ $Ue_2 \stackrel{def}{=} (req_{pduse}, r_r).(rep_{pduse}, r_r).Ue_1$
PSSF NF	$Pssf_1 \stackrel{def}{=} (req_{pduse}, r_r).Pssf_2$ $Pssf_2 \stackrel{def}{=} (acc_{pssf}, r_a).(process, r_p).Pssf_3$ $Pssf_3 \stackrel{def}{=} (req_{sc}, r_r).(rep_{sc}, r_r).Pssf_4$ $Pssf_4 \stackrel{def}{=} (acc_{pssf}, r_a).(process, r_p).Pssf_5$ $Pssf_5 \stackrel{def}{=} (rep_{pduse}, r_r).Pssf_1$
CN Controller NF	$Con_1 \stackrel{def}{=} (req_{sc}, r_r).Con_2$ $Con_2 \stackrel{def}{=} (acc_{comp}, r_a).(process, r_p).Con_3$ $Con_3 \stackrel{def}{=} (req_{n4est}, r_r).(rep_{n4est}, r_r).Con_4$ $Con_4 \stackrel{def}{=} (acc_{comp}, r_a).(process, r_p).Con_5$ $Con_5 \stackrel{def}{=} (rep_{sc}, r_r).Con_1$
UPF NF	$Upf_1 \stackrel{def}{=} (req_{n4est}, r_r).Upf_2$ $Upf_2 \stackrel{def}{=} (acc_{upfp}, r_a).(process, r_p).Upf_1$
UE Processor	$Uep_1 \stackrel{def}{=} (acc_{uep}, r_a).Uep_2$ $Uep_2 \stackrel{def}{=} (process, r_p).Uep_1$
PSSF Processor	$Pssfp_2 \stackrel{def}{=} (process, r_p).Pssfp_1$
CN Controller Processor	$Comp_1 \stackrel{def}{=} (acc_{comp}, r_a).Comp_2$ $Comp_2 \stackrel{def}{=} (process, r_p).Comp_1$
UPF Processor	$Upfp_1 \stackrel{def}{=} (acc_{upfp}, r_a).Upfp_2$ $Upfp_2 \stackrel{def}{=} (process, r_p).Upfp_1$
System Equation	$((Ue_1[n] \bowtie_{L_1} Pssf_1[N_{pssf}.N_{pssf_p}.N_t])$ $\bowtie_{L_2} Con_1[N_{con}.N_{comp}.N_t])$ $\bowtie_{L_3} Upf_1[N_{upf}.N_{upfp}.N_t])$ $\bowtie_{L_4} ((Uep_1[n] \phi Pssfp_1[N_{pssf}.N_{pssf_p}])$ $\phi Comp_1[N_{con}.N_{comp}])$ $\phi Upfp_1[N_{upf}.N_{upfp}])$
Cooperation Set	$L_1 = \langle req_{pduse}, rep_{pduse} \rangle$ $L_2 = \langle req_{sc}, rep_{sc} \rangle$ $L_3 = \langle req_{n4est} \rangle$ $L_4 = \langle acc_{uep}, process, acc_{pssf},$ $acc_{comp}, acc_{upfp} \rangle$ $\phi = \langle \rangle$

for the quantitative modelling of a distributed system [13]. Table I and Table II represent the system model for the proposed architecture for the PDU session establishment and mobility procedures, respectively. To explain the system model, we use the PDU session establishment (or session establishment) procedure (shown in Fig. 4).

The session establishment procedure requires PSSF, CN controller and UPF as the key CN functions in the proposed architecture. These NFs are modelled as PEPA components. In addition, a UE is also modelled as a PEPA component. Each PEPA component (representing UE or a CN NF) goes through a set of states during the handling of the procedure. The individual component states are denoted by associating a unique number with the name of the component (e.g., $Pssf_1$, represents the first state of component, PSSF). Each component performs a set of actions, such as accessing the processor or sending a request/response. These actions are denoted in lowercase, and subscripts are added to provide further distinction (as $action_{actiondetail}$). For example, the notation for the action of PDU session establishment request and response can be req_{pduse} and rep_{pduse} , respectively.

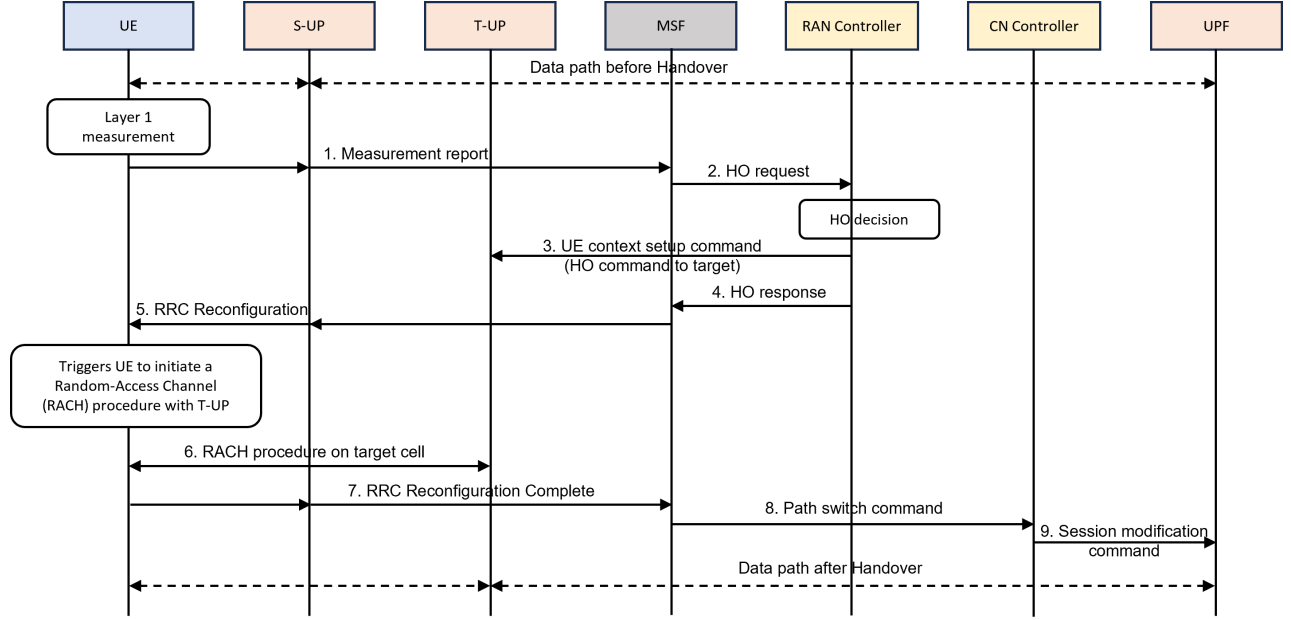

Fig. 7. Mobility procedure in the proposed architecture

Each action is associated with a specific rate value, r . The rate (number of actions performed per unit time) models the expected duration of the action in the PEPA component and is taken as reference from [21], [22] and [23].

Let us now understand the details of modelling of NF states as shown in Table I. Consider UE as an example. The UE acquires the processor in its initial state (acc_{uep} , r_a) and performs the processing action ($process$, r_{iat}) before sending a request. The second state, Ue_2 , models the request (req_{pduse} , r_r) and response (rep_{pduse} , r_r) messages exchanged between UE and PSSF for the PDU session establishment. NFs acquire processors to process a request/response. In Table I, UEP, PSSFP, CONP and UPFP are the processing entities for UE, PSSF, CN controller (CON) and UPF respectively. These processing entities are modelled such that each NF processor has two states. For instance, the first state of UEP, Uep_1 , is for acquiring the processor (acc_{uep}), and the second state, Uep_2 , performs the processing action ($process$). Similarly, the other NFs and their processing entities are modelled.

As discussed in this section, the system model uses the following additional parameters: n denotes the number of UEs; N_{pssf} , N_{con} , and N_{upf} are the number of NF instances for PSSF, CN controller (CON), and UPF, respectively. Similarly, N_{pssf_p} , N_{con_p} , and N_{upf_p} are the number of PSSF processor (PSSFP), CN controller processor (CONP) and UPF processor (UPFP), respectively. Please note that each processor can handle a set of concurrent threads, N_t . Thus, the product $N_{nf} \cdot N_{nf_p} \cdot N_t$ (as mentioned in the system model equation) represents the total number of threads for a type of NF. Moreover, the product $N_{nf} \cdot N_{nf_p}$ is the total number of processors allocated to a type of NF, e.g., for UPF processor.

The system equation represents the overall system model. The cooperation operator (“ \bowtie ”), for example, $A \bowtie_L B$, models the interactions between NFs A and B over the actions defined in the cooperation set L . It can be noted that it is possible that

component $A \bowtie_L B$ will have different behaviour from component $A \bowtie_K B$ if $L \neq K$. Let us consider an example from Fig. 4, where PSSF and CN controller (CON) interact with each other for session context request/response req_{sc}/rep_{sc} . These actions are defined in cooperation set L_2 , as shown in Table I. Therefore, the system equation $Pssf_1[N_{pssf} \cdot N_{pssf_p} \cdot N_t] \bowtie_{L_2} Con_1[N_{con} \cdot N_{con_p} \cdot N_t]$, models the interaction between PSSF and CN controller over the cooperation set L_2 . In a similar way, the overall system equation, as shown in Table I and Table II represents the interaction between the various NFs as shown in the two call flows, Fig. 4 and Fig. 7, respectively.

VI. PERFORMANCE EVALUATION

This section presents the performance comparison between the existing 5GS and the proposed architecture analysed using the PEPA Eclipse plug-in [24], a software tool integrated into the popular Eclipse platform. This tool supports various performance measures [22] as discussed below, which help evaluate the network’s performance.

- 1) **Session establishment rate (or the number of successful handovers in the case of mobility):** The number of session establishments are measured for the action (say, rep_{pduse} , which describes the completion of the session establishment procedure), representing the session establishment rate. Similarly, the number of successful handovers is measured for the action ‘*session*’ (as performed by UPF NF in Table II), which signifies the completion of the handover procedure.
- 2) **Average response time:** It measures the UE waiting time for any specific request and reflects the system’s operating speed. We consider the average response time as the duration of the completion of the session establishment procedure. Similarly, we consider the mobility procedure’s average response time as the completion of the handover procedure.

TABLE II
SYSTEM MODEL FOR MOBILITY

Mobility	
PEPA Modules	Code Description
UE NF	$Ue_1 \stackrel{def}{=} (acc_{uep}, r_a).(measure, r_{iat}).Ue_2$ $Ue_2 \stackrel{def}{=} (reconfig, r_r).Ue_3$ $Ue_3 \stackrel{def}{=} (rachreq, r_r).(rachres, r_r).Ue_4$ $Ue_4 \stackrel{def}{=} (reconfigcomp, r_r).Ue_1$
T-UP NF	$Upt_1 \stackrel{def}{=} (pathsetup, r_r).Upt_2$ $Upt_2 \stackrel{def}{=} (acc_{uptp}, r_a).(process, r_p).Upt_3$ $Upt_3 \stackrel{def}{=} (rachreq, r_r).(rachres, r_r).Upt_1$
MSF NF	$Msf_1 \stackrel{def}{=} (measure, r_r).Msf_2$ $Msf_2 \stackrel{def}{=} (acc_{msfp}, r_a).(horeq, r_r).Msf_3$ $Msf_3 \stackrel{def}{=} (hores, r_r).Msf_4$ $Msf_4 \stackrel{def}{=} (acc_{msfp}, r_a).(reconfig, r_r).Msf_5$ $Msf_5 \stackrel{def}{=} (reconfigcomp, r_r).Msf_6$ $Msf_6 \stackrel{def}{=} (acc_{msfp}, r_a).$ $(pathswitch, r_r).Msf_1$
RAN Controller NF	$Ran_1 \stackrel{def}{=} (horeq, r_r).Ran_2$ $Ran_2 \stackrel{def}{=} (acc_{ranp}, r_a).(pathsetup, r_r).$ $(hores, r_r).Ran_1$
CN Controller NF	$Cn_1 \stackrel{def}{=} (pathswitch, r_r).Cn_2$ $Cn_2 \stackrel{def}{=} (acc_{cnp}, r_a).(session, r_r).Cn_1$
UPF NF	$Upf_1 \stackrel{def}{=} (session, r_r).Upf_2$ $Upf_2 \stackrel{def}{=} (acc_{upfp}, r_a).(process, r_p).Upf_1$
UE Processor	$Uep_1 \stackrel{def}{=} (acc_{uep}, r_a).Uep_2$ $Uep_2 \stackrel{def}{=} (measure, r_{iat}).Uep_1$
T-UP Processor	$Uptp_1 \stackrel{def}{=} (acc_{uptp}, r_a).Uptp_2$ $Uptp_2 \stackrel{def}{=} (rachreq, r_r).Uptp_1$ $+(rachres, r_r).Uptp_1$
MSF Processor	$Msfp_1 \stackrel{def}{=} (acc_{msfp}, r_a).Msfp_2$ $Msfp_2 \stackrel{def}{=} (horeq, r_r).Msfp_1 + (reconfig, r_r).$ $Msfp_1 + (pathswitch, r_r).Msfp_1$
RAN Processor	$Ranp_1 \stackrel{def}{=} (acc_{ranp}, r_a).Ranp_2$ $Ranp_2 \stackrel{def}{=} (pathsetup, r_r).(hores, r_r).Ranp_1$
CN Processor	$Cnnp_1 \stackrel{def}{=} (acc_{cnp}, r_a).Cnnp_2$ $Cnnp_2 \stackrel{def}{=} (session, r_r).Cnnp_1$
UPF Processor	$Upfp_1 \stackrel{def}{=} (acc_{upfp}, r_a).Upfp_2$ $Upfp_2 \stackrel{def}{=} (session, r_r).Upfp_1$
System Equation	$\begin{aligned} & (((Ue_1[n]_{L_1}^{\times} Upt_1[N_{upt}.N_{uptp}.N_t]) \\ & \times_{L_2} Msf_1[N_{msf}.N_{msfp}.N_t]) \\ & \times_{L_3} Ran_1[N_{ran}.N_{ranp}.N_t]) \\ & \times_{L_4} Cn_1[N_{cn}.N_{cnp}.N_t]) \\ & \times_{L_5} Upf_1[N_{upf}.N_{upfp}.N_t]) \\ & \times_{L_6} (((Uep_1[n]_{\phi}^{\times} Uptp_1[N_{uptp}.N_{uptp}]) \\ & \times_{\phi} Msfp_1[N_{msf}.N_{msfp}]) \\ & \times_{\phi} Ranp_1[N_{ran}.N_{ranp}]) \\ & \times_{\phi} Cnnp_1[N_{cn}.N_{cnp}]) \\ & \times_{\phi} Upfp_1[N_{upf}.N_{upfp}]) \end{aligned}$
Cooperation Set	$L_1 = \langle rachreq, rachres \rangle$ $L_2 = \langle measure, reconfig, reconfigcomp \rangle$ $L_3 = \langle pathsetup, horeq, hores \rangle$ $L_4 = \langle pathswitch \rangle$ $L_5 = \langle session \rangle$ $L_6 = \langle acc_{uep}, acc_{uptp}, acc_{msfp}, acc_{ranp}, acc_{cnp}, acc_{upfp} \rangle$ $\phi = \langle \rangle$

- 3) **Utilisation:** Utilisation measures the NFs processor capacity utilised during the procedure. The utilisation of any NF (for example, *PSSF* processor) is derived from its population level (one of the features available in the tool) while performing any process.
- 4) **Scalability:** Scalability (S), in simple terms, measures a network's ability to increase or decrease its size, performance and cost in response to changes in system processing demands. Alternatively, according to Equation 1, scalability can be defined as the ratio between the productivity of a system at two configurations (configuration here implies the number of NFs used) having different scales, say m_1 and m_2 [25], which corresponds to the different numbers of NFs used in the network, say $m_1 = (1,1,1)$ and $m_2 = (3,3,1)$. The mathematical expression for scalability is given as [25]:

$$S(m_1, m_2) = \frac{C(m_2)}{C(m_1)} \quad (1)$$

Where, $C(m)$ is the productivity of a system at the scale m , given by (Equation 2):

$$C(m) = \frac{t(m) \cdot r(m)}{U(m)} \quad (2)$$

Where $t(m)$ is the average number of sessions established at scale m , $U(m)$ is the processor utilisation of the system at scale m , and $r(m)$ (Equation 3) is determined by evaluating the response time performance of the scaled system. We consider the following equation [25] to evaluate the performance function $r(m)$ by using the average response time $T(m)$, at scale m , with the target average response time T [22].

$$r(m) = \frac{1}{1 + T(m)/T} \quad (3)$$

A. Results and Analysis

In this section, we present the performance results for 5GS and the proposed architecture in the case of PDU session establishment service and mobility service.

1) **PDU Session Establishment Service:** The performance analysis of the proposed architecture and the existing 5GS for the session establishment procedure is discussed in this section. Fig. 8 and Fig. 9 show the session establishment rate with respect to the number of UEs for 5GS and the proposed architecture using two different configurations. For instance, $(N_{pssf}, N_{con}, N_{upf}) = (1,1,1)$ for the proposed architecture is the basic configuration with single NF assigned and $(N_{pssf}, N_{con}, N_{upf}) = (3,3,1)$ is the configuration for a scaled system with three NFs assigned to PSSF and CON while one to UPF. Similarly, basic and the scaled configuration for 5GS is defined as $(N_{amf}, N_{smf}, N_{upf}) = (1,1,1)$ and $(N_{amf}, N_{smf}, N_{upf}) = (3,3,1)$, respectively.

Results show that the proposed architecture can achieve a higher session establishment rate compared to the existing 5GS in case of both basic and scaled configurations. Although the session establishment rate has increased using a scaled

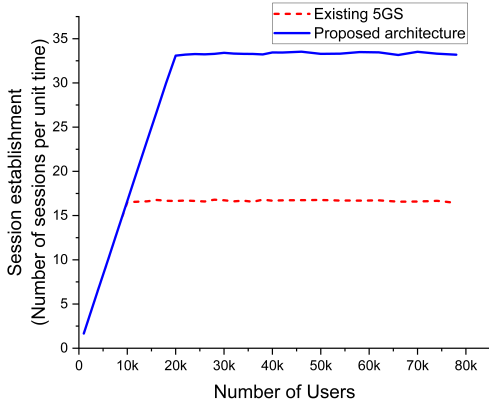

Fig. 8. Session establishment (number of sessions per unit time) for the proposed and the 5GS architecture having the basic configuration

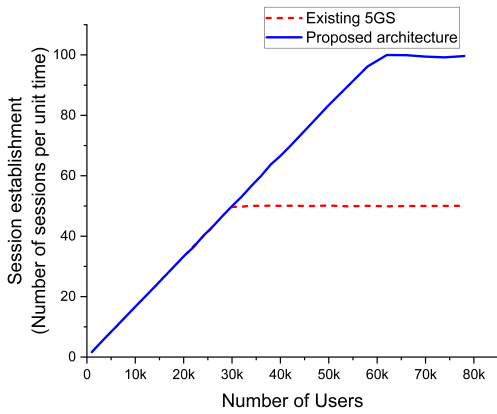

Fig. 9. Session establishment (number of sessions per unit time) for the proposed and the 5GS architecture having the scaled configuration

configuration for proposed and existing architectures compared to the session establishment rate achieved using a basic configuration, the proposed architecture has achieved a higher session establishment rate than the 5GS. The saturation point for existing 5GS, as shown in Fig. 8, is around 10,000 users i.e. it can serve a maximum number of 10,000 users while the session establishment rate for the proposed architecture saturates at around 20,000 users. Similarly, Fig. 9 shows that 5GS saturates at around 34,000 users. As the saturation point is reached, the network drops the incoming requests from the users. This means that with the given number of processors/NFs, the proposed architecture can achieve a higher session establishment rate. In contrast, more processors/NFs are required to support more number of session establishments.

The processor utilisation for all the NFs of the existing 5GS and the proposed architecture for basic and the scaled configuration is shown in Fig. 10 and Fig. 11, respectively. For instance, the PSSFP reaches its maximum utilisation explaining the saturation point for the session establishment rate. Although at this point, CONP and UPFP are not fully utilised. These results show that the request processing chain fails if an NF becomes a bottleneck for the consecutive chain.

Scalability for the existing 5GS and the proposed architec-

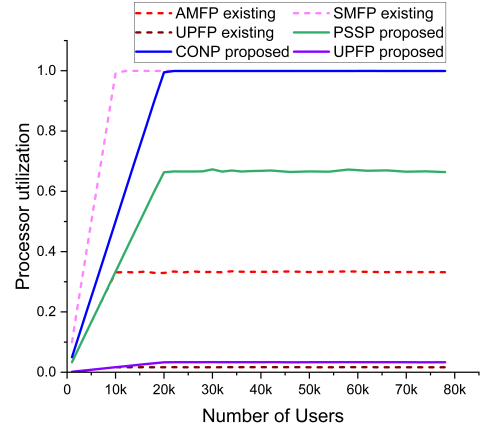

Fig. 10. Processor utilisation of session establishment for the proposed and the 5GS architecture having the basic configuration

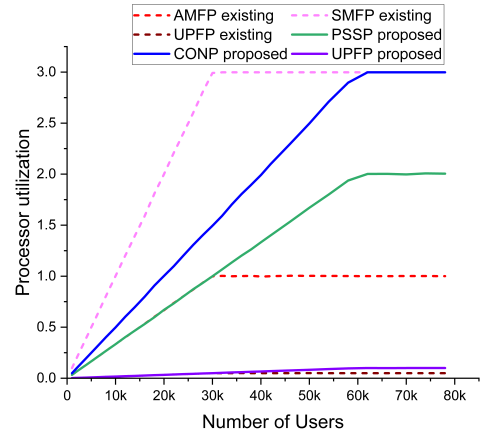

Fig. 11. Processor utilisation of session establishment for the proposed and the 5GS architecture having scaled configuration

ture is evaluated based on Equation 1. It is plotted in Fig. 12 based on the results obtained for session establishment rate, average response time and utilisation from the PEPA-based simulation and modelling. As stated earlier, we consider the following two configurations m_1 and m_2 for estimating the scalability metric. Fig. 12 shows that the existing 5GS can serve 10,000 users for a basic configuration, and the proposed architecture can serve 20,000 users. Similarly, the existing 5GS reaches its saturation point at 34,000 users, and the proposed architecture saturates at 62,000 users for scaled configuration. Therefore, it implies that the proposed architecture performs better and can serve more users than the existing 5GS. Besides, the proposed is more scalable with increased users for the same number of NFs/processors. Please note that a similar explanation for all the performance measures (successful handovers, processor utilization and scalability) holds in the case of mobility service.

2) **Mobility Service:** This section presents the comparative analysis of the existing 5GS and the proposed architecture for the mobility service. Similar to the session establishment, the analysis is performed for the basic and the scaled configurations. Therefore, the basic configuration for the proposed

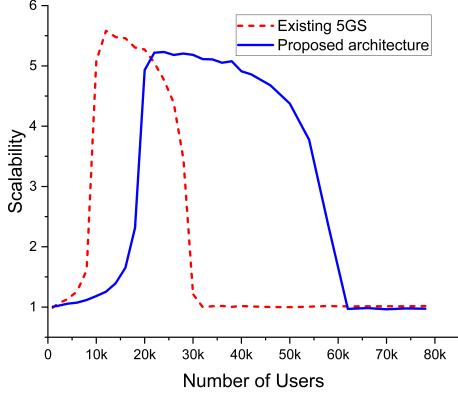

Fig. 12. Scalability of PDU session for 5GS and the proposed architecture

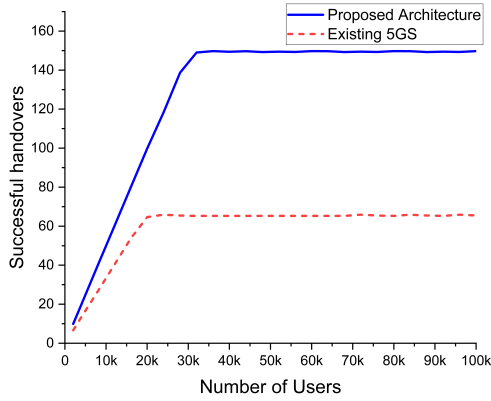

Fig. 13. Number of successful handovers per unit time for the proposed and the 5GS architecture having the basic configuration

architecture is given as $(N_{upt}, N_{msf}, N_{ran}, N_{cn}, N_{upf}) = (1, 2, 2, 1, 1)$ and for the 5GS architecture is $(N_{sdu}, N_{scu}, N_{tdu}, N_{tcu}, N_{amf}, N_{smf}, N_{upf}) = (1, 1, 1, 1, 1, 1, 1)$. Similarly, the scaled configuration for the proposed architecture is $(N_{upt}, N_{msf}, N_{ran}, N_{cn}, N_{upf}) = (3, 6, 6, 3, 3)$ and for the 5GS architecture is given as $(N_{sdu}, N_{scu}, N_{tdu}, N_{tcu}, N_{amf}, N_{smf}, N_{upf}) = (3, 3, 3, 3, 3, 3, 3)$. Here $N_{upt}, N_{msf}, N_{ran}, N_{cn}, N_{upf}$ are the number of Target-User Plane (T-UP), MSF, RAN controller, CN controller and UPF respectively in the system model. Similarly, $N_{sdu}, N_{scu}, N_{tdu}, N_{tcu}, N_{amf}, N_{smf}, N_{upf}$ are the number of S-DU, S-CU, T-DU, T-CU, AMF, SMF, and UPF respectively. Please note that for brevity, we have not split S-CU into S-CU-CP and S-CU-UP and T-CU into T-CU-CP and T-CU-UP while modelling the mobility call flow procedure for the 5GS. Further, we provide an equal number of functions and associated processors to the 5GS and the proposed architecture for justified comparison.

After reaching the saturation point, the system starts to drop handovers. Fig. 13 and Fig. 14 show that the proposed architecture serves more successful handovers per unit time compared to the existing 5GS for both the basic and the scaled configurations, respectively. The saturation point for the existing 5GS is 20,000 users, while for the proposed,

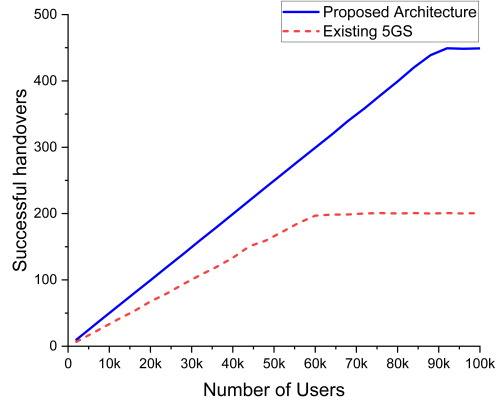

Fig. 14. Number of successful handovers per unit time for the proposed and the 5GS architecture having the scaled configuration

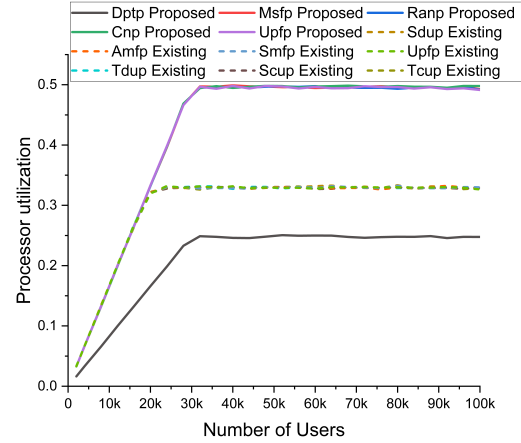

Fig. 15. Processor Utilization in case of mobility for the proposed and the 5GS architecture having the basic configuration

the saturation is 30,000 users for the basic configuration. Similarly, the saturation point for the existing 5GS is around 60,000 users, while for the proposed, the saturation is around 90,000 users for the scaled configuration. The number of successful handovers per unit of time has increased using a scaled configuration for both architectures.

Fig. 15 and Fig. 16 are the result of processor utilisation for both the 5GS and the proposed architecture. Fig. 17 shows the scalability results in the case of mobility service for 5GS and the proposed architectures. It can be observed from the scalability results that 5GS reaches its saturation point earlier than the proposed architecture and the proposed architecture is more scalable.

VII. CONCLUSION AND FUTURE WORK

In this paper, we have proposed a novel mobile network architecture for separating the UE signalling from the network control functionality, enhancing the modularity, scalability, and flexibility of the network. The transposition of UE signalling functionality to service functions leads to simplified protocols and opens up ways to implement use case specific signalling in mobile networks. The proposed architecture also has improved alignment with the SDN principles.

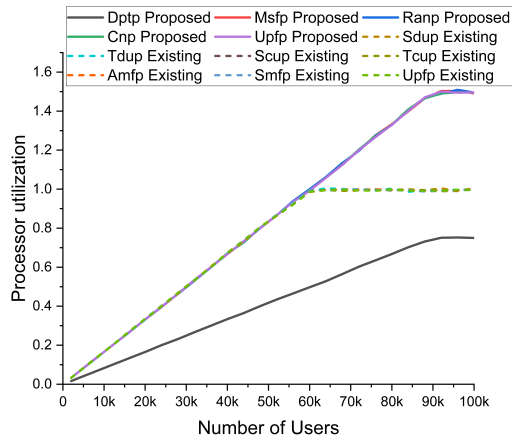

Fig. 16. Processor Utilisation in case of mobility for the proposed and the 5GS architecture having the scaled configuration

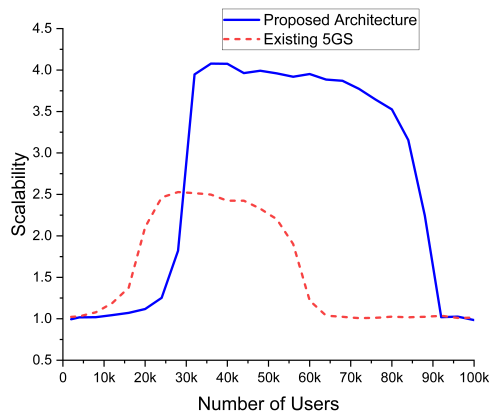

Fig. 17. Scalability in case of Mobility

We have considered PDU session establishment and mobility services as examples to analyse the performance of the proposed architecture using the PEPA-based simulation method. Based on the performance results and other benefits, it can be concluded that the proposed architecture is a promising option for future networks to handle vast and diverse traffic demands. We plan to extend this work to analyse other features/services of mobile networks, such as authentication, network slicing, development of protocols between (signalling) service functions and the control plane, and addressing security threats in the 6GS mobile network (touched upon in section III) in future.

ACKNOWLEDGMENT

We acknowledge the Ministry of Electronics and Information Technology (MeitY), India, for supporting the project.

REFERENCES

- [1] SWG IMT-2030, "Framework and overall objectives of the future development of IMT for 2030 and beyond," *Technical Recommendation*, 2023.
- [2] FG NET-2030, "Achievements of ITU-T Focus Group on Network 2030," *7th SG13 Regional Workshop for Africa on ITU-T Standardization Work on Future Networks: Towards a Better Future for Africa (Abuja, Nigeria)*, 2020.

- [3] Taksande, Pradnya Kiri and Jha, Pranav and Karandikar, Abhay, "Dual Connectivity Support in 5G Networks: An SDN based approach," in *IEEE Wireless Communications and Networking Conference (WCNC)*, 2019, pp. 1–6.
- [4] Akshatha, Nayak M. and Jha, Pranav and Karandikar, Abhay, "A Centralized SDN Architecture for the 5G Cellular Network," in *IEEE 5G World Forum (5GWF)*, 2018, pp. 147–152.
- [5] Roozbeh, Amir, "Distributed Cloud and De-centralized Control Plane: A Proposal for Scalable Control Plane for 5G," in *IEEE/ACM 8th International Conference on Utility and Cloud Computing (UCC)*, 2015, pp. 348–353.
- [6] Ueda, Tetsuro and Idoue, Akira and Utsunomiya, Eiji, "Hierarchical and Distributed Software-Defined Network to Reduce Control Load," in *IEEE Wireless Communications and Networking Conference (WCNC)*, 2019, pp. 1–6.
- [7] Abdulghaffar, Abdulaziz and Mahmoud, Ashraf and Abu-Amara, Marwan and Sheltami, Tarek, "Modeling and Evaluation of Software Defined Networking Based 5G Core Network Architecture," *IEEE Access*, vol. 9, pp. 10 179–10 198, 2021.
- [8] Zuo, Qingyun and Chen, Ming and Ding, Ke and Xu, Bo, "On Generality of the Data Plane and Scalability of the Control Plane in Software-Defined Networking," *China Communications*, vol. 11, no. 2, pp. 55–64, 2014.
- [9] Hu, Jie and Lin, Chuang and Li, Xiangyang and Huang, Jiwei, "Scalability of Control Planes for Software Defined Networks: Modeling and Evaluation," in *IEEE 22nd International Symposium of Quality of Service (IWQoS)*, 2014, pp. 147–152.
- [10] A. Tootoonchian and Y. Ganjali, "Hyperflow: A distributed control plane for openflow," in *Proceedings of the Internet Network Management Conference on Research on Enterprise Networking*, 2010, p. 3.
- [11] J. Raychev, D. Kinaneva, G. Hristov, and P. Zahariev, "Optimizing sdn control plane scalability by efficient switch to controller migration," in *27th National Conference with International Participation (TELECOM)*, 2019, pp. 42–45.
- [12] Meghna Khaturia, Akshatha Nayak Manjeshwar, Pranav Jha and Abhay Karandikar, "5G-Serv: Decoupling User Control and Network Control in the 3GPP 5G Network," in *24th Conference on Innovation in Clouds, Internet and Networks and Workshops (ICIN)*, 2021, pp. 75–79.
- [13] Hillston, J., "A Compositional Approach to Performance Modelling," *Distinguished Dissertations in Computer Science. Cambridge University Press.*, 1996.
- [14] 3GPP TS 23.501, "System Architecture for the 5G System," *Technical Specification*, 2018.
- [15] ITU-T Y.3300, "Framework of Software-Defined Networking," *Recommendation*, 2014.
- [16] ONF TR-502, "SDN Architecture," *Technical Specification*, vol. Issue 1, 2014.
- [17] 3GPP TS 23.502, "Procedures for the 5G System," *Technical Specification*, 2018.
- [18] 3GPP TS 33.512, "5G; 5G Security Assurance Specification (SCAS); Access and Mobility Management Function (AMF)," *Technical Specification*, 2022.
- [19] 3GPP TS 33.511, "5G; Security Assurance Specification (SCAS) for the next generation Node B (gNodeB) network product class," *Technical Specification*, 2022.
- [20] ENISA, "SECURITY IN 5G SPECIFICATIONS; Controls in 3GPP Security Specifications (5G SA)," *Technical Specification*, 2021.
- [21] Oliveira, E. M. R and Viana, A. C. and Naveen, K. P. and Sarraute, C., "Mobile data traffic modeling: Revealing temporal facets," *Computer Networks*, vol. 112, pp. 176–193, 2017.
- [22] Arteaga, C. H. T. and Ordoñez, A. and Rendon, O. M. C., "Scalability and Performance Analysis in 5G Core Network Slicing," *IEEE Access*, vol. 8, pp. 142086–142100, 2020.
- [23] Arteaga, C. H. T., "A 5G Core Network Prototype," *Computer Networks*, vol. 112, pp. 176–193, 2019.
- [24] Tribastone, Mirco and Duguid, Adam and Gilmore, Stephen, "The PEPA Eclipse Plugin," *SIGMETRICS Perform. Eval. Rev.*, vol. 36, no. 4, pp. 28–33, 2009.
- [25] Jogalekar, P. and Woodside, M., "Evaluating the scalability of distributed systems," *IEEE Transactions on Parallel and Distributed Systems*, vol. 11, no. 6, pp. 589–603, 2000.