

Raster Interval Object Approximations for Spatial Intersection Joins

Thanasis Georgiadis · Eleni Tzirita Zacharatou · Nikos Mamoulis

Received: date / Accepted: date

Abstract Spatial join processing techniques that identify intersections between complex geometries (e.g., polygons) commonly follow a two-step filter-and-refine pipeline. The filter step evaluates the query predicate on the minimum bounding rectangles (MBRs) of the geometries, while the refinement step eliminates false positives by applying the query on the exact geometries. To accelerate spatial join evaluation over complex geometries, we propose a *raster intervals approximation* of object geometries and introduce a powerful *intermediate* step in the pipeline. In a preprocessing phase, our method (i) rasterizes each object geometry using a fine grid, (ii) models groups of nearby cells that intersect the polygon as an interval, and (iii) encodes each interval with a bitstring capturing the overlap of each cell in it with the polygon. Going one step further, we improve our approach by approximating each object by two sets of intervals that succinctly capture the raster cells which (i) intersect with the object and (ii) are fully contained within the object. Using this representation, we show that we can verify whether two polygons intersect through a sequence of linear-time joins between the interval sets. Our approximations are effectively compressible and customizable for partitioned data and polygons of varying sizes, rasterized at differ-

ent granularities. Finally, we propose a novel algorithm that computes the interval approximation of a polygon without fully rasterizing it first, rendering the computation of approximations orders of magnitude faster. Experiments on real data demonstrate the effectiveness and efficiency of our proposal over previous work.

1 Introduction

We study the problem of computing the spatial intersection join between two spatial object collections R and S , which identifies all pairs of objects (r, s) , $r \in R$, $s \in S$ such that r shares at least one common point with s . Besides being a common operation in geographic information systems (GIS), the spatial intersection join finds a wide range of applications in geo-spatial interlinking [32], GeoSPARQL queries on RDF data stores [47], interference detection between objects in computer graphics [36], and the suggestion of synapses between neurons in neuroscience models [29]. Recently, there has been a growing interest in spatial query evaluation over complex object geometries, such as polygons [14, 15, 22, 51, 28, 31, 37, 46, 55, 56].

A naive way to evaluate the join is to run an intersection test algorithm from computational geometry for each pair (r, s) in $R \times S$. However, this method is extremely expensive, since (i) the number $|R \times S|$ of pairs to be tested can be huge and (ii) for each pair the test takes $O(n \log n)$ time [9]. To mitigate (i), the join is evaluated in two steps. Provided that the minimum bounding rectangles (MBRs) of the objects are available (and possibly indexed), in the *filter step*, an efficient MBR-join algorithm [10, 49] is used to find the pairs of objects $(r, s) \in R \times S$ such that $MBR(r)$ intersects with $MBR(s)$. In the *refinement step*, for each

T. Georgiadis
Department of Computer Science & Engineering, University of Ioannina, Greece
E-mail: ageorgiadis@cs.uoi.gr

E. Tzirita Zacharatou
IT University of Copenhagen, Denmark
E-mail: elza@itu.dk

N. Mamoulis
Department of Computer Science & Engineering, University of Ioannina, Greece
E-mail: nikos@cs.uoi.gr

pair that passes the filter step, the expensive intersection test on the exact object geometries is applied. To further reduce the number of pairs needing refinement, *intermediate filters* can be added to the pipeline [9, 58]. The main idea is to use object approximations, in addition to the MBR, that can help to quickly determine whether a candidate pair (r, s) that passes the MBR filter is (i) a sure result, (ii) a sure non-result, or (iii) an indecisive pair, for which we still have to apply the geometry intersection test. Brinkhoff et al. [9] investigated the use of different object approximations (e.g., the convex hull) to be used as subsequent filters after MBR-intersection. Zimbrao and de Souza [58] proposed a more effective *raster* object approximation, where each object MBR is partitioned using a grid and the object is approximated by the percentages of grid cell areas that the object overlaps. This approach has several limitations. First, the raster object representations may occupy a lot of space. Second, the approximations of two candidate objects may be based on grids of different scales; their re-scaling and subsequent comparison can be quite expensive. Third, the cost of comparing two rasters in order to filter a candidate pair is linear to the number of cells in the rasters.

In a preliminary version of our work [18], we introduce *Raster Intervals* (RI); a raster approximation technique for polygonal objects, which does not share the drawbacks of [58] and reduces the end-to-end spatial join cost up to 10 times, when we use it as a pre-refinement, intermediate filter. Our technique uses a *global fine grid* to approximate all objects, hence, no re-scaling issues arise. In addition, RI encodes each cell by a 3-bit sequence; whether two objects overlap in a cell can be determined by bit-wise ANDing the corresponding sequences. Finally, RI models the set of cells that approximate an object o by a sorted list of *raster intervals*, determined by the Hilbert curve order of continuous cells in o 's representation. For each such interval, we unify in a bitstring all 3-bit sequences of the included cells. Object pair filtering is then implemented as a merge join between the corresponding raster interval lists. For each pair of intersecting intervals, the sub-bitstrings corresponding to the common cells are ANDed to find whether there is at least one cell wherein the polygons overlap.

Despite its effectiveness and efficiency compared to previous filters, RI has a relatively high preprocessing cost and occupies significant space. In this extended version of [18] we propose APRIL (Approximating Polygons as Raster Interval Lists), a significant improvement over RI. Unlike [58, 18] that divide the raster cells intersecting a polygon into three classes, APRIL uses only two cell classes, which improves storage efficiency

and accelerates the intermediate filter. Second, the main novelty of APRIL lies in the way it represents objects using *two lists of intervals*: the first (*A-list*) includes all cells, regardless of their class, and the second (*F-list*) includes only cells that are fully covered by the object. The intermediate filter is then implemented as a sequence of three simple merge joins between the sorted interval lists of a given object pair. The first join, performed between the two *A-lists*, effectively identifies all true negatives. The last two joins, performed between one object's *A-list* and the other object's *F-list*, identify true positives. Since APRIL does not explicitly store or encode cell-class information and does not perform cell-specific comparisons, it is significantly faster than previous raster approximations. Finally, APRIL applies a compression technique based on delta encoding to greatly reduce the space required to store the interval lists. As a result, APRIL approximations may require even less space than object MBRs, allowing them to be stored and processed in main memory. Moreover, APRIL's compression scheme allows partial, on-demand decompression of interval lists during interval join evaluation.

In addition to improving RI to APRIL, in this paper we show the generality of APRIL in supporting spatial selection queries, spatial within joins, and joins between polygons and linestrings. Furthermore, we present a space partitioning approach, which increases the resolution of the raster grid and achieves more refined object approximations as necessary, leading to fewer inconclusive cases and, therefore, faster query evaluation. We also investigate options for defining and joining APRIL approximations of different polygons at different granularities based on their geometries. Finally, a significant contribution of this paper is a novel, one-step "intervalization" algorithm that computes the APRIL approximation of a polygon without having to rasterize it in full. We show that this method is orders of magnitude faster compared to other rasterization approaches on CPU [58, 46].

The rest of the paper is structured as follows: Section 2 provides the necessary background. In Section 3, we introduce our raster approximations (RI) technique as an intermediate filter for spatial intersection joins. Section 4 introduces APRIL, our improved raster intervals representation, detailing its features, construction, and usage. Section 5 presents customization options for tuning APRIL to specific system or dataset requirements. In Section 6, we study the efficient construction of APRIL approximations. Section 7 presents our experiments that verify APRIL's performance. Section 8 reviews related work, and finally, Section 9 concludes the paper and offers suggestions for future work.

2 Background

Figure 1 illustrates the spatial intersection join pipeline. An MBR-join algorithm takes as input the MBR approximations of objects to identify all pairs of objects that intersect (*filter step*) [21, 49]. Before accessing and comparing the exact object geometries for each such candidate pair, in an *intermediate step*, more detailed object approximations (than the MBR) are used to verify (fast) whether the pair is a sure result (true hit) or a sure non-result (false hit), or we cannot decide based on the approximations [9, 58]. Finally, if the pair is still a candidate, it is passed to the *refinement step* where the exact geometries are accessed and an (expensive) algorithm from computational geometry [35] is run to determine whether the pair is a result. Most previous work focused on the filter step [10, 21, 29, 49]. However, the refinement step dominates the overall cost, as discussed in the Introduction. The intermediate step using additional object approximations has been proved valuable toward reducing the overall join cost [9].

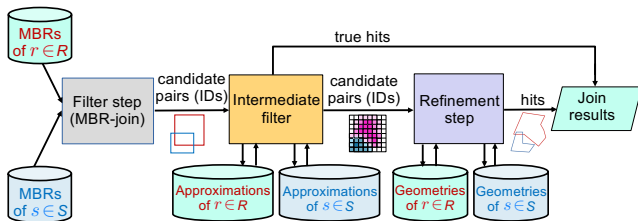

Fig. 1: Spatial intersection join pipeline [9]

Zimbrao and de Souza [58] introduced an effective intermediate filter, by imposing a grid over each object's MBR. The cells of the grid comprise the *raster approximation* of the object. Each cell belongs to one of the following four types: *full* (the object completely covers the cell), *strong* (the object covers more than 50% of the cell), *weak* (the object covers at most 50% of the cell), or *empty* (the object is disjoint with the cell). Figure 2 shows an example.

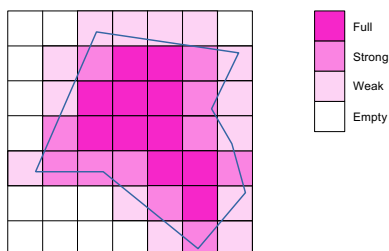

Fig. 2: Four types of cells in a raster approximation [58]

To create the raster approximation (RA) of a polygon, a grid of at most K square cells is defined. The side of each cell should be $\omega 2^k$, for some $k \geq 0$, where ω is a minimum cell side (unit). In addition, the coordinates of each cell should be multiples of $\omega 2^k$.

For a pair (r, s) of candidate objects, the cells in their approximations $RA(r)$ and $RA(s)$ that overlap with their common MBR are identified and the remaining ones are ignored. If the cells of $RA(r)$ are smaller than the cells of $RA(s)$, groups of neighboring cells in $RA(r)$ are combined to infer the type of a larger cell that is perfectly aligned with a cell of $RA(s)$. Re-scaling is expensive, results in accuracy loss and reduces the effectiveness of the filter, rendering RA useful mainly for polygons of similar size, which is rarely the case in real-world data.

After re-scaling, the common cells in the two raster approximations are examined and, for each such cell, we use the cell's types in the two approximations to conclude whether the objects intersect in the cell, according to Table 1. Specifically, if at least one of the two types is *empty* the objects definitely do not intersect in the cell. If at least one of the two types is *full* and the other is not *empty* or both types are *strong*, then the objects definitely intersect in the cell. In all other cases, we cannot conclude whether the objects intersect in the cell. If we find at least one cell, where the objects intersect, the pair is directly reported as a spatial join result (true hit). If at all common cells, the objects do not intersect, then the pair is pruned (false hit). If we cannot conclude about the object pair, the refinement step should be applied.

Table 1: Do two objects intersect in a cell, based on the cell's types in the two raster approximations? [58]

	empty	weak	strong	full
empty	no	no	no	no
weak	no	<i>inconclusive</i>	<i>inconclusive</i>	yes
strong	no	<i>inconclusive</i>	yes	yes
full	no	yes	yes	yes

3 Raster Intervals

We propose a new framework for the intermediate step of spatial joins, which builds upon, but is significantly more effective than the raster approximation technique of previous work [58]. Our approach has three important differences: (i) we use the same global (and fine-grained) grid to rasterize all objects; (ii) we use bit-string representations for the cell types of object ap-

proximations; and (iii) we represent the set of all non-empty cells of each object as a sorted list of intervals paired with binary codes. In this section, we present in detail the steps that we follow in order to generate the raster intervals approximation for each object.

3.1 Object rasterization and raster encoding

We superimpose over the entire data space (e.g., the map) a $2^N \times 2^N$ grid. For each data object o , we identify set of the cells C_o that the object intersects and use this set to approximate o . Each cell in C_o may belong to three types: *full*, *strong*, or *weak*; as opposed to [58], we do not include empty cells in C_o . In order to compute C_o for each object, and the type of each cell, we apply the algorithm of [58]. In a nutshell, the algorithm first identifies the grid columns (stripes) which overlap with o . It clips the object in each stripe, and then runs a plane-sweep algorithm along the stripe to identify the cells and the type of each cell.

Furthermore, we *encode* the three types of cells that we are using, as shown in Table 2. Note that we use a different encoding for the cell types depending on whether the object comes from join input R or S . This encoding has two important properties. First, if for two objects $r \in R$ and $s \in S$ and for a cell c , the bitwise AND of the codes of r and s in cell c is non-zero, then we are sure that r and s intersect in cell c . Indeed, this corresponds to the case where at least one type is *full* or both are *strong*. If the logical AND is 0, we cannot be sure whether r intersects s in c .

The second property of the encoding is that it allows us to swap the roles of R and S in the join, if necessary. Specifically, the code for a cell c of an object in one join input (e.g., R) can be converted to the code for c if the object belonged to the other join input (e.g., S) by XORing the code with the mask $m = 110$. For example, 011, the R -encoding of *full* cells, after bitwise XORing with m , becomes 101, i.e., the S -encoding of *full* cells. This is important for the case where the rasterization of a dataset has been *precomputed* before the join, according to the R -encoding and we want to use the dataset as the right join input S . XORing can be done on-the-fly when we apply our filter, as we explain in Section 3.3, with insignificant cost.

Table 2: 3-bit type codes for each input dataset

	input R	input S
full	011	101
strong	101	011
weak	100	010

3.2 Intervalization

We use the Hilbert curve [20] to order the cells in the $2^N \times 2^N$ grid. Hilbert curve is a well-known space filling curve that preserves spatial proximity. Hence, each cell is mapped to a value in $[0, 2^{2N} - 1]$. By this, the set of cells C_o that intersect an object o can be represented as a list of intervals L_o formed by consecutive cells in C_o according to the Hilbert order. Figure 3 exemplifies the *intervalization* for a polygonal object o in a $2^3 \times 2^3$ space. The cells are marked according to their Hilbert order and shaded based on their type. There are in total 36 cells in C_o , which are represented by 7 intervals. To intervalize C_o , we sort the cells there in Hilbert order and scan the sorted array, merging cells of consecutive cells into the current interval. The cost for this is $O(|C_o| \log |C_o|)$.

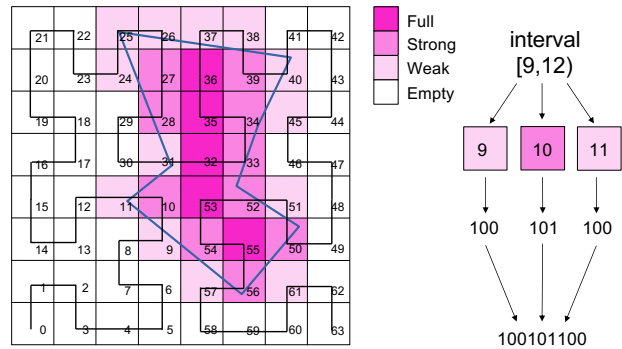

Fig. 3: The Hilbert curve cell enumeration and interval generation for a polygon in a 8×8 space.

For each interval in L_o , during the interval construction, we *concatenate* the bitwise representations of the cells in their Hilbert order, to form a *single* code for the entire interval. This allows us to replace the set C_o of cells that intersect an object o by L_o . For example, assume that the polygon of Figure 3 belongs to the left join input R . We replace cells 9, 10 and 11 in C_o with codes 100, 101 and 100, respectively, by interval [9,12] with binary code 100101100, as shown in the figure. This helps us to greatly reduce the space requirements for the rasterized objects. In addition, as we will show next, we save many computations while verifying a pair of objects, because we can apply the bitwise AND for multiple cells simultaneously. The resulting *raster intervals* (RI) approximation of each object is a sequence of $\langle st, end, code \rangle$ triples (ordered by st), where $[st, end]$ is an interval in the Hilbert curve space and $code$ is a bitstring that encodes the cell types in the interval.

Practical considerations A larger value for N results in a finer-grained grid and thus more accurate approx-

imations. Moreover, a polygon rasterized with higher granularity has an increased probability to have completely covered cells (i.e., type *full*), which increases the chances of the intermediate spatial join filter to identify a true hit. At the same time, a large N requires more space for storing the endpoints of the intervals in L_o . We choose $N = 16$, which results in a grid with a fine granularity; in addition, the Hilbert order of cells (i.e., the interval endpoints) can be stored as 32-bit unsigned integers. As each cell in an interval contributes three bits to the interval's concatenated binary code, for a $[st, end)$ interval, we need $\lceil (end - st) * 3/8 \rceil$ bytes to encode its cells. We may opt to compress binary codes consisting of many bytes and the RI approximation of an object, overall.

3.3 Intermediate filter

For a join candidate pair (r, s) , $r \in R, s \in S$ which is produced by the MBR-join algorithm, our objective is to use the raster intervals approximations $RI(r)$ and $RI(s)$ of r and s to verify fast whether r and s definitely intersect, (ii) r and s definitely do not intersect, or (iii) we cannot conclude about the intersection of r and s , based on their RIs. This is done via our RI-join procedure (Algorithm 1).

Algorithm 1 RI-join algorithm

Require: $RI(r)$ as X , $RI(s)$ as Y

```

1:  $ovl \leftarrow False$ ;  $\triangleright$  no overlapping interval pair found yet
2:  $i \leftarrow 0$ ;  $j \leftarrow 0$ 
3: while  $i < |X|$  and  $j < |Y|$  do
4:   if  $X_i$  overlaps with  $Y_j$  then
5:     if  $ALIGNEDAND(X_i.code, Y_j.code)$  then
6:       return true hit  $\triangleright$  bitwise AND is non-zero
7:     end if
8:      $ovl \leftarrow True$ ;  $\triangleright$  found an overlapping interval pair
9:   end if
10:  if  $X_i.end \leq Y_j.end$  then  $i \leftarrow i + 1$  else  $j \leftarrow j + 1$ 
11: end while
12: if  $ovl$  then  $\triangleright$  at least one overlapping interval pair
13:   return indecisive
14: else
15:   return false hit  $\triangleright$  no common cells in  $X$  and  $Y$ 
16: end if
```

RI-join merge-joins the sorted interval lists $RI(r)$ and $RI(s)$, denoted by X and Y in the pseudocode, respectively, and identifies pairs (X_i, Y_j) of intervals that overlap; i.e., X_i and Y_j include at least one common cell. For each such pair, there is a possibility to find out that (r, s) is a true hit (i.e., a spatial join result) and avoid sending the pair to the refinement step. Specifically, if in at least one of the common cells of X_i and

Y_j the logical AND of the cell codes is non-zero, we have a sure true hit and we do not need to continue the RI-join. Having the codes of the cells in X_i and Y_j concatenated in two single bitstrings $X_i.code$ and $Y_j.code$ allows us to perform this check (abstracted by Function $ALIGNEDAND$) efficiently. We first select from each bitstring the fragment that includes the codes of all cells in $[\max\{X_i.st, Y_j.st\}, \min\{X_i.end, Y_j.end\}]$, i.e., the intersection interval of X_i and Y_j . Then, we bitwise AND the fragments. If the fragments have been encoded by the same encoding (i.e., both have R or S encoding as shown in Table 2), ANDing is preceded by XORing one of the two codes. If there is at least one pair (X_i, Y_j) of overlapping intervals (variable ovl of Algorithm 1 is $True$ at the end of the while-loop), but the object pair is not found to be a true hit, then the object pair is *indecisive*, meaning that we will have to apply the refinement step for it. On the other hand, if there are no overlapping intervals in the two RIs (ovl remains $False$), there are no common cells in the raster representations of the objects, and we can conclude that the two objects definitely do not intersect (false hit). As an example, Figure 4 shows two rasterized polygons and the pairs (X_i, Y_j) of intervals from the two raster intervals that overlap.

In general, the codes (bitstrings) of two intersecting intervals may occupy multiple bytes and the common subinterval may be of arbitrary length. Before bitshifting, Function $ALIGNEDAND$ truncates all unmatched bytes from the two bitstrings. In addition, bitshifting is done at the bytes of one interval only (the one that starts earlier), making sure to carry over the required bits from the next byte to avoid any loss of information. This continuous shifting and matching (binary AND between aligned bitstrings) is performed byte-by-byte, hence, once two ANDed bytes give a non-zero, we immediately report the true hit. XORing, (if both join inputs have the same encoding), is done on-demand on the shifted byte, after any potential bit carryover. A byte-wide XOR mask m_{byte} is used, created by concatenating our mask $m = 110$ a few times to fill a byte; m_{byte} is shifted, if necessary. The whole process can easily be parallelized (shifting and bitwise operations are independent for each byte).

For each pair of intervals, the last bytes to be matched is a special case and has to be treated cautiously, since the remaining bits that need checking may be less than 8 and the rest of the bits in that byte should not be included in the bitwise operations. In other words, the XOR and AND operations applied on the last bytes should consider bits only in the positions relevant to the compared intervals, otherwise we may mistake a false positive as a true hit. Hence, we apply one last bit

mask with 1s at the positions of the bits that need to partake in the operation, setting the rest to zero.

Figure 5 shows how the codes for first pair (X_0, Y_1) of intersecting intervals from the example of Figure 4 are matched, where $X_0 = \langle [9, 13), 100101101101 \rangle$ and $Y_1 = \langle [11, 15), 100100101100 \rangle$ (i.e., assume that both datasets are R -coded). Each code occupies 2 bytes. Since the interval of Y_1 starts 2 cells after the interval of X_0 , the code of X_0 is shifted by $2 \times 3 = 6$ bits in the first step. This aligns the common cells (11 and 12) in the two codes. The common fragment (6 bits) occupies 1 byte, so there will be one byte-by-byte match. As both intervals are R -coded, we first XOR the X_0 -byte with the (shifted) byte-wise XOR mask m_{byte} . Before ANDing the two bytes, we AND the shifted byte with a mask that clears the bits that are outside the common fragment of the intervals, as we are at the last byte. Finally, the bytes are ANDed with a 0 result, so the intersection of the two objects remains indecisive with respect to (X_0, Y_1) . As a result, Algorithm 1 continues to find next pair of overlapping intervals (X_5, Y_2) and performs the corresponding code matching.

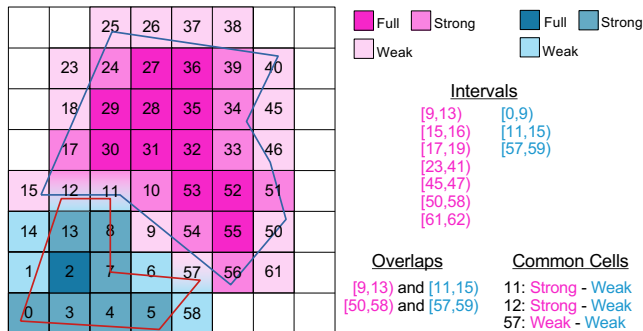

Fig. 4: Two rasterized polygons, the overlaps between their raster intervals, and their common cells

Analysis. RI-join requires a single scan of interval lists X and Y , since no two intervals in the same list (i.e., in the same polygon) overlap. Assuming that bitstrings are relatively short so that their matching (a call to Function `ALIGNEDAND`) takes constant time, the time complexity of Algorithm 1 is $O(|X| + |Y|)$ since the number of overlapping interval pairs is at most $|X| + |Y|$.

3.4 “Within” spatial joins

Although we focus on polygon-polygon intersection joins, RI can also be used as an intermediate filter for *within joins*. The objective of a spatial within join is to find pairs (r, s) of objects, $r \in R$, $s \in S$, such that r is *within*

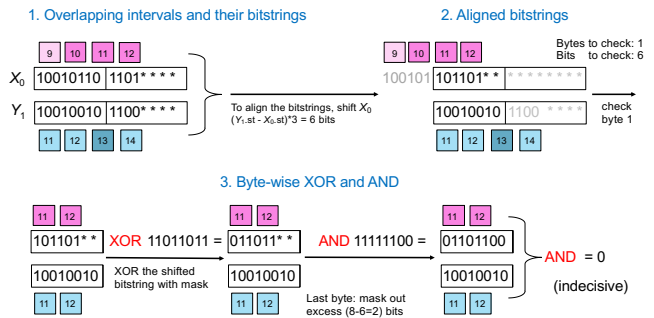

Fig. 5: Intervals $[9, 13)$ and $[11, 15)$ of our two example polygons overlap but are not aligned. Byte truncation and bit shifting (if necessary) align their bitstrings before performing the bitwise operation(s)

s , i.e. the space occupied by r is a subset of the space occupied by s . For each pair (r, s) of polygons that passes the filter step of the within join (i.e., the MBR of r is within the MBR of s), we can apply Algorithm 1 with the following changes in order to identify whether (r, s) is a true negative (false hit), a true positive (i.e., true hit), or an indecisive pair w.r.t. the within predicate: As soon as we find an interval $X_i \in RI(r)$ which is not a subset of any interval $Y_j \in RI(s)$, we can terminate with the assertion that r is not within s , since there is at least one non-empty cell of r which is empty in s . In addition, for an identified pair of (X_i, Y_j) , such that $X_i \subseteq Y_j$, if there is a cell in X_i that is (i) *full* in X_i but not full in Y_j or (ii) *strong* in X_i and *weak* in Y_j , then (r, s) should be a true negative and the algorithm terminates. For (x, y) to be characterized as a true hit without refinement, for all identified (X_i, Y_j) such that $X_i \subseteq Y_j$, all cells in the subinterval X_i where X_i and Y_j overlap should be *full* in Y_j ; if at least one such cell is not full, then we cannot guarantee a true hit and the pair (x, y) must be passed to the refinement step, unless it is found to be a true negative.

4 APRIL

We now propose *APRIL* (Approximating Polygons as Raster Interval Lists), a significant enhancement of RI, which can be used as an intermediate filtering method for spatial query processing and is more efficient and less space consuming compared to RI.

4.1 A- and F-Interval Lists

APRIL is a succinct polygon approximation for intermediate filtering, which categorizes raster cells into *Full*, *Partial*, and *Empty*, based on their coverage percentage with the object’s geometry (100%, less than 100%, and

0%, respectively). In other words, APRIL *unifies* the *Strong* and *Weak* cell classes used by RI and [58] to a single *Partial* class. Under this, APRIL approximates a polygon with two sorted interval lists: the *A*-list and the *F*-list. The *A*-list contains intervals that concisely capture all cells that overlap with the polygon, regardless of their type (Full or Partial), whereas the *F*-list includes only Full cells. An interval list having n intervals is stored as a simple sorted integer sequence in which the i -th interval's *start*, *end* are located at positions $2i$ and $2i + 1$ respectively, for $i \in [0, n)$.

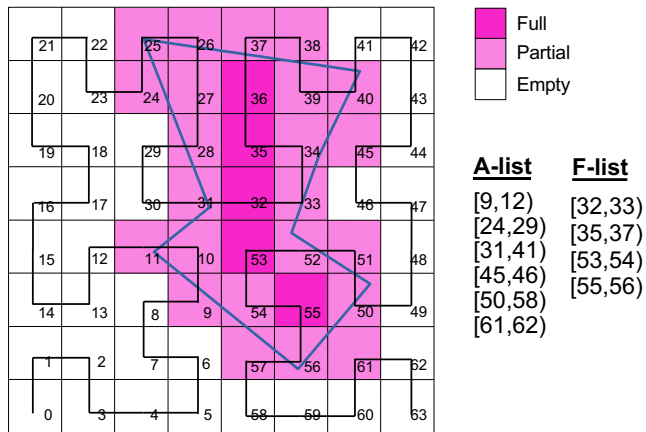

Fig. 6: The interval generation for a polygon in a 8×8 space, without bit-coding and using interval lists.

The *A*-list and *F*-list for the example polygon of Figure 3 are shown in Figure 6. Strong and Weak cell types become Partial, which results in a simpler representation than RI. Note that the set of intervals in each of the *A*- and *F*-lists are disjoint. The new relationship identification table for a cell shared by two polygons, is shown in Table 3. Removing the Strong cell type renders the approximation unable to detect true hits for cells of the Strong-Strong case, as common cells that are both Partial cannot decide definite intersection between the two polygons.¹

Table 3: APRIL: Do two objects intersect in a common cell?

	Partial	Full
Partial	<i>Inconclusive</i>	yes
Full	yes	yes

¹ As we have found experimentally (Sec. 7.4.2), this has minimal effect on the amount of true hits and true negatives that the intermediate filter manages to detect. This is due to the fact that the only cases of true hits missed are pairs of polygons that intersect with each other *exclusively* in cells typed Strong for both polygons and nowhere else.

Construction To construct an APRIL approximation we need to first identify the cells intersected by the polygon's area in the grid, while also labeling each one of them as Partial or Full. Then, *Intervalization* derives the *F*-list, by sorting the set of Full cells by ID (i.e., Hilbert order) and merging consecutive cell IDs into intervals. To derive the *A*-list, we repeat this for the union of Full and Partial cells. In Section 6.2, we propose an efficient algorithm that derives the *F*- and *A*-list of a polygon without having to label each individual cell that intersects it.

4.2 APRIL Intermediate Spatial Join Filter

APRIL is used as an intermediate filter (Figure 1) that is situated between the MBR filter and the refinement phase. Given a pair (r, s) of objects coming as a result of an MBR-join algorithm [10, 33, 49], APRIL uses the *A*- and *F*-lists of r and s to detect fast whether the polygons (i) are disjoint (true negative), (ii) are guaranteed to intersect (true hit), or (iii) are inconclusive, so they have to be forwarded to the refinement stage to verify their intersection.

Whether r and s are disjoint (i.e. do not intersect), can be determined by checking whether their *A*-lists have any pair overlapping of intervals or not. If they have no overlapping intervals, then r and s do not have any common cell in the grid and thus they cannot intersect. We check this condition by performing a merge join over the *A*-lists and stopping as soon as we detect two overlapping intervals.

Pairs of polygons that have at least one pair of overlapping intervals in their *A*-lists are then checked using their *F*-lists. We perform two more merge-joins: $A(r) \bowtie F(s)$ and $F(r) \bowtie A(s)$; detecting an overlapping intervals pair in one of these two joins means that there is a Full cell in one object that is common to a Full or Partial cell of the other object. This guarantees that the two objects intersect and the pair (r, s) is immediately reported as a spatial join result. If $A(r) \bowtie F(s)$ fails to detect (r, s) as a true hit, then $F(r) \bowtie A(s)$ is conducted; if the latter also fails, then (r, s) is an *inconclusive* candidate join pair, which is forwarded to the refinement step.

In summary, APRIL's intermediate filter sequence consists of three steps: the *AA*-join, *AF*-join, and *FA*-join, as illustrated in Figure 7 and described by Algorithm 2. Each step is a simple merge-join between two sorted interval lists. Since each list contains disjoint intervals, each of the three interval joins takes $O(n + m)$ time, where n and m are the lengths of the two interval join input lists. Hence, the total cost of the APRIL

filter (i.e., Algorithm 2) is linear to the total number of intervals in the A - and F -lists of r and s .

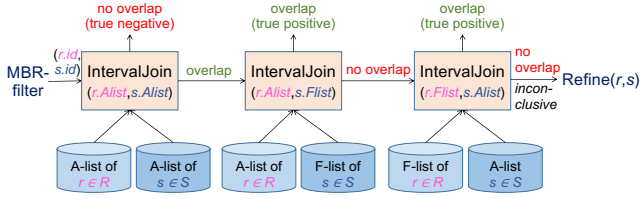

Fig. 7: The three steps of the intermediate filter for a candidate pair of polygons.

Algorithm 2 APRIL join algorithm.

Require: (r, s) such that $MBR(r)$ intersects $MBR(s)$

```

1: function INTERVALJOIN( $X, Y$ )
2:    $i \leftarrow 0; j \leftarrow 0$ 
3:   while  $i < |X|$  and  $j < |Y|$  do
4:     if  $X_i$  overlaps with  $Y_j$  then
5:       return true                                ▷ overlap exists
6:     end if
7:     if  $X_i.end \leq Y_j.end$  then  $i \leftarrow i + 1$  else  $j \leftarrow j + 1$ 
8:     end while
9:   return false                                  ▷ no overlaps detected
10: end function
11:
12: if not IntervalJoin( $A(r), A(s)$ ) then
13:   return false                                  ▷ true negative
14: end if
15: if IntervalJoin( $A(r), F(s)$ ) then
16:   return true                                    ▷ true hit
17: end if
18: if IntervalJoin( $F(r), A(s)$ ) then
19:   return true                                    ▷ true hit
20: end if
21: return REFINEMENT( $r, s$ )                        ▷ forward pair to
    refinement

```

Join Order Optimization The AA -join, AF -join, and FA -join could be applied in any order in Algorithm 2. For example, if (r, s) is a true hit, it would be more beneficial to perform the AF -join and the FA -join before the AA -join, as this would identify the hit earlier. On the other hand, if (r, s) is a true negative, conducting the AA -join first avoids the futile AF - and FA -joins. However, there is no way to know a priori whether (r, s) is a true hit or a true negative. In addition, we experimentally found that changing the join order does not have a high impact on the intermediate filter cost and the overall cost. For a typical candidate pair (r, s) the common cells are expected to be few compared to the total number of cells covered by either r or s , making AA -join the most reasonable join to start with. This is confirmed by our experiments where the number of candidate pairs identified as true negatives is typically

much larger compared to the number of identified true hits.

4.3 Generality

In this section, we demonstrate the generality of APRIL in supporting other queries besides spatial intersection joins between polygon-sets. We first show how we can use it as an intermediate filter in selection (range) queries. Then, we discuss its application in spatial *within* joins. Finally, we discuss the potential of using APRIL approximations of polygons and raster approximation of linestrings to filter pairs in polygon-linestring intersection joins.

4.3.1 Selection Queries

Similarly to joins, APRIL can be used in an intermediate filter to reduce the cost of selection queries. Consider a spatial database system, which manages polygons and where the user can draw a selection query as arbitrary polygon QP ; the objective is to retrieve the data polygons that intersect with the query polygon QP . Assuming that we have pre-processed all data polygons and computed and stored their APRIL representations, we can process polygonal selection queries as follows. We first pre-process QP to create its APRIL approximation. Then, we use the MBR of QP to find fast the data polygons whose MBR intersects with the MBR of the query (potentially with the help of an index [19,50]). For each such data polygon r , we apply the APRIL intermediate filter for the (r, QP) pair to find fast whether r is a true negative or a true hit. If r cannot be pruned or confirmed as a query result, we eventually apply the refinement step.

4.3.2 Spatial Within Joins

APRIL can also be applied for spatial joins having a *within* predicate, where the objective is to find the pairs (r, s) , where $r \in R$ and $s \in S$ and r is *within* s (i.e., r is completely covered by s). In this case, the intermediate filter performs only two of its three steps. The AA -join is applied first to detect whether r and s are disjoint, in which case the pair should be eliminated. Then, we perform a variant of the AF -join, where the objective is to find if *every* interval in the A -list of r is contained in one interval in the F -list of s ; if this is true, then (r, s) is guaranteed to be a within join result and it is reported as a true hit. In the opposite case, (r, s) is forwarded to the refinement step. We do not apply an FA -join, because this may only detect whether s is within r .

4.3.3 Linestring to Polygon Joins

Another interesting question is whether APRIL can be useful for intersection joins between other spatial data types, besides polygons. The direct answer is no, since APRIL is designed for spatially-extended objects. Still, our method can be useful for the case of joins between polygons and linestrings. A linestring is a sequence of line segments and it is used to approximate geographic objects such as roads and rivers. The rasterization of a linestring results in only Partial cells, as linestrings have zero area and cannot cover a cell entirely. In addition, as exemplified in Figure 8, linestrings do not really benefit from merging consecutive cells into intervals, as linestrings that follow the Hilbert order (or any other fixed space-filling curve) are rare. Hence, it is more space-efficient to approximate a linestring as a sorted sequence of cell-IDs (which are guaranteed to be Partial). Having the linestring approximations, we can evaluate spatial intersection joins between a collection of polygons and a collection of linestrings, by applying two of the three steps in the APRIL intermediate filter; namely, (i) a merge-join between the *A*-list of the polygon and the cell-ID list of the linestring to find out whether the pair is a true negative and (ii) a merge-join between the *F*-list of the polygon and the cell-ID list of the linestring to find out whether the pair is a true hit. Algorithm 2 can easily be adapted for polygon-linestring filtering, by changing `IntervalJoin(X, Y)` to take a sequence of cell-IDs *Y* and treat them as intervals of duration 1.

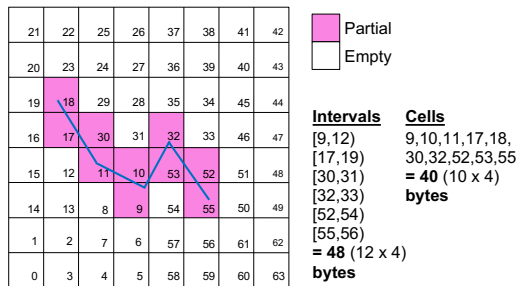

Fig. 8: A linestring’s APRIL approximation size in bytes, if stored as intervals versus cells.

5 Customization

We have explored a series of optimization and customization options that can potentially reduce APRIL’s space complexity and improve its performance in terms of filter effectiveness and speed.

5.1 Compression

Recall that the only information that APRIL stores for each polygon is two interval lists: the *A*-list and the *F*-list. The interval lists are essentially sorted integer arrays, so we can exploit delta encoding and more specialized lossless compression schemes to reduce their space requirements. Since any of the *AA*- *AF*- and *FA*-join that we may apply on the lists may terminate early (as soon as an interval overlap is detected), we should go for a compression scheme that does not require the decompression a list entirely before starting processing it. In other words, we should be able to perform joins *while* decompressing the lists. This way, we may avoid uncompressing the lists at their entirety and still be able to perform the joins. In view of this, we use delta encoding, where we store the first value of the list precisely and from thereon store the differences (gaps) between consecutive numbers.

There are dozens of different compression schemes for gaps between ordered integers, each with their pros and cons. We chose the Variable Byte (VByte) method [12,48], a popular technique that even though it rarely achieves optimal compression, it is adequately efficient and really fast [23]. We use the libvbyte [11] library that has an option for sorted integer list compression, which matches our case and boosts performance by utilizing delta encoding. Compression hardly affects APRIL’s construction time, which is dominated by the rasterization/intervalization cost.

At the same time, we adapt our interval join algorithm to apply decompression and join at the same time, i.e., each time it needs to get the next integer from the list it decompresses its value and adds it to the previous value in the list.

5.2 Partitioning

The accuracy of APRIL as a filter is intertwined with the grid granularity we choose. A more fine-grained grid results in more Full cells, increasing the chance of detecting true hits; similarly, empty cells increase, enhancing true negative detection. However, simply raising the order *N* is not enough to improve performance. Increasing *N* beyond 16 means that a single unsigned integer is not enough to store a Hilbert curve’s identifier, which range from $[0, 2^{2N} - 1]$. For $N = 17$ or higher, we would need 8 bytes (i.e., an unsigned long) to store each interval endpoint, exploding the space requirements and the access/processing cost.

In view of this, we introduce a partitioning mechanism for APRIL, that divides the data space into *dis-joint* partitions and defines a dedicated rasterization

grid and Hilbert curve of order $N = 16$ to each partition. This increases the global granularity of the approximation, without using long integers, while giving us the opportunity to define smaller partitions for denser areas of the map for which a finer granularity is more beneficial. Partitioning is done considering all datasets (i.e., layers) of the map. That is, the same space partitioning is used for all datasets that are joined together. The contents of each partition are all objects that intersect it; hence, the *raster* area of the partition is defined by the MBR of these objects and may be larger than the partition, as shown in the example of Figure 9. APRIL approximations are defined based on the raster area of the partition. The spatial join is then decomposed to multiple joins, one for each spatial partition. Duplicate join results are avoided at the filter step of the join (MBR-join) as shown in [13,49]. This partitioning approach is particularly beneficial for big data management systems, such as Apache Sedona, where spatial queries are evaluated in a distributed manner after space and data partitioning. Partitioning allows (i) more accurate approximations through fine-grained partitions and (ii) parallel evaluation per partition that further reduces the end-to-end join time.

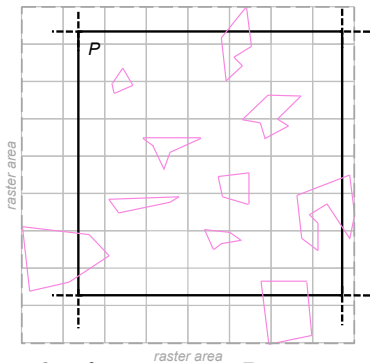

Fig. 9: Example of a partition P , a group of polygons in it and P 's raster area with granularity order $N = 8$.

5.3 Different Granularity

If we use the same (fine) grid to rasterize all polygons, the APRIL approximations of large polygons may contain too many intervals, slowing down the intermediate filter. We can create approximations using a different order N of the Hilbert curve for different datasets, based on the average sizes of their contents. There is a trade-off between memory and performance, since an order lower than 16 means fewer intervals and thus lower memory requirements and complexity, but also means reduced APRIL accuracy.

When joining two APRIL approximations of different order, we need to adjust one of the two interval lists so that it can be joined with the other. For this, we scale down the list with the highest order. Specifically, before comparing two intervals $a = [a_{start}, a_{end})$ and $b = [b_{start}, b_{end})$ at orders N and L respectively, where $N > L$, the highest order interval a should be right shifted by $n = |N - L| \times 2$ bits, to form a transformed interval a' , as follows:

$$a' = [a_{start} \gg n, (a_{end} - 1) \gg n] \quad (1)$$

Right shifting creates intervals in a more coarse-grained grid and thus, they may represent larger areas than the original. Therefore, this formula works only for A -intervals, since there is no guarantee that a Full interval at order N will also be Full at order L . For this reason, in Algorithm 2, we perform only one of the AF - and FA - joins, using the F -list of the coarse approximation (which is not scaled down). This has a negative effect on the filter's effectiveness, as a trade-off for the coarser (and smaller) APRIL approximations that we may use for large polygons.

6 APRIL Approximation Construction

In this section, we present two methods for the construction of a polygon's APRIL approximation. In Section 6.1 we present a *rasterization* approach that efficiently finds the cells that intersect an input polygon and their types, based on previous research on polygon rasterization, and then sorts them to construct the A - and F -interval lists. In Section 6.2, we propose a more efficient approach tailored for APRIL, which avoids classifying all cells, but directly identifies the intervals and constructs the A - and F -interval lists.

6.1 Efficient Graphics-Inspired Rasterization

RI and the previous raster-based filter of [58] require the classification of each cell to Full, Strong, Weak, or Empty, based on the percentage of the cell covered by the original polygonal geometry. For this, they apply an algorithm that involves numerous polygon clippings and polygonal area computations, at a high cost. On the other hand, to define an APRIL approximation, we only need to identify the cells which are partially or fully covered by the input polygon's area. Inspired by rasterization techniques in the graphics community [4, 41], we propose a polygon rasterization technique which involves two stages. Firstly, we compute the Partial

cells, which essentially form the boundary of the polygon in the grid. Next, we compute the Full cells using the previously-computed boundary cells.

Identifying the Partial cells is closely related to the pixel drawing problem in graphics that involves detecting which cells to “turn on” to draw a target line. While Bresenham’s algorithm [8] is a popular and fast pixel drawing algorithm, it approximates a line segment by turning on a minimal amount of cells and may thus not detect all intersected cells. In contrast, the Digital Differential Analyzer (DDA) method [27] is slower, but identifies correctly and completely all intersected cells. To detect the Partial cells, we use an efficient variant of DDA [4] that uses grid traversal. We execute the grid traversal for each edge of the polygon and store the IDs of the identified Partial cells in a list. The leftmost grid in Figure 11 shows the Partial cells detected by the grid traversal algorithm for the polygon drawn in the figure.

Next, to identify the Full cells, we have to detect all cells that reside in the polygon’s enclosed areas. This is closely related to the shape filling problem in computer graphics, a very old and thoroughly studied problem. Most approaches are variants of two paradigms: sweep-line (scanline) rendering [7] or shape (flood) filling [34, 41]. Both approaches have their pros and cons in terms of performance and accuracy.

Scanline Sweep-line algorithms use horizontal lines to find all intersections between them and the polygon per row in the grid, and sort the intersections based on their x -values. These are called *event* points and are used to loop through all internal cells without performing any point-in-polygon (PiP) tests. All cells in-between consecutive pairs of the sorted event points are simply looped through and are labeled as Full. Note that this approach can be used as standalone method without the grid traversal algorithm, to detect all cells that overlap with a polygon regardless of type. However, in order to accurately classify each cell as Partial or Full and without performing a PiP test for every single one, we use it only for the Full cells, right after the DDA algorithm has generated the set of Partial cells.

Flood Fill The classic flood fill algorithm first selects an unlabeled cell that is guaranteed to be within the polygon, called *seed*. Then, it traverses all neighboring cells of the seed until it finds the boundaries of the enclosed area, classifying the encountered cells as fully covered. We implemented a variant of this algorithm which minimizes the number of PiP tests required to identify whether a cell is inside or outside the polygon. Specifically, we iterate through the cells of the polygon’s MBR area. If a cell c has not been labeled yet (e.g., as Partial), we perform a PiP check from c ’s center. If the cell c is found to be inside the polygon, c is

marked as Full and we perform a flood fill using c as the seed, stopping at labeled cells, and label all encountered unchecked cells as Full. If the cell c is found to be outside the polygon, c is marked as Empty and we perform flood fill to mark Empty cells. The algorithm repeats as long as there are unchecked cells to flood fill from. This reduces the number of PiP tests that need to be performed, as it suffices to perform a single test for each contiguous region in the grid with Full or Empty cells.

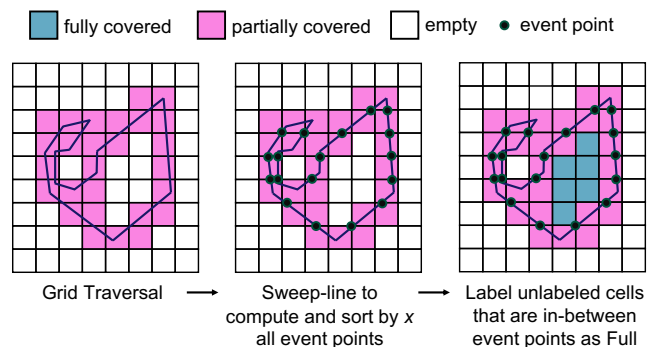

Fig. 10: The Scanline rendering algorithm we implemented, filling the Full cells without performing any PiP tests.

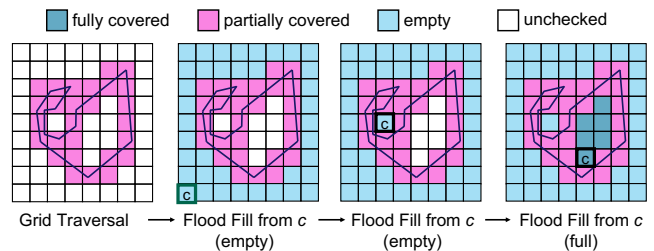

Fig. 11: The flood fill algorithm, performing 3 iterations with different seeds c to completely fill all unchecked cells.

Figure 10 shows an example of our sweep-line rendering variant method. After all Partial cells have been identified, the event points between the scanlines and the polygon’s edges are calculated and sorted by their x -values. Then, for each two consecutive pairs of event points, their in-between unlabeled cells are labeled as Full. Figure 11 illustrates our Flood Fill process for an example polygon. The unchecked cells form three contiguous regions bounded by Partial cells, two of them being outside the polygon and one inside. Instead of looking for cells within the polygon to flood fill starting from them, it is faster to fill both the inside and outside of the polygon (marking cells as Full and Empty,

respectively), as the number of point-in-polygon tests is minimized.

Regardless of which rasterization approach was chosen and after all Partial and Full cells have been identified, the algorithm merges consecutive cell identifiers into intervals to create the A - and F -lists that form the APRIL approximation.

6.2 One-Step Intervalization

The approach described in the previous section identifies the types (Partial, Full, Empty) of all cells that intersect the MBR of the input polygon. For polygons which are relatively large and their MBRs define a large raster area this can be quite expensive. We propose an alternative approach that identifies the F -intervals of the APRIL approximation efficiently and directly uses them to identify the A -intervals that include them in one step, without the need to identify the types of all individual cells in them.

As in Sec. 6.1, we first apply DDA [4] to detect the Partial cells and sort them in Hilbert order. An important observation is that “gaps” between nonconsecutive identifiers in the sorted Partial cells list, indicate candidate Full intervals on the Hilbert curve. Fig. 12 shows how these gaps are formed for an example polygon. Identifying the first cell c of each candidate interval as Full or Empty, through a point-in-polygon (PiP) test, is enough to label the whole interval as Full or Empty, respectively. The first “gap” interval is $[7, 8)$ containing just cell 7, which can be marked empty after a PiP test. From all “gap” intervals those marked in **bold** (i.e., $32-34 = [32, 35)$ and $52-54 = [52, 55)$) are Full intervals and can be identified as such by a PiP test at their first cell (i.e., 32 and 52, respectively).

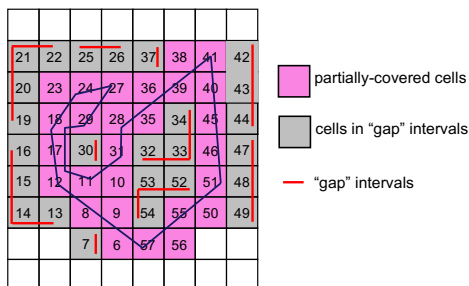

[6,7,8,9,10,11,12,13-16,17,18,19-22,23,24,25-26,27,28,29,30,31,32-34,35,36,37,38,39,40,41,42-44,45,46,47-49,50,51,52-54,55,56,57]

Fig. 12: Example of the intervals/gaps for a set of Partial cells. Whether a gap will be labeled as Full or Empty, depends on the outcome of the PiP test.

Additionally, we can skip some of these PiP tests by checking all adjacent cells (north, south, west, east) of the first cell c with smaller identifiers than c ; if any of them is Full or Empty, we can also give the same label to the candidate interval, as it should exist in the same inner/outer area of the raster image. For example, in Figure 12, when the algorithm moves to identify the interval $[52, 55)$, it can detect that its first cell 52 is adjacent to another Full cell with smaller order (cell 33), that has been previously identified. Thus, the interval $[52, 55)$ exists in the same inner area as cell 33 and it inherits its label (Full), without performing another PiP test for it. In this example, a total of 5 PiP tests will be performed, for the intervals that start with the cells 7, 13, 30, 32 and 42, instead of 11 PiP tests that would be performed otherwise, if we did not take into consideration the neighboring cells.

Algorithm 3 is a pseudocode for the one-step intervalization process, which takes as input the sorted Partial cells list P computed by DDA. The algorithm creates the A -list, F -list of the polygon in a single loop through P . In a nutshell, the algorithm keeps track of the starting point of every A -interval and when an empty gap is identified, the algorithm “closes” the current A -interval and starts the next one from the next Partial cell in the list. On the other hand, Full intervals start with the identifier of the cell that is right after the last Partial cell of a consecutive sequence and end before the next Partial cell in order.

In details, Algorithm 3, starting from the first cell p in P , keeps track of the starting cell-ID A_{start} of the current A -interval; while the next cell $p + 1$ in Hilbert order is also in P (Lines 3–9) the current A -interval is expanded. If the next cell $c = p + 1$ is not partial, it is the starting cell of a candidate F -interval. We first apply function $CheckNeighbors(c)$ to find whether there exists an adjacent cell of c which is part of a $FULL$ or $EMPTY$ interval. Specifically, for cell c and a neighbor n , we first check whether $n < c$ (if not, n is either Partial or unchecked); if yes, we binary-search P to check whether n is a P -cell. If not, we apply a special binary search method on the current F -list to find out whether n is part of an interval in it. If we find n as part of an F -interval, then c is definitely a Full cell. If we do not find n , then c is definitely an Empty cell because $n < c$ and n is not Partial. If for all neighbors n of c , either $n > c$ or n is Partial, then we cannot determine the type of c based on the current data, so we perform a PiP test to determine c ’s type (i.e., Full or Empty). If c is Full, then we know that the entire interval $[c, p)$ is $FULL$ and append it to the F -list (Line 16). Otherwise (c is Empty), c is the end of the current A -interval, so the interval is added to the A -list and the start of the

next A -interval is set to the next Partial cell p . The algorithm continues until the list P of partial cells is exhausted and commits the last A -interval (Line 23).

Algorithm 3 The One-Step Intervalization algorithm.

Require: Sorted Partial cell array P

```

1: function ONESTEPINTERVALIZATION( $P$ )
2:    $i \leftarrow 0$   $\triangleright$  current position in array  $P$ 
3:    $Astart \leftarrow P_i; p \leftarrow P_i$   $\triangleright$  cell-IDs of current  $A$ -interval
   and partial cell
4:   while  $i < |P|$  and  $p + 1 = P_{i+1}$  do  $\triangleright$  while next cell
   is partial
5:      $i \leftarrow i + 1$ 
6:      $p \leftarrow P_i$ 
7:   end while
8:    $c \leftarrow p + 1$   $\triangleright$  next uncertain cell
9:    $i \leftarrow i + 1; p \leftarrow P_i$   $\triangleright$  next partial cell
10:  while  $i < |P|$  do
11:     $type \leftarrow CheckNeighbors(c)$ 
12:    if  $type \neq FULL$  and  $type \neq EMPTY$  then  $\triangleright$ 
    $type$  is still uncertain
13:       $type \leftarrow PointInPolygon(c)$   $\triangleright$  PiP test gives
    $FULL$  or  $EMPTY$ 
14:    end if
15:    if  $type = FULL$  then
16:       $AppendFullInterval([c, p])$ 
17:    else  $\triangleright type$  is  $EMPTY$ 
18:       $AppendAllInterval([Astart, c])$   $\triangleright$  current
    $A$ -interval finalized
19:       $Astart \leftarrow p$   $\triangleright$  start new  $A$ -interval
20:    end if
21:    Execute Lines 3–9  $\triangleright$  go through partial cells until
   next gap
22:  end while
23:   $AppendAllInterval([Astart, P_{i-1} + 1])$   $\triangleright$  save last
    $ALL$  interval
24: end function

```

Our one-step intervalization approach performs $|P| - 1$ PiP tests in the worst-case, which dominate its cost. Compared to the FloodFill-based approach of Section 6.1, which explicitly marks and then sorts all Full and Partial cells, Algorithm 3 is expected to be much faster for polygons which are large compared to the cell size and include a huge number of Full cells. On the other hand, flood filling may be a better fit for small polygons with a small MBR and relatively few Full cells.

7 Experimental Analysis

We assess the performance of our proposed methods (i.e., RI and APRIL), by experimentally comparing them with previously proposed polygon approximations for intermediate filtering of spatial joins. These include the 5-corner approximations comparison followed by a comparison of convex hulls (5C+CH) (as proposed in [9]), and Raster Approximation (RA) of [58]. We also included a baseline approach (None), which does not ap-

ply an intermediate filter between the MBR-join and the refinement step. For RA, we set the grid resolution to $K = 750$ cells, except for a few datasets where we use $K = 100$, due to memory constraints. For our methods (RI and APRIL), unless otherwise stated, we use a granularity order $N = 16$ for the rasterization grid, meaning that the Hilbert order of each cell can be represented by a 32-bit unsigned integer. The MBR filter of the spatial join pipeline was implemented using the algorithm of [49]. The refinement step was implemented using the Boost Geometry library (www.boost.org) and its functions regarding shape intersection. All code was written in C++ and compiled with the -O3 flag on a machine with a 3.6GHz Intel i9-10850k and 32GB RAM, running Linux.

7.1 Datasets

We used datasets from SpatialHadoop’s [42] collection. T1, T2, and T3 represent landmark, water and county areas in the United States (conterminous states only). We also used two Open Street Maps (OSM) datasets (O5 and O6) that contain lakes and parks, respectively, from all around the globe. We grouped objects into continents and created 6 smaller datasets representing each one: Africa (O5AF, O6AF), Asia (O5AS, O6AS), Europe (O5EU, O6EU), North America (O5NA, O6NA), Oceania (O5OC, O6OC) and South America (O5SA, O6SA). From all datasets, we removed non-polygonal objects as well as multi-polygons, self-intersecting polygons, and polygons with holes, because they need special handling by the refinement algorithms and the Boost Geometry library that we are using does not support some of these data types. The construction algorithms for APRIL approximations, presented in Section 6 can easily be adapted to handle these special polygon classes with minor modifications; our raster approximations for such polygons can directly be used as intermediate filters. The first three rows of Table 4 show statistics about the datasets. The cardinalities of the datasets vary from 3.1K to 7.1M. The smallest dataset (T3) includes complex polygons (thousands of edges), each having a relatively large area (see third row of Table 4). The other datasets are larger and include medium (e.g., T1, OSM data) to small and relatively simple polygons (e.g., T2). We conducted spatial joins only between pairs of datasets that cover the same area (i.e., $T1 \bowtie T2$, $T1 \bowtie T3$, $O5AF \bowtie O6AF$, etc.).

Table 4: Statistics of the datasets and space requirements of the data and the approximations

	T1	T2	T3	O5AF	O6AF	O5AS	O6AS	O5EU	O6EU	O5NA	O6NA	O5SA	O6SA	O5OC	O6OC
# of Polygons	123K	2.25M	3.1K	72K	191K	447K	622K	1.9M	7.1M	4.0M	999K	123K	228K	107K	223K
Avg # of vertices	25.4	31.9	2285.0	58.9	36.3	45.3	41.9	35.1	32.1	37.6	47.5	41.6	48.4	42.7	
Avg obj MBR area	1.77E-04	4.03E-05	3.95E-01	2.03E-03	1.23E-03	1.03E-03	9.98E-04	1.25E-04	1.19E-04	1.11E-04	4.40E-04	1.34E-03	2.37E-03	5.00E-04	5.27E-04
Geometries size (MB)	51.1	1168.1	115.3	68.9	112.7	327.9	422.1	1120.7	3746.2	2453.4	767.4	94.9	153.7	84.2	151.3
MBR size (MB)	4.4	81.1	0.1	2.6	6.9	16.1	22.4	70.9	258.4	144.8	36.0	4.5	8.2	3.9	8.1
APRIL size (MB)	14.4	134.0	57.2	14.2	25.4	55.2	64.5	180.3	968.0	251.0	155.0	25.4	44.4	7.3	15.0
APRIL-C size (MB)	6.6	75.3	16.0	5.1	10.6	23.3	28.6	84.8	406.5	138.0	62.4	9.2	16.7	3.8	7.8
RI size (MB)	19.5	138.2	968.7	18.6	55.7	57.5	109.8	180.9	942.9	238.1	213.5	31.2	143.4	14.2	39.3
RA size (MB)	1100.0	20000.0	26.9	617.2	1700.0	3700.0	5700.0	342.2	11400.0	6200.0	1500.0	1100.0	2100.0	898.7	2000.0
5C-CH size (MB)	28.7	705.4	1.6	18.5	46.6	117.8	159.4	515.4	1700.0	1200.0	257.7	30.4	52.9	28.8	57.7

7.2 Optimizations and Customizations

In this set of experiments, we showcase how the added features of APRIL perform both independently and compared to RI. Additionally, we compare APRIL with RI in terms of space complexity, filter effectiveness, filter cost and creation time.

7.2.1 The effect of N in RI

Recall that our RI approach superimposes a $2^N \times 2^N$ grid over the data space and approximates each object o with the set C_o of cells that overlap with o . C_o is then modeled by a set of intervals and a bitstring for each interval, which encodes the types of the cells that it contains. As discussed in Section 3.2, we set the value of N to 16, in order to have a fine granularity and be able to store the interval endpoints in 4-byte unsigned integers. We confirm the appropriateness of this choice, by evaluating the effectiveness of both RI and APRIL in spatial joins for various values of N .

Table 5 analyzes the performances of RI and APRIL for different values of N in spatial join $T1 \bowtie T2$. The first three columns of the table show the percentage of candidate pairs identified by the intermediate filters as true hits, false hits, or inconclusive (i.e., should be sent to the refinement step). The last four columns show the cost of the filter step of the spatial join (MBR-join), the total cost of applying our intermediate filters that use RI and APRIL to all candidate pairs, the total cost of the refinement step, and the overall join cost. The MBR-join cost is N -invariant, as this operation is independent of the subsequent steps (intermediate filter, refinement). Observe that the number of inconclusive pairs shrinks as N increases; the refinement cost decreases proportionally. On the other hand, the cost of RI-filter increases with N as the intervals become more and longer. Eventually, for the largest value of N , the overall join cost converges to less than 1 second.

In Table 6, we show the total time required to compute the RI and APRIL object approximations of all objects in T1 and T2 and the corresponding storage requirements for them, as a function of N . For small

Table 5: Effect of N on the performance of RI and APRIL in $T1 \bowtie T2$

	True hits	False hits	Inconclusive	MBR-join (s)	RI-filter (s)	Refinement (s)	Total time (s)
$T1 \bowtie T2$ (RI)							
$N = 10$	5.68%	24.96%	69.36%	0.03	0.03	1.44	1.50
$N = 13$	13.34%	46.88%	39.79%	0.03	0.06	0.63	0.72
$N = 14$	17.74%	52.20%	30.06%	0.03	0.09	0.48	0.60
$N = 15$	21.65%	56.07%	22.28%	0.03	0.15	0.37	0.54
$N = 16$	24.50%	59.42%	16.08%	0.03	0.28	0.27	0.59
$T1 \bowtie T2$ (APRIL)							
$N = 10$	5.67%	24.96%	69.37%	0.03	0.03	1.45	1.52
$N = 13$	13.46%	46.88%	39.66%	0.03	0.04	0.61	0.68
$N = 14$	17.99%	52.20%	29.81%	0.03	0.04	0.45	0.52
$N = 15$	21.85%	56.07%	22.08%	0.03	0.04	0.34	0.41
$N = 16$	24.29%	59.42%	16.29%	0.03	0.05	0.26	0.34

Table 6: Effect of N on the cost and space of RI and APRIL for T1 and T2

T1	RI constr. cost (s)	APRIL constr. cost (s)	RI Size (MB)	APRIL Size (MB)
$N = 10$	0.98	0.29	2.6	3.0
$N = 13$	5.32	0.55	3.5	3.6
$N = 14$	13.90	0.85	4.7	4.4
$N = 15$	43.17	1.37	8.2	7.7
$N = 16$	148.72	2.37	19.0	13.8
T2	RI constr. cost (s)	APRIL constr. cost (s)	RI Size (MB)	APRIL Size (MB)
$N = 10$	15.29	5.68	46.0	53.0
$N = 13$	43.95	8.08	53.0	58.4
$N = 14$	87.35	11.23	62.0	66.7
$N = 15$	214.04	16.57	82.0	84.1
$N = 16$	620.57	26.76	132.0	128.0

values of N , where the intermediate filters are not very effective, the computation cost and the space requirements are low because, for each object, only a small number of intervals, each approximating a small number of cells are constructed. On the other hand, for large values of N , where the intermediate filters are most effective, the approximations are very fine and require more time for computation and more space. We performed the same analysis for all other pairs of joined datasets (results are not shown, due to space constraints) and drew the same conclusions. Overall, due to the high effectiveness for $N = 16$, which brings the best possible performance to the overall spatial join, we choose this value of N in the rest of the experiments. Although we use a fixed grid for all objects (independently of their sizes), the intervalization and compression of the raster representations does not incur an unbearable space overhead and at the same time we achieve a very good filtering performance even for small objects, while avoiding re-scaling at runtime (as opposed to [58]).

7.2.2 Join Order

So far the interval joins in APRIL are assumed to be applied in a fixed order: AA , AF , and FA . As discussed

Table 7: Join order effect on APRIL filter cost.

Join Order	True hits	True negatives	Indecisive	Int. Filter (s)
T1 \bowtie T2				
AA-AF-FA	24.29%	59.42%	16.29%	0.0505
AA-FA-AF	24.29%	59.42%	16.29%	0.0501
AF-FA-AA	24.29%	59.42%	16.29%	0.0585
FA-AF-AA	24.29%	59.42%	16.29%	0.0601
T1 \bowtie T3				
AA-AF-FA	69.84%	28.13%	2.03%	0.1872
AA-FA-AF	69.84%	28.13%	2.03%	0.1891
AF-FA-AA	69.84%	28.13%	2.03%	0.1737
FA-AF-AA	69.84%	28.13%	2.03%	0.1773

in Section 4.2, the joins can be performed in any order. Table 7 tests different join orders for $T1 \bowtie T2$ and $T1 \bowtie T3$. $T1 \bowtie T2$ (like the majority of tested joins) has a high percentage of true negatives, so the original order is the most efficient one (changing the order of *AF* and *FA* does not make a difference). On the other hand, for $T1 \bowtie T3$, where the true hits are more, pushing the *AA*-join at the end is more beneficial. Since knowing the number (or probability) of true negatives and true hits a priori is impossible and because the join order does not make a big difference in the efficiency of the filter (especially to the end-to-end join time), we suggest using the fixed order, which is the best one in most tested cases. In the future, we investigate the use of data statistics and/or object MBRs to fast guess a good join order on an object pair basis.

7.2.3 Partitioning

Tables 8 and 9 illustrate the effect of data partitioning (Section 5.2) on the effectiveness, query evaluation time, and space requirements of APRIL approximations. A higher number of partitions means finer-grained grids per partition and thus, more intervals per polygon (i.e., more space is required). Even though this reduces the amount of inconclusive cases, it can slow down the intermediate filter, since more intervals need to be traversed per candidate pair. For example, $T1 \bowtie T3$ has already a small percentage of inconclusive pairs, so partitioning may not bring a significant reduction in the total join time. On the other hand, for joins with high inconclusive percentage, such as $O5AS \bowtie O6AS$, partitioning can greatly reduce the total cost. In summary, partitioning comes with a time/space tradeoff.

7.2.4 Different Granularity

As discussed in Section 5.3, we can define and use APRIL at lower granularity than $N = 16$ for one or both datasets, trading filter effectiveness for space savings. In Table 10, we study the effect of reducing N for $T3$ in $T1 \bowtie T3$. The size of $T3$'s APRIL approximations halves every time we decrease N by one. The filter time also decreases, due to the reduced amount of intervals from $T3$ in the interval joins. However, the percentage of

indecisive pairs increases, raising the refinement cost. $N = 15$ is the best value for $T3$, because it achieves the same performance as $N = 16$, while cutting the space requirements in half.

7.3 APRIL Construction Cost

We now evaluate the APRIL construction techniques that we have proposed in Section 6, comparing them with the rasterization method used in previous work [58] (and for RI). Note that RA [58] and RI essentially apply polygon clipping and polygon-cell intersection area computations, because they need to classify the cells that intersect the polygon to Weak, Strong, and Full. On the other hand, APRIL uses two classes: Partial and Full, which enables the application of the techniques that we proposed in Section 6. Table 11 shows the time taken to compute the APRIL approximations of all polygons in each dataset (for $N = 16$), using (i) the rasterization+intervalization approach of RI, after unifying Strong and Weak cells, (ii) the Scanline and FloodFill approaches tailored for APRIL presented in Section 6.1, and (iii) two versions of our novel OneStep intervalization approach (Section 6.2): one that performs a point-in-polygon (PiP) test for each first cell c of a candidate Full interval and one that checks the Neighbors of c before attempting the PiP test. All costs in Table 11 include the intervalization cost as well, to generate the final interval lists needed for APRIL. The intervalization for the rasterization techniques is performed by merging cells with consecutive Hilbert order identifiers into intervals, while our methods from Section 6.2 generate the intervals straight away.

We also included in the comparison the rasterization technique proposed for IDEAL [46], which also detects Full and Partial cells, as implemented in [45]. We modified IDEAL's granularity definition formula accordingly to match APRIL's Hilbert space grid of order $N = 16$.

Observe that our OneStep intervalization algorithm employing the Neighbors check (Section 6.2) and our Scanline rendering (Section 6.1) are the fastest approaches in most of the cases. Scanline and Flood Fill show little to no difference in performance between them, with Scanline being overall faster for small polygons and Flood Fill being faster for large and more complex shapes. This is due to the fact that Flood Fill performs some PiP tests while Scanline does not, as well as Flood Fill filling some unnecessary (Empty) pixels outside of the polygon, while Scanline focusing entirely on the interior of the shape specified by the event points. OneStep (Neighbors) applies 40% – 70% fewer PiP tests compared to OneStep (PiPs) that does not apply the Neighbors check. Only in datasets containing relatively small

Table 8: # partitions per dimension effect on join time.

#	Indecisive	Int. Filter (s)	Refinement (s)	Total time (s)
T1 \bowtie T2				
1	16.29%	0.08	0.27	0.39
2	12.81%	0.06	0.22	0.32
3	11.36%	0.08	0.20	0.30
4	10.50%	0.09	0.20	0.32
T1 \bowtie T3				
1	2.03%	0.47	0.34	0.86
2	1.77%	0.29	0.29	0.62
3	1.67%	0.37	0.27	0.69
4	1.64%	0.49	0.26	0.80
O5AF \bowtie O6AF				
1	26.92%	0.06	0.36	0.45
2	21.24%	0.06	0.29	0.37
3	18.26%	0.07	0.25	0.34
4	16.63%	0.08	0.24	0.35
O5AS \bowtie O6AS				
1	30.76%	0.43	7.48	8.04
2	24.07%	0.41	5.30	5.83
3	20.52%	0.46	4.34	4.93
4	18.39%	0.55	3.61	4.29
O5EU \bowtie O6EU				
1	34.32%	5.83	30.55	38.01
2	27.97%	5.35	24.24	31.22
3	24.84%	6.06	21.55	29.24
4	22.60%	6.61	19.99	28.23
O5NA \bowtie O6NA				
1	22.26%	3.56	24.08	28.49
2	17.58%	3.14	18.81	22.81
3	15.68%	3.65	17.13	21.64
4	14.45%	4.52	16.02	21.40
O5SA \bowtie O6SA				
1	25.80%	0.17	1.44	1.66
2	20.74%	0.14	1.21	1.39
3	18.39%	0.17	1.12	1.33
4	17.03%	0.20	1.07	1.30
O5OC \bowtie O6OC				
1	24.42%	0.10	1.51	1.65
2	18.89%	0.12	1.09	1.25
3	16.17%	0.14	0.95	1.13
4	14.65%	0.16	0.88	1.08

Table 9: # of partitions per dimension, effect on APRIL size (MB).

#	T1	T2	T3	O5AF	O6AF	O5AS	O6AS	O5EU	O6EU	O5NA	O6NA	O5SA	O6SA	O5OC	O6OC
1	14.4	134.0	57.2	14.2	25.4	55.2	64.5	180.3	968.0	251.0	155.0	25.4	44.4	7.3	15.0
2	26.1	236.3	112.0	29.2	49.2	106.9	124.2	336.9	1900.0	453.4	311.8	51.5	86	14.3	49.2
3	37.1	352.6	166.7	44.7	74.2	164.0	188.3	492.5	2800.0	654.2	459.6	76.9	129.8	35.2	76.3
4	47.2	465.9	224.9	61.4	99.5	219.1	255.1	653.0	3700.0	875.1	619.0	104.2	172.3	49.1	107.7

polygons OneStep (Neighbors) is up to 32% slower than the Scanline method, however in most such cases their difference is negligible. On the other hand, in some datasets containing large polygons (e.g., T3, O6AF, O6SA) OneStep is up to one order of magnitude faster than Scanline (T3) and 33% to 224% faster than the rest of the methods. All methods proposed in Section 6 are orders of magnitude faster compared to rasterization for RI, because the latter has to perform expensive detection for Strong and Weak cells.

7.4 Comparative Study

Finally, we compare RI and APRIL with other intermediate filters in terms of space complexity, filter effectiveness, and filter cost. For all experiments, we created RI and APRIL using a single partition (i.e., the map of the two datasets that are joined in each case), rasterized on a $2^{16} \times 2^{16}$ grid, which is the best performing granularity for both methods. We used a fixed order (AA-,

Table 10: Join between T1 (order 16) and T3 (order N).

N	True hits	True negs.	Indecisive	Int. Filter (s)	Refinement (s)	Total (s)	T3 size (MB)
16	69.84%	28.13%	2.03%	0.19	0.33	0.57	57.2
15	69.63%	27.85%	2.52%	0.13	0.41	0.59	28.3
14	69.18%	27.46%	3.36%	0.11	0.54	0.70	14.0
13	68.39%	26.86%	4.75%	0.09	0.78	0.92	6.9
12	66.63%	25.70%	7.67%	0.09	1.23	1.37	3.4

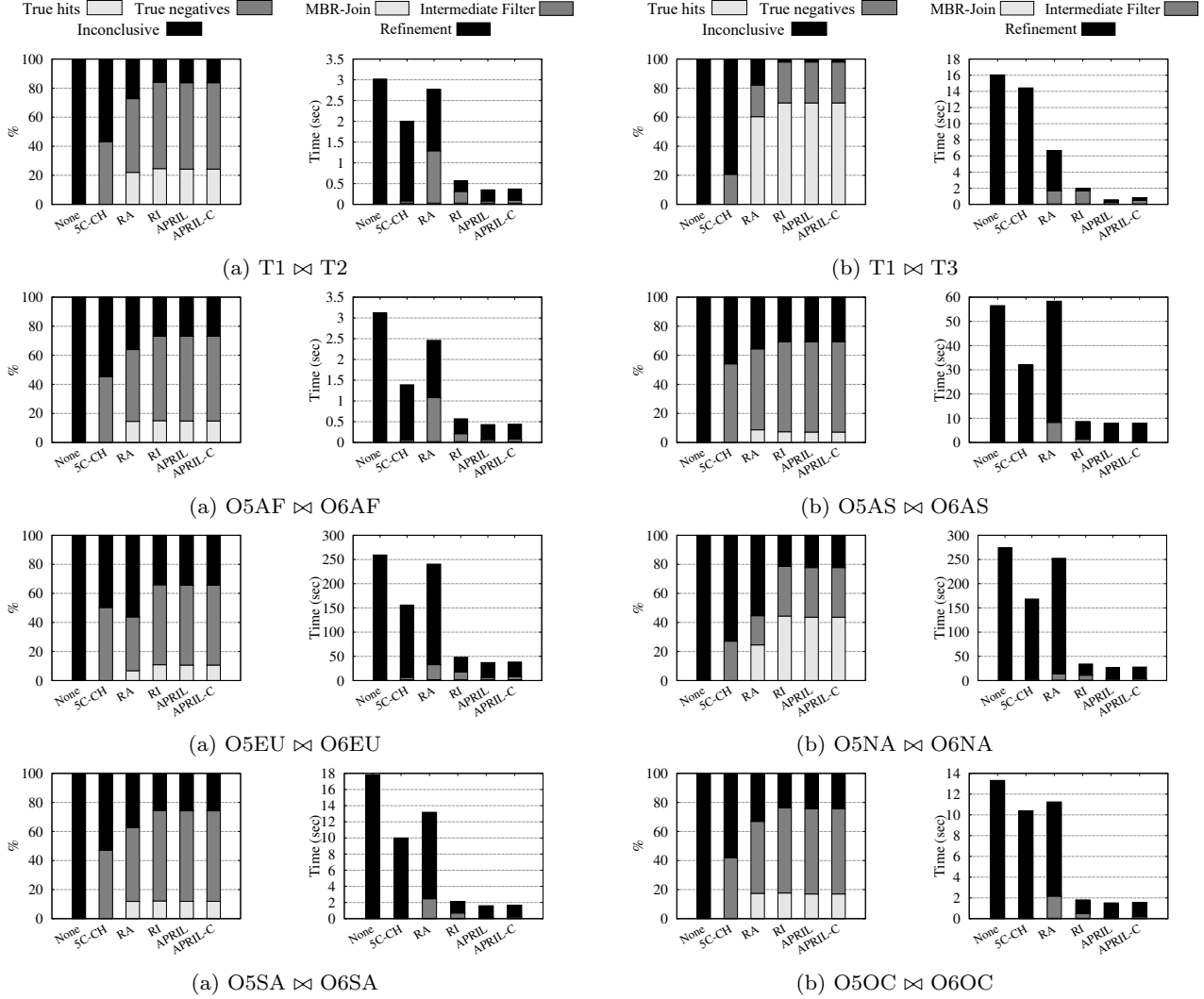

Fig. 13: Filter effectiveness and spatial join cost for various intermediate filters.

Table 11: Total construction cost (sec) for all datasets.

Dataset	RI	Flood Fill	Scanline	IDEAL	OneStep (PIPs)	OneStep (Neighbors)
T1	143.62	3.90	3.63	9.76	3.74	2.19
T2	601.67	28.05	23.06	37.40	33.76	23.43
T3	9919.06	265.72	278.50	666.19	75.40	28.33
O5AF	264.45	4.25	3.98	13.02	11.00	4.72
O6AF	468.47	13.06	12.62	32.45	5.66	4.17
O5AS	486.86	11.69	10.07	27.42	21.28	11.78
O6AS	994.93	28.98	24.76	56.14	65.01	25.07
O5EU	1193.71	36.08	30.30	58.18	55.79	33.71
O6EU	5493.15	172.20	147.29	244.95	243.17	156.94
O5NA	1530.92	53.33	45.26	72.34	133.39	66.60
O6NA	1630.29	43.40	40.89	76.62	51.79	30.71
O5SA	361.87	6.67	5.79	20.69	14.74	6.77
O6SA	1478.05	34.56	34.15	98.20	22.86	10.52
O5OC	39.99	2.88	2.48	6.17	3.82	2.49
O6OC	113.99	9.32	8.49	18.29	20.75	8.56

AF-, FA-) for the interval joins of APRIL, as shown in Algorithm 2.

7.4.1 Space Complexity

Table 4 shows the total space requirements of the object approximations required by each intermediate filter, for each of the datasets used in our experiments. APRIL and APRIL-C refer to the uncompressed and compressed version of APRIL, respectively. As a basis of comparison we also show the total space required

to store the exact geometries of the objects and their MBRs. Note that, in most cases, our methods (RI, APRIL and APRIL-C) are significantly more space efficient compared to RA and have similar or lower space requirements to the 5C-CH. The only exception is T3, which includes huge polygons that are relatively expensive to approximate even by APRIL-C. Notably, for most datasets, the compressed APRIL approximations have similar space requirements as the object MBRs, meaning that we can keep them in memory and use them in main-memory spatial joins [28] directly after the MBR-join step, without incurring any I/O.

7.4.2 Comparison in Spatial Intersection Joins

We evaluate APRIL (both compressed and uncompressed version), 5C+CH, RA, and RI, on all join pairs, in Figure 13. We compare their ability to detect true hits and true negatives, their computational costs as filters, and their impact to the end-to-end cost of the spatial join.

Filter Effectiveness APRIL and RI have the highest filter effectiveness among all approximations across the board. APRIL’s true hit ratio is slightly smaller compared to that of RI because APRIL fails to detect the (rare) pairs of polygons which only have Strong-Strong common cells. However, this only brings a marginal increase in the refinement step’s cost, at the benefit of having a faster and more space-efficient filter. In O5AS \bowtie O6AS and O5OC \bowtie O6OC, APRIL and RI have marginally lower true hit ratio compared to RA; however, in these cases their true negative ratio is much higher than that of RA. The least effective filter is 5C+CH, mainly due to its inability to detect true hits.

Intermediate Filter cost 5C+CH are simple approximations (a few points each), therefore the corresponding filter is very fast to apply. Notably, APRIL has a filtering cost very close to that of 5C+CH and sometimes even lower. This is due to APRIL’s ability to model a raster approximation as two sequences of integers, which are processed by a sequence of efficient merge-join algorithms. 5C+CH has poor filtering performance, which negatively affects the total join cost (last column), whereas APRIL is very fast and very effective at the same time. The state-of-the-art filter RI is more expensive than APRIL, because it requires the alignment and bitwise *AND*ing of the interval bitcodes. As a result, APRIL is 3.5-8.5 times faster as an intermediate filter compared to RI (note the “Intermediate Filter” part of the cost in the bars). A comparison between the filter costs of APRIL and APRIL-C reveals that decompressing the interval lists while performing the joins in APRIL-C only brings a small overhead, making compression well worthy, considering the space

Table 12: Improvement of APRIL over RI on all join pairs

APRIL vs. RI	range	average
APRIL size (times smaller)	0.95x–16.94x	2.59x
APRIL-C size (times smaller)	1.73x–60.54x	7.39x
Construction (times faster)	13.32x–350.13x	70.71x
Intermediate Filter (times faster)	3.45x–8.56x	4.86x
End-to-end Join (times faster)	1.10x–3.51x	1.58x

savings it offers (see Table 4). The decompression cost is significant only in T1 \bowtie T3, because T3’s *A*-lists and *F*-lists are quite long. Still, even in this case, APRIL-C is much faster than RI. **Refinement cost** The refinement cost is intertwined with the percentage of indecisive pairs. The detection of fewer candidate pairs as true hits or true negatives leads to a higher refinement workload; this is why APRIL and RI result in the lowest refinement cost, compared to the rest of the approximations.

Overall join cost APRIL (Section 4) reduces the overall cost of end-to-end spatial joins up to 3.5 times compared to using our RI intermediate filter (Section 3), while also achieving a speedup of 3.23x-25x against the rest of the approximations. Adding the APRIL intermediate filter between the MBR filter and the refinement step reduces the spatial join cost by 7x-28x. APRIL’s high filtering effectiveness, low application cost, and low memory requirements render it a superior approximation for filtering pairs in spatial intersection join pipelines.

APRIL vs. RI In summary, APRIL prevails over RI on all aspects including space complexity, construction time, filtering efficiency, and overall spatial intersection join time. Table 12, summarizes the improvement that APRIL achieves over RI on all join pairs.

7.4.3 Effect of variance in object sizes

We now test the effect that the variance between the sizes of joined objects has on the performance of APRIL compared to previous work. For this, besides T1, T2, and T3, we used two more Tiger datasets, i.e., T9 (States) and T10 (Zip codes). Table 14 lists statistics of all the Tiger datasets that we used in this experiment ordered by average area of the objects in them.

To demonstrate APRIL’s performance on dataset-pairs of varying object sizes, we joined the Water Areas dataset (T2), which has polygons with the smallest areas on average compared to other Tiger datasets, in increasing order of average area per object. Note that as the objects which are joined with T2-objects grow larger (T1, T10, T3 and then T9) the indecisive cases reduce drastically. This can be explained by the fact that as a polygon grows larger, it generates more Full

Table 13: End-to-end join performance between T2 and datasets with varying average object area.

Method	Accepted	Rejected	Inconclusive	Int. Filter (s)	Refinement (s)	Total time (s)
T2 \bowtie T1						
None	0.00%	0.00%	100.00%	0.00	2.94	2.98
RA (K=750)	21.98%	50.76%	27.26%	1.16	1.20	2.40
5C+CH	0.00%	43.15%	56.85%	0.05	1.65	1.74
APRIL	24.29%	59.42%	16.29%	0.05	0.27	0.35
T2 \bowtie T10						
None	0.00%	0.00%	100.00%	0.00	296.01	297.51
RA (K=750, K=150)	27.49%	25.15%	47.36%	27.61	228.51	257.55
5C+CH	0.00%	29.11%	70.89%	2.28	204.66	208.68
APRIL	51.92%	45.59%	2.50%	2.32	6.46	9.51
T2 \bowtie T3						
None	0.00%	0.00%	100.00%	0.00	310.81	312.38
RA (K=750, K=150)	58.27%	23.15%	18.58%	31.82	102.67	135.79
5C+CH	0.00%	22.03%	77.97%	2.32	224.14	228.40
APRIL	68.47%	29.88%	1.64%	3.22	5.29	9.32
T2 \bowtie T9						
None	0.00%	0.00%	100.00%	0.00	2595.44	2596.96
RA (K=750, K=150)	49.34%	20.26%	30.40%	24.55	1352.44	1378.21
5C+CH	0.00%	21.70%	78.30%	2.36	2003.41	2007.63
APRIL	68.04%	31.80%	0.16%	20.52	3.03	24.46

Dataset	# objects	avg # vertices	avg MBR area
T2 (Water areas)	2252316	31.9	4.03E-05
T1 (Landmarks)	123045	25.4	1.77E-04
T10 (Zip codes)	26091	1404.8	4.14E-02
T3 (Counties)	3043	2316.2	3.95E-01
T9 (States)	43	18140.4	2.59E+01

Table 14: TIGER dataset statistics, sorted by ascending average object MBR area.

intervals and thus, the probability of detecting a true hit between it and another polygon using APRIL increases. Table 13 shows a detailed performance comparison for the spatial intersection join between the TIGER datasets. In all cases, APRIL retains the best filtering effectiveness and total execution time. The performance gap between APRIL and the other methods grows with the difference in sizes between the objects in the candidate pairs, due to APRIL’s effectiveness in detecting true hits, avoiding their costly refinement.

7.4.4 Performance in other queries

We now evaluate the performance of APRIL in other queries, besides spatial intersection joins. We start with selection queries of arbitrary shape (see Section 4.3.1). For this experiment, we sampled 1000 polygons from T3 and applied them as selection queries on T1 and T2, simulating queries of the form: find all landmark areas (T1) or water areas (T2) that intersect with a given US county (T3). As Table 15 shows, compared to RI, APRIL achieves a 3.5x-4x speedup in the total query cost.

Next, we compare all methods in spatial *within* joins, where the objective is to find pairs (r, s) such that

r is within s (see Section 4.3.2). As Table 16 shows, APRIL again achieves the best performance, due to its extremely low filtering cost. APRIL is even faster than 5C+CH, because 5C+CH performs two polygon-in-polygon tests which are slower compared to a polygon intersection test.

Finally, we test the effectiveness of APRIL in polygon-linestring joins, as described in Section 4.3.3. For this experiment, we join the polygon sets T1, T2, and T3 with dataset T8 (from the same collection), which contains 16.9M linestrings (roads in the United States), each having 20.4 vertices on average. In this comparison, we do not include RI and RA, because Strong cell types cannot be used to detect true hits. Table 17 compares APRIL with 5C+CH and the skipping of an intermediate filter (None). 5C+CH only detects true negatives (in the case where the 5C+CH approximations do not intersect). APRIL outperforms 5C+CH by at least three times in total join time and by orders of magnitude in T3 \bowtie T8, where it can identify the great majority of join results as true hits.

8 Related Work

Most previous works on spatial intersection joins [21] focus on the filter step of the join (denoted by MBR-join). They either exploit the pre-existing indexes [10, 26] or partition the data on-the-fly and perform the join independently at each partition [33, 29, 49]. Each partition-to-partition MBR-join can be performed in memory with the help of plane-sweep [10, 5].

Table 15: APRIL vs. RI (polygonal range queries).

	True hits	True negatives	Indecisive	Int. Filter (s)	Refinement (s)	Total (s)
1000 T3 queries against T1						
RI	69.28%	28.60%	2.12%	0.52	0.10	0.64
APRIL	69.27%	28.60%	2.13%	0.06	0.10	0.18
1000 T3 queries against T2						
RI	68.46%	29.87%	1.67%	9.26	1.58	11.07
APRIL	68.46%	29.87%	1.67%	1.02	1.58	2.84

Table 16: Performance of filters (spatial within joins)

	True hits	True negatives	Indecisive	Int. Filter (s)	Refinement (s)	Total (s)
T2 \bowtie T1 (Tiger water in landmark areas)						
None	0.00%	0.00%	100.00%	0.00	3.61	3.64
5C+CH	0.00%	34.71%	65.29%	0.10	1.33	1.46
RA	13.48%	29.18%	57.34%	0.14	1.11	1.28
RI	18.48%	59.46%	22.06%	0.20	0.48	0.71
APRIL	18.48%	59.42%	22.11%	0.05	0.49	0.58
T1 \bowtie T3 (Tiger landmark in county areas)						
None	0.00%	0.00%	100.00%	0.00	20.14	20.19
5C+CH	0.00%	20.72%	79.28%	0.37	14.02	14.44
RA	44.35%	14.29%	41.36%	0.51	8.26	8.82
RI	68.05%	28.13%	3.82%	1.56	0.80	2.41
APRIL	68.05%	28.13%	3.82%	0.21	0.80	1.06
T2 \bowtie T3 (Tiger water in county areas)						
None	0.00%	0.00%	100.00%	0.00	383.49	384.23
5C+CH	0.00%	22.17%	77.83%	7.70	274.54	282.98
RA	42.50%	15.25%	42.25%	9.53	165.50	175.77
RI	67.36%	29.88%	2.75%	27.08	12.22	40.04
APRIL	67.36%	29.88%	2.75%	3.47	12.22	16.43

Table 17: Polygon-linestring spatial intersection joins.

	True hits	True negatives	Indecisive	Int. Filter (s)	Refinement (s)	Total (s)
T1 \bowtie T8 (Tiger landmarks and roads)						
None	0.00%	0.00%	100.00%	0.00	27.82	28.25
5C+CH	0.00%	45.24%	54.76%	1.07	15.99	17.49
APRIL	12.70%	55.01%	32.29%	0.93	3.82	5.18
T2 \bowtie T8 (Tiger water areas and roads)						
None	0.00%	0.00%	100.00%	0.00	238.91	241.59
5C+CH	0.00%	68.13%	31.87%	6.24	90.60	99.52
APRIL	0.08%	90.22%	9.71%	5.58	19.92	28.17
T3 \bowtie T8 (Tiger county areas and roads)						
None	0.00%	0.00%	100.00%	0.00	2546.48	2543.37
5C+CH	0.00%	22.79%	77.21%	16.21	1855.63	1878.73
APRIL	66.25%	30.77%	2.98%	25.64	58.23	90.77

Intermediate filters To further reduce the candidate pairs that reach the refinement step, conservative and/or progressive object approximations can be used for identifying false hits and/or true hits, respectively. Brinkhoff et al. [9] suggested the use of the convex hull and the minimum bounding 5-corner convex polygon (5C) as conservative approximations and the maximum enclosing rectangle (MER) as a progressive approximation. MER is hard to compute and of questionable effectiveness [58], hence, we did not include it in our comparison. In follow-up work [58], the object geometries are rasterized and modeled as grids, where each cell is colored

based on its percentage of its coverage by the object. By re-scaling and aligning the grids of two candidate join objects, we can infer, in most cases, whether the objects are a join pair or a false hit. Indecisive pairs are forwarded to the refinement step.

Raster-based approaches for other queries Hierarchical (quad-tree based) raster approximations based on a hierarchical grid have been used in the past [17] for window and distance queries. In addition, Teng et al. [46] propose IDEAL, a hybrid vector-raster polygonal approximation, targeting point-in-polygon queries and point-to-polygon distance queries. The approximations

in IDEAL are similar to those of APRIL in that they capture information about Full or Partial coverage of each cell, but they also have important differences that render IDEAL approximations not appropriate for spatial intersection joins. Specifically, in IDEAL, each polygon is approximated by its own (local) grid, defined by splitting the object’s MBR. Hence, the IDEAL grids of two different objects are not necessarily aligned to each other and may have different resolutions, as shown in Figure 14(a). Hence, IDEAL approximations are not appropriate for intersection (or distance) joins because aligning the two different grids of two polygons (having different positions, cell size, and resolution) is hard and inference of polygon intersection from the cell types if the cells are not perfectly aligned is not trivial. Another difference between IDEAL and our work is that cells in IDEAL are not grouped into intervals and interval joins are not used as operations.

RAPTOR [38, 40, 39] joins a raster dataset (map of pixels, where each pixel is associated with values such as temperature) with a vector dataset (e.g., set of polygons, linestrings, or points). The objective of Raptor-Join is to identify, for each vector object o , the pixels that are relevant to o and associate with o the values of these pixels to the object (e.g., aggregate them). For example, if the vector object o is a polygon, the relevant pixels to o are those whose centroids are included in o . Hence, in Figure 14(b), the dashed polygon is relevant to the cells in light-gray and the solid-border polygon is relevant to the cells in dark-gray. To compute the Raptor-Join, in a pre-processing step, all relevant cells to each object are identified and stored in a tabular representation (called Flash Index), with intervals of contiguous cells per row of the raster matrix. For example, the solid-border polygon is represented by three tuples: $\{(5, [1, 2]), (6, [1, 2]), (7, [0, 3])\}$, implying that the polygon spans columns 1-2 in rows 5 and 6, and columns 0-3 in row 7. This is reminiscent to our APRIL approximations, where each object is represented by intervals of cells. However, raster representations of vector objects used by RAPTOR have several important differences to APRIL. First, for a cell to be included in a Raptor approximation, the center of the cell should lie inside the polygon, whereas in APRIL the cell should overlap with the polygon. This means, for example, that cell (4,1) is not part of the solid-border polygon approximation in Raptor, whereas it is part of its APRIL approximation. Second, APRIL differentiates between Full and Partial cells, whereas Raptor only has one type of cells. The most important difference is that Raptor-join cannot be used for the problem of spatial intersection joins that we study in this paper, as it is possible that two polygons intersect but their Raptor approximations share

no common cell(s). In the example of Figure 14(b), the two polygons intersect each other in cells (4,1), (4,2), and (6,4). Cells (4,1), (4,2) are included in the approximation of the dashed-border polygon but not in the other one, whereas cell (6,4) is included in neither of the two Raptor approximations. Hence, Raptor-join, if applied for spatial intersection joins, would mistakenly prune this pair of objects as false positive.

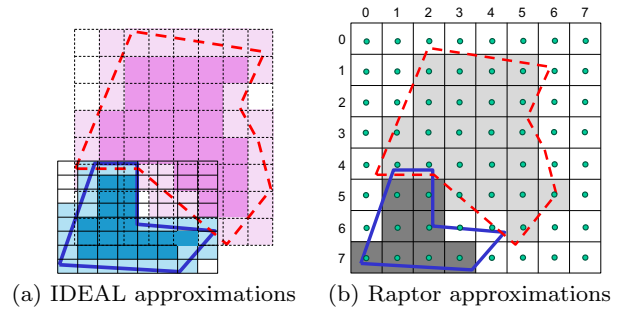

Fig. 14: Examples of IDEAL and Raptor object approximations.

Speeding up the refinement step Checking whether two polygons overlap requires point-in-polygon tests and finding an intersection in the union of line segments that form both polygons [9]. A point-in-polygon test bears a $O(n)$ cost, while the second problem can be solved in $O(n \log n)$ time [35], where n is the total number of edges in both polygons. Given a pair of candidate objects, Aghajarian et al. [2] prune all line segments from the object geometries that do not intersect their common MBR (CMBR) (i.e., the intersection area of their MBRs), before applying the refinement step. This reduces the complexity of refinement, as a smaller number of segments need to be checked for intersection. In addition, if one object MBR is contained in the other, then the point-in-polygon test is applied before the segment intersection test. Polysketch [25] decomposes each object to a set of tiles, i.e., small MBRs which include consecutive line segments of the object’s geometry. Given two candidate objects, the refinement step is then applied only for the tile-pairs that overlap. A similar idea (trapezoidal decomposition) was suggested by Brinkhoff et al. [9] and alternative polygon decomposition approaches were suggested in [6]. PSCMBR [24] combines Polysketch with the CMBR approach. Specifically, for the two candidate objects, the overlapping pairs of Polysketch tiles are found; for each such pair, the segments in the two tiles that do not overlap with the CMBR of the tiles are pruned before refining the contents of the tiles. Polysketch and PSCMBR focus on finding the intersection points of two objects,

hence, unlike our approach, they do not identify true hits. The CMBR approach [2] is fully integrated in our implementation; still the refinement cost remains high. Finally, the Clipped Bounding Box (CBB) [37] is an enriched representation of the MBR that captures the dead (unused) space at MBR corners with a few auxiliary points, providing the opportunity of refinement step avoidance in the case where object CBBs intersect only at their common dead-space areas. CBBs can also be used by R-tree nodes to avoid their traversal if the query range overlaps only with their dead space.

Approximate spatial joins The approximate representation of objects and approximate spatial query evaluation using space-filling curves was first suggested by Orenstein [30]. Recent work explores the use of raster approximations for the approximate evaluation of spatial joins and other operations [22,56,51]. Our work is the first to approximate polygon rasterizations as intervals for *exact* spatial query evaluation.

Spatial joins on GPUs The widespread availability of programmable GPUs has inspired several research efforts that leverage GPUs for spatial joins [44,2,1,25,24]. Sun et al. [44] accelerated the join refinement step by incorporating GPU rasterization as an intermediate filter. This filter identifies *only true negatives* using a low resolution, and has thus limited pruning effectiveness. Aghajarian et al. [2,1] proposed a GPU approach to process point-polygon and polygon-polygon joins for datasets that can be accommodated in GPU memory. Liu et al. [25,24] also proposed GPU-accelerated filters to reduce the number of refinements. These filters [2,1,25,24], in contrast to APRIL, *do not identify true hits*, but rather focus on finding the intersection points between a candidate pair. Furthermore, the above approaches [2,1,25,24] do not involve rasterization and rely on CUDA, which is exclusive to NVIDIA GPUs. A recent line of work [55,14,56,15] proposes to use the GPU rasterization pipeline as an integral component of spatial query processing. Doraiswamy et al. [14,15] introduced a spatial data model and algebra that is designed to exploit modern GPUs. Their approach leverages a data representation called *canvas*, which stores polygons as collections of pixels. The canvas includes a flag that differentiates between pixels that lie on the boundary of the polygon and those that are entirely covered by it. Although current-generation GPUs can handle millions of polygons at fast frame rates, the evaluation of spatial queries is still dominated by other costs, such as triangulating polygons and performing I/Os [15].

Scalability in spatial data management The emergence of cloud computing has led to many efforts to scale out spatial data management [31]. SJMP [57] is

an adaptation of the PBSM spatial join algorithm [33] for MapReduce. Other spatial data management systems that use MapReduce or Spark and handle spatial joins include Hadoop-GIS [3], SpatialHadoop [16], Magellan [43], SpatialSpark [53], Simba [52], and Apache Sedona [54]. These systems perform spatial partitioning of the data and distribution of the partitions to different machines, in order to improve scalability of spatial data management and query processing. Each partition is typically indexed by a data structure such as the R-tree or the quadtree, which facilitate spatial query evaluation. Regarding spatial intersection joins, all the aforementioned systems focus only on the filter step and forward all candidate pairs directly to the refinement phase, which is implemented with the help of off-the-shelf libraries such as JTS². APRIL is orthogonal to the data partitioning approaches applied by these systems in the sense that its intermediate filter can follow any MBR filter or spatial index. The enhanced filtering of the added intermediate step reduces the amount of candidate pairs that must be geometrically refined, significantly improving the overall performance of spatial intersection join evaluation in them. Besides, as discussed in Section 5.2, rasterization and APRIL object approximations can be applied independently to each one of the space-oriented partitions used by such systems.

9 Conclusions

In this paper, we proposed a technique that represents raster approximations of polygons as sets of intervals, offering a fast and effective intermediate step between the filter and the refinement steps of polygon intersection joins. RI, the first version of our approach approximates each object as a single list of intervals that include the raster cells that intersect the object; together with each interval we store a bitstring that encodes the classes of cells (Full, Strong, Weak) in the interval. APRIL is an enhanced version of our method that captures the cells that are partially or fully covered by the object by two lists of intervals and drops the space-consuming and burdensome bitstring. APRIL’s intermediate filter is different in that of RI in that it performs a pipeline of three interval joins instead of a single interval join paired with bitwise operations on the bitstrings.

As we have shown experimentally, compared to previous approaches [9,58], APRIL is (i) lightweight, as it represents each polygon by two lists of integers that can be effectively compressed; (ii) effective, as it typi-

² locationtech.github.io/jts/

cally filters the majority of MBR-join pairs as true negatives or true positives; and (iii) efficient to apply, as it only requires at most three linear scans over the interval lists. Specifically, RI and APRIL offer at least 3x speedup in end-to-end spatial intersection joins compared to previous intermediate filters (raster approximations [58], 5C-CH [9]). At the same time, the space complexity of RI and APRIL is relatively low and the approximations can easily be accommodated in main memory. Compared to RI approximations, APRIL approximations are much cheaper to construct, occupy significantly less space, offer a much faster intermediate filter, and significantly improve the end-to-end cost of spatial intersection joins.

APRIL is a general approximation for polygons that can also be used in selection queries, within-joins and joins between polygons and linestrings. We propose a compression technique for APRIL and customizations that trade space for filter effectiveness. Finally, we propose an efficient construction technique for APRIL approximations, which is orders of magnitude faster than rasterization-based techniques used for other filters.

In the future, we plan to investigate further the problem of interval join order optimization and explore the effectiveness of APRIL for 3D objects (e.g., polytopes). We also aim to investigate integrating APRIL into a big distributed spatial database management system, such as Apache Sedona as well as in open-source spatial database systems such as PostGIS.



Acknowledgements The research project was supported by the Hellenic Foundation for Research and Innovation (H.F.R.I.) under the “2nd Call for H.F.R.I. Research Projects to support Faculty Members & Researchers” (Project Number: 02757).

References

1. Aghajarian, D., Prasad, S.K.: A spatial join algorithm based on a non-uniform grid technique over GPGPU. In: E.G. Hoel, S.D. Newsam, S. Ravada, R. Tamassia, G. Trajcevski (eds.) Proceedings of the 25th ACM SIGSPATIAL International Conference on Advances in Geographic Information Systems, GIS 2017, Redondo Beach, CA, USA, November 7-10, 2017, pp. 56:1–56:4. ACM (2017)
2. Aghajarian, D., Puri, S., Prasad, S.K.: GCMF: an efficient end-to-end spatial join system over large polygonal datasets on GPGPU platform. In: Proceedings of the 24th ACM SIGSPATIAL International Conference on Advances in Geographic Information Systems, GIS 2016, Burlingame, California, USA, October 31 - November 3, 2016, pp. 18:1–18:10. ACM (2016)
3. Aji, A., Wang, F., Vo, H., Lee, R., Liu, Q., Zhang, X., Saltz, J.H.: Hadoop-gis: A high performance spatial data warehousing system over mapreduce. *Proc. VLDB Endow.* **6**(11), 1009–1020 (2013)
4. Amanatides, J., Woo, A.: A fast voxel traversal algorithm for ray tracing. In: 8th European Computer Graphics Conference and Exhibition, Eurographics 1987, Amsterdam, The Netherlands, August 24-28, 1987, Proceedings. North-Holland / Eurographics Association (1987)
5. Arge, L., Procopiuc, O., Ramaswamy, S., Suel, T., Vitter, J.S.: Scalable sweeping-based spatial join. In: A. Gupta, O. Shmueli, J. Widom (eds.) VLDB’98, Proceedings of 24th International Conference on Very Large Data Bases, August 24-27, 1998, New York City, New York, USA, pp. 570–581. Morgan Kaufmann (1998)
6. Badawy, W.M., Aref, W.G.: On local heuristics to speed up polygon-polygon intersection tests. In: ACM-GIS ’99, Proceedings of the 7th International Symposium on Advances in Geographic Information Systems, November 2-6, 1999, Kansas City, USA, pp. 97–102. ACM (1999)
7. de Berg, M., Cheong, O., van Kreveld, M.J., Overmars, M.H.: Computational geometry: algorithms and applications, 3rd Edition. Springer (2008)
8. Bresenham, J.: Algorithm for computer control of a digital plotter. *IBM Syst. J.* **4**(1), 25–30 (1965)
9. Brinkhoff, T., Kriegel, H., Schneider, R., Seeger, B.: Multi-step processing of spatial joins. In: R.T. Snodgrass, M. Winslett (eds.) Proceedings of the 1994 ACM SIGMOD International Conference on Management of Data, Minneapolis, Minnesota, USA, May 24-27, 1994, pp. 197–208. ACM Press (1994)
10. Brinkhoff, T., Kriegel, H., Seeger, B.: Efficient processing of spatial joins using r-trees. In: Proceedings of the 1993 ACM SIGMOD International Conference on Management of Data, Washington, DC, USA, May 26-28, 1993, pp. 237–246. ACM Press (1993)
11. crupstahl: libvbyte - Fast C Library for 32bit and 64bit Integer Compression (2017). URL <https://github.com/crupstahl/libvbyte>
12. Cutting, D.R., Pedersen, J.O.: Optimizations for dynamic inverted index maintenance. In: SIGIR’90, 13th International Conference on Research and Development in Information Retrieval, Brussels, Belgium, 5-7 September 1990, Proceedings, pp. 405–411. ACM (1990)
13. Dittrich, J., Seeger, B.: Data redundancy and duplicate detection in spatial join processing. In: D.B. Lomet, G. Weikum (eds.) Proceedings of the 16th International Conference on Data Engineering, San Diego, California, USA, February 28 - March 3, 2000, pp. 535–546. IEEE Computer Society (2000)
14. Doraiswamy, H., Freire, J.: A gpu-friendly geometric data model and algebra for spatial queries. In: Proceedings of the 2020 International Conference on Management of Data, SIGMOD Conference 2020, online conference [Portland, OR, USA], June 14-19, 2020, pp. 1875–1885. ACM (2020)
15. Doraiswamy, H., Freire, J.: SPADE: gpu-powered spatial database engine for commodity hardware. In: 38th IEEE International Conference on Data Engineering, ICDE 2022, Kuala Lumpur, Malaysia, May 9-12, 2022, pp. 2669–2681. IEEE (2022)
16. Eldawy, A., Mokbel, M.F.: Spatialhadoop: A mapreduce framework for spatial data. In: J. Gehrke, W. Lehner, K. Shim, S.K. Cha, G.M. Lohman (eds.) 31st IEEE International Conference on Data Engineering, ICDE 2015, Seoul, South Korea, April 13-17, 2015, pp. 1352–1363. IEEE Computer Society (2015)
17. Fang, Y., Friedman, M.T., Nair, G., Rys, M., Schmid, A.: Spatial indexing in microsoft SQL server 2008. In: Pro-

- ceedings of the ACM SIGMOD International Conference on Management of Data, SIGMOD 2008, Vancouver, BC, Canada, June 10-12, 2008, pp. 1207–1216 (2008)
18. Georgiadis, T., Mamoulis, N.: Raster intervals: An approximation technique for polygon intersection joins. In: Proceedings of the 2023 ACM SIGMOD International Conference on Management of Data, Seattle, Washington, USA, June (2023)
 19. Guttman, A.: R-trees: A dynamic index structure for spatial searching. In: B. Yorlmark (ed.) SIGMOD'84, Proceedings of Annual Meeting, Boston, Massachusetts, USA, June 18-21, 1984, pp. 47–57. ACM Press (1984)
 20. Hilbert, D.: Über die stetige abbildung einer linie auf ein flächenstück. *Mathematische Annalen* **38**(1), 459–460 (1891)
 21. Jacox, E.H., Samet, H.: Spatial join techniques. *ACM Trans. Database Syst.* **32**(1), 7 (2007)
 22. Kipf, A., Lang, H., Pandey, V., Persa, R.A., Anneser, C., Zacharitou, E.T., Doraiswamy, H., Boncz, P.A., Neumann, T., Kemper, A.: Adaptive main-memory indexing for high-performance point-polygon joins. In: Proceedings of the 23rd International Conference on Extending Database Technology, EDBT 2020, Copenhagen, Denmark, March 30 - April 02, 2020, pp. 347–358. OpenProceedings.org (2020)
 23. Lemire, D., Boytsov, L.: Decoding billions of integers per second through vectorization. *CoRR* **abs/1209.2137** (2012)
 24. Liu, Y., Puri, S.: Efficient filters for geometric intersection computations using GPU. In: C. Lu, F. Wang, G. Trajcevski, Y. Huang, S.D. Newsam, L. Xiong (eds.) SIGSPATIAL '20: 28th International Conference on Advances in Geographic Information Systems, Seattle, WA, USA, November 3-6, 2020, pp. 487–496. ACM (2020)
 25. Liu, Y., Yang, J., Puri, S.: Hierarchical filter and refinement system over large polygonal datasets on CPU-GPU. In: 26th IEEE International Conference on High Performance Computing, Data, and Analytics, HiPC 2019, Hyderabad, India, December 17-20, 2019, pp. 141–151. IEEE (2019)
 26. Mamoulis, N., Papadias, D.: Slot index spatial join. *IEEE Trans. Knowl. Data Eng.* **15**(1), 211–231 (2003)
 27. Museth, K.: Hierarchical digital differential analyzer for efficient ray-marching in opendb. In: Special Interest Group on Computer Graphics and Interactive Techniques Conference, SIGGRAPH '14, Vancouver, Canada, August 10-14, 2014, Talks Proceedings, p. 40:1. ACM (2014)
 28. Nobari, S., Qu, Q., Jensen, C.S.: In-memory spatial join: The data matters! In: Proceedings of the 20th International Conference on Extending Database Technology, EDBT 2017, Venice, Italy, March 21-24, 2017, pp. 462–465. OpenProceedings.org (2017)
 29. Nobari, S., Tauheed, F., Heinis, T., Karras, P., Bressan, S., Ailamaki, A.: TOUCH: in-memory spatial join by hierarchical data-oriented partitioning. In: Proceedings of the ACM SIGMOD International Conference on Management of Data, SIGMOD 2013, New York, NY, USA, June 22-27, 2013, pp. 701–712. ACM (2013)
 30. Orenstein, J.A.: Redundancy in spatial databases. In: Proceedings of the 1989 ACM SIGMOD International Conference on Management of Data, Portland, Oregon, USA, May 31 - June 2, 1989, pp. 295–305. ACM Press (1989)
 31. Pandey, V., Kipf, A., Neumann, T., Kemper, A.: How good are modern spatial analytics systems? *Proc. VLDB Endow.* **11**(11), 1661–1673 (2018)
 32. Papadakis, G., Mandilaras, G.M., Mamoulis, N., Koubarakis, M.: Progressive, holistic geospatial interlinking. In: WWW '21: The Web Conference 2021, Virtual Event / Ljubljana, Slovenia, April 19-23, 2021, pp. 833–844. ACM / IW3C2 (2021)
 33. Patel, J.M., DeWitt, D.J.: Partition based spatial-merge join. In: Proceedings of the 1996 ACM SIGMOD International Conference on Management of Data, Montreal, Quebec, Canada, June 4-6, 1996, pp. 259–270. ACM Press (1996)
 34. Reynolds, C.: Filling polygons. *Architecture Machinations*, Department of Architecture, Massachusetts Institute of Technology, Room **9**, 518 (1977)
 35. Shamos, M.I., Hoey, D.: Geometric intersection problems. In: 17th Annual Symposium on Foundations of Computer Science, Houston, Texas, USA, 25-27 October 1976, pp. 208–215. IEEE Computer Society (1976)
 36. Shinya, M., Forgue, M.: Interference detection through rasterization. *Comput. Animat. Virtual Worlds* **2**(4), 132–134 (1991)
 37. Sidlauskas, D., Chester, S., Zacharitou, E.T., Ailamaki, A.: Improving spatial data processing by clipping minimum bounding boxes. pp. 425–436. IEEE Computer Society (2018)
 38. Singla, S., Eldawy, A.: Raptor zonal statistics: Fully distributed zonal statistics of big raster + vector data. In: 2020 IEEE International Conference on Big Data (IEEE BigData 2020), Atlanta, GA, USA, December 10-13, 2020, pp. 571–580. IEEE (2020)
 39. Singla, S., Eldawy, A., Diao, T., Mukhopadhyay, A., Scudiero, E.: Experimental study of big raster and vector database systems. In: 37th IEEE International Conference on Data Engineering, ICDE 2021, Chania, Greece, April 19-22, 2021, pp. 2243–2248. IEEE (2021)
 40. Singla, S., Eldawy, A., Diao, T., Mukhopadhyay, A., Scudiero, E.: The raptor join operator for processing big raster + vector data. In: SIGSPATIAL '21: 29th International Conference on Advances in Geographic Information Systems, Virtual Event / Beijing, China, November 2-5, 2021, pp. 324–335. ACM (2021)
 41. Smith, A.R.: Tint fill. In: Proceedings of the 6th Annual Conference on Computer Graphics and Interactive Techniques, SIGGRAPH 1979, Chicago, Illinois, USA, August 8-10, 1979, pp. 276–283. ACM (1979)
 42. SpatialHadoop: TIGER datasets (2015). URL <http://spatialhadoop.cs.umn.edu/datasets.html>
 43. Sriharsha, R.: Magellan: Geospatial analytics using spark. <https://github.com/harsha2010/magellan>
 44. Sun, C., Agrawal, D., El Abbadi, A.: Hardware acceleration for spatial selections and joins. In: Proceedings of the ACM SIGMOD International Conference on Management of Data, San Diego, California, USA, p. 455–466. ACM (2003)
 45. Teng, D.: IDEAL (2021). URL <https://github.com/tengdj/IDEAL>
 46. Teng, D., Baig, F., Sun, Q., Kong, J., Wang, F.: IDEAL: a vector-raster hybrid model for efficient spatial queries over complex polygons. In: 22nd IEEE International Conference on Mobile Data Management, MDM 2021, Toronto, ON, Canada, June 15-18, 2021, pp. 99–108. IEEE (2021)
 47. Theodoridis, K., Liagouris, J., Mamoulis, N., Bouros, P., Terrovitis, M.: SRX: efficient management of spatial RDF data. *VLDB J.* **28**(5), 703–733 (2019)
 48. Thiel, L.H., Heaps, H.S.: Program design for retrospective searches on large data bases. *Inf. Storage Retr.* **8**(1), 1–20 (1972)

49. Tsitsigkos, D., Bouros, P., Mamoulis, N., Terrovitis, M.: Parallel in-memory evaluation of spatial joins. In: Proceedings of the 27th ACM SIGSPATIAL International Conference on Advances in Geographic Information Systems, SIGSPATIAL 2019, Chicago, IL, USA, November 5-8, 2019, pp. 516–519. ACM (2019)
50. Tsitsigkos, D., Lampropoulos, K., Bouros, P., Mamoulis, N., Terrovitis, M.: A two-layer partitioning for non-point spatial data. In: 37th IEEE International Conference on Data Engineering, ICDE 2021, Chania, Greece, April 19-22, 2021, pp. 1787–1798. IEEE (2021)
51. Winter, C., Kipf, A., Anneser, C., Zacharatou, E.T., Neumann, T., Kemper, A.: Geoblocks: A query-cache accelerated data structure for spatial aggregation over polygons. In: Proceedings of the 24th International Conference on Extending Database Technology, EDBT 2021, Nicosia, Cyprus, March 23 - 26, 2021, pp. 169–180. OpenProceedings.org (2021)
52. Xie, D., Li, F., Yao, B., Li, G., Zhou, L., Guo, M.: Simba: Efficient in-memory spatial analytics. In: F. Özcan, G. Koutrika, S. Madden (eds.) Proceedings of the 2016 International Conference on Management of Data, SIGMOD Conference 2016, San Francisco, CA, USA, June 26 - July 01, 2016, pp. 1071–1085. ACM (2016)
53. You, S., Zhang, J., Gruenwald, L.: Large-scale spatial join query processing in cloud. In: CloudDB, ICDE Workshops, pp. 34–41 (2015)
54. Yu, J., Zhang, Z., Sarwat, M.: Spatial data management in apache spark: the geospark perspective and beyond. *GeoInformatica* **23**(1), 37–78 (2019)
55. Zacharatou, E.T., Doraiswamy, H., Ailamaki, A., Silva, C.T., Freire, J.: GPU rasterization for real-time spatial aggregation over arbitrary polygons. *Proc. VLDB Endow.* **11**(3), 352–365 (2017)
56. Zacharatou, E.T., Kipf, A., Sabek, I., Pandey, V., Doraiswamy, H., Markl, V.: The case for distance-bounded spatial approximations. In: 11th Conference on Innovative Data Systems Research, CIDR 2021, Virtual Event, January 11-15, 2021, Online Proceedings. www.cidrdb.org (2021)
57. Zhang, S., Han, J., Liu, Z., Wang, K., Xu, Z.: SJMR: parallelizing spatial join with mapreduce on clusters. In: Proceedings of the 2009 IEEE International Conference on Cluster Computing, August 31 - September 4, 2009, New Orleans, Louisiana, USA, pp. 1–8. IEEE Computer Society (2009)
58. Zimbrão, G., de Souza, J.M.: A raster approximation for processing of spatial joins. In: VLDB'98, Proceedings of 24rd International Conference on Very Large Data Bases, August 24-27, 1998, New York City, New York, USA, pp. 558–569 (1998)