IDENTIFIABILITY OF DIRECT EFFECTS FROM SUMMARY CAUSAL GRAPHS

A PREPRINT

• Simon Ferreira
ENS de Lyon
EasyVista

• Charles K. Assaad
EasyVista

ABSTRACT

Dynamic structural causal models (SCMs) are a powerful framework for reasoning in dynamic systems about direct effects which measure how a change in one variable affects another variable while holding all other variables constant. The causal relations in a dynamic structural causal model can be qualitatively represented with a full-time causal graph. Assuming linearity and causal sufficiency and given the full-time causal graph, the direct causal effect is always identifiable and can be estimated from data by adjusting on any set of variables given by the so-called single-door criterion. However, in many application such a graph is not available for various reasons but nevertheless experts have access to an abstraction of the full-time causal graph which represents causal relations between time series while omitting temporal information. This paper presents a complete identifiability result which characterizes all cases for which the direct effect is graphically identifiable from summary causal graphs and gives two sound finite adjustment sets that can be used to estimate the direct effect whenever it is identifiable.

1 Introduction

Structural causal models (SCMs) are a powerful framework for representing and reasoning about causal relations between variables with a long history in many fields such as genetics (Wright, 1920, 1921), econometrics (Haavelmo, 1943), social sciences (Duncan, 1975; Goldberger, 1972), and artificial intelligence (Pearl, 2000). In particular, SCMs are useful for reasoning about direct effects which measure how a change in one variable affects another variable while holding all other variables constant (Pearl, 2012). The identification and estimation of direct effects are important in many application, *e.g.*, epidemiologists are interested in measuring how smoking affects lung cancer risk without being mediated by genetic susceptibility (Zhou et al., 2021); ecologists are usually focus on understanding direct effects such as competition, herbivory, and predation (Connell, 1961); IT monitoring expert can localize the root cause of a system failure or a performance issue by comparing the direct causal impact of different components on each other before and after the failure (Assaad et al., 2023).

In the framework of (non-dynamic) SCMs, assuming linearity and causal sufficiency and given a causal graph which qualitatively represents causal relations between different variables, the direct effect between two variables is always identifiable and there exists a complete graphical tool, called the single-door criterion (Pearl, 1998; Spirtes et al., 1998; Pearl, 2000) that finds all possible adjustment sets that allow to estimate the direct effect from data. These results are directly applicable in dynamic SCMs given the full-time causal graph—which qualitatively represents all causal relations between different temporal instants of the dynamic SCM—and assuming consistency throughout time and that the full-time causal graph is acyclic. However, in many dynamic systems, experts have difficulties in building a full-time causal graph (Aït-Bachir et al., 2023), while they can usually build a summary causal graph (Assaad et al., 2022) which is an abstraction of the full-time causal graph where temporal information is omitted.

So far, the problem of identifying direct effects has only been addressed for summary causal graphs under the assumption that the summary causal graph is acyclic (while allowing self-loops). In particular, it has been shown that direct effects are always identifiable in an acyclic summary causal graph with loops and a non-complete extension of

the single-door criterion has been proposed to find some adjustment sets that allow to estimate the direct effect from data (Assaad et al., 2023).

In this work, we focus on the identifiability of direct effects from summary causal graphs without assuming that the given summary causal graph is acyclic. Our main contribution is two-folds. First, we give a complete identifiability result which characterizes all cases for which a direct effect is graphically identifiable from a summary causal graph. Then, we present two finite adjustment sets that can be used to estimate the direct effect from data whenever it is identifiable.

The remainder of the paper is organized as follows: Section 2 gives the definitions of direct effect and summary causal graph and recall all necessary graphical preliminaries. Section 3 presents the complete identifiability result and Section 4 provides two finite adjustment sets that can be used to estimate the direct effect from data whenever it is identifiable. Then, Section 5 discusses some interesting examples of other adjustments sets for specific summary causal graphs which can be helpful for a future work that aims to develop a complete criterion for finding all possible finite adjustments sets. Finally, Section 6 concludes the paper.

2 Problem setup

In this section, we first introduce some terminology, tools, and assumptions which are standard for the major part. Then, we formalize the problem we are going to solve. Without any opposite mention, we refer to the variables as capital letters and to the associated potential values as lower cases. Calligraphic letters correspond to vectors or sets.

In this work, we consider that a dynamic system can be represented by a linear dynamic structural causal model (SCM).

Definition 1 (Linear dynamic SCM). *Considering a finite set of times series \mathcal{V} , a linear structural causal model (SCM) is a set of equations in which each instant $t \in \mathbb{Z}$ of time serie (e.g., Y_t) is defined as a linear function of past instants of itself (e.g., $Y_{t-\gamma}$, $\gamma > 0$), past or present instants of other times series (e.g., $X_{t-\gamma}$, $X \neq Y$, $\gamma \geq 0$) and of some noise (e.g., ξ_{Y_t}):*

$$Y_t := \left(\sum_{\gamma > 0} \alpha_{Y_t, Y_{t-\gamma}} * Y_{t-\gamma} \right) + \left(\sum_{X \neq Y, \gamma \geq 0} \alpha_{Y_t, X_{t-\gamma}} * X_{t-\gamma} \right) + \xi_{Y_t},$$

where the noise variables are assumed to be jointly independent (i.e., $\forall X, Y \forall t^X, t^Y, X_{t^X} \neq Y_{t^Y} \implies \xi_{X_{t^X}} \perp\!\!\!\perp \xi_{Y_{t^Y}}$) and any coefficient α can be zero.

In the following, we start by defining direct effects in general and then we give its definition in the case of linear dynamic SCMs.

Definition 2 (Direct effect, adapted from Pearl (2000)). *The direct effect of $X_{t-\gamma_{xy}}$ on Y_t is given by:*

$$P(y_t | do(x_{t-\gamma_{xy}}), do(v_{X_{t-\gamma_{xy}}, Y_t})) - P(y_t | do(x'_{t-\gamma_{xy}}), do(v_{X_{t-\gamma_{xy}}, Y_t})),$$

where $\mathcal{V}_{X_{t-\gamma_{xy}}, Y_t}$ is the set of all observed variables in the system except $X_{t-\gamma_{xy}}$ and Y_t and $P(y_t | do(x_{t-\gamma_{xy}}), do(v_{X_{t-\gamma_{xy}}, Y_t}))$ is the distribution of Y_t while $X_{t-\gamma_{xy}}$ and $\mathcal{V}_{X_{t-\gamma_{xy}}, Y_t}$ are held constant respectively at $x_{t-\gamma_{xy}}$ and $v_{X_{t-\gamma_{xy}}, Y_t}$. In the linear case, the direct effect corresponds to the structural coefficient¹ $\alpha_{Y_t, X_{t-\gamma_{xy}}}$.

In the following, we explicitly state further assumptions we make in this paper.

Assumption 1 (Causal Sufficiency, Spirtes et al. (2000)). *No hidden confounding.*

Assumption 2 (Stationarity of direct effects). *The causal mechanisms of the system considered do not change and therefore, $\forall X \neq Y \in \mathcal{V}, \forall t - \gamma \leq t \in \mathbb{Z}, \alpha_{Y_t, X_{t-\gamma}} = \alpha_{Y_{t+1}, X_{t-\gamma+1}}$, and $\forall t - \gamma \leq t \in \mathbb{Z}, \alpha_{Y_t, Y_{t-\gamma}} = \alpha_{Y_{t+1}, Y_{t-\gamma+1}}$. There exists a maximum lag γ_{max} of a SCM as $\gamma_{max} := \max\{\gamma \in \mathbb{N} | \exists X, Y \in \mathcal{V}, \alpha_{Y_t, X_{t-\gamma}} \neq 0\}$.*

Definition 3 (Full-Time Causal Graph). *Considering a finite set of times series and a SCM, one can define the full-time causal graph (FTCG) $\mathcal{G}_f = (\mathcal{V}_f, \mathcal{E}_f)$ associated to the SCM in the following way:*

$$\begin{aligned} \mathcal{V}_f &:= \{Y_t \mid \forall Y \in \mathcal{V}, \forall t \in \mathbb{Z}\}, \\ \mathcal{E}_f &:= \{X_{t-\gamma} \rightarrow Y_t \mid \forall Y_t \in \mathcal{V}_f, \forall X_{t-\gamma} \text{ such that } \alpha_{Y_t, X_{t-\gamma}} \neq 0\}. \end{aligned}$$

¹In Sewall Wright's terminology the structural coefficient is called path coefficient (Wright, 1920, 1921).

In addition, for every vertex $Y_t \in \mathcal{V}_f$ we note:

$$\begin{aligned} \text{Parents}(Y_t, \mathcal{G}_f) &= \{U_{t'} \in \mathcal{V}_f \mid U_{t'} \rightarrow Y_t \text{ in } \mathcal{E}_f\}, \\ \text{Children}(Y_t, \mathcal{G}_f) &= \{U_{t'} \in \mathcal{V}_f \mid Y_t \rightarrow U_{t'} \text{ in } \mathcal{E}_f\}, \\ \text{Ancestors}(Y_t, \mathcal{G}_f) &= \bigcup_{n \in \mathbb{N}} P_n \text{ where } P_0 = \{Y_t\} \text{ and } P_{k+1} = \bigcup_{U_{t'} \in P_k} \text{Parents}(U_{t'}, \mathcal{G}_f), \text{ and} \\ \text{Descendants}(Y_t, \mathcal{G}_f) &= \bigcup_{n \in \mathbb{N}} C_n \text{ where } C_0 = \{Y_t\} \text{ and } C_{k+1} = \bigcup_{U_{t'} \in C_k} \text{Children}(U_{t'}, \mathcal{G}_f). \end{aligned}$$

Assumption 3 (Acyclicity of the FTCTG). *Every FTCTG is acyclic.*

The FTCTG is the most natural way to represent a SCM but it is unpractical as it is infinite. Of course, given Assumption 2, it is possible to represent a FTCTG in a finite graph, but even in this case sometimes, it is difficult to construct this type of graphs from prior knowledge due to the uncertainty regarding temporal lags. Furthermore, causal discovery methods are not always efficient (Aït-Bachir et al., 2023) due to the strong assumptions they require that are not always satisfied in real applications, so constructing this type of graphs from data is not always a valid option. Therefore, it is much more reliable to construct an abstraction of this type of graphs which does not contain temporal information. This abstraction is usually referred to as a summary causal graph (Assaad et al., 2022).

Definition 4 (Summary Causal Graph). *Consider a FTCTG $\mathcal{G}_f = (\mathcal{V}_f, \mathcal{E}_f)$. One can define the summary causal graph (SCG) $\mathcal{G}_s = (\mathcal{V}_s, \mathcal{E}_s)$ in the following way:*

$$\begin{aligned} \mathcal{V}_s &:= \mathcal{V}, \\ \mathcal{E}_s &:= \{X \rightarrow Y \mid \forall X, Y \in \mathcal{V}, \exists t' \leq t \in \mathbb{Z} \text{ such that } X_{t'} \rightarrow Y_t \in \mathcal{E}_f\}. \end{aligned}$$

In addition, for every vertex $Y \in \mathcal{V}_s$ we note:

$$\begin{aligned} \text{Parents}(Y, \mathcal{G}_s) &= \{U \in \mathcal{V}_s \mid U \rightarrow Y \text{ or } U \rightleftharpoons Y \text{ in } \mathcal{E}_s\}, \\ \text{Children}(Y, \mathcal{G}_s) &= \{U \in \mathcal{V}_s \mid Y \rightarrow U \text{ or } U \rightleftharpoons Y \text{ in } \mathcal{E}_s\}, \\ \text{Ancestors}(Y, \mathcal{G}_s) &= \bigcup_{n \in \mathbb{N}} P_n \text{ where } P_0 = \{Y\} \text{ and } P_{k+1} = \bigcup_{U \in P_k} \text{Parents}(U, \mathcal{G}_s), \text{ and} \\ \text{Descendants}(Y, \mathcal{G}_s) &= \bigcup_{n \in \mathbb{N}} C_n \text{ where } C_0 = \{Y\} \text{ and } C_{k+1} = \bigcup_{U \in C_k} \text{Children}(U, \mathcal{G}_s). \end{aligned}$$

Notice that a SCG may have cycles and in particular two arrows in opposite directions, i.e., if in the FTCTG we have $X_{t'} \rightarrow Y_t$ and $Y_{t'} \rightarrow X_t$ then in the SCG we have $X \rightleftharpoons Y$.

The abstraction of summary causal graphs entails that, even though there is exactly one SCG compatible with a given FTCTG, there are in general several FTCTGs compatible with a given SCG.

For example, consider the following linear dynamic SCM, in which the coefficients α equal to zero are omitted:

$$\begin{aligned} W_t &:= \alpha_{W_t, W_{t-1}} * W_{t-1} + \alpha_{W_t, X_t} * X_t + \xi_{W_t}, \\ X_t &:= \alpha_{X_t, X_{t-1}} * X_{t-1} + \alpha_{X_t, Z_{t-1}} * Z_{t-1} + \xi_{X_t}, \\ Y_t &:= \alpha_{Y_t, W_t} * W_t + \alpha_{Y_t, X_t} * X_t + \alpha_{Y_t, Y_{t-1}} * Y_{t-1} + \xi_{Y_t}, \text{ and} \\ Z_t &:= \alpha_{Z_t, W_{t-1}} * W_{t-1} + \alpha_{Z_t, Z_{t-1}} * Z_{t-1} + \xi_{Z_t}. \end{aligned}$$

The corresponding FTCTG and the corresponding SCG of this linear dynamic SCM are respectively given in Figures 1a and 1b and another FTCTG which is also compatible with the same SCG but does not correspond with the linear dynamic SCM is given in Figures 1c.

Now that we have defined direct effects and summary causal graphs, we can formally define graphical identifiability.

Definition 5 (Graphical identifiability of a direct effect). *The direct effect of a time instant $X_{t-\gamma}$ on another time instant Y_t , i.e., $\alpha_{Y_t, X_{t-\gamma}}$ of a linear dynamic SCM is said to be identifiable from a SCG if the quantity $\alpha_{Y_t, X_{t-\gamma}}$ can be computed uniquely from the observed distribution without any further assumption on the distribution.*

Note that computing the direct effect uniquely from the observed distribution without any further assumption on the distribution usually consists on removing all confounding bias and non-direct effects by adjusting on a suitable adjustment set that do not create any selection bias. Removing confounding bias usually necessitates adjusting on some suitable ancestors of the cause or the effect, removing non-direct effects usually consists on adjusting on some

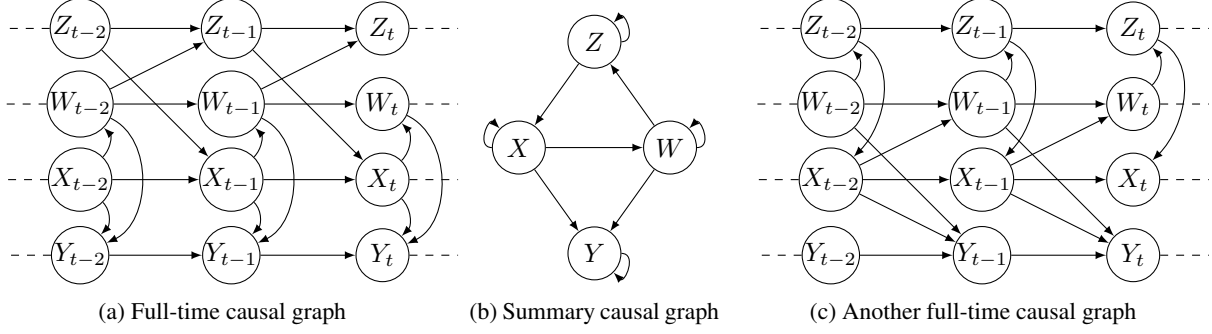

Figure 1: Two full time causal graph in (a) and (c) corresponding to the same summary causal graph in (b). Note that full time causal graphs give more information about the dynamic SCM, whereas the summary causal graph one an abstraction and can be deduced from the full time causal graph.

suitable ancestors of the effect that are not ancestors of the cause, and creating bias artificial consists on adjusting on descendants of the effect.

In the following, we recall several preliminaries related to FTCTGs and SCGs.

Definition 6 (Paths in FTCTGs). A path between two vertices X_{tx} to Y_{ty} is an ordered sequence of vertices denoted as $\pi_f = \langle V_{t_1}^1, \dots, V_{t_n}^n \rangle$ such that $V_{t_1}^1 = X_{tx}$, $V_{t_n}^n = Y_{ty}$ and $\forall 1 \leq i < n$, $V_{t_i}^i$ and $V_{t_{i+1}}^{i+1}$ are adjacent (i.e., $V_{t_i}^i \rightarrow V_{t_{i+1}}^{i+1}$ or $V_{t_i}^i \leftarrow V_{t_{i+1}}^{i+1}$) and $\forall 1 \leq i < j \leq n$, $V_{t_i}^i \neq V_{t_j}^j$. In this paper, a path π_f between X_{tx} to Y_{ty} is said to be non-direct if $\pi_f \neq \langle X_{tx} \rightarrow Y_{ty} \rangle$ and we write $t_{\min}(\pi_f = \langle V_{t_1}^1, \dots, V_{t_n}^n \rangle) = \min\{t^i | 1 \leq i \leq n\}$ and $t_{\max}(\pi_f = \langle V_{t_1}^1, \dots, V_{t_n}^n \rangle) = \max\{t^i | 1 \leq i \leq n\}$.

Definition 7 (Walks and Paths in SCGs). A walk between two vertices X to Y is an ordered sequence of vertices denoted as $\pi_s = \langle V^1, \dots, V^n \rangle$ such that $V^1 = X$, $V^n = Y$ and $\forall 1 \leq i < n$, V^i and V^{i+1} are adjacent (i.e., $V^i \rightarrow V^{i+1}$ or $V^i \leftarrow V^{i+1}$ or $V^i \rightleftharpoons V^{i+1}$). In this paper, a walk π_s between X to Y is said to be non-direct if $\pi_s \neq \langle X \rightarrow Y \rangle$. A path is a walk with no two identical vertices.

Definition 8 (Cycles in SCGs). A cycle is a directed walk from a vertex to itself with no repeated vertices except the endpoints. i.e., in a SCG, a cycle is a walk $\pi_s = \langle V^1, \dots, V^n \rangle$ such that:

- $V^1 = V^n$,
- $\forall 1 \leq i < n$, $V^i \rightarrow V^{i+1}$ or $V^i \rightleftharpoons V^{i+1}$, and
- $\forall 1 \leq i < j \leq n$, $V^i = V^j \implies i = 1$ and $j = n$.

The set of cycles with endpoints $Y \in \mathcal{V}_s$ in a SCG \mathcal{G}_s is written $Cycles(Y, \mathcal{G}_s)$.

As SCGs represent FTCTGs, the walks in a SCG can represent the paths of compatible FTCTGs. This is gives rise to the notion of compatible walk.

Definition 9 (Compatible Walk). Let $\mathcal{G}_f = (\mathcal{V}_f, \mathcal{E}_f)$ be a FTCTG and $\mathcal{G}_s = (\mathcal{V}_s, \mathcal{E}_s)$ the compatible SCG. A path $\pi_f = \langle V_{t_1}^1, \dots, V_{t_n}^n \rangle$ in \mathcal{G}_f can be uniquely represented as a walk $\pi_s = \langle V^1, \dots, V^n \rangle$ in \mathcal{G}_s in which the temporal information has been removed. We refer to π_s as π_f 's compatible walk and we write $\pi_s = \phi(\pi_f)$. e.g., $\phi(\langle X_{t-1}, X_t, Y_t, Z_t, Z_{t+1}, X_{t+1} \rangle) = \langle X, X, Y, Z, Z, X \rangle$.

An important graphical notion used in causal reasoning is the notion of blocked path (Pearl, 1998) for which the classical definition was introduced for directed acyclic graphs and thus can be directly used for FTCTGs under Assumption 3. Note that a suitable adjustment set that removes all confounding bias and non-direct effects and that do not create any selection bias between $X_{t-\gamma_{xy}}$ and Y_t consists on a set that block all non-direct paths between $X_{t-\gamma_{xy}}$ and Y_t . In the following, we firstly give the definition of blocked Path in FTCTGs and then we give a similar notion for SCGs.

Definition 10 (Blocked Path in FTCTGs). In a FTCTG $\mathcal{G}_f = (\mathcal{V}_f, \mathcal{E}_f)$, a path $\pi_f = \langle V_{t_1}^1, \dots, V_{t_n}^n \rangle$ is said to be blocked by a set of vertices $\mathcal{Z}_f \subseteq \mathcal{V}_f$ if:

1. $V_{t_1}^1 \in \mathcal{Z}_f$ or $V_{t_n}^n \in \mathcal{Z}_f$, or
2. $\exists 1 < i < n$ such that $V_{t_{i-1}}^{i-1} \leftarrow V_{t_i}^i$ or $V_{t_i}^i \rightarrow V_{t_{i+1}}^{i+1}$ and $V_{t_i}^i \in \mathcal{Z}_f$, or

3. $\exists 1 < i < n$ such that $V_{t^{i-1}}^{i-1} \rightarrow V_{t^i}^i \leftarrow V_{t^{i+1}}^{i+1}$ and $\text{Descendants}(V_{t^i}^i, \mathcal{G}_f) \cap \mathcal{Z}_f = \emptyset$.

A path which is not blocked is said to be active. When the set \mathcal{Z}_f is not specified, it is implicit that we consider $\mathcal{Z}_f = \emptyset$. In the case of condition 2, we say that π_f is manually \mathcal{Z}_f -blocked by $V_{t^i}^i$ and in the case of condition 3 we say that π_f is passively \mathcal{Z}_f -blocked by $V_{t^i}^i$.

The classical definition of blocked path is usually used in directed acyclic graph and since the SCG compatible with a FTSG can be cyclic, one needs to adapt it. Spirtes (1993) explains that under the linearity assumption the notion of blocked path is readily extended. Moreover, Forré and Mooij (2017) introduced a more recent and general (non-parametric and allow for hidden confounding) adaptation called σ -block path. Here we will focus on the definition used in Spirtes (1993) since we assume linearity but we adapt it to consider walks and such that in SCGs extremity vertices of a path do not necessarily block the path.

Definition 11 (Blocked Walk in SCGs). In a SCG $\mathcal{G}_s = (\mathcal{V}_s, \mathcal{E}_s)$, a walk $\pi_s = \langle V^1, \dots, V^n \rangle$ is said to be blocked by a set of vertices $\mathcal{Z}_s \subseteq \mathcal{V}_s$ if:

1. $\exists 1 < i < n$ such that $V^{i-1} \leftarrow V^i$ or $V^i \rightarrow V^{i+1}$ and $V^i \in \mathcal{Z}_s$, or
2. $\exists 1 < i \leq j < n$ such that $V^{i-1} \rightarrow V^i \rightleftharpoons \dots \rightleftharpoons V^j \leftarrow V^{j+1}$ and $\text{Descendants}(V^i, \mathcal{G}_s) \cap \mathcal{Z}_s = \emptyset$.

A walk which is not blocked is said to be active. When the set \mathcal{Z}_s is not specified, it is implicit that we consider $\mathcal{Z}_s = \emptyset$. In the case of condition 1, we say that π_s is manually \mathcal{Z}_s -blocked by V^i and in the case of condition 2 we say that π_s is passively \mathcal{Z}_s -blocked by $\{V^k | i \leq k \leq j\}$.

Condition 1 in Definition 11 is a direct adaptation of condition 2 in Definition 10. Condition 2 of Definition 11 is explained by the fact that for a walk $\pi_s = \langle V^1, \dots, V^n \rangle$ in a SCG $\mathcal{G}_s = (\mathcal{V}_s, \mathcal{E}_s)$ and a set of vertices $\mathcal{Z}_s \subseteq \mathcal{V}_s$, if $\exists 1 < i \leq j < n$ such that $V^{i-1} \rightarrow V^i \rightleftharpoons \dots \rightleftharpoons V^j \leftarrow V^{j+1}$ and $\text{Descendants}(V^i, \mathcal{G}_s) \cap \mathcal{Z}_s = \emptyset$ then $\forall \pi_f = \langle V_{t^1}^1, \dots, V_{t^n}^n \rangle \in \phi^{-1}(\pi_s)$, $\exists 1 < i \leq k \leq j < n$ such that $V_{t^{k-1}}^{k-1} \rightarrow V_{t^k}^k \leftarrow V_{t^{k+1}}^{k+1}$ and $\text{Descendants}(V_{t^k}^k, \mathcal{G}_s) \cap \mathcal{Z}_s = \emptyset$ so $\text{Descendants}(V_{t^k}^k, \mathcal{G}_f) \cap \mathcal{Z}_f = \emptyset$ where $\mathcal{Z}_f \subseteq \{V_{t'}^k | V \in \mathcal{Z}_s, t' \in \mathbb{Z}\}$. Notice that there is no adaptation of condition 1 as having $V^1 \in \mathcal{Z}_s$ or $V^n \in \mathcal{Z}_s$ does not mean that instants of interests $V_{t^1}^1$ or $V_{t^n}^n$ which are endpoints of compatible paths of interests are in $\mathcal{Z}_f \subseteq \{V_{t'}^k | V \in \mathcal{Z}_s, t' \in \mathbb{Z}\}$. Moreover, in this paper we are interested in the direct effect of $V_{t^1}^1 = X_{t-\gamma_{xy}}$ on $V_{t^n}^n = Y_t$ and therefore we cannot adjust on them and thus we will always have $V_{t^1}^1, V_{t^n}^n \notin \mathcal{Z}_f$. However, having $V^1 \in \mathcal{Z}_s$ or $V^n \in \mathcal{Z}_s$ can activate or block walks, e.g., $\langle X \leftarrow W \rightarrow X \leftarrow Z \rightarrow Y \rangle$ and $\langle X \leftarrow W \rightarrow X \rightarrow Z \rightarrow Y \rangle$.

3 Graphical identifiability from SCGs

In this section, we present the identifiability result. We start by stating a trivial lemma that will be needed for the general identifiability result.

Lemma 1. Let $\mathcal{G}_s = (\mathcal{V}_s, \mathcal{E}_s)$ be a SCG, $\gamma_{max} \geq 0$ a maximum lag and $\alpha_{Y_t, X_{t-\gamma_{xy}}}$ the direct effect of $X_{t-\gamma_{xy}}$ on Y_t such that $X, Y \in \mathcal{V}_s$, $X \neq Y$ and $0 \leq \gamma_{xy} \leq \gamma_{max}$. If $X \notin \text{Parents}(Y, \mathcal{G}_s)$ then $\alpha_{Y_t, X_{t-\gamma_{xy}}}$ is identifiable.

Proof. In Appendix. □

The aim of this work is to identify direct effects that can be estimated from data. This implies that we are interested in figuring out if for a given $X_{t-\gamma_{xy}}$ and a given Y_t , it is possible to find at least some *finite* adjustment set that removes all confounding bias and non-direct effects and that does not create any selection bias between $X_{t-\gamma_{xy}}$ and Y_t . Therefore, in the following lemma, we show that what we are trying to achieve is possible by pointing out that infinite sets are not necessary to block paths between $X_{t-\gamma_{xy}}$ and Y_t in a given FTSG.

Lemma 2. Let $\mathcal{G}_f = (\mathcal{V}_f, \mathcal{E}_f)$ be a FTSG of maximal lag at most $\gamma_{max} \geq 0$ and $\alpha_{Y_t, X_{t-\gamma_{xy}}}$ the direct effect of $X_{t-\gamma_{xy}}$ on Y_t such that $X_{t-\gamma_{xy}}, Y_t \in \mathcal{V}_f$, $X \neq Y$ and $0 \leq \gamma_{xy} \leq \gamma_{max}$. Let $\pi_f = \langle V_{t^1}^1, \dots, V_{t^n}^n \rangle$ a path from $X_{t-\gamma_{xy}}$ to Y_t in \mathcal{G}_f . If $t_{max}(\pi_f) > t$ then π_f is passively blocked by any $\mathcal{Z}_f \subseteq \mathcal{V}_f$ such that $\mathcal{Z}_f \cap \{V_{t'}^k \in \mathcal{V}_f | t' > t\} = \emptyset$. If $t_{min}(\pi_f) < t - \gamma_{xy}$ then π_f is manually blocked by any $\mathcal{Z}_f \subseteq \mathcal{V}_f$ such that $\{V_{t'}^k \in \mathcal{V}_f | t - \gamma_{max} \leq t' < t\} \subseteq \mathcal{Z}_f$.

Proof. In Appendix. □

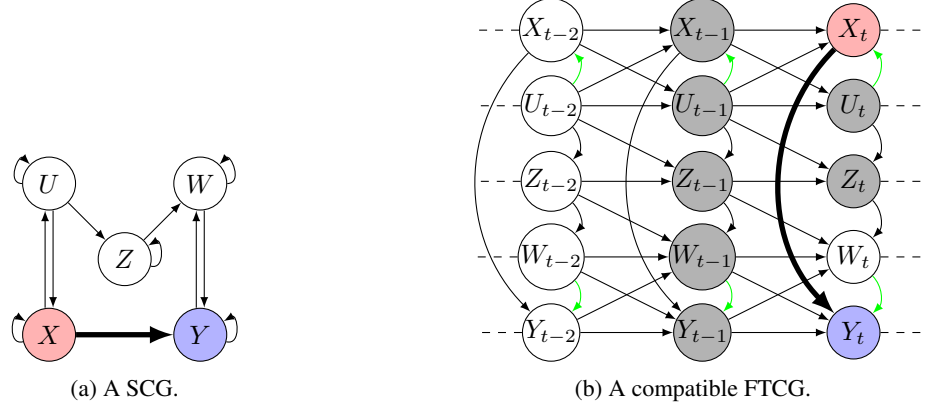

Figure 2: An example of SCG and its compatible FTCC where red and blue vertices respectively represent the cause and the effect we are interested in, the thick edge corresponds to the edge between them, and the gray vertices in the FTCC correspond to an adjustment set. In the given FTCC, one could choose to add W_t to the adjustment set to block every non-direct path from $X_{t-\gamma_{xy}}$ to Y_t . However, there exists another FTCC compatible with the SCG in (a) such that W_t is a descendant on Y_t . Therefore, if only the SCG is known, W_t should not be used in the adjustment set.

Lemma 1 and Lemma 2 respectively show that the case where $X \notin Parents(Y, \mathcal{G}_s)$ is trivial and that the cases where $t_{min}(\pi_f) < t - \gamma_{xy}$ and $t_{max}(\pi_f) > t$ are trivial. Thus we will consider $X \in Parents(Y, \mathcal{G}_s)$ and $t - \gamma_{xy} \leq t_{min}(\pi_f) \leq t_{max}(\pi_f) \leq t$ in the following Lemmas. In these cases, one might think that to block all active non-direct paths between $X_{t-\gamma_{xy}}$ and Y_t , it is simply sufficient to adjust on all vertices in the FTCC which do not temporally succeed the effect Y_t and have compatible vertices on an active path between X and Y in the SCGs. In Figure 2 we give an example where this is not true. In particular, in the FTCC in Figure 2b which is compatible with the SCG in Figure 2a, one can visually check that all gray vertices ($X_t, U_t, Z_t, U_{t-1}, Z_{t-1}, W_{t-1}, Y_{t-1}$) block all active non-direct paths between X_t and Y_t and do not create any selection bias since none of the gray vertices is a descendant of Y_t . Notice that this adjustment set is still valid if any of the black edges is omitted and if the orientation of the green edges is inverted and the new FTCC is still compatible with the SCG. One might also notice that W_t does not create any selection bias in the FTCC in Figure 2b so it can be added to the adjustment set. However, the general validity does not hold if we add W_t to the adjustment set because there exists another FTCC compatible with the same SCG in which the green edge between W and Y has been inverted such that W_t is a descendant on Y_t . Therefore, if only the SCG is known, W_t should not be used in the adjustment set. It turns out that this observation can be generalized. In the following we start, by formally defining an adjustment set for any SCGs that share the same characteristics as the adjustment set of Figure 2 and then we give a lemma that shows the usefulness of such a set.

Definition 12 (A first finite adjustment set). Consider a SCG $\mathcal{G}_s = (\mathcal{V}_s, \mathcal{E}_s)$, a maximal lag γ_{max} , two vertices X and Y with $X \in Parents(Y, \mathcal{G}_s)$ and a lag γ_{xy} . Consider the following sets:

$$\mathcal{A}_{\leq t} = \{V_{t'} | V \in \mathcal{V}_s \setminus Descendants(Y, \mathcal{G}_s), t - \gamma_{max} \leq t' \leq t\} \setminus \{X_{t-\gamma_{xy}}\},$$

$$\mathcal{D}_{< t} = \{V_{t'} | V \in Descendants(Y, \mathcal{G}_s), t - \gamma_{max} \leq t' < t\} \setminus \{X_{t-\gamma_{xy}}\}.$$

$\mathcal{Z}_f = \mathcal{A}_{\leq t} \cup \mathcal{D}_{< t}$ is called an adjustment set relative to $(X_{t-\gamma_{xy}}, Y_t)$.

Lemma 3. Let $\mathcal{G}_s = (\mathcal{V}_s, \mathcal{E}_s)$ be a SCG, $\gamma_{max} \geq 0$ a maximum lag and $\alpha_{Y_t, X_{t-\gamma_{xy}}}$ the direct effect of $X_{t-\gamma_{xy}}$ on Y_t such that $X, Y \in \mathcal{V}_s$, $X \neq Y$ and $0 \leq \gamma_{xy} \leq \gamma_{max}$. For every non-direct walk $\pi_s = \langle V^1, \dots, V^n \rangle$ between X and Y such that $\langle V^2, \dots, V^{n-1} \rangle \not\subseteq Descendants(Y, \mathcal{G}_s)$, every compatible path $\pi_f \in \phi^{-1}(\pi_s)$ from $X_{t-\gamma_{xy}}$ to Y_t can be blocked by the adjustment set $\mathcal{Z}_f = \mathcal{A}_{\leq t} \cup \mathcal{D}_{< t}$ defined in Definition 12.

Proof. In Appendix. □

One important factor that we did not take into account until now is the value of γ_{xy} . Indeed, when $\gamma_{xy} > 0$ it is safe to say that the problem should become easier as in this case we know that the parents of $X_{t-\gamma_{xy}}$ cannot be descendants of Y_t . Therefore, distinguishing the case where $\gamma_{xy} = 0$ and the case where $\gamma_{xy} > 0$ is important to reach a general identifiability result. In Figure 3 we give an example where it is possible to find a set that blocks all non-direct paths between $X_{t-\gamma_{xy}}$ and Y_t if $\gamma_{xy} > 0$. In particular, consider the FTCC in Figure 3b, using the adjustment set used in Figure 2, $(X_t, U_t, Z_t, U_{t-1}, Z_{t-1}, W_{t-1}, Y_{t-1})$ is not sufficient to block all non-direct paths between X_{t-1} and

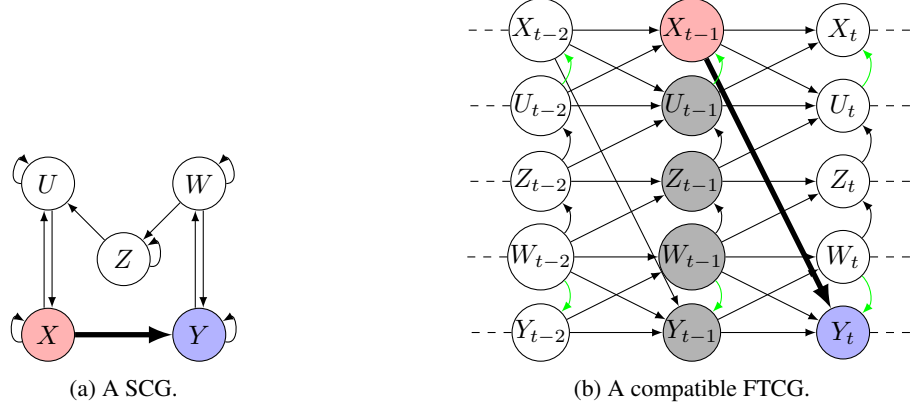

Figure 3: An example of SCG and its compatible FT CG where red and blue vertices respectively represent the cause and the effect we are interested in, the thick edge corresponds to the the edge between them, and the gray vertices in the FT CG correspond to an adjustment set. In the given FT CG, one could choose to add X_t, U_t, Z_t and W_t to the adjustment set to block every non-direct path from $X_{t-\gamma_{xy}}$ to Y_t . However, there exists another FT CG compatible with the SCG in (a) such that X_t, U_t, Z_t and W_t are a descendant on Y_t . Therefore, if only the SCG is known, X_t, U_t, Z_t and W_t should not be used in the adjustment set.

Y_t in all FT CGs that are compatible with the SCG given in Figure 3a. However, in this case, the vertices in gray ($U_{t-1}, Z_{t-1}, W_{t-1}, Y_{t-1}$) in Figure 3b are sufficient to block all non-direct paths between X_{t-1} and Y_t . Notice that in the same example if we consider $\gamma_{xy} = 0$ then the the vertices in gray will not longer be a valid adjustment set.

Lemma 4. Let $\mathcal{G}_s = (\mathcal{V}_s, \mathcal{E}_s)$ be a SCG, $\gamma_{max} \geq 0$ a maximum lag and $\alpha_{Y_t, X_{t-\gamma_{xy}}}$ the direct effect of $X_{t-\gamma_{xy}}$ on Y_t such that $X, Y \in \mathcal{V}_s$, $X \neq Y$ and $0 < \gamma_{xy} \leq \gamma_{max}$. For every non-direct walk $\pi_s = \langle V^1, \dots, V^n \rangle$ from X to Y such that $\exists 1 \leq i < n$, $V^i \leftarrow V^{i+1}$ (i.e., not $V^i \rightarrow V^{i+1}$ and not $V^i \rightleftharpoons V^{i+1}$), every compatible path $\pi_f \in \phi^{-1}(\pi_s)$ from $X_{t-\gamma_{xy}}$ to Y_t can be blocked by $\mathcal{Z}_f = \mathcal{A}_{\leq t} \cup \mathcal{D}_{< t}$ because $\mathcal{Z}_f \cap \mathcal{D}_{\geq t} = \emptyset$ where:

- $\mathcal{A}_{\leq t}, \mathcal{D}_{< t}$ are defined in Definition 12 and
- $\mathcal{D}_{\geq t}$ is the set of instants of descendants of Y greater or equal to t , i.e., $\mathcal{D}_{\geq t} = \{V_{t'} | V \in \text{Descendants}(Y, \mathcal{G}_s), t' \geq t\}$.

Note that $\pi_s = \langle V^1, \dots, V^n \rangle$ from X to Y is non-direct, $X \in \text{Parents}(Y, \mathcal{G}_s)$ by Lemma 1 and $\exists 1 \leq i < n$, $V^i \leftarrow V^{i+1}$ implies that $n \geq 3$.

Proof. In Appendix. □

Now we give the complementary of Lemma 4 in the case where $X \rightleftharpoons Y$.

Lemma 5. Let $\mathcal{G}_s = (\mathcal{V}_s, \mathcal{E}_s)$ be a SCG, $\gamma_{max} \geq 0$ a maximum lag and $\alpha_{Y_t, X_{t-\gamma_{xy}}}$ the direct effect of $X_{t-\gamma_{xy}}$ on Y_t such that $X, Y \in \mathcal{V}_s$, $X \neq Y$ and $0 < \gamma_{xy} \leq \gamma_{max}$. For every non-direct walk $\pi_s = \langle V^1, \dots, V^n \rangle$ from X to Y where $\exists 1 < i < n$, $V^i = Y$, every compatible path $\pi_f \in \phi^{-1}(\pi_s)$ from $X_{t-\gamma_{xy}}$ to Y_t can be blocked by $\mathcal{Z}_f = \mathcal{A}_{\leq t} \cup \mathcal{D}_{< t}$ (notice $\mathcal{Z}_f \cap \mathcal{D}_{\geq t} = \emptyset$) where $\mathcal{A}_{\leq t}, \mathcal{D}_{< t}$ are defined in Definition 12 and $\mathcal{D}_{\geq t}$ is defined in Lemma 4.

Proof. In Appendix. □

In the following two lemmas, we show that the conditions given in Lemma 3 and 4 are not only sufficient for blocking all non-direct active paths but they are also necessary.

Lemma 6. Let $\mathcal{G}_s = (\mathcal{V}_s, \mathcal{E}_s)$ be a SCG, $\gamma_{max} \geq 0$ a maximum lag and $\alpha_{Y_t, X_{t-\gamma_{xy}}}$ the direct effect of $X_{t-\gamma_{xy}}$ on Y_t such that $X, Y \in \mathcal{V}_s$, $X \neq Y$ and $0 \leq \gamma_{xy} \leq \gamma_{max}$. If there exists a path $\pi_s = \langle V^1, \dots, V^n \rangle$ from X to Y with $\langle V^2, \dots, V^{n-1} \rangle \subseteq \text{Descendants}(Y, \mathcal{G}_s)$ and $\exists 1 \leq i < n$, $V^i \leftarrow V^{i+1}$ and either $n \geq 3$ or $X \in \text{Descendants}(Y, \mathcal{G}_s)$ and $\exists C \in \text{Cycles}(X, \mathcal{G}_s)$ with $Y \notin C$ then $\alpha_{Y_t, X_{t-\gamma_{xy}}}$ is not identifiable.

Proof. In Appendix. □

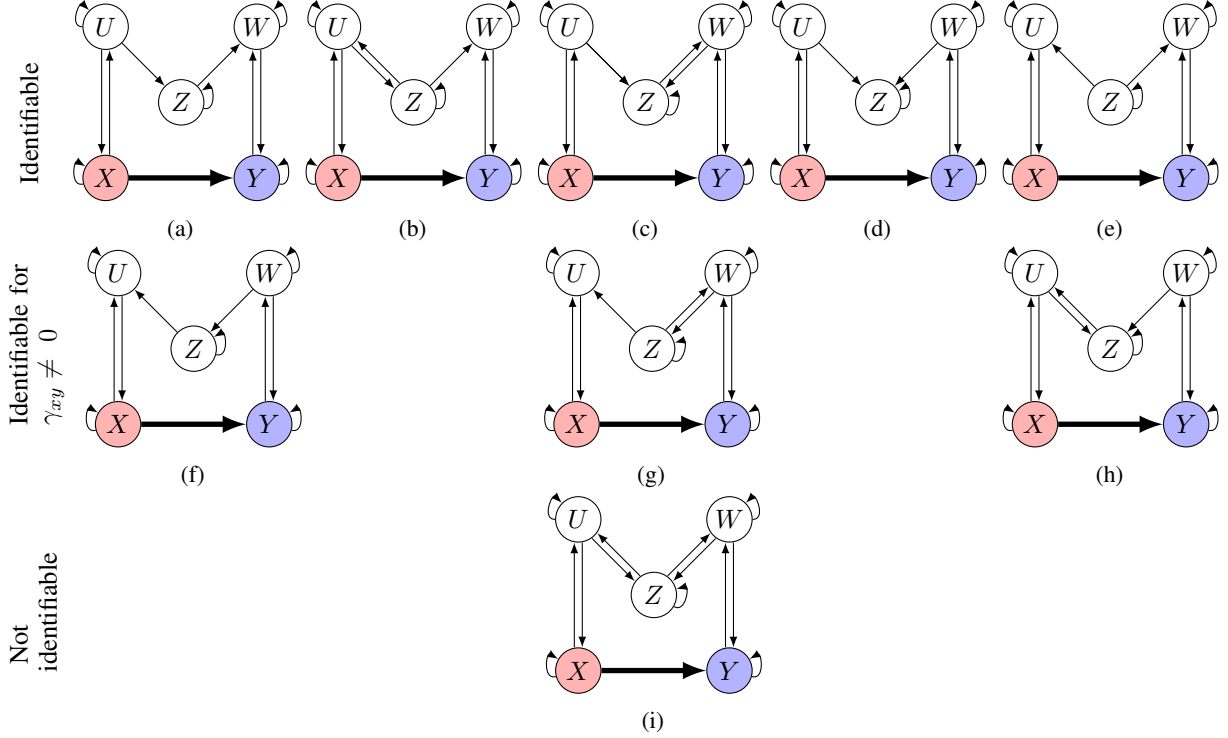

Figure 4: Examples of SCGs with 5 vertices where in (a),(b),(c),(d),(e) $\alpha_{Y_t, X_{t-\gamma_{x,y}}}$ is identifiable for all $\gamma_{x,y}$, in (f),(g),(h) $\alpha_{Y_t, X_{t-\gamma_{x,y}}}$ is identifiable only for $\gamma_{x,y} \neq 0$, and in (i) $\alpha_{Y_t, X_{t-\gamma_{x,y}}}$ is non identifiable only all $\gamma_{x,y}$. Red and blue vertices respectively represent the cause and the effect we are interested in and the thick edge corresponds to the the edge between them.

Lemma 7. Let $\mathcal{G}_s = (\mathcal{V}_s, \mathcal{E}_s)$ be a SCG, $\gamma_{max} \geq 0$ a maximum lag and $\alpha_{Y_t, X_{t-\gamma_{x,y}}}$ the direct effect of $X_{t-\gamma_{x,y}}$ on Y_t such that $X, Y \in \mathcal{V}_s$, $X \neq Y$ and $\gamma_{xy} = 0$. If there exists an active non-direct path $\pi_s = \langle V^1, \dots, V^n \rangle$ from X to Y in \mathcal{G}_s with $\langle V^2, \dots, V^{n-1} \rangle \subseteq \text{Descendants}(Y, \mathcal{G}_s)$ then $\alpha_{Y_t, X_{t-\gamma_{x,y}}}$ is not identifiable.

Proof. In Appendix. □

Since Lemmas 3,4 and 5 consider walks in SCGs while Lemma 6 and 7 consider paths in SCGs, in the following we provide a list of properties to reconcile these two notions. Let $\mathcal{G}_s = (\mathcal{V}_s, \mathcal{E}_s)$ be a SCG and $\pi_s = \langle V^1, \dots, V^n \rangle$ a walk from X to Y . $\pi'_s = \langle U^1, \dots, U^m \rangle$ such that $U^1 = V^1$ and $U^{k+1} = V^{max\{i | V^i = U^k\} + 1}$ is called the subpath of π_s . It verifies the following properties.

Property 1 If π'_s is passively blocked by U^i then π_s is passively blocked by at least a descendant of U^i .

Property 2 If $m = 2$ then either $n = 2$ or $\langle V^1, \dots, V^{n-1} \rangle \in \text{Cycles}(X, \mathcal{G}_s)$.

Property 3 If $\langle U^2, \dots, U^{m-1} \rangle \not\subseteq \text{Descendants}(Y, \mathcal{G}_s)$ then $\langle V^2, \dots, V^{n-1} \rangle \not\subseteq \text{Descendants}(Y, \mathcal{G}_s)$.

Property 4 If $m \geq 3$ and $\exists 1 \leq i < m$, $U^i \leftarrow U^{i+1}$ then $n \geq 3$ and $\exists 1 \leq i < n$, $V^i \leftarrow V^{i+1}$.

Lemma 1 deals with the trivial case of identifiability, Lemma 2 shows that every path outside of the time slices of $X_{t-\gamma_{xy}}$ and Y_t are easily blocked, Property 1 shows that passively blocked paths are not problematic for identification, Lemma 3 together with Property 3 states that we will always be able to block paths in which some vertices are not descendants of Y , Lemmas 4 and 5 together with Property 2 and Property 4 show that in the case of positive lag (i.e., $\gamma_{xy} > 0$) we can use this temporal information to block other specific paths, and lastly, Lemmas 6 and 7 prove that these identifiability criteria are necessary. Together, these lemmas give a set of necessary and sufficient conditions for the direct effect to be identifiable. This is summarized in the following theorem.

Theorem 1. Let $\mathcal{G}_s = (\mathcal{V}_s, \mathcal{E}_s)$ be a SCG, $\gamma_{max} \geq 0$ a maximum lag and $\alpha_{Y_t, X_{t-\gamma_{xy}}}$ the direct effect of $X_{t-\gamma_{xy}}$ on Y_t such that $X, Y \in \mathcal{V}_s$ and $X \neq Y$. $X \in Parents(Y, \mathcal{G}_s)$ and there exists an active path $\pi_s = \langle V^1, \dots, V^n \rangle$ from X to Y in \mathcal{G}_s such that $\langle V^2, \dots, V^{n-1} \rangle \subseteq Descendants(Y, \mathcal{G}_s)$, and

- $\gamma_{xy} = 0$ and π_s is non-direct or
- $\gamma_{xy} > 0$, and
 - $n \geq 3$ and $\nexists 1 \leq i < n$, $V^i \leftarrow V^{i+1}$ (i.e., $\forall 1 \leq i < n$, $V^i \rightarrow V^{i+1}$ or $V^i \rightleftharpoons V^{i+1}$), or
 - $n = 2$ and $X \in Descendants(Y, \mathcal{G}_s)$ and $\exists C \in Cycles(X, \mathcal{G}_s)$ with $Y \notin C$.

if and only if $\alpha_{Y_t, X_{t-\gamma_{xy}}}$ is not identifiable.

Proof. The previous lemmas contain most of the proof, we will show here how to combine them to obtain Theorem 1. Lemma 1 give the first trivial condition $\alpha_{Y_t, X_{t-\gamma_{xy}}}$ not identifiable $\implies X \in Parents(Y, \mathcal{G}_s)$ so we assume in the remaining of the proof $X \in Parents(Y, \mathcal{G}_s)$. Lemma 7 gives the forward implication when $\gamma_{xy} = 0$ and Lemma 6 gives the forward implication when $\gamma_{xy} > 0$. All what is left is to prove to backward implication.

To prove the backward implication it suffices to prove that if we suppose that \mathcal{G}_s does not contain any path as described in Theorem 1, then there exists an adjustment set that:

1. does not contain any descendant of Y_t in any FTCTG that is compatible with \mathcal{G}_s , and
2. blocks every non-direct path from $X_{t-\gamma_{xy}}$ to Y_t in every FTCTG that is compatible with \mathcal{G}_s .

Consider \mathcal{Z}_f as defined in Definition 12. Condition 1 is satisfied since by construction \mathcal{Z}_f does not contain any descendant of Y_t . To prove condition 2, let us consider π_f to be a path from $X_{t-\gamma_{xy}}$ to Y_t in a FTCTG \mathcal{G}_f compatible with \mathcal{G}_s . Let $\phi(\pi_f) = \pi_s = \langle V^1, \dots, V^n \rangle$ its compatible walk in \mathcal{G}_s and $\pi'_s = \langle U^1, \dots, U^m \rangle$ the subpath of π_s . In the following, we consider all cases where π'_s violates one of the conditions of Theorem 1:

- if $\langle U^2, \dots, U^{m-1} \rangle \not\subseteq Descendants(Y, \mathcal{G}_s)$ then $\langle V^2, \dots, V^{n-1} \rangle \not\subseteq Descendants(Y, \mathcal{G}_s)$ by Property 3. Thus Lemma 3 shows that \mathcal{Z}_f blocks π_f , or
- if $\gamma_{xy} = 0$ and π'_s is direct then either π_s is direct and π_f is direct, or $\langle V^1, \dots, V^{n-1} \rangle \in Cycles(X, \mathcal{G}_s)$ by Property 2. Then $V^1 = V^{n-1} = X$ so since π_f is a path, $t^{n-1} \neq t$. Thus $t_{min}(\pi_f) < t$ or $t_{max}(\pi_f) > t$ and Lemma 2 shows that \mathcal{Z}_f blocks π_f , or
- if $\langle U^2, \dots, U^{m-1} \rangle \subseteq Descendants(Y, \mathcal{G}_s)$, π'_s is passively blocked by U^i and $\gamma_{xy} = 0$ (the case $\gamma_{xy} > 0$ is treated with the case $m \geq 3$ and $\exists 1 \leq i < m$, $U^i \leftarrow U^{i+1}$) then π_s is passively blocked by at least a descendant of U^i by Property 1. Then consider $t_{min}(\pi_f)$ and $t_{max}(\pi_f)$. If $t_{min}(\pi_f) < t$ or $t_{max}(\pi_f) > t$ then Lemma 2 shows that \mathcal{Z}_f blocks π_f . Else $t_{min}(\pi_f) = t_{max}(\pi_f) = t$, since π_s is passively blocked by at least a descendant of U^i and $Descendants(U^i, \mathcal{G}) \subseteq Descendants(Y, \mathcal{G})$, there exists $V_t^j \in \mathcal{D}_{\geq t}$ such that π_f is passively blocked by V_t^j . Therefore, \mathcal{Z}_f blocks π_f , or
- if $\gamma_{xy} > 0$, $m \geq 3$ and $\exists 1 \leq i < m$, $U^i \leftarrow U^{i+1}$ then $n \geq 3$ and $\exists 1 \leq i < n$, $V^i \leftarrow V^{i+1}$ by Property 4. Thus Lemma 4 shows that \mathcal{Z}_f blocks π_f , or
- if $\gamma_{xy} > 0$, $m = 2$ and $X \notin Descendants(Y, \mathcal{G}_s)$ or $\forall C \in Cycles(X, \mathcal{G}_s)$, $Y \in C$, either π_s is direct and π_f is direct, or $\pi_s = \langle X \rightleftharpoons Y \rangle$ and $\pi_f = \langle X_{t-\gamma_{xy}} \rightarrow Y_t \rangle$ as $\gamma_{xy} > 0$ and π_f is direct or $\langle V^1, \dots, V^{n-1} \rangle \in Cycles(X, \mathcal{G}_s)$ by Property 2. If $X \notin Descendants(Y, \mathcal{G}_s)$ then $V^{n-1} = X \notin Descendants(Y, \mathcal{G}_s)$ and by Lemma 1 \mathcal{Z}_f blocks π_f . Else, $\forall C \in Cycles(X, \mathcal{G}_s)$, $Y \in C$ so $Y \in \langle V^2, \dots, V^{n-1} \rangle$ and Lemma 5 shows that \mathcal{Z}_f blocks π_f .

Thus, any violation of any condition Theorem 1 leads to π_f becoming \mathcal{Z}_f -blocked. In conclusion, if the conditions of Theorem 1 are verified then \mathcal{Z}_f defined in Definition 12 allows to identify $\alpha_{Y_t, X_{t-\gamma_{xy}}}$. \square

We give some examples of SCGs with 5 vertices in Figure 4 that are categorized by whether the direct effect $\alpha_{Y_t, X_{t-\gamma_{xy}}}$ is always identifiable, identifiable if and only if $\gamma_{xy} > 0$ or never identifiable. Note that in Figure 4, for any SCG changing the edge type of the edges $U \rightleftharpoons X$ or $W \rightleftharpoons Y$ would either keep the same identifiability result

or make the causal effect identifiable or identifiable if and only if $\gamma_{xy} > 0$. Which means that at least for SCGs with the same skeleton as the skeletons of Figures 4 and such that $X \rightarrow Y$ (with a strict right arrow) the number of cases of non identifiability is fewer than the number of cases of identifiability.

4 Two adjustment sets

In this section we provide two finite adjustment sets that can be used to estimate the direct effect from data whenever it is identifiable.

Theorem 1 gives a graphical criterion to determine whether the direct effect is identifiable from a SCG \mathcal{G}_s . For a FTCTG \mathcal{G}_f and two vertices $X_{t-\gamma_{xy}}$ and Y_t it is necessary and sufficient to know a finite set of vertices \mathcal{Z}_f such that $\mathcal{Z}_f \cap (\text{Descendants}(Y_t, \mathcal{G}_f) \cup \{X_{t-\gamma_{xy}}, Y_t\}) = \emptyset$ which blocks every non-direct path from $X_{t-\gamma_{xy}}$ to Y_t in order to identify the direct effect of $X_{t-\gamma_{xy}}$ on Y_t . Thus, for a SCG \mathcal{G}_s , a maximal lag γ_{max} , two vertices X and Y and a lag γ_{xy} one needs to find a set of vertices \mathcal{Z}_f such that $\mathcal{Z}_f \cap (\text{Descendants}(Y_t, \mathcal{G}_f) \cup \{X_{t-\gamma_{xy}}, Y_t\}) = \emptyset$ which blocks every non-direct path from $X_{t-\gamma_{xy}}$ to Y_t in every FTCTG \mathcal{G}_f compatible with \mathcal{G}_s of maximal lag at most γ_{max} .

The following proposition formally indicates the soundness of the finite adjustment set defined in Definition 12.

Corollary 1. *Consider a SCG $\mathcal{G}_s = (\mathcal{V}_s, \mathcal{E}_s)$, a maximal lag γ_{max} , two vertices X and Y with $X \in \text{Parents}(Y, \mathcal{G}_s)$ and a lag γ_{xy} . Suppose the direct effect of $X_{t-\gamma_{xy}}$ on Y_t is identifiable following Theorem 1. Then $\mathcal{Z}_f = \mathcal{A}_{\leq t} \cup \mathcal{D}_{< t}$ as defined in Definition 12 verifies:*

- $\mathcal{Z}_f \cap (\text{Descendants}(Y_t, \mathcal{G}_f) \cup \{X_{t-\gamma_{xy}}\}) = \emptyset$, and
- \mathcal{Z}_f blocks every non-direct path from $X_{t-\gamma_{xy}}$ to Y_t in every compatible FTCTG \mathcal{G}_f of maximal lag at most γ_{max} .

Which means that \mathcal{Z}_f allows to estimate the direct effect $\alpha_{Y_t, X_{t-\gamma_{xy}}}$.

Proof. The proof of the backward implication of Theorem 1 proves this corollary. □

However, there may exist multiple such sets and in practice each one does not induce the same estimation error. Therefore, it is interesting to search for other such set in order to use the best one to optimize the identification of the direct effect. In the following, we give another (smaller) adjustment set that is sufficient for estimating the direct effect when it is identifiable.

Definition 13 (A second finite adjustment set). *Consider a SCG $\mathcal{G}_s = (\mathcal{V}_s, \mathcal{E}_s)$, a maximal lag γ_{max} , two vertices X and Y with $X \in \text{Parents}(Y, \mathcal{G}_s)$ and a lag γ_{xy} . Consider the following sets:*

$$\begin{aligned} \mathcal{D}_{t'}^{Anc(Y)} &= \{V_{t'} | V \in \text{Ancestors}(Y, \mathcal{G}_s) \cap \text{Descendants}(Y, \mathcal{G}_s), t' \in [t - \gamma_{max}, t] \setminus \{X_{t-\gamma_{xy}}\} \text{ and} \\ \mathcal{A}_{t'}^{Anc(Y)} &= \{V_{t'} | V \in \text{Ancestors}(Y, \mathcal{G}_s) \setminus \text{Descendants}(Y, \mathcal{G}_s), t' \in [t - \gamma_{max}, t] \setminus \{X_{t-\gamma_{xy}}\}. \end{aligned}$$

$\mathcal{Z}_f = \mathcal{D}_{t'}^{Anc(Y)} \cup \mathcal{A}_{t'}^{Anc(Y)}$ is called an adjustment set relative to $(X_{t-\gamma_{xy}}, Y_t)$.

The following proposition formally indicates the soundness of the finite adjustment set defined in Definition 13.

Proposition 1. *Consider a SCG $\mathcal{G}_s = (\mathcal{V}_s, \mathcal{E}_s)$, a maximal lag γ_{max} , two vertices X and Y with $X \in \text{Parents}(Y, \mathcal{G}_s)$ and a lag γ_{xy} . Suppose the direct effect of $X_{t-\gamma_{xy}}$ on Y_t is identifiable following Theorem 1. The adjustment set \mathcal{Z}_f relative to $(X_{t-\gamma_{xy}}, Y_t)$ defined in Definition 13 verifies:*

- $\mathcal{Z}_f \cap (\text{Descendants}(Y_t, \mathcal{G}_f) \cup \{X_{t-\gamma_{xy}}\}) = \emptyset$, and
- \mathcal{Z}_f blocks every non-direct path from $X_{t-\gamma_{xy}}$ to Y_t in every compatible FTCTG \mathcal{G}_f of maximal lag at most γ_{max} .

which allows to estimate the direct effect $\alpha_{Y_t, X_{t-\gamma_{xy}}}$.

Proof. In Appendix. □

5 Discussion Towards a Complete Single-Door Criterion

In the previous section, we have introduced two sound finite adjustment sets that can be used to estimate the direct effect from data whenever it is identifiable from a given SCG. However, the ultimate goal would be to obtain complete criterion —similarly to the single-door criterion for directed acyclic graphs in the case non-dynamic SCMs— which characterizes every finite set $\mathcal{Z}_f \subseteq \mathcal{V}_f$ which allow for the estimation of the direct effect of $X_{t-\gamma_{xy}}$ on Y_t whenever it is identifiable. Such a criterion would be useful as having all possible adjustment sets, we can opt to select the one that induces the smallest estimation error, or the one that is optimal, *i.e.*, the one which achieves the smallest asymptotic estimation variance. Having all possible adjustment sets would also be useful to exclude the ones that contain variables with missing values or measurement errors. Therefore, in this section we first give for two different SCGs an example of adjustment sets different that the ones given by Definition 12 and 13 that can be used to estimate the direct effect and then we give some insights that can be useful for developing a complete criterion that can find all possible adjustment sets.

While having all possible adjustment sets would be the ideal result, since the SCGs offer very little information on lags, in this work, we decided to firstly search for sets of the form $\mathcal{Z}_f = (\{V_{t'} | V \in \mathcal{A}, t' \in \tau_{\mathcal{A}}\} \cup \{V_{t'} | V \in \mathcal{D}, t' \in \tau_{\mathcal{D}}\}) \setminus \{X_{t-\gamma_{xy}}\}$ with:

- $\mathcal{A} \subseteq \mathcal{V}_s \setminus \text{Descendants}(Y, \mathcal{G}_s)$, $\tau_{\mathcal{A}} = [t_{inf}, t]$ and
- $\mathcal{D} \subseteq \text{Descendants}(Y, \mathcal{G}_s)$, $\tau_{\mathcal{D}} = [t_{inf}, t]$.

Indeed, one can notice that no $V_{t'}$ with $t' > t$ is necessary to block a path from $X_{t-\gamma_{xy}}$ to Y_t as Lemma 2 shows that every path π_f in a compatible FTSG with $t_{max}(\pi_f) > t$ has a collider $\rightarrow V_{t_{max}(\pi_f)} \leftarrow \in \pi_f$ which will not be activated if $\mathcal{Z}_f \cap \{V_{t'} | V \in \mathcal{V}_s, t' > t\} = \emptyset$. However, the set of this form are far from being the only adjustment sets. To illustrate this, in Figures 5 and 6, we give examples where it is possible to find an adjustment set that is simpler than the ones given in Definitions 12 and 13:

- Figure 5 shows that on an active path between X and Y in the SCG, if there exists a vertex that seems to block the path when looking only at the SCG, then it is possible to block this path by adjusting on some finite instants of this vertex in addition to some finite instants of vertices that are between the selected vertex and X , and
- Figure 6 shows that sometimes in some special cases, it is possible to block a path by adjusting on some finite instants of a single vertex without even taking into account vertices that are between the selected vertex and X .

Even though these examples only focus on the vertices between the selected vertex and X , we think that the same claims can be made for the vertices between the selected vertex and Y .

In the remaining figures, we give examples that highlights some characteristics that a complete criterion that can find all possible adjustment sets should have:

- Figure 7 shows that if $X \rightarrow X$ in the SCG then it is mandatory to adjust on relevant time instant of X ,
- Figure 8 shows that if $Y \rightarrow Y$ in the SCG and $\gamma_{xy} > 0$ then it is mandatory to adjust on relevant time instant of Y ,
- Figure 9 shows that parents of X in the SCG can induce an active path between $X_{t-\gamma_{xy}}$ and Y_t in a FTSG even if they are not on an active path between X and Y in the compatible SCG,
- Figure 10 is a complementary to Figure 9 which shows that parents of X and parents of Y in the SCG can induce an active path between $X_{t-\gamma_{xy}}$ and Y_t in a compatible FTSG even if they are not on an active path between X and Y in the SCG, and
- Figure 11 shows that in the case of $\gamma_{xy} > 0$ and a path made of descendants of Y with a strict left arrow (pointing toward X), one should surely block this path by adjusting on a vertex with an outgoing strict left arrow. However, this example does not give any intuition on which such vertex one should choose if there exist multiple ones.

Lastly, blocking every path at once while taking into account all the characteristics mentioned above can be a complex task as respecting one of the characteristics for one path can violate another characteristic for another path. Therefore, maybe it would be easier to consider an iterative procedure. For example, start by blocking all non activate paths then proceed to blocking all paths that were activated during the previous step, and so on until all non-direct paths are blocked.

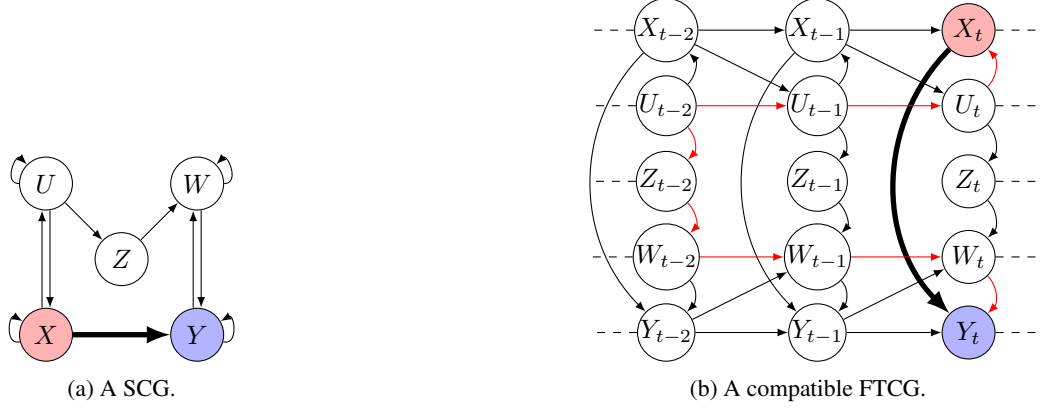

Figure 5: Example of a SCG in (a) where the direct effect of $X_{t-\gamma_{xy}}$ to Y_t is identifiable by Theorem 1 and one of its compatible FTCTGs in (b). Red and blue vertices respectively represent the cause and the effect we are interested in and the thick edge corresponds to the the edge between them. Here, when looking at the SCG, one could choose to adjust on relevant time instants of Z to block every non-direct path from $X_{t-\gamma_{xy}}$ to Y_t . However, in the compatible FTCTG, the path in red can go infinitely back in time which means that adjusting on a finite set of instances of Z is not sufficient. Therefore, in addition to Z , either X and U or W and Y should belong to the adjustment set.

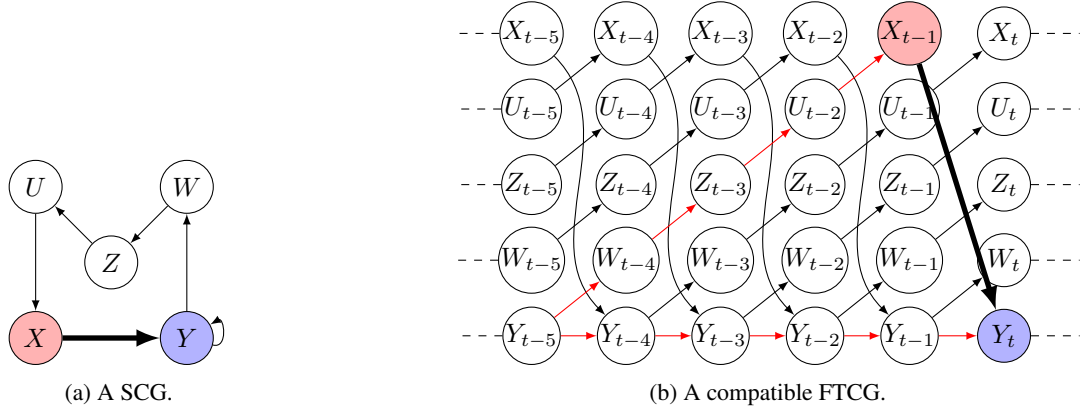

Figure 6: Example of a SCG in (a) where the direct effect of $X_{t-\gamma_{xy}}$ to Y_t for $\gamma_{xy} > 0$ is identifiable by Theorem 1 and one of its compatible FCTGs in (b). Red and blue vertices respectively represent the cause and the effect we are interested in and the thick edge corresponds to the the edge between them. Here, when looking at the SCG, one could choose to adjust on relevant time instants of W to block every non-direct path from $X_{t-\gamma_{xy}}$ to Y_t . This does not cause the same problem as in Figure 5 since in the compatible FCTG, the path in red can be blocked by relevant time instants of W , namely, $W_{t-(|\mathcal{V}_s|-1)*\gamma_{max}}, \dots, W_t$. This gives the intuition that on an active path in a SCG, if there exist at least one vertex W on the path that can block it such that all vertices on the subpath between X and W do not belong to any cycle, then all compatible paths can be blocked by finite instances of that vertex.

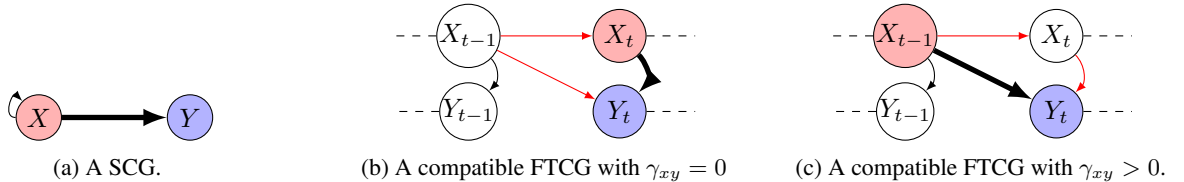

Figure 7: Example of a SCG in (a) where the direct effect of $X_{t-\gamma_{xy}}$ to Y_t for $\gamma_{xy} \geq 0$ is identifiable by Theorem 1 and two of its compatible FCTGs in (b) and (c). Red and blue vertices respectively represent the cause and the effect we are interested in and the thick edge corresponds to the the edge between them. In the FTCTG in (a) the active non-direct path (in red) can be blocked by X_{t-1} and in the FTCTG in (b) the active non-direct path (in red) can be blocked by X_t . This gives the intuition that in this simple case adjusting on instances of X is sufficient.

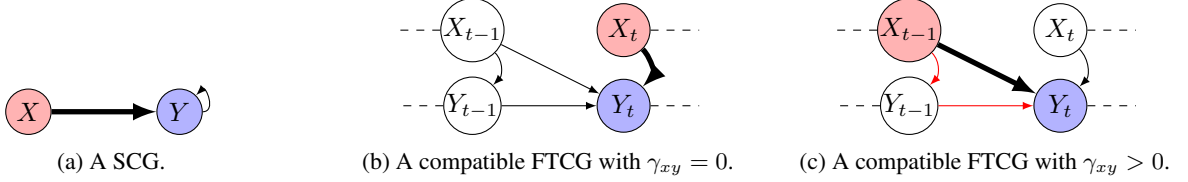

Figure 8: Example of a SCG in (a) where the direct effect of $X_{t-\gamma_{xy}}$ to Y_t for $\gamma_{xy} \geq 0$ is identifiable by Theorem 1 and one of its compatible FTCTGs in (b). Red and blue vertices respectively represent the cause and the effect we are interested in and the thick edge corresponds to the the edge between them. In the FTCTG in (a) there is no active non-direct path so no need to adjust on any vertex. However, adjusting on Y_{t-1} does not activate any path and so does not harm identification. In the FTCTG in (b) the active non-direct path (in red) can be blocked by Y_{t-1} . This gives the intuition that in this simple case adjusting on instances of Y is sufficient.

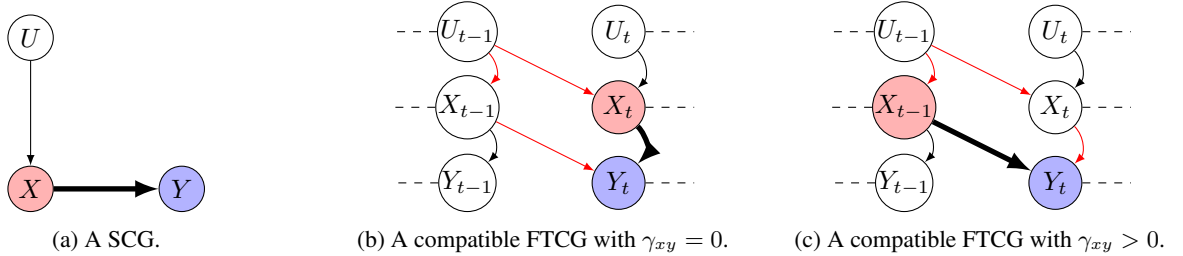

Figure 9: Example of a SCG in (a) where the direct effect of $X_{t-\gamma_{xy}}$ to Y_t for $\gamma_{xy} \geq 0$ is identifiable by Theorem 1 and two of its compatible FTCTGs in (b) and (c). Red and blue vertices respectively represent the cause and the effect we are interested in and the thick edge corresponds to the the edge between them. Here, when looking at the SCG, one might think at there is no need to adjust on any vertex since there is not activated non-direct paths. However, in the compatible FTCTGs, it is obvious that this is not true. More specifically, in the FTCTG in (b) the active non direct path (in red) can be blocked by either X_{t-1} or U_{t-1} and in the in the FTCTG in (c) the active non direct path (in red) can be blocked by either X_t or U_{t-1} . This gives the intuition that parents of X in the SCG can induce an active path between $X_{t-\gamma_{xy}}$ and Y_t in a FTCTG even if they are not on an active path between X and Y in the compatible SCG.

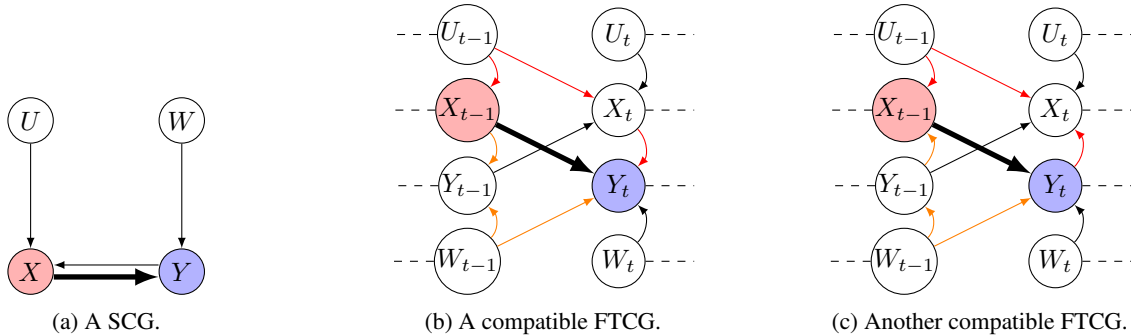

Figure 10: Example of a SCG in (a) where the direct effect of $X_{t-\gamma_{xy}}$ to Y_t for $\gamma_{xy} > 0$ is identifiable by Theorem 1 and two of its compatible FTCTGs in (b) and (c). Red and blue vertices respectively represent the cause and the effect we are interested in and the thick edge corresponds to the the edge between them. Here, when looking at the SCG, one might think that adjusting on U and V is not necessary since U and V are not on an active path between X and Y . However, in the two compatible FTCTGs, it is obvious that this is not true. More specifically, in the FCTG in (b) the active non direct path (in red) can be blocked either by U_{t-1} or X_t and the the active non direct path (in orange) can be blocked either by V_{t-1} or (Y_{t-1}, V_{t-1}) . Similarly, in the FCTG in (c) the active non direct path (in red) can be blocked either by U_{t-1} or (X_t, U_{t-1}) and the the active non direct path (in orange) can be blocked either by V_{t-1} or (Y_{t-1}) . This gives the intuition that parents of X and parents of Y in the SCG can induce an active path between $X_{t-\gamma_{xy}}$ and Y_t in a compatible FTCTG even if they are not on an active path between X and Y in the SCG.

Furthermore in this case, it seems that instances of all parents should be adjusted on in order to block all active non-direct paths between $X_{t-\gamma_{xy}}$ to Y_t for any FTCTG compatible with the SCG.

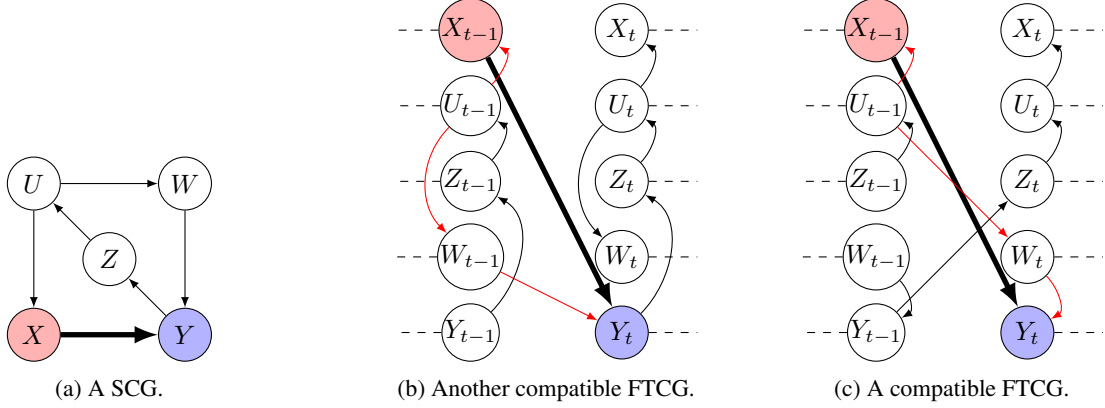

Figure 11: Example of a SCG in (a) where the direct effect of $X_{t-\gamma_{xy}}$ to Y_t for $\gamma_{xy} > 0$ is identifiable by Theorem 1 and two of its compatible FT CGs in (b) and (c). Red and blue vertices respectively represent the cause and the effect we are interested in and the thick edge corresponds to the edge between them. Here, when looking at the SCG, one might think that to block all active non-direct paths between X and Y one should either adjust on U or on (W, Z) . In addition since all vertices are descendants of Y then it is obvious that one should not adjust on vertices at time t in order to prevent any selection bias. This claim is true for the compatible FT CG in (b) as in order to block the active non-direct path (in red) it is necessary to adjust either on U_{t-1} or on W_{t-1} and adjusting on Z_{t-1} does not activate any new path. However, for the same SCG, there exists another compatible FT CG given in (c) where it is obvious that to block the active non-direct path (in red) it is necessary to adjust either U_{t-1} or W_t . But as said before adjusting on W_t is risky as the true FT CG might correspond to the one given in (b) where W_t is a descendant of Y_t . This gives the intuition that, in this case, one should adjust on relevant time instants (strictly smaller than t) of the vertex with an outgoing strict left arrow (pointing toward X), here this is U_{t-1} .

6 Conclusion

In this paper, we developed new graphical criteria for the identifiability of direct effects in linear dynamic structural causal models from summary causal graphs. Theorem 1 has important ramifications to the theory and practice of observational studies in dynamic systems. It implies that the key to graphical identifiability of the direct effect of $X_{t-\gamma_{xy}}$ on Y_t from summary causal graphs lies not only in finding a set of non-descendants of Y in the summary causal graph that are able of blocking paths between X and Y but also in some descendants of Y in the case $\gamma_{xy} > 0$. Furthermore, in case of identifiability, we presented two adjustments sets that can be used to estimate the direct effects and we gave in Section 5 some insight on what to consider to find more adjustment sets.

The finding of this paper should be useful for many applications such as root cause identification in dynamic systems and it should open new research questions. Namely, for future works, it would be interesting to have a single-door criterion along with a completeness result describing every possible adjustment set. In addition, in this work, we considered only linear dynamic SCMs, however in many real world applications causal relations can be nonlinear so it would be interesting to extend this work to nonlinear SCMs and consider non parametric direct effect (Robins and Greenland, 1992; Pearl, 2001). Finally, as many other works, we assumed that the FT CG is acyclic but we think that this assumption can be relaxed, so it would be interesting to formally check the validity of our results for cyclic FT CGs.

Bibliography

- Charles K. Assaad, Emilie Devijver, and Eric Gaussier. Survey and evaluation of causal discovery methods for time series. *J. Artif. Int. Res.*, 73, apr 2022. doi: 10.1613/jair.1.13428.
- Charles K. Assaad, Imad Ez-Zejjari, and Lei Zan. Root cause identification for collective anomalies in time series given an acyclic summary causal graph with loops. In Francisco Ruiz, Jennifer Dy, and Jan-Willem van de Meent, editors, *Proceedings of The 26th International Conference on Artificial Intelligence and Statistics*, volume 206 of *Proceedings of Machine Learning Research*, pages 8395–8404. PMLR, 25–27 Apr 2023.
- Ali Aït-Bachir, Charles K. Assaad, Christophe de Bignicourt, Emilie Devijver, Simon Ferreira, Eric Gaussier, Hosein Mohanna, and Lei Zan. Case studies of causal discovery from it monitoring time series. submitted, 2023.
- Joseph H. Connell. The influence of interspecific competition and other factors on the distribution of the barnacle *chthamalus stellatus*. *Ecology*, 42(4):710–723, 1961. doi: <https://doi.org/10.2307/1933500>.

- O.D. Duncan. *Introduction to Structural Equation Models*. Studies in population. Academic Press, 1975. ISBN 9780122241505.
- Patrick Forré and Joris Mooij. Markov properties for graphical models with cycles and latent variables. 10 2017.
- Arthur S. Goldberger. Structural equation methods in the social sciences. *Econometrica*, 40(6):979–1001, 1972. ISSN 00129682, 14680262.
- Trygve Haavelmo. The statistical implications of a system of simultaneous equations. *Econometrica*, 11(1):1–12, 1943. ISSN 00129682, 14680262.
- Judea Pearl. Graphs, causality, and structural equation models. *Sociological Methods & Research*, 27(2):226–284, 1998. doi: 10.1177/0049124198027002004.
- Judea Pearl. *Causality: Models, Reasoning, and Inference*. Cambridge University Press, New York, NY, USA, 2000. ISBN 0-521-77362-8.
- Judea Pearl. Direct and indirect effects. In *Proceedings of the Seventeenth Conference on Uncertainty in Artificial Intelligence*, UAI’01, page 411–420, San Francisco, CA, USA, 2001. Morgan Kaufmann Publishers Inc. ISBN 1558608001.
- Judea Pearl. The causal mediation formula—a guide to the assessment of pathways and mechanisms. *Prevention Science*, 13:426–436, 2012.
- James M. Robins and Sander Greenland. Identifiability and exchangeability for direct and indirect effects. *Epidemiology*, 3(2):143–155, 1992. ISSN 10443983.
- Peter Spirtes. Directed cyclic graphs, conditional independence, and non-recursive linear structural equation models. 1 1993. doi: 10.1184/R1/6491399.v1.
- Peter Spirtes, Thomas Richardson, Christopher Meek, Richard Scheines, and Clark Glymour. Using path diagrams as a structural equation modeling tool. *Sociological Methods & Research*, 27(2):182–225, 1998. doi: 10.1177/0049124198027002003.
- Peter Spirtes, Clark Glymour, and Richard Scheines. *Causation, Prediction, and Search*. MIT press, 2nd edition, 2000.
- Sewall Wright. The relative importance of heredity and environment in determining the piebald pattern of guinea-pigs. *Proceedings of the National Academy of Sciences of the United States of America*, 6(6):320–332, 1920. ISSN 00278424.
- Sewall Wright. Correlation and causation. *Journal of agricultural research*, 20(7):557–585, 1921.
- Wen Zhou, Geoffrey Liu, Rayjean J. Hung, Philip C. Haycock, Melinda C. Aldrich, Angeline S. Andrew, Susanne M. Arnold, Heike Bickeböller, Stig E. Bojesen, Paul Brennan, Hans Brunström, Olle Melander, Neil E. Caporaso, Maria Teresa Landi, Chu Chen, Gary E. Goodman, David C. Christiani, Angela Cox, John K. Field, Mikael Johansson, Lambertus A. Kiemeny, Stephen Lam, Philip Lazarus, Loïc Le Marchand, Gad Rennert, Angela Risch, Matthew B. Schabath, Sanjay S. Shete, Adonina Tardón, Shanbeh Zienolddiny, Hongbing Shen, and Christopher I. Amos. Causal relationships between body mass index, smoking and lung cancer: Univariable and multivariable mendelian randomization. *International Journal of Cancer*, 148(5):1077–1086, 2021. doi: <https://doi.org/10.1002/ijc.33292>.

A Proofs

In this section, we restate all lemmas and Proposition 1 and provide their corresponding proofs.

Lemma 1. Let $\mathcal{G}_s = (\mathcal{V}_s, \mathcal{E}_s)$ be a SCG, $\gamma_{max} \geq 0$ a maximum lag and $\alpha_{Y_t, X_{t-\gamma_{xy}}}$ the direct effect of $X_{t-\gamma_{xy}}$ on Y_t such that $X, Y \in \mathcal{V}_s$, $X \neq Y$ and $0 \leq \gamma_{xy} \leq \gamma_{max}$. If $X \notin \text{Parents}(Y, \mathcal{G}_s)$ then $\alpha_{Y_t, X_{t-\gamma_{xy}}}$ is identifiable.

Proof. Suppose $X \notin \text{Parents}(Y, \mathcal{G}_s)$. Then $X_{t-\gamma_{xy}} \notin \text{Parents}(Y_t, \mathcal{G}_f)$ and the direct effect is equal to zero (i.e., $\alpha_{Y_t, X_{t-\gamma_{xy}}} = 0$). \square

Lemma 2. Let $\mathcal{G}_f = (\mathcal{V}_f, \mathcal{E}_f)$ be a FTCTG of maximal lag at most $\gamma_{max} \geq 0$ and $\alpha_{Y_t, X_{t-\gamma_{xy}}}$ the direct effect of $X_{t-\gamma_{xy}}$ on Y_t such that $X_{t-\gamma_{xy}}, Y_t \in \mathcal{V}_f$, $X \neq Y$ and $0 \leq \gamma_{xy} \leq \gamma_{max}$. Let $\pi_f = \langle V_{t^1}^1, \dots, V_{t^n}^n \rangle$ a path from $X_{t-\gamma_{xy}}$ to Y_t in \mathcal{G}_f . If $t_{max}(\pi_f) > t$ then π_f is passively blocked by any $\mathcal{Z}_f \subseteq \mathcal{V}_f$ such that $\mathcal{Z}_f \cap \{V_{t'} \in \mathcal{V}_f | t' > t\} = \emptyset$. If $t_{min}(\pi_f) < t - \gamma_{xy}$ then π_f is manually blocked by any $\mathcal{Z}_f \subseteq \mathcal{V}_f$ such that $\{V_{t'} \in \mathcal{V}_f | t - \gamma_{max} \leq t' < t\} \subseteq \mathcal{Z}_f$.

Proof. Let $\mathcal{G}_f = (\mathcal{V}_f, \mathcal{E}_f)$ be a FTCTG, $X_{t-\gamma_{xy}} \neq Y_t \in \mathcal{V}_f$ and $\pi_f = \langle V_{t^1}^1, \dots, V_{t^n}^n \rangle$ a path from $X_{t-\gamma_{xy}}$ to Y_t in \mathcal{G}_f .

- Suppose $t_{max}(\pi_f) > t$. Since $t - \gamma_{xy} \leq t < t_{max}(\pi_f)$ there exists $1 < i \leq j < n$ such that $t^{i-1} < t^i = t_{max}(\pi_f) = t^j > t^{j+1}$. Therefore, $V_{t^{i-1}}^{i-1} \rightarrow V_{t^i}^i$ and $V_{t^j}^j \leftarrow V_{t^{j+1}}^{j+1}$ in π_f . Thus, $\exists i \leq k \leq j$ such that $V_{t^{k-1}}^{k-1} \rightarrow V_{t^k}^k \leftarrow V_{t^{k+1}}^{k+1}$ in π_f and $t^k = t_{max}(\pi_f) > t$. In conclusion, π_f is passively blocked by any $\mathcal{Z}_f \subseteq \mathcal{V}_f$ such that $\text{Descendants}(V_{t^k}^k, \mathcal{G}_f) \cap \mathcal{Z}_f = \emptyset$ so by any \mathcal{Z}_f such that $\mathcal{Z}_f \cap \{V_{t'} \in \mathcal{V}_f | t' > t\} = \emptyset$
- Suppose $t_{min}(\pi_f) < t - \gamma_{xy}$. Since $t_{min}(\pi_f) < t - \gamma_{xy} < t$ and $t^n = t$ there exists $1 < i < n$ such that $t^i < t \leq t^{i+1}$. Therefore, $V_{t^i}^i \rightarrow V_{t^{i+1}}^{i+1}$ in π_f and $t - \gamma_{max} \leq t^i < t \leq t^{i+1}$ so $V_{t^i}^i \in \{V_{t'} \in \mathcal{V}_f | t - \gamma_{max} \leq t' < t\}$. In conclusion, π_f is manually blocked by any $\mathcal{Z}_f \subseteq \mathcal{V}_f$ such that $V_{t^i}^i \in \mathcal{Z}_f$ so by any \mathcal{Z}_f such that $\{V_{t'} \in \mathcal{V}_f | t - \gamma_{max} \leq t' < t\} \subseteq \mathcal{Z}_f$.

\square

Lemma 3. Let $\mathcal{G}_s = (\mathcal{V}_s, \mathcal{E}_s)$ be a SCG, $\gamma_{max} \geq 0$ a maximum lag and $\alpha_{Y_t, X_{t-\gamma_{xy}}}$ the direct effect of $X_{t-\gamma_{xy}}$ on Y_t such that $X, Y \in \mathcal{V}_s$, $X \neq Y$ and $0 \leq \gamma_{xy} \leq \gamma_{max}$. For every non-direct walk $\pi_s = \langle V^1, \dots, V^n \rangle$ between X and Y such that $\langle V^2, \dots, V^{n-1} \rangle \not\subseteq \text{Descendants}(Y, \mathcal{G}_s)$, every compatible path $\pi_f \in \phi^{-1}(\pi_s)$ from $X_{t-\gamma_{xy}}$ to Y_t can be blocked by the adjustment set $\mathcal{Z}_f = \mathcal{A}_{\leq t} \cup \mathcal{D}_{< t}$ defined in Definition 12.

Proof. Suppose there exists a non-direct walk $\pi_s = \langle V^1, \dots, V^n \rangle$ between X and Y such that $\langle V^2, \dots, V^{n-1} \rangle \not\subseteq \text{Descendants}(Y, \mathcal{G}_s)$. Then, take $\pi_f = \langle V_{t^1}^1, \dots, V_{t^n}^n \rangle$ from $X_{t-\gamma_{xy}}$ to Y_t compatible with π_s (i.e., $\pi_f \in \phi^{-1}(\pi_s)$). Take $j = \max\{1 < i < n | V^i \notin \text{Descendants}(Y, \mathcal{G}_s)\}$. Notice that $V^j \notin \text{Descendants}(Y, \mathcal{G}_s)$ and $V^{j+1} \in \text{Descendants}(Y, \mathcal{G}_s)$ so $V_{t^j}^j \rightarrow V_{t^{j+1}}^{j+1} \in \pi_f$. Therefore, since $t - \gamma_{xy} \leq t_{min}(\pi_f) \leq t_{max}(\pi_f) \leq t$ by Lemma 2, $t - \gamma_{xy} \leq t^j \leq t$ and thus π_f is manually blocked by $V_{t^j}^j \in \mathcal{A}_{\leq t} \subseteq \mathcal{Z}_f$. \square

Lemma 4. Let $\mathcal{G}_s = (\mathcal{V}_s, \mathcal{E}_s)$ be a SCG, $\gamma_{max} \geq 0$ a maximum lag and $\alpha_{Y_t, X_{t-\gamma_{xy}}}$ the direct effect of $X_{t-\gamma_{xy}}$ on Y_t such that $X, Y \in \mathcal{V}_s$, $X \neq Y$ and $0 < \gamma_{xy} \leq \gamma_{max}$. For every non-direct walk $\pi_s = \langle V^1, \dots, V^n \rangle$ from X to Y such that $\exists 1 \leq i < n$, $V^i \leftarrow V^{i+1}$ (i.e., not $V^i \rightarrow V^{i+1}$ and not $V^i \rightleftharpoons V^{i+1}$), every compatible path $\pi_f \in \phi^{-1}(\pi_s)$ from $X_{t-\gamma_{xy}}$ to Y_t can be blocked by $\mathcal{Z}_f = \mathcal{A}_{\leq t} \cup \mathcal{D}_{< t}$ because $\mathcal{Z}_f \cap \mathcal{D}_{\geq t} = \emptyset$ where:

- $\mathcal{A}_{\leq t}$, $\mathcal{D}_{< t}$ are defined in Definition 12 and
- $\mathcal{D}_{\geq t}$ is the set of instants of descendants of Y greater or equal to t , i.e., $\mathcal{D}_{\geq t} = \{V_{t'} | V \in \text{Descendants}(Y, \mathcal{G}_s), t' \geq t\}$.

Note that $\pi_s = \langle V^1, \dots, V^n \rangle$ from X to Y is non-direct, $X \in \text{Parents}(Y, \mathcal{G}_s)$ by Lemma 1 and $\exists 1 \leq i < n$, $V^i \leftarrow V^{i+1}$ implies that $n \geq 3$.

Proof. Let $\pi_s = \langle V^1, \dots, V^n \rangle$ be a non-direct walk between X and Y such that $\langle V^2, \dots, V^{n-1} \rangle \not\subseteq \text{Descendants}(Y, \mathcal{G}_s)$ and $\gamma_{xy} > 0$ and $\exists 1 \leq i < n$, $V^i \leftarrow V^{i+1}$. Then, take $\pi_f = \langle V_{t^1}^1, \dots, V_{t^n}^n \rangle$ from

$X_{t-\gamma_{xy}}$ to Y_t compatible with π_s (i.e., $\pi_f \in \phi^{-1}(\pi_s)$) and $1 \leq i < n$ such that $V_{t^i}^i \leftarrow V_{t^{i+1}}^{i+1}$. $t_{\min}(\pi_f) \geq t - \gamma_{xy}$ and $t_{\max}(\pi_f) \leq t$ by Lemma 2.

If $V_{t^{i+1}}^{i+1} \notin \mathcal{D}_{\geq t}$ then since $t_{\min}(\pi_f) \geq t - \gamma_{xy}$ and $t_{\max}(\pi_f) \leq t$, π_f is manually blocked by $V_{t^{i+1}}^{i+1} \in \mathcal{Z}_f = \mathcal{A}_{\leq t} \cup \mathcal{D}_{< t}$.

Else, $V_{t^{i+1}}^{i+1} \in \mathcal{D}_{\geq t}$, so since $\gamma_{xy} > 0$ and $t_{\min}(\pi_f) \geq t - \gamma_{xy}$ and $t_{\max}(\pi_f) \leq t$, there exists $j = \max\{1 < j \leq i \mid V_{t^{j-1}}^{j-1} \rightarrow V_{t^j}^j\}$. Thus V^j is a collider and $V^j \in \mathcal{D}_{\geq t}$ so $\text{Descendants}(V_{t^j}^j, \mathcal{G}_s) \subseteq \mathcal{D}_{\geq t}$. Therefore, π_f is passively blocked by $V_{t^j}^j \in \mathcal{Z}_f = \mathcal{A}_{\leq t} \cup \mathcal{D}_{< t}$.

In conclusion, π_f is blocked by \mathcal{Z}_f . \square

Lemma 5. Let $\mathcal{G}_s = (\mathcal{V}_s, \mathcal{E}_s)$ be a SCG, $\gamma_{\max} \geq 0$ a maximum lag and $\alpha_{Y_t, X_{t-\gamma_{xy}}}$ the direct effect of $X_{t-\gamma_{xy}}$ on Y_t such that $X, Y \in \mathcal{V}_s$, $X \neq Y$ and $0 < \gamma_{xy} \leq \gamma_{\max}$. For every non-direct walk $\pi_s = \langle V^1, \dots, V^n \rangle$ from X to Y where $\exists 1 < i < n$, $V^i = Y$, every compatible path $\pi_f \in \phi^{-1}(\pi_s)$ from $X_{t-\gamma_{xy}}$ to Y_t can be blocked by $\mathcal{Z}_f = \mathcal{A}_{\leq t} \cup \mathcal{D}_{< t}$ (notice $\mathcal{Z}_f \cap \mathcal{D}_{\geq t} = \emptyset$) where $\mathcal{A}_{\leq t}$, $\mathcal{D}_{< t}$ are defined in Definition 12 and $\mathcal{D}_{\geq t}$ is defined in Lemma 4.

Proof. Let $\pi_s = \langle V^1, \dots, V^n \rangle$ be a non-direct walk between X and Y as described. Then, take $\pi_f = \langle V_{t^1}^1, \dots, V_{t^n}^n \rangle$ non-direct from $X_{t-\gamma_{xy}}$ to Y_t compatible with π_s (i.e., $\pi_f \in \phi^{-1}(\pi_s)$). Since $\exists 1 < i_y < n$ such that $V^{i_y} = Y$ and because π_f is a path, $t^{i_y} \neq t$ so by Lemma 2 $t - \gamma_{xy} \leq t^{i_y} < t$. If $\leftarrow V_{t^{i_y}}^{i_y}$ or $V_{t^{i_y}}^{i_y} \rightarrow$ then π_f is manually blocked by $V_{t^{i_y}}^{i_y}$. Since $t - \gamma_{xy} \leq t^{i_y} < t$, $V_{t^{i_y}}^{i_y} \in \mathcal{Z}_f$ and π_f is manually blocked by \mathcal{Z}_f . If $\rightarrow V_{t^{i_y}}^{i_y} \leftarrow V_{t^{i_y+1}}^{i_y+1}$ then π_f is manually blocked by $V_{t^{i_y+1}}^{i_y+1}$. Using Lemma 2, $t - \gamma_{xy} \leq t^{i_y+1} \leq t$. Moreover, since $t - \gamma_{xy} \leq t^{i_y} < t$ and $V_{t^{i_y}}^{i_y} \leftarrow V_{t^{i_y+1}}^{i_y+1}$, one can see that $t - \gamma_{xy} \leq t^{i_y+1} < t$. Lastly, π_f is a path so $V_{t^{i_y+1}}^{i_y+1} \neq X_{t-\gamma_{xy}}$. Thus π_f is manually blocked by $V_{t^{i_y+1}}^{i_y+1} \in \mathcal{Z}_f$. \square

Lemma 6. Let $\mathcal{G}_s = (\mathcal{V}_s, \mathcal{E}_s)$ be a SCG, $\gamma_{\max} \geq 0$ a maximum lag and $\alpha_{Y_t, X_{t-\gamma_{xy}}}$ the direct effect of $X_{t-\gamma_{xy}}$ on Y_t such that $X, Y \in \mathcal{V}_s$, $X \neq Y$ and $0 \leq \gamma_{xy} \leq \gamma_{\max}$. If there exists a path $\pi_s = \langle V^1, \dots, V^n \rangle$ from X to Y with $\langle V^2, \dots, V^{n-1} \rangle \subseteq \text{Descendants}(Y, \mathcal{G}_s)$ and $\exists 1 \leq i < n$, $V^i \leftarrow V^{i+1}$ and either $n \geq 3$ or $X \in \text{Descendants}(Y, \mathcal{G}_s)$ and $\exists C \in \text{Cycles}(X, \mathcal{G}_s)$ with $Y \notin C$ then $\alpha_{Y_t, X_{t-\gamma_{xy}}}$ is not identifiable.

Proof. Let $\pi_s = \langle V^1, \dots, V^n \rangle$ be a non-direct path from X to Y with $\langle V^2, \dots, V^{n-1} \rangle \subseteq \text{Descendants}(Y, \mathcal{G}_s)$ and $\exists 1 \leq i < n$, $V^i \leftarrow V^{i+1}$ and either $n \geq 3$ or $X \in \text{Descendants}(Y, \mathcal{G}_s)$ and $\exists C \in \text{Cycles}(X, \mathcal{G}_s)$ with $Y \notin C$. If $n \geq 3$ take $\pi'_s = \langle U^1, \dots, U^{m+1} \rangle = \pi_s$. If $n = 2$ and $\exists C = \langle U^1, \dots, U^m \rangle \in \text{Cycles}(X, \mathcal{G}_s)$ with $Y \notin C$, then take $\pi'_s = C + \pi_s$ in order to have a walk $\pi'_s = \langle U^1, \dots, U^{m+1} \rangle$.

• Firstly,

- if $n \geq 3$ then $\langle V^2, \dots, V^{n-1} \rangle \subseteq \text{Descendants}(Y, \mathcal{G}_s)$ and $\pi'_s = \langle U^1, \dots, U^{m+1} \rangle = \pi_s$ give $\langle U^2, \dots, U^m \rangle \subseteq \text{Descendants}(Y, \mathcal{G}_s)$, and
- if $n = 2$ since $X \in \text{Descendants}(Y, \mathcal{G}_s)$, $C \subseteq \text{Descendants}(X, \mathcal{G}_s) \subseteq \text{Descendants}(Y, \mathcal{G}_s)$ so $\pi'_s = C + \pi_s = \langle U^2, \dots, U^m \rangle \subseteq \text{Descendants}(Y, \mathcal{G}_s)$.

Therefore, there exists a FTCCG \mathcal{G}_f compatible with \mathcal{G}_s in which $\langle U_t^2, \dots, U_t^{m+1} \rangle \subseteq \text{Descendants}(Y_t, \mathcal{G}_f)$.

- Secondly, since $Y \notin C$, X and Y are not repeated in $\langle U^2, \dots, U^{m+1} \rangle$ and because $\exists 1 \leq i \leq n$, $V^i \leftarrow V^{i+1}$ and $U^m = X \rightleftharpoons Y = U^{m+1}$, there exists a FTCCG \mathcal{G}'_f compatible with \mathcal{G}_s in which $\pi_f = \langle U_{t-\gamma_{xy}}^1 \rightarrow U_t^2 \rightarrow \dots \rightarrow U_t^{m+1} \rangle$ is a path. In this case, π_f is active and can only be blocked by a \mathcal{Z}_f such that $\mathcal{Z}_f \cap \langle U_{t-\gamma_{xy}}^1, U_t^2, \dots, U_t^{m+1} \rangle \neq \emptyset$.

Since adjusting on $X_{t-\gamma_{xy}}$ or descendants of Y_t induces a bias, these two cases are irreconcilable and therefore $\alpha_{Y_t, X_{t-\gamma_{xy}}}$ is not identifiable. \square

Lemma 6. Let $\mathcal{G}_s = (\mathcal{V}_s, \mathcal{E}_s)$ be a SCG, $\gamma_{\max} \geq 0$ a maximum lag and $\alpha_{Y_t, X_{t-\gamma_{xy}}}$ the direct effect of $X_{t-\gamma_{xy}}$ on Y_t such that $X, Y \in \mathcal{V}_s$, $X \neq Y$ and $0 \leq \gamma_{xy} \leq \gamma_{\max}$. If there exists a path $\pi_s = \langle V^1, \dots, V^n \rangle$ from X to Y with $\langle V^2, \dots, V^{n-1} \rangle \subseteq \text{Descendants}(Y, \mathcal{G}_s)$ and $\exists 1 \leq i < n$, $V^i \leftarrow V^{i+1}$ and either $n \geq 3$ or $X \in \text{Descendants}(Y, \mathcal{G}_s)$ and $\exists C \in \text{Cycles}(X, \mathcal{G}_s)$ with $Y \notin C$ then $\alpha_{Y_t, X_{t-\gamma_{xy}}}$ is not identifiable.

Proof. Let $\pi_s = \langle V^1, \dots, V^n \rangle$ be a path from X to Y with $\langle V^2, \dots, V^{n-1} \rangle \subseteq \text{Descendants}(Y, \mathcal{G}_s)$ and $\nexists 1 \leq i < n, V^i \leftarrow V^{i+1}$ and either $n \geq 3$ or $\exists C \in \text{Cycles}(X, \mathcal{G}_s)$ with $Y \notin C$. If $n \geq 3$ take $\pi'_s = \langle U^1, \dots, U^{m+1} \rangle = \pi_s$. If $n = 2$ and $\exists C = \langle U^1, \dots, U^m \rangle \in \text{Cycles}(X, \mathcal{G}_s)$ with $Y \notin C$, then take $\pi'_s = C + \pi_s$ in order to have a walk $\pi'_s = \langle U^1, \dots, U^{m+1} \rangle$.

• Firstly,

- if $n \geq 3$ then $\langle V^2, \dots, V^{n-1} \rangle \subseteq \text{Descendants}(Y, \mathcal{G}_s)$ and $\pi'_s = \langle U^1, \dots, U^{m+1} \rangle = \pi_s$ give $\langle U^2, \dots, U^m \rangle \subseteq \text{Descendants}(Y, \mathcal{G}_s)$, and
- if $n = 2$ then because π_s is non-direct from X to Y and $X \in \text{Parents}(Y, \mathcal{G}_s)$ by Lemma 1, we know $X \rightleftharpoons Y$ and thus $X \in \text{Descendants}(Y, \mathcal{G}_s)$ and $C \subseteq \text{Descendants}(X, \mathcal{G}_s) \subseteq \text{Descendants}(Y, \mathcal{G}_s)$ so $C + \pi_s = \langle U^2, \dots, U^m \rangle \subseteq \text{Descendants}(Y, \mathcal{G}_s)$.

Therefore, there exists a FTCCG \mathcal{G}_f compatible with \mathcal{G}_s in which $\langle U_t^2, \dots, U_t^{m+1} \rangle \subseteq \text{Descendants}(Y_t, \mathcal{G}_f)$.

- Secondly, since $Y \notin C$, X and Y are not repeated in $\langle U^2, \dots, U^{m+1} \rangle$ and because $\nexists 1 \leq i \leq n, V^i \leftarrow V^{i+1}$ and $U^m = X \rightleftharpoons Y = U^{m+1}$, there exists a FTCCG \mathcal{G}'_f compatible with \mathcal{G}_s in which $\pi_f = \langle U_{t-\gamma_{xy}}^1 \rightarrow U_t^2 \rightarrow \dots \rightarrow U_t^{m+1} \rangle$ is a path. In this case, π_f is active and can only be blocked by a \mathcal{Z}_f such that $\mathcal{Z}_f \cap \langle U_{t-\gamma_{xy}}^1, U_t^2, \dots, U_t^{m+1} \rangle \neq \emptyset$.

Since adjusting on $X_{t-\gamma_{xy}}$ or descendants of Y_t induces a bias, these two cases are irreconcilable and therefore $\alpha_{Y_t, X_{t-\gamma_{xy}}}$ is not identifiable. \square

Lemma 7. Let $\mathcal{G}_s = (\mathcal{V}_s, \mathcal{E}_s)$ be a SCG, $\gamma_{max} \geq 0$ a maximum lag and $\alpha_{Y_t, X_{t-\gamma_{xy}}}$ the direct effect of $X_{t-\gamma_{xy}}$ on Y_t such that $X, Y \in \mathcal{V}_s, X \neq Y$ and $\gamma_{xy} = 0$. If there exists an active non-direct path $\pi_s = \langle V^1, \dots, V^n \rangle$ from X to Y in \mathcal{G}_s with $\langle V^2, \dots, V^{n-1} \rangle \subseteq \text{Descendants}(Y, \mathcal{G}_s)$ then $\alpha_{Y_t, X_{t-\gamma_{xy}}}$ is not identifiable.

Proof. Let $\pi_s = \langle V^1, \dots, V^n \rangle$ be an active non-direct path from X to Y in \mathcal{G}_s with $\langle V^2, \dots, V^{n-1} \rangle \subseteq \text{Descendants}(Y, \mathcal{G}_s)$ and $\gamma_{xy} = 0$. Since $\langle V^2, \dots, V^{n-1} \rangle \subseteq \text{Descendants}(Y, \mathcal{G}_s)$ there exists a FTCCG \mathcal{G}_f compatible with \mathcal{G}_s in which $\langle V_t^2, \dots, V_t^{n-1} \rangle \subseteq \text{Descendants}(Y_t, \mathcal{G}_f)$. Moreover, since π_s is active there exists a FTCCG \mathcal{G}'_f compatible with \mathcal{G}_s in which $\pi_f = \langle V_t^1, \dots, V_t^n \rangle$ is an active path and can only be blocked by a \mathcal{Z}_f such that $\mathcal{Z}_f \cap \langle V_t^1, \dots, V_t^n \rangle \neq \emptyset$. Since adjusting on $X_{t-\gamma_{xy}}$ or descendants of Y_t induces a bias, these two cases are irreconcilable and therefore $\alpha_{Y_t, X_{t-\gamma_{xy}}}$ is not identifiable. \square

Proposition 1. Consider a SCG $\mathcal{G}_s = (\mathcal{V}_s, \mathcal{E}_s)$, a maximal lag γ_{max} , two vertices X and Y with $X \in \text{Parents}(Y, \mathcal{G}_s)$ and a lag γ_{xy} . Suppose the direct effect of $X_{t-\gamma_{xy}}$ on Y_t is identifiable following Theorem 1. The adjustment set \mathcal{Z}_f relative to $(X_{t-\gamma_{xy}}, Y_t)$ defined in Definition 13 verifies:

- $\mathcal{Z}_f \cap (\text{Descendants}(Y_t, \mathcal{G}_f) \cup \{X_{t-\gamma_{xy}}\}) = \emptyset$, and
- \mathcal{Z}_f blocks every non-direct path from $X_{t-\gamma_{xy}}$ to Y_t in every compatible FTCCG \mathcal{G}_f of maximal lag at most γ_{max} .

which allows to estimate the direct effect $\alpha_{Y_t, X_{t-\gamma_{xy}}}$.

Proof. Let $\mathcal{G}_s = (\mathcal{V}_s, \mathcal{E}_s)$ be a SCG, $X, Y \in \mathcal{V}_s$ with $X \in \text{Parents}(Y, \mathcal{G}_s)$ and γ_{xy} be a lag. Suppose the direct effect of $X_{t-\gamma_{xy}}$ on Y_t is identifiable following Theorem 1. Let \mathcal{Z}_f be the single-door set relative to $(X_{t-\gamma_{xy}}, Y_t)$ defined in Definition 13. Let $\mathcal{G}_f = (\mathcal{V}_f, \mathcal{E}_f)$ be a compatible FTCCG of maximal lag at most γ_{max} compatible with \mathcal{G}_s .

- Firstly, using the decomposition $\mathcal{Z}_f = \mathcal{D}_{t'}^{Anc(Y)} \cup \mathcal{A}_{t'}^{Anc(Y)}$ as in Definition 13, and because $\text{Descendants}(Y_t, \mathcal{G}_f) \subseteq \{V_{t'} | V \in \text{Descendants}(Y, \mathcal{G}_s), t' \geq t\}$ it is clear that $\mathcal{Z}_f \cap (\text{Descendants}(Y_t, \mathcal{G}_f) \cup \{X_{t-\gamma_{xy}}\}) = \emptyset$.
- Secondly, let $\pi_f = \langle V_{t_1}^1, \dots, V_{t_n}^n \rangle$ be a non-direct path from $X_{t-\gamma_{xy}}$ to Y_t in FTCCG \mathcal{G}_f and $\pi_s = \langle V^1, \dots, V^n \rangle = \phi(\pi_f)$ its compatible walk. If $t_{max}(\pi_f) > t$ then $\exists 1 < k < n$ such that $\rightarrow V_{t_{max}(\pi_f)}^k \leftarrow$ in

π_f with $Descendants(V_{t_{max}(\pi_f)}^k, \mathcal{G}_f) \cap \mathcal{Z}_f = \emptyset$ and thus π_f is passively blocked by \mathcal{Z}_f . Therefore, for the following we can suppose $t_{max}(\pi_f) \leq t$.

Because the direct effect of $X_{t-\gamma_{xy}}$ on Y_t is identifiable following Theorem 1 we know that $\pi_f \neq \langle V_{t^1}^1 \leftarrow \dots \leftarrow V_{t^n}^n \rangle$. Therefore, $\exists 1 < k \leq n$ such that $\rightarrow V_{t^k}^k \leftarrow \dots \leftarrow V_{t^n}^n$ with $t^k \geq t$ and $V^k \in Descendants(Y, \mathcal{G}_s)$ and since π_f is non-direct this forces $n > 2$.

- If $k < n$ then $Descendants(V_{t^k}^k, \mathcal{G}_f) \cap \mathcal{Z}_f = \emptyset$ and thus π_f is passively blocked by \mathcal{Z}_f .
- If $k = n$ (i.e., $V_{t^{n-1}}^{n-1} \rightarrow V_{t^n}^n$) and $\pi_f = \langle V_{t^1}^1 \rightarrow \dots \rightarrow V_{t^n}^n \rangle$ then because the direct effect of $X_{t-\gamma_{xy}}$ on Y_t is identifiable following Theorem 1 we know that $\exists d_{max} = \max\{1 < d < n \text{ such that } V^d \notin Descendants(Y, \mathcal{G}_s)\}$. This forces either $t - \gamma_{max} \leq t^{d_{max}} \leq t$ or $\exists d_{max} < d < n$ such that $t - \gamma_{max} \leq t^d < t$ so since $V^{d_{max}}, V^d \in Ancestors(Y, \mathcal{G}_s)$, we have either $V_{t^{d_{max}}}^{d_{max}} \in \mathcal{A}_{t'}^{Anc(Y)}$ or $V_{t^d}^d \in \mathcal{D}_{t'}^{Anc(Y)}$ and thus π_f is manually blocked by \mathcal{Z}_f .
- If $k = n$ (i.e., $V_{t^{n-1}}^{n-1} \rightarrow V_{t^n}^n$) and $\exists l_{max} = \max\{1 < l < n | V_{t^{l-1}}^{l-1} \leftarrow V_{t^l}^l\}$ then $V^{l_{max}} \in Ancestors(Y, \mathcal{G}_s)$
 - * If $t^{l_{max}} < t$ then $\exists l_{max} \leq i$ such that $V_{t^i}^i \rightarrow V_{t^{i+1}}^{i+1}$ and $t - \gamma_{max} \leq t^i < t^{i+1} = t$ and since $V^i \in Ancestors(Y, \mathcal{G}_s)$, $V_{t^i}^i \in \mathcal{Z}_f$ and thus π_f is manually blocked by \mathcal{Z}_f .
 - * If $V^{l_{max}} \notin Descendants(Y, \mathcal{G}_s)$ and $t^{l_{max}} = t$ then, since $V^{l_{max}} \in Ancestors(Y, \mathcal{G}_s)$, $V_{t^{l_{max}}}^{l_{max}} \in \mathcal{A}_{t'}^{Anc(Y)}$ and thus π_f is manually blocked by \mathcal{Z}_f .
 - * If $V^{l_{max}} \in Descendants(Y, \mathcal{G}_s)$ and $t^{l_{max}} = t$ then we can distinguish the cases $\gamma_{xy} = 0$ and $\gamma_{xy} > 0$:
 - If $\gamma_{xy} = 0$ then, because the direct effect of $X_{t-\gamma_{xy}}$ on Y_t is identifiable following Theorem 1 we know that $\phi(\pi_f)$ is blocked so $\exists r_{max} = \max\{1 < r < l_{max} | V_{t^{r-1}}^{r-1} \rightarrow V_{t^r}^r\}$.
 - Similarly, if $\gamma_{xy} > 0$ since $V_{t^{l_{max}-1}}^{l_{max}-1} \leftarrow V_{t^{l_{max}}}^{l_{max}}$, then $t = t^{l_{max}} \leq t^{l_{max}-1} \leq t$ and there must exist $1 < r < l_{max}$ such that $V_{t^{r-1}}^{r-1} \rightarrow V_{t^r}^r$ with $t^r < t^{r+1} = t$ so $\exists r_{max} = \max\{1 < r < l_{max} | V_{t^{r-1}}^{r-1} \rightarrow V_{t^r}^r\}$.

Therefore, we have $\rightarrow V_{t^r}^r \leftarrow$ and since $V^{l_{max}} \in Descendants(Y, \mathcal{G}_s)$ and $V^{r_{max}} \in Descendants(V^{l_{max}}, \mathcal{G}_s)$ we have $V^{r_{max}} \in Descendants(Y, \mathcal{G}_s)$ so $\mathcal{Z}_f \cap Descendants(V_{t^{r_{max}}}^{r_{max}}, \mathcal{G}_f) = \emptyset$ and therefore π_f is passively blocked by \mathcal{Z}_f .

In conclusion, π_f is blocked by \mathcal{Z}_f .

□