





A Term-based Approach for Generating Finite Automata from Interaction Diagrams

Erwan Mahe¹, Boutheina Bannour¹, Christophe Gaston¹,
Arnault Lapitre¹, and Pascale Le Gall²

¹ Université Paris-Saclay, CEA, List, F-91120, Palaiseau, France

² Université Paris-Saclay, CentraleSupélec, F-91192, Gif-sur-Yvette, France

Abstract. Non-deterministic Finite Automata (NFA) may represent regular languages succinctly (in number of states), increasing their appeal for applications such as word recognition. This paper proposes a new approach to generate NFA from an interaction language such as UML Sequence Diagrams or Message Sequence Charts. Using an operational semantics, we generate an NFA from a set of interactions reachable using the associated execution relation. In addition, by applying simplifications (rewriting) on reachable interactions to merge them, it is possible to obtain reduced NFA without relying on costly NFA reduction techniques. Experimental results regarding NFA generation and their application in trace analysis are also presented.

Keywords: Interaction language · Sequence Diagram · Message Sequence Chart · Non-deterministic Finite Automaton generation · Trace analysis

1 Introduction

Interactions are behavioral models describing communication flows between actors. Interaction languages include, among others, Message Sequence Charts (MSC) [11,33], or UML Sequence Diagrams (UML-SD) [36]. Those models have a graphical counterpart, which allows producing human-readable specifications. Fig.1 depicts one such interaction: each actor (here **l1** and **l2**) is associated to a vertical line, called a *lifeline*. Message exchanges are represented by horizontal arrows connecting two lifelines and labelled by message names (here **m1**, **m2** and **m3**). Scenarios specified by interactions are described as *traces* i.e. successions of atomic communication actions (abbrv. *actions*) which are either the emission of a message m from a lifeline l (denoted as $l!m$) or the reception of m by l (denoted as $l?m$).

High level operators such as parallel composition, choice and repetition may be used to structure scenarios. A particularity of interactions is the distinction between strict and weak sequencing resp. denoted as *strict* and *seq*. While *strict* always enforces an order between actions (e.g. in $strict(l_1!m, l_2!m)$, $l_1!m$ must

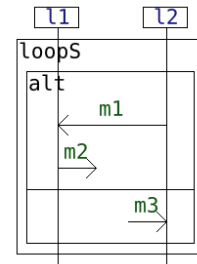

Fig. 1: Interaction

occur first), *seq* only does so between actions occurring on the same lifeline (e.g. in $seq(l_1!m_1, l_2!m_2)$, if $l = l_1$ then $l_1!m_1$ must occur first but if $l \neq l_1$ they can occur in any order). Most operators are drawn as annotated boxes (for instance, on Fig.1, *loops* denotes a strictly sequential loop and *alt* a non-deterministic choice). However this is not the case for *strict*, which may correspond to the encoding of horizontal message exchange arrows and *seq*, which is never drawn and always corresponds to the top to bottom direction of the diagram. In other words, when two arrows are drawn one above the other this means they are structured using *seq*. As a result, the interaction from Fig.1 signifies that we can repeat either the transmission of *m1* from *l2* to *l1* followed by the emission of *m2* by *l1* or the reception of *m3* by *l2*.

Interestingly, for a subset of interactions, associated trace languages are regular. Therefore, associating them with Finite Automata (FA) is possible. In the literature, translations from interaction to FA have been explored and generally rely on linearization of partial orders [1] and/or composition, matching interaction operators to FA ones [40]. In this paper, we explore an alternative approach, taking advantage of a representation of interactions as terms [31]. This representation allows the definition of a structural operational semantics [38] via a predicate \rightarrow defining transformations $i \xrightarrow{a} i'$ where i is an interaction, a is an action which can immediately occur within behaviors specified by i and i' is an interaction specifying all the continuations of behaviors specified by i that start with the occurrence of a . The semantics of i is then characterized by a graph-like structure in which each path may correspond to a specified behavior. We identify a subset of the language from [31] for which this structure is finite, which allows for the synthesis of NFA accepting the same language. Moreover, we generate a NFA with a reduced number of states by dynamically merging states that correspond to semantically equivalent interactions. Such equivalences can be identified thanks to rewriting rules applied to interaction terms. Empirical evidence shows that we can generate NFA with a number of states close to that of the minimal equivalent NFA. We then take advantage of those automata to perform trace analysis in the fashion of [30] with a gain in performances at the cost of a loss in the expressive power of the language.

The paper is organized as follows. After some preliminaries in Sec.2, we introduce our interaction language and its semantics in Sec.3. Sec.4 covers our approach for NFA generation and Sec.5 presents experimental results. Finally, after some remarks and related works in Sec.6, we conclude in Sec.7.

2 Preliminaries

For a set A , $\mathcal{P}(A)$ and A^* resp. denote the sets of all subsets of A and of all finite sequences over A . "." denotes the concatenation operation and ε the empty sequence. For $w \in A^*$ and for $a \in A$, the length of (resp. number of occurrences of a in) w is denoted by $|w|$ (resp. by $|w|_a$). A word u is said to be a prefix of w if there exists a word v such that $w = u.v$.

Non-deterministic Finite Automata (NFA). Def.1 recalls the definition of NFA.

Definition 1. A NFA is a tuple $(A, Q, q_0, F, \rightsquigarrow)$ s.t. A is a finite alphabet, Q is a finite set of states, $q_0 \in Q$ is an initial state, $F \subseteq Q$ is a set of accepting states and $\rightsquigarrow \subseteq Q \times A \times Q$ is a finite set of transitions.

A transition (q, x, q') , with $q, q' \in Q^2$ and $x \in A$ is denoted as $q \xrightarrow{x} q'$ and is said to be labelled by x . For q and q' in Q , a path from q to q' is a finite sequence of $k > 0$ consecutive transitions $q_i \xrightarrow{x_{i+1}} q_{i+1}$ with $i \in [0, k-1]$ s.t. $q_0 = q$ and $q_k = q'$. If we denote by w the word obtained from concatenating their labels i.e. $w = x_1 \cdots x_k$, we may then write $q \xrightarrow{w} q'$. By extension, we have $q \xrightarrow{\varepsilon} q$ for any $q \in Q$. The language recognized by a NFA $\mathcal{A} = (A, Q, q_0, F, \rightsquigarrow)$ is then the set of words $\mathcal{L}(\mathcal{A}) = \{w \in A^* \mid \exists q_f \in F \text{ s.t. } q_0 \xrightarrow{w} q_f\}$.

Term rewriting (see [8] for details). A set of operation symbols \mathcal{F} is a structured set $\mathcal{F} = \bigcup_{j \geq 0} \mathcal{F}_j$ s.t. for any integer $j \geq 0$, the set \mathcal{F}_j is that of symbols of arity j . Symbols of arity 0 are constants. We denote by $\mathcal{T}_{\mathcal{F}}$ the set of terms defined as the smallest set s.t. **(1)** $\mathcal{F}_0 \subset \mathcal{T}_{\mathcal{F}}$ and **(2)** for any symbol $f \in \mathcal{F}_j$ of arity $j > 0$ and for any terms t_1, \dots, t_j from $\mathcal{T}_{\mathcal{F}}$, $f(t_1, \dots, t_j) \in \mathcal{T}_{\mathcal{F}}$.

For any $t \in \mathcal{T}_{\mathcal{F}}$, we denote by $pos(t) \in \mathcal{P}((\mathbb{N}^+)^*)$ its set of positions according to the Dewey Decimal Notation [8], that is: **(1)** $\forall t \in \mathcal{F}_0$, $pos(t) = \{\varepsilon\}$ and **(2)** $\forall t \in \mathcal{F}$ of the form $f(t_1, \dots, t_j)$ with $j > 0$ and $f \in \mathcal{F}_j$ we have $pos(f(t_1, \dots, t_j)) = \{\varepsilon\} \cup \bigcup_{k \in [1, j]} \{k.p \mid p \in pos(t_k)\}$. For any term t , and any position $p \in pos(t)$, $t|_p$ is the sub-term at position p within t , and, for any term s , $t[s]_p$ is the term obtained by substituting $t|_p$ with s within t .

A rewrite rule $\rightsquigarrow \subseteq \mathcal{T}_{\mathcal{F}}^2$ is a relation between terms. Def.2 then defines Term Rewrite Systems (TRS) characterized by a set of rewrite rules.

Definition 2. A set R of rewrite rules defines a TRS as a relation \rightarrow_R s.t.:

- $\forall \rightsquigarrow \in R, \rightsquigarrow \subseteq \rightarrow_R$
- $\forall t \in \mathcal{T}_{\mathcal{F}}$, if there exists $y \in \mathcal{T}_{\mathcal{F}}$ s.t. $t|_p \rightarrow_R y$ for $p \in pos(t)$, then $t \rightarrow_R t[y]_p$

With $R = \bigcup_{x \in \mathbb{N}} \{x + 0 \rightsquigarrow x\}$ as rewrite rules on integer expressions, we can simplify $3 + (5 + 0) \rightarrow_R 3 + 5$ using \rightsquigarrow at position 2 within $3 + (5 + 0)$.

Given a TRS \rightarrow_R , a term $t \in \mathcal{T}_{\mathcal{F}}$ is irreducible iff there are no $t' \neq t$ s.t. $t \rightarrow_R t'$. We denote by \rightarrow_R^* the reflexive and transitive closure of the relation \rightarrow_R . A TRS is convergent if all consecutive applications starting from a term necessarily converge to the same irreducible term, i.e. if for all $t \in \mathcal{T}_{\mathcal{F}}$, there exists a unique $t' \in \mathcal{T}_{\mathcal{F}}$ s.t. $t \rightarrow_R^* t'$ and t' is irreducible. For a convergent TRS \rightarrow_R , given a term t , the notation $t \rightarrow_R^! t'$ signifies that t' is the unique irreducible term s.t. $t \rightarrow_R^* t'$.

3 Interactions and their execution

The basic notion to describe communications within a concurrent system is that of atomic communication *actions* that can be observed at the interfaces of its sub-systems. Those actions correspond to either the emission or the reception of a message. We use a finite set L of lifelines to describe communication interfaces on which those actions occur (typically one lifeline l for each sub-system). A finite set M of messages abstracts away all messages that can be transmitted. The set of actions is then denoted by $\mathbb{A} = \{l\Delta m \mid l \in L, \Delta \in \{!, ?\}, m \in M\}$. Notations $!$ and $?$ resp. denote emissions and receptions. For any $a \in \mathbb{A}$ of the form $l\Delta m$ with $\Delta \in \{!, ?\}$, $\theta(a)$ refers to the lifeline l on which it occurs. Sequences of actions called *traces* characterize executions of systems. We denote the set of all traces by $\mathbb{T} = \mathbb{A}^*$.

We consider a subset of the interaction language from [31] and formalize it as a set of terms in Def.3. It includes weak and strict sequencing (*seq* and *strict*) as well as interleaving (*par*), non-deterministic choice (*alt*) and strictly sequential repetition (*loop_S*). Fig.2 illustrates one such interaction term, which encodes the diagrammatic representation from Fig.1.

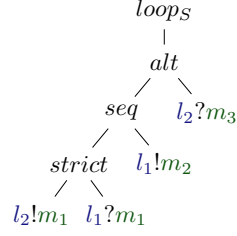

Fig. 2: Fig.1 as a term

Definition 3. *The set \mathbb{I} of interactions is the set of terms built over the following symbols provided with arities in \mathbb{N} :*

- the empty interaction \emptyset and any action a in \mathbb{A} of arity 0;
- the loop operator *loop_S* of arity 1;
- the non-deterministic choice operator *alt* of arity 2;
- and the three scheduling operators *strict*, *seq* and *par* of arity 2.

In [31], we have defined an operational semantics for interactions in the style of Plotkin [38]. The following introduces a compact rewording of that semantics.

We say that an interaction $i \in \mathbb{I}$ evades a set of lifelines $\ell \subseteq L$ if it can express traces that contain no actions occurring on lifelines of ℓ . Its definition in Def.4 follows directly from the meaning of the involved operators: for example, any loop term *loop_S*(i) evades any set of lifelines $\ell \subseteq L$ because it specifies the empty behavior ε which corresponds to repeating 0 times the loop.

Definition 4 (Evasion). *The predicate $\downarrow \subseteq \mathbb{I} \times \mathcal{P}(L)$ is s.t. for any $\ell \subseteq L$, any i_1 and i_2 from \mathbb{I} , any $f \in \{\text{strict}, \text{seq}, \text{par}\}$ we have:*

$$\begin{array}{c}
 \frac{}{\emptyset \downarrow^\ell} \qquad \frac{\theta(a) \notin \ell}{a \downarrow^\ell} \qquad \frac{i_j \downarrow^\ell}{\text{alt}(i_1, i_2) \downarrow^\ell} \quad j \in \{1, 2\} \\
 \frac{i_1 \downarrow^\ell \quad i_2 \downarrow^\ell}{f(i_1, i_2) \downarrow^\ell} \qquad \frac{}{\text{loop}_S(i_1) \downarrow^\ell}
 \end{array}$$

The pruning relation from Def.5 characterizes for any interaction i , the existence and unicity of another interaction i' which accepts exactly all executions of i that do not involve any lifelines in $\ell \subseteq L$.

Definition 5 (Pruning). *The pruning relation $\bowtie \rightarrow \subseteq \mathbb{I} \times \mathcal{P}(L) \times \mathbb{I}$ is s.t. for any $\ell \in L$, any $x \in \{\emptyset\} \cup \mathbb{A}$, any i_1 and i_2 from \mathbb{I} and any $f \in \{\text{strict}, \text{seq}, \text{par}, \text{alt}\}$:*

$$\frac{x \downarrow^\ell}{x \bowtie \rightarrow x} \quad \frac{i_j \bowtie \rightarrow i'_j \quad \neg(i_k \downarrow^\ell)}{\text{alt}(i_1, i_2) \bowtie \rightarrow i'_j} \quad \{j, k\} = \{1, 2\}$$

$$\frac{i_1 \bowtie \rightarrow i'_1 \quad i_2 \bowtie \rightarrow i'_2}{f(i_1, i_2) \bowtie \rightarrow f(i'_1, i'_2)} \quad \frac{i_1 \bowtie \rightarrow i'_1}{\text{loop}_S(i_1) \bowtie \rightarrow \text{loop}_S(i'_1)} \quad \frac{\neg(i_1 \downarrow^\ell)}{\text{loop}_S(i_1) \bowtie \rightarrow \emptyset}$$

The semantics from [31] relies on the definition of an execution relation which relates interactions to **(1)** the actions which are immediately expressible and **(2)** the interactions which remain to be expressed afterwards. With Def.6, we can determine which actions cannot be immediately expressed via the \nrightarrow relation.

Definition 6 (Non-expression). *The predicate $\nrightarrow \subseteq \mathbb{I} \times \mathbb{A}$ is s.t. for any $a \in \mathbb{A}$, any $x \in \{\emptyset\} \cup \mathbb{A}$, any i_1 and i_2 from \mathbb{I} and any $f \in \{\text{par}, \text{alt}\}$:*

$$\frac{x \neq a}{x \nrightarrow} \quad \frac{i_1 \nrightarrow}{\text{loop}_S(i_1) \nrightarrow} \quad \frac{i_1 \nrightarrow \quad \neg(i_1 \downarrow^L) \vee (i_2 \nrightarrow)}{\text{strict}(i_1, i_2) \nrightarrow}$$

$$\frac{i_1 \nrightarrow \quad \neg(i_1 \downarrow^{\{\theta(a)\}}) \vee (i_2 \nrightarrow)}{\text{seq}(i_1, i_2) \nrightarrow} \quad \frac{i_1 \nrightarrow \quad i_2 \nrightarrow}{f(i_1, i_2) \nrightarrow}$$

The relation \rightarrow given in Def.7 uses the predicates from Def.4, Def.5 and Def.6 to characterize transformations of the form $i \xrightarrow{a} i'$ where $i \in \mathbb{I}$ is an interaction, $a \in \mathbb{A}$ is an action which is immediately executable from i and $i' \in \mathbb{I}$ is a follow-up interaction which characterizes continuations of behaviors specified by i that start with a .

Definition 7 (Expression). *The predicate $\rightarrow \subseteq \mathbb{I} \times \mathbb{A} \times \mathbb{I}$ is s.t. for any $a \in \mathbb{A}$, any $i_1, i_2, i'_1, i'_2 \in \mathbb{I}^4$, any $f \in \{\text{strict}, \text{seq}, \text{par}\}$ and any $\{j, k\} = \{1, 2\}$:*

$$\frac{}{a \xrightarrow{a} \emptyset} \text{act} \quad \frac{i_1 \xrightarrow{a} i'_1}{\text{loop}_S(i_1) \xrightarrow{a} \text{strict}(i'_1, \text{loop}_S(i_1))} \text{loop}$$

$$\frac{i_1 \xrightarrow{a} i'_1}{f(i_1, i_2) \xrightarrow{a} f(i'_1, i_2)} \text{f-left} \quad \frac{i_2 \xrightarrow{a} i'_2}{\text{par}(i_1, i_2) \xrightarrow{a} \text{par}(i_1, i'_2)} \text{par-right}$$

$$\frac{i_2 \xrightarrow{a} i'_2 \quad i_1 \downarrow^L}{\text{strict}(i_1, i_2) \xrightarrow{a} i'_2} \text{strict-right} \quad \frac{i_2 \xrightarrow{a} i'_2 \quad i_1 \bowtie \rightarrow^{\{\theta(a)\}} i'_1}{\text{seq}(i_1, i_2) \xrightarrow{a} \text{seq}(i'_1, i'_2)} \text{seq-right}$$

$$\frac{i_j \xrightarrow{a} i'_j \quad i_k \nrightarrow}{\text{alt}(i_1, i_2) \xrightarrow{a} i'_j} \text{alt-choice} \quad \frac{i_1 \xrightarrow{a} i'_1 \quad i_2 \xrightarrow{a} i'_2}{\text{alt}(i_1, i_2) \xrightarrow{a} \text{alt}(i'_1, i'_2)} \text{alt-delay}$$

The relation from Def.7 resembles those found in process algebra, with the notable exception of rules "seq-right" concerning the seq operator (which involves the pruning predicate) and "alt-delay". Both are inspired by [32] which

deals with graphs of MSCs. Fig.3 illustrates the use of the execution relation \rightarrow on several examples.

The interaction i on Fig.3a illustrates weak sequencing and pruning. Action $i_{|22} = l_2?m_3$ is on the right of a seq , within $i_{|2} = seq(loop_S(i_{|211}), l_2?m_3)$. $i_{|21} = loop_S(i_{|211})$ on its left accepts an execution that do not involve any action on l_2 (because it accepts ε). Hence, $l_2?m_3$ can be executed immediately. But, to do so, the interaction $i_{|21}$ on the left of the seq must be cleaned-up from any action on l_2 . This is the role of the pruning operation in rule "seq-right" of Def.7. Because of the content of $i_{|21}$, this pruning yields the empty interaction. Fig.3a also hints how we leverage interaction execution for NFA generation. This particular example would yield a NFA with 4 states.

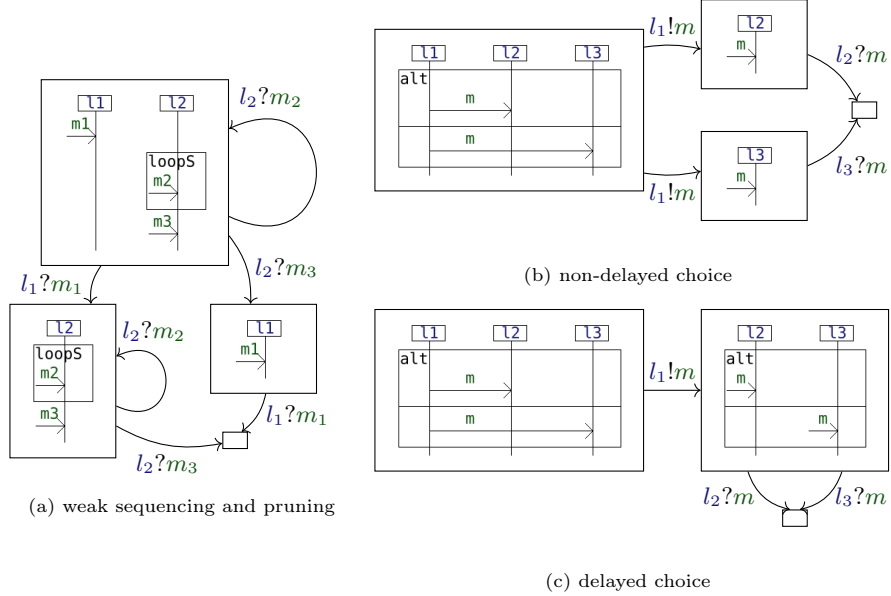

Fig. 3: Executing interactions

There are several trace-equivalent (as opposed to bisimilar) manners to define an operational rule for the non-deterministic choice alt operator. Fig.3b and Fig.3c present two such manners. In [30,29], we have presented the manner described on Fig.3b in which choice of alternative branches is made as soon as possible. In this paper, we rather favor the one described on Fig.3c that is called delayed-choice in [32] as its use will further reduce the number of states of generated NFA.

Definition 8 (Semantics). $\sigma : \mathbb{I} \rightarrow \mathcal{P}(\mathbb{T})$ is defined by:

$$\frac{i \downarrow^L}{\varepsilon \in \sigma(i)} \qquad \frac{t \in \sigma(i') \quad i \xrightarrow{a} i'}{a.t \in \sigma(i)}$$

The predicates from Def.4 and Def.7 enable us to define an operational semantics of interactions in Def.8. The set $\sigma(i)$ of traces of an interaction i contains all (possibly empty) sequences $a_1 a_2 \dots a_k$ of actions such that there exist some execution steps $i_0 \xrightarrow{a_1} i_1, i_1 \xrightarrow{a_2} i_2, \dots, i_{k-1} \xrightarrow{a_k} i_k$ with $i = i_0$ and $i_k \downarrow^L$. In particular, if the sequence is empty, then $i \downarrow^L$ and $\varepsilon \in \sigma(i)$. We note $\xrightarrow{*}$ the reflexive and transitive closure of the execution relation \rightarrow .

Remark 1. The above predicate definitions are consistent in the sense that they are interdependent and complementary. For instance, for any $\ell \subseteq L$, any i in \mathbb{I} , $i \downarrow^\ell$ iff there exists a unique i' in \mathbb{I} s.t. $i \xrightarrow{\ell} i'$. Other such properties can be stated about the operational semantics, but are not essential for the rest of the paper. In the sequel, we will essentially use the rules given in Def.7.

Remark 2. The *par* operator is the most permissive scheduling operator (among *par*, *seq* and *strict*). In other words, whenever $f(i_1, i_2) \xrightarrow{a} i'$ for $f \in \{\text{seq}, \text{strict}\}$, then we have also $\text{par}(i_1, i_2) \xrightarrow{a} i'$. Indeed, all left rules have the same form and thus allow the same derivations while the right rules contain restrictive conditions for *strict* and *seq* (resp. $i_1 \downarrow^L$ for *strict* and $i_1 \xrightarrow{\{\theta(a)\}} i_1'$ for *seq*) but not for *par* and thus allow less derivations by construction.

4 Deriving NFA from interactions

Several works [1,40] propose translations of interactions into automata. In [1], basic Message Sequence Charts (bMSC) are described using partial order relations induced by send-receive pairs and local orders of actions on each lifeline. A bMSC contains a sequence of send-receive pairs and corresponds, in our framework, to a sequence of patterns of the form $\text{strict}(l_1!m, l_2?m)$ arranged with *seq*. bMSC are then combined to form graphs of MSC (MSC-g) in order to support more complex behaviors. Nodes of an MSC-g contain bMSC and its edges, linking two bMSC correspond to a concatenation of the behaviors specified by each. This concatenation can either be interpreted as *strict* or *seq* which resp. corresponds to the synchronous and asynchronous interpretation in [1]. For the synchronous interpretation, the authors of [1] associate NFA to MSC-g by linearizing the partial orders of each bMSC node and by concatenating the resulting NFA (one per node) along the graph edges. Besides, they point out that the problem of building an NFA from an MSC-g with the asynchronous interpretation is undecidable. [40] proceeds in a somewhat similar fashion with UML-SD. Basic SD (only containing message passing and *seq*) are identified within the overall SD and individually transformed into NFA. Those NFA are then composed following the structure of the SD. For this, operators of UML-SD are mapped to operators on NFA. For instance, they map *alt* to NFA union and *loop* to NFA Kleene star (hence it corresponds to our strictly sequential loop loop_S). Because there is no NFA operator equivalent to *seq*, the use of *seq* is restricted to basic SD.

We propose translating any interaction i into an equivalent NFA which states correspond to (sets of) interactions reachable from i and transitions are derived from execution steps $i' \xrightarrow{a} i''$. In our approach, every operator is handled in the same way and hence, unlike [1,40], the *seq* operator can be used above complex operators such as *alt*, *par* or *loops*.

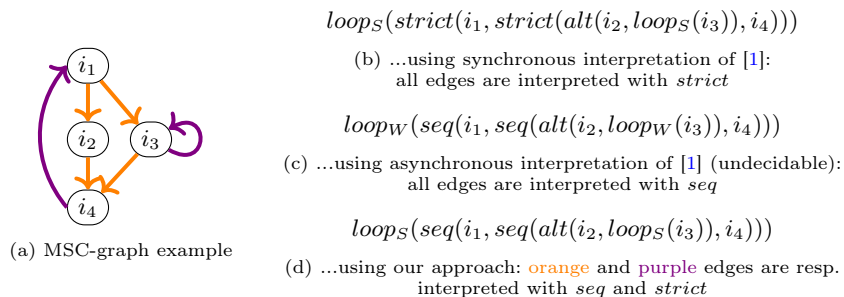

Fig. 4: MSC-graph example and equivalent interactions

Fig.4a provides an example MSC-g built over 4 bMSC. Under the synchronous interpretation of graph edges, we would translate this MSG-g into the interaction term from Fig.4b. If we were to consider the asynchronous interpretation, using the weak sequential loop operator $loop_W$ from [31], we would translate it as the term from Fig.4c. Unlike the former, the latter cannot be translated into a NFA, as stated by the non-decidability result from [1]. However, with our approach, we can provide NFA translation with a greater expressivity, as underlined with the third interpretation of the graph given on Fig.4d. Indeed, using $loop_S$ and seq , we may interpret distinct edges of the graph either synchronously or asynchronously. Moreover, this allows using seq at any scope within the specification, unlike [40] where it must be used within basic SD.

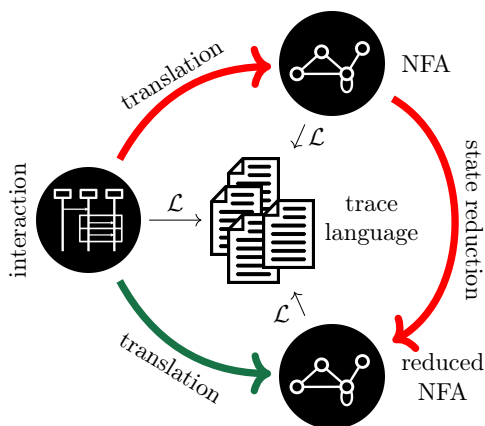

Fig. 5: Translating interactions to NFA

- careless translation then reduction
- translation with care for reduction

With real-world systems, a FA generated from an interaction may become extremely large which may pose several problems e.g. the time required to build it or the space in memory required to store it. State reduction is therefore a pertinent issue. The presence of the *par*, *seq*, *alt* and *loops* operators make behaviors of interactions non-deterministic and cyclic. Hence NFA are more suitable to encode their behaviors. However, the problem of state minimization for NFA is

PSPACE-complete [15]. Various minimization algorithms exist, such as Kameda-Weiner [17] or [35,39]. However they are not scalable, as demonstrated by the search for approximal approaches (i.e., to find reduced but not minimal NFA in a more reasonable time) [5,13,14,10]. Those methods rely either on finding equivalences on states and merging them [14] or via an encoding in SAT [10]. Still, experimental validation is limited to very small NFA (in [10] they consider at most 15 states). Vastly more efficient minimization algorithms exist for strict subset of NFA such as DFA [12] or acyclic automata [6,2]. However, interactions are non-deterministic and cyclic. It is also known that a minimal DFA may have an exponentially larger number of states of that of an equivalent minimal NFA [21]. For instance, given alphabet $\{a, b\}$, the regular expression $(a|b)^*a(a|b)^n$ can be encoded as a NFA with $n+2$ states while an equivalent minimal DFA has 2^{n+1} states. This discussion underlines the importance of considering state reduction during the generation of the NFA itself and not a posteriori, as illustrated in Fig.5.

Our approach for NFA generation is detailed in the following. In Sec.4.1 we prove that the set of interactions reachable by iterating the application of elementary steps $i' \xrightarrow{a} i''$ is finite which enables the construction of a NFA. Then, in Sec.4.2, we explain how we reduce the number of states on the fly (during the generation) by simplifying interactions as they are discovered (using term rewriting). In this way, a reduced NFA can be built right from the start (green arrow of Fig.5).

4.1 Generating an NFA from an interaction

Given an interaction i , the set of interactions reachable from i with the relation \rightarrow is finite. This allows us to define a finite set $reach(i)$ of such terms.

Property 1. For any $i \in \mathbb{I}$, the set $reach(i) = \{i' \mid i \xrightarrow{*} i'\}$ is finite.

Proof. For any interaction $i \in \mathbb{I}$ let us reason by induction on interactions in \mathbb{I} :

- for $i = \emptyset$, $reach(i)$ is reduced to $\{\emptyset\}$ since no rule is applicable.
- for $i = a \in \mathbb{A}$, $reach(i) = \{a, \emptyset\}$ since only rule "act" is applicable and yields $a \xrightarrow{a} \emptyset$.
- for $i = par(i_1, i_2)$, we have $reach(i) = \{par(j_1, j_2) \mid j_1 \in reach(i_1), j_2 \in reach(i_2)\}$. Indeed, the only rules applicable from an interaction of the form $par(i_1, i_2)$ are the rules "par-left" and "par-right". "par-left" (resp. "par-right") replaces the sub-term i_1 (resp. i_2) by a certain i'_1 (resp. i'_2) directly reachable from i_1 (resp. i_2) leading to a term of the form $par(i'_1, i_2)$ (resp. $par(i_1, i'_2)$). The same two rules are again the only ones applicable from these terms so that by applying them several times, successive derivations result in all terms of the form $par(j_1, j_2)$ with j_1 (resp j_2) reachable from i_1 (resp. i_2), i.e. $j_1 \in reach(i_1)$ (resp. $j_2 \in reach(i_2)$). Both $reach(i_1)$ and $reach(i_2)$ are finite by induction and hence $reach(i)$ is also finite.

- for $i = f(i_1, i_2)$ with $f \in \{strict, seq\}$, we have $|reach(i)| \leq |reach(par(i_1, i_2))|$. Indeed, as per Rem.2, the *strict* and *seq* operators enable less interleavings than *par*. Derivations from a term of the form $f(i_1, i_2)$ with $f \in \{strict, seq\}$ lead to terms of the form $f(i'_1, i'_2)$ with the property that the derivation $par(i_1, i_2) \xrightarrow{a} par(i'_1, i'_2)$ also holds. As by hypothesis (previous point), $reach(par(i_1, i_2))$ is finite, $reach(f(i_1, i_2))$ is also finite.
- for $i = alt(i_1, i_2)$, then $reach(i) \subset \{i\} \cup reach(i_1) \cup reach(i_2) \cup \{alt(j_1, j_2) \mid j_1 \in reach(i_1), j_2 \in reach(i_2)\}$. Indeed, a derivation $alt(i_1, i_2) \xrightarrow{a} i'$ comes from either the rule "alt-choice" or the rule "alt-delay":
 - if it comes from the rule "alt-choice", then it means that there is a $k \in \{1, 2\}$ s.t. $i_k \xrightarrow{a} i'$ and $i' \in reach(i_k)$ as well as all the following interactions.
 - if it comes from the rule "alt-delay", then i' is of the form $alt(i'_1, i'_2)$ and, by induction, all continuations are in either $reach(i'_1)$, $reach(i'_2)$ or $\{alt(j_1, j_2) \mid j_1 \in reach(i'_1), j_2 \in reach(i'_2)\}$
 The induction hypothesis implies that both $reach(i_1)$ and $reach(i_2)$ are finite. Hence $reach(i)$ is also finite.
- for $i = loop_S(i_1)$, then $reach(i) = \{i\} \cup \{strict(j_1, i) \mid j_1 \in reach(i_1)\}$. For such terms, only rule "loop" is applicable so that the first derivation (if it exists) results in a term of the form $strict(i'_1, loop_S(i_1))$. From there:
 - if we apply the "strict-left" rule, we obtain a term of the form $strict(i''_1, loop_S(i_1))$ with $i'_1 \xrightarrow{a} i''_1$. With further applications of rule "strict-left", we obtain all terms of the form $strict(j_1, loop_S(i_1))$ with $j_1 \in reach(i_1)$.
 - if we apply "strict-right", it means that $i'_1 \downarrow^L$ and that we have $loop_S(i_1) \xrightarrow{a} strict(i_1^*, loop_S(i_1))$ with $i_1 \xrightarrow{a} i_1^*$ so that we obtain $strict(i'_1, loop_S(i_1)) \xrightarrow{a} strict(i_1^*, loop_S(i_1))$. As i_1^* belongs to $reach(i_1)$, by applying the "strict-right" rule, we find yet again an interaction of the form $strict(j_1, i)$ with $j_1 \in reach(i_1)$.
 Due to the induction hypothesis, $reach(i_1)$ is finite and as a result, $reach(i) = \{i\} \cup \{strict(j_1, i) \mid j_1 \in reach(i_1)\}$ is also finite.

□

Prop.1 defines the set $reach(i)$ of all the interactions that can be reached from i via the execution relation \rightarrow and states that this set is always finite. This enables building an NFA whose recognized language coincides with the set of traces of the interaction i .

Definition 9. For any $i_0 \in \mathbb{I}$, $nfa(i_0) = (\mathbb{A}, Q, q_0, F, \rightsquigarrow)$ is the NFA whose elements are defined by: $Q = reach(i_0)$, $q_0 = i_0$, $F = \{i \mid i \in Q, i \downarrow^L\}$ and $\rightsquigarrow = \{(i, a, i') \mid (i, i') \in Q^2, a \in \mathbb{A}, i \xrightarrow{a} i'\}$.

Def.9 is well founded. Indeed, the set Q is finite according to Prop.1, the subset F of accepting states and the transition relation \rightsquigarrow are defined thanks to predicates \downarrow^L and \rightarrow from Def.4 and Def.7.

Th.1 states the soundness of the translation i.e. that the language recognized by $nfa(i)$ corresponds to the semantics $\sigma(i)$.

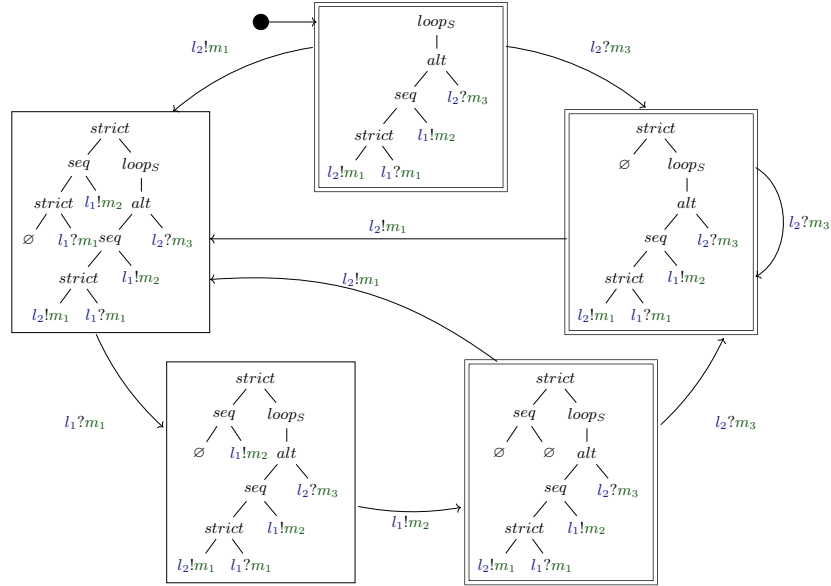

Fig. 6: A Non-deterministic Finite Automaton derived from an interaction

Theorem 1. For any interaction $i \in \mathbb{I}$, we have $\mathcal{L}(nfa(i)) = \sigma(i)$

Proof. The construction of the automaton reflects the construction of the execution tree: there is a transition $i' \xrightarrow{a} i''$ in $nfa(i)$ for each execution step $i' \xrightarrow{a} i''$ issued from i' and reciprocally. As accepting states of $nfa(i)$ coincide with reachable interactions i' verifying $i' \downarrow^L$, then sequences recognized by $nfa(i)$ are traces of i , i.e. we have $\mathcal{L}(nfa(i)) = \sigma(i)$.

On Fig.6, we represent the NFA $nfa(i)$ associated to our example of interaction given in Fig.1 as a diagram and in Fig.2 as a term. We deliberately chose a very simple interaction so that the associated NFA is small and easy to visualize. It contains 5 states which can be uniquely associated with 5 distinct interaction terms (as per Def.9). On Fig.6, we draw this automaton, with each state being represented by a square containing the corresponding interaction term. Squares with doubled delimitations correspond to accepting states and can be determined using the \downarrow^L predicate on the corresponding interaction terms. The initial state is the target of the \bullet .

4.2 On-the-fly simplification of generated NFAs

In most cases, the iterative application of the execution relation \rightarrow creates many useless occurrences of \emptyset in the derived interaction terms. These sub-terms can be removed without the set of traces being modified. For example, because of the rule "strict-right" and of the fact that $\emptyset \downarrow^L$, derivations from $strict(\emptyset, i)$ are exactly those from i . $strict(\emptyset, i)$ and i are said to be semantically equivalent.

The construction of the NFA associated with an interaction can take advantage of considering such semantically equivalent terms. For instance, via the

simplification of useless occurrences of \emptyset , instead of the NFA from Fig.6 we rather obtain the one from Fig.7 which is reduced to 3 states instead of 5. In order to set up these simplification mechanisms, we provide in Def.10 a set R of rewrite rules aimed at eliminating useless occurrences of \emptyset .

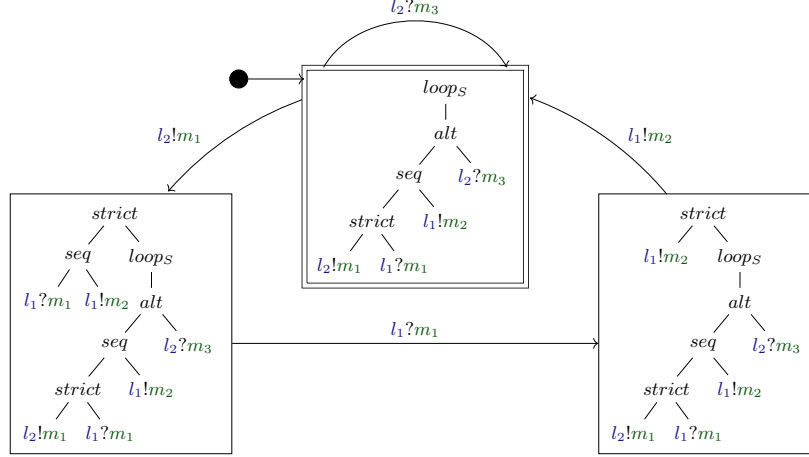

Fig. 7: Simplified NFA

Definition 10. R is the following set of rewrite rules:

$$R = \bigcup_{i \in \mathbb{I}} \left(\begin{array}{l} \cup_{f \in \{\text{strict}, \text{seq}, \text{par}\}} \{f(\emptyset, i) \rightsquigarrow i, f(i, \emptyset) \rightsquigarrow i\} \\ \cup \{\text{alt}(\emptyset, \text{loops}(i)) \rightsquigarrow \text{loops}(i), \text{alt}(\text{loops}(i), \emptyset) \rightsquigarrow \text{loops}(i)\} \\ \cup \{\text{alt}(\emptyset, \emptyset) \rightsquigarrow \emptyset, \text{loops}(\emptyset) \rightsquigarrow \emptyset\} \end{array} \right)$$

These rewrite rules define a TRS \rightarrow_R which is convergent and preserves the semantics σ (as per Prop.2).

Property 2. The TRS characterized by R is convergent and semantically sound i.e. for any $i \in \mathbb{I}$, $\exists! i_s \in \mathbb{I}$ s.t. $i \rightarrow_R^! i_s$ and we have $\sigma(i) = \sigma(i_s)$.

Proof. \rightarrow_R is both terminating and confluent (see automated proof in [28] using the TTT2 [19] and CSI [41] tools) and hence convergent. To prove semantic equivalence it suffices to prove it for interactions related by all $\rightsquigarrow \in R$ which is trivial.

Prop.2 stating that the TRS is convergent, for any $i \in \mathbb{I}$, there exists a unique i_s such that $i \rightarrow_S^! i_s$. With the index s standing for "simplified", we use the notation $_s$ to designate simplified terms. This allows us to consider simplified NFA generation in Def.11.

Definition 11. For any $i_0 \in \mathbb{I}$, $\text{nfa}_s(i_0) = (\mathbb{A}, Q, q_0, F, \rightsquigarrow)$ is the NFA s.t.:
 $Q = \{i_s \in \mathbb{I} \mid i \in \text{reach}(i_0)\}$, $q_0 = i_{0s}$, $F = \{i_s \mid i \in Q, i \downarrow^L\}$ and
 $\rightsquigarrow = \{(i_s, a, i'_s) \mid (i, i') \in \text{reach}(i_0)^2, a \in \mathbb{A}, i \xrightarrow{a} i'\}$

In a few words, $nfa_s(i_0)$ is the quotient NFA of the NFA $nfa(i_0)$ by the equivalence relation on interactions defined by: $i \equiv i'$ iff $i_s = i'_s$. In particular, transitions between two simplified interactions j and j' include all transitions between interactions i and i' verifying $i_s = j$ and $i'_s = j'$. Those results can be generalized for any convergent and semantically sound Term Rewrite System for interactions³. In fact, each node of the generated NFA may rather correspond to an equivalence class of (semantically equivalent) interactions according to a certain equivalence relation which preserves semantics σ .

5 Experiments

We have implemented NFA generation from interactions via the nfa_s function in the tool HIBOU [24]. Simplifications (Def.10) are systematically applied to newly encountered interactions when building the automaton. First, we present experiments on NFA generation and then on their usage in trace analysis. The experiments were performed using an Intel(R) Core(TM)i5-6360U CPU (2.00GHz) with 8GB RAM. Details of the experiments and the artifacts required to reproduce them are available in [27] and [26].

Assessing the reduction of generated NFA. As a first step, to assess the reduced nature of the generated NFA we want to compare its number of states to that of equivalent minimal NFA and DFA. To obtain those we use implementations of resp. the Kameda-Weiner [17] and Brzozowski’s algorithms within the AUTOUR [25] toolbox.

So as to highlight the importance of the NFA formalism w.r.t. DFA, let us consider a digital lock mechanism as a first use case. Encoded as an interaction, it consists of a single lifeline l , which can receive as inputs combinations of a and b characters. To open the lock, we have to enter 6 digits, the first 3 of them forming a specific sequence w , while the last 3 may be random. Once the lock is unlocked, it emits a u message. Hence, given $L = \{l\}$, $M = \{a, b, u\}$ this specification accepts traces corresponding, given alphabet \mathbb{A} , to the following regular expression: $(l?a|l?b)^*.w.(l?a|l?b)^3.l!u$. This system with a single lock can be used to define systems with $n > 1$ locks that communicate. In such systems, a lock l_2 may need several other locks to have been unlocked to start receiving combinations of letters (i.e. a number of $l_2?u$ must occur). For instance, for a system with 2 locks l_1 and l_2 we may have $seq(i_{l_1}, seq(strict(l_1!u, l_1!u), seq(i_{l_2}, l_2!u)))$ where i_{l_1} and i_{l_2} resp. correspond to combinations required to open l_1 and l_2 .

On Fig.8a, we summarize experiments performed on 3 systems with resp. 1 lock, 4 and 8 locks (each example corresponding to a row). The $|Q| nfa_s$, $|Q| min_{NFA}$ and $|Q| min_{DFA}$ columns resp. correspond to the number of states of the generated NFA and equivalent minimal NFA and DFA. The column on their right gives the time required to generate or minimize the FA. We can

³ A more complete sound TRS for interactions, taking advantage of algebraic properties of operators (associativity of *strict*, *seq*, *par*, *alt*, commutativity and reflexivity of *alt* and *par*, idempotency of loops etc.) can be found in [23].

observe that determinization increases the number of states exponentially. NFA minimization yields an NFA with the same number of states for the smaller example and quickly becomes untractable for the larger ones.

	$ Q $ nfa_s	\ominus nfa_s	$ Q $ min_{NFA}	\ominus min_{NFA}	$ Q $ min_{DFA}	\ominus min_{DFA}
1 lock	8	230 μs	8	30s	14	130 μs
4 locks	105	7400 μs	N/A	timeout	312	8000 μs
8 locks	2881	1s	N/A	timeout	16274	2s

(a) Comparing nfa_s with equivalent minimal NFA and DFA

	$ Q $ nfa_s	\ominus nfa_s	$ Q $ $compo$	\ominus $compo$	$ Q $ min_{DFA}	\ominus min_{DFA}
1 lock	8	230 μs	13	370 μs	14	120 μs
4 locks $s\&p$	97	3500 μs	223	7300 μs	298	8100 μs
8 locks $s\&p$	1624	0.38s	5904	0.15s	9374	2.3s

(b) Comparing nfa_s with compositional NFA generation method

Fig. 8: Usecases with networked digital locks

Comparison with compositional NFA generation. In order to compare our approach with those of the literature [1,40], we have also implemented an alternative "compositional" method for NFA generation. It involves **(1)** identifying the maximal "basic interactions" (i.e. with only *strict* and *seq*) sub-terms of an initial interaction i , **(2)** generating a NFA for each one using our approach and **(3)** composing them using NFA operators⁴ depending on the structure of i to obtain a certain $compo(i)$ NFA. As previously discussed in Sec.4, the main limitation of this compositional approach is that i cannot have *seq* outside "basic interactions". In order to use it on our example networks of digital locks, we need to replace the *seq* between the locks with either *strict* or *par*. Doing so requires identifying which locks are executed concurrently and which ones are executed strictly sequentially. In the initial interaction, the *seq* operator does this organically depending on the exchange of u messages between locks. By manually replacing *seq*, we obtain a different specification which expresses a slightly different language. We can then compare both approaches (ours and the compositional) on these new $s\&p$ specifications. Fig.8b presents the results of the comparison. The NFAs obtained via composition have fewer states than the minimal DFAs but still have much more states than the NFA obtained via nfa_s .

Distributed system use cases and trace analysis. In the following, we experiment the benefits of using generated NFA for trace analysis. In this context, trace analysis simply corresponds to assessing whether or not a trace $t \in \mathbb{T}$ belongs to the semantics $\sigma(i)$ of an interaction i . In previous works [30], we used interactions directly to perform trace analysis. Indeed, the relation \rightarrow allows trying to reenact a trace t from an initial i , and, if this is possible, then $t \in \sigma(i)$. Using a generated NFA simply corresponds to trying to read the word in the NFA. The

⁴ concatenation, union, Kleene and parallel composition

major difference is that this equates to using pre-calculated interaction terms (the reachable interactions) instead of computing them as needed.

	NFA		Traces		Rates in $a.s^{-1}$			
	$ Q $	\ominus	T	t sizes	\ominus i ✓	\ominus nfa_s ✓	\ominus i ✗	\ominus nfa_s ✗
ABP [32]	68	7300 μs	80	[250; 10000]	24000	413000	20000	407000
Platoon [3]	90	2900 μs	40	[250; 5000]	98000	430000	87000	325000
HR [20]	101	4300 μs	40	[250; 5000]	53000	440000	timeout	351000

Fig. 9: Trace analysis using either interaction directly or generated NFA

Fig. 9 summarises experiments conducted on some interactions taken from the literature: a modelization of the Alternating Bit Protocol [32], a connected platoon of autonomous Rovers [3] and a DApp system for managing Human-Resources [20]. Each use case corresponds to a row on Fig. 9. The second and third columns give the number of states of the generated NFA and the time required to compute it. For each use case, we have generated a number of accepted traces and an equal number of error traces. Column T gives this number while column t gives the minimal and maximal size of generated traces. For each accepted trace (resp. error trace), both the interaction and NFA methods (respectively denoted as i and nfa_s) return a *Pass* (resp. *Fail*) verdict. The last four columns of the table correspond to rates (in actions per second) associated with the analysis of traces using either method on either accepted (✓) or error (✗) traces. As might be expected, empirical evidence goes in favor of using generated NFA for trace analysis. For some long error traces in the HR usecase [20] analysis using interactions may even timeout. Plotting the data reveals that, with the method from [30] the average rate decreases with the length of traces while this is not the case for the NFA-based method. However, let us keep in mind that not all interactions can be translated into NFA (in this paper we use a subset of the language from [31]).

6 Some comments and related work

Complexity of NFA generation. The size of NFA generated from basic interactions (with only *seq* and message passing via *strict*) is, in the worst case, $O(n^k)$ where n is the number of message passing patterns and k is the number of lifelines [1,40,34,9]. Such interactions resembles basic MSC [1,40] or regular expressions with interleaving over finite words [34]. The witness interaction $par(l_1!m, par(\dots, l_n!m) \dots)$ consisting of the interleaving of n distinct atomic actions accepts as traces all possible interleavings of those n actions. Any NFA associated to it must have at least 2^n states. Hence, the cost of NFA generation with *par* is $\Omega(2^n)$, which relates to results established for regular expressions with interleaving [34,9].

Repetition and boundedness. In [31], we considered three repetition operators: $loop_S$ which is included in this work but also $loop_W$ and $loop_P$ which correspond

to the Kleene closures of resp. the weak sequential operator seq and the interleaving operator par . These loops are problematic for the definition of a translation towards NFA. Indeed, in contrast to $loop_S$, with either $loop_W$ or $loop_P$, it is possible that arbitrarily many instances of the loop are active at the same time (i.e. have started but have not yet been entirely executed). Fig.10a illustrates this with a $loop_W$ which enables several instances of messages m to be sent by l_1 consecutively without any being received by l_2 . That is $\sigma(i)$ is the set of words w in $\{a = l_1!m, b = l_2?m\}^*$ verifying $|w|_a = |w|_b$ and for all prefixes u of w , $|u|_a \geq |u|_b$. One can state that there does not exist an NFA recognizing this language which follows from a pumping lemma as observed in [22]. Another manner to consider $loop_W$ would be to restrict to a subclass of "bounded interactions" in the same fashion as "bounded MSC graphs" [37,11,1,22] (see also process divergence in [4]) as illustrated in Fig.10b. Here, because lifeline l_1 must wait for the reception of m_2 before being able to emit a second instance of message m_1 , there are only 4 distinct global states in which the system may be. Consequently, at most 1 message can be in transit between l_1 and l_2 . Boundedness [37,11,1] generalizes this observation, characterizing MSC graphs in which there can only be a finite amount of "buffered" messages in transit between any two lifelines. Note that deciding boundedness comes at some computational cost (NP-hard, see [37]).

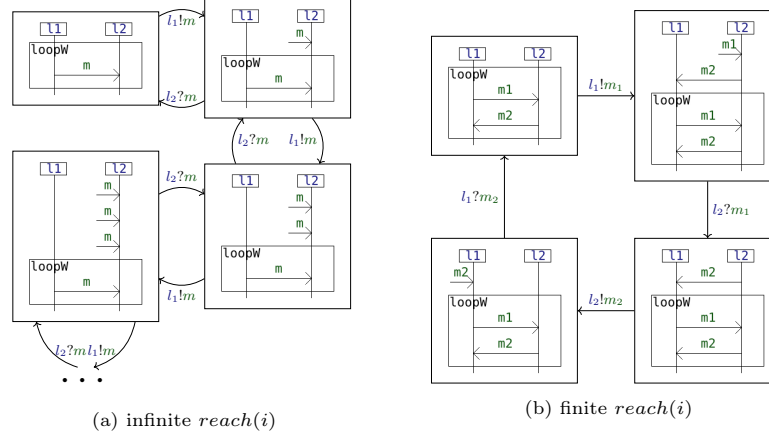

Fig. 10: Boundedness with weak sequential loop

Automata and trace analysis. Automata are extensively used in Runtime Verification (RV) for trace analysis. However, they are mostly generated from logics such as Linear Temporal Logic (LTL) [7,16,18] rather than interaction models. [7] has focused on generating automata monitors that recognize the minimal bad prefixes of ω -languages (sets of infinite traces). These monitors are created by reducing Büchi Automata into Binary Transition Tree Finite State Machines (BTT-FSM). Finite trace analysis against the generated FSM is performed online (as can we using our generated NFA). Overall, automata are preferred in

RV due to their compact form, efficient memory usage, and faster processing. They offer various analysis possibilities, particularly for Distributed Systems (DS) dealing with unreliable communication channels [18] or lossy traces due to network-related issues [16].

7 Conclusion

We have proposed an approach for generating Non-deterministic Finite Automata (NFA) from Interactions. It employs operational unfolding and term simplification techniques in the style of process rewrite systems to generate concise NFA on-the-fly. We have validated our approach through proofs and experiments with several interactions from the literature, showcasing the generated NFA reduced quality (no need for costly NFA reduction machinery) and their suitability for trace analysis.

References

1. Alur, R., Yannakakis, M.: Model checking of message sequence charts. In: Baeten, J.C.M., Mauw, S. (eds.) CONCUR '99: Concurrency Theory, 10th International Conference, Eindhoven, The Netherlands, August 24-27, 1999, Proceedings. Lecture Notes in Computer Science, vol. 1664, pp. 114–129. Springer (1999). https://doi.org/10.1007/3-540-48320-9_10
2. Amilhastre, J., Janssen, P., Vilarem, M.C.: Fa minimisation heuristics for a class of finite languages. In: Boldt, O., Jurgensen, H. (eds.) Automata Implementation. pp. 1–12. Springer Berlin Heidelberg, Berlin, Heidelberg (2001)
3. Andre, M., Philippe, M., Sebastien, D., Vivek, N., Henrik, P., Arnold, S., Eren, C., Sfetsos, T., Victor, J., Estibaliz, A., Cristina, M., Angel, L., Joaquin, G.A., Mariana, S., Jose, R.H., Gregory, B., Herve, D., Roberto, C., Silvio, R., Luca, V., Marco, S.B., Artsiom, Y., Andrea, M., Jacques, K., Tegawende, B., Jordan, S.: Assessment specifications and roadmap. In: EC (ed.) Technical report. SPARTA project (2020)
4. Ben-Abdallah, H., Leue, S.: Syntactic detection of process divergence and non-local choice in message sequence charts. In: Brinksma, E. (ed.) Tools and Algorithms for the Construction and Analysis of Systems. pp. 259–274. Springer Berlin Heidelberg, Berlin, Heidelberg (1997)
5. Champarnaud, J.M., Coulon, F.: Nfa reduction algorithms by means of regular inequalities. In: Esik, Z., Fulop, Z. (eds.) Developments in Language Theory. pp. 194–205. Springer Berlin Heidelberg, Berlin, Heidelberg (2003)
6. Daciuk, J., Watson, B.W., Mihov, S., Watson, R.E.: Incremental construction of minimal acyclic finite-state automata. *Comput. Linguist.* **26**(1), 3–16 (mar 2000). <https://doi.org/10.1162/089120100561601>
7. d’Amorim, M., Rosu, G.: Efficient monitoring of omega-languages. In: Etessami, K., Rajamani, S.K. (eds.) Computer Aided Verification, 17th International Conference, CAV 2005, Edinburgh, Scotland, UK, July 6-10, 2005, Proceedings. Lecture Notes in Computer Science, vol. 3576, pp. 364–378. Springer (2005). https://doi.org/10.1007/11513988_36
8. Dershowitz, N., Jouannaud, J.P.: Rewrite Systems, p. 243–320. MIT Press, Cambridge, MA, USA (1991)

9. Gelade, W.: Succinctness of regular expressions with interleaving, intersection and counting. *Theor. Comput. Sci.* **411**(31-33), 2987–2998 (2010). <https://doi.org/10.1016/j.tcs.2010.04.036>, <https://doi.org/10.1016/j.tcs.2010.04.036>
10. Geldenhuys, J., van der Merwe, B., van Zijl, L.: Reducing nondeterministic finite automata with sat solvers. In: Yli-Jyra, A., Kornai, A., Sakarovitch, J., Watson, B. (eds.) *Finite-State Methods and Natural Language Processing*. pp. 81–92. Springer Berlin Heidelberg, Berlin, Heidelberg (2010)
11. Henriksen, J.G., Mukund, M., Kumar, K.N., Sohoni, M.A., Thiagarajan, P.S.: A theory of regular MSC languages. *Inf. Comput.* **202**(1), 1–38 (2005). <https://doi.org/10.1016/j.ic.2004.08.004>
12. Hopcroft, J.E.: An $n \log n$ algorithm for minimizing states in a finite automaton. Tech. rep., Stanford, CA, USA (1971)
13. Ilie, L., Navarro, G., Yu, S.: On NFA Reductions, pp. 112–124. Springer Berlin Heidelberg, Berlin, Heidelberg (2004). https://doi.org/10.1007/978-3-540-27812-2_11
14. Ilie, L., Yu, S.: Algorithms for computing small nfacs. In: Diks, K., Rytter, W. (eds.) *Mathematical Foundations of Computer Science 2002*. pp. 328–340. Springer Berlin Heidelberg, Berlin, Heidelberg (2002)
15. Jiang, T., Ravikumar, B.: Minimal nfa problems are hard. In: Albert, J.L., Monien, B., Artalejo, M.R. (eds.) *Automata, Languages and Programming*. pp. 629–640. Springer Berlin Heidelberg, Berlin, Heidelberg (1991)
16. Joshi, Y., Tchamgoue, G.M., Fischmeister, S.: Runtime verification of LTL on lossy traces. In: Seffah, A., Penzenstadler, B., Alves, C., Peng, X. (eds.) *Proceedings of the Symposium on Applied Computing, SAC 2017, Marrakech, Morocco, April 3-7, 2017*. pp. 1379–1386. ACM (2017). <https://doi.org/10.1145/3019612.3019827>
17. Kameda, T., Weiner, P.: On the state minimization of nondeterministic finite automata. *IEEE Transactions on Computers* **C-19**(7), 617–627 (1970). <https://doi.org/10.1109/T-C.1970.222994>
18. Kauffman, S., Havelund, K., Fischmeister, S.: Monitorability over unreliable channels. In: Finkbeiner, B., Mariani, L. (eds.) *Runtime Verification - 19th International Conference, RV 2019, Porto, Portugal, October 8-11, 2019, Proceedings. Lecture Notes in Computer Science*, vol. 11757, pp. 256–272. Springer (2019). https://doi.org/10.1007/978-3-030-32079-9_15
19. Korp, M., Sternagel, C., Zankl, H., Middeldorp, A.: Tyrolean termination tool 2. In: Treinen, R. (ed.) *Rewriting Techniques and Applications*. pp. 295–304. Springer Berlin Heidelberg, Berlin, Heidelberg (2009)
20. Lallai, G., Pinna, A., Marchesi, M., Tonelli, R.: Software engineering for dapp smart contracts managing workers contracts (03 2020)
21. Leiss, E.: Succinct representation of regular languages by boolean automata. *Theoretical Computer Science* **13**(3), 323–330 (1981). [https://doi.org/10.1016/S0304-3975\(81\)80005-9](https://doi.org/10.1016/S0304-3975(81)80005-9)
22. Madhusudan, P., Meenakshi, B.: Beyond message sequence graphs. In: Hariharan, R., Mukund, M., Vinay, V. (eds.) *FST TCS 2001: Foundations of Software Technology and Theoretical Computer Science, 21st Conference, Bangalore, India, December 13-15, 2001, Proceedings. Lecture Notes in Computer Science*, vol. 2245, pp. 256–267. Springer (2001). https://doi.org/10.1007/3-540-45294-X_22, https://doi.org/10.1007/3-540-45294-X_22
23. Mahe, E.: An operational semantics of interactions for verifying partially observed executions of distributed systems. Theses, Université Paris-Saclay (Jul 2021), <https://theses.hal.science/tel-03369906>

24. Mahe, E.: Hibou tool. github.com/erwanM974/hibou_label (2022)
25. Mahe, E.: Autour toolbox. github.com/erwanM974/autour_core (2023)
26. Mahe, E.: experiments with generated nfa trace analysis. github.com/erwanM974/hibou_nfa_trace_analysis (2023)
27. Mahe, E.: experiments with nfa generation. github.com/erwanM974/hibou_nfa_generation (2023)
28. Mahe, E.: proof of convergence for interaction simplification. github.com/erwanM974/hibou_trs_simplify_empty (2023)
29. Mahe, E., Bannour, B., Gaston, C., Lapitre, A., Le Gall, P.: A small-step approach to multi-trace checking against interactions. In: Proceedings of the 36th Annual ACM Symposium on Applied Computing. p. 1815–1822. SAC '21, Association for Computing Machinery, New York, NY, USA (2021). <https://doi.org/10.1145/3412841.3442054>
30. Mahe, E., Gaston, C., Le Gall, P.: Revisiting semantics of interactions for trace validity analysis. In: Wehrheim, H., Cabot, J. (eds.) *Fundamental Approaches to Software Engineering*. pp. 482–501. Springer International Publishing, Cham (2020)
31. Mahe, E., Gaston, C., Le Gall, P.: Equivalence of denotational and operational semantics for interaction languages. In: Ameer, Y.A., Craciun, F. (eds.) *Theoretical Aspects of Software Engineering - 16th International Symposium, TASE 2022, Cluj-Napoca, Romania, July 8-10, 2022, Proceedings*. Lecture Notes in Computer Science, vol. 13299, pp. 113–130. Springer (2022). https://doi.org/10.1007/978-3-031-10363-6_8
32. Mauw, S., Reniers, M.A.: High-level message sequence charts. In: *SDL '97 Time for Testing, SDL, MSC and Trends - 8th International SDL Forum, Proceedings*. pp. 291–306. Elsevier (1997)
33. Mauw, S., Reniers, M.A.: Operational semantics for msc'96. *Computer Networks* **31**(17), 1785–1799 (1999). [https://doi.org/10.1016/S1389-1286\(99\)00060-2](https://doi.org/10.1016/S1389-1286(99)00060-2)
34. Mayer, A., Stockmeyer, L.: The complexity of word problems - this time with interleaving. *Information and Computation* **115**(2), 293–311 (1994). <https://doi.org/https://doi.org/10.1006/inco.1994.1098>, <https://www.sciencedirect.com/science/article/pii/S0890540184710984>
35. Melnikov, B.F.: A new algorithm of the state-minimization for the nondeterministic finite automata. *Korean Journal of Computational and Applied Mathematics* p. 277–290 (may 1999). <https://doi.org/10.1007/BF03014374>
36. Micskei, Z., Waeselynck, H.: The many meanings of uml 2 sequence diagrams: a survey. *Software & Systems Modeling* **10**(4), 489–514 (2011)
37. Muscholl, A., Peled, D.A., Su, Z.: Deciding properties for message sequence charts. In: Nivat, M. (ed.) *Foundations of Software Science and Computation Structure, First International Conference, FoSSaCS'98, Held as Part of the European Joint Conferences on the Theory and Practice of Software, ETAPS'98, Lisbon, Portugal, March 28 - April 4, 1998, Proceedings*. Lecture Notes in Computer Science, vol. 1378, pp. 226–242. Springer (1998). <https://doi.org/10.1007/BFb0053553>, <https://doi.org/10.1007/BFb0053553>
38. Plotkin, G.: A structural approach to operational semantics. *The Journal of Logic and Algebraic Programming* **60-61**, 17–139 (07 2004). <https://doi.org/10.1016/j.jlap.2004.05.001>
39. Polak, L.: Minimalizations of nfa using the universal automaton. In: *Proceedings of the 9th International Conference on Implementation and Application of Automata*. p. 325–326. CIAA'04, Springer-Verlag, Berlin, Heidelberg (2004). https://doi.org/10.1007/978-3-540-30500-2_37

40. Simmonds, J., Gan, Y., Chechik, M., Nejati, S., O'Farrell, B., Litani, E., Waterhouse, J.: Runtime monitoring of web service conversations. *IEEE Trans. Serv. Comput.* **2**(3), 223–244 (2009). <https://doi.org/10.1109/TSC.2009.16>
41. Zankl, H., Felgenhauer, B., Middeldorp, A.: Csi – a confluence tool. In: Bjørner, N., Sofronie-Stokkermans, V. (eds.) *Automated Deduction – CADE-23*. pp. 499–505. Springer Berlin Heidelberg, Berlin, Heidelberg (2011)

A Details on the NFA generation experiments

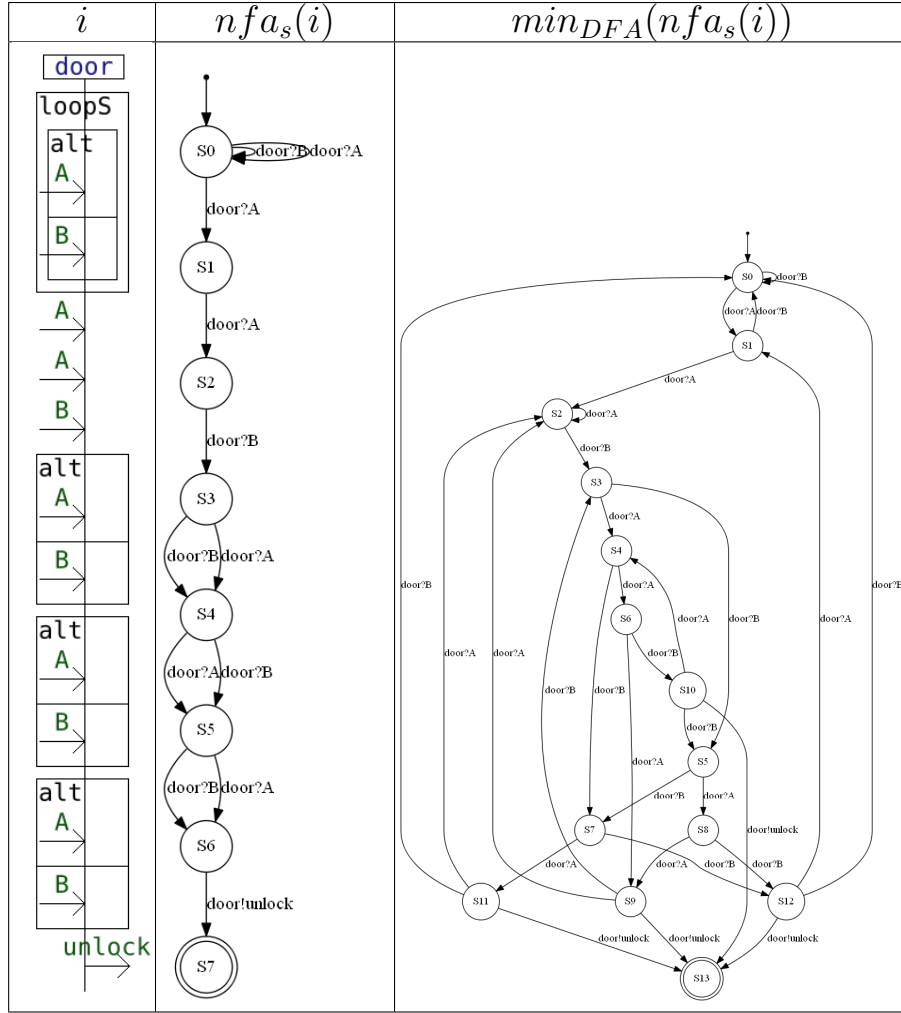

Fig. 11: Example with a single digital lock

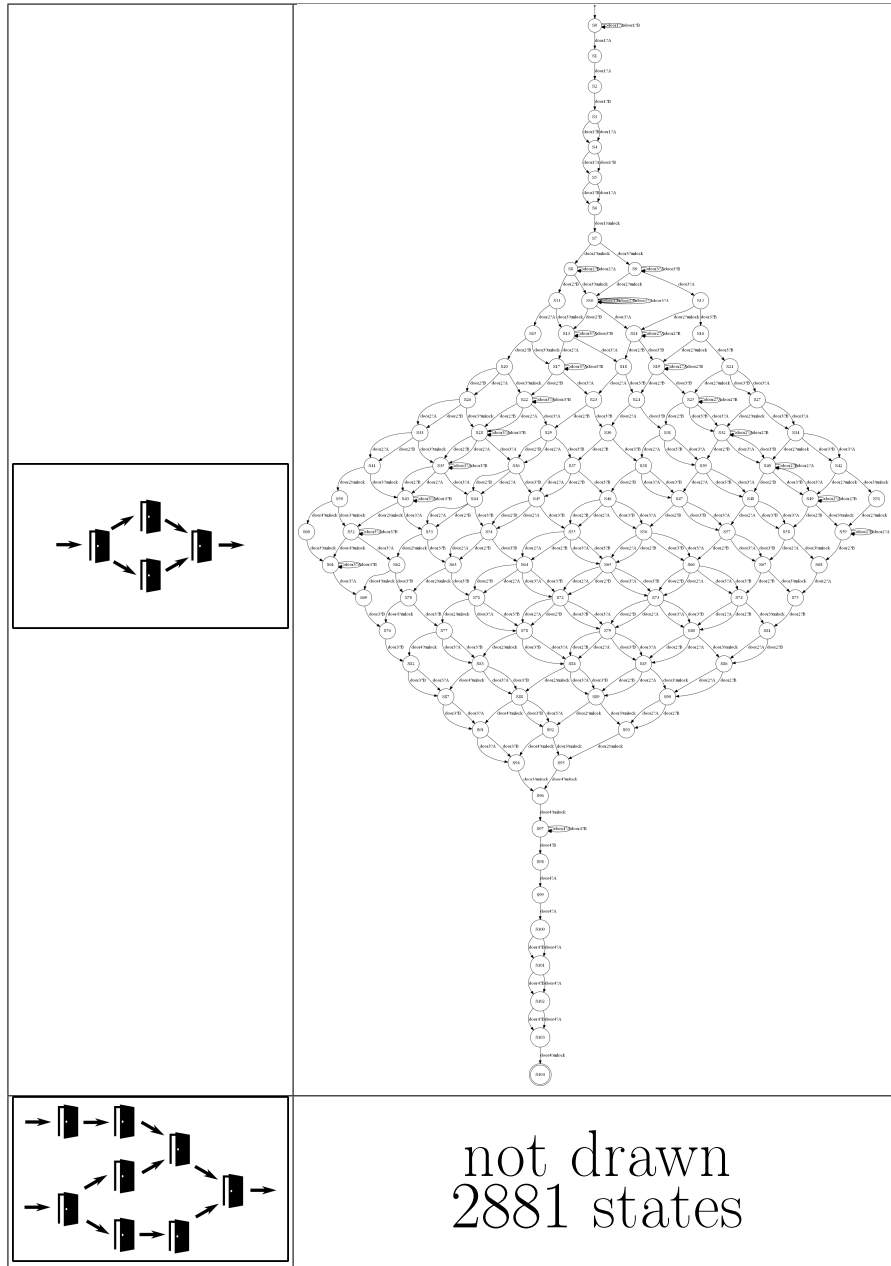

Fig. 12: NFA generated from more complex networks of digital locks

Number of locks	$nfa_S(i)$	$compo(i)$
1		
4 <i>s&p</i>		

Fig. 13: Comparison of NFA generated from lock networks only containing *strict* and *par* using our method and a compositional method.

B Details on the trace analysis experiments

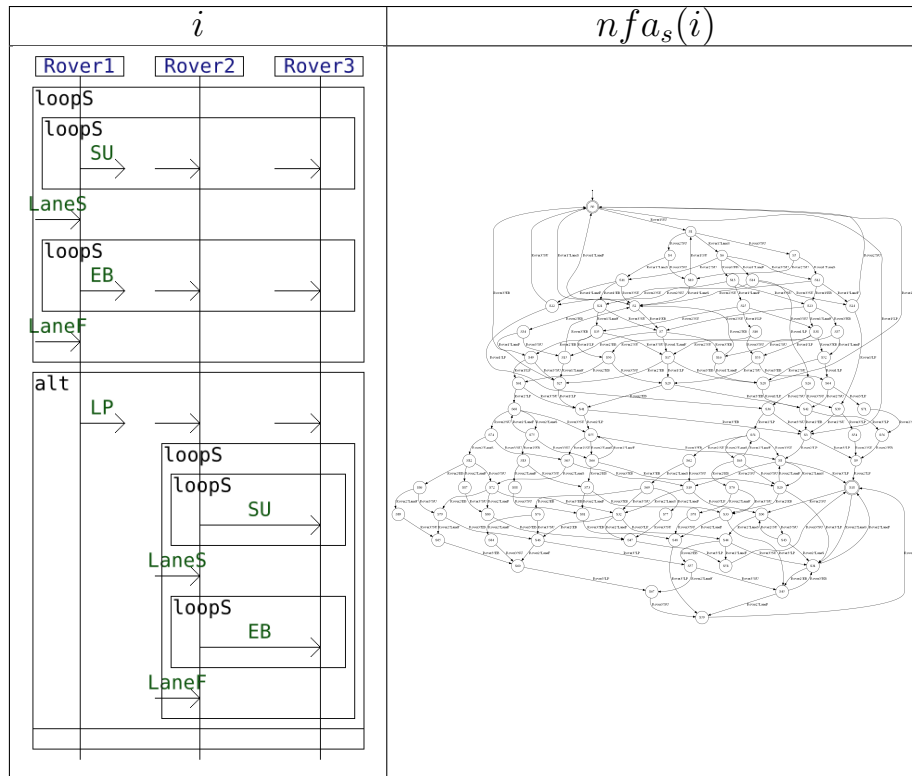

Fig. 14: Platoon [3] usecase

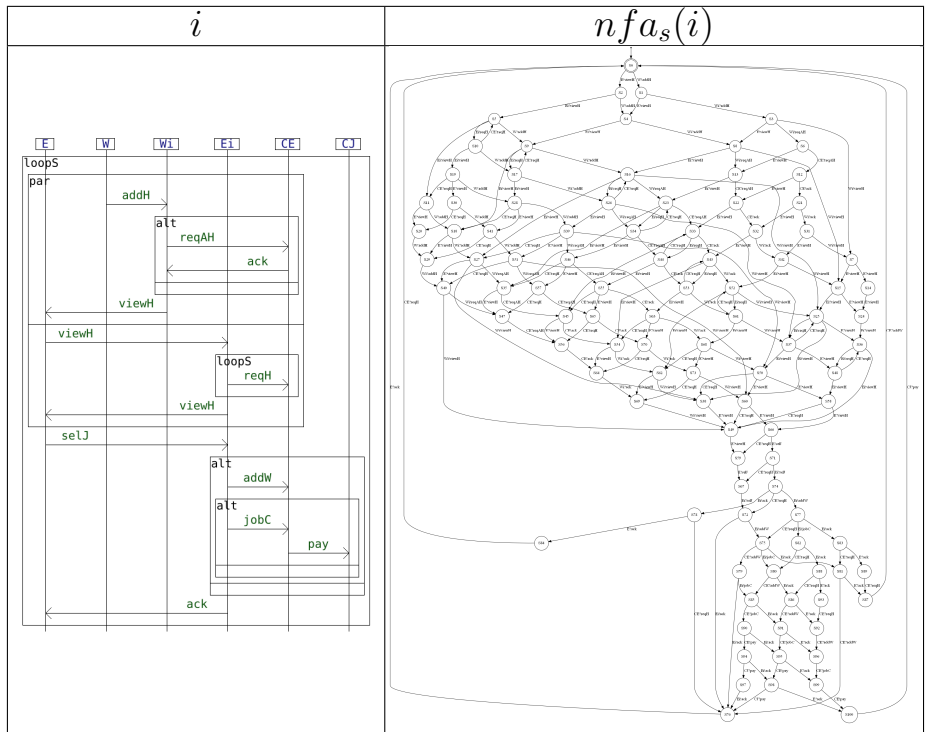

Fig. 15: Human Resources [20] usecase

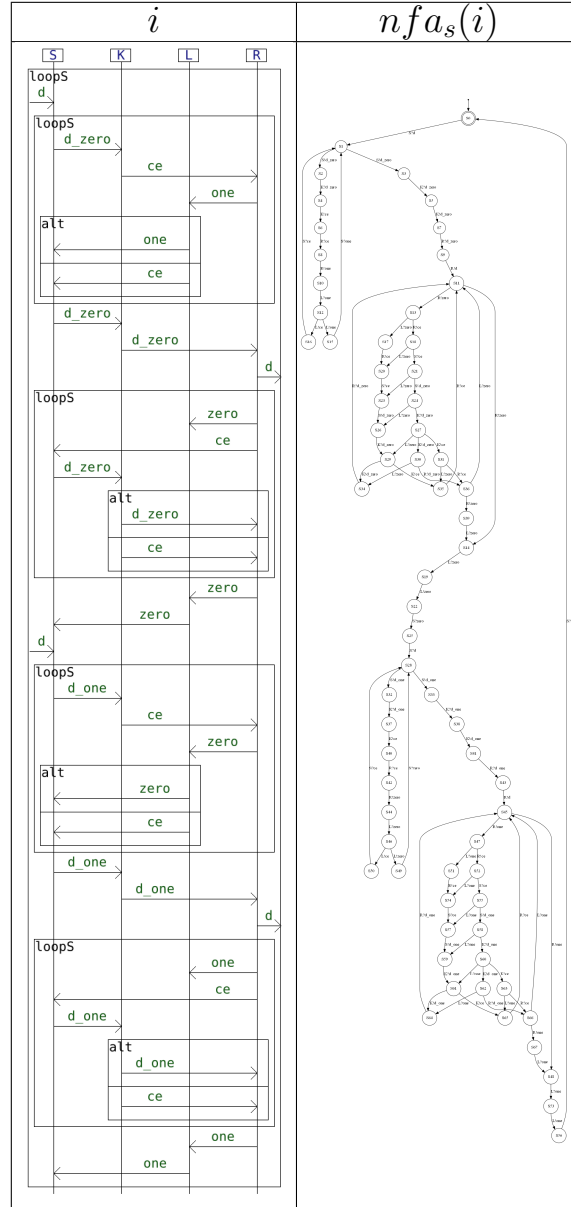

Fig. 16: Alternating Bit Protocol [32] usecase

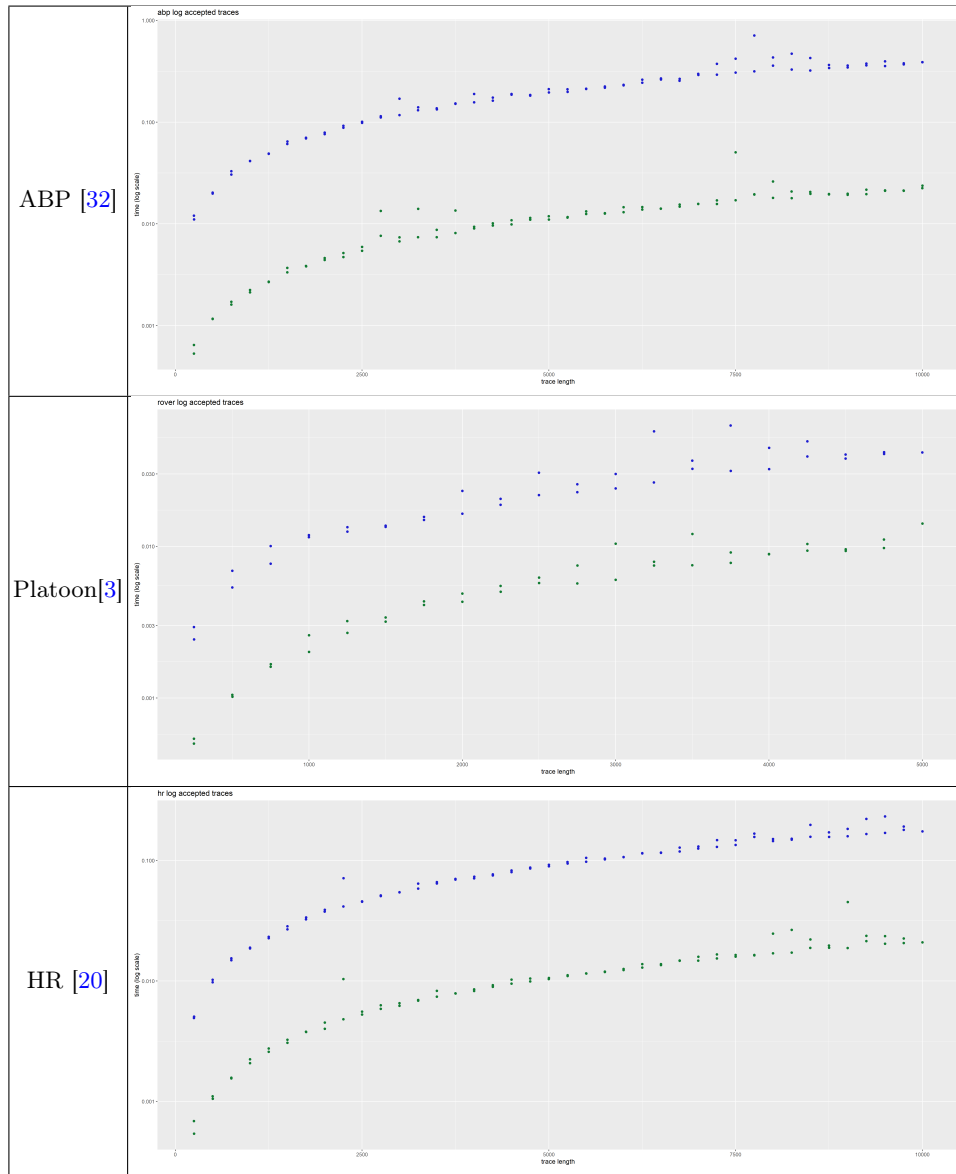

Fig. 17: Results for accepted traces (LOG scale)

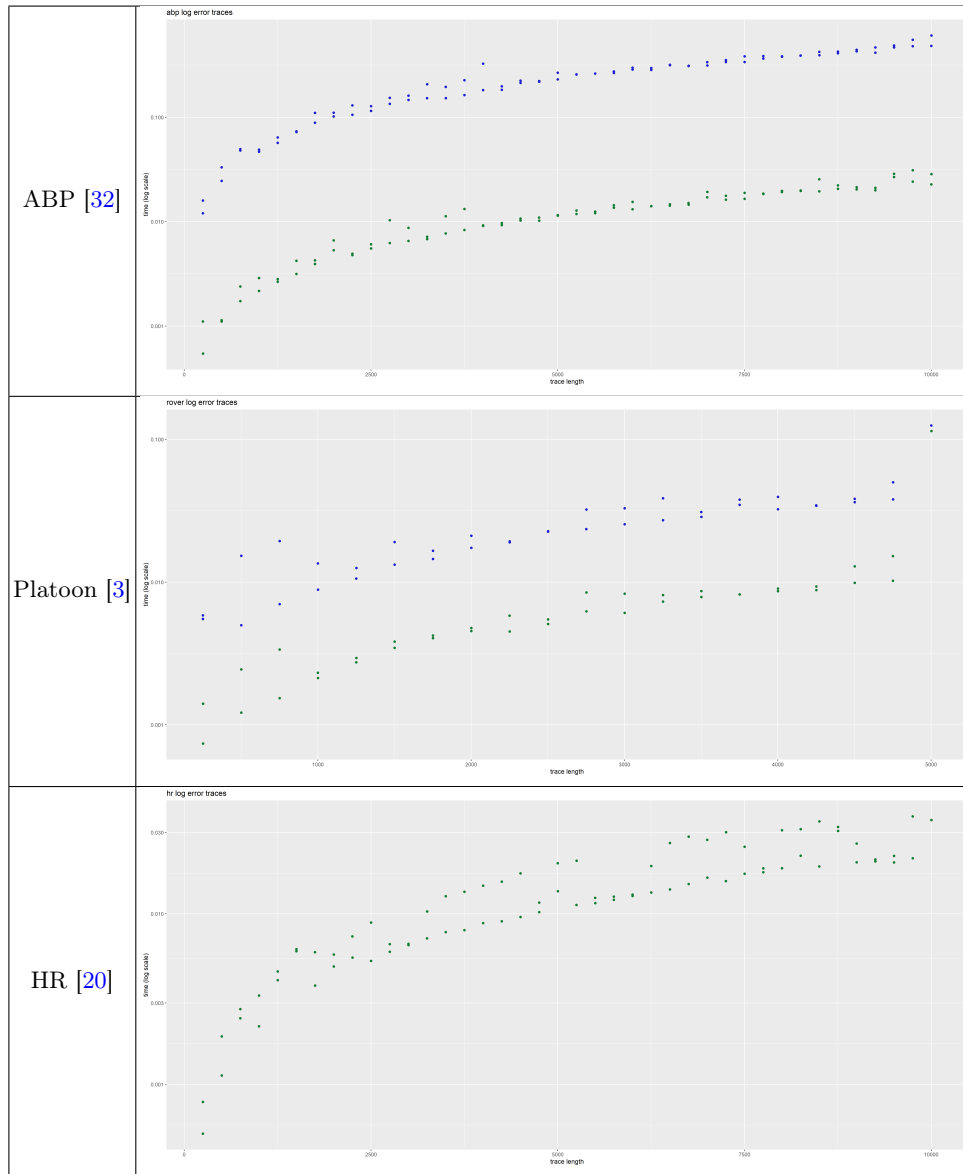

Fig. 18: Results for error traces (LOG scale)