

Automatic Synthesis of Low-Complexity Translation Operators for the Fast Multipole Method

Isuru Fernando and Andreas Klöckner

May 30, 2023

Abstract

We demonstrate a new, hybrid symbolic-numerical method for the automatic synthesis of all families of translation operators required for the execution of the Fast Multipole Method (FMM). Our method is applicable in any dimensionality and to any translation-invariant kernel. The Fast Multipole Method, of course, is the leading approach for attaining linear complexity in the evaluation of long-range (e.g. Coulomb) many-body interactions. Low complexity in translation operators for the Fast Multipole Method (FMM) is usually achieved by algorithms specialized for a potential obeying a specific partial differential equation (PDE). Absent a PDE or specialized algorithms, Taylor series based FMMs or kernel-independent FMM have been used, at asymptotically higher expense.

When symbolically provided with a constant-coefficient elliptic PDE obeyed by the potential, our algorithm can automatically synthesize translation operators requiring $O(p^d)$ operations, where p is the expansion order and d is dimension, compared with $O(p^{2d})$ operations in a naive approach carried out on (Cartesian) Taylor expansions. This is achieved by using a compression scheme that asymptotically reduces the number of terms in the Taylor expansion and then operating directly on this “compressed” representation. Judicious exploitation of shared subexpressions permits formation, translation, and evaluation of local and multipole expansions to be performed in $O(p^d)$ operations, while an FFT-based scheme permits multipole-to-local translations in $O(p^{d-1} \log(p))$ operations. We demonstrate computational scaling of code generation and evaluation as well as numerical accuracy through numerical experiments on a number of potentials from classical physics.

1 Introduction

The Fast Multipole Method (FMM) [Greengard and Rokhlin, 1987] is an algorithm to attain linear complexity (in the number of “source” and “target” or “observation” points) in the evaluation of a many-body potential

$$\phi(\mathbf{x}) = \sum_{\mathbf{y} \in S} G(\mathbf{x} - \mathbf{y})w(\mathbf{y}), \quad (\mathbf{x} \in T), \quad (1)$$

where $S \subset \mathbb{R}^d$ is a set of source particles and $T \subset \mathbb{R}^d$ a set of target particles, $G : \mathbb{R}^d \rightarrow \mathbb{C}^d$ is a kernel, and w is a density function. As a computational primitive, the FMM has proven crucial in molecular dynamics, particle-based gravitational simulation as well as as a building block of solvers for boundary value problems of elliptic partial differential equations based on boundary and volume integral equations, cf. [Chew et al., 2008] for example.

The FMM proceeds by expanding the far-field of the potential in “local” and “multipole” expansions that are nested recursively along a quad- or octree in a box geometry. To ensure accuracy of the expansion (resulting from the smoothness of the far-field), all expansions are only used away from their source geometries, where multipoles attain accuracy away from their expansion center, while local expansions (much like conventional Taylor expansions) attain accuracy close to their center.

Common types of expansions for multipoles and locals include spherical harmonic series, complex Laurent series, or Taylor series.

Greengard and Rokhlin [1987] introduced a (non-adaptive) FMM algorithm for the Laplace equation in two dimensions, using a complex-valued Laurent series for expressing the Coulomb potential $\log(R)$ where R is the distance between the target and the source point. The expansions for this scheme have $O(p)$ terms and translations cost $O(p^2)$ operations where p is the order of the expansion. Greengard [1988] extended the FMM to three-dimensional Laplace equation using a spherical harmonic series which has $O(p^2)$ terms in the expansion and allows translations that cost $O(p^4)$ operations. Greengard and Rokhlin [1988] improved on the FMM by reducing the cost of translations to $O(p \log(p))$ for two dimensions and to $O(p^2 \log(p))$ for three dimensions using a Fast Fourier Transform (FFT). Greengard and Huang [2002] introduced an $O(p^3)$ algorithm for the three-dimensional Yukawa equation based on spherical harmonic expansions by converting to plane wave expansions before translations to achieve a better time complexity.

To remedy the kernel-specific nature of prior developments, Ying et al. [2004] introduced a kernel-independent FMM algorithm. The kernel-independent FMM works for a broad class of potentials without needing kernel-specific translation operators to be supplied, unlike prior approaches based on spherical harmonics or plane-wave-based expansions. The algorithm likewise uses a Fast Fourier Transform, but uses asymptotically more terms in each expansion than the algorithm in [Greengard and Rokhlin, 1988] (by a factor of $O(p)$), and therefore is a $O(p^3 \log(p))$ algorithm in three dimensions.

FMM variants based on Taylor series have been developed in two and three dimensions. Zhao [1987] gives an algorithm for the three-dimensional Laplace equation, where each expansion has $O(p^3)$ terms and a translation costs $O(p^6)$. The cost of the translations for Taylor series-based expansions is an obstacle for widespread usage. Ooppelstrup [2013] uses common subexpression elimination (via a computer algebra system) to reduce the cost from $O(p^6)$ to an (empirically obtained) $O(p^{4.5})$. Shanker and Huang [2007] give a Taylor series-based algorithm with a multipole-to-local translations cost of $O(p^4)$ for kernels of the form $R^{-\nu}$ ($\nu \in \mathbb{R}$). This includes the three-dimensional Laplace problem at $\nu = 1$. This algorithm re-writes translation operations as tensor computations and uses tensor contraction algorithms. Coles and Bieri [2020] extend Shanker and Huang’s work coupled with common subexpression elimination to reduce the cost of multipole-to-local translation to $O(p^{3.6})$ empirically.

One advantage of methods based on Taylor series is that they can be easily generalized to arbitrary kernels. In order to do that, partial derivatives of the kernel have to be obtained, which can be both numerically subtle and computationally inconvenient. Tausch [2003] proposes an algorithm to calculate the derivatives using a recurrence formula for all radially symmetric kernels given that all radial derivatives are known and gives formulae for the radial derivatives for (free-space) Green’s functions of the Laplace equation, the Helmholtz equation, as well as the equations of linear elasticity and Stokes flow. Zhang and Berz [2011] use a differential algebra framework for calculating the derivatives. Coles and Bieri [2020] use a symbolic algebra framework to calculate the derivatives. While each of these latter methods is aimed at a generalization of the FMM, their approach to expansion and translation does not yield low complexity competitive with the manually-derived approaches described above. Specifically, they use expansions with $O(p^d)$ coefficients, and some of the translations require $O(p^{2d})$ work.

In this paper, we present, to the best of our knowledge, the first comprehensive black-box toolchain for the synthesis of Fast Multipole Methods for general kernels that attains complexities competitive with manually-derived approaches, from limited amounts of user-provided information. Our method provably attains the same order of truncation error as other state-of-the-art methods in the literature. The complexity of our approach decreases as more information is made available by the user.

- With only a symbolic expression of the kernel, our method requires $O(p^d)$ terms in the expansion. It attains $O(p^d \log p)$ cost of a multipole-to-local translation (with $O(p^{d+1})$ offline precomputation cost), and no higher than $O(p^{d+1})$ cost for other translations, assuming a derivative of any given order can be computed at amortized $O(p)$ cost.

- Given a symbolic form of an elliptic constant-coefficient partial differential equation satisfied by the potential, our method requires $O(p^{d-1})$ terms in the expansion. It attains $O(p^{d-1} \log p)$ cost of a multipole-to-local translation (with $O(p^d)$ offline precomputation cost), and no higher than $O(p^d)$ cost for other translations, again assuming a derivative of any given order can be computed at amortized $O(p)$ cost.
- Given the PDE *and* an evaluation formula for the derivatives of the kernel that yields $O(p^{d-1})$ specific derivatives at $O(p^{d-1})$ cost, our method requires $O(p^{d-1})$ terms in the expansion. It attains $O(p^{d-1} \log p)$ cost of a multipole-to-local translation (with $O(p^{d-1})$ offline precomputation cost), and no higher than $O(p^d)$ cost for other translations.

The final form of our method is competitive with methods having state-of-the art complexity (e.g. [Greengard, 1988]) outside of multipole-to-multipole and local-to-local translations requiring $O(p^d)$ operations. Notably, neither of the two represent a dominant cost in typical applications of the FMM. In the interest of brevity, we use the term ‘translation’ so as to include initial formation and final evaluation of multipole and local expansions in the above description.

We show that there is no additional error incurred by our approach as compared to conventional Cartesian Taylor expansions, *except* for multipole-to-multipole translations for specific PDEs. In this case, we show that the error obeys a bound that is asymptotically identical to the truncation error of the underlying expansion, under mild assumptions. We additionally provide numerical verification supporting this claim. Finally, we will apply the algorithm to solve a boundary value problem for the biharmonic equation and verify the accuracy.

2 Preliminaries

In this section, we introduce the fundamental objects under consideration, namely multipole and local expansions based on Taylor series as well as their respective translation operators. These serve as the point of departure for our compressed and cost-optimized methods.

Let $\mathbf{x}, \mathbf{y} \in \mathbb{R}^d$ be two points. We will refer to these as the *target point* and the *source point*, respectively. Let

$$\mathcal{M}(p) := \left\{ \mathbf{q} = (q_1, \dots, q_d) \in \mathbb{N}_0^d : \sum_{i=1}^d q_i \leq p \right\}$$

be the set of all d -dimensional multi-indices with total order less than or equal to p , and let $N(p) := |\mathcal{M}(p)|$. Observe that

$$N(p) = \binom{p}{d}. \quad (2)$$

Let $p \in \mathbb{N}_0$ be an expansion order. Let $G \in C^{2p}(\mathbb{R}^d \setminus \{\mathbf{0}\})$ be a (translation-invariant) kernel as in (1). Note that we do not yet impose the restriction that G satisfy a PDE away from the origin. We assume that the derivatives of G of order greater than p satisfy

$$\partial_{\mathbf{x}}^{\mathbf{q}} G(\mathbf{x}) \leq M \frac{1}{\|\mathbf{x}\|^{|\mathbf{q}|+p'}} \quad (\|\mathbf{x}\| \leq a), \quad (3)$$

for some constants $a, M, p' \in \mathbb{R}^+$ where $\mathbf{q} \in \mathbb{N}_0^d$, $|\mathbf{q}| \geq p + 1$ and $p' \geq -p$. We let

$$\mathcal{G}(\mathbf{x}, \mathbf{y}) = G(\mathbf{x} - \mathbf{y})$$

for now to more clearly separate the dependencies on source and target variables. Using a Taylor series for (local) expansion of \mathcal{G} around a center \mathbf{c} from sources \mathbf{y} outside an expansion radius R

($\|\mathbf{y} - \mathbf{c}\| > R$),

$$\mathcal{G}(\mathbf{x}, \mathbf{y}) = \sum_{\mathbf{q} \in \mathcal{M}(\infty)} \underbrace{\frac{\partial_{\mathbf{x}}^{\mathbf{q}} \mathcal{G}(\mathbf{x}, \mathbf{y})|_{\mathbf{x}=\mathbf{c}}}{\mathbf{q}!}}_{\text{depends on source/center}} \underbrace{(\mathbf{x} - \mathbf{c})^{\mathbf{q}}}_{\text{depends on center/target}}. \quad (4)$$

Truncating the series to order p we have for $R > a$,

$$\left| \mathcal{G}(\mathbf{x}, \mathbf{y}) - \sum_{\mathbf{q} \in \mathcal{M}(p)} \frac{\partial_{\mathbf{x}}^{\mathbf{q}} \mathcal{G}(\mathbf{x}, \mathbf{y})|_{\mathbf{x}=\mathbf{c}}}{\mathbf{q}!} (\mathbf{x} - \mathbf{c})^{\mathbf{q}} \right| \leq \frac{A \|\mathbf{x} - \mathbf{c}\|^{p+1}}{R^{p+p'}(R - \|\mathbf{x} - \mathbf{c}\|)}, \quad (5)$$

where A is a constant. Shanker and Huang [2007] provide a proof of this error bound for the local expansion. Given a user-specified error tolerance ϵ , we choose an order such that the remainder term in the above expansion is smaller than the tolerance whenever $\|\mathbf{x} - \mathbf{c}\| < R$. In reference to a local expansion, we consider $(\partial_{\mathbf{x}}^{\mathbf{q}} \mathcal{G} / \mathbf{q}!)_{\mathbf{q} \in \mathcal{M}(p)}$ the *coefficients* of the expansion, and the multivariate monomials $((\mathbf{x} - \mathbf{c})^{\mathbf{q}})_{\mathbf{q} \in \mathcal{M}(p)}$ the *expansion basis*. The factorial term in the expansion can be considered part of the coefficient or the expansion basis. We choose to consider it part of the coefficient. Above, we have used the multi-index notation where for $\mathbf{q} = (q_1, q_2, \dots, q_d)$ and $\mathbf{x} = (x_1, x_2, \dots, x_d)^T$, we have

$$\begin{aligned} \mathbf{q}! &:= q_1! q_2! \dots q_d!, \\ \mathbf{x}^{\mathbf{q}} &:= x_1^{q_1} x_2^{q_2} \dots x_d^{q_d}, \\ \partial_{\mathbf{x}}^{\mathbf{q}} &:= \frac{\partial^{q_1}}{\partial x_1^{q_1}} \frac{\partial^{q_2}}{\partial x_2^{q_2}} \dots \frac{\partial^{q_d}}{\partial x_d^{q_d}}, \\ \mathbf{x} \geq \mathbf{q} &:\Leftrightarrow x_1 \geq q_1 \wedge x_2 \geq q_2 \wedge \dots \wedge x_d \geq q_d, \\ |\mathbf{q}| &:= q_1 + q_2 + \dots + q_d, \\ \binom{\mathbf{x}}{\mathbf{q}} &:= \binom{x_1}{q_1} \binom{x_2}{q_2} \dots \binom{x_d}{q_d}. \end{aligned}$$

Likewise, for a multipole expansion of \mathcal{G} around a center \mathbf{c} from sources \mathbf{y} inside an expansion ball with radius R ($\|\mathbf{y} - \mathbf{c}\| < R$), we have

$$\mathcal{G}(\mathbf{x}, \mathbf{y}) = \sum_{\mathbf{q} \in \mathcal{M}(\infty)} \underbrace{\frac{\partial_{\mathbf{y}}^{\mathbf{q}} \mathcal{G}(\mathbf{x}, \mathbf{y})|_{\mathbf{y}=\mathbf{c}}}{\mathbf{q}!}}_{\text{depends on center/target}} \underbrace{(\mathbf{c} - \mathbf{y})^{\mathbf{q}}}_{\text{depends on source/center}}. \quad (6)$$

Truncating the series to order p we have for $\|\mathbf{x} - \mathbf{c}\| < a$,

$$\left| \mathcal{G}(\mathbf{x}, \mathbf{y}) - \sum_{\mathbf{q} \in \mathcal{M}(p)} \frac{\partial_{\mathbf{y}}^{\mathbf{q}} \mathcal{G}(\mathbf{x}, \mathbf{y})|_{\mathbf{y}=\mathbf{c}}}{\mathbf{q}!} (\mathbf{c} - \mathbf{y})^{\mathbf{q}} \right| \leq \frac{A' R^{p+1}}{\|\mathbf{x} - \mathbf{c}\|^{p+p'} (\|\mathbf{x} - \mathbf{c}\| - R)}, \quad (7)$$

where A' is a constant. Shanker and Huang [2007] also provide a proof of this error bound for the multipole expansion. Given a user-specified error tolerance ϵ , we once again choose an order p such that the remainder term in the above expansion is smaller than the tolerance whenever $\|\mathbf{x} - \mathbf{c}\| > R$. In reference to a multipole expansion, we consider the multivariate monomials $((\mathbf{y} - \mathbf{c})^{\mathbf{q}} / \mathbf{q}!)_{\mathbf{q} \in \mathcal{M}(p)}$ the *coefficients* of the expansions, and the derivatives $(\partial_{\mathbf{x}}^{\mathbf{q}} \mathcal{G})_{\mathbf{q} \in \mathcal{M}(p)}$ the *expansion basis*.

In both cases, the d -dimensional Taylor series are truncated at order p , and therefore there are $O(p^d)$ terms in the sum.

To obtain a *multipole-to-local translation operator* given the coefficients for a multipole expansion $\alpha_{\mathbf{q}} = (\mathbf{c}_1 - \mathbf{y})^{\mathbf{q}} / \mathbf{q}!$ at a given center \mathbf{c}_1 , we can calculate the coefficients of a local expansion at a

different center by formally inserting multipole expansion (6) into the local expansion (4) and matching terms, i.e.

$$\partial_{\mathbf{x}}^r \mathcal{G}(\mathbf{x}, \mathbf{y})|_{\mathbf{x}=\mathbf{c}_2} \approx \sum_{|\mathbf{q}| \leq p} \partial_{\mathbf{x}}^r (\partial_{\mathbf{y}}^{\mathbf{q}} \mathcal{G}(\mathbf{x}, \mathbf{y})|_{\mathbf{y}=\mathbf{c}_1})|_{\mathbf{x}=\mathbf{c}_2} \boldsymbol{\alpha}_{\mathbf{q}}.$$

Since there are $O(p^d)$ terms in the expansion around given center, and there are the same number of coefficients in the translated expansion, this multipole-to-local translation operator requires $O(p^{2d})$ work when carried out naively.

To obtain a *multipole-to-multipole translation operator* given the coefficients for a multipole expansion $\boldsymbol{\alpha}_{\mathbf{q}} = (\mathbf{c}_1 - \mathbf{y})^{\mathbf{q}} / \mathbf{q}!$ at a given center \mathbf{c}_1 , we can calculate the coefficients of a multipole expansion at a different center using the multi-index binomial theorem.

$$\frac{(\mathbf{c}_2 - \mathbf{y})^r}{r!} = \frac{1}{r!} \sum_{\mathbf{q} \leq r} \binom{r}{\mathbf{q}} \underbrace{\mathbf{q}! \boldsymbol{\alpha}_{\mathbf{q}}}_{(\mathbf{c}_1 - \mathbf{y})^{\mathbf{q}}} (\mathbf{c}_2 - \mathbf{c}_1)^{r-\mathbf{q}} = \sum_{\mathbf{q} \leq r} \boldsymbol{\alpha}_{\mathbf{q}} \frac{(\mathbf{c}_2 - \mathbf{c}_1)^{r-\mathbf{q}}}{(r-\mathbf{q})!}.$$

This multipole-to-multipole translation operator also requires $O(p^{2d})$ work when carried out naively.

To obtain a *local-to-local translation operator* given the coefficients for a local expansion $\boldsymbol{\gamma}_{\mathbf{q}} = \partial_{\mathbf{y}}^{\mathbf{q}} \mathcal{G}(\mathbf{x}, \mathbf{y})|_{\mathbf{x}=\mathbf{c}_1} / \mathbf{q}!$ at a given center \mathbf{c}_1 , we can calculate the coefficients of a local expansion at a different center \mathbf{c}_2 by differentiation, i.e.

$$\partial_{\mathbf{x}}^r \mathcal{G}(\mathbf{x}, \mathbf{y})|_{\mathbf{x}=\mathbf{c}_2} \approx \sum_{|\mathbf{q}| \leq p} \boldsymbol{\gamma}_{\mathbf{q}} \partial_{\mathbf{x}}^r (\mathbf{x} - \mathbf{c}_1)^{\mathbf{q}}|_{\mathbf{x}=\mathbf{c}_2}.$$

This local-to-local operator also requires $O(p^{2d})$ work when carried out naively.

Formation of a multipole expansion following (6) and evaluation of a local expansion following (4) both require only $O(p^d)$ work. If $\partial_{\mathbf{x}}^{\mathbf{q}} u$ for $\mathbf{q} \in \mathcal{M}(p)$ is available in amortized $O(p)$ time, evaluation of a multipole expansion and formation of a local expansion (both requiring these values) require $O(p^{d+1})$ work. If, however, cheaper derivatives that cost amortized $O(1)$ time are available, then the evaluation of a multipole expansion and formation of a local expansion also require only $O(p^d)$ work.

The storage and operation count required for expansion and evaluation in the Taylor setting is higher by a factor of $O(p)$ than, e.g. conventional translation operators based on spherical harmonics. Translation operators in Taylor form require more work by a factor of at least $O(p^2)$. This difference results from the use of the PDE constraint (or lack thereof).

3 Algebraic Compression of Multipole and Local Expansions

When the potential satisfies a constant-coefficient linear partial differential equation, the derivatives of the potential satisfy the same PDE. Exploiting the resulting linear relationships among the derivatives $(\partial_{\mathbf{x}}^{\mathbf{q}} u)_{\mathbf{q} \in \mathcal{M}(p)}$ can reduce the amount of storage and computation needed for formation, translation, and evaluation of multipole and local expansions.

In this section, we derive an automated symbolic procedure to compress local and multipole expansions based on Taylor series with the help of an assumption that the potential satisfy a linear, constant-coefficient PDE. The resulting expansions have $O(p^{d-1})$ terms (compared to $O(p^d)$ terms in (4) and (6)). We begin by encoding the relationships between derivatives using the language of linear algebra in Section 3.1.

3.1 Linear-Algebraic Relationships Among Derivatives

Let \mathcal{L} be a constant-coefficient, linear, scalar d -dimensional partial differential operator

$$\mathcal{L} = \sum_{\mathbf{m} \in \mathcal{M}(c)} a_{\mathbf{m}} \frac{\partial^{\mathbf{m}}}{\partial \mathbf{x}^{\mathbf{m}}}, \quad (8)$$

where $a_{\mathbf{m}} \in \mathbb{C}$ are coefficients and c is the order of the PDE. Let $G : \mathbb{R}^d \setminus \{\mathbf{0}\} \rightarrow \mathbb{C}$ satisfy $\mathcal{L}G(\mathbf{x}) = 0$ for $x \in \mathbb{R}^d \setminus \{\mathbf{0}\}$. We define ‘a graded monomial ordering’ for multi-indices in Definition 1 using the definition in [Cox et al., 1994].

Definition 1. A graded monomial ordering ν is an invertible mapping $\nu : \mathbb{N} \rightarrow \mathbb{N}_0^d$ that enumerates the d -multi-indices in such a way that

1. $\nu(1) = (0, \dots, 0) \in \mathbb{N}_0^d$,
2. for $i, j \in \mathbb{N}$ we have $|\nu(i)| < |\nu(j)| \implies i < j$, and
3. for $i, j, k \in \mathbb{N}$ we have

$$i < j \implies \nu^{-1}(\nu(i) + \nu(k)) < \nu^{-1}(\nu(j) + \nu(k)). \quad (9)$$

Remark 2. Definition 1 implies that each graded monomial ordering induces a numbering of the elements of $\mathcal{M}(p)$, i.e. $\nu|_{\{1, \dots, N(p)\}} = \mathcal{M}(p)$.

Remark 3. (9) is equivalent to

$$i < j \Leftrightarrow \nu^{-1}(\nu(i) + \nu(k)) < \nu^{-1}(\nu(j) + \nu(k)). \quad (10)$$

For the remainder of this article, ν will always be a graded monomial ordering. Let \mathcal{D}^q be a vector of derivative operators with order less than or equal to q :

$$\mathcal{D}^q = [\partial_{\mathbf{x}}^{\nu(i)}]_{i=1}^{N(q)}. \quad (11)$$

$\mathcal{L}G = 0$ will result in linear relationships between elements of $\mathcal{D}^p G$. In the following, we will construct a *decompression matrix* $M \in \mathbb{C}^{N(p) \times N_c(p)}$ such that

$$\mathcal{D}^p G = M[\mathcal{D}^p G]_{\mathbf{j}}, \quad (12)$$

where $\mathbf{j} \in \{1, \dots, N(p)\}^{N_c(p)}$ is a vector of indices such that for a vector $\mathbf{v} \in \mathbb{C}^{N_c(p)}$, we have $[\mathbf{v}_{\mathbf{j}}]_i = v_{j_i}$ for $i \in \{1, \dots, N_c(p)\}$. One interpretation of (12) is that all the elements of $\mathcal{D}^p G$ can be reconstructed from just the subset given by \mathbf{j} .

Since $\mathcal{L}G = \mathbf{0}$ for $\mathbf{x} \neq \mathbf{0}$, $\mathcal{D}^{p-c} \mathcal{L}G = 0$. In the following, we use this nullspace relation to construct a basis of the coefficient space from which all values can be reconstructed by way of a *decompression operator* M .

Let $i \in \{1, \dots, N(p-c)\}$ and $\mathbf{n} = \nu(i) \in \mathcal{M}(p-c)$. Then

$$\begin{aligned} [\mathcal{D}^{p-c} \mathcal{L}G(\mathbf{x})]_i &= \partial_{\mathbf{x}}^{\mathbf{n}} \mathcal{L}G(\mathbf{x}) \\ &= \partial_{\mathbf{x}}^{\mathbf{n}} \left(\sum_{\xi \in \mathcal{M}(c)} a_{\xi} \partial_{\mathbf{x}}^{\xi} G(\mathbf{x}) \right) = \sum_{\xi \in \mathcal{M}(c)} a_{\xi} \partial_{\mathbf{x}}^{\xi + \mathbf{n}} G(\mathbf{x}) \\ &= \sum_{\mathbf{m} \in \mathcal{M}(p)} b_{\mathbf{n}, \mathbf{m}} \partial_{\mathbf{x}}^{\mathbf{m}} G(\mathbf{x}), \end{aligned} \quad (13)$$

with

$$b_{\mathbf{n}, \mathbf{m}} = \begin{cases} a_{\mathbf{m} - \mathbf{n}} & \mathbf{m} \geq \mathbf{n} \text{ and } \mathbf{m} - \mathbf{n} \in \mathcal{M}(c), \\ 0 & \text{otherwise} \end{cases} \quad (\mathbf{m} \in \mathcal{M}(p)). \quad (14)$$

Next, define a ‘PDE coefficients’ matrix $P \in \mathbb{C}^{N(p-c) \times N(p)}$ such that

$$P_{i_1, i_2} = b_{\nu(i_1), \nu(i_2)}(\mathbf{x}) \quad (i_1 \in N(p-c), i_2 \in N(p)) \quad (15)$$

and observe that

$$P\mathcal{D}^pG(\mathbf{x}) = \mathbf{0} \quad (\mathbf{x} \neq \mathbf{0}). \quad (16)$$

In a sense, each subsequent row of P contains a “shifted” version of the coefficients in the first row, cf. (14).

Let $h(i) : \{1, \dots, N(p-c)\} \rightarrow \{1, \dots, N(p)\}$ be the index of the last nonzero column in the i th row of P , i.e.

$$h(i) = \max\{l \in \{1, \dots, N(p)\} : b_{\nu(i), \nu(l)} \neq 0\}, \quad (17)$$

and let

$$\bar{\mathbf{j}} = (h(1), \dots, h(N(p-c)))^T. \quad (18)$$

Here and in the following, we abuse notation slightly by using index vectors like $\bar{\mathbf{j}}$ as sets, with the obvious interpretation. Next, we argue that $P_{[:, \bar{\mathbf{j}}]}$ is an invertible (particularly, square) submatrix of P in Lemmas 4, 5 and 6. We next use this invertibility to recover the full coefficient vector $\mathcal{D}^pG(\mathbf{x})$ from its subset $(\mathcal{D}^pG(\mathbf{x}))_{\bar{\mathbf{j}}}$ using the fact that $\mathcal{D}^pG(\mathbf{x})$ is in the nullspace of P .

Lemma 4. For $i \in \{1, 2, \dots, N(p-c)\}$, $\nu(h(i)) = \nu(h(1)) + \nu(i)$.

Proof. Let $i \in \{1, 2, \dots, N(p-c)\}$. Using the definition of b in (14), we see that

$$h(i) = \max\{l : a_{\nu(l) - \nu(i)} \neq 0, l \in \{1, \dots, N(p-c)\}, \nu(l) \geq \nu(i), \nu(l) - \nu(i) \in \mathcal{M}(c)\}, \quad (19)$$

and

$$h(1) = \max\{l : a_{\nu(l)} \neq 0, l \in \{1, \dots, N(p-c)\}, \nu(l) \in \mathcal{M}(c)\}. \quad (20)$$

Let

$$z = \nu^{-1}(\nu(h(1)) + \nu(i)).$$

Since $i \leq N(p-c)$ and $|\nu(h(1))| \leq c$, we have $|\nu(z)| \leq p$. Using (20), $a_{\nu(z) - \nu(i)} = a_{\nu(h(1))} \neq 0$. Therefore, using (19), we have $h(i) \geq z$.

In order to prove the lemma, we need to prove that $h(i) = z$. To arrive at a contradiction, assume $l = h(i) > z$. By (19), we may find an $m \in \{1, \dots, N(p-c)\}$ such that $\nu(m) = \nu(l) - \nu(i) \in \mathcal{M}(c)$. Then, using (10), we have

$$m = \nu^{-1}(\nu(l) - \nu(i)) > \nu^{-1}(\nu(z) - \nu(i)) = h(1)$$

and $a_{\nu(m)} = a_{\nu(l) - \nu(i)} \neq 0$. This contradicts the maximality of $h(1)$. \square

Lemma 5. h is a strictly increasing function, i.e. for $r_1, r_2 \in \{1, 2, \dots, N(p-c)\}$ with $r_1 < r_2$, we have

$$h(r_1) < h(r_2).$$

Proof. Using Definition 1,

$$\nu^{-1}(\nu(r_1) + \nu(k)) < \nu^{-1}(\nu(r_2) + \nu(k))$$

for $k \in \{1, \dots, N(p)\}$ since $r_1 < r_2$. Replacing k by $h(1)$ and using Lemma 4 we have,

$$\begin{aligned} h(r_1) &= \nu^{-1}(\nu(h(r_1))) \\ &= \nu^{-1}(\nu(h(1)) + \nu(r_1)) \\ &< \nu^{-1}(\nu(h(1)) + \nu(r_2)) \\ &= \nu^{-1}(\nu(h(r_2))) \\ &= h(r_2). \end{aligned}$$

\square

Lemma 6. $P_{[:, \bar{\mathbf{j}}]}$ is an invertible lower triangular matrix.

Here we have denoted extracting the columns with indices \mathbf{j} from T by the ‘Matlab(R)-style’ notation $T_{[:,\mathbf{j}]}$.

Proof. This follows from Lemma 5 because, in the i th row of P , the $h(i)$ th column is the last nonzero entry. Therefore, $P_{[:,\bar{\mathbf{j}}]}$ is lower triangular with nonzero diagonal entries. \square

Let $\mathbf{j} \in \{1, 2, \dots, N(p)\}^{N(p)-|\bar{\mathbf{j}}|}$ be an (unconstrained) numbering of the complement of $\bar{\mathbf{j}}$, i.e. of $\{m \in \{1, 2, \dots, N(p)\} : m \notin \bar{\mathbf{j}}\}$. Using Lemma 6 and the definition of P ,

$$\begin{aligned} P\mathcal{D}^p G(\mathbf{x}) &= 0 \\ \Leftrightarrow [P_{[:,\mathbf{j}]} \quad P_{[:,\bar{\mathbf{j}}]}] \begin{bmatrix} \mathcal{D}^p G(\mathbf{x})_{\mathbf{j}} \\ \mathcal{D}^p G(\mathbf{x})_{\bar{\mathbf{j}}} \end{bmatrix} &= 0 \\ \Leftrightarrow P_{[:,\mathbf{j}]} \mathcal{D}^p G(\mathbf{x})_{\mathbf{j}} + P_{[:,\bar{\mathbf{j}}]} \mathcal{D}^p G(\mathbf{x})_{\bar{\mathbf{j}}} &= 0 \\ \Leftrightarrow \mathcal{D}^p G(\mathbf{x})_{\bar{\mathbf{j}}} &= -(P_{[:,\bar{\mathbf{j}}]})^{-1} P_{[:,\mathbf{j}]} \mathcal{D}^p G(\mathbf{x})_{\mathbf{j}} \\ \Leftrightarrow \begin{bmatrix} \mathcal{D}^p G(\mathbf{x})_{\mathbf{j}} \\ \mathcal{D}^p G(\mathbf{x})_{\bar{\mathbf{j}}} \end{bmatrix} &= \underbrace{\begin{bmatrix} I \\ -P_{[:,\bar{\mathbf{j}}}^{-1} P_{[:,\mathbf{j}]} \end{bmatrix}}_{M' :=} \mathcal{D}^p G(\mathbf{x})_{\mathbf{j}}. \end{aligned}$$

As a row permutation of the matrix M' above, we define the *decompression operator* $M \in \mathbb{C}^{N(p) \times N(p-c)}$ as

$$\begin{aligned} M_{[\mathbf{j},:]} &= I \\ M_{[\bar{\mathbf{j}},:]} &= -P_{[:,\bar{\mathbf{j}}}^{-1} P_{[:,\mathbf{j}]} \end{aligned}$$

resulting in

$$\mathcal{D}^p G(\mathbf{x}) = M[\mathcal{D}^p G(\mathbf{x})]_{\mathbf{j}}, \quad (21)$$

corroborating the naming.

Theorem 7. For a vector $\mathbf{s} \in \mathbb{C}^{N(p)}$, $M\mathbf{s}$ can be computed in $\mathcal{O}(p^d)$ operations. Similarly, for a vector $\mathbf{s} \in \mathbb{C}^{N(p-c)}$, $M^T \mathbf{s}$ can be computed in $\mathcal{O}(p^d)$ operations.

Proof. Multiplying M by \mathbf{s} amounts to multiplication by the identity I and $-P_{[:,\bar{\mathbf{j}}}^{-1} P_{[:,\mathbf{j}]}$. The former is free, and, for the latter, let k be the number of nonzero elements in the first row of P , where $k = \mathcal{O}(1)$ (in the expansion order) as it depends only on the PDE. Observe that each row in P has the same number of nonzero elements as the first row. Therefore, the number of nonzero entries in P is $k \cdot N(p-c) = \mathcal{O}(p^d)$. So a matrix-vector product with $P_{[:,\mathbf{j}]}$ requires only $\mathcal{O}(p^d)$ operations. Since $P_{[:,\bar{\mathbf{j}}]}$ is lower triangular (Lemma 6) and also has $\mathcal{O}(p^d)$ nonzero entries, a matrix-vector product with $P_{[:,\bar{\mathbf{j}}}^{-1}$ can be carried out by forward substitution in $\mathcal{O}(p^d)$ operations. As a result, a matrix-vector product with $P_{[:,\bar{\mathbf{j}}}^{-1} P_{[:,\mathbf{j}]}$ can be carried out in $\mathcal{O}(p^d)$ operations. The argument for M^T is analogous. \square

Using (21) for the storage of Taylor series coefficients means that $|\mathbf{j}|$ coefficients suffice to recover the entire Taylor expansion of a function u satisfying $\mathcal{L}G(\mathbf{x}) = 0$ at a point \mathbf{x} . The number of entries of \mathbf{j} satisfies

$$|\mathbf{j}| = |\mathcal{M}(p) \setminus \bar{\mathbf{j}}| = N(p) - |\bar{\mathbf{j}}| = N(p) - N(p-c) \stackrel{(2)}{=} \binom{p}{d} - \binom{p-c}{d} = \mathcal{O}(p^{d-1}),$$

so that we only need to store $\mathcal{O}(p^{d-1})$ coefficients to represent a local Taylor expansion. We show the multi-index ‘footprint’ of \mathbf{j} and $\bar{\mathbf{j}}$ for some example PDEs in Figure 1.

We describe the formation of the local expansions in more detail in Section 3.2 and their evaluation in Section 3.3. Since the basis functions of the multipole expansion are the derivatives of the kernel, they are amenable to compression via (21) as well. We describe formation of a compressed multipole expansion in Section 3.4 and evaluation of the multipole expansion in Section 3.5.

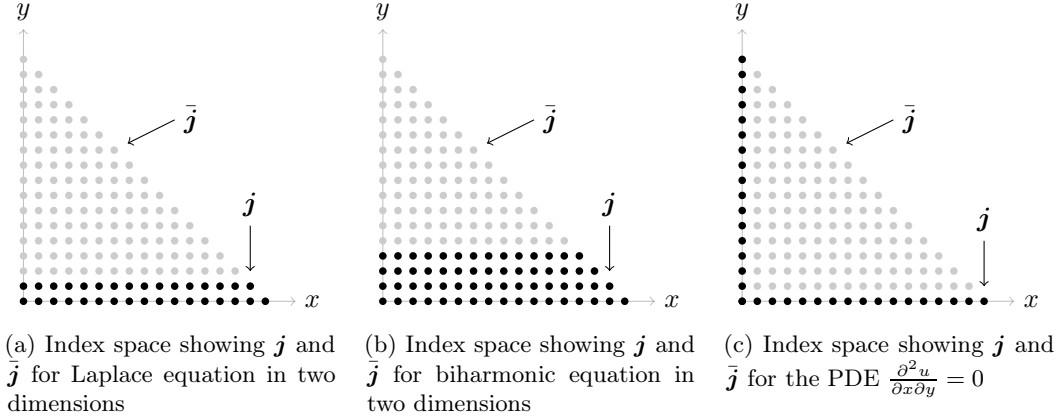

Figure 1: Index space showing \mathbf{j} , $\bar{\mathbf{j}}$ for order 16 Taylor series satisfying different two-dimensional partial differential equations

3.2 Compressed Local Expansion

Let $\mathbf{y} \in \mathbb{R}^d$ be a source point, $\mathbf{c} \in \mathbb{R}^d$ an expansion center, and $\mathbf{x} \in \mathbb{R}^d$ a target point with $\|\mathbf{x} - \mathbf{c}\| < \|\mathbf{y} - \mathbf{c}\|$. Recall from (4) that the i th coefficient of a local expansion is

$$\gamma_i = \sum_{\mathbf{y} \in S} \frac{\partial_{\mathbf{x}}^{\nu(i)} \mathcal{G}(\mathbf{x}, \mathbf{y})|_{\mathbf{x}=\mathbf{c}}}{\nu(i)!} = \sum_{\mathbf{y} \in S} \frac{[\mathcal{D}^p G(\mathbf{c} - \mathbf{y})]_i}{\nu(i)!}.$$

Using the decompression machinery from Section 3.1, it suffices to compute and store

$$\boldsymbol{\theta} = \sum_{\mathbf{y} \in S} [\mathcal{D}^p G(\mathbf{c} - \mathbf{y})]_{\mathbf{j}} \quad (22)$$

to recover the uncompressed representation via

$$\gamma_i = \sum_{\mathbf{y} \in S} \frac{[\mathcal{D}^p G(\mathbf{c} - \mathbf{y})]_i}{\nu(i)!} = \frac{[M \sum_{\mathbf{y} \in S} [\mathcal{D}^p G(\mathbf{c} - \mathbf{y})]_{\mathbf{j}}]_i}{\nu(i)!} = \frac{[M\boldsymbol{\theta}]_i}{\nu(i)!}. \quad (23)$$

Next, we consider the cost of evaluating (22).

Definition 8. Let $w(p)$ be the amortized number of floating point operations required to calculate one derivative of G , assuming all of the derivatives $[\mathcal{D}^p G(\mathbf{x})]_{\mathbf{j}}$ required for the ‘compressed’ subset $\nu(\mathbf{j})$ are being calculated.

Given the quantity $w(p)$, forming a compressed local expansion requires $O(p^{d-1}w(p))$ operations. Section 4.4 gives procedures for the computation of derivatives and provides estimates of $w(p)$ for different kernels.

3.3 Compressed Local Evaluation

In local expansion evaluation, the inner product of the full set of Taylor coefficients and the monomials is calculated per target. Recall from (4) that the local Taylor expansion for a target $\mathbf{x} \in T$ is,

$$G(\mathbf{x} - \mathbf{y}) \approx \sum_{i \in \{1, 2, \dots, N(p)\}} \gamma_i (\mathbf{x} - \mathbf{c})^{\nu(i)},$$

where

$$\gamma_i = \frac{[M\boldsymbol{\theta}]_i}{\nu(i)!} \quad \text{and} \quad \boldsymbol{\theta} = \sum_{\mathbf{y} \in S} [\mathcal{D}^p G(\mathbf{c} - \mathbf{y})]_j.$$

Using Theorem 7, calculating the full set of Taylor coefficients γ_i from the stored coefficients $\boldsymbol{\theta}_i$ requires $O(p^d)$ operations. Calculating the monomials $(\mathbf{x} - \mathbf{c})^{\nu(i)}$ requires $O(p^d)$ operations, and the inner product of the monomials and the coefficients require the same amount of work. Overall, evaluation of a compressed local expansion requires $O(p^d)$ operations.

3.4 Compressed Multipole Expansion

While compression and decompression of local expansions amounted to a straightforward application of (21), compression and decompression of multipole expansions requires additional machinery, which we introduce in this section. We compress a multipole expansion to $O(p^{d-1})$ terms at a cost of $O(p^d)$ operations.

Let $\boldsymbol{\alpha} \in \mathbb{C}^{|\mathcal{M}(p)|}$ be a vector of coefficients of a multipole expansion. From (6), we know that

$$\boldsymbol{\alpha}_i = \sum_{\mathbf{y} \in S} \frac{(\mathbf{c} - \mathbf{y})^{\nu(i)}}{\nu(i)!},$$

where $i \in \{1, 2, \dots, N(p)\}$. Let $\mathcal{D}^p G(\mathbf{x} - \mathbf{c})$ be a vector of derivatives. Let M be the decompression operator and \mathbf{j} be the vector of indices of $\mathcal{D}^p G(\mathbf{x})$ that are stored. Recall from (6) that the multipole expansion around center \mathbf{c} evaluated at a target point $\mathbf{x} \in T$ is,

$$\mathcal{D}^p G(\mathbf{x} - \mathbf{c})^T \boldsymbol{\alpha}.$$

Inserting (21) into the above equation and using associativity, we obtain,

$$\mathcal{D}^p G(\mathbf{x} - \mathbf{c})^T \mathbf{s} = (M[\mathcal{D}^p G(\mathbf{x} - \mathbf{c})_{\mathbf{j}}])^T \boldsymbol{\alpha} = [\mathcal{D}^p G(\mathbf{x} - \mathbf{c})_{\mathbf{j}}]^T M^T \boldsymbol{\alpha} = [\mathcal{D}^p G(\mathbf{x} - \mathbf{c})_{\mathbf{j}}]^T \boldsymbol{\beta},$$

where

$$\boldsymbol{\beta} = M^T \boldsymbol{\alpha}. \tag{24}$$

We choose to store $\boldsymbol{\beta}$ instead of $\boldsymbol{\alpha}$, requiring only $O(p^{d-1})$ elements to be stored instead of $O(p^d)$. Using Theorem 7 we know that this computation requires only $O(p^d)$ operations.

3.5 Compressed Multipole Evaluation

Recall from Section 3.4 that the multipole expansion around center \mathbf{c} evaluated at a target point $\mathbf{x} \in T$ is given by,

$$\mathcal{G}(x, y) = [\mathcal{D}^p G(\mathbf{x} - \mathbf{c})_{\mathbf{j}}]^T \boldsymbol{\beta}, \tag{25}$$

where $\boldsymbol{\beta}$ are the stored coefficients, and \mathbf{j} is the vector of stored indices of $\mathcal{D}^p G(\mathbf{x} - \mathbf{c})$. For multipole evaluation, the derivatives $\mathcal{D}^p G(\mathbf{x} - \mathbf{c})_{\mathbf{j}}$ need to be calculated, and there are $O(p^{d-1})$ derivatives. Using Definition 8, calculating the derivatives costs $O(p^{d-1}) w(p)$ operations. The last step in the evaluation is a dot product of the coefficients $\boldsymbol{\beta}$ and the kernel derivatives $\mathcal{D}^p G(\mathbf{x} - \mathbf{c})_{\mathbf{j}}$, which requires $O(p^{d-1})$ operations. Therefore, multipole evaluation performs $O(p^{d-1} w(p))$ operations.

4 Translations on Algebraically Compressed Expansions

In this section, we consider algorithms for translating compressed Taylor series expansions as well as costs and errors incurred by them. Subsections 4.1, 4.2, and 4.3 give algorithms for translating a compressed multipole expansion to a compressed local expansion, shifting the center of a compressed local expansion and shifting the center of a compressed multipole expansion, respectively.

4.1 Multipole-to-Local Translation

To set the stage for the statement of the multipole-to-local translation algorithm in compressed representation, consider a linear PDE of order c and number of dimensions d in the form

$$\mathcal{L}G(\mathbf{x}) = \sum_{|\mathbf{m}|=c} a_{\mathbf{m}} \partial_{\mathbf{x}}^{\mathbf{m}} G(\mathbf{x}) + \sum_{|\mathbf{m}|<c} a_{\mathbf{m}} \partial_{\mathbf{x}}^{\mathbf{m}} G(\mathbf{x}) = 0,$$

where we have separated the highest-order terms from the lower-order terms.

The following property (and its consequences as given by the subsequent lemmas) yield a reduction in the asymptotic cost of our translation operators:

Property 9.

$$a_{c\mathbf{e}_i} \neq 0 \text{ for some } i \in \{1, \dots, d\}.$$

Lemma 10. *A constant-coefficient elliptic PDE has property 9.*

Proof. Using the definition for an elliptic PDE given by Cosner [1991] a constant-coefficient elliptic PDE is a PDE such that the principal symbol

$$\mathcal{P}(\boldsymbol{\xi}) = \sum_{|\mathbf{m}|=c} a_{\mathbf{m}} \boldsymbol{\xi}^{\mathbf{m}} \neq 0$$

for all nonzero vectors $\boldsymbol{\xi} \in \mathbb{C}^d$. Suppose an elliptic PDE does not have Property 9, then, $a_{c\mathbf{e}_i} = 0$ for all $i \in \{1, \dots, d\}$. Then $\mathcal{P}(\mathbf{e}_i) = 0$ for $i \in \{1, \dots, d\}$, contradicting ellipticity. \square

Fast Fourier Transforms (FFTs) will play an important role in our translation algorithm. In this next lemma, we bound an expression that determines the size of the FFTs carried out as part of the evaluation of the translation operator.

Lemma 11. *There exists a graded monomial ordering $\boldsymbol{\nu}$ such that, for a PDE with Property 9,*

$$\prod_{i=1}^d \max_{s \in \mathbf{j}} \boldsymbol{\nu}(s)_i = O(p^{d-1}), \quad (26)$$

where \mathbf{j} depends on the ordering $\boldsymbol{\nu}$.

Proof. Let $k \in \{1, \dots, d\}$ be such that $a_{c\mathbf{e}_k} \neq 0$. Let $\boldsymbol{\nu}$ be a degree-lexicographic ordering with the k th entry varying slowest. Then $\boldsymbol{\nu}^{-1}(c\mathbf{e}_k) = N(c)$, i.e. it is the last entry in the ordering of multi-indices $\mathcal{M}(c)$. In terms of h from (17), $h(1) = \max \boldsymbol{\nu}^{-1}(\mathcal{M}(c)) = \boldsymbol{\nu}^{-1}(c\mathbf{e}_k)$, i.e. $\boldsymbol{\nu}(h(1)) = c\mathbf{e}_k$. From Lemma 4, we have

$$\boldsymbol{\nu}(h(q)) = \boldsymbol{\nu}(h(1)) + \boldsymbol{\nu}(q) = c\mathbf{e}_k + \boldsymbol{\nu}(q) \quad (q \in \{1, 2, \dots, N(p-c)\}).$$

Therefore all multi-indices $\mathbf{m} \in \mathcal{M}(p)$ with $m_k \geq c$ belong to the unrepresented indices $\bar{\mathbf{j}}$, as defined in (18). On the other hand, for represented indices \mathbf{j} , $\boldsymbol{\nu}(s)_k < c$ for $s \in \mathbf{j}$. Thus

$$\max_{s \in \mathbf{j}} \boldsymbol{\nu}(s)_k = c - 1 = O(1) \quad (\text{as } p \rightarrow \infty),$$

while

$$\max_{s \in \mathbf{j}} \boldsymbol{\nu}(s)_i = O(p) \quad (i \neq k).$$

\square

Consider the three examples in Figure 1. We know that the Laplace equation and biharmonic equation satisfy Property 9 and \mathbf{j} given in Figures 1a and 1b are such that the $\max_{s \in \mathbf{j}} \nu(s)_2$ is 1 and 3 respectively, confirming Lemma 11. We also know that the PDE $\partial^2 u / \partial x \partial y = 0$ does not satisfy the Property 9, and we can see that the resulting numbering does not satisfy (26) since $\max_{s \in \mathbf{j}} \nu(s)_2 = \max_{s \in \mathbf{j}} \nu(s)_1 = p$ as shown in Figure 1c.

We are now ready to state an algorithm for multipole-to-local translation, including for the special case of PDEs with Property 9.

Theorem 12. *Translating a multipole expansion in compressed representation around center \mathbf{c}_1 to a local expansion in compressed representation around center \mathbf{c}_2 can be achieved with*

- $O(p^{d-1} \log(p))$ work in d dimensions for PDEs with Property 9,
- $O(p^2)$ work in two dimensions, and
- $O(p^d \log(p))$ work in d dimensions.

Proof. To translate a multipole expansion to a local expansion, we need to calculate the $O(p^{d-1})$ coefficients in the compressed representation of the target local expansion. Let \mathbf{c}_1 be the multipole expansion center and \mathbf{c}_2 be the local expansion center. Using (25), we have

$$\sum_{\mathbf{y} \in S} \mathcal{G}(\mathbf{x}, \mathbf{y}) \approx \mathcal{D}^p G(\mathbf{x} - \mathbf{c}_1)_{\mathbf{j}}^T \boldsymbol{\beta} = \sum_{q \in \mathbf{j}} G^{(\nu(q))}(\mathbf{x} - \mathbf{c}_1) \boldsymbol{\beta}_q,$$

where $\boldsymbol{\beta} = M^T \boldsymbol{\alpha}$ and $\boldsymbol{\alpha}_i = \sum_{\mathbf{y} \in S} (\mathbf{c}_1 - \mathbf{y})^{\nu(i)} / \nu(i)!$ for $i \in \{1, 2, \dots, N(p)\}$. Since, according to (4), the coefficients in a local expansion are derivatives of the potential, we obtain local coefficients for the potential from a multipole expansion by taking derivatives of the expansion expression. The i th local expansion coefficient is therefore

$$\gamma_i = \frac{\partial_{\mathbf{x}}^{\nu(i)} \mathcal{G}(\mathbf{x}, \mathbf{y})|_{\mathbf{x}=\mathbf{c}_2}}{\nu(i)!} = \frac{1}{\nu(i)!} \partial_{\mathbf{x}}^{\nu(i)} \left(\sum_{q \in \mathbf{j}} G^{(\nu(q))}(\mathbf{x} - \mathbf{c}_1) \boldsymbol{\beta}_q \right) |_{\mathbf{x}=\mathbf{c}_2} = \frac{1}{\nu(i)!} \sum_{q \in \mathbf{j}} G^{(\nu(q)+\nu(i))}(\mathbf{c}_2 - \mathbf{c}_1) \boldsymbol{\beta}_q, \quad (27)$$

where $i \in \mathbf{j}$. Let \mathbf{j}' is a vector of indices of the stored derivatives for order $2p$ similar to \mathbf{j} for order p . Since $|\nu(q) + \nu(i)| \leq 2p$ for $q, i \in \mathbf{j}$, $G^{(\nu(q)+\nu(i))}$ can be computed by calculating the derivatives $\mathcal{D}^{2p} G(\mathbf{x})_{\mathbf{j}'}$, and then using the decompression matrix to calculate all the derivatives $\mathcal{D}^{2p} G(\mathbf{x})$. Using $w(p)$ as defined in Def. 8, the evaluation of the derivatives numbered by \mathbf{j}' requires $O(p^{d-1} w(2p))$ operations, and calculating the remaining ones requires $O(p^d)$ operations (Theorem 7). Since the sum has $O(p^{d-1})$ terms and there are only $O(p^{d-1})$ coefficients in the target local expansion that need to be computed, the total work required is $O(p^{2d-2} + O(p^d) + p^{d-1} w(2p))$.

These derivatives can be precomputed for a given collection of expansion centers, since they depend only on $\mathbf{c}_2 - \mathbf{c}_1$. In a typical FMM, there are only $7^d - 3^d$ different distances per level for d dimensions. With pre-computation of the derivatives, this gives us an algorithm with $O(p^{2d-2})$ operations.

The translation operator in (27) can be transformed to a d -dimensional convolutional form. Let $\boldsymbol{\eta} = \nu(\mathbf{j}_i)_{i=1}^{\#\mathbf{j}}$, $\gamma'_{\nu(i)} = \gamma_i$ for $i \in \{1, \dots, N(p)\}$ and $\boldsymbol{\beta}'_{\nu(q)} = \boldsymbol{\beta}_q$ for $q \in \mathbf{j}$. Re-writing the expression for translated expansion coefficient in the three dimensions with the individual dimensions made explicit, we obtain

$$\gamma'_{\eta_1, \eta_2, \eta_3} = \frac{1}{\eta_1! \eta_2! \eta_3!} \sum_{\zeta_1=0}^{M_1} \sum_{\zeta_2=0}^{M_2} \sum_{\zeta_3=0}^{M_3} G^{(\eta_1+\zeta_1, \eta_2+\zeta_2, \eta_3+\zeta_3)}(\mathbf{c}_2 - \mathbf{c}_1) \boldsymbol{\beta}''_{-\zeta_1, -\zeta_2, -\zeta_3},$$

where M_1, M_2, M_3 are the maximum nonzero indices for each dimension, i.e. $M_i = \max_{s \in \mathbf{j}} \nu(s)_i$. In addition,

$$\boldsymbol{\beta}''_{-\zeta_1, -\zeta_2, -\zeta_3} = \begin{cases} \boldsymbol{\beta}'_{\zeta_1, \zeta_2, \zeta_3} & \boldsymbol{\nu}^{-1}(\zeta_1, \zeta_2, \zeta_3) \in \mathbf{j}, \\ 0 & \text{otherwise.} \end{cases}$$

Rearranging the summation variables, we obtain

$$\gamma'_{\eta_1, \eta_2, \eta_3} = \frac{1}{\eta_1! \eta_2! \eta_3!} \sum_{\zeta_1 = -M_1}^0 \sum_{\zeta_2 = -M_2}^0 \sum_{\zeta_3 = -M_3}^0 G^{(\eta_1 - \zeta_1, \eta_2 - \zeta_2, \eta_3 - \zeta_3)}(\mathbf{c}_2 - \mathbf{c}_1) \boldsymbol{\beta}''_{\zeta_1, \zeta_2, \zeta_3}, \quad (28)$$

revealing the convolutional form of the operator.

This is similar to the convolution-based algorithm for the M2L translation operator for 3D Laplace described in [Greengard and Rokhlin, 1988]. In a further step, this convolution can be applied by viewing it as multiplication of the coefficient vector by a Toeplitz matrix. This multiplication in turn can be realized via a Fast Fourier Transform through an embedding in a circulant matrix. We refer to [Greengard and Rokhlin, 1988] for the details, noting that while the reference only discusses convolutions in one and two dimensions, the extension to d dimensions is straightforward (where, in our case, the sizes of the d -dimensional convolution are $(M_1 + 1, \dots, M_d + 1)$).

A one-dimensional convolution of size m can be represented as multiplication by a Toeplitz matrix, which in turn can be embedded in a circulant matrix of size $2m - 1$. A circulant matrix multiplication can be carried out using an FFT of length $2m - 1$. Similarly, a d -dimensional convolution with sizes $(M_1 + 1, \dots, M_d + 1)$ can be carried out using an FFT of sizes $(2M_1 + 1, \dots, 2M_d + 1)$ which in turn can be transformed into a one-dimensional FFT of size $\prod_{i=1}^d (2M_i + 1)$. Since $M_i = O(p)$, the length of the FFT is $O(p^d)$. Using Lemma 11, the length of the FFT is $O(p^{d-1})$ for PDEs satisfying Property 9.

The overall time complexity of the translation is therefore $O(p^{d-1} \log p)$ for PDEs satisfying Property 9 and $O(p^d \log p)$ for all other PDEs. In particular, for three-dimensional Laplace, the FFT is of sizes $(2p + 1, 2p + 1, 3)$ which leads to a $O(p^2 \log p)$ algorithm. \square

Cost comparisons with other M2L translation algorithms in the literature. The specialized algorithm by Greengard and Rokhlin [1988] for the Laplace equation requires an FFT of sizes $(2p, 4p + 1)$ which requires approximately one third fewer operations than our algorithm. As a further comparison with the literature, the algorithm without the FFT performs $O(p^{2d-2}) = O(p^4)$ floating point operations for Laplace 3D, which has the same cost as the algorithm based on tensor contraction by Shanker and Huang [2007] and is an improvement over the algorithm given in [Oppelstrup, 2013] where common sub-expression elimination is used to give an (empirically) $O(p^{4.5})$ algorithm.

4.1.1 Numerical stability

While the Fast Fourier Transform is numerically stable, having input values that differ in magnitude has the potential to result in substantial error resulting from rounding of intermediate quantities. Greengard and Rokhlin [1988] provide a partial mitigation to this problem for the Laplace equation, where scaling the derivatives and the monomials in the Taylor series reduces the error by reducing the range of the magnitudes of the derivatives. Rewriting (27) using a scaling parameter t , we obtain

$$\gamma_i = \frac{t^{|\nu(i)|}}{\nu(i)!} \sum_{q \in j} \frac{G^{(\nu(q) + \nu(i))}(\mathbf{c}_2 - \mathbf{c}_1)}{t^{|\nu(q) + \nu(i)|}} \boldsymbol{\beta}_q t^{|\nu(q)|}.$$

This preserves the convolutional form of the operator, and therefore the multipole-to-local translation algorithm of Section 4.1 applies with only minor modifications.

Choosing the scaling parameter depends on the magnitudes of the derivatives $G^{(\nu(q) + \nu(i))}$. For the three-dimensional Laplace equation, Greengard and Rokhlin [1988] suggests using p/r where p is the order and r is the distance between the centers of two neighboring boxes in the tree, akin to an expansion ‘radius’. Empirically, the same parameter succeeds in controlling the magnitudes of entries of the input vector in our algorithm. For the two-dimensional biharmonic equation on the other hand, we observed a smaller range of magnitudes in the entries of the input vector when using $4/r$ compared to $16/r$ for an expansion of order 16. While the parameter suggested in Greengard and Rokhlin [1988] appears empirically to be a workable choice, optimal selection of the scaling parameter for general kernels remains a subject for future research.

4.2 Local-to-Local Translation

Using the local expansion in (4) and replacing the precomputed coefficient with C_q , we get

$$\sum_{\mathbf{y} \in S} \mathcal{G}(\mathbf{x}, \mathbf{y}) \approx \sum_{i=1}^{N(p)} \boldsymbol{\alpha}_i (\mathbf{x} - \mathbf{c})^{\boldsymbol{\nu}(i)}$$

where $\boldsymbol{\alpha}_i = [M\boldsymbol{\beta}]_i / \boldsymbol{\nu}(i)!$. To calculate the local expansion around the new center \mathbf{c}_2 , we take derivatives of the expression above to obtain the coefficients of the new local expansion. In the local expansion around center \mathbf{c}_2 , the i th coefficient is

$$\begin{aligned} \boldsymbol{\mu}_i &= \frac{\partial_{\mathbf{x}}^{\boldsymbol{\nu}(i)} \mathcal{G}(\mathbf{x}, \mathbf{y})|_{\mathbf{x}=\mathbf{c}_2}}{\boldsymbol{\nu}(i)!} = \frac{1}{\boldsymbol{\nu}(i)!} \sum_{q \in \{1, 2, \dots, N(p)\}} \gamma_q \partial_{\mathbf{x}}^{\boldsymbol{\nu}(i)} (\mathbf{x} - \mathbf{c}_1)^{\boldsymbol{\nu}(q)}|_{\mathbf{x}=\mathbf{c}_2} \\ &= \frac{1}{\boldsymbol{\nu}(i)!} \sum_{q \in \{1, 2, \dots, N(p)\}, \boldsymbol{\nu}(q) \geq \boldsymbol{\nu}(i)} \gamma_q \frac{\boldsymbol{\nu}(q)!}{(\boldsymbol{\nu}(q) - \boldsymbol{\nu}(i))!} (\mathbf{c}_2 - \mathbf{c}_1)^{\boldsymbol{\nu}(q) - \boldsymbol{\nu}(i)} \\ &= \sum_{q \in \{1, 2, \dots, N(p)\}, \boldsymbol{\nu}(q) \geq \boldsymbol{\nu}(i)} \gamma_q \binom{\boldsymbol{\nu}(q)}{\boldsymbol{\nu}(i)} (\mathbf{c}_2 - \mathbf{c}_1)^{\boldsymbol{\nu}(q) - \boldsymbol{\nu}(i)} \end{aligned} \quad (29)$$

where $i \in \mathbf{j}$. From Theorem 7, we know that calculating γ_q from $\boldsymbol{\theta}$ for $q \in \{1, 2, \dots, N(p)\}$ requires $O(p^d)$ operations as $\gamma_q = [M\boldsymbol{\theta}]_q / \boldsymbol{\nu}(q)!$. Evaluating each $\boldsymbol{\mu}_i$ following the formula above requires $O(p^d)$ operations, resulting in an overall operation count of $O(p^{2d-1})$ for the translation in compressed representation. Fortunately, the amount of work can be reduced to $O(p^d)$ by re-arranging the sums to use common sub-expressions. To show this time complexity, we need the following two lemmas.

Lemma 13. *Let p be the order of a local expansion and let*

$$S_{\ell, k} = \{\mathbf{m} : \mathbf{m} \in \mathcal{M}(p), \mathbf{m}_\ell = k\}$$

for $\ell \in \{1, \dots, d\}$, $k \in \{0, \dots, p\}$. When calculating the coefficients of a local expansion by translating a local expansion at a different center, calculating all the $O(p^{d-1})$ coefficients in $S_{\ell, k}$ for a given ℓ and k requires $O(p^d)$ work.

Proof. Let $i \in \mathbf{j}$, $\boldsymbol{\eta} = \boldsymbol{\nu}(i)$, $\boldsymbol{\mu}'_{\boldsymbol{\eta}} = \boldsymbol{\mu}_i$, $\gamma'_{\boldsymbol{\nu}(q)} = \gamma_q$ for $q \in \{1, 2, \dots, N(p)\}$. Rewriting (29) using these substitutions yields

$$\boldsymbol{\mu}'_{\boldsymbol{\eta}} = \sum_{(\boldsymbol{\eta} + \boldsymbol{\zeta}) \in \mathcal{M}(p), \boldsymbol{\zeta} \geq 0} \gamma'_{\boldsymbol{\zeta} + \boldsymbol{\eta}} \binom{\boldsymbol{\zeta} + \boldsymbol{\eta}}{\boldsymbol{\eta}} (\mathbf{c}_2 - \mathbf{c}_1)^{\boldsymbol{\zeta}}.$$

As an illustrative example, consider the two-dimensional case with $\boldsymbol{\mu}'_{\boldsymbol{\eta}}$ expanded:

$$\begin{aligned} \boldsymbol{\mu}'_{\eta_1, \eta_2} &= \sum_{\zeta_1=0}^{p-\eta_1} \left(\sum_{\zeta_2=0}^{p-\eta_1-\eta_2-\zeta_1} \gamma'_{\zeta_1+\eta_1, \zeta_2+\eta_2} \binom{\zeta_1+\eta_1}{\eta_1} \binom{\zeta_2+\eta_2}{\eta_2} d_1^{\zeta_1} d_2^{\zeta_2} \right) \\ &= \sum_{\zeta_1=0}^{p-\eta_1} \underbrace{\left(\sum_{\zeta_2=0}^{p-(\zeta_1+\eta_1)-\eta_2} \gamma'_{\zeta_1+\eta_1, \zeta_2+\eta_2} \binom{\zeta_2+\eta_2}{\eta_2} d_2^{\zeta_2} \right)}_{\xi_{\zeta_1+\eta_1, \eta_2}} d_1^{\zeta_1} \binom{\zeta_1+\eta_1}{\eta_1}, \end{aligned}$$

where $(d_1, d_2)^T = \mathbf{c}_2 - \mathbf{c}_1$. Let

$$\xi_{\eta_1, \eta_2} = \sum_{\zeta_2=0}^{p-\eta_1-\eta_2} \gamma'_{\eta_1, \zeta_2+\eta_2} \binom{\zeta_2+\eta_2}{\eta_2} d_2^{\zeta_2}. \quad (30)$$

Assume that we are calculating the coefficients for multi-indices in $S_{2,k}$. Then $\eta_2 = k$ is fixed and we vary only η_1 . Evaluating the $O(p)$ coefficients $(\xi_{\mathbf{m}})_{\mathbf{m} \in S_{2,k}}$ requires $O(p^2)$ operations since the sum in (30) has $O(p)$ terms. Finally, once $(\xi_{\mathbf{m}})_{\mathbf{m} \in S_{2,k}}$ are calculated, calculating $(\mu'_{\mathbf{m}})_{\mathbf{m} \in S_{2,k}}$ also requires $O(p^2)$ operations. A similar formula (factoring on the first instead of the second dimension) gives an algorithm of the same asymptotic cost when calculating $(\mu'_{\mathbf{m}})_{\mathbf{m} \in S_{1,k}}$.

In the general case of d dimensions, an analog of the above computation may use $d - 1$ ‘nested’ definitions $\xi^{(1)}, \xi^{(2)}, \dots, \xi^{(d-1)}$, with each intermediate quantity having $O(p^{d-1})$ elements and each entry a sum of $O(p)$ terms. Overall, the computation requires $O(p^d)$ operations in total. \square

In the case of the uncompressed representation, all the multi-indices in $\mathcal{M}(p)$ can be divided into $p + 1$ sets (which one might think of as “slices”), i.e.,

$$\mathcal{M}(p) = \bigcup_{k=0}^p S_{1,k}.$$

This leads to a translation cost of $O(p^{d+1})$ operations. In the compressed case, we subdivide

$$\nu(\mathbf{j}) = \{\nu(i) : i \in \mathbf{j}\}$$

into slices. One might expect that $O(1)$ slices need to be computed. As an illustrative example, consider the PDE

$$\frac{\partial^2 u}{\partial x \partial y} + \frac{\partial u}{\partial x} + \frac{\partial u}{\partial y} = 0 \quad (31)$$

in two dimensions. Using a degree-lexicographic ordering ν where the x dimension varies slowest,

$$\nu(\mathbf{j}) = \{\mathbf{m} \in \mathcal{M}(p) : m_1 = 0 \text{ or } m_2 = 0\}.$$

(To see this, consider that (31) amounts to a rule that allows rewriting the leading term as a sum of the other two derivatives, allowing the partial derivatives with multi-indices $\mathcal{M}(p) \setminus \nu(\mathbf{j})$ to be computed from those in $\nu(\mathbf{j})$.) We can rewrite $\nu(\mathbf{j})$ as

$$\nu(\mathbf{j}) = S_{2,0} \cup S_{1,0}.$$

so that we have a union of two slices with the first slice varying only the first dimension and the second slice varying only the second dimension. This leads to a $O(p^2)$ algorithm. Lemma 14 generalizes this to any PDE.

Lemma 14. *The multi-indices in the compressed representation of a local or multipole expansion of order p of a potential obeying any PDE in d dimensions can be divided into $O(1)$ “slices” where each multi-index has one component constant across the set.*

Proof. Let

$$\nu(\bar{\mathbf{j}}) = \{\nu(i) : i \in \bar{\mathbf{j}}\}.$$

Recall from (18) that

$$\nu(\bar{\mathbf{j}}) = (\nu(h(1)), \dots, \nu(h(N(p-c))))^T.$$

Let $\mathbf{t} = \nu(h(1))$. Using Lemma 4,

$$\nu(\bar{\mathbf{j}}) = (\mathbf{t} + \nu(1), \mathbf{t} + \nu(2), \dots, \mathbf{t} + \nu(N(p-c)))^T.$$

Since \mathbf{j} is a numbering of $\{1, 2, \dots, N(p)\} \setminus \bar{\mathbf{j}}$, $\nu(\mathbf{j}) = \mathcal{M}(p) \setminus \nu(\bar{\mathbf{j}})$. Therefore

$\nu(\mathbf{j}) = \{\mathbf{m} : \mathbf{m} \in \mathcal{M}(p) \text{ and there does not exist a multi-index } \mathbf{r} \in \mathcal{M}(p-c) \text{ such that } \mathbf{m} = \mathbf{t} + \mathbf{r}\},$

which means any multi-index $\mathbf{m} \in \nu(\mathbf{j})$ has an index i such that $\mathbf{m}_i < \mathbf{t}_i$. This interpretation of the set $\nu(\mathbf{j})$ can be seen to equal a union of slices as

$$\nu(\mathbf{j}) = \bigcup_{i=1}^d \left(\bigcup_{s=0}^{\mathbf{t}_i-1} S_{i,s} \right).$$

Since $\nu(\mathbf{j})$ is a union of $|\mathbf{t}| = |\nu(h(1))|$ sets (which only depend on the PDE), $\nu(\mathbf{j})$ and in turn \mathbf{j} can be divided into $O(1)$ slices of the form $S_{i,s}$. \square

Theorem 15. *Translating a local expansion in compressed representation around center \mathbf{c}_1 to a local expansion in compressed representation around center \mathbf{c}_2 can be achieved with $O(p^d)$ work.*

Proof. Follows from lemmas 13 and 14. \square

4.3 Multipole-to-Multipole Translation

In the uncompressed case, multipole-to-multipole translation using Taylor series is worked out in some detail below, using the multi-binomial expansion theorem. For the compressed case, we present a method for translating a compressed multipole expansion by assuming that the coefficients of non-stored multi-indices are zero and translating. This results in an uncompressed representation which we then re-compress.

Let α be the coefficients of multipole expansion in the uncompressed representation that is accurate for targets outside a circle with center \mathbf{c}_1 and R_1 . Let T be the translation operator that translates the expansion from center \mathbf{c}_1 to new center \mathbf{c}_2 to obtain a multipole expansion that is accurate outside the circle with center \mathbf{c}_1 and radius $R_2 \geq R_1 + \|\mathbf{c}_2 - \mathbf{c}_1\|$. Let M be the decompression operator and let the multipole-to-multipole translation coefficients for this uncompressed representation be given by

$$\rho = T\alpha. \tag{32}$$

Next, let E be the compressed-to-uncompressed embedding operator, defined by

$$[E\beta]_i = \begin{cases} \beta_i & i \in \mathbf{j}, \\ 0 & i \notin \mathbf{j} \end{cases} \quad (i \in \{1, \dots, N(p)\}).$$

Recall from (24) that the coefficients for the compressed representation were obtained as $\beta = M^T\alpha$. Let $\sigma = TE\beta$, i.e. the uncompressed translation applied to the embedded compressed expansion. Recompressing the result of this translation yields

$$\psi = M^T\sigma = M^TTE\beta = M^TTEM^T\alpha. \tag{33}$$

Compression and translation do not necessarily commute, i.e. $\rho \neq \sigma$ in general. To estimate the impact of this error, we consider the pointwise difference of the two expansions

$$\epsilon(\mathbf{x}) = \mathcal{D}^p G(\mathbf{x} - \mathbf{c}_2)_j^T \psi - \mathcal{D}^p G(\mathbf{x} - \mathbf{c}_2)^T \rho = \mathcal{D}^p G(\mathbf{x} - \mathbf{c}_2)^T (TEM^T\alpha - T\alpha),$$

which is not necessarily zero.

Figure 2 shows a two-dimensional example in schematic form, showing the state of the expansion on a path through compression and translation. In the figure, each lattice point represent a coefficient in $\mathcal{M}(p)$. Assuming only one coefficient is nonzero in the expansion around the first center as in Figure 2(a), the nonzero coefficients of the translated expansion around the new center are shown in Figure 2(d). If one were to compress first, however, two cases arise, shown as the second and third column respectively. The second column shows the more straightforward case of a PDE with terms that are all of the same order (e.g. Laplace). In this case, compress-translate-compress incurs no error. In that case, the single coefficient from panel (a) may become one or more nonzero coefficients

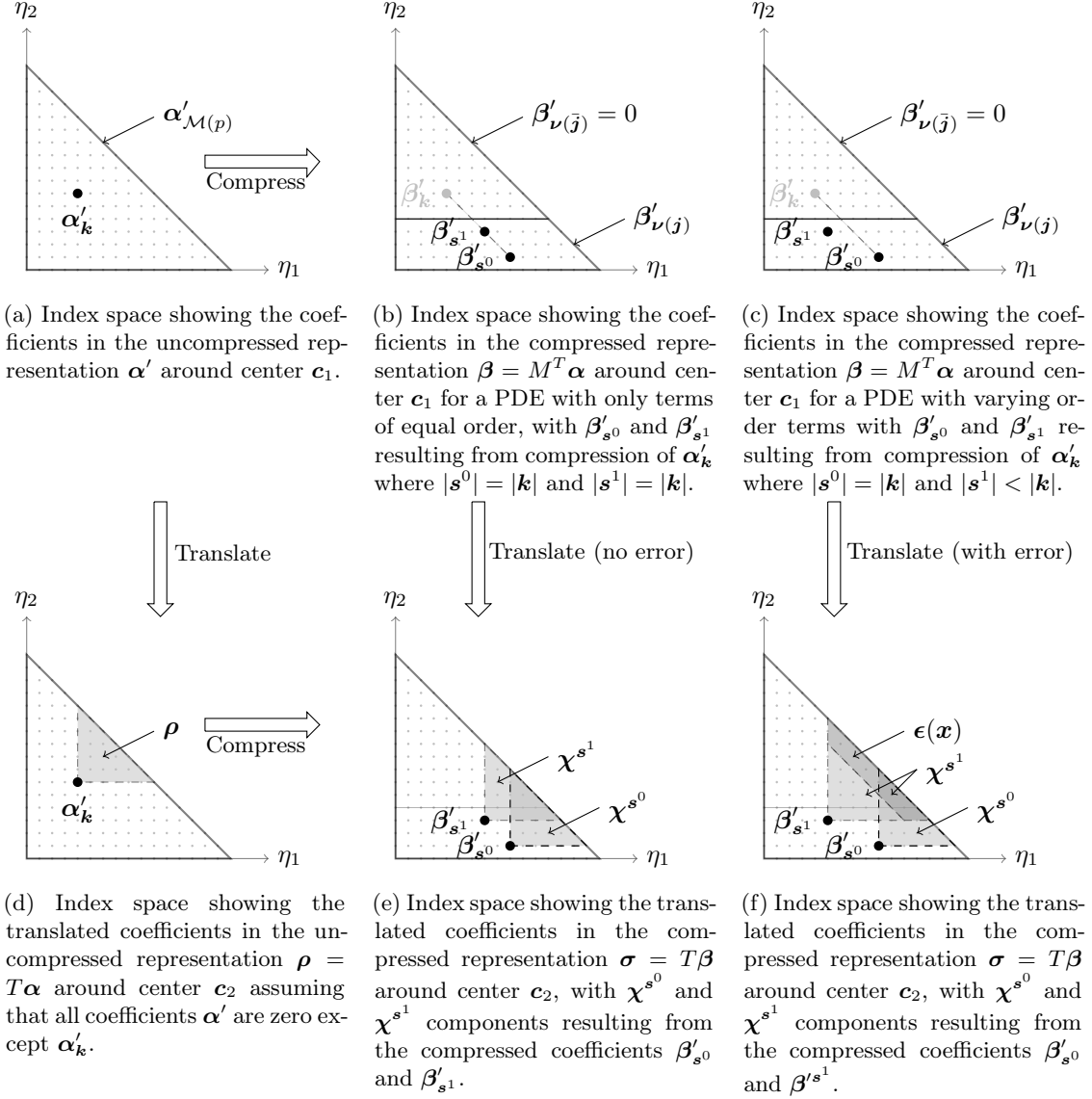

Figure 2: Multipole-to-multipole translation for uncompressed representation and compressed representation

as shown in Figure 2(b). After translation, each of those coefficients spawn a ‘triangle’ of coefficients in the translated expansion, shown in Figure 2(e). In the case of a PDE with terms not all of the same order (e.g. Helmholtz), cf. Figure 2(c), error is incurred, shown schematically in Figure 2(f).

The following lemma will be useful as a technical tool in the discussion that follows. It states that each derivative in $\partial_{\mathbf{x}}^{\mathbf{k}}G(\mathbf{x})$ can be linearly combined from the derivatives in the subset $\mathcal{D}^pG(\mathbf{x})_{\mathbf{j}}$ with order less than or equal to $|\mathbf{k}|$.

Lemma 16. *For $\mathbf{k} \in \mathcal{M}(p)$, there exist coefficients $(v_{\mathbf{k},\mathbf{s}})_{\mathbf{s} \in \nu(\mathbf{j}), |\mathbf{s}| \leq |\mathbf{k}|} \subset \mathbb{C}$ so that*

$$\partial_{\mathbf{x}}^{\mathbf{k}}G(\mathbf{x}) = \sum_{\mathbf{s} \in \nu(\mathbf{j}), |\mathbf{s}| \leq |\mathbf{k}|} v_{\mathbf{k},\mathbf{s}} \partial_{\mathbf{x}}^{\mathbf{s}}G(\mathbf{x}). \quad (34)$$

When G satisfies a PDE with only terms of equal order, then there exist coefficients $(v_{\mathbf{k},\mathbf{s}})_{\mathbf{s} \in \nu(\mathbf{j}), |\mathbf{s}| = |\mathbf{k}|} \subset \mathbb{C}$ such that

$$\partial_{\mathbf{x}}^{\mathbf{k}}G(\mathbf{x}) = \sum_{\mathbf{s} \in \nu(\mathbf{j}), |\mathbf{s}| = |\mathbf{k}|} v_{\mathbf{k},\mathbf{s}} \partial_{\mathbf{x}}^{\mathbf{s}}G(\mathbf{x}). \quad (35)$$

Proof. We use strong induction on $i \in \{1, 2, \dots, N(p)\}$.

Induction hypothesis $H(i)$: There exist $(v_{\mathbf{k},\mathbf{s}})$ so that (34) is true for $\mathbf{k} = \nu(i)$.

Base case $H(1)$: For $i = 1$, we have $\mathbf{k} = \nu(1) = \mathbf{0}$. $\mathbf{0}$ is in $\nu(\mathbf{j})$, allowing a trivial representation in (34).

Induction step $H(1) \wedge \dots \wedge H(n) \implies H(n+1)$: Let the hypothesis be true for $i = 1, \dots, n$. If $n+1 \in \mathbf{j}$, a trivial representation satisfies (34). Suppose that $n+1 \in \bar{\mathbf{j}}$. By definition of $\bar{\mathbf{j}}$, there exists a $w \in \{1, \dots, N(p)\}$ such that $h(w) = n+1$. Taking the w th row of

$$P\mathcal{D}^pG(\mathbf{x}) = 0$$

we find

$$P_{[w,:]}^T \mathcal{D}^pG(\mathbf{x}) = 0.$$

Restated using the definition of P from (15), this is equivalent to

$$\sum_{\ell=1}^{N(p)} b_{\nu(w),\nu(\ell)} \partial_{\mathbf{x}}^{\nu(\ell)}G(\mathbf{x}) = 0.$$

We know that the last nonzero term in the inner product above is in the $(n+1)$ st term, and therefore the order- $\nu(n+1)$ derivative of G can be written as a linear combination of derivatives $\ell \in \{1, \dots, n\}$:

$$\partial_{\mathbf{x}}^{\nu(n+1)}G(\mathbf{x}) = -\frac{1}{b_{\nu(w),\nu(n+1)}} \sum_{\ell=1}^n b_{\nu(w),\nu(\ell)} \partial_{\mathbf{x}}^{\nu(\ell)}G(\mathbf{x}).$$

By the induction hypothesis, $\partial_{\mathbf{x}}^{\nu(\ell)}G(\mathbf{x})$ for $\ell \in \{1, \dots, n\}$ are linear combinations of derivatives in $\mathcal{D}^pG(\mathbf{x})_{\mathbf{j}}$ with order less than or equal to $|\nu(\ell)|$. Since $|\nu(\ell)| \leq |\nu(n+1)|$ for all $\ell \in \{1, \dots, n\}$, the order- $\nu(n+1)$ derivative is also a linear combination of derivatives in $\mathcal{D}^pG(\mathbf{x})_{\mathbf{j}}$ with order less than or equal to $|\nu(n+1)|$.

In the case of a PDE with only terms of equal order, we use the observation that

$$b_{\nu(w),\nu(l)} = 0$$

for $|\nu(l)| \neq \nu(n+1)$, and the proof is analogous to the above. \square

Let

$$\alpha_q = \frac{(\mathbf{c}_1 - \mathbf{y})^{\nu(q)}}{\nu(q)!} \quad (q \in \{1, 2, \dots, N(p)\})$$

be the multipole coefficients around a center $\mathbf{c}_1 \in \mathbb{R}^n$. Then the multipole expansion around center \mathbf{c}_1 evaluated at target point \mathbf{x} with uncompressed representation is

$$\sum_{q=1}^{N(p)} \alpha_q \partial_{\mathbf{x}}^{\nu(q)} G(\mathbf{x} - \mathbf{c}_1) \quad (36)$$

for a target point $\mathbf{x} \in \mathbb{R}^d$. From Section 3.5, we can compress this expansion to get

$$\begin{aligned} \sum_{q=1}^{N(p)} \alpha_q \partial_{\mathbf{x}}^{\nu(q)} G(\mathbf{x} - \mathbf{c}_1) &= \sum_{q \in \mathbf{j}} \beta_q \partial_{\mathbf{x}}^{\nu(q)} G(\mathbf{x} - \mathbf{c}_1) \\ &= \sum_{q=1}^{N(p)} [E\beta]_q \partial_{\mathbf{x}}^{\nu(q)} G(\mathbf{x} - \mathbf{c}_1). \end{aligned}$$

Let $\mathbf{x} \in \mathbb{R}^d$ be a target point, $\mathbf{y} \in \mathbb{R}^d$ be a source point, and

$$\rho_q = \frac{(\mathbf{c}_2 - \mathbf{y})^{\nu(q)}}{\nu(q)!} \quad (q \in \{1, 2, \dots, N(p)\})$$

be the multipole coefficients around the new center $\mathbf{c}_2 \in \mathbb{R}^d$. Similar to (36), the multipole expansion around center \mathbf{c}_1 evaluated at target point \mathbf{x} is

$$\sum_{i=1}^{N(p)} \rho_i \partial_{\mathbf{x}}^{\nu(i)} G(\mathbf{x} - \mathbf{c}_2). \quad (37)$$

Using the multi-binomial theorem, we obtain that the coefficients of a translated expansion, for $q \in \{1, \dots, N(p)\}$,

$$\begin{aligned} \rho_q &= \frac{(\mathbf{c}_2 - \mathbf{y})^{\nu(q)}}{\nu(q)!} = \frac{1}{\nu(q)!} \sum_{i \in \{1, \dots, N(p)\}, \nu(i) \leq \nu(q)} \binom{\nu(q)}{\nu(i)} (\mathbf{c}_2 - \mathbf{c}_1)^{\nu(q) - \nu(i)} (\mathbf{c}_1 - \mathbf{y})^{\nu(i)} \\ &= \frac{1}{\nu(q)!} \sum_{i \in \{1, \dots, N(p)\}, \nu(i) \leq \nu(q)} \binom{\nu(q)}{\nu(i)} \nu(i)! \mathbf{h}^{\nu(q) - \nu(i)} \frac{(\mathbf{c}_1 - \mathbf{y})^{\nu(i)}}{\nu(i)!} \end{aligned}$$

where $\mathbf{h} = \mathbf{c}_2 - \mathbf{c}_1$. This yields for $q \in \{1, \dots, N(p)\}$

$$\rho_q = \sum_{i \in \{1, \dots, N(p)\}, \nu(i) \leq \nu(q)} \frac{\mathbf{h}^{\nu(q) - \nu(i)}}{(\nu(q) - \nu(i))!} \alpha_i. \quad (38)$$

We use this same translation formula for compressed representation with ρ replaced by σ and α replaced by $E\beta$, i.e. for $q \in \{1, \dots, N(p)\}$

$$\sigma_q = \sum_{i \in \{1, \dots, N(p)\}, \nu(i) \leq \nu(q)} \frac{\mathbf{h}^{\nu(q) - \nu(i)}}{(\nu(q) - \nu(i))!} [E\beta]_i. \quad (39)$$

Observe that the expansion with the coefficients σ is not compressed and can be compressed as before to obtain the compressed multipole coefficients for the new center $\psi = M^T \sigma$.

The remainder of this section is divided into three subsections. In Subsection 4.3.1, we show that, in the case of PDEs with only terms of equal order (such as Laplace), the two expansions evaluate to the same value. In Subsection 4.3.2, we show that, using the numbering \mathbf{j} as described in Theorem 7, the error in the multipole-to-multipole translation using compressed representation is asymptotically identical to the truncation error in the original (Taylor) multipole expansion of the potential function. Finally, in Subsection 4.3.3, we give an algorithm to perform this computation with low asymptotic cost.

4.3.1 Compressed Expansions for PDEs with only Terms of Equal Order

Theorem 17. *For a constant-coefficient linear PDE with only terms of equal order, evaluating the multipole expansion resulting from a p th order multipole-to-multipole translation with coefficients in compressed representation is equal to evaluating using a p th order multipole expansion, i.e.*

$$\sum_{n=1}^{N(p)} \sigma_n \partial_{\mathbf{x}}^{\nu(n)} G(\mathbf{x} - \mathbf{c}_2) = \sum_{n=1}^{N(p)} \rho_n \partial_{\mathbf{x}}^{\nu(n)} G(\mathbf{x} - \mathbf{c}_2)$$

where

$$\rho_n = \frac{(\mathbf{c}_2 - \mathbf{y})^{\nu(n)}}{\nu(n)!},$$

$$\sigma_n = \sum_{i \in \{1, \dots, N(p)\}, \nu(i) \leq \nu(n)} \frac{\mathbf{h}^{\nu(n) - \nu(i)}}{(\nu(n) - \nu(i))!} [E\beta]_i,$$

$\mathbf{h} = \mathbf{c}_2 - \mathbf{c}_1$, and β are coefficients of a ‘source’ multipole expansion around center \mathbf{c}_1 in compressed representation.

Proof. Let α be the coefficients of a ‘source’ multipole expansion around center \mathbf{c}_1 in uncompressed representation. Then

$$\beta = M^T \alpha.$$

For $\mathbf{q} \in \mathcal{M}(p)$, we introduce the variables $\alpha'_{\mathbf{q}} = \alpha_{\nu^{-1}(\mathbf{q})}$, $\beta'_{\mathbf{q}} = [E\beta]_{\nu^{-1}(\mathbf{q})}$, $\rho'_{\mathbf{q}} = \rho_{\nu^{-1}(\mathbf{q})}$, and $\sigma'_{\mathbf{q}} = \sigma_{\nu^{-1}(\mathbf{q})}$ to index the coefficients α , $E\beta$, ρ , and σ using multi-indices for the sake of readability. Then we have to show that

$$\sum_{\mathbf{q} \in \mathcal{M}(p)} \sigma'_{\mathbf{q}} \partial_{\mathbf{x}}^{\mathbf{q}} G(\mathbf{x} - \mathbf{c}_2) = \sum_{\mathbf{q} \in \mathcal{M}(p)} \rho'_{\mathbf{q}} \partial_{\mathbf{x}}^{\mathbf{q}} G(\mathbf{x} - \mathbf{c}_2).$$

Without loss of generality, and using linearity, we assume that all multipole coefficients α' are zero, except for $\alpha'_{\mathbf{k}}$ for some $\mathbf{k} \in \mathcal{M}(p)$. Using Lemma 16,

$$\partial_{\mathbf{x}}^{\mathbf{k}} G(\mathbf{x} - \mathbf{c}_2) = \sum_{\mathbf{s} \in \nu(j), |\mathbf{s}| = |\mathbf{k}|} v_{\mathbf{k}, \mathbf{s}} \partial_{\mathbf{x}}^{\mathbf{s}} G(\mathbf{x} - \mathbf{c}_2), \quad (40)$$

where $v_{\mathbf{k}, \mathbf{s}}$ are constants. In this equation, we have the condition that $|\mathbf{s}| = |\mathbf{k}|$ because the PDE has only terms of equal order. Consider the term $\alpha'_{\mathbf{k}} \partial_{\mathbf{x}}^{\mathbf{k}} G$ in multipole evaluation. Using (40), it can be expanded as

$$\alpha'_{\mathbf{k}} \partial_{\mathbf{x}}^{\mathbf{k}} G(\mathbf{x} - \mathbf{c}_2) = \sum_{\mathbf{s} \in \nu(j), |\mathbf{s}| = |\mathbf{k}|} \alpha'_{\mathbf{k}} v_{\mathbf{k}, \mathbf{s}} \partial_{\mathbf{x}}^{\mathbf{s}} G(\mathbf{x} - \mathbf{c}_2). \quad (41)$$

Then the left-hand side is the multipole expansion in uncompressed representation, and the right-hand side is the multipole expansion in compressed representation. Embedding the compressed coefficients in the uncompressed coefficient space results in

$$\beta'_{\mathbf{s}} = [E\beta]_{\nu^{-1}(\mathbf{s})} = \begin{cases} \alpha'_{\mathbf{k}} v_{\mathbf{k}, \mathbf{s}} & \text{for } \mathbf{s} \in \nu(j) \text{ and } |\mathbf{s}| = |\mathbf{k}|, \\ 0 & \text{otherwise.} \end{cases} \quad (42)$$

Since only the coefficient $\alpha'_{\mathbf{k}}$ is nonzero in the uncompressed expansion for the center \mathbf{c}_1 ,

$$\rho'_{\mathbf{q}} = \begin{cases} \frac{\mathbf{h}^{\mathbf{q} - \mathbf{k}}}{(\mathbf{q} - \mathbf{k})!} \alpha'_{\mathbf{k}} & \text{for } \mathbf{q} \geq \mathbf{k}, \\ 0 & \text{otherwise.} \end{cases} \quad (43)$$

In other words, the nonzero translated coefficients resulting from α'_k have multi-indices $\mathbf{q} = \mathbf{k} + \boldsymbol{\ell}$ where $\boldsymbol{\ell} \geq \mathbf{0}$ is a multi-index, and

$$\rho'_{\mathbf{k}+\boldsymbol{\ell}} = \frac{h^\ell}{\ell!} \alpha'_k \quad (|\mathbf{k} + \boldsymbol{\ell}| \in \mathcal{M}(p)). \quad (44)$$

Let

$$\chi_q^s = \begin{cases} \frac{h^{q-s}}{(q-s)!} \beta'_s & \text{for } \mathbf{q} \geq \mathbf{s}, \\ 0 & \text{otherwise} \end{cases} \quad (45)$$

be the component of the translated coefficient σ_q resulting from the (compressed) ‘source’ multipole coefficient β'_s , where $\mathbf{q}, \mathbf{s} \in \mathcal{M}(p)$. Figure 2(e) shows values of $\mathbf{s}, \mathbf{q} \in \mathcal{M}(p)$ where χ is non-zero. Using the definition of σ (via σ'),

$$\sum_{\mathbf{q} \in \mathcal{M}(p)} \sigma'_q \partial_x^q G(\mathbf{x} - \mathbf{c}_2) = \sum_{\mathbf{q} \in \mathcal{M}(p)} \left(\sum_{\mathbf{s} \leq \mathbf{q}} \chi_q^s \partial_x^s \right) G(\mathbf{x} - \mathbf{c}_2). \quad (46)$$

Replacing $\mathbf{q} = \mathbf{s} + \boldsymbol{\ell}$ we have,

$$\begin{aligned} \sum_{\mathbf{q} \in \mathcal{M}(p)} \sigma'_q \partial_x^q G(\mathbf{x} - \mathbf{c}_2) &\stackrel{(46)}{=} \sum_{\boldsymbol{\ell} \in \mathcal{M}(p)} \left(\sum_{\mathbf{s} \in \mathcal{M}(p), |\mathbf{s}+\boldsymbol{\ell}| \leq p} \chi_{\mathbf{s}+\boldsymbol{\ell}}^{\mathbf{s}} \partial_x^{\mathbf{s}+\boldsymbol{\ell}} \right) G(\mathbf{x} - \mathbf{c}_2) \\ &\stackrel{(45)}{=} \sum_{\boldsymbol{\ell} \in \mathcal{M}(p)} \left(\sum_{\mathbf{s} \in \mathcal{M}(p), |\mathbf{s}+\boldsymbol{\ell}| \leq p} \frac{h^\ell}{\ell!} \beta'_s \partial_x^{\mathbf{s}+\boldsymbol{\ell}} \right) G(\mathbf{x} - \mathbf{c}_2) \\ &\stackrel{(42)}{=} \sum_{\boldsymbol{\ell} \in \mathcal{M}(p)} \left(\sum_{\mathbf{s} \in \nu(\mathbf{j}), |\mathbf{s}|=|\mathbf{k}|, |\mathbf{s}+\boldsymbol{\ell}| \leq p} \frac{h^\ell}{\ell!} \alpha'_k v_{\mathbf{k},\mathbf{s}} \partial_x^{\mathbf{s}+\boldsymbol{\ell}} \right) G(\mathbf{x} - \mathbf{c}_2) \\ &= \sum_{\boldsymbol{\ell} \in \mathcal{M}(p), |\mathbf{k}+\boldsymbol{\ell}| \leq p} \left(\frac{h^\ell}{\ell!} \partial_x^\ell \sum_{\mathbf{s} \in \nu(\mathbf{j}), |\mathbf{s}|=|\mathbf{k}|} \alpha'_k v_{\mathbf{k},\mathbf{s}} \partial_x^{\mathbf{s}} G(\mathbf{x} - \mathbf{c}_2) \right) \\ &\stackrel{(41)}{=} \sum_{\boldsymbol{\ell} \in \mathcal{M}(p), |\mathbf{k}+\boldsymbol{\ell}| \leq p} \frac{h^\ell}{\ell!} \partial_x^\ell \alpha'_k \partial_x^{\mathbf{k}} G(\mathbf{x} - \mathbf{c}_2) \\ &\stackrel{(44)}{=} \sum_{\boldsymbol{\ell} \in \mathcal{M}(p), |\mathbf{k}+\boldsymbol{\ell}| \leq p} \rho'_{\mathbf{k}+\boldsymbol{\ell}} \partial_x^{\mathbf{k}+\boldsymbol{\ell}} G(\mathbf{x} - \mathbf{c}_2) \stackrel{\mathbf{k}+\boldsymbol{\ell}=\mathbf{q}}{=} \sum_{\mathbf{q} \in \mathcal{M}(p), \mathbf{q} \geq \mathbf{k}} \rho'_q \partial_x^q G(\mathbf{x} - \mathbf{c}_2) \\ &\stackrel{(43)}{=} \sum_{\mathbf{q} \in \mathcal{M}(p)} \rho'_q \partial_x^q G(\mathbf{x} - \mathbf{c}_2), \end{aligned}$$

completing the argument. \square

Figure 2(e) shows the values of \mathbf{s}, \mathbf{q} in $\mathcal{M}(p)$ where χ is non-zero and the proof uses the observation that the area of each triangle in the figure is equal to the area of the triangle in Figure 2(b).

4.3.2 Compressed Expansions for PDEs with Terms of Varying Order

A novel difficulty presented by the case of PDEs with terms of varying order is that nonzero coefficients $v_{\mathbf{k},\mathbf{s}}$ with $|\mathbf{k}| \neq |\mathbf{s}|$ will occur (cf. Lemma 16). Necessarily, the $v_{\mathbf{k},\mathbf{s}}$ have spatial scaling behavior depending on $|\mathbf{k}| - |\mathbf{s}|$. To capture the dependency of the coefficients $v_{\mathbf{k},\mathbf{s}}$ on spatial scaling, we assume that

$$|v_{\mathbf{k},\mathbf{s}} a^{|\mathbf{k}|-|\mathbf{s}|} < M' \quad (47)$$

for $\mathbf{k} \in \mathcal{M}(p)$ and $\mathbf{s} \in \nu(\mathbf{j})$ and for some constant M' , where a is the assumed maximum FMM box size for which the bound (3) holds.

Remark 18. For the Helmholtz equation, it can be shown that the dependency of $v_{\mathbf{k},\mathbf{s}}$ on κ can be isolated as follows:

$$v_{\mathbf{k},\mathbf{s}} = \kappa^{|\mathbf{k}|-|\mathbf{s}|} D_{\mathbf{k},\mathbf{s}}$$

for all $\kappa > 0$, where $D_{\mathbf{k},\mathbf{s}}$ independent of κ . Thus, assuming

$$a\kappa < 1 \tag{48}$$

leads to

$$|v_{\mathbf{k},\mathbf{s}} a^{|\mathbf{k}|-|\mathbf{s}|}| = |(a\kappa)^{|\mathbf{k}|-|\mathbf{s}|} D_{\mathbf{k},\mathbf{s}}| \leq \max_{\mathbf{k},\mathbf{s}} |D_{\mathbf{k},\mathbf{s}}| = M',$$

establishing a version of (47). Operationally, this amounts to limiting the box size with respect to the Helmholtz wave number, an approach that is already commonly taken for the ‘low-frequency’ expansions as part of a wide-band FMM, cf. [Cheng et al., 2006]. In Section 5.1, we further present numerical evidence suggesting that the accuracy impact of (47) is no worse than that imposed by the use of Cartesian expansions in the first place.

We next state our main accuracy result for multipole-to-multipole translations for PDEs with varying order.

Theorem 19. Let α be the coefficients of a ‘source’ multipole expansion in uncompressed representation and accurate outside a circle centered at \mathbf{c}_1 with radius R_1 , and let ρ be the coefficients of a ‘target’ multipole expansion in uncompressed representation accurate around center \mathbf{c}_2 with radius $R_2 \geq R_1 + \|\mathbf{c}_2 - \mathbf{c}_1\|$ (cf. Figure 5). Let β be the coefficients of a ‘source’ multipole expansion around center \mathbf{c}_1 in compressed representation, and let σ be the coefficients of a ‘target’ multipole expansion around center \mathbf{c}_2 translated from the expansion with coefficients β , i.e.,

$$\rho_n = \sum_{i \in \{1, \dots, N(p)\}, \nu(i) \leq \nu(n)} \frac{\mathbf{h}^{\nu(n)-\nu(i)}}{(\nu(n) - \nu(i))!} \alpha_i \quad (n \in \{1, \dots, N(p)\}), \tag{49}$$

$$\sigma_n = \sum_{i \in \{1, \dots, N(p)\}, \nu(i) \leq \nu(n)} \frac{\mathbf{h}^{\nu(n)-\nu(i)}}{(\nu(n) - \nu(i))!} [E\beta]_i \quad (n \in \{1, \dots, N(p)\}), \tag{50}$$

where $\mathbf{x} \in \mathbb{R}^d$ is a target point and $\mathbf{h} = \mathbf{c}_3 - \mathbf{c}_1$.

Assume that $|v_{\mathbf{k},\mathbf{s}} a^{|\mathbf{k}|-|\mathbf{s}|}| < M'$ for $\mathbf{k} \in \mathcal{M}(p)$ and $\mathbf{s} \in \nu(\mathbf{j})$ (cf. (47)). Then the difference in the potential calculated at the target point between the compressed expansion and the uncompressed expansion obeys a bound identical to (7) aside from the constant, i.e. for $\|\mathbf{x} - \mathbf{c}_2\| > a$,

$$|\epsilon(\mathbf{x})| = \left| \sum_{n=1}^{N(p)} \sigma_n \partial_{\mathbf{x}}^{\nu(n)} G(\mathbf{x} - \mathbf{c}_2) - \sum_{n=1}^{N(p)} \rho_n \partial_{\mathbf{x}}^{\nu(n)} G(\mathbf{x} - \mathbf{c}_2) \right| \leq \frac{A'' R_2^{p+1}}{\|\mathbf{x} - \mathbf{c}_2\|^{p+p'} (\|\mathbf{x} - \mathbf{c}_2\| - R_2)}$$

where A'' is a constant depending on p .

Proof. Let α be the coefficients of a ‘source’ multipole expansion around center \mathbf{c}_1 in uncompressed representation. Then

$$\beta = M^T \alpha.$$

Likewise, let ρ and σ be as defined in (49) and (50).

Define α', ρ', σ' as versions of their un-primed counterparts indexed by multi-indices directly as before. As in Theorem 17, let

$$\chi_{\mathbf{q}}^{\mathbf{s}} = \begin{cases} \frac{\mathbf{h}^{\mathbf{q}-\mathbf{s}}}{(\mathbf{q}-\mathbf{s})!} \beta'_{\mathbf{s}} & \text{for } \mathbf{q} \geq \mathbf{s}, \\ 0 & \text{otherwise.} \end{cases} \tag{51}$$

Without loss of generality, and using linearity, we assume that all multipole coefficients α' are zero, except for α'_k for some $k \in \mathcal{M}(p)$. Embedding the compressed coefficients β in the uncompressed representation results in

$$\beta'_s = [E\beta]_{\nu^{-1}(s)} = \begin{cases} \alpha'_k v_{k,s} & \text{for } s \in \nu(j) \text{ and } |s| \leq |k|, \\ 0 & \text{otherwise,} \end{cases} \quad (52)$$

where $s \in \mathcal{M}(p)$. We need to show that

$$\epsilon(\mathbf{x}) = \sum_{\mathbf{q} \in \mathcal{M}(p)} \sigma'_q \partial_{\mathbf{x}}^q G(\mathbf{x} - \mathbf{c}_2) - \sum_{\mathbf{q} \in \mathcal{M}(p)} \rho'_q \partial_{\mathbf{x}}^q G(\mathbf{x} - \mathbf{c}_2)$$

obeys the desired bound. Similar to (40), using Lemma 16,

$$\partial_{\mathbf{x}}^k G(\mathbf{x} - \mathbf{c}_2) = \sum_{s \in \nu(j), |s| \leq |k|} v_{k,s} \partial_{\mathbf{x}}^s G(\mathbf{x} - \mathbf{c}_2), \quad (53)$$

where $v_{k,s}$ are constants. Unlike (40), we sum over $|s| \leq |k|$ because the PDE has terms of varying order. Since (by assumption) only the coefficient α'_k is nonzero in the uncompressed expansion for center \mathbf{c}_1 and $\mathbf{q} \in \mathcal{M}(p)$, ρ' satisfies (43) and (44). Using (50) and evaluating the multipole expansion yields

$$\begin{aligned} \sum_{\mathbf{q} \in \mathcal{M}(p)} \sigma'_q \partial_{\mathbf{x}}^q G(\mathbf{x} - \mathbf{c}_2) &= \sum_{\mathbf{q} \in \mathcal{M}(p)} \left(\sum_{s \leq q} \chi_q^s \partial_{\mathbf{x}}^s \right) G(\mathbf{x} - \mathbf{c}_2) \\ &= \sum_{s \in \mathcal{M}(p)} \left(\sum_{\mathbf{q} \in \mathcal{M}(p), s \leq \mathbf{q}} \chi_q^s \partial_{\mathbf{x}}^q \right) G(\mathbf{x} - \mathbf{c}_2). \end{aligned} \quad (54)$$

Replacing $\mathbf{q} = \mathbf{s} + \boldsymbol{\ell}$,

$$\begin{aligned}
\sum_{\mathbf{q} \in \mathcal{M}(p)} \sigma'_{\mathbf{q}} \partial_{\mathbf{x}}^{\mathbf{q}} G(\mathbf{x} - \mathbf{c}_2) &\stackrel{(54)}{=} \sum_{\mathbf{s} \in \mathcal{M}(p)} \left(\sum_{\boldsymbol{\ell} \in \mathcal{M}(p-|\mathbf{s}|)} \chi_{\mathbf{s}+\boldsymbol{\ell}}^{\mathbf{s}} \partial_{\mathbf{x}}^{\mathbf{s}+\boldsymbol{\ell}} \right) G(\mathbf{x} - \mathbf{c}_2) \\
&\stackrel{(51)}{=} \sum_{\mathbf{s} \in \mathcal{M}(p)} \left(\sum_{\boldsymbol{\ell} \in \mathcal{M}(p-|\mathbf{s}|)} \frac{\mathbf{h}^{\boldsymbol{\ell}}}{\boldsymbol{\ell}!} \beta'_{\mathbf{s}} \partial_{\mathbf{x}}^{\mathbf{s}+\boldsymbol{\ell}} \right) G(\mathbf{x} - \mathbf{c}_2) \\
&\stackrel{(52)}{=} \sum_{\mathbf{s} \in \nu(\mathbf{j}), |\mathbf{s}| \leq |\mathbf{k}|} \left(\sum_{\boldsymbol{\ell} \in \mathcal{M}(p-|\mathbf{s}|)} \frac{\mathbf{h}^{\boldsymbol{\ell}}}{\boldsymbol{\ell}!} \alpha'_{\mathbf{k}} v_{\mathbf{k},\mathbf{s}} \partial_{\mathbf{x}}^{\mathbf{s}+\boldsymbol{\ell}} \right) G(\mathbf{x} - \mathbf{c}_2) \\
&= \sum_{\mathbf{s} \in \nu(\mathbf{j}), |\mathbf{s}| \leq |\mathbf{k}|} \left(\sum_{\boldsymbol{\ell} \in \mathcal{M}(p-|\mathbf{k}|)} \frac{\mathbf{h}^{\boldsymbol{\ell}}}{\boldsymbol{\ell}!} \alpha'_{\mathbf{k}} v_{\mathbf{k},\mathbf{s}} \partial_{\mathbf{x}}^{\mathbf{s}+\boldsymbol{\ell}} \right. \\
&\quad + \sum_{\boldsymbol{\ell} \in \mathcal{M}(p), p-|\mathbf{k}| < |\boldsymbol{\ell}| \leq p-|\mathbf{s}|} \left. \frac{\mathbf{h}^{\boldsymbol{\ell}}}{\boldsymbol{\ell}!} \alpha'_{\mathbf{k}} v_{\mathbf{k},\mathbf{s}} \partial_{\mathbf{x}}^{\mathbf{s}+\boldsymbol{\ell}} \right) G(\mathbf{x} - \mathbf{c}_2) \\
&= \sum_{\boldsymbol{\ell} \in \mathcal{M}(p-|\mathbf{k}|)} \frac{\mathbf{h}^{\boldsymbol{\ell}}}{\boldsymbol{\ell}!} \alpha'_{\mathbf{k}} \left(\sum_{\mathbf{s} \in \nu(\mathbf{j}), |\mathbf{s}| \leq |\mathbf{k}|} v_{\mathbf{k},\mathbf{s}} \partial_{\mathbf{x}}^{\mathbf{s}} \right) \partial_{\mathbf{x}}^{\boldsymbol{\ell}} G(\mathbf{x} - \mathbf{c}_2) \\
&\quad + \underbrace{\sum_{\mathbf{s} \in \nu(\mathbf{j}), |\mathbf{s}| \leq |\mathbf{k}|} \left(\sum_{\boldsymbol{\ell} \in \mathcal{M}(p), p-|\mathbf{k}| < |\boldsymbol{\ell}| \leq p-|\mathbf{s}|} \frac{\mathbf{h}^{\boldsymbol{\ell}}}{\boldsymbol{\ell}!} \alpha'_{\mathbf{k}} v_{\mathbf{k},\mathbf{s}} \partial_{\mathbf{x}}^{\mathbf{s}+\boldsymbol{\ell}} \right)}_{\epsilon'(\mathbf{x})} G(\mathbf{x} - \mathbf{c}_2) \\
&\stackrel{(53)}{=} \sum_{\boldsymbol{\ell} \in \mathcal{M}(p-|\mathbf{k}|)} \frac{\mathbf{h}^{\boldsymbol{\ell}}}{\boldsymbol{\ell}!} \alpha'_{\mathbf{k}} \partial_{\mathbf{x}}^{\mathbf{k}+\boldsymbol{\ell}} G(\mathbf{x} - \mathbf{c}_2) + \epsilon'(\mathbf{x}) \\
&\stackrel{(44)}{=} \sum_{\boldsymbol{\ell} \in \mathcal{M}(p-|\mathbf{k}|)} \rho'_{\mathbf{k}+\boldsymbol{\ell}} \partial_{\mathbf{x}}^{\mathbf{k}+\boldsymbol{\ell}} G(\mathbf{x} - \mathbf{c}_2) + \epsilon'(\mathbf{x}) \\
&\stackrel{\mathbf{k}+\boldsymbol{\ell}=\mathbf{q}}{=} \sum_{\mathbf{q} \in \mathcal{M}(p)} \rho'_{\mathbf{q}} \partial_{\mathbf{x}}^{\mathbf{q}} G(\mathbf{x} - \mathbf{c}_2) + \epsilon'(\mathbf{x}).
\end{aligned}$$

From the above equality, it becomes clear that ϵ' as defined in the derivation matches the error ϵ which we are seeking to bound. As a result,

$$\begin{aligned}
\epsilon(\mathbf{x}) = \epsilon'(\mathbf{x}) &= \sum_{\mathbf{s} \in \nu(\mathbf{j}), |\mathbf{s}| \leq |\mathbf{k}|} \left(\sum_{\boldsymbol{\ell} \in \mathcal{M}(p), p-|\mathbf{k}| < |\boldsymbol{\ell}| \leq p-|\mathbf{s}|} \frac{\mathbf{h}^{\boldsymbol{\ell}}}{\boldsymbol{\ell}!} \alpha'_{\mathbf{k}} v_{\mathbf{k},\mathbf{s}} \partial_{\mathbf{x}}^{\mathbf{s}+\boldsymbol{\ell}} \right) G(\mathbf{x} - \mathbf{c}_2) \\
&= \sum_{\mathbf{s} \in \nu(\mathbf{j}), |\mathbf{s}| < |\mathbf{k}|} \left(\sum_{\boldsymbol{\ell} \in \mathcal{M}(p), p-|\mathbf{k}| < |\boldsymbol{\ell}| \leq p-|\mathbf{s}|} \frac{\mathbf{h}^{\boldsymbol{\ell}}}{\boldsymbol{\ell}!} \alpha'_{\mathbf{k}} v_{\mathbf{k},\mathbf{s}} \partial_{\mathbf{x}}^{\mathbf{s}+\boldsymbol{\ell}} \right) G(\mathbf{x} - \mathbf{c}_2), \quad (55)
\end{aligned}$$

where the change in sum bounds in the last step is justified because the inner sum is empty in the case of $|\mathbf{s}| = |\mathbf{k}|$.

All terms in the double sum in (55) are of the form

$$\frac{\mathbf{h}^{\boldsymbol{\ell}}}{\boldsymbol{\ell}!} \alpha'_{\mathbf{k}} v_{\mathbf{k},\mathbf{s}} \partial_{\mathbf{x}}^{\mathbf{s}+\boldsymbol{\ell}} G(\mathbf{x} - \mathbf{c}_2)$$

for $\mathbf{s}, \boldsymbol{\ell} \in \mathcal{M}(p)$, $|\boldsymbol{\ell}| > p - |\mathbf{k}|$, and $|\mathbf{s}| < |\mathbf{k}|$, which yields $|\mathbf{k} + \boldsymbol{\ell}| \geq p + 1$. Therefore, $\|\mathbf{c}_2 - \mathbf{c}_1\| \leq$

$R_2 - R_1 \leq R_2$, $\|\mathbf{c}_1 - \mathbf{y}\| \leq R_1 \leq R_2$ and $\|\mathbf{x} - \mathbf{c}_2\| \leq a$. Therefore

$$\begin{aligned}
\left| \frac{\mathbf{h}^\ell}{\ell!} \boldsymbol{\alpha}'_{\mathbf{k}} v_{\mathbf{k},\mathbf{s}} \partial_{\mathbf{x}}^{s+\ell} G(\mathbf{x} - \mathbf{c}_2) \right| &= \left| \frac{(\mathbf{c}_2 - \mathbf{c}_1)^\ell (\mathbf{c}_1 - \mathbf{y})^{\mathbf{k}}}{\ell! \mathbf{k}!} v_{\mathbf{k},\mathbf{s}} \partial_{\mathbf{x}}^{s+\ell} G(\mathbf{x} - \mathbf{c}_2) \right| \\
&\stackrel{(3)}{\leq} \frac{M |v_{\mathbf{k},\mathbf{s}}|}{\mathbf{k}! \ell!} \frac{R_2^{|\mathbf{k}+\ell|}}{\|\mathbf{x} - \mathbf{c}_2\|^{s+\ell+p'}} \\
&= \frac{M |v_{\mathbf{k},\mathbf{s}}|}{\mathbf{k}! \ell!} \left(\frac{R_2}{\|\mathbf{x} - \mathbf{c}_2\|} \right)^{|\mathbf{k}+\ell|} \frac{\|\mathbf{x} - \mathbf{c}_2\|^{|\mathbf{k}|-|\mathbf{s}|}}{\|\mathbf{x} - \mathbf{c}_2\|^{p'}} \\
&\leq \frac{M}{\mathbf{k}! \ell! \|\mathbf{x} - \mathbf{c}_2\|^{p'}} |v_{\mathbf{k},\mathbf{s}}| \|\mathbf{x} - \mathbf{c}_2\|^{|\mathbf{k}|-|\mathbf{s}|} \left(\frac{R_2}{\|\mathbf{x} - \mathbf{c}_2\|} \right)^{p+1} \quad (56) \\
&\leq \frac{M}{\mathbf{k}! \ell! \|\mathbf{x} - \mathbf{c}_2\|^{p'}} |v_{\mathbf{k},\mathbf{s}}| a^{|\mathbf{k}|-|\mathbf{s}|} \left(\frac{R_2}{\|\mathbf{x} - \mathbf{c}_2\|} \right)^{p+1} \\
&\stackrel{(47)}{\leq} \frac{MM'}{\mathbf{k}! \ell! \|\mathbf{x} - \mathbf{c}_2\|^{p'}} \left(\frac{R_2}{\|\mathbf{x} - \mathbf{c}_2\|} \right)^{p+1} \\
&\leq \frac{MM'}{\mathbf{k}! \ell!} \frac{R_2^{p+1}}{\|\mathbf{x} - \mathbf{c}_2\|^{p+p'} (\|\mathbf{x} - \mathbf{c}_2\| - R_2)}.
\end{aligned}$$

Therefore, as claimed, there exists a constant A'' such that

$$|\epsilon(\mathbf{x})| \leq A'' \frac{R_2^{p+1}}{\|\mathbf{x} - \mathbf{c}_2\|^{p+p'} (\|\mathbf{x} - \mathbf{c}_2\| - R_2)}.$$

□

The terms making up ϵ (or, equivalently, ϵ') are shown in Figure 2(f), represented as the ‘overhanging’ χ elements compared to the χ elements in Figure 2(d).

4.3.3 Asymptotically Faster Multipole-to-Multipole Translation

Using the multipole-to-multipole translation procedure as described thus far, shifting the center of a multipole expansion requires calculating each of the $O(p^d)$ coefficients at the new center from $O(p^{d-1})$ coefficients around the old center and then compressing them. A straightforward approach might use $O(p^{d-1})$ operations per target coefficient, resulting in an overall algorithm with $O(p^{2d-1})$ operations. The asymptotic cost of this algorithm can be improved by making use of the Cartesian structure and storing intermediate results.

Theorem 20. *Translating a multipole expansion in compressed representation around center \mathbf{c}_1 to a multipole expansion in compressed representation around center \mathbf{c}_2 can be achieved with $O(p^d)$ operations.*

Proof. Let $\boldsymbol{\alpha}'_{\boldsymbol{\nu}(i)} = \boldsymbol{\alpha}_i$ and $\boldsymbol{\rho}'_{\boldsymbol{\nu}(i)} = \boldsymbol{\rho}_i$ for $i \in \{1, \dots, N(p)\}$. Consider a version of (38) in three dimensions. Let $\boldsymbol{\nu}(q) = (\eta_1, \eta_2, \eta_3)$, $\boldsymbol{\nu}(i) = (\zeta_1, \zeta_2, \zeta_3)$ and $\mathbf{h} = \mathbf{c}_2 - \mathbf{c}_1$.

$$\begin{aligned}
\rho'_{\eta_1, \eta_2, \eta_3} &= \sum_{\zeta_3=0}^{\eta_3} \sum_{\zeta_2=0}^{\eta_2} \sum_{\zeta_1=0}^{\eta_1} \frac{\mathbf{h}_1^{\eta_1-\zeta_1}}{(\eta_1-\zeta_1)!} \frac{\mathbf{h}_2^{\eta_2-\zeta_2}}{(\eta_2-\zeta_2)!} \frac{\mathbf{h}_3^{\eta_3-\zeta_3}}{(\eta_3-\zeta_3)!} \boldsymbol{\alpha}'_{\zeta_1, \zeta_2, \zeta_3} \\
&= \sum_{\zeta_3=0}^{\eta_3} \underbrace{\left(\sum_{\zeta_2=0}^{\eta_2} \sum_{\zeta_1=0}^{\eta_1} \frac{\mathbf{h}_1^{\eta_1-\zeta_1}}{(\eta_1-\zeta_1)!} \frac{\mathbf{h}_2^{\eta_2-\zeta_2}}{(\eta_2-\zeta_2)!} \boldsymbol{\alpha}'_{\zeta_1, \zeta_2, \zeta_3} \right)}_{\boldsymbol{\xi}_{\eta_1, \eta_2, \zeta_3}} \frac{\mathbf{h}_3^{\eta_3-\zeta_3}}{(\eta_3-\zeta_3)!}
\end{aligned}$$

Let

$$\xi_{\eta_1, \eta_2, \zeta_3} = \sum_{\zeta_2=0}^{\eta_2} \frac{h_2^{\eta_2-\zeta_2}}{(\eta_2-\zeta_2)!} \underbrace{\left(\sum_{\zeta_1=0}^{\eta_1} \frac{h_1^{\eta_1-\zeta_1}}{(\eta_1-\zeta_1)!} \alpha'_{\zeta_1, \zeta_2, \zeta_3} \right)}_{\xi'_{\eta_1, \zeta_2, \zeta_3}} \quad \text{for } (\eta_1, \eta_2, \zeta_3) \in \mathcal{M}(p)$$

and let

$$\xi'_{\eta_1, \zeta_2, \zeta_3} = \sum_{\zeta_1=0}^{\eta_1} \frac{h_1^{\eta_1-\zeta_1}}{(\eta_1-\zeta_1)!} \alpha'_{\zeta_1, \zeta_2, \zeta_3} \quad \text{for } (\eta_1, \zeta_2, \zeta_3) \in \mathcal{M}(p).$$

Since the values of ξ' and ξ are reused for different ρ' s, precomputing and storing them removes redundant work. Precomputing ξ' first, then precomputing ξ using ξ' , and finally computing ρ' using ξ requires calculating a sum of $O(p)$ terms for $O(p^3)$ elements each, leading to a $O(p^4)$ algorithm. The analogous algorithm in two dimensions has two nested summations and thus requires $O(p^3)$ operations. A straightforward generalization yields an algorithm with $O(p^{d+1})$ operations in d dimensions.

The above algorithm is stated for expansions in uncompressed representation. Replacing α' by β' and ρ' by σ' straightforwardly yields an algorithm for expansions in compressed representation with complexity $O(p^{d+1})$, the same as the uncompressed case. To obtain an improvement in the complexity, realize that $\beta'_{\nu(i)} = [E\beta]_i = 0$ when $i \in \mathbf{j}$ where \mathbf{j} is the set of multi-indices in the compressed representation as defined in Theorem 7. By the resulting reduction in the number of source multipole coefficients, the translation require $O(p^d)$ operations in the compressed case.

To see that this works even in the general case of multiple orientations of coefficient hyperplanes (for example the two dark black hyperplanes in Figure 1c for the PDE $\partial^2/\partial x\partial y = 0$), consider the two-dimensional case, in which the translation operator is given by

$$\sigma'_{\eta_1, \eta_2} = \sum_{\zeta_2=0}^{\eta_2} \sum_{\zeta_1=0}^{\eta_1} \frac{h_1^{\eta_1-\zeta_1}}{(\eta_1-\zeta_1)!} \frac{h_2^{\eta_2-\zeta_2}}{(\eta_2-\zeta_2)!} \beta'_{\zeta_1, \zeta_2}.$$

Let $\mathbf{t} = \nu(h(1))$. Then assume that the set of multi-indices for the compressed representation is

$$\nu(\mathbf{j}) = \{(\zeta_1, \zeta_2) : \zeta_1 \in \{0, \dots, \mathbf{t}_1\}, \zeta_1 + \zeta_2 \leq p\} \cup \{(\zeta_1, \zeta_2) : \zeta_2 \in \{(0, \dots, \mathbf{t}_2)\}, \zeta_1 + \zeta_2 \leq p\},$$

which implies that, $\beta'_{\zeta_1, \zeta_2} = 0$ if $\zeta_1 > \mathbf{t}_1$ and $\zeta_2 > \mathbf{t}_2$. Separating the coefficient sets by hyperplane orientation and collecting subexpressions for each analogously to the above, we find

$$\begin{aligned} \sigma'_{\eta_1, \eta_2} &= \sum_{\zeta_2=0}^{\min(\mathbf{t}_2, \eta_2)} \left(\frac{h_2^{\eta_2-\zeta_2}}{(\eta_2-\zeta_2)!} \sum_{\zeta_1=0}^{\eta_1} \frac{h_1^{\eta_1-\zeta_1}}{(\eta_1-\zeta_1)!} \beta'_{\zeta_1, \zeta_2} \right) \\ &\quad + \sum_{\zeta_1=0}^{\min(\mathbf{t}_1, \eta_1)} \left(\frac{h_1^{\eta_1-\zeta_1}}{(\eta_1-\zeta_1)!} \sum_{\zeta_2=\mathbf{t}_2+1}^{\eta_2} \frac{h_2^{\eta_2-\zeta_2}}{(\eta_2-\zeta_2)!} \beta'_{\zeta_1, \zeta_2} \right) \\ &= \sum_{\zeta_2=0}^{\min(\mathbf{t}_2, \eta_2)} \left(\tau_{\eta_1, \zeta_2}^1 \frac{h_2^{\eta_2}}{\eta_2!} \right) + \sum_{\zeta_1=0}^{\min(\mathbf{t}_1, \eta_1)} \left(\tau_{\zeta_1, \eta_2}^2 \frac{h_1^{\eta_1}}{\eta_1!} \right), \end{aligned}$$

where

$$\begin{aligned} \tau_{\eta_1, \zeta_2}^1 &= \sum_{\zeta_1=0}^{\eta_1} \frac{h_1^{\eta_1-\zeta_1}}{(\eta_1-\zeta_1)!} \beta'_{\zeta_1, \zeta_2} \quad \text{for } \zeta_2 \in \{0, \dots, \mathbf{t}_2\}, \eta_1 \in \{0, \dots, p\}, \text{ and} \\ \tau_{\zeta_1, \eta_2}^2 &= \sum_{\zeta_2=\mathbf{t}_2+1}^{\eta_2} \frac{h_2^{\eta_2-\zeta_2}}{(\eta_2-\zeta_2)!} \beta'_{\zeta_1, \zeta_2} \quad \text{for } \zeta_1 \in \{0, \dots, \mathbf{t}_1\}, \eta_2 \in \{0, \dots, p\}. \end{aligned}$$

Each entry in τ^1, τ^2 requires $O(p)$ operations, and there are $O(p \cdot (\mathbf{t}_1 + \mathbf{t}_2)) = O(p)$ entries. This is similar to Theorem 15, where we used Lemma 14 to show that the cost is $O(p \cdot (\mathbf{t}_1 + \mathbf{t}_2)) = O(p)$. Then calculating σ'_{η_1, η_2} requires a constant number of operations, resulting in an algorithm with $O(p^2)$ operations overall.

A straightforward generalization of the above examples to the d -dimensional case shows the result. \square

4.4 Asymptotic Cost of Derivative Evaluation

In Definition 8, we have introduced $w(p)$ as the amortized operation count needed to compute one derivative when computing the derivatives $\mathcal{D}^p G(\mathbf{x})_j$ required in the compressed case. For kernels that depend only on the (scalar) distance between two points, Tausch [2003] gives an algorithm with $O(p^{d+1})$ cost for calculating all derivatives $\mathcal{D}^p G(\mathbf{x})$ when the derivatives of the kernel

$$\left(\left(\frac{1}{r} \frac{d}{dr} \right)^i G(r) \right)_{i \in \{0, \dots, p\}} \quad (57)$$

with respect to the distance are known. A straightforward modification of this algorithm yields an algorithm to compute $\mathcal{D}^p G(\mathbf{x})_j$ with $w(p) = O(p)$ cost, assuming an algorithm to compute (57) is available.

In some special cases, the amortized cost for computing derivatives can be lowered further. In the following sections, we describe a few algorithms we found for reducing the cost to $w(p) = O(1)$. To the best of our knowledge, these formulas have not previously been used in the context of Fast Multipole Methods.

4.4.1 Laplace 2D

Let $n \in \mathbb{N}_0$. For conciseness, here and below we let $r = \sqrt{x^2 + y^2}$. To facilitate derivative computations in our expansions, we give a recurrence for the x derivatives of $\log(r)$:

$$r^2 \frac{\partial^n}{\partial x^n} \log(r) = -2(n-1)x \frac{\partial^{n-1}}{\partial x^{n-1}} \log(r) - (n-1)(n-2) \frac{\partial^{n-2}}{\partial x^{n-2}} \log(r)$$

where $n \geq 3$. A recurrence can still be found when a y derivative is present:

$$r^2 \frac{\partial^{n+1}}{\partial x^n \partial y} \log(r) = -2(n-1)x \frac{\partial^n}{\partial x^{n-1} \partial y} \log(r) - (n-1)(n-2) \frac{\partial^{n-1}}{\partial x^{n-2} \partial y} \log(r) - 2y \frac{\partial^n}{\partial x^n} \log(r). \quad (58)$$

These formulae can be derived using induction or by using the definitions of the n^{th} order Chebyshev polynomials of the first and second kind as defined in [DLMF, (18.5.1)] and [DLMF, (18.5.2)].

For our expansion machinery, we can choose we can choose \mathbf{nu} such that

$$\nu(\mathbf{j}) = \{(n, 0) : n \in \{0, \dots, p\}\} \cup \{(n, 1) : n \in \{0, \dots, p-1\}\},$$

i.e. so that compressed expansions involve only the two ‘slices’ of multi-indices shown in Figure 1a. Therefore, the above recurrences suffice to provide an amortized constant-time algorithm with $w(p) = O(1)$ for the Laplace kernel in two dimensions.

4.4.2 Laplace 3D

Using induction we can give a recurrence for the x derivatives of $1/r$:

$$r^2 \frac{\partial^n}{\partial x^n} \left(\frac{1}{r} \right) = -(2n-1)x \frac{\partial^{n-1}}{\partial x^{n-1}} \left(\frac{1}{r} \right) - (n-1)^2 \frac{\partial^{n-2}}{\partial x^{n-2}} \left(\frac{1}{r} \right)$$

where $n \geq 2$. A recurrence can still be found when a y derivative is present:

$$r^2 \frac{\partial^{n+1}}{\partial x^n y} \left(\frac{1}{r} \right) = -(2n-1)x \frac{\partial^n}{\partial x^{n-1} y} \left(\frac{1}{r} \right) - (n-1)^2 \frac{\partial^{n-1}}{\partial x^{n-2} y} \left(\frac{1}{r} \right) - 2y \frac{\partial^n}{\partial x^n} \left(\frac{1}{r} \right).$$

This in turn can be generalized to the case of an arbitrary number of derivatives along the x and y axes:

$$\begin{aligned} r^2 \frac{\partial^{n+m}}{\partial x^n y^m} \left(\frac{1}{r} \right) &= -(2n-1)x \frac{\partial^{n+m-1}}{\partial x^{n-1} y^m} \left(\frac{1}{r} \right) - (n-1)^2 \frac{\partial^{n+m-2}}{\partial x^{n-2} y^m} \left(\frac{1}{r} \right) \\ &\quad - 2my \frac{\partial^{n+m-1}}{\partial x^n y^{m-1}} \left(\frac{1}{r} \right) - m(m-1) \frac{\partial^{n+m-2}}{\partial x^n y^{m-2}} \left(\frac{1}{r} \right) \end{aligned}$$

for all $m \geq 0, n \geq 1$ where the last term is defined and nonzero for $m \geq 2$ and the preceding term is defined and nonzero for $m \geq 1$. An analogous generalization to three variables yields the recurrence formula

$$\begin{aligned} r^2 \frac{\partial^{n+m+l}}{\partial x^n y^m z^l} \left(\frac{1}{r} \right) &= -(2n-1)x \frac{\partial^{n+m-1}}{\partial x^{n-1} y^m z^l} \left(\frac{1}{r} \right) - (n-1)^2 \frac{\partial^{n+m-2}}{\partial x^{n-2} y^m z^l} \left(\frac{1}{r} \right) - 2my \frac{\partial^{n+m-1}}{\partial x^n y^{m-1} z^l} \left(\frac{1}{r} \right) \\ &\quad - m(m-1) \frac{\partial^{n+m-2}}{\partial x^n y^{m-2} z^l} \left(\frac{1}{r} \right) - 2lz \frac{\partial^{n+m-1}}{\partial x^n y^m z^{l-1}} \left(\frac{1}{r} \right) - l(l-1) \frac{\partial^{n+m-2}}{\partial x^n y^m z^{l-2}} \left(\frac{1}{r} \right). \end{aligned} \quad (59)$$

As above, this leads to an algorithm for the computation of the derivatives need for our expansions with $w(p) = O(1)$.

4.4.3 Biharmonic 2D

Using induction, we can prove that,

$$r^2 \frac{\partial^n}{\partial x^n} (r^2 \log(r)) = -2(n-2)x \frac{\partial^{n-1}}{\partial x^{n-1}} (r^2 \log(r)) - (n-1)(n-4) \frac{\partial^{n-2}}{\partial x^{n-2}} (r^2 \log(r))$$

for $n \geq 5$. Differentiating by y , we get,

$$\begin{aligned} r^2 \frac{\partial^{n+1}}{\partial x^n y} (r^2 \log(r)) &= -2(n-2)x \frac{\partial^n}{\partial x^{n-1} y} (r^2 \log(r)) \\ &\quad - (n-1)(n-4) \frac{\partial^{n-1}}{\partial x^{n-2} y} (r^2 \log(r)) - 2y \frac{\partial^n}{\partial x^n} (r^2 \log(r)) \end{aligned}$$

which in turn leads to,

$$\begin{aligned} r^2 \frac{\partial^{n+m}}{\partial x^n y^m} (r^2 \log(r)) &= -2(n-2)x \frac{\partial^{n+m-1}}{\partial x^{n-1} y^m} (r^2 \log(r)) - (n-1)(n-4) \frac{\partial^{n+m-2}}{\partial x^{n-2} y^m} (r^2 \log(r)) \\ &\quad - 2my \frac{\partial^{n+m-1}}{\partial x^n y^{m-1}} (r^2 \log(r)) - m(m-1) \frac{\partial^{n+m-2}}{\partial x^n y^{m-2}} (r^2 \log(r)) \end{aligned} \quad (60)$$

which is true for $n \geq 5, m \geq 0$ where the last term is defined and nonzero for $m \geq 2$ and the preceding term is defined and nonzero for $m \geq 1$. As above, this leads to a $w(p) = O(1)$ algorithm for computing the needed derivatives.

4.5 Summary

Table 3 summarizes time complexities for all the formation, translation and evaluation operators for both local and multipole expansions. In the table, p refers to the order of the expansions, d is the number of dimensions and $w(p)$ is the amortized asymptotic cost of calculating one derivative of the potential function (cf. Section 4.4).

	P2L / M2P	P2M / L2P	M2M / L2L	M2L
Taylor Series	$p^d + p^{d-1}w(p)$	p^d	p^{d+1}	p^{2d}
Taylor Series with FFT	$p^d + p^{d-1}w(p)$	p^d	p^{d+1}	$p^d \log(p)$
Compressed Taylor Series	$p^{d-1}w(p)$	p^d	p^d	p^{2d-2}
Compressed Taylor Series with FFT	$p^{d-1}w(p)$	p^d	p^d	$p^{d-1} \log(p)$

Table 3: Time complexities for expansions, translations and evaluations. In the table, P2L is the formation of a local expansion from a point source, P2M is the formation of a multipole expansion from a point source, M2M is the translation of a multipole expansion into another multipole expansion, M2L is the translation of a multipole expansion into a local expansion, L2L is the translation of a local expansion into another local expansion, M2P is the evaluation of a multipole expansion at a target point, and L2P is the evaluation of a local expansion at a target point.

5 Numerical Results

In order to support the claims presented, we conduct three numerical experiments. We have implemented the algorithms in OpenCL and have published the codes under a permissive MIT license. You can reproduce these experiments as described in [Fernando, 2022].

5.1 Accuracy of Multipole-to-Multipole Translation

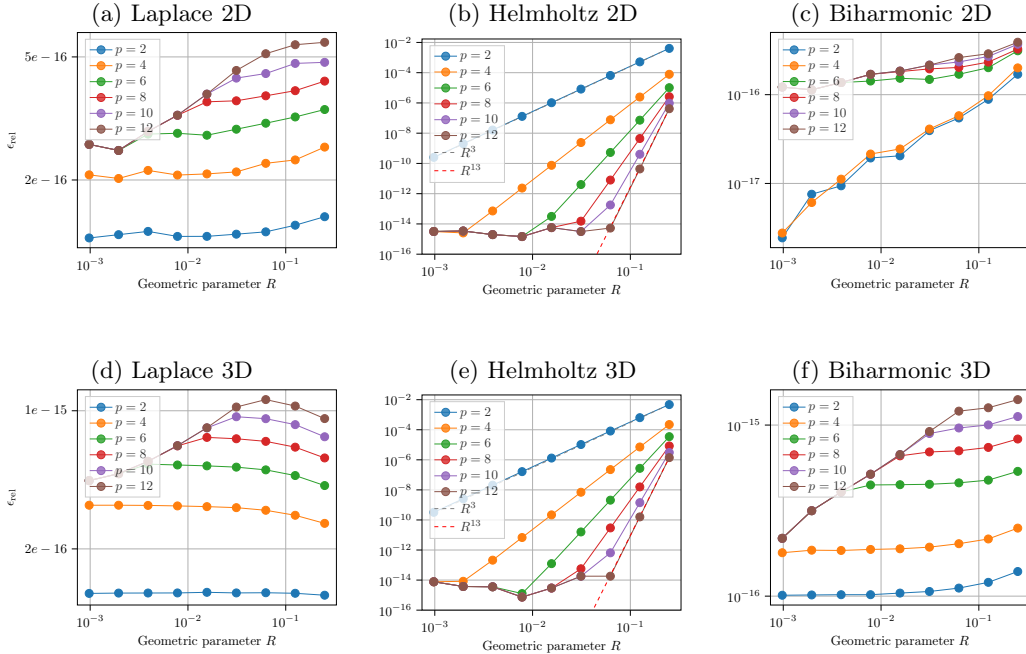

Figure 4: Comparison of M2M translation error between compressed and uncompressed representation.

As shown in Section 4, our compression approach introduces no additional numerical error when compared to uncompressed Cartesian Taylor expansions *except* in the case of the multipole-to-multipole translation for PDEs with terms of varying order, such as Helmholtz or Yukawa. The details are in Theorems 17 and 19, particularly a bound of the additional error.

As numerical confirmation of these expectations, we have conducted a collection of numerical experiments to calculate the relative error between the compressed Taylor series translation and uncompressed Taylor series. In our numerical experiments, we consider an arrangement of sources, targets and the expansion centers of the multipole expansions as illustrated in Figure 5. As we change a single geometric parameter R , we consider the error measure

$$\epsilon_{\text{rel}} = \sqrt{\frac{\sum_{\mathbf{x}} |\epsilon(\mathbf{x})|^2}{\sum_{\mathbf{x}} \left| \sum_{n=1}^{N(p)} \rho_n \partial_{\mathbf{x}}^{\nu(n)} G(\mathbf{x} - \mathbf{c}_2) \right|^2}},$$

where $\epsilon(\mathbf{x})$ is defined as in Theorem 19. ϵ_{rel} measures the relative error in the evaluated potential when comparing compressed and uncompressed expansions in the setting of forming a multipole expansion, translating it to another multipole expansion, and evaluating the translated expansion. For the purposes of our experiment, the sources are arranged in a uniform grid centered at $\mathbf{c}_1 = [R, R, R]^T$ with side length $2R$ and 50 grid points per dimension. Each source is assigned strength from a uniform distribution on $(0, 1)$. The first multipole expansion is formed about center \mathbf{c}_1 located in the middle of the source grid. The translated multipole expansion is centered at $\mathbf{c}_2 = [0, 0, 0]^T$. The target points (at which error is measured) are once again located in a uniform grid centered at $[1, 1, 1]^T$ with side length 1 having 50 grid points per dimension. Figure 5 shows the geometric setup for a specific R , noting that R is varied as part of the experiment. An analogous two-dimensional experiment is constructed from the three-dimensional one by dropping the last dimension. We perform this calculation for different values of the Taylor series order and for Laplace, Helmholtz and biharmonic kernels/PDEs in two and three dimensions. All calculations were performed using double-precision floating-point arithmetic. Figure 4 summarizes the error ϵ_{rel} for the three kernels.

For PDEs with only terms of equal order, our techniques introduce no additional error, cf. Theorem 17. As numerical examples of this case, we use the Laplace and biharmonic PDEs which have only terms of equal order. We observe an error less than 10^{-14} in Figures 4a, 4c, 4d and 4f. While we observe some incipient growth of the error as R increases in Figure 4d near the level of machine epsilon, a tolerance of 10^{-14} is maintained in our experiments. We hypothesize that this incipient error growth is the result of amplification of round-off error.

For PDEs with terms of varying order, we use the example of the Helmholtz equation

$$\Delta u + \kappa^2 u = 0$$

with $\kappa = 1$. The classical upper bound of truncation error for uncompressed expansions for the chain of translations performed is $O(R^{p+1})$ as $R \rightarrow 0$, cf. [Shanker and Huang, 2007]. Under the additional assumption (47), Theorem 19 shows that the added error introduced by our compressed translation method is asymptotically identical to this estimate. The experimental data in Figures 4b and 4e show no disagreement with this claim.

Next, we numerically examine to what extent the terms bounded with the help of assumption (47) contribute to the observed error. We use the same experimental setup as before in the case of the Helmholtz equation but with the geometric parameter R fixed at 10^{-2} and varying the wavenumber κ . As above, the setup is illustrated in Figure 5 for two dimensions. When $\kappa \geq 2$, (48) does not hold because $\max_{\mathbf{x}} \|\mathbf{x} - \mathbf{c}_2\| \kappa = 0.5\sqrt{d}\kappa \geq \sqrt{d} > 1$. Recall that, if (48) holds, Theorem 19 shows that the error in compressed multipole-to-multipole translation obeys an error bound that is asymptotically identical to that of the Taylor series truncation error. In this experiment, we directly compare these two errors by considering the truncation error in the uncompressed translated expansion

$$\epsilon_{\text{trunc}} = \sqrt{\frac{\sum_{\mathbf{x}} \left| \sum_{n=1}^{N(p)} \rho_n \partial_{\mathbf{x}}^{\nu(n)} G(\mathbf{x} - \mathbf{c}_2) - \sum_{\mathbf{y}} G(\mathbf{x} - \mathbf{y}) \right|^2}{\sum_{\mathbf{x}} \left| \sum_{\mathbf{y}} G(\mathbf{x} - \mathbf{y}) \right|^2}}.$$

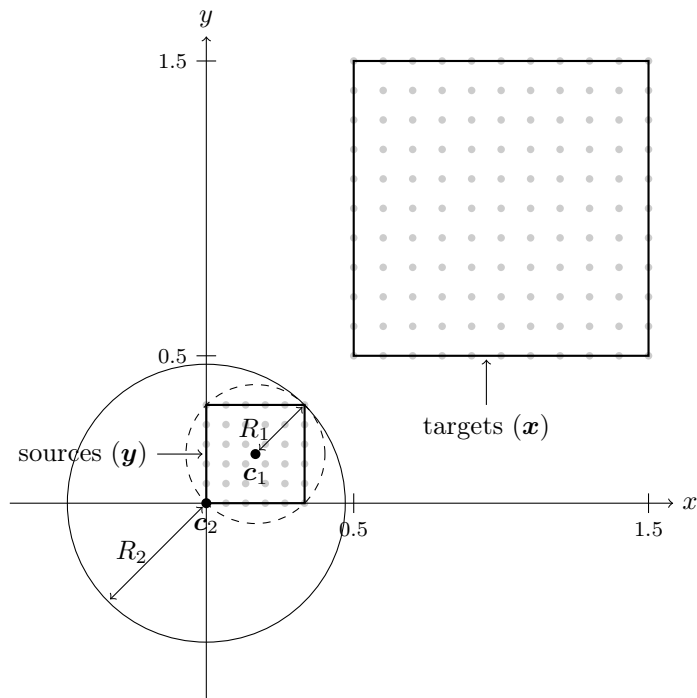

Figure 5: Geometric setting of a numerical experiment to calculate the error in compressed multipole expansion. Targets are in a box of size 1 centered at $(1, 1)^T$ and sources are in a box of size $2R$ centered at $(R, R)^T$. The initial multipole expansion is centered at \mathbf{c}_1 with radius $R_1 = \sqrt{2}R$. It is then translated to a multipole expansion centered at \mathbf{c}_2 with radius $R_2 = 2\sqrt{2}R$.

and comparing it to the additional error ϵ_{rel} introduced by performing the multipole-to-multipole translation in compressed form. We show both ϵ_{rel} and ϵ_{trunc} in Figure 6 for Helmholtz equation in two and three dimensions.

We observe that the multipole translation error in compressed representation ϵ_{rel} behaves very similarly to the Taylor series truncation error ϵ_{trunc} . In particular, we note no change in the behavior of the error after (48) ceases to hold. This suggests that Theorem 19 may hold in a more general setting than stated.

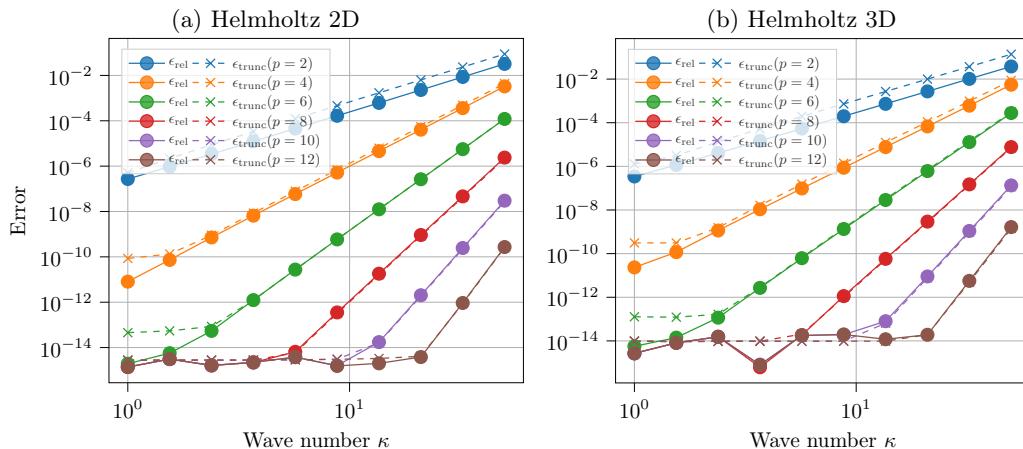

Figure 6: Comparison of error between direct evaluation and uncompressed Taylor M2M translation (dashed) and *additional* error introduced by using M2M translation in compressed representation for Helmholtz problem with different wavenumbers.

5.2 Operation count

To confirm the time complexities in Table 3, floating point operation counts were collected from the source code for the case of a single source and a single target. For multipole-to-local translation, the FFT used in the accelerated evaluation of (28) is by far the dominant cost. To put this cost into perspective compared to the other translation operators, while accounting for the fact that the FFT cost is typically amortized across many different translations, we divide the FFT cost by the maximal size of List 2 (27 in 2D and 189 in 3D, cf. [Carrier et al., 1988]). The cost of the FFT of the derivatives (cf. (28)) and the cost of the evaluation of derivatives for the multipole to local translation was not included, as these can be precomputed once per tree and reused.

In our implementation, we have used 58, 59 and 60 for the Laplace equation and the biharmonic equation to obtain $w(p) = O(1)$. For the Helmholtz equation, we have used the method of Tausch [2003] to obtain $w(p) = O(p)$. For PDEs with radially symmetric Green’s functions, we have implemented the procedure of Tausch [2003] together with symbolic differentiation for the derivatives with respect to the (scalar) derivatives using the SymPy computer algebra system [Meurer et al., 2017]. For other PDEs, we use symbolic differentiation to obtain the derivatives.

Figure 7 and Figure 8 show the floating point operation counts for the uncompressed representation and compressed representation as well as the expected time complexities for the two-dimensional and three-dimensional Laplace kernel. We observe that local expansion (“P2L”) and multipole evaluation (“M2P”) have $O(p^{d-1})$ operations for the Laplace equation, as the derivative calculation has amortized constant cost. Multipole expansion, multipole-to-multipole translation, local-to-local translation have $O(p^d)$ operations as expected. Multipole-to-local translation has cost $O(p^{d-1} \log(p))$ as expected. Costs of multipole-to-local translation across different values of p fluctuate due to the use of the

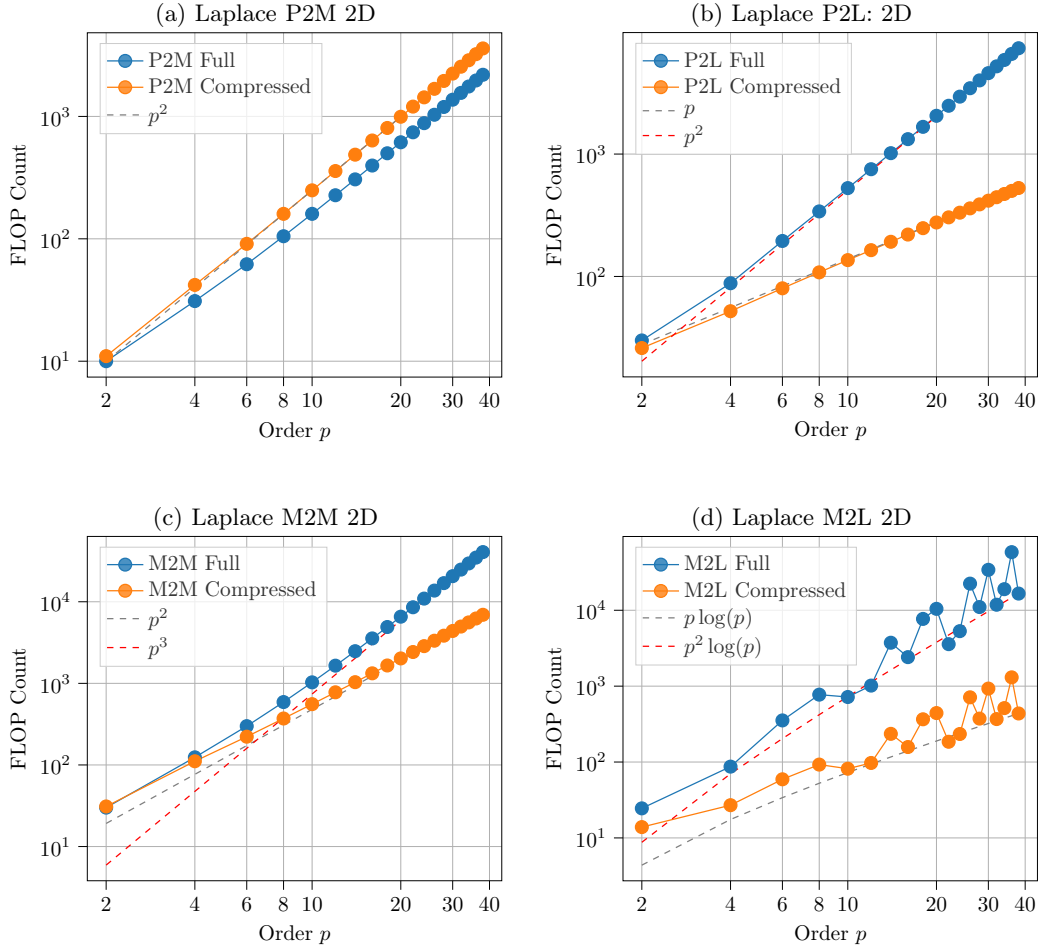

Figure 7: Operation counts for multipole expansion (P2M), local expansion (P2L), multipole-to-local translation (M2L) and multipole-to-multipole translation (M2M) of Laplace kernel for two dimensions.

Cooley-Tukey algorithm for the forward and inverse FFT, which involves the divisibility of various vector sizes, cf. Section 4.1. We have not shown operation count graphs for multipole evaluation, local evaluation and local-to-local translation as they are very similar to those for local expansion, multipole expansion and multipole-to-multipole expansion graphs, respectively.

5.3 Application: A Boundary Integral Equation Solver for the Biharmonic Equation

To test our expansion algorithms in the context of an application, we consider a boundary integral equation solver involving the biharmonic equation in two dimensions. We solve the following interior

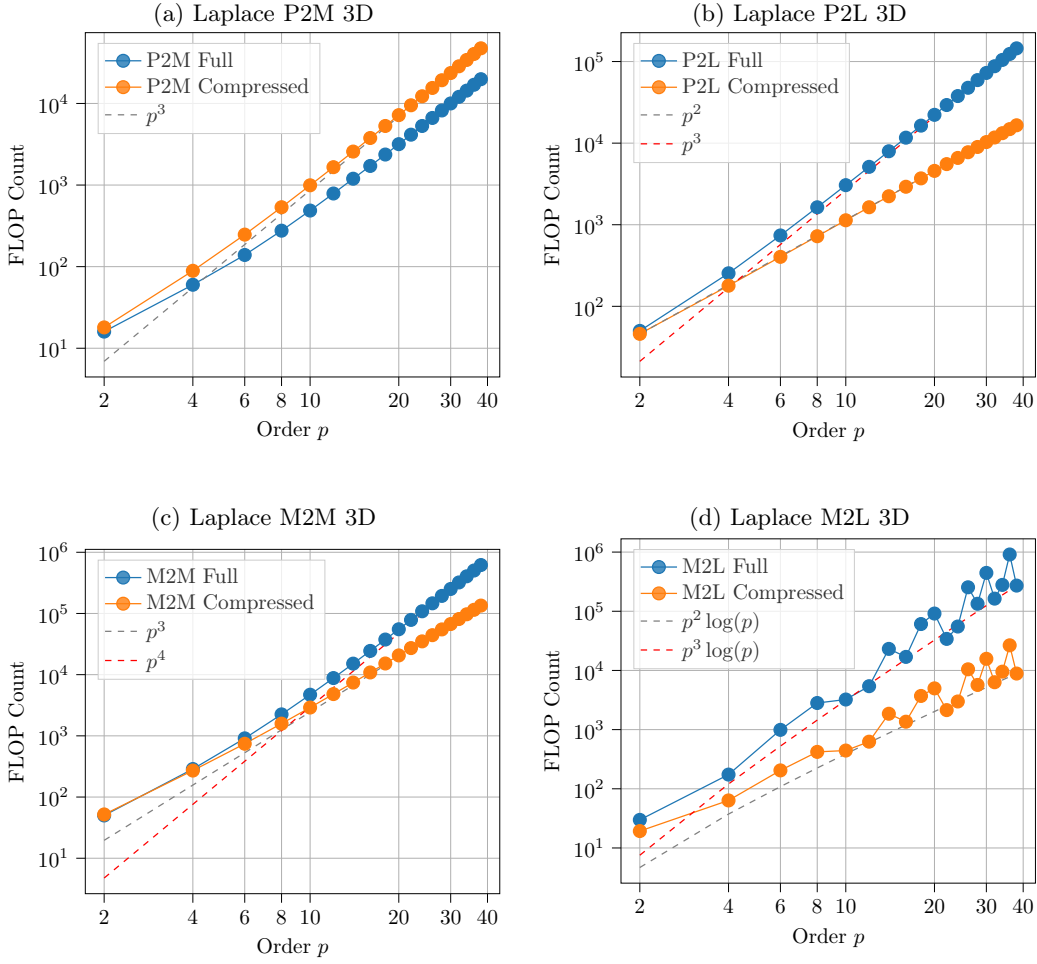

Figure 8: Operation counts for multipole expansion (P2M), local expansion (P2L), multipole-to-local translation (M2L) and multipole-to-multipole translation (M2M) of Laplace kernel for three dimensions.

boundary value problem:

$$\begin{aligned} \Delta^2 u &= 0 \text{ on } D, \\ u &= g_1 \text{ on } \partial D \\ \frac{\partial u}{\partial \nu} &= g_2 \text{ on } \partial D, \end{aligned}$$

where $\frac{\partial u}{\partial \nu}$ is the normal derivative, and D is the interior of the ellipse defined by the curve $\gamma(t)$ where

$$\gamma(t) = \left[\cos(2\pi t), \frac{\sin(2\pi t)}{3} \right]^T,$$

and t is in the range $[0, 1)$.

The boundary conditions g_1 and g_2 were generated from a set of point ‘charges’ with strengths σ_i

Order	Taylor Series	Compressed Taylor	Compressed Taylor with FFT
6	7.39569e-04	7.39569e-04	7.39569e-04
8	1.88837e-04	1.88837e-04	1.88837e-04
10	3.76156e-05	3.76156e-05	3.76156e-05
12	2.52269e-06	2.52269e-06	2.52269e-06
14	8.51900e-08	8.51899e-08	8.51950e-08
16	1.18994e-08	1.18995e-08	1.18681e-08
18	7.95475e-09	7.95485e-09	7.77618e-09

Table 9: 2-norm errors for the biharmonic boundary value problem

drawn from a standard normal distribution:

$$g_1(\mathbf{x}) = \sum_{i=0}^9 (\mathbf{r}_1^2 + \mathbf{r}_2^2) \log(\mathbf{r}_1^2 + \mathbf{r}_2^2) \sigma_i \quad \mathbf{x} \text{ on } D \quad (61)$$

and

$$g_2(\mathbf{x}) = \sum_{i=0}^9 2 (\log(\mathbf{r}_1^2 + \mathbf{r}_2^2) + 1) (\mathbf{r}_2 \boldsymbol{\eta}_2 + \mathbf{r}_1 \boldsymbol{\eta}_1) \sigma_i \quad \mathbf{x} \text{ on } \partial D$$

where $(\boldsymbol{\eta}_1, \boldsymbol{\eta}_2)$ is the normal direction to the boundary ∂D at the the point $(\mathbf{x}_1, \mathbf{x}_2)$ and

$$\begin{aligned} \mathbf{r}_1 &= \mathbf{x}_1 - 2 \sin \frac{2\pi i}{10} \\ \mathbf{r}_2 &= \mathbf{x}_2 - 2 \cos \frac{2\pi i}{10}. \end{aligned}$$

Using (61) the reference values $u_{\text{ref}}(\mathbf{x})$ for points inside the boundary are also calculated.

The system of integral equations used for this boundary value problem is the one described in [Farkas, 1990]. For layer potential evaluation, the method of quadrature by expansion [Klöckner et al., 2013] was used with QBX order 5. The boundary was discretized into 100 elements of equal length in t . According to the criteria of Wala and Klöckner [2019], no refinement was required for accurate QBX evaluation, and thus no further refinement was performed. The generalized minimal residual method (GMRES) with a tolerance of 10^{-9} was used to solve the system of integral equations. We use the reference values to calculate the relative error for each target and calculate the 2-norm to compute the error measure

$$\epsilon = \sqrt{\frac{\sum_{\mathbf{x} \in T} |u_{\text{approx}}(\mathbf{x}) - u_{\text{ref}}(\mathbf{x})|^2}{\sum_{\mathbf{x} \in T} |u_{\text{ref}}(\mathbf{x})|^2}}$$

where $u_{\text{approx}}(\mathbf{x})$ is the potential at target \mathbf{x} computed via the solution representation using the numerically-solved density function. Errors are of very similar magnitude between the FMM based on Taylor series expansions, the FMM using compressed Taylor series, and the FMM using compressed Taylor series and FFT-based multipole-to-local translations, cf. Table 9. For high-order expansions, the FFT-based approach incurs a small amount of additional error, in line with the discussion in Section 4.1.1.

6 Conclusion

In this paper, we have described a new algorithm for the automatic synthesis of low-complexity translation operators for the FMM, based on the Taylor series of the potential function for potentials satisfying a PDE. We have shown that a time complexity of $O(p^d)$ can be achieved for the translation

operators for a d -dimensional expansion of order p . The new translation operators retain the same asymptotic error estimates as the classical ones of Greengard and Rokhlin [1988].

The FMM using compressed Taylor series achieves similar time complexities compared to PDE-specialized fast algorithms. This includes FMMs using spherical harmonic expansions, such as the kernel- and PDE-specific methods of Greengard and Rokhlin [1988] and Greengard and Huang [2002]. In contrast to those, our approach provides a single method that is applicable to a broad class of kernels and PDEs in two and three dimensions.

While we feel that the present contribution addresses the case of non-oscillatory scalar kernels in a satisfactory manner, extensions to the oscillatory setting as well as the case of systems of PDEs such as Stokes, elasticity, or Maxwell's are of immediate interest. In addition, a high-performance implementation of the approach could be of immediate interest across a broad range of applications.

Acknowledgments

The authors' research was supported by the National Science Foundation under grants DMS-1654756 and SHF-1911019 as well as the Department of Computer Science at the University of Illinois at Urbana-Champaign. Any opinions, findings, and conclusions, or recommendations expressed in this article are those of the authors and do not necessarily reflect the views of the National Science Foundation; NSF has not approved or endorsed its content. The authors would also like to thank Matt Wala for helpful discussions.

References

- L Greengard and V Rokhlin. A fast algorithm for particle simulations. *Journal of Computational Physics*, 73(2):325–348, 1987. ISSN 0021-9991. DOI: 10.1016/0021-9991(87)90140-9.
- Weng Cho Chew, Mei Song Tong, and Bin Hu. *Integral equation methods for electromagnetic and elastic waves*. Morgan & Claypool Publishers, September 2008. ISBN 978-1-59829-148-3.
- Leslie Greengard. *The rapid evaluation of potential fields in particle systems*. MIT Press, 1988. ISBN 9780262571920.
- Leslie Greengard and Vladimir Rokhlin. On the efficient implementation of the fast multipole algorithm. Technical report, Department of Computer Science, Yale University, 1988. URL <http://www.cs.yale.edu/publications/techreports/tr602.pdf>.
- Leslie Greengard and Jingfang Huang. A new version of the fast multipole method for screened coulomb interactions in three dimensions. *Journal of Computational Physics*, 180(2):642–658, 2002. DOI: 10.1006/jcph.2002.7110.
- Lexing Ying, George Biros, and Denis Zorin. A kernel-independent adaptive fast multipole algorithm in two and three dimensions. *Journal of Computational Physics*, 196(2):591–626, 2004. DOI: 10.1016/j.jcp.2003.11.021.
- Feng Zhao. An $O(N)$ algorithm for three-dimensional n-body simulations. Master's thesis, Massachusetts Institute of Technology, 1987. URL <http://hdl.handle.net/1721.1/6962>.
- Tomas Oppelstrup. Matrix compression by common subexpression elimination. *Journal of Computational Physics*, 247:100–108, 2013. DOI: 10.1016/j.jcp.2013.03.042.
- Balasubramaniam Shanker and He Huang. Accelerated cartesian expansions—a fast method for computing of potentials of the form $R^{-\nu}$ for all real ν . *Journal of Computational Physics*, 226(1): 732–753, 2007. DOI: 10.1016/j.jcp.2007.04.033.

- Jonathan P Coles and Rebekka Bieri. An optimizing symbolic algebra approach for generating fast multipole method operators. *Computer Physics Communications*, 251:107081, 2020. DOI: 10.1016/j.cpc.2019.107081.
- Johannes Tausch. The fast multipole method for arbitrary green’s functions. *Contemporary Mathematics*, 329:307–314, 2003. DOI: 10.1090/conm/329/05866.
- He Zhang and Martin Berz. The fast multipole method in the differential algebra framework. *Nuclear Instruments and Methods in Physics Research Section A: Accelerators, Spectrometers, Detectors and Associated Equipment*, 645(1):338–344, 2011. DOI: 10.1016/j.nima.2011.01.053.
- David Cox, John Little, Donal O’Shea, and Moss Sweedler. Ideals, varieties, and algorithms. *American Mathematical Monthly*, 101(6):582–586, 1994.
- Chris Cosner. On the definition of ellipticity for systems of partial differential equations. *Journal of Mathematical Analysis and Applications*, 158(1):80–93, 1991. DOI: 10.1016/0022-247X(91)90268-5.
- Hongwei Cheng, William Y. Crutchfield, Zydrunas Gimbutas, Leslie F. Greengard, J. Frank Ethridge, Jingfang Huang, Vladimir Rokhlin, Norman Yarvin, and Junsheng Zhao. A wideband fast multipole method for the Helmholtz equation in three dimensions. *Journal of Computational Physics*, 216(1):300–325, July 2006. ISSN 0021-9991. DOI: 10.1016/j.jcp.2005.12.001.
- DLMF. *NIST Digital Library of Mathematical Functions*. <http://dlmf.nist.gov/>, Release 1.0.26 of 2020-03-15, 2020. URL <http://dlmf.nist.gov/>. F. W. J. Olver, A. B. Olde Daalhuis, D. W. Lozier, B. I. Schneider, R. F. Boisvert, C. W. Clark, B. R. Miller, B. V. Saunders, H. S. Cohl, and M. A. McClain, eds.
- Isuru Fernando. `isuruf/pde-translations-paper-code`: 2022.10.10, October 2022. URL <https://doi.org/10.5281/zenodo.7180193>.
- J Carrier, Leslie Greengard, and Vladimir Rokhlin. A fast adaptive multipole algorithm for particle simulations. *SIAM Journal on Scientific and Statistical Computing*, 9(4):669–686, 1988. DOI: 10.1137/0909044.
- Aaron Meurer, Christopher P Smith, Mateusz Paprocki, Ondřej Čertík, Sergey B Kirpichev, Matthew Rocklin, AMiT Kumar, Sergiu Ivanov, Jason K Moore, Sartaj Singh, et al. Sympy: symbolic computing in python. *PeerJ Computer Science*, 3:e103, 2017. DOI: 10.7717/peerj-cs.103.
- P. Farkas. Mathematical foundations for fast algorithms for the biharmonic equation. Technical Report YALEU/DCS/TR-765, Department of Computer Science, Yale University, 1990. URL <http://www.cs.yale.edu/publications/techreports/tr765.pdf>.
- Andreas Klöckner, Alexander Barnett, Leslie Greengard, and Michael O’Neil. Quadrature by expansion: a new method for the evaluation of layer potentials. *Journal of Computational Physics*, 252:332–349, 2013. DOI: 10.1016/j.jcp.2013.06.027.
- Matt Wala and Andreas Klöckner. A fast algorithm for quadrature by expansion in three dimensions. *Journal of Computational Physics*, 388:655–689, 2019. DOI: 10.1016/j.jcp.2019.03.024.